

Aging suppression timing Multi-Strip Multi-Gap Resistive Plate Chamber for high counting rate experiments

Mariana Petris

Hadron Physics Department

National Institute for R&D in Physics and Nuclear Engineering (IFIN-HH), Bucharest, Romania

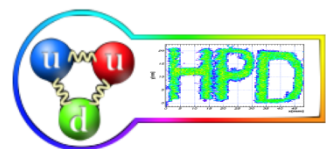

3rd International Conference on Detector Stability and Aging Phenomena in
Gaseous Detectors, CERN, 06 – 10 November 2023

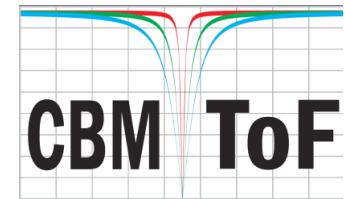

Outline

- **Motivation – next generation high interaction rate, high multiplicity experiments, (e.g. CBM/FAIR, Darmstadt ->TOF inner wall)**
- **MSMGRPC design considerations & high counting rate test of the MSMGRPC**
- **Aging investigations with high activity ^{60}Co source**
- **MSMGRPC prototype with direct gas flow & X-ray tube aging studies**
 - **Standard fishing line spacers**
 - **Discrete spacers - a new generation of direct flow MSMGRPC**
- **Summary and Outlook**

High interaction rate experiments -> CBM/FAIR

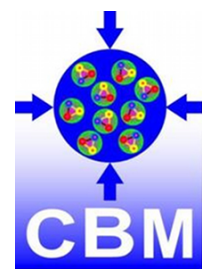

See also Ingo's talk on Tuesday

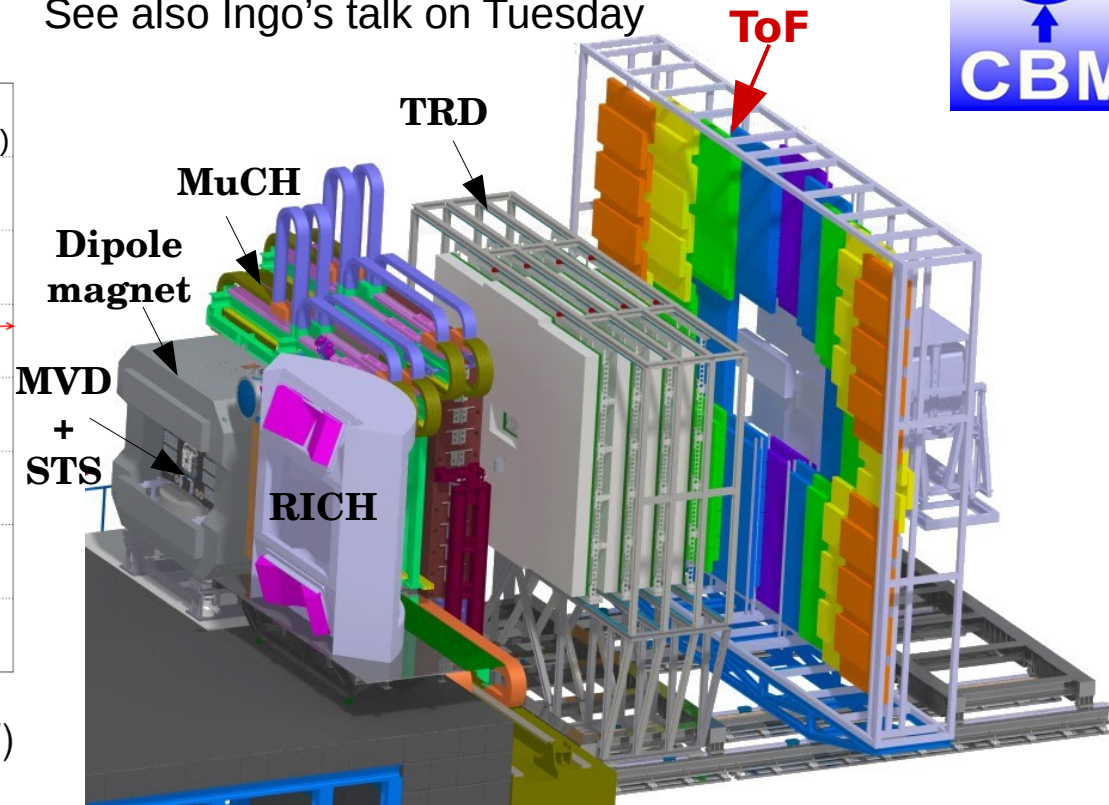
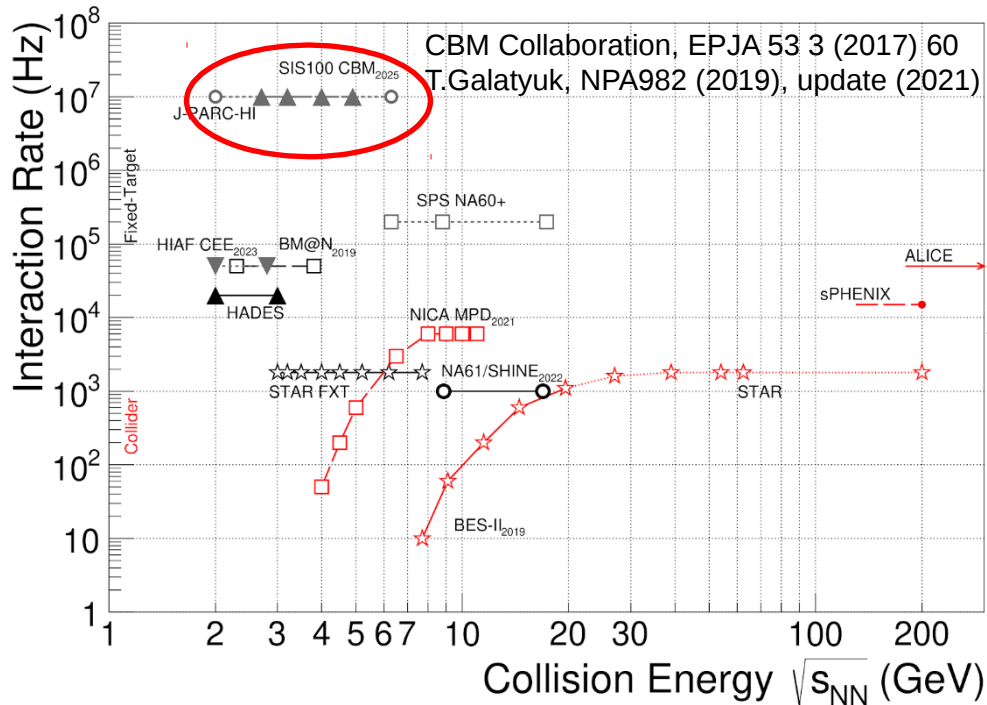

CBM experiment at FAIR/SIS100:

- A+A collisions, $E_{kin} = 2.5A - 11A$ GeV
- Systematically explore QCD matter at large baryon densities with high accuracy and rare probes

MVD: Micro Vertex Detector*
STS: Silicon Tracking System*
* inside magnetic field

MuCh / RICH

Muon Chamber System /
Ring Imaging Cherenkov Detector
TRD: Transition Radiation Detector
ToF: Time-of-Flight Detector

- Tracking acceptance: $2.5^\circ < \theta_{Lab} < 25^\circ$
- **Peak R_{int} is 10 MHz for Au+Au**
- Fast & radiation hard detectors
- Free-streaming DAQ
- 4D tracking (space, time)
- Online event selection & reconstruction
- Data rate: 1 TB/sec

CBM – TOF wall

See also Ingo's talk on Tuesday

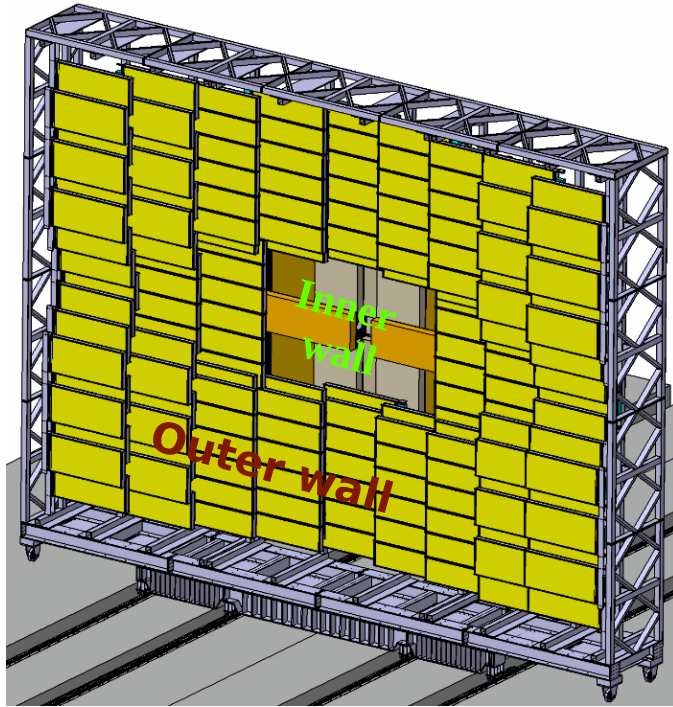
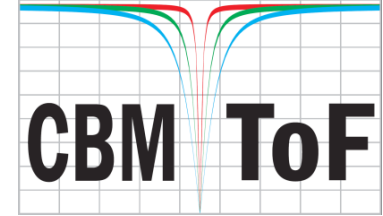

FLUKA simulation: Au + Au collisions at $E_{\text{kin}} = 11A$ GeV, 10^7 interactions/s
Charged particle flux at a distance of 8 m from the target

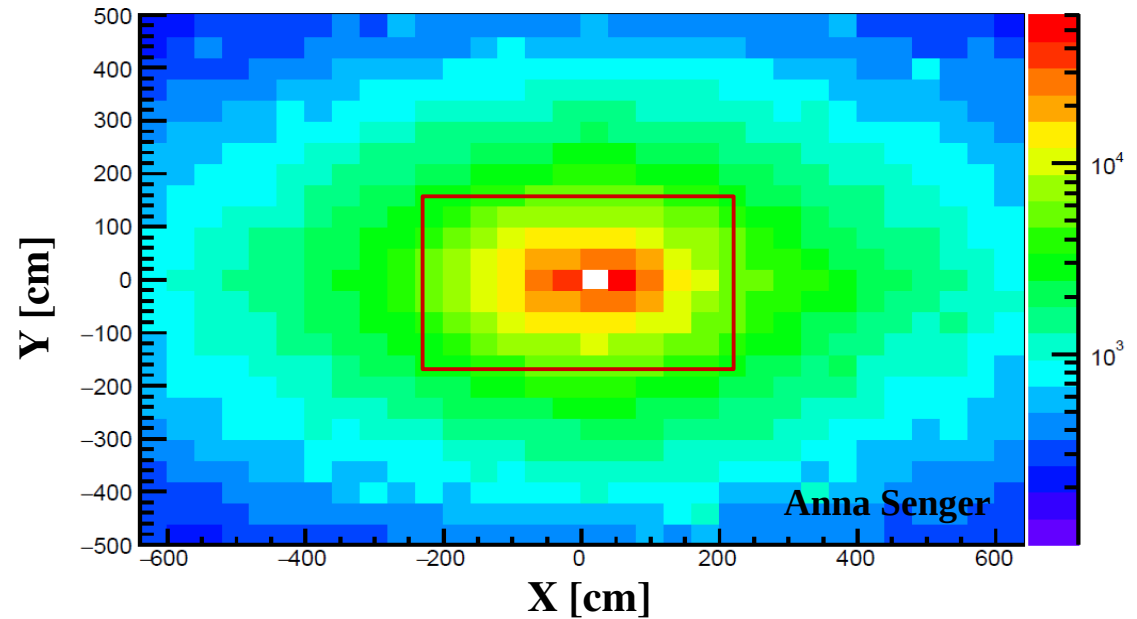

CBM-ToF Requirements

- Full system time resolution $\sigma_T \sim 80$ ps
- Efficiency > 95%
- Rate capability ≤ 50 kHz/cm²
- Polar angular range 2.5° – 25°
- Active area of 120 m²
- Occupancy < 5%
- Low power electronics (~120.000 channels)
- Free streaming data acquisition

Detectors with different rate capabilities and granularities are needed as a function of polar angle

Our R&D activity → MSMGRPCs for the inner wall :

- highest counting rate
- highest granularity
- ~15 m² active area (up to ~ 11° polar angle)

CBM – TOF Technical Desing Report, October 2014

CBM – TOF inner wall

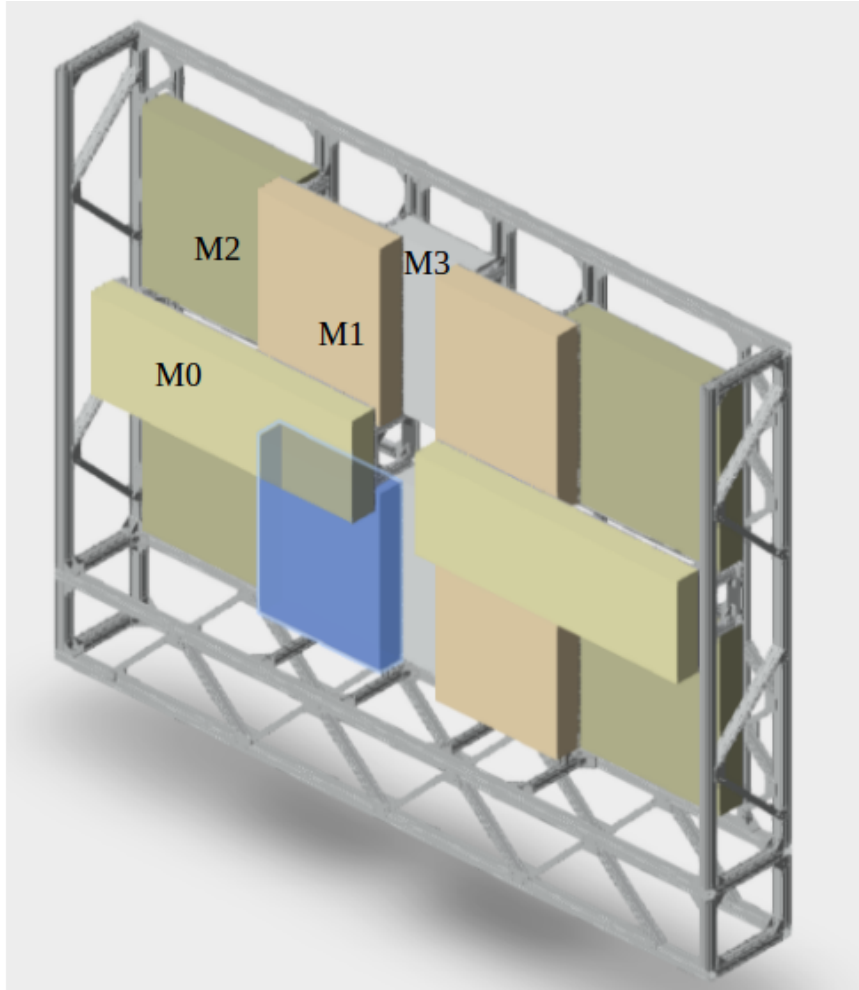

CBM-TOF inner zone
 - $\sim 15 \text{ m}^2$ active area, modular architecture:
 - 12 modules
 - 4 types (M0, M1, M2, M3)

Counters with different granularities are used.

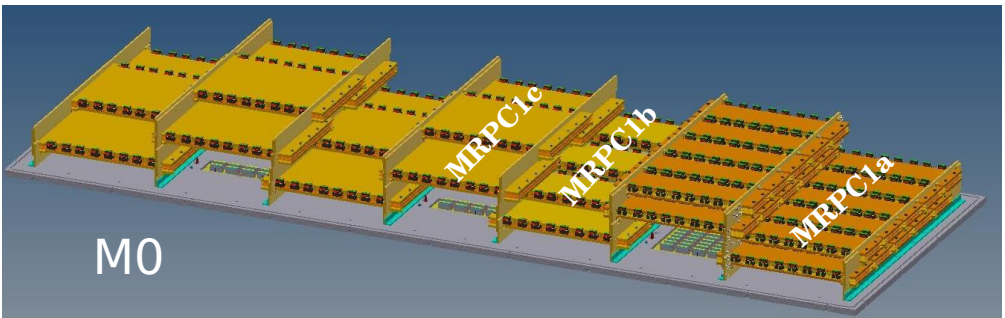
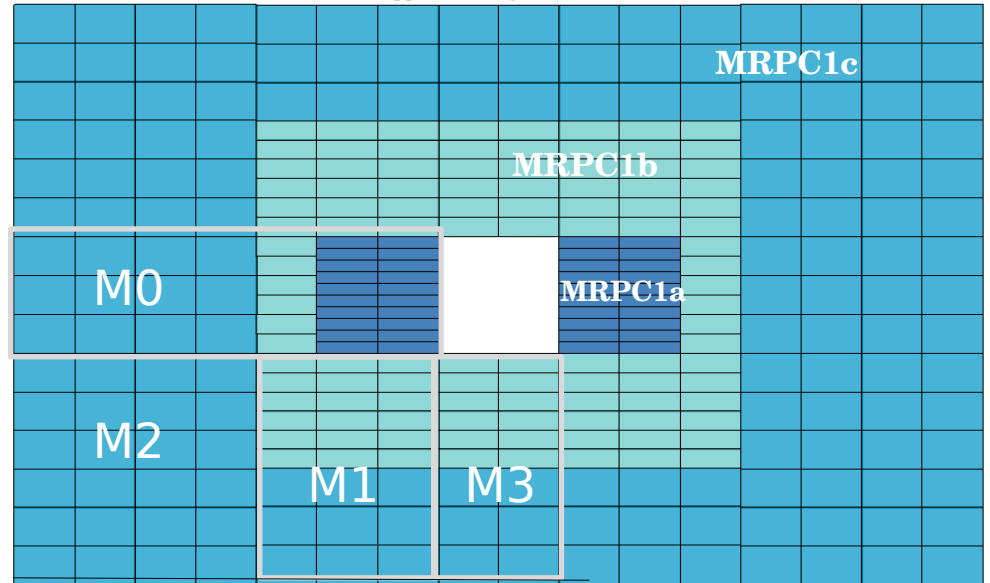

3 chamber types: 56/96/196 mm (strip length) x 300 mm

	MRPC1c (196 mm)	MRPC1b (96 mm)	MRPC1a (56 mm)	Total
No. MRPCs	168	108	40	316
No. channels	10752	6912	2560	20224

Chamber design considerations

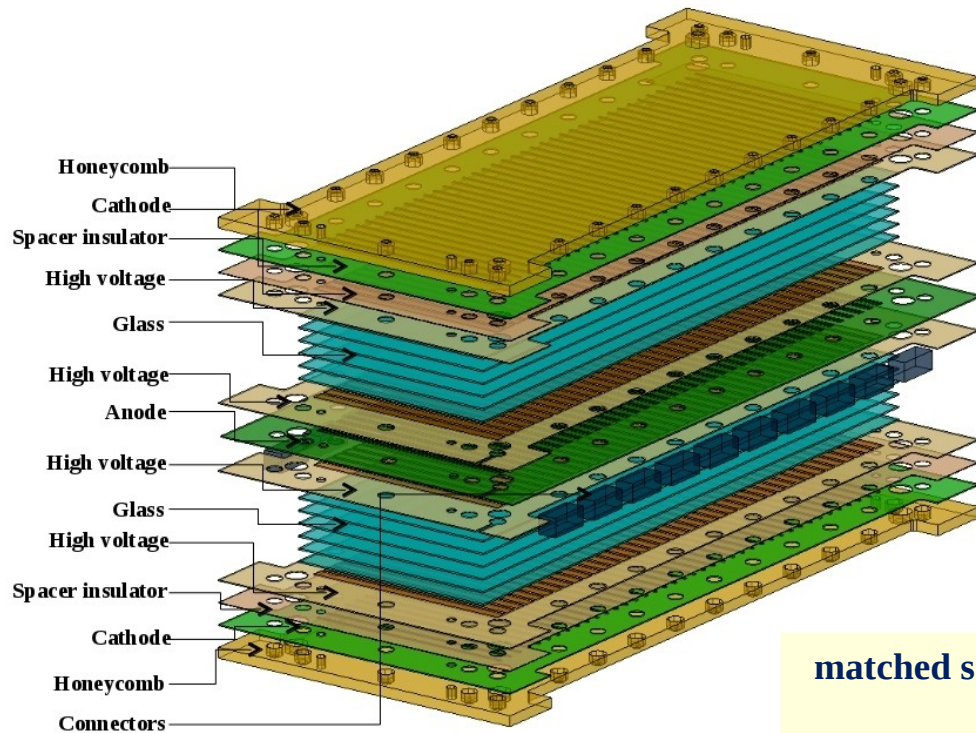

- ✓ Symmetric structure: 5 gaps x 2 stacks
- ✓ Gas gap thickness: 200 μm
- ✓ Active area 56/96/196 mm x 9 mm pitch x 32 strips
- ✓ Resistive electrodes: $\sim 10^{10} \Omega\text{cm}$, 0.7 mm Chinese glass
- ✓ Strip structure for Readout & HV electrodes
- ✓ Differential readout
- ✓ Direct flow through the gas gaps

matched signal transmission line impedance to the input of the FEE

D. Bartos et al., Romanian Journal of Physics 63, 901 (2018)

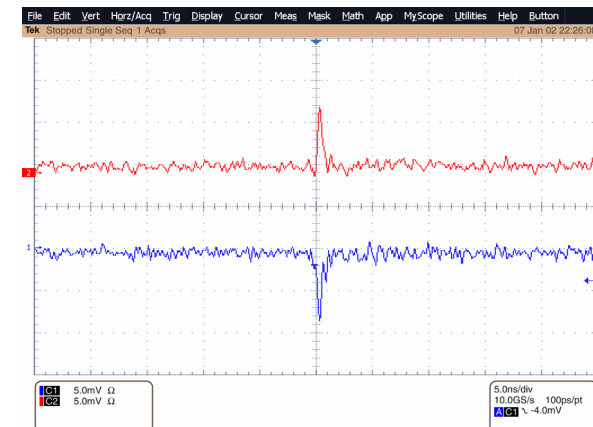
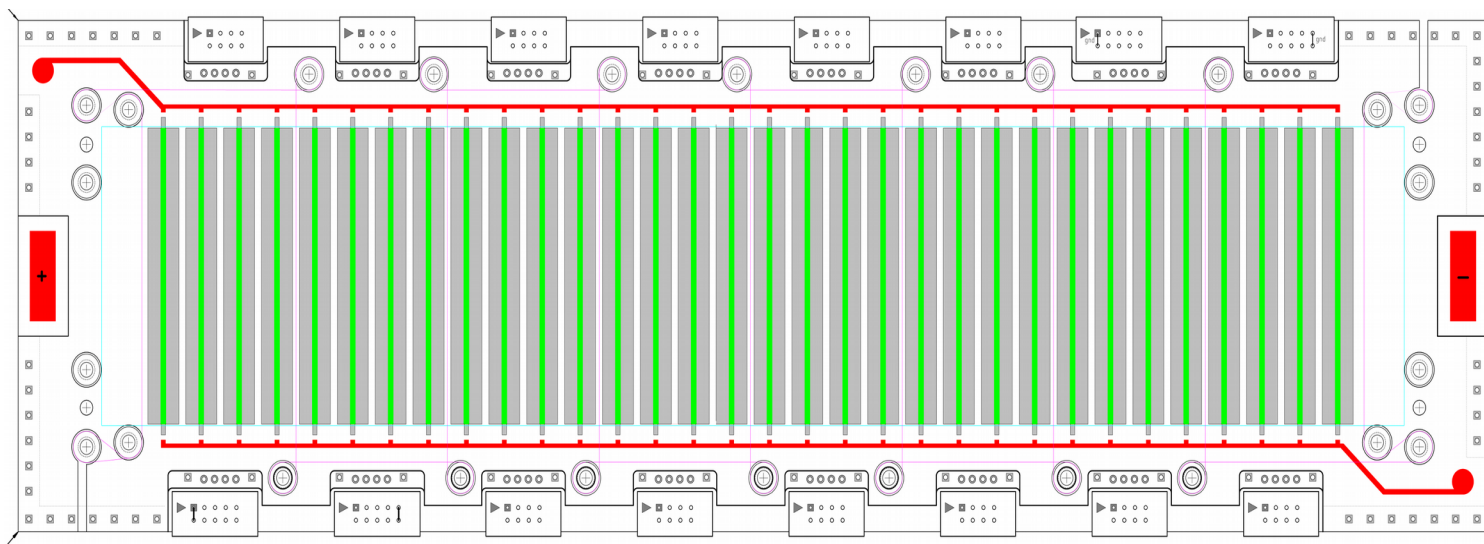

MSMGRPC prototype: gas exchange via diffusion

High voltage (HV) electrode

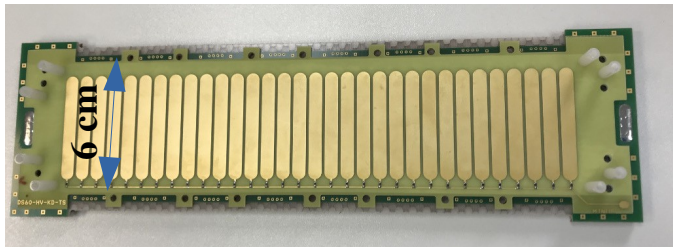

Spacer distribution across the surface

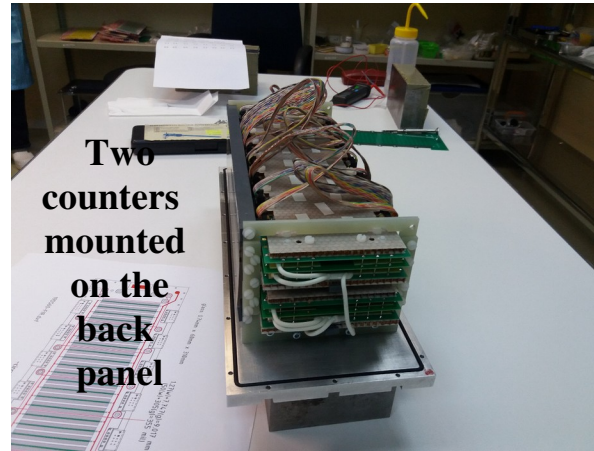

Two counters mounted on the back panel

MSMGRPC	I_{dark}	Dark rate
RPC1	< 1 nA	0.11 Hz/cm ²
RPC2	< 1 nA	0.14 Hz/cm ²

High Counting Rate Test in mCBM

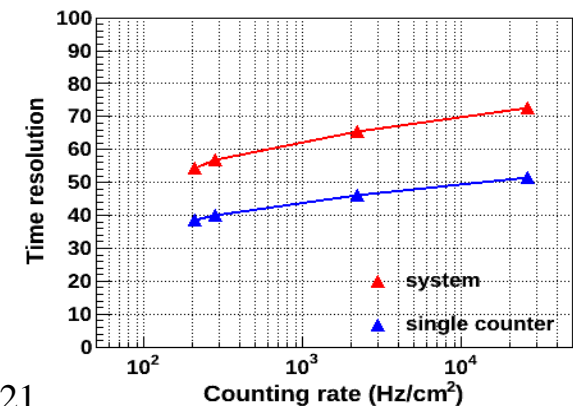
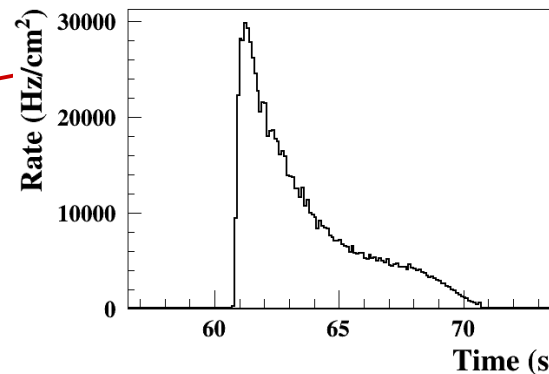
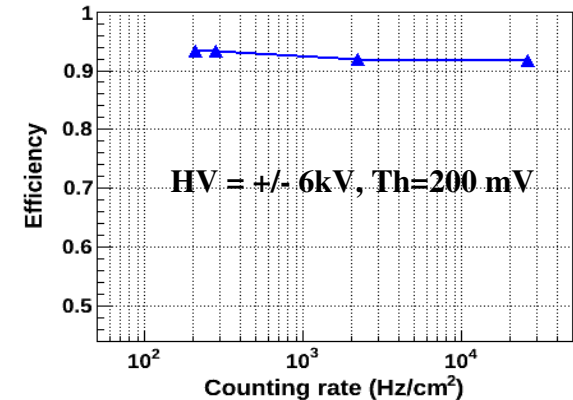
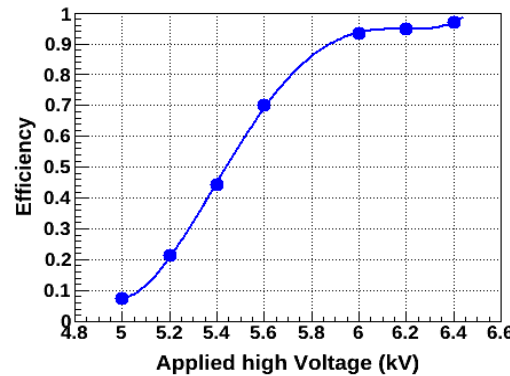
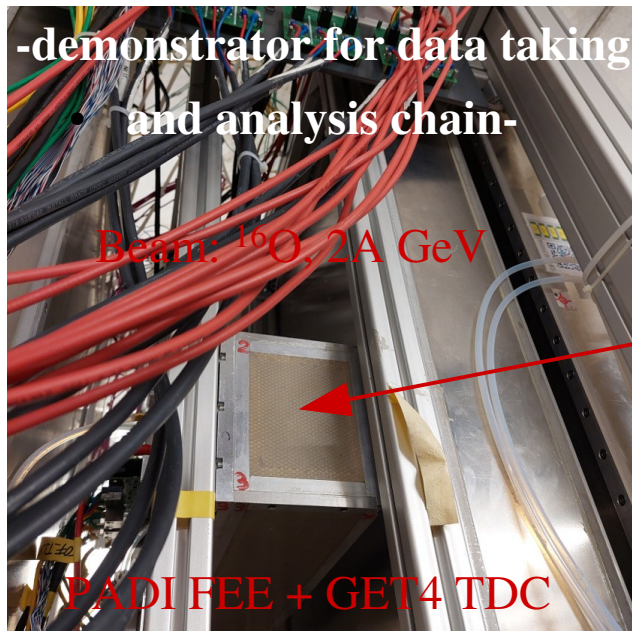

M. Petris et al., Nucl. Inst. and Methods A 1045 (2023) 167621

Aging investigations of MSMGRPC with gas exchange via diffusion

- IRASM/IFIN-HH multipurpose irradiation center
- ^{60}Co source: 360 kCi;
- Dose rate = 0.3 kGy/h

D. Bartos et al., Nucl. Inst. and Methods A 1024 (2022) 166122



MSMGRPC under high γ flux

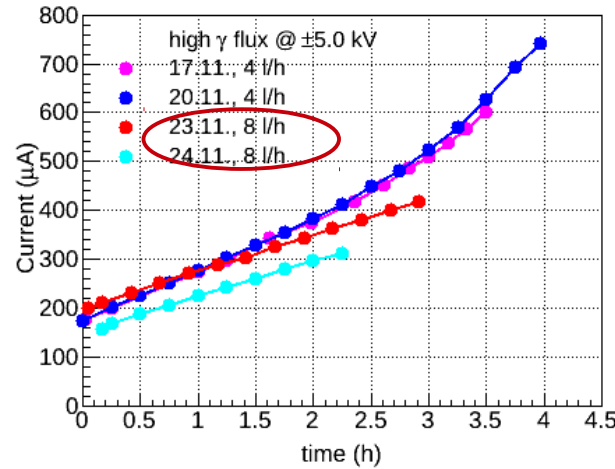

Accumulated charge: 0.127 C/cm²
Chamber area = 9.6 cm x 30 cm

MSMGRPC short term recovery
Dark current

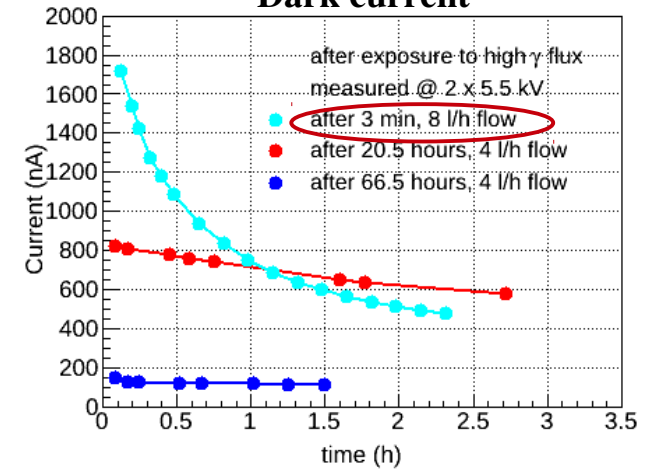

90% C₂H₂F₄ + 5% SF₆ + 5% iso-C₄H₁₀

MSMGRPC “long” term recovery

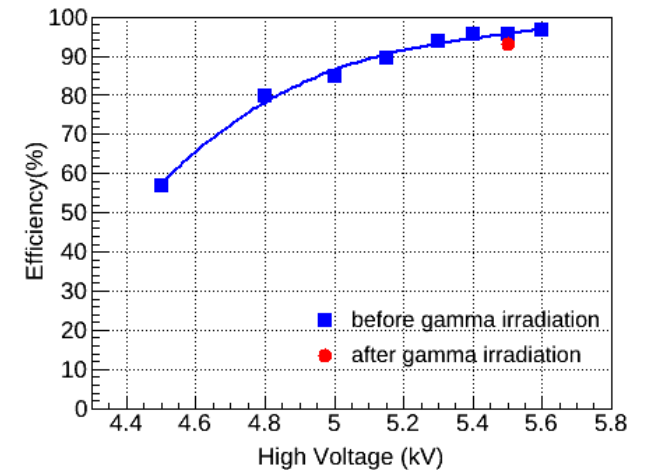
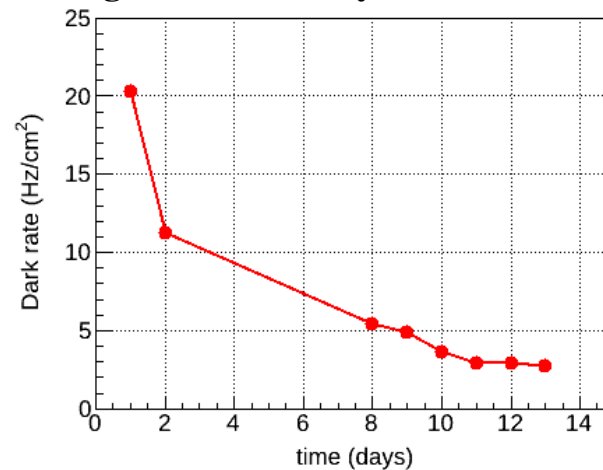
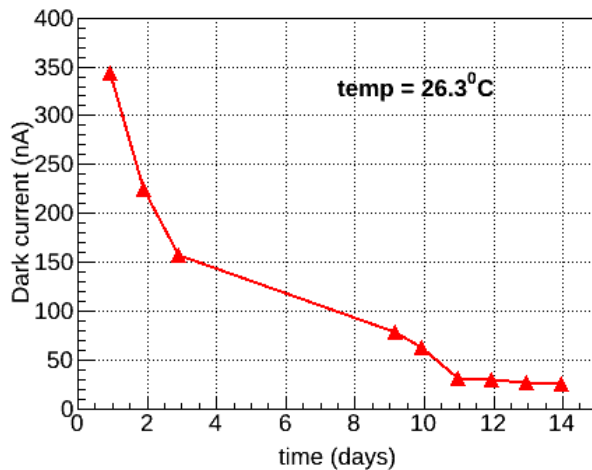

Aging investigations

Dark rate generated around the spacers

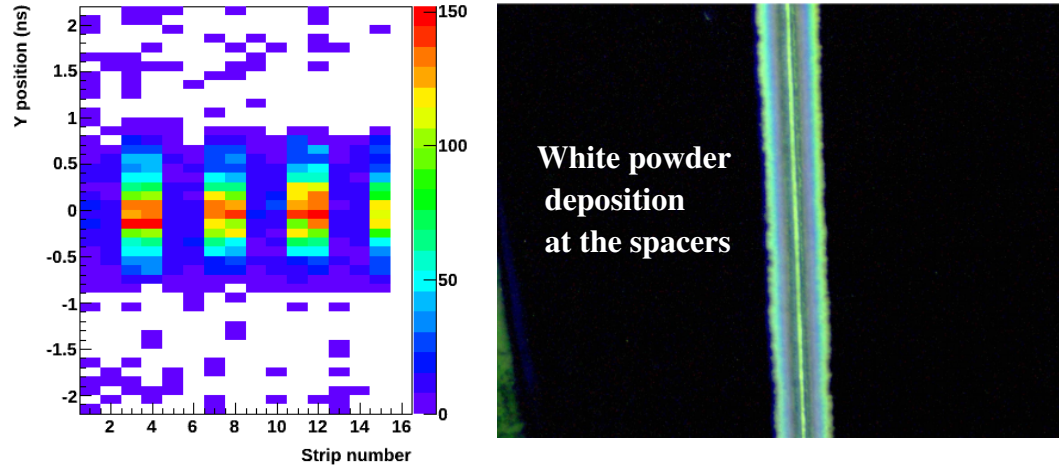

Glass inspections performed with various methods: (SEM, XPS, AFM RBS, non-RBS, THz-TDS)

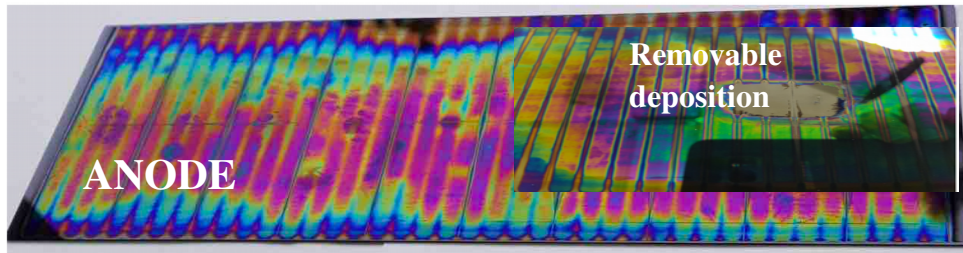

Glass resistivity remains unchanged



(XPS) analysis of the chemical composition of irradiated and non-irradiated glass plates

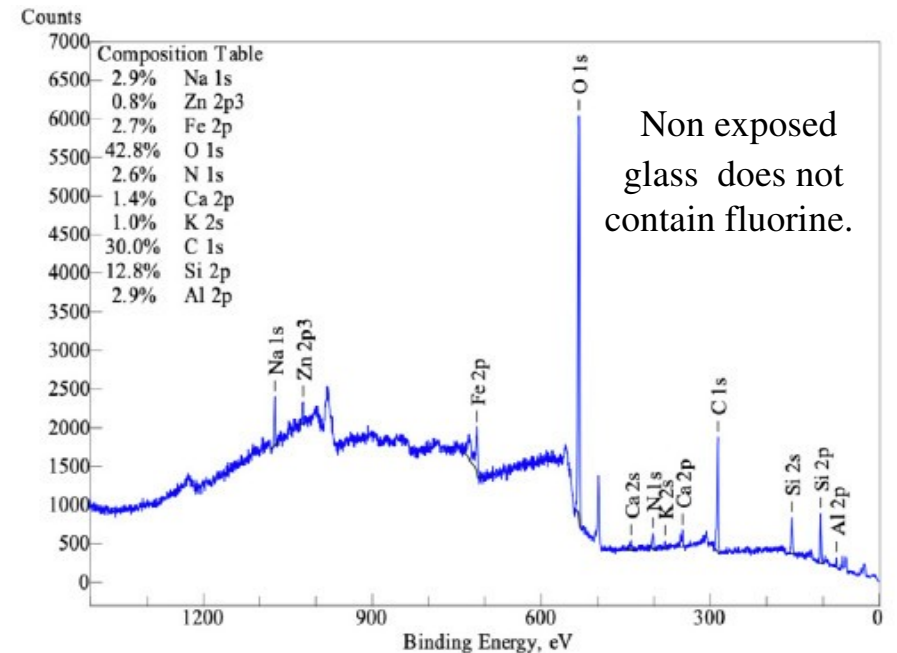
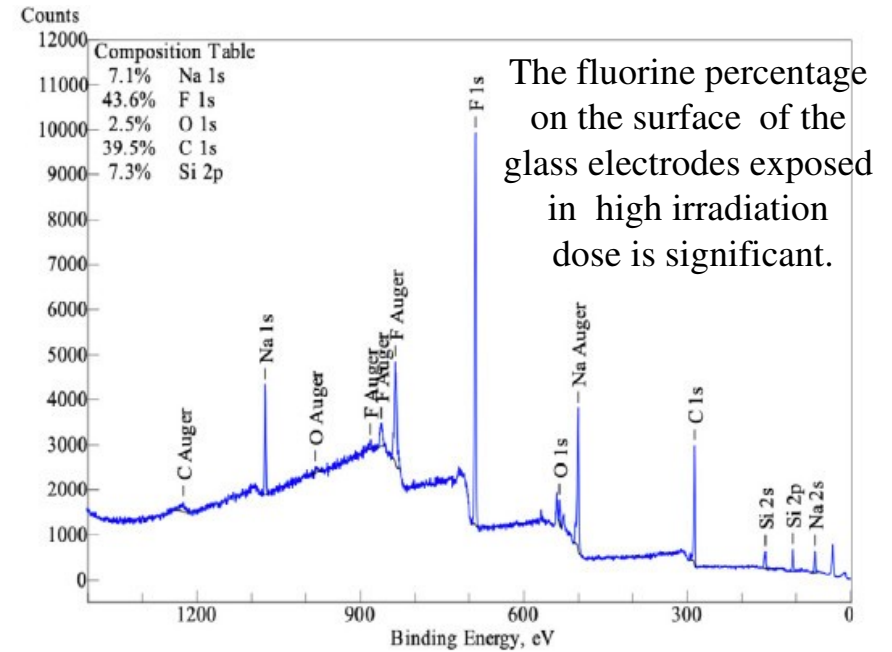

D. Bartos et al., Nucl. Inst. and Methods A 1024 (2022) 166122

First MSMGRPC prototype with a direct flow – 70% gas transmission

Assembling of MRPC1a
(56 mm strip length)

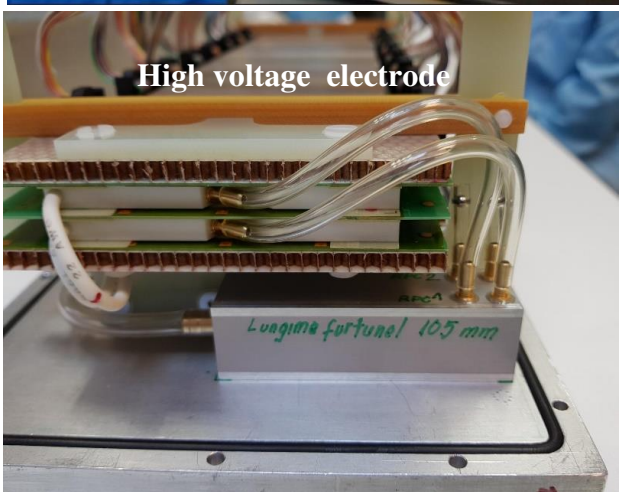
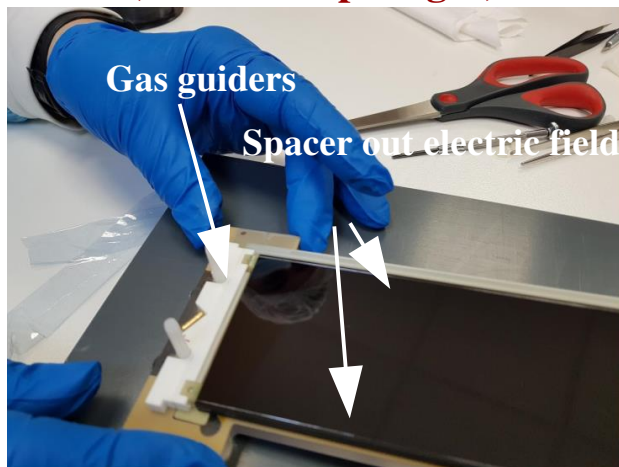

- Direct gas flow through the gas gaps.
- Spacers run across the strips.
- Spacers outside electric field area.

mCBM@SIS18 July 2021
in-beam test results

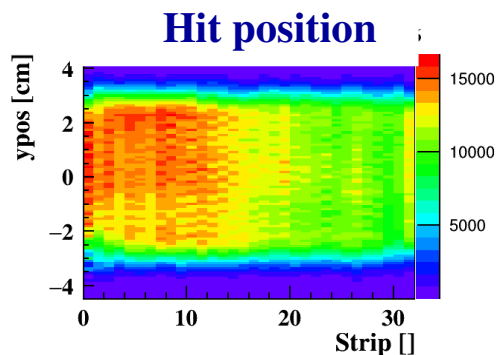

High voltage scan

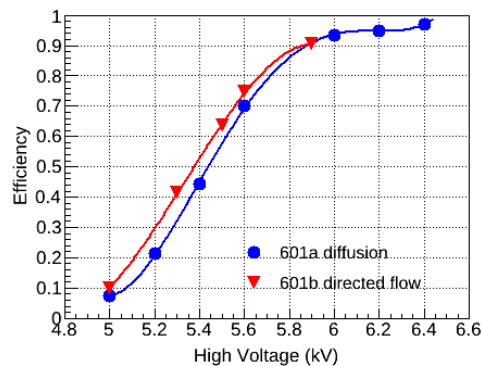

Time resolution @±5.9 kV

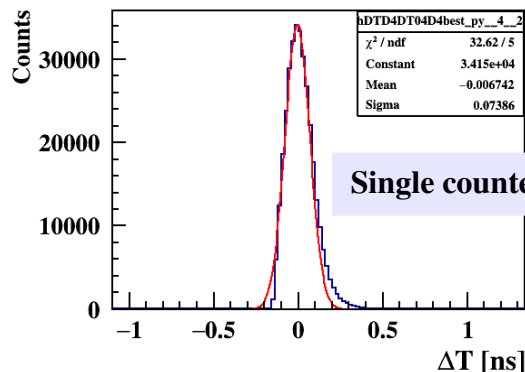

Single counter = 51 ps

High intensity X-ray irradiation

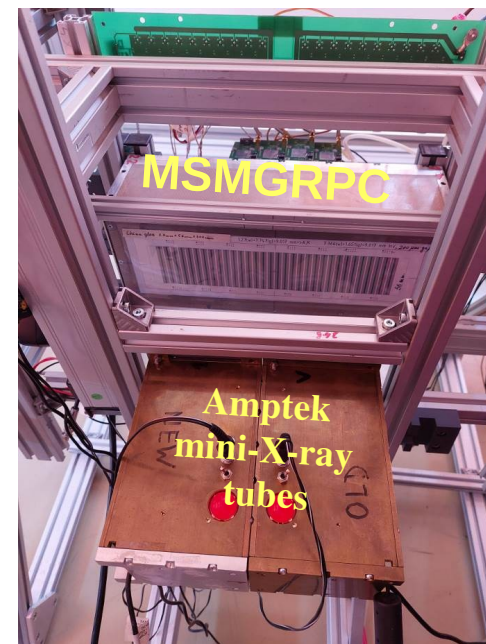

Gas mixture: 97.5% $C_2H_2F_4$ + 2.5% SF_6

Gas flow rate: 4 l/h

HV = +/- 6 kV

Deposition on the middle of the glass electrode

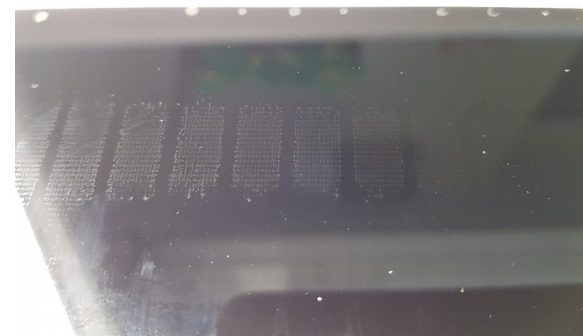

Second MRPC1a prototype with direct flow – 100% gas transmission

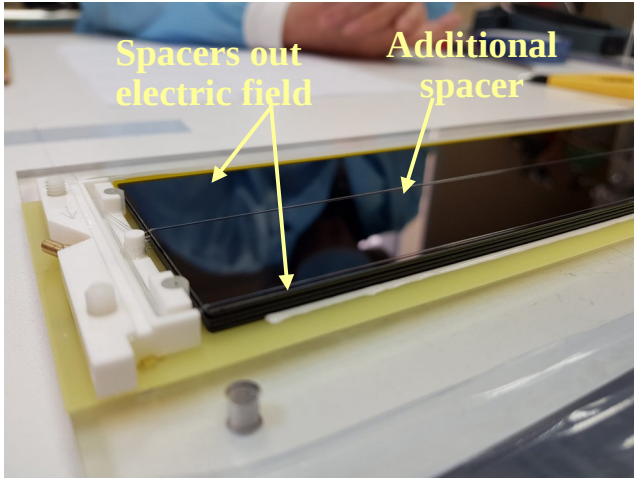

Dark current up to 2 x 6.4 kV
before HR test < 10 nA
after HR test < 10 nA

Negligible dark counting rate
after HR test

Clu rate of Rpc #000 in Sm 000 of type 6

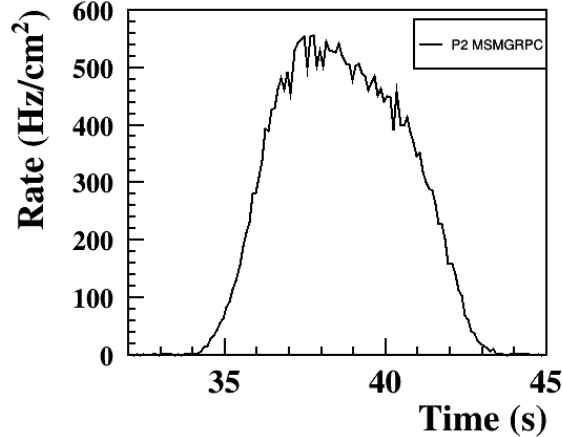

Clu rate of Rpc #000 in Sm 000 of type 6

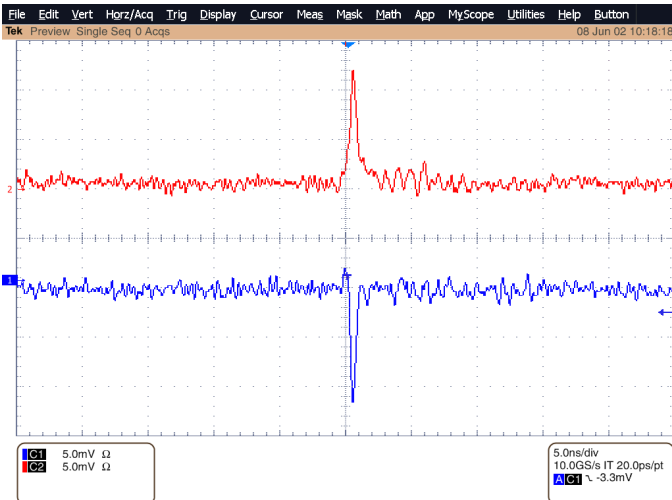
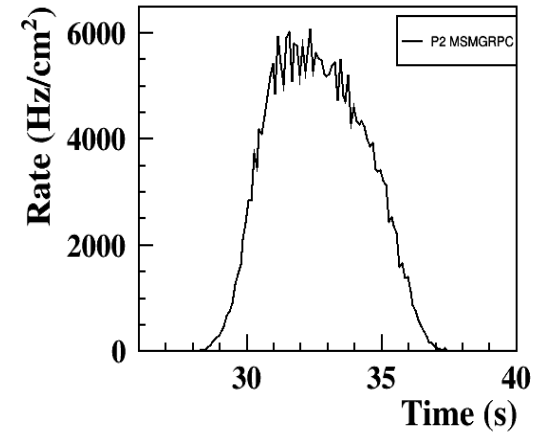

Au(65+) + Au at 1.13 AGeV, 2.5mm Au target/0.4mm/4mm Ni target
Rate scan (HR) -> intensity per spill: 1×10^7 , 3×10^7 , 1×10^8 , 3x to 4×10^8
Exposed to the highest delivered counting rate for ~8 hours

High intensity X-ray irradiation of MRPC1a

Current & counting rate during high intensity X-ray flux exposure

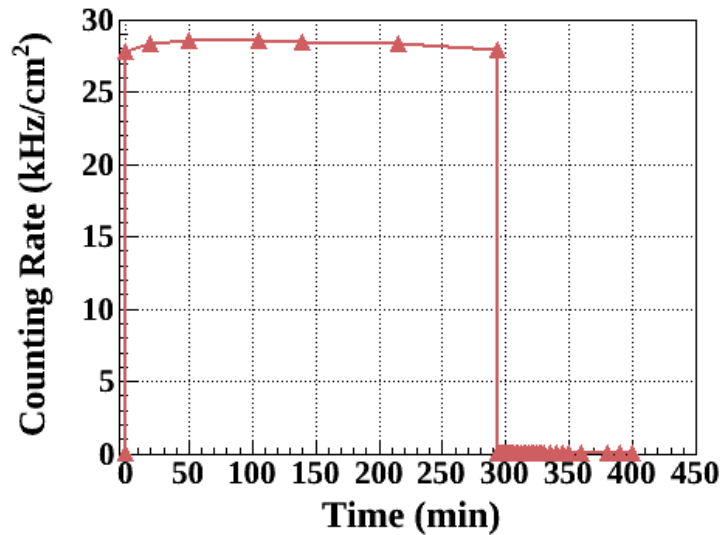
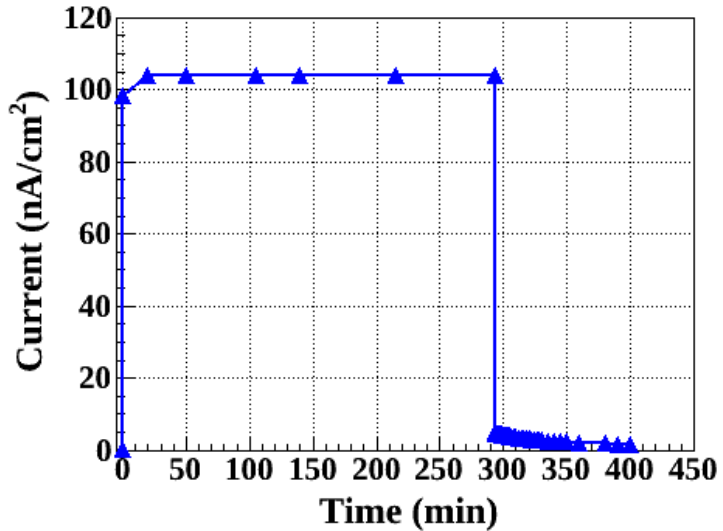

Dark current & dark counting rate after X-ray exposure

Gas exchange via diffusion

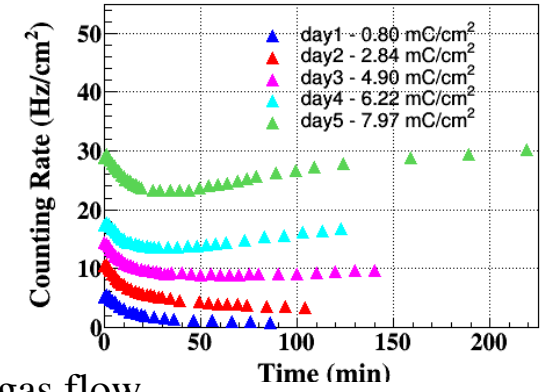
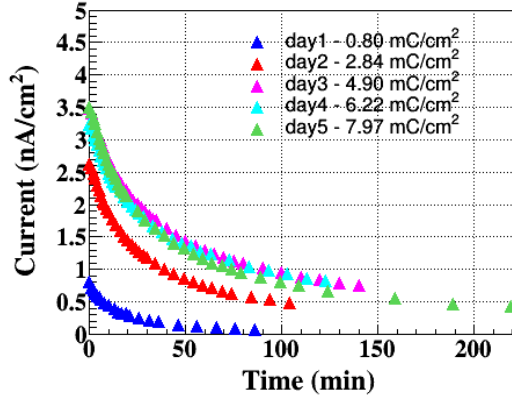

Direct gas flow

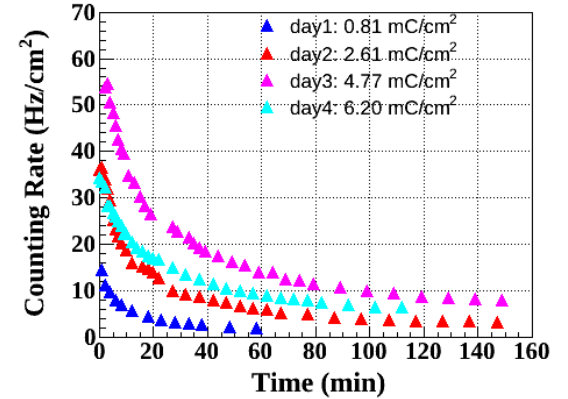
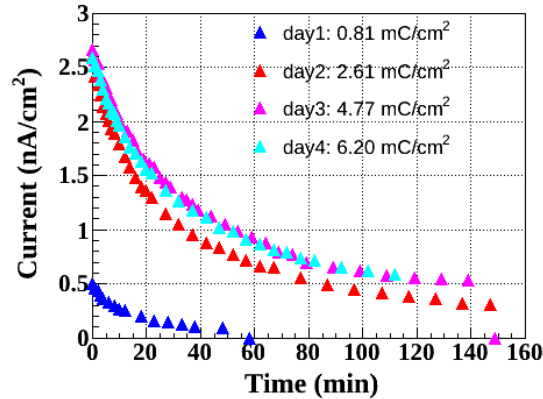

Direct gas flow at different gas flow rate

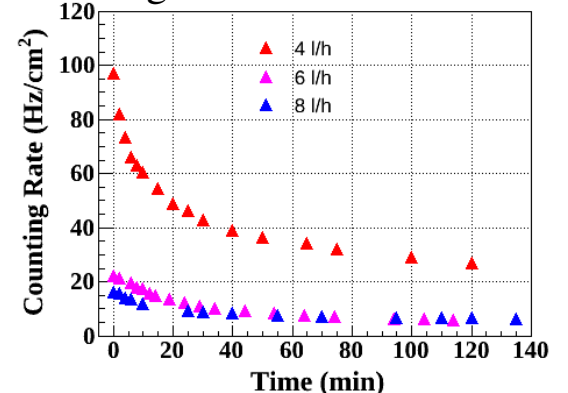
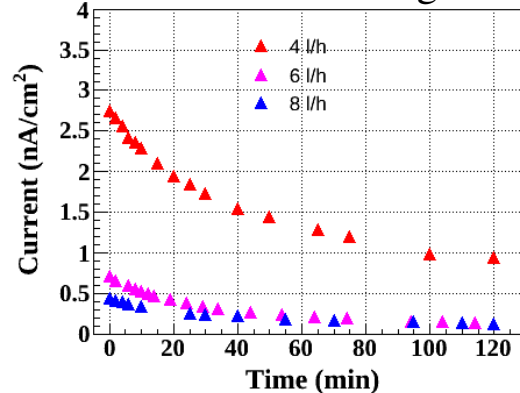

Mapping the direct flow counter with cosmic rays, in self – triggered mode, after X-ray exposure

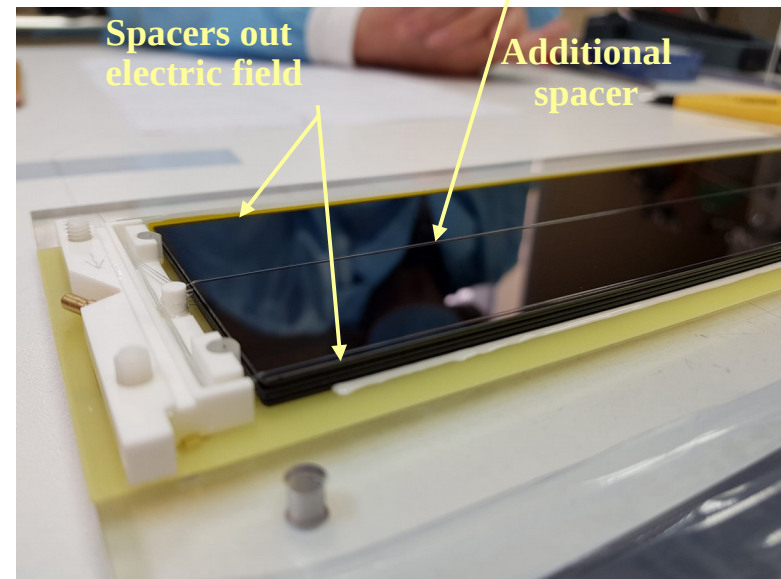
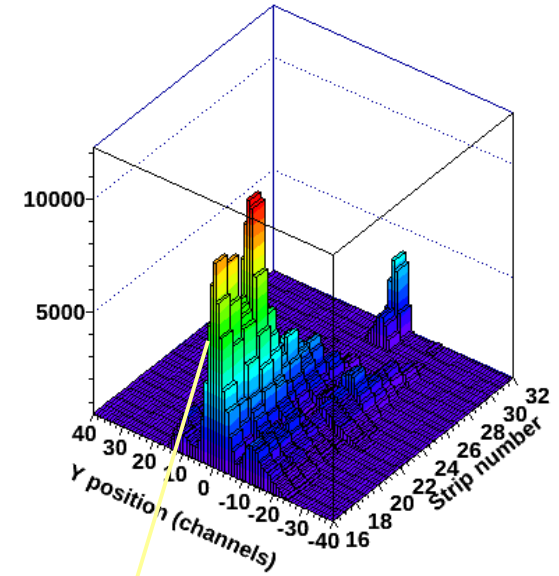
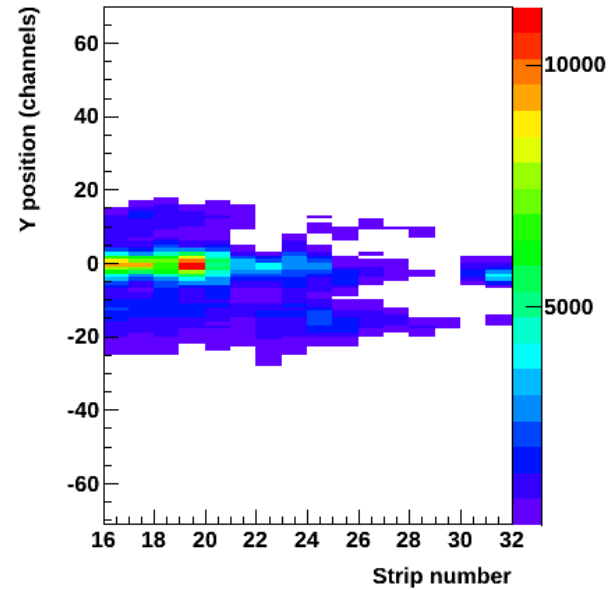

Direct gas flow counters MRPC1b

Gas guide design

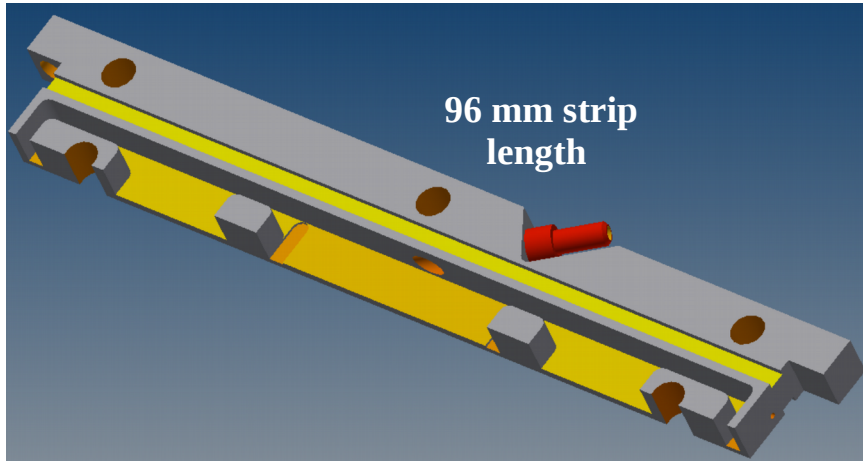

Assembling of MRPC1b (96 mm strip length)

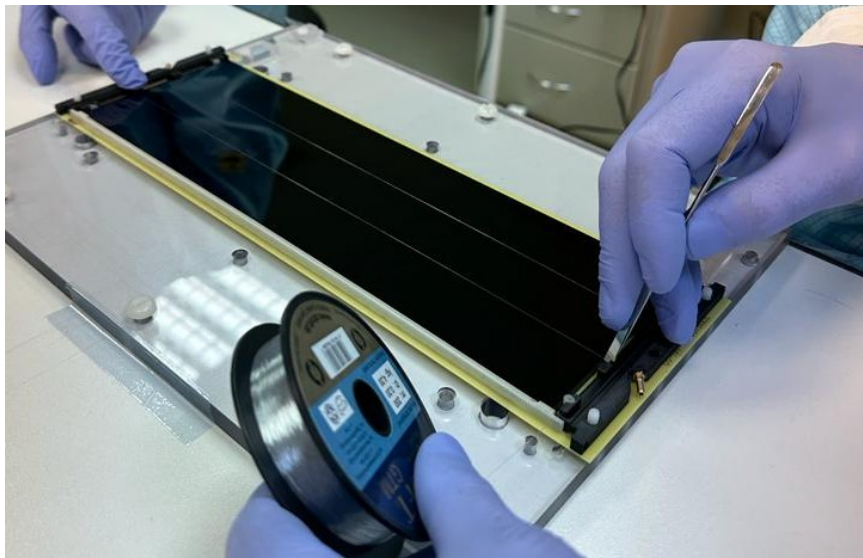

3D printed gas guide

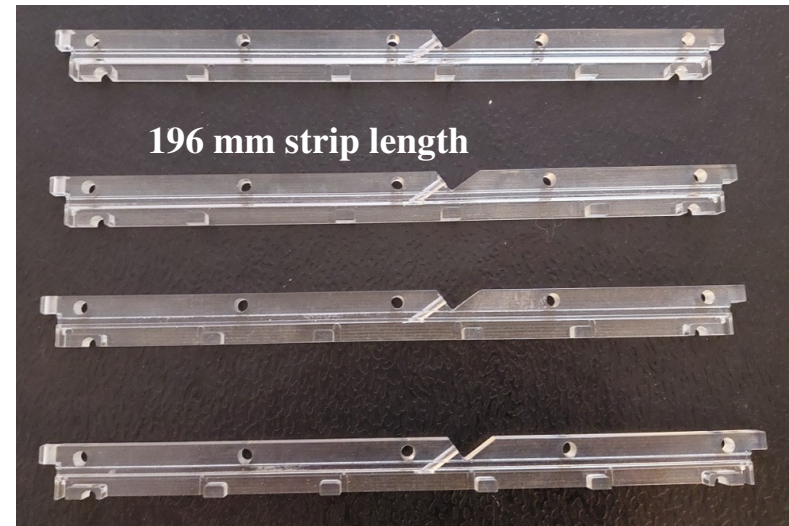

Assembling of MRPC1c (196 mm strip length)

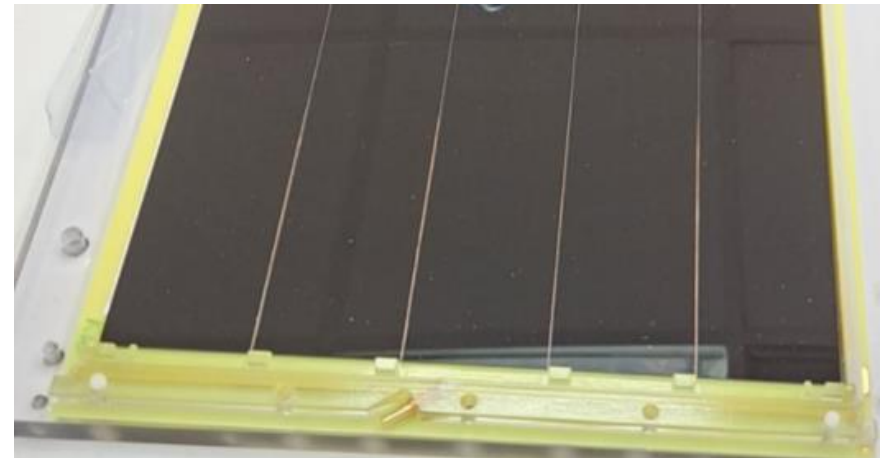

Aging tests, high X-ray flux MRPC1b & MRPC1c

Chamber tightness

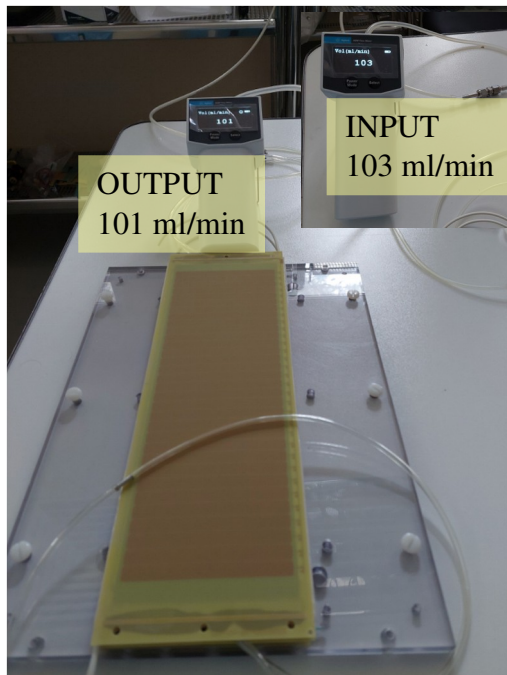

Experimental setup

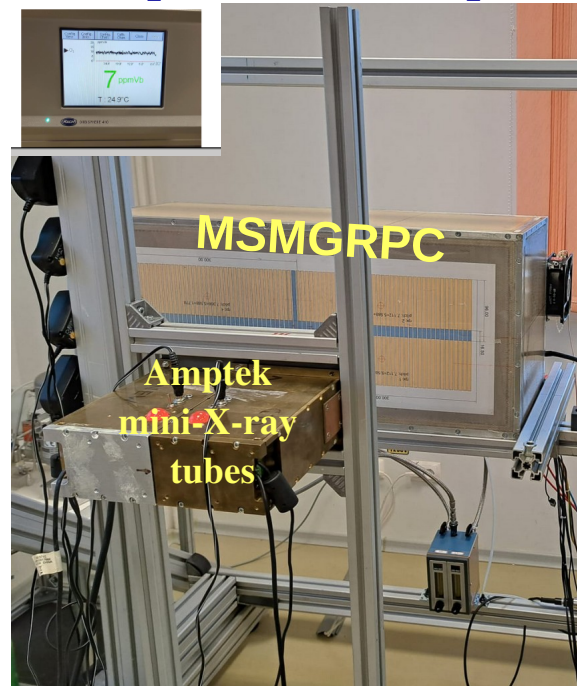

MRPC1b

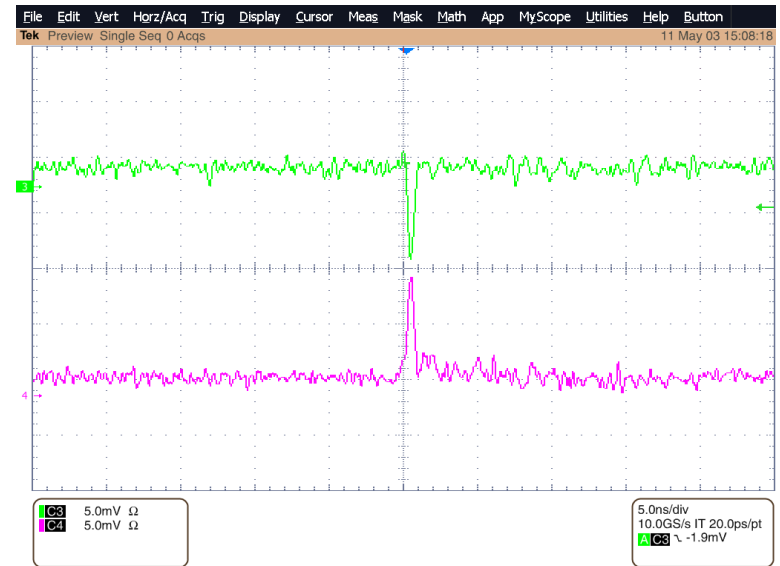

Gas mixture: 97.5% $C_2H_2F_4$ + 2.5% SF_6

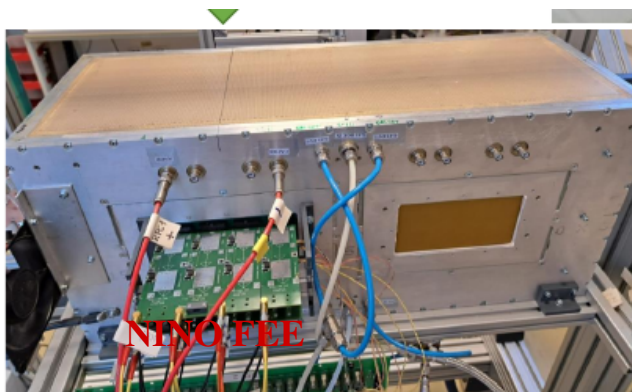

Dark current & dark counting rate after high X-ray flux exposure

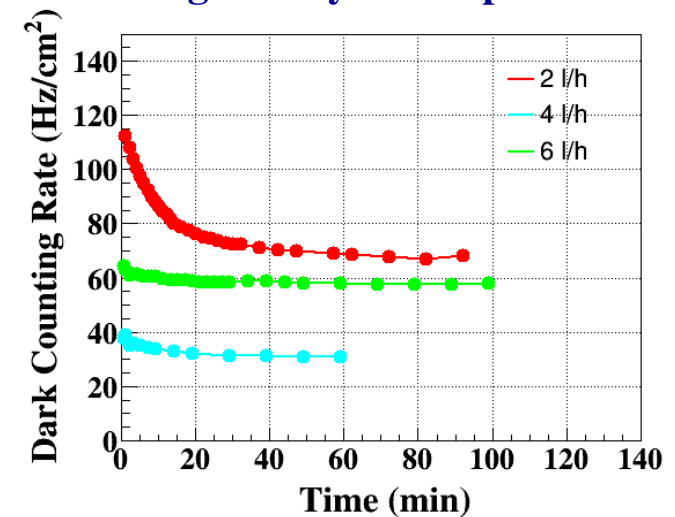
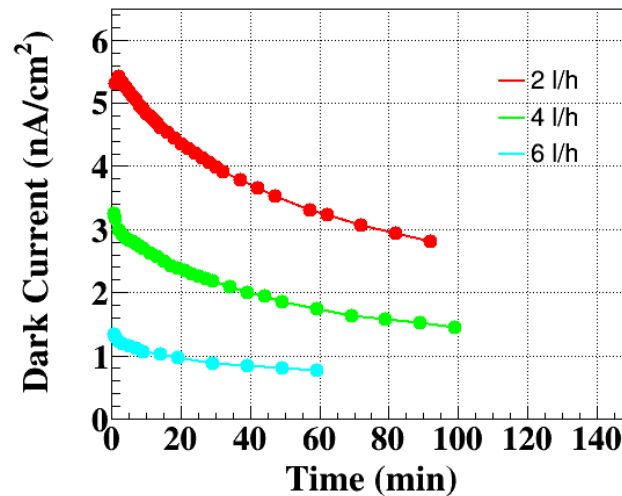

Dark rate long – term evolution

Counter	exposure
MRPC1a (56 mm)	End on 28.09.2022 (35 mC/cm ²)
MRPC1b (96 mm)	21.03 – 13.04.2023 9.4 mC/cm ²
MRPC1c (196 mm)	19.04 – 28.04 2023 2.4 mC/cm ²

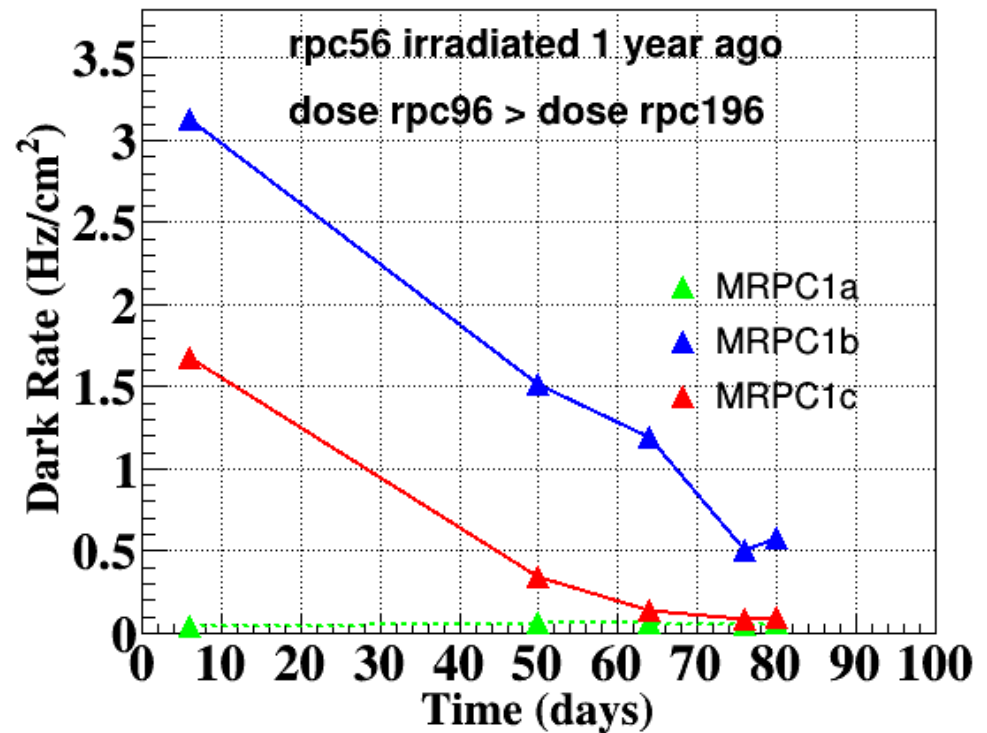

Cosmic - ray tests of the direct flow prototypes

Direct flow MSMGRPC stack

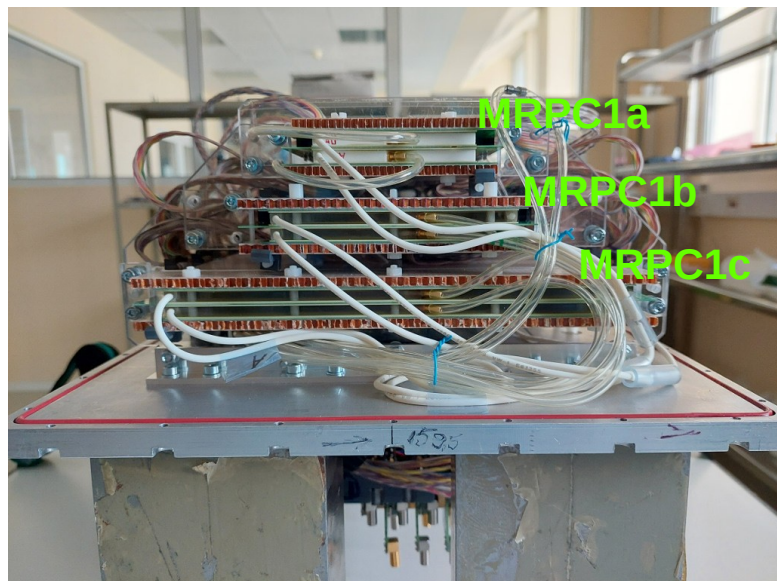

Experimental setup for cosmic rays test

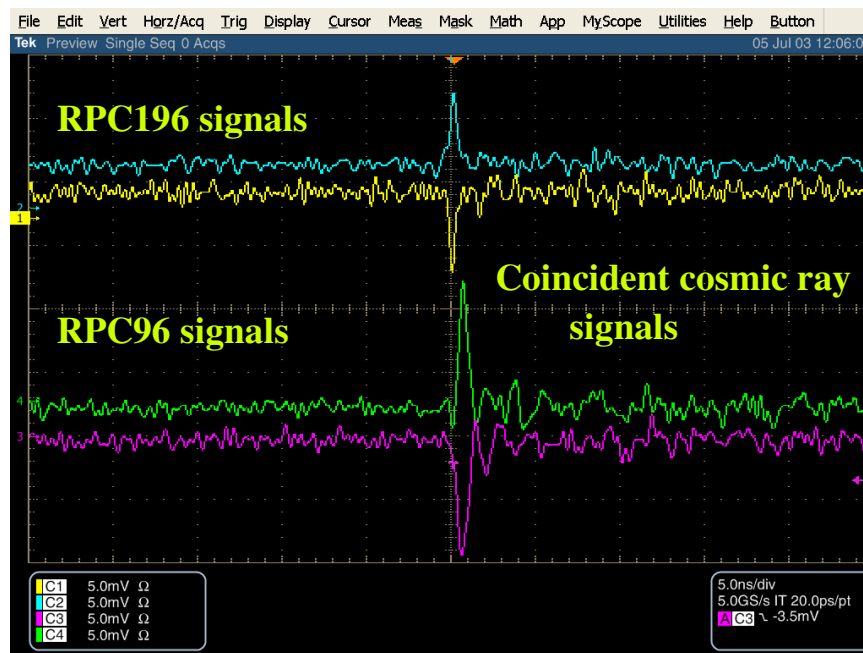
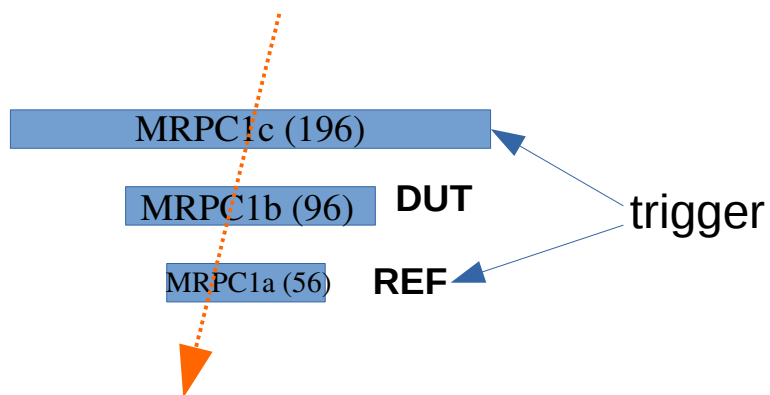
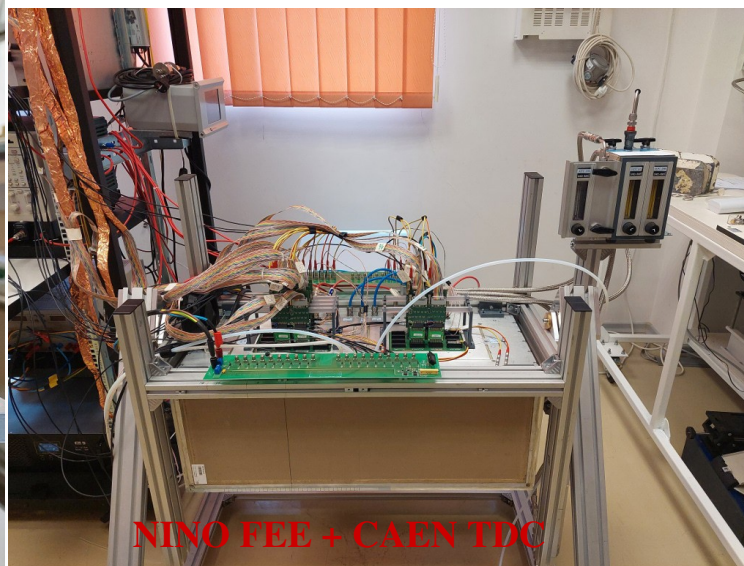

Cosmic - ray tests of the direct flow prototypes

Efficiency & time resolution after exposure to high X-ray flux

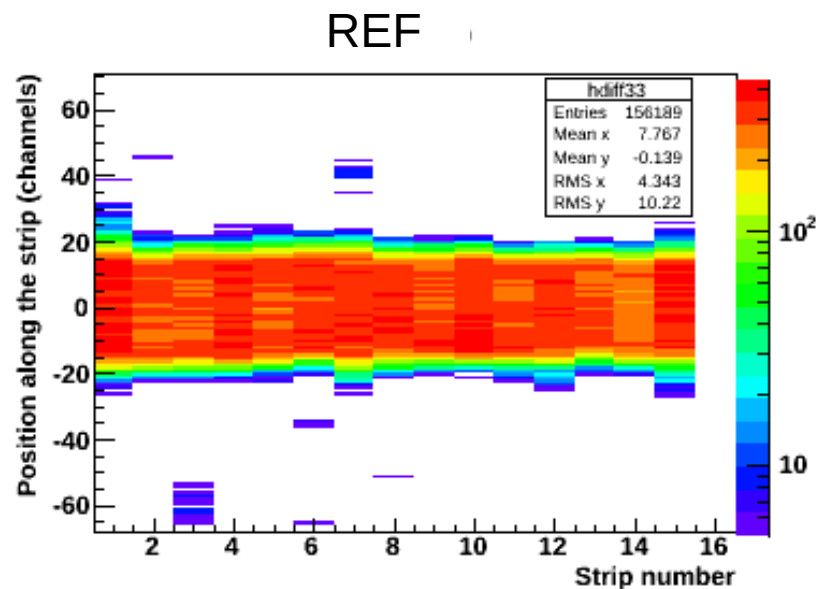
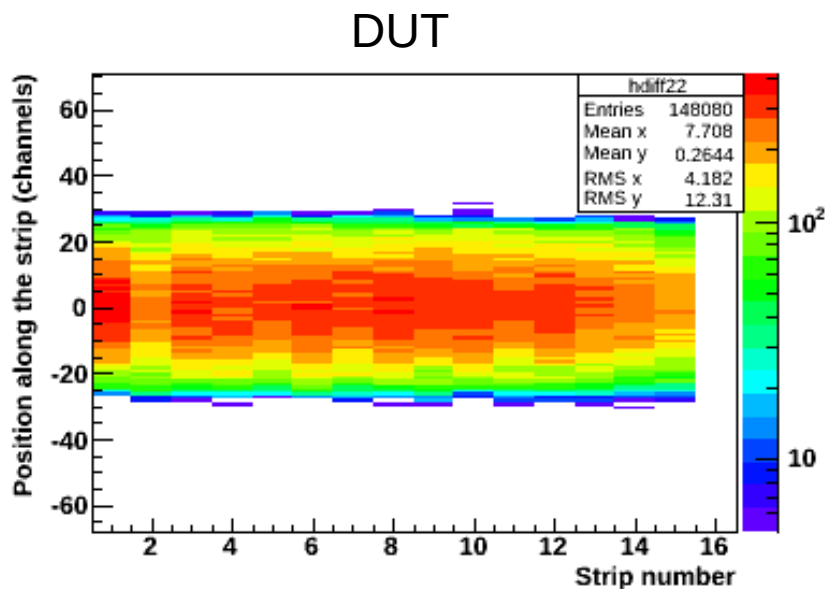

Efficiency = 94.8%

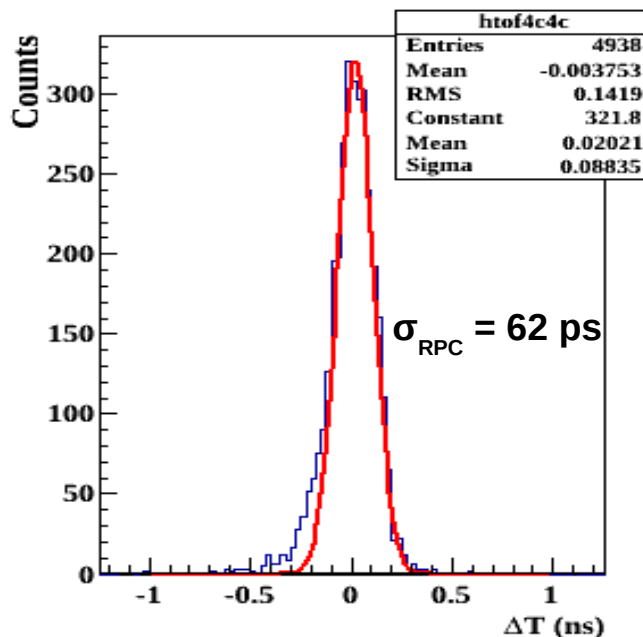

2D mapping of MRPC1b active area in self triggered mode

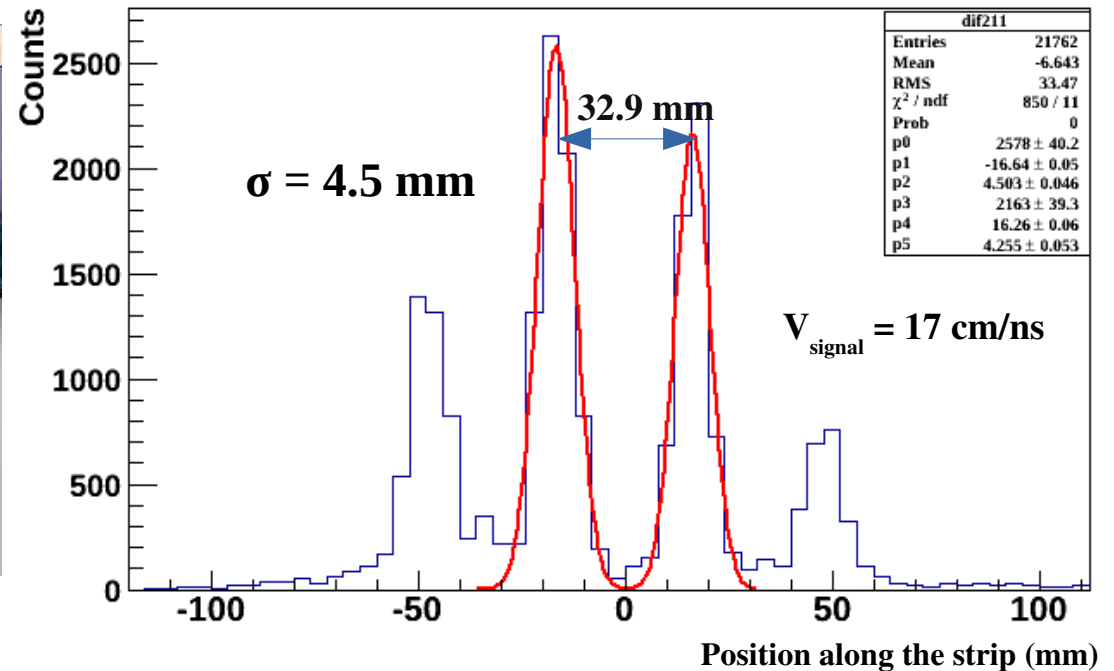
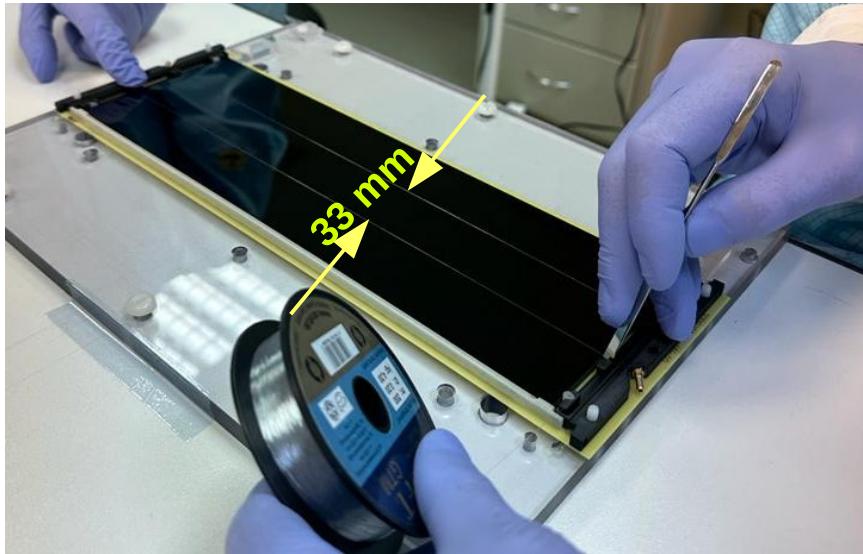
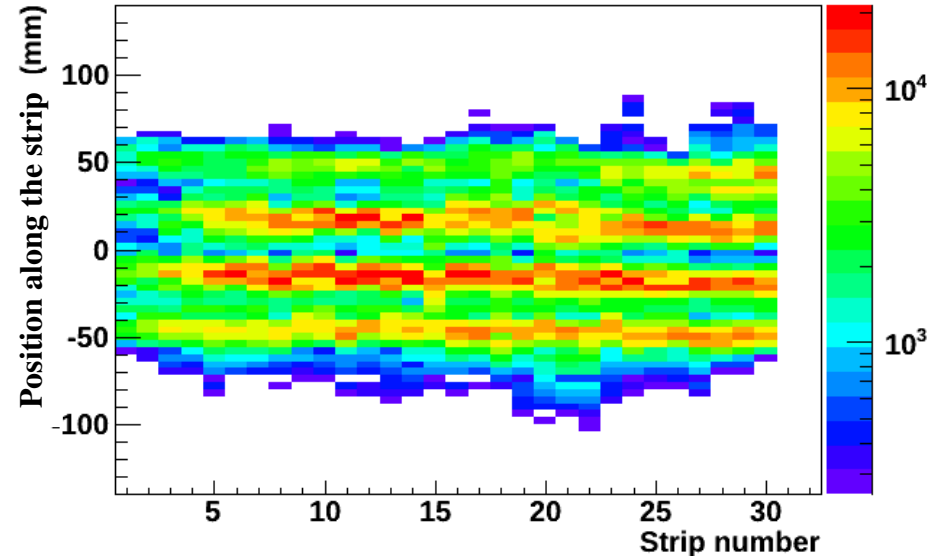
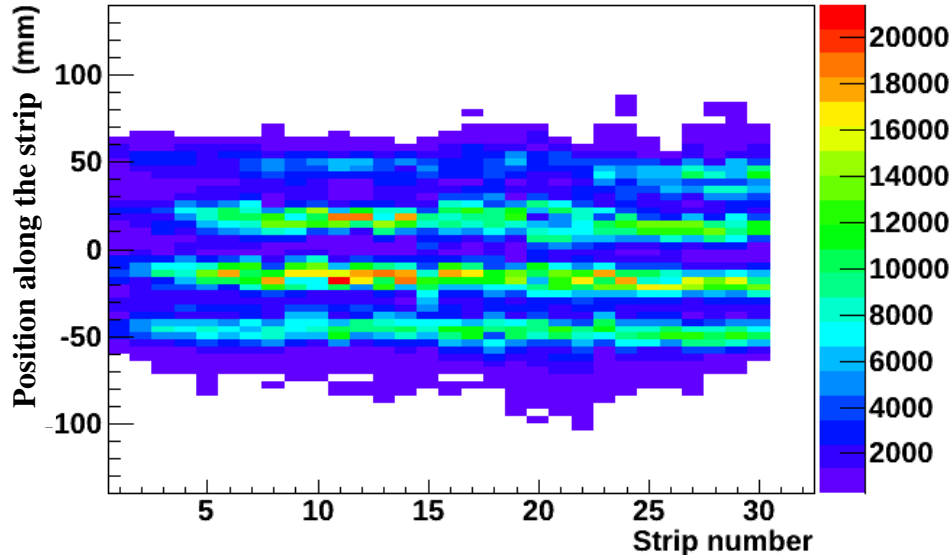

2D mapping of MRPC1c active area in self triggered mode

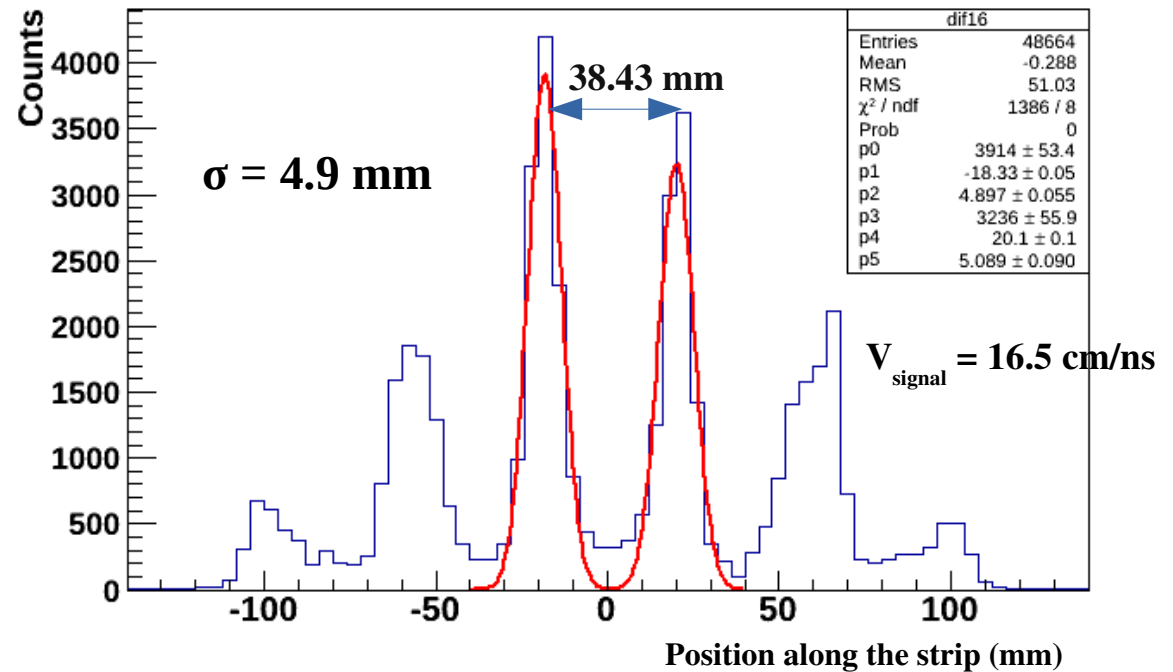
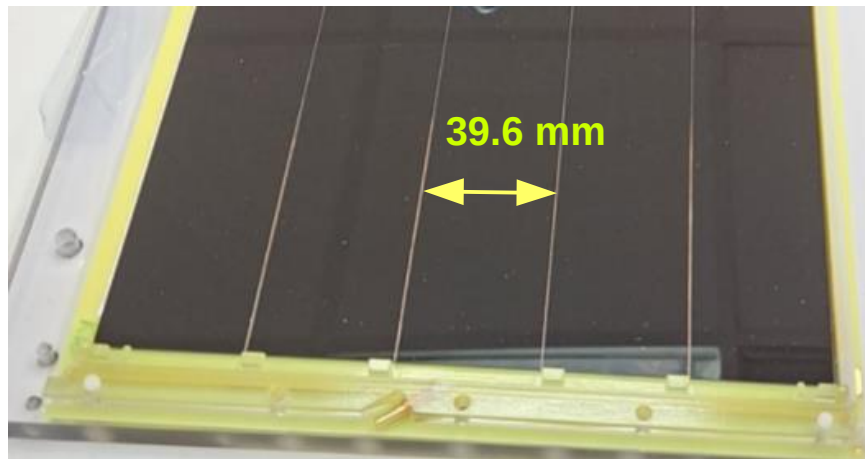
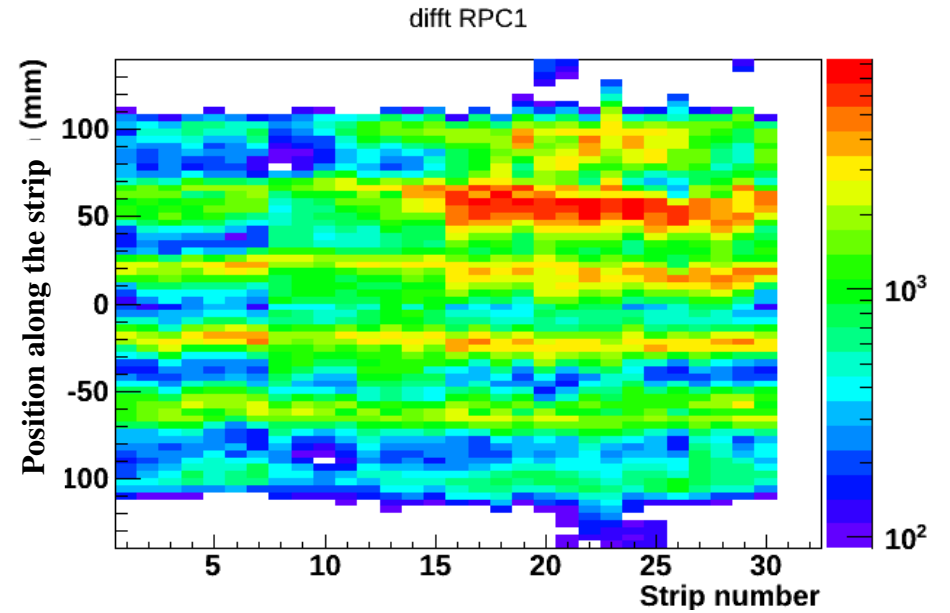
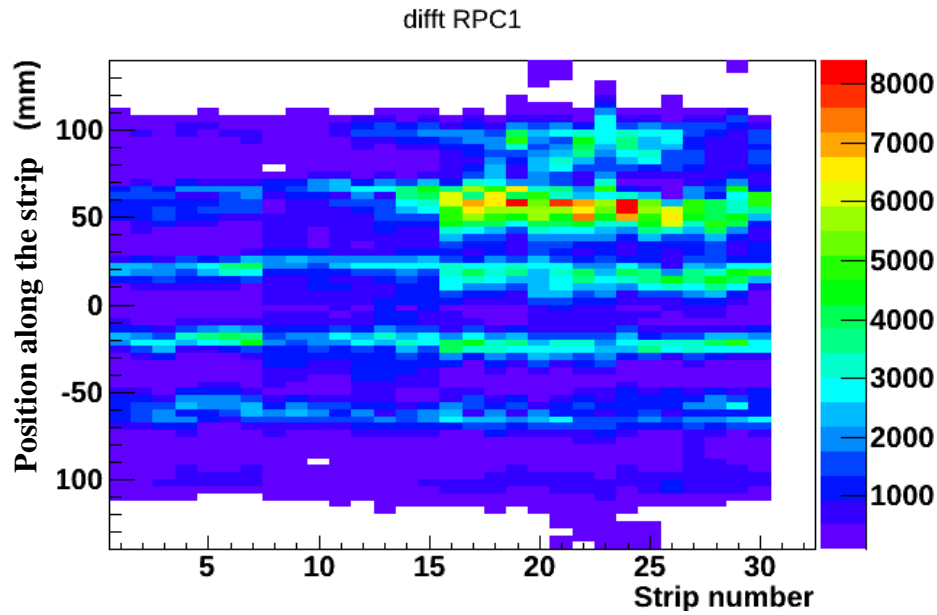

New generation direct flow MSMGRPC

Home made rectangular discrete spacers
2 mm x 2 mm

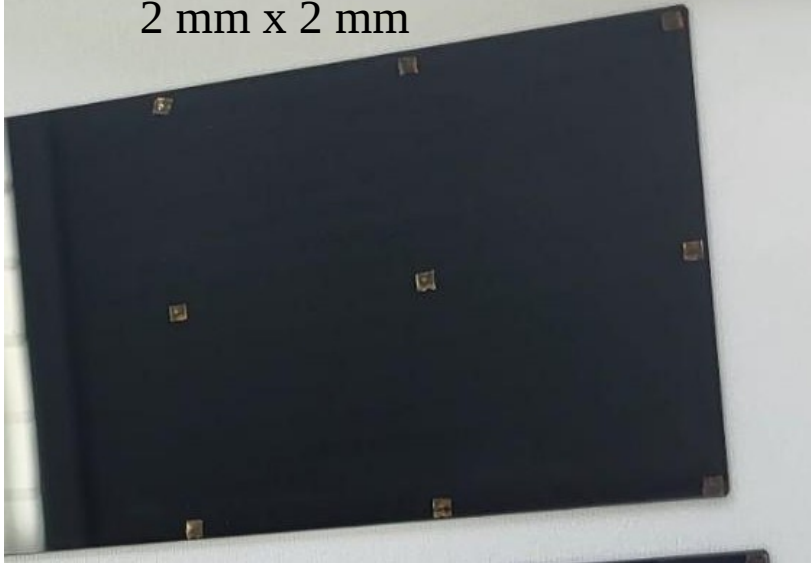

Dark current & dark counting rate after X-ray exposure

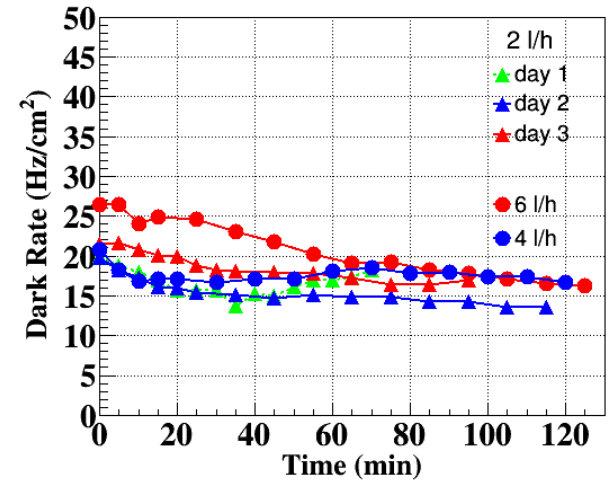
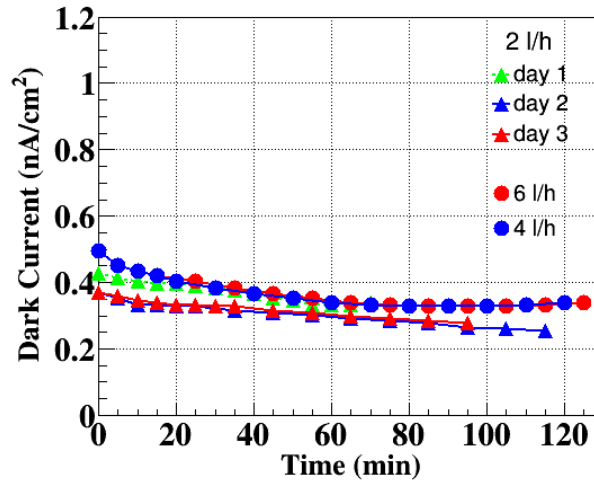

Exposure to high X-ray flux

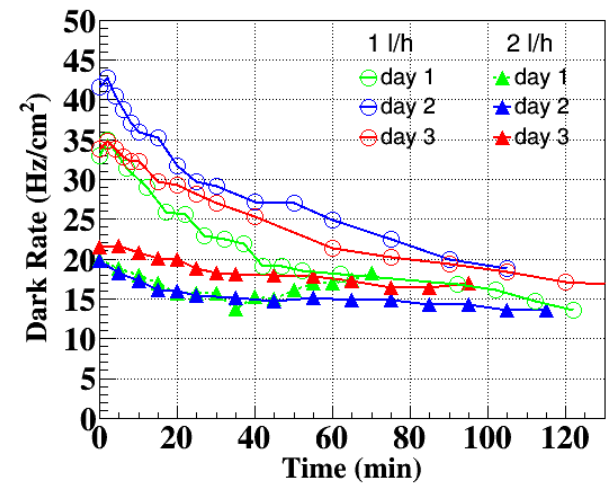
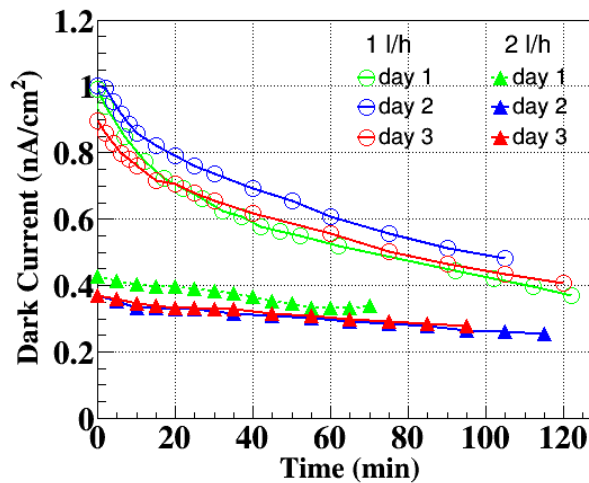
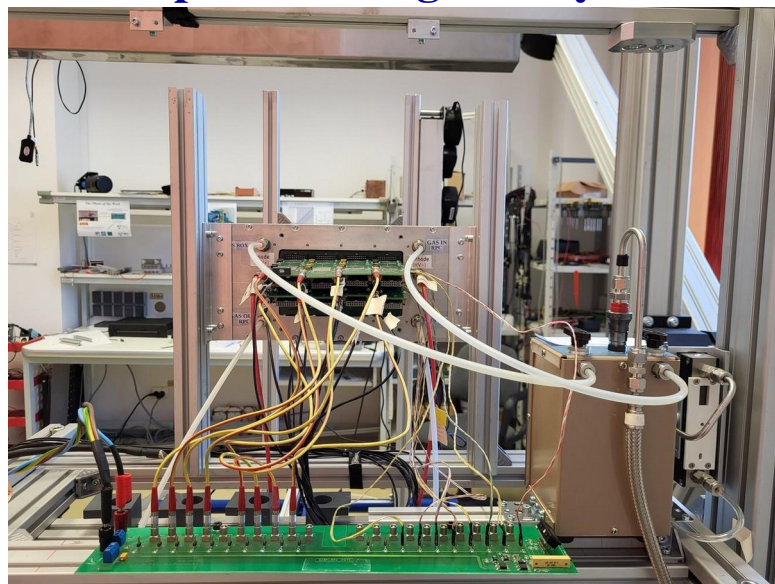

Gas mixture: 97.5% C₂H₂F₄ + 2.5% SF₆

New generation direct flow MSMGRPC – discrete spacers

2D mapping in self triggered mode

Home made rectangular discrete spacers
2 mm x 2 mm

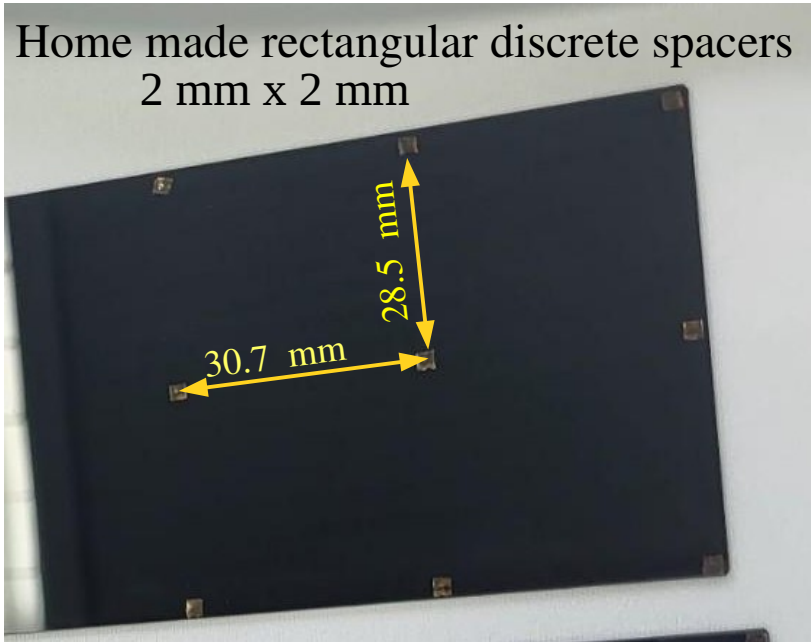

The spacers are the source of the measured dark rate

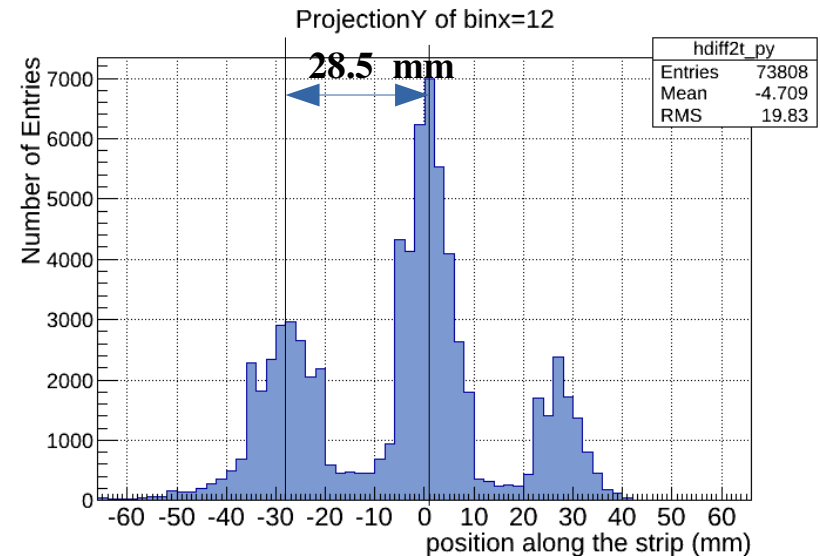
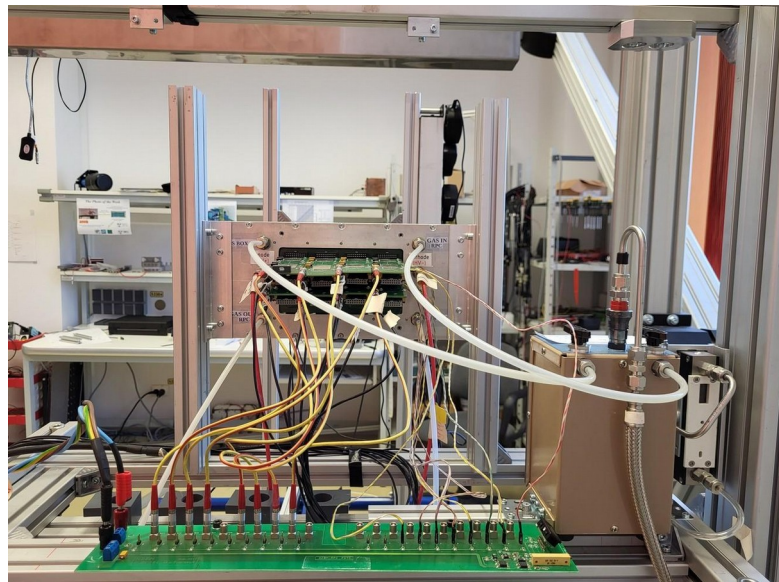
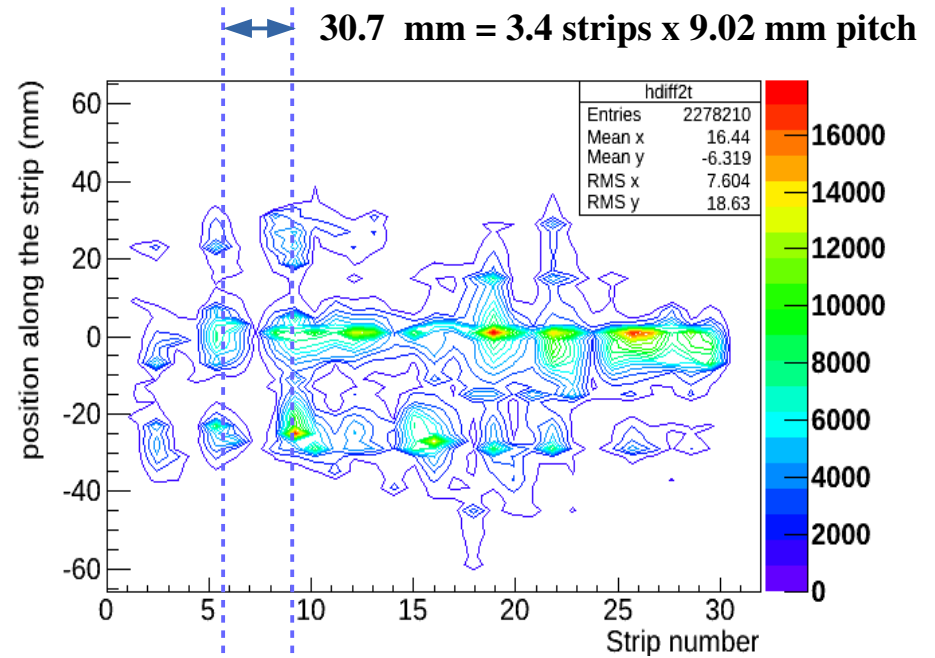

New generation direct flow MSMGRPC based on commercial polyimide disc spacers

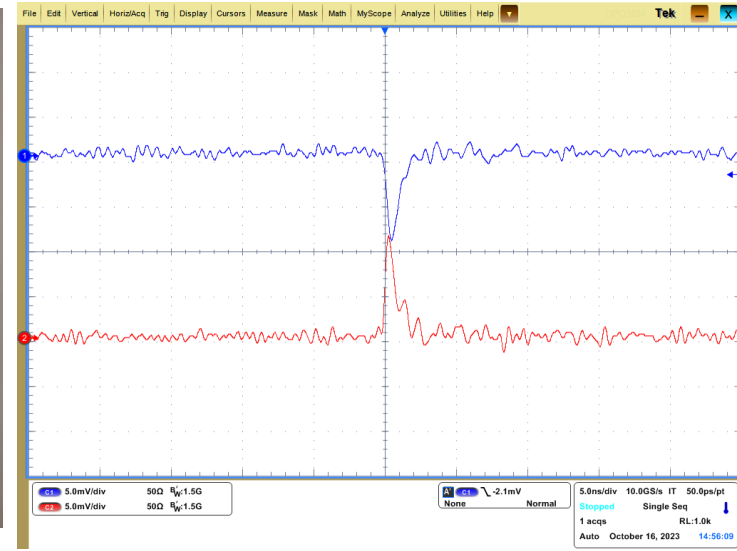
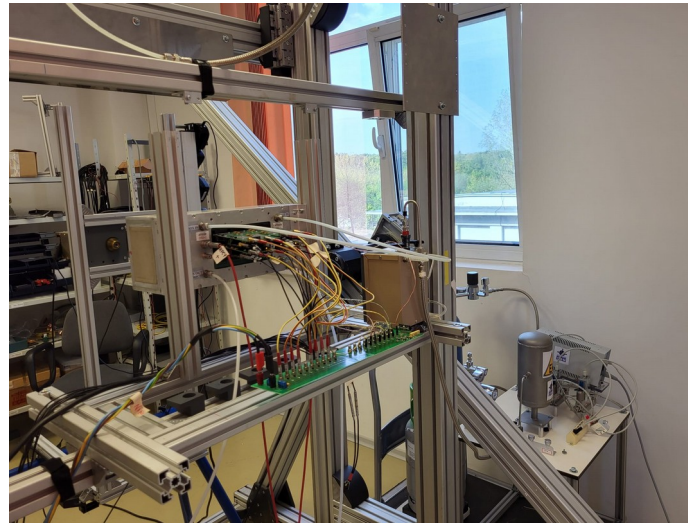
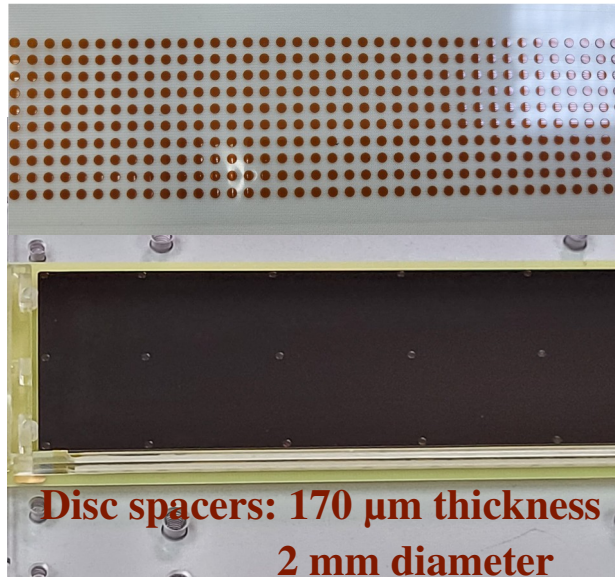

Gas mixture: 97.5% $\text{C}_2\text{H}_2\text{F}_4$ + 2.5% SF_6

Exposure to high X-ray flux & recovery

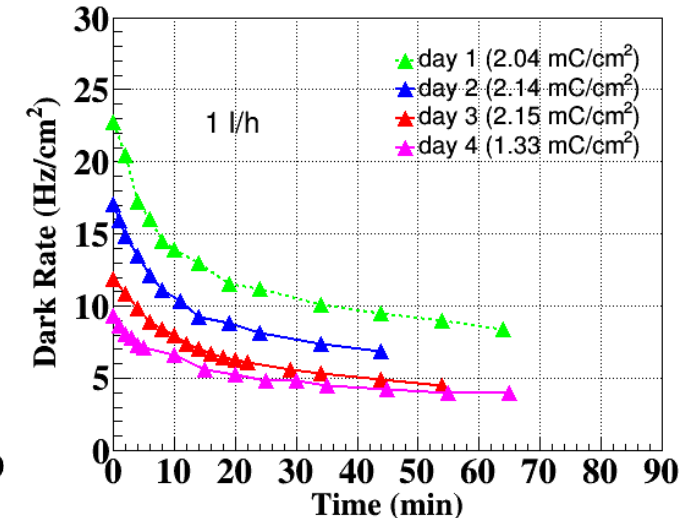
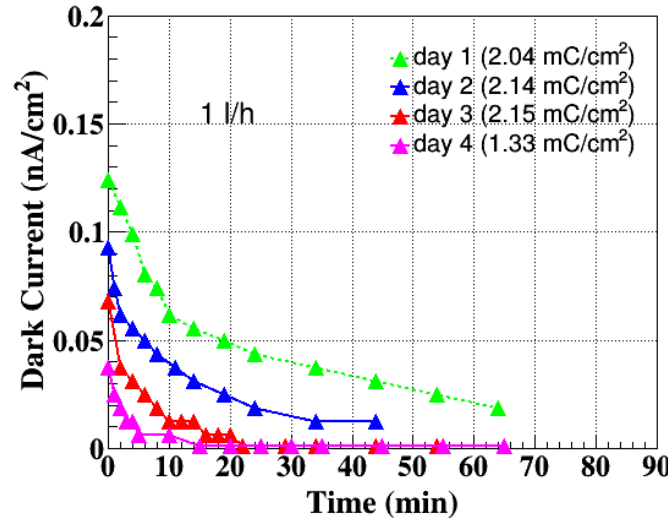
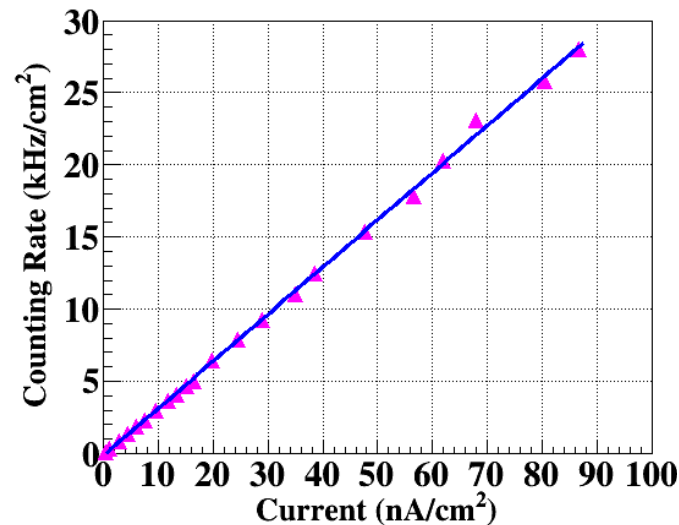

New generation direct flow MSMGRPC based on commercial polyimide disc spacers

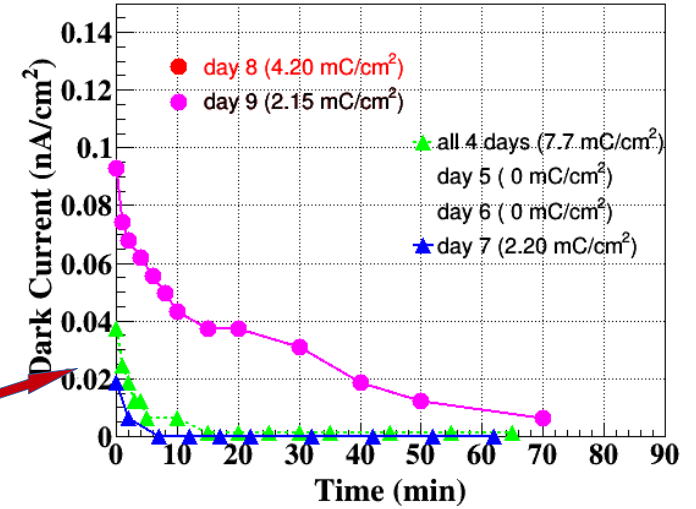
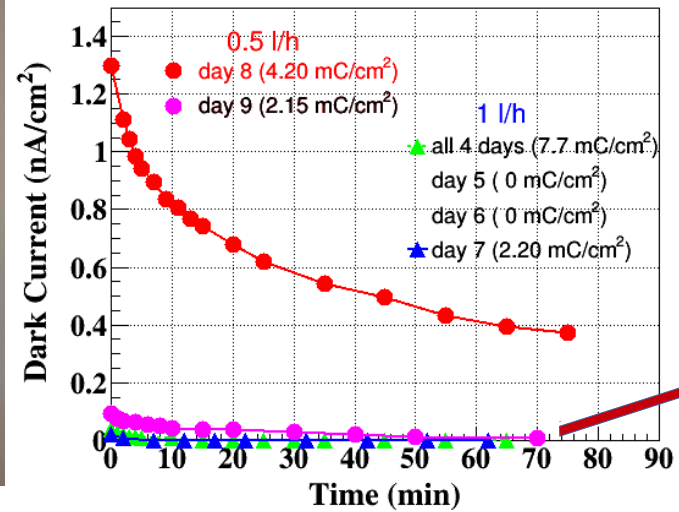
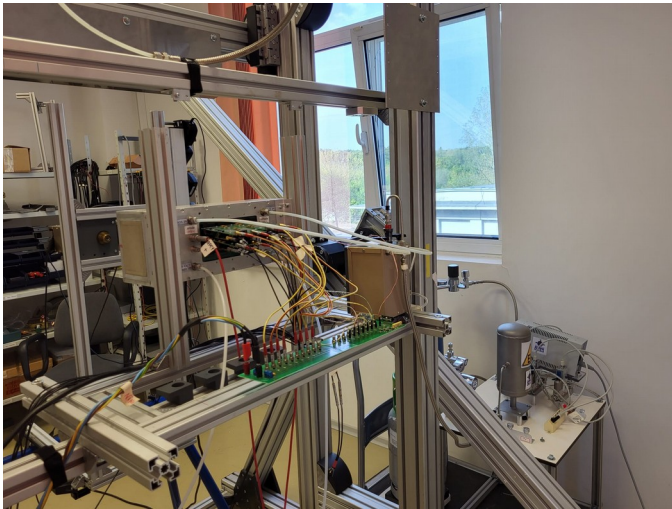

Chamber operation:

All days: 2 x 5.6 kV → 132 kV/cm
Counting rate = 28 – 30 kHz/cm²

Day 8 : 2 x 6.0 kV → 141 kV/cm
Counting rate = 45 – 47 kHz/cm²

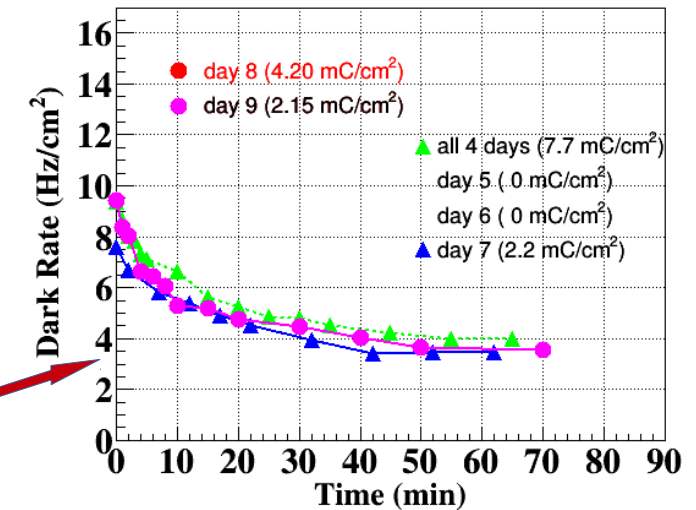
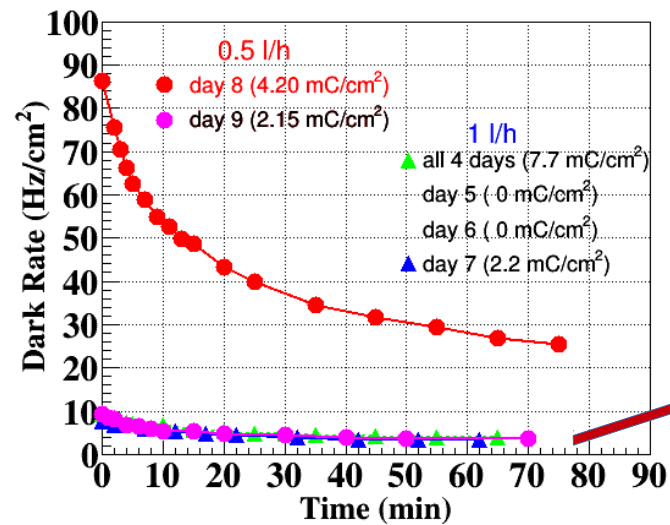

Implementation of the new generation direct flow MSMGRPC in the M0 module of the CBM-TOF inner zone

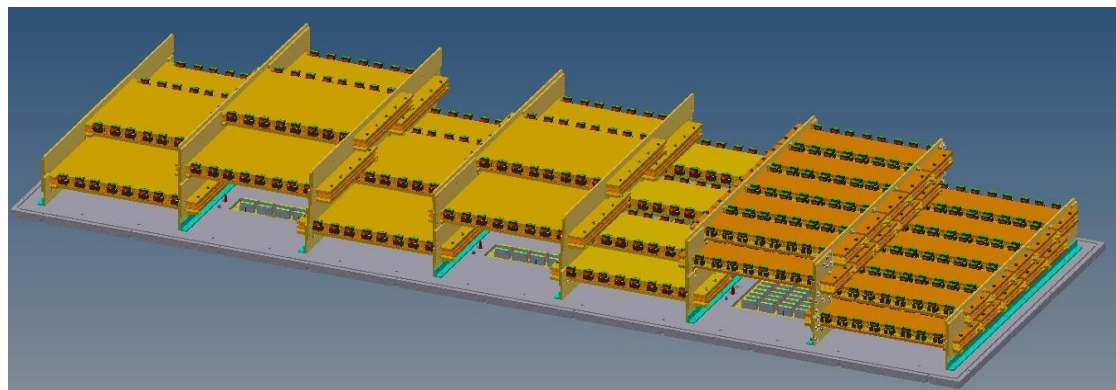
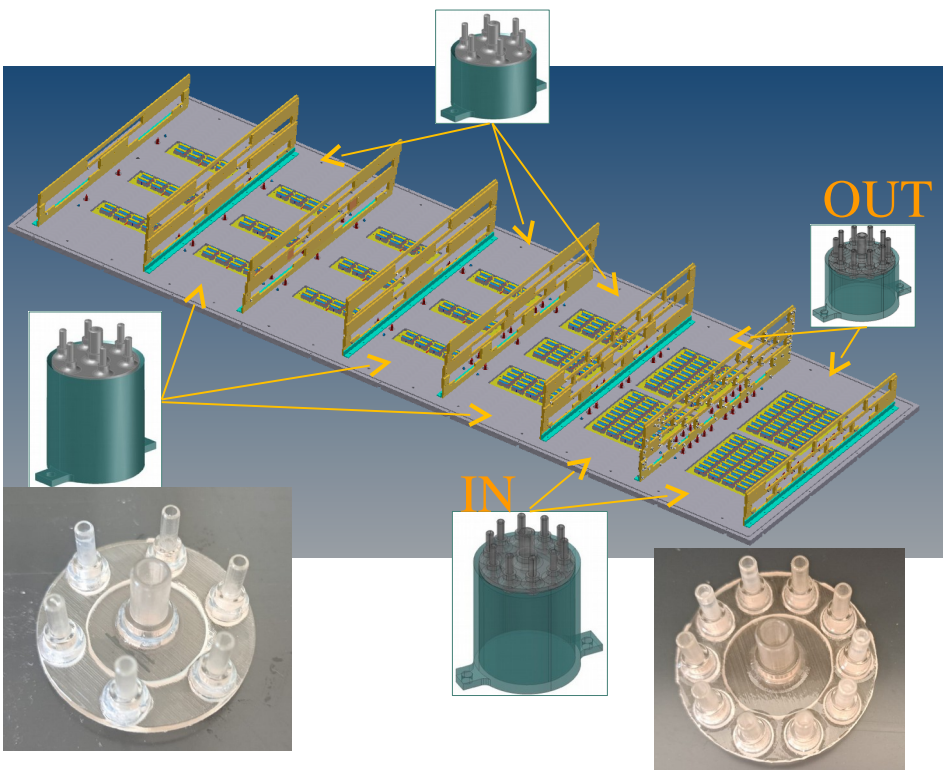

Six/ten gas pipes distributors printed 3D

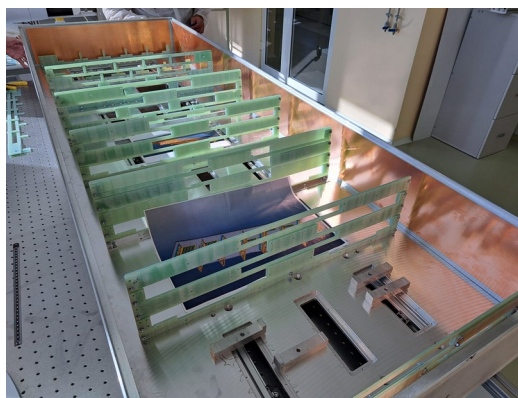

Summary & Outlook

- The aging tests of MSMGRPCs for the CBM-TOF inner zone performed using a high intensity ^{60}Co source evidenced an important gas pollution effect which could limit the lifetime of the counter.
- Proposed mitigation solutions has been MSMGRPCs with direct flow through the gaps and reduced number of the fishing line spacers in the active area. Gas flow rate studies showed a minimization of the aging effects (dark current and dark counting rate) with the increase of the gas flow, its suppression being observed at 6 l/h.
- Due to the still high dark counting rate localized in the close vicinity of the spacer, a new architecture of the counters is proposed. The fishing line spacers were replaced with discrete spacers which minimize the active area in contact with spacers.
- The X-ray aging investigations showed very promising results: dark current and dark counting rate are independent of gas flow and goes to negligible values in hours, even at gas flow rate of 0.5 l/h.
- X-ray irradiated counters maintain their performance in terms of time resolution and efficiency after exposure.
- Dedicated high counting rate tests in mCBM and MIP aging tests are required and they will follow.

Acknowledgements

IFIN-HH Bucharest

Hadron Physics Department

V. Aprodu

D. Bartos

A. Caragheorgheopol

D. Dorobantu

V. Duta

M. Petris

M. Petrovici

A. Radu

G. Stoian

GSI Darmstadt

Jochen Frühauf

Universität Heidelberg

Ingo Deppner

Norbert Herrmann

3rd International Conference on
**DETECTOR STABILITY AND
AGING PHENOMENA IN GASEOUS DETECTORS**

Thank you for your attention!



CERN, Geneva
6-10 November, 2023

