

EICUG 2023

Research and Development for an EIC 2nd Detector KLM

Simon Schneider
simon.schneider@duke.edu
Electron-Ion Collider User Group Meeting in Warszawa
2023-07-30

Duke
UNIVERSITY

Research supported by the



U.S. DEPARTMENT OF
ENERGY

Office of
Science

Overview

- What is a KLM type detector?
 - Showing the Belle II KLM as example
- Motivation for a KLM at the EIC
 - Showcases: some highlights from the physics program
- Current work
 - Simulation progress from Duke and University of South Carolina
- Further Research and Development Plans

Belle II at SuperKEKB

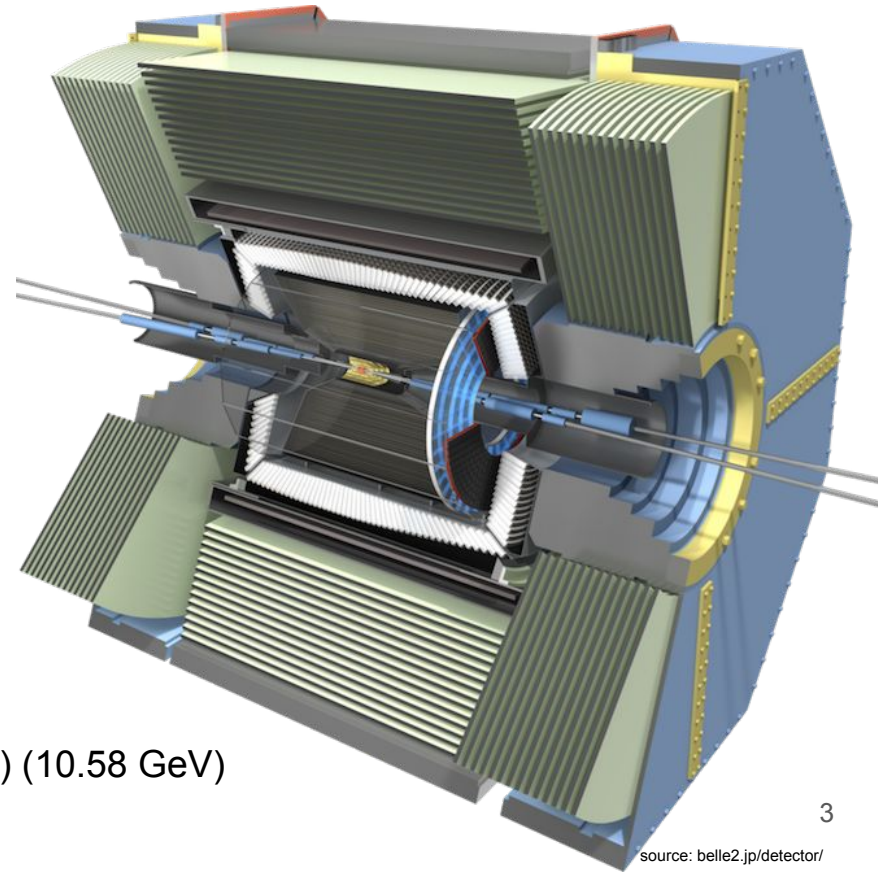
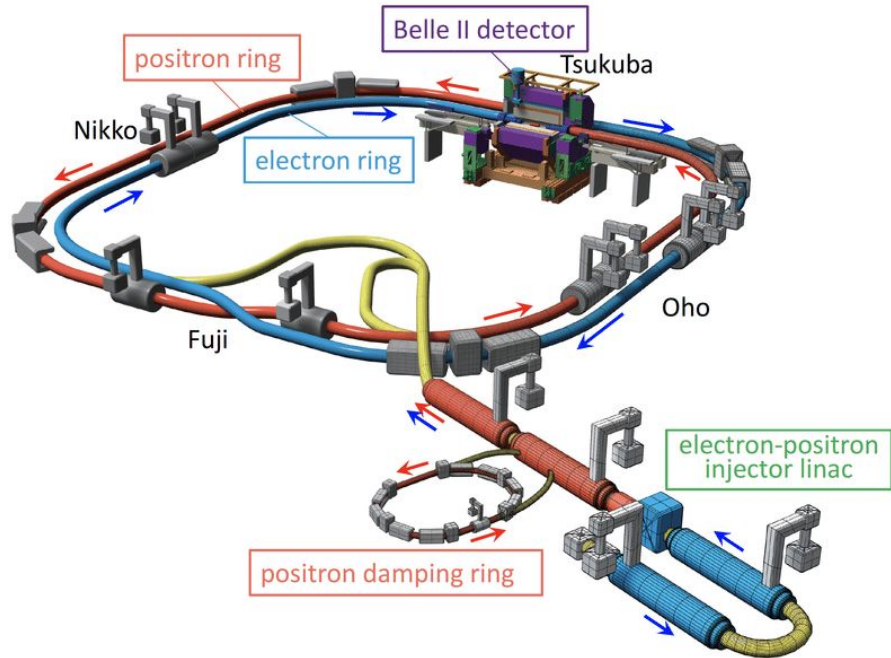

Asymmetric e^+e^- collider (4GeV x 7GeV) “B-factory” at Y(4S) (10.58 GeV)

Belle II KLM (K_L and muon detector)

Belle II KLM as current state-of-the-art

Task: pure and efficient K_L and μ ID

for muons > 0.6 GeV

$\sim 2^\circ$ angular resolution for K_L

Orthogonal scintillator/RPC layers embedded in
1.5T solenoid return steel

Relatively cost-effective and robust design

Ongoing optimization efforts as luminosity is
ramping up

Considerations for full scintillator upgrade

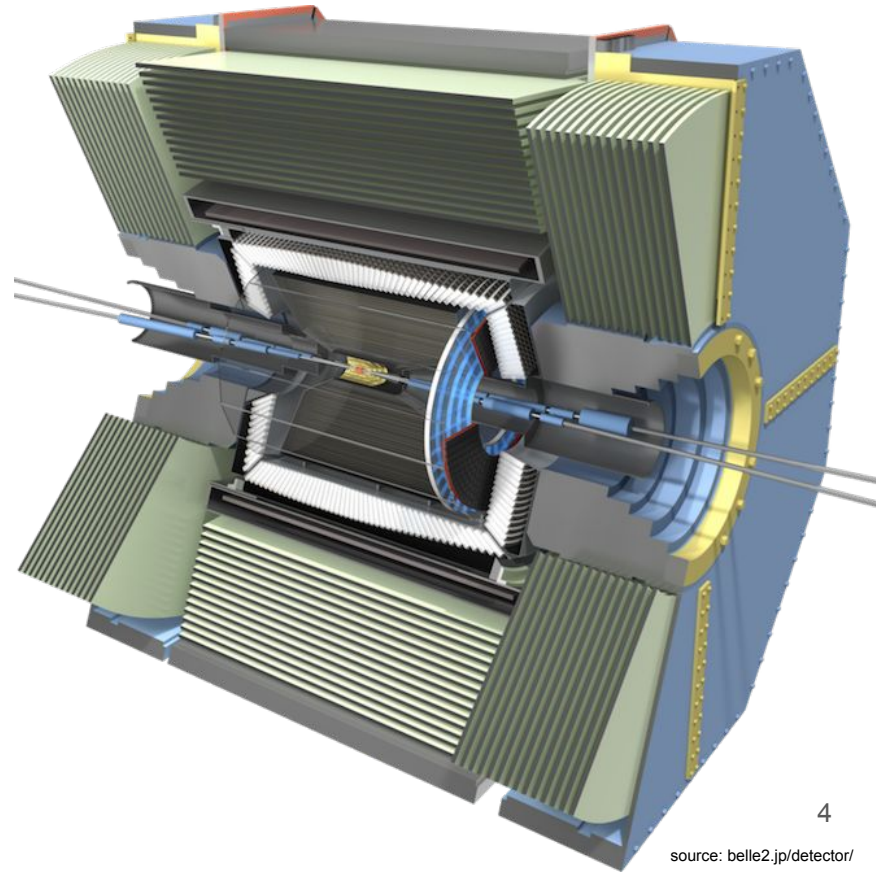

Belle II KLM (K_L and muon detector)

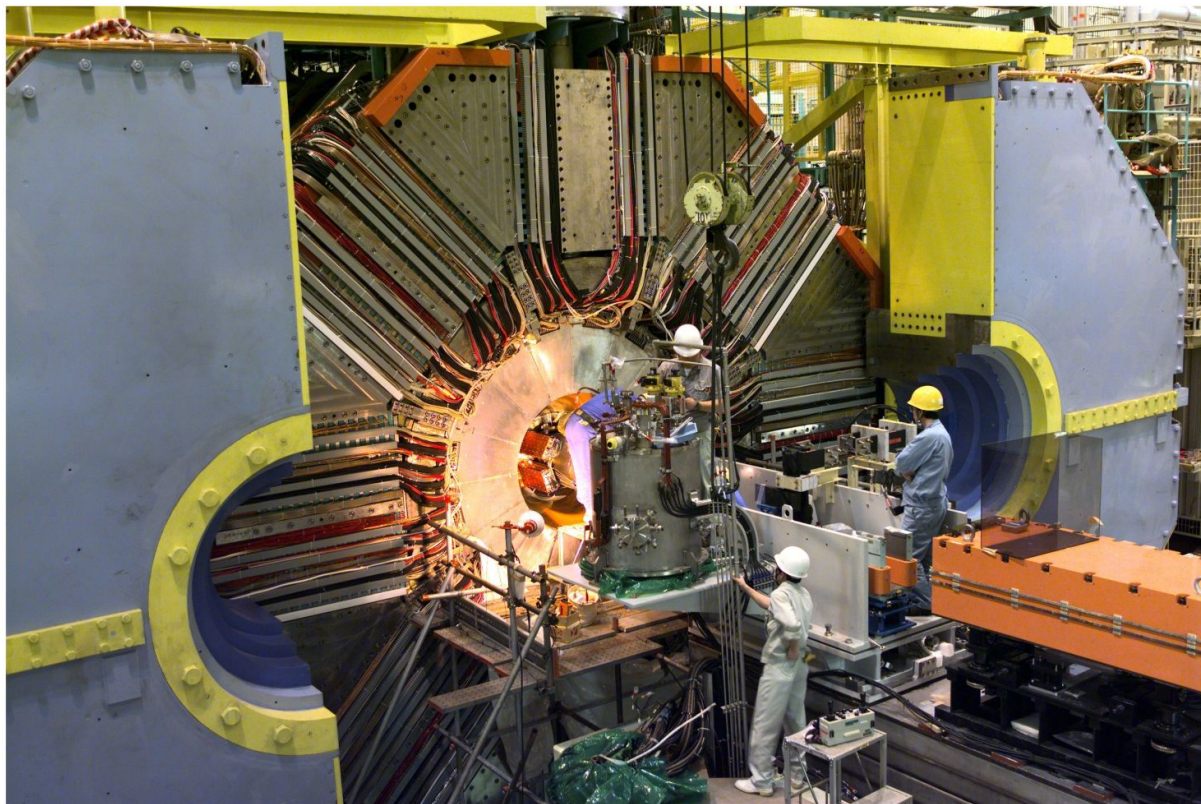

Belle II KLM (K_L and muon detector)

Detector setup and clean e⁺e⁻ environment allows very complete event reconstruction

Belle KLM had endcaps and inner two barrel layers upgraded from RPCs to scintillators for Belle II

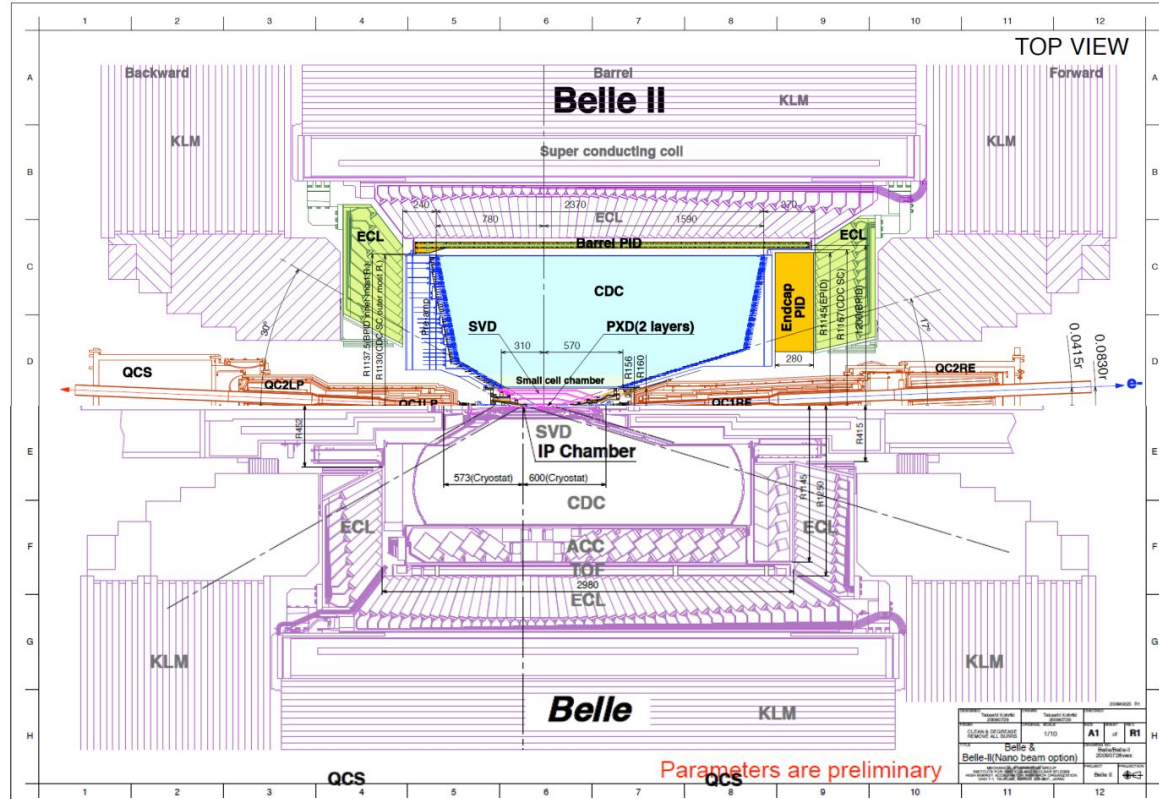

Belle II KLM (K_L and muon detector)

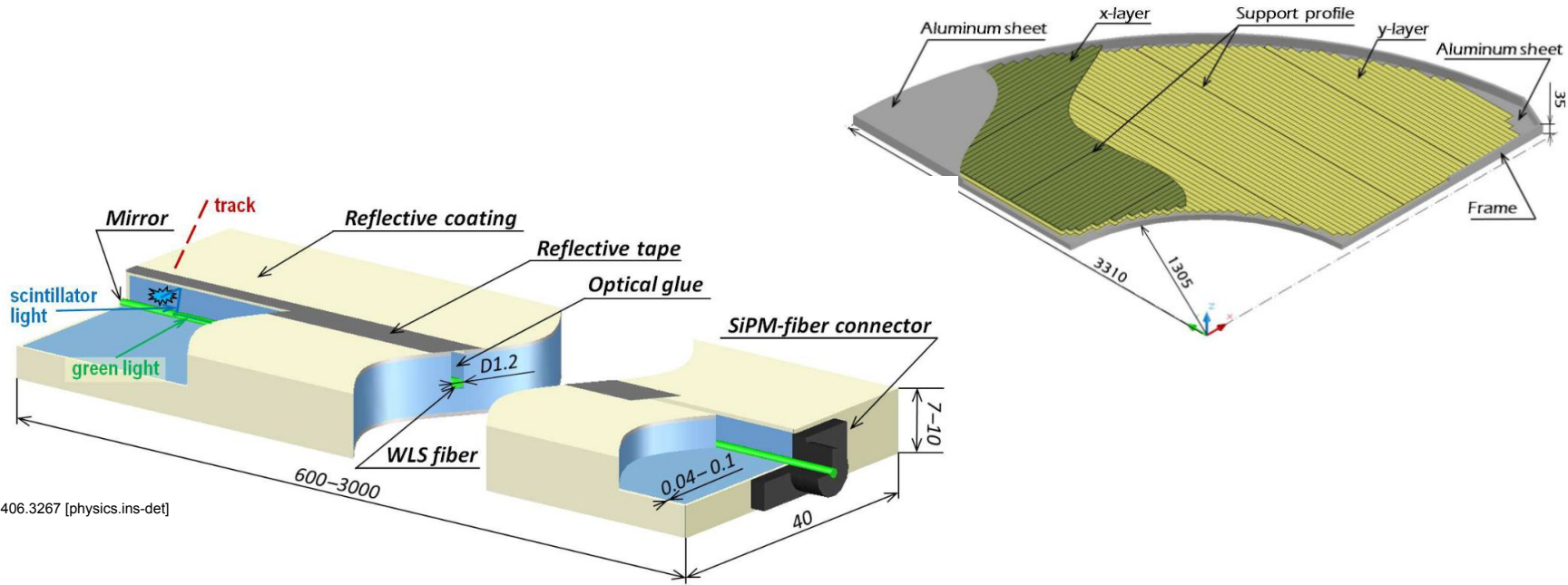

Schematic structure of the Belle II KLM scintillator setup

Belle II KLM (K_L and muon detector)

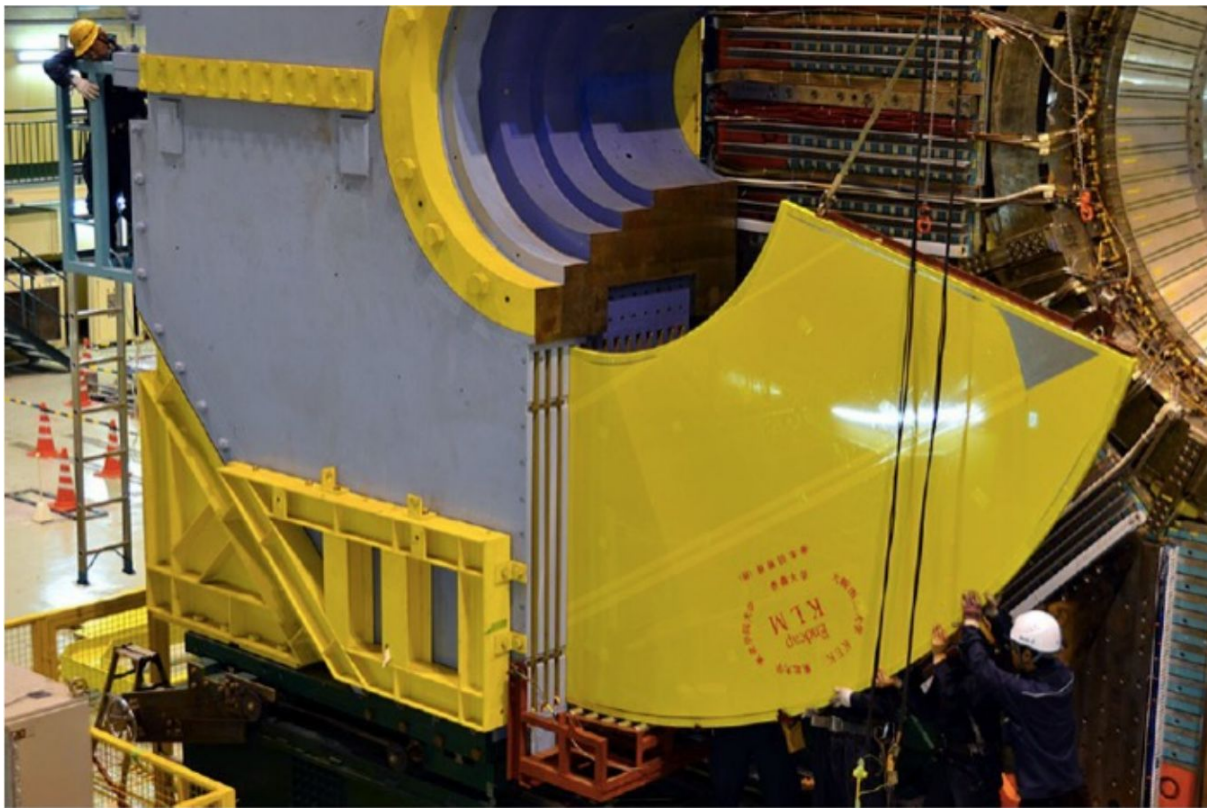

Belle II KLM (K_L and muon detector): performance

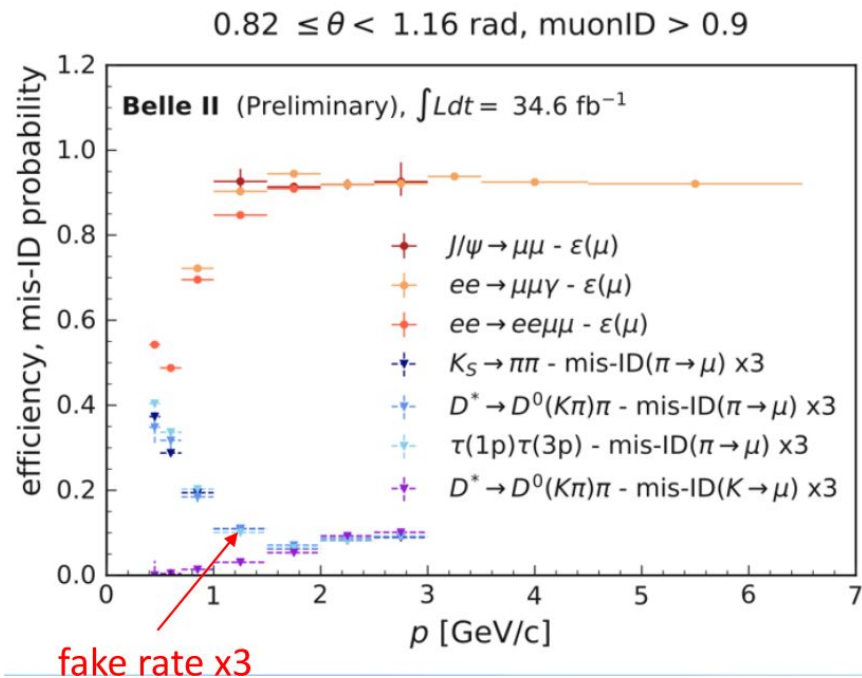

Motivations

- Importance of good muon ID at a 2nd EIC detector
 - C.f. physics talks in this and previous workshops
 - Adds to electron channels, quarkonium, etc.
 - Important for the physics case but could also give 2nd detector specific advantage over 1st
- The case for better neutral hadron detection
 - $\frac{1}{3}$ of jets expected to contain neutral hadrons
 - HCal capabilities
- A Belle II style KLM is able to address both needs within the constraints at IR8
 - Compact design integrated into magnet flux return
 - Combined muon and neutral hadron detection
 - Possibilities for additional time-of-flight information and HCal capabilities

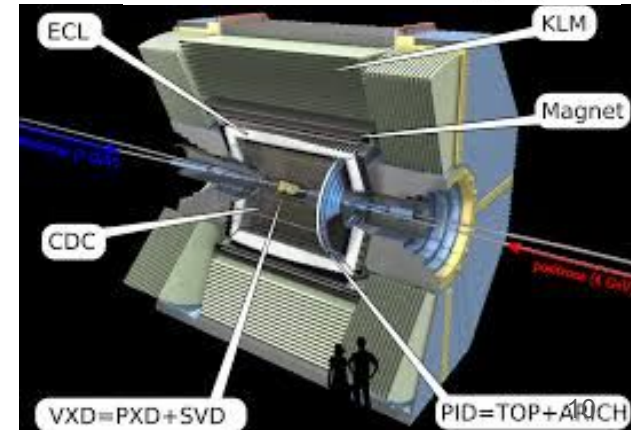
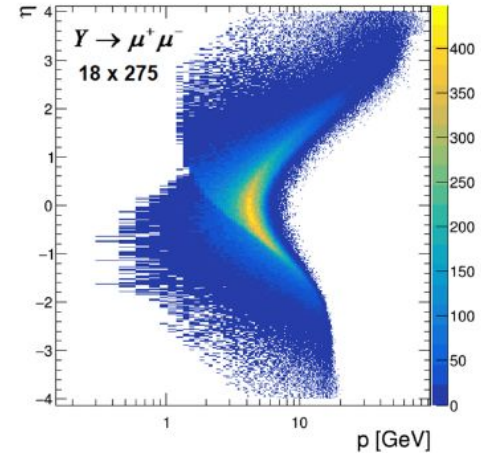

Examples from the last workshop at Temple University

Summary

Exclusive Dilepton Production (Jakub Wagner):

<https://indico.bnl.gov/event/18414/contributions/76070/>

- ▶ TCS is a mandatory complementary measurement to DVCS, cleanest way to test universality of GPDs. First measurement from CLAS12
- ▶ Timelike-spacelike relations at LO/NLO gives us tools to use TCS data in DVCS CFF fits, with special sensitivity to Q^2 dependence.
- ▶ First data-driven and model-free predictions for TCS using global DVCS data
- ▶ EIC – TCS study in Yellow Report, TCS included in EPIC event generator.
- ▶ Measurement of TCS should also make us more optimistic about the DDVCS, but **We need muon detection!**
- ▶ New analytical formulae for DDVCS have been derived.
- ▶ It is already implemented in PARTONS and EPIC MC generator (LO + LT).
- ▶ Asymmetries are large enough for DDVCS to be measurable at both current, JLab12, and future, JLab20+ and EIC, experiments.
- ▶ Addressing GPD model dependence with cross-sections and asymmetries is possible.

EICUG Steering Committee Perspective on Path Forward (Renee Fatemi):

<https://indico.bnl.gov/event/18414/contributions/76304/>

Unique opportunities for Det II @ IP8

- MAGNETIC FIELD** - Solenoid field up to 3T, allowing for high resolution momentum reconstruction for charged particles.
- EXTENDED COVERAGE** for precision electromagnetic calorimetry - important for DVCS on nuclei
- MUONS** – enhanced muon ID in backward and barrel region.
- BACKWARD HADRONIC CALO** - Low-x physics, reconstruction of current jets in the approach to saturation
- SECONDARY FOCUS** - tagging for nearly all ion fragments and extended acceptance for low pT/ low x protons. Enables detection of short-lived rare isotopes.

EIC 2nd Detector: Vision and Realization (Abhay Deshpande)

<https://indico.bnl.gov/event/18414/contributions/76302/>

Potential Physics topics beyond Core EPIC detector's mandate exist

Focus first on Physics beyond the EIC's core (CD0) science (there will be others: some overlapping, some exclusive due to different IR design)

Physics with nucleons and nuclear targets:

- Quark **Exotica**: 4,5,6 quark systems...? Much interest after recent **LHCb** led results.
- **Nuclear Fragments** from light and heavy nuclei - e-A – Connecting to low energy nuclear physics (exotic nuclei), studying the shapes of nuclei and their internal substructure; entanglement, entropy, fragmentation, hadronization and such phenomena

New Studies with proton or neutron target: (mostly overlapping?)

- Impact of precision measurements of unpolarized PDFs at high x/Q^2 , on LHC-Upgrade results(?)
- Precision calculation of α_s : higher order pQCD calculations, twist 3
- Heavy quark and quarkonia (c, b quarks) studies with 1000 times lumi of HERA (and polarization)

Precision electroweak and BSM physics:

- Electroweak physics & searches beyond the SM: Parity, charge symmetry, lepton flavor violation
- LHC-EIC Synergies & complementarity: (**muon detectors were of particular interest**)

DDVCS: Double deeply virtual Compton scattering

“Provides the framework necessary for an uncorrelated measurement of a GPD (ξ' , ξ , t) as a function of both scaling variable ξ' and ξ ”

“Challenging from the experimental point of view due to the small magnitude of the cross section and requires high luminosity and full exclusivity of the final state”

-> Requires clean reconstruction of muon pairs

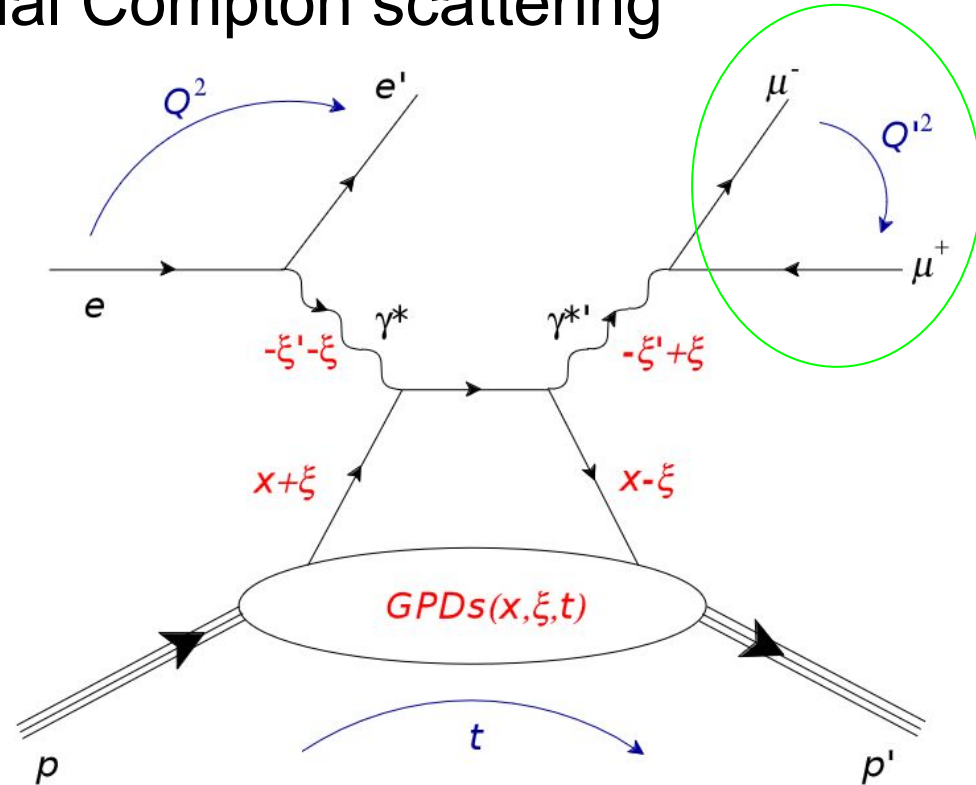

TCS: Timelike Compton Scattering

See the next talk by Pierre Chatagnon for more on TCS!

From the Yellow Report (sec. 8.4.4):

“TCS has a final state identical to the exclusive production of J/ψ , but without the advantage of a well-defined invariant mass for the lepton pair.”

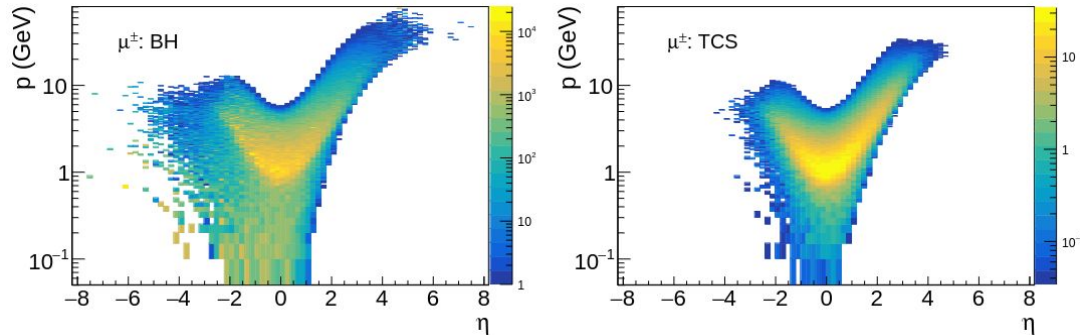

Figure 8.69: Momentum vs pseudorapidity for e^+e^- (top) and $\mu^+\mu^-$ (bottom) at the 5×41 GeV collision energy, for an integrated luminosity of 10 fb^{-1} . Left: BH, right: TCS.

Motivation for K_L and n detection

- Roughly $\frac{1}{3}$ of EIC jets are expected to contain neutral hadrons
 - Many parts of the EIC physics program depend on good jet measurements
 - Much cleaner jet reconstruction if neutrals can be reconstructed or veto jets
 - R&D into HCAL capabilities of a KLM-type detector

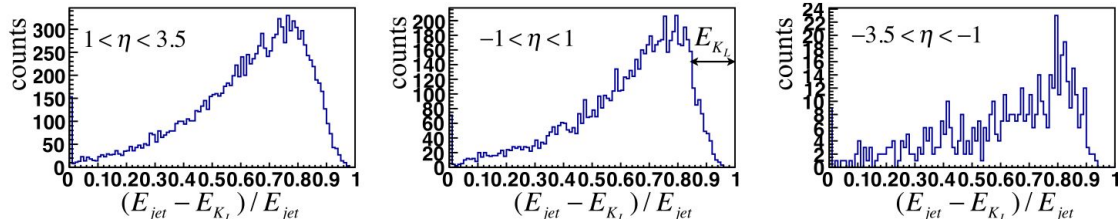

FIG. 8. Energy fraction of the total jet energy excluding the energy carried by K_L in the jet. The left, middle, and right distributions show the pseudorapidity of the jet in the hadron endcap, barrel, and electron endcap, respectively. The beam energy configuration is 10GeVx275GeV.

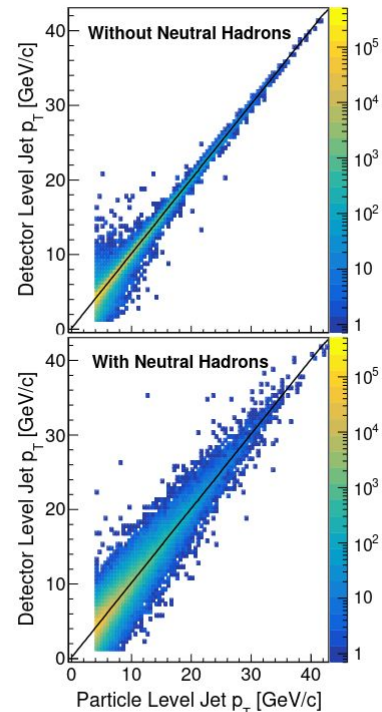
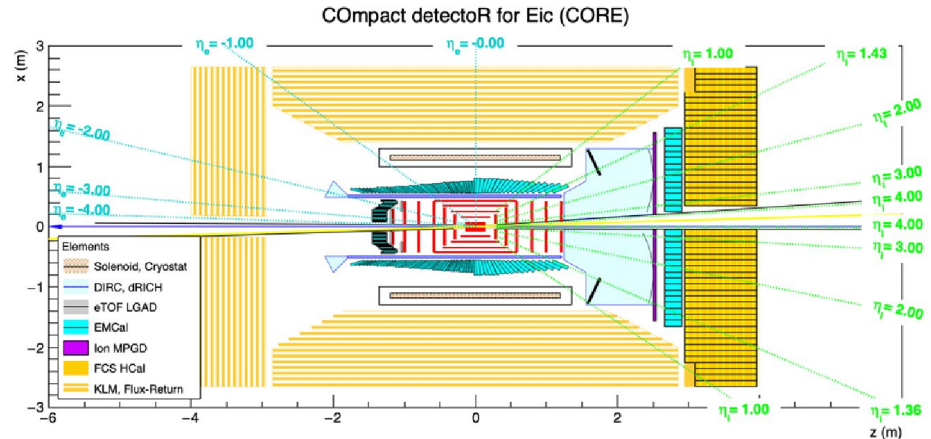
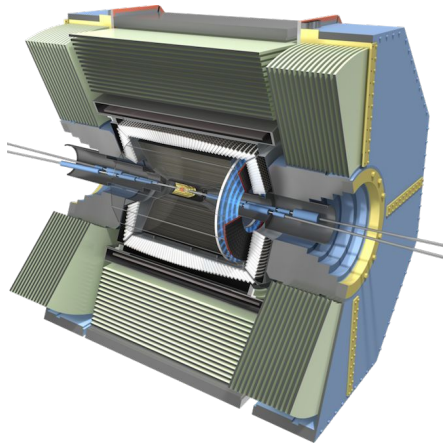

FIG. 20. [color online] Relationship between particle level and smeared jet transverse momenta for jets which do not (upper panel) and do (lower panel) contain neutral hadrons.

source: B.S. Page et al., arXiv.1911.00657 "Jet Physics at a Future EIC"

Research and Development Program

- State-of-the-art and not-yet used potentials at Belle II inspired barrel + e-endcap in EIC EOI #26
- This was incorporated into the EIC CORE proposal
- These efforts can now be applied in 2nd detector development
- EIC KLM R&D proposal initially funded by EIC Generic R&D program for further development of the KLM concept and optimization for the EIC



Research and Development Program

- Direct readout to replace WLS fiber
 - Belle II focus was position -> study response and use for energy measurement
- Improved timing
 - Timing on order of 10s of ps opens possibilities
 - Neutral hadron momentum through time-of-flight infor
 - Hit localization within the scintillator
 - Simplified layer structure
 - Simpler, more compact design
- Thin HCal capabilities
- Integration into magnet flux return

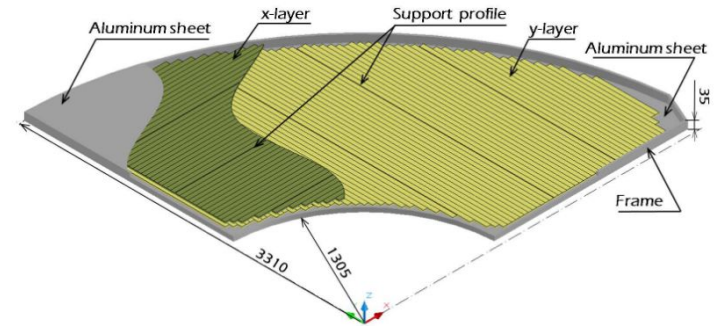
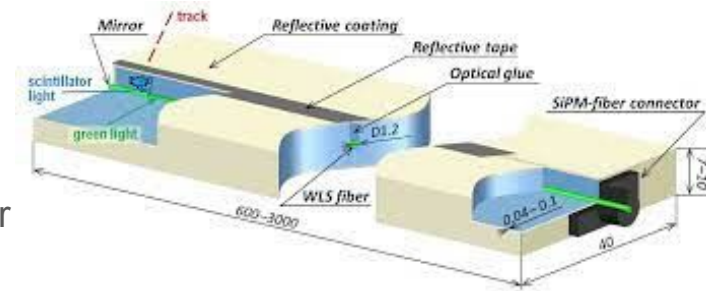

Current work at Duke University

- Implemented simplified barrel KLM in DD4hep framework used by project detector
- Allows easy use of ePIC software developments
- Access to ePIC subdetector simulations
- Flexible simulation to allow for geometry optimization based on simulated performance

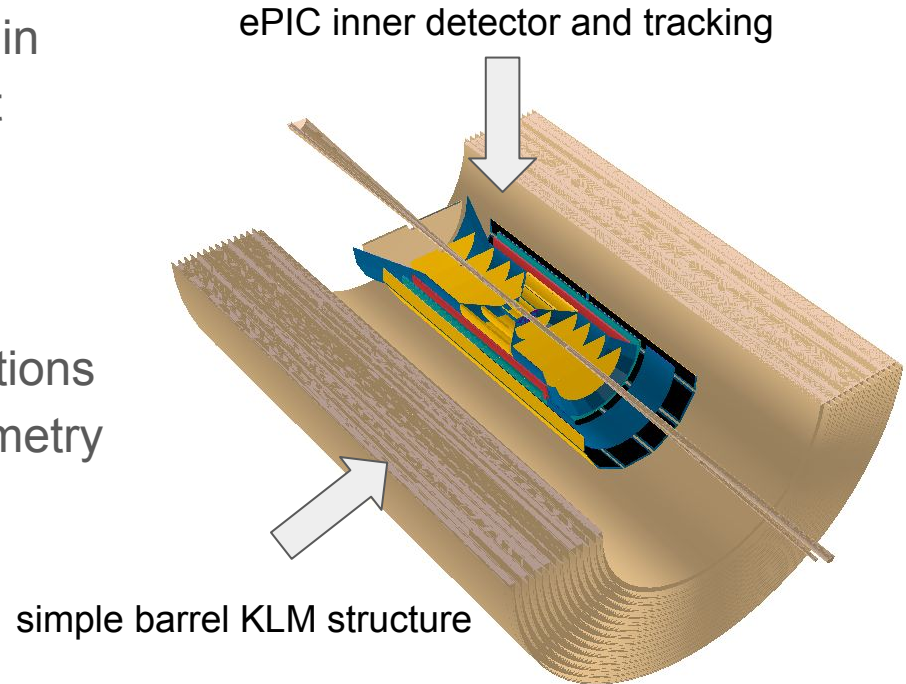

Current work at Duke University

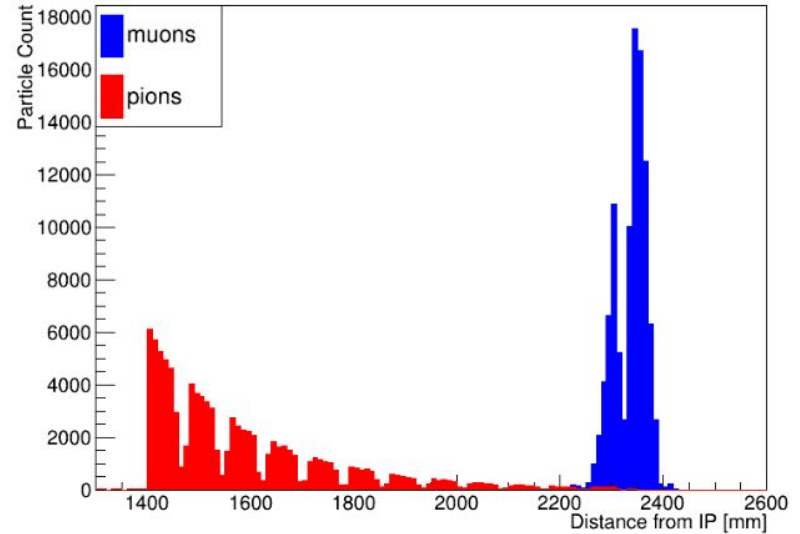
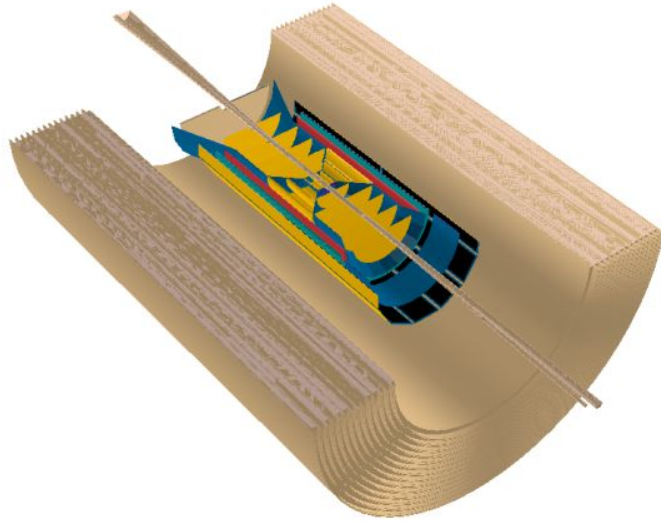

FIG. 1. Implementation of the 14 layer KLM in DD4hep with vertexing and tracking systems adapted from ePIC (left). Penetration depths of pions (red) and muons at 1 GeV. They can be clearly separated.

Current work at University of South Carolina

- Continuing development in Fun4All to use existing CORE simulation
 - Advantage of existing magnet design
- Determined muon momentum thresholds to reach KLM for range of pseudo-rapidities and magnetic field strengths

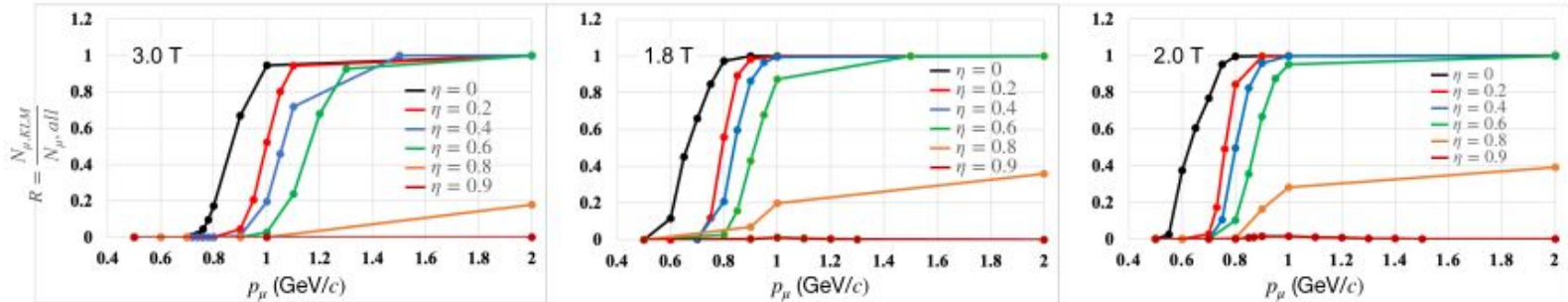

FIG. 2. Ratios of the number of muons reaching the barrel KLM to the number of muons generated at the center of CORE, for various values of central magnetic field and pseudo-rapidity.

Current work at University of South Carolina

- Continuing development in Fun4All to use existing CORE simulation
 - Advantage of existing magnet design
- Determined muon momentum thresholds to reach KLM for range of pseudo-rapidities and magnetic field strengths

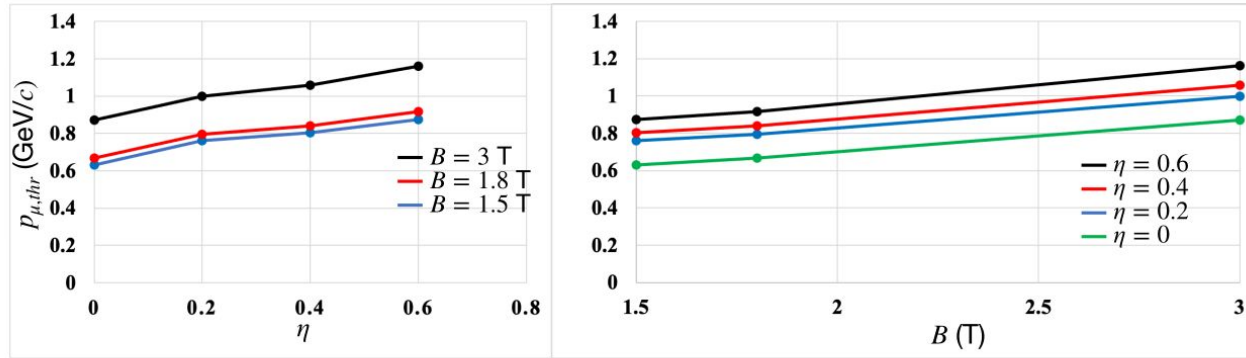
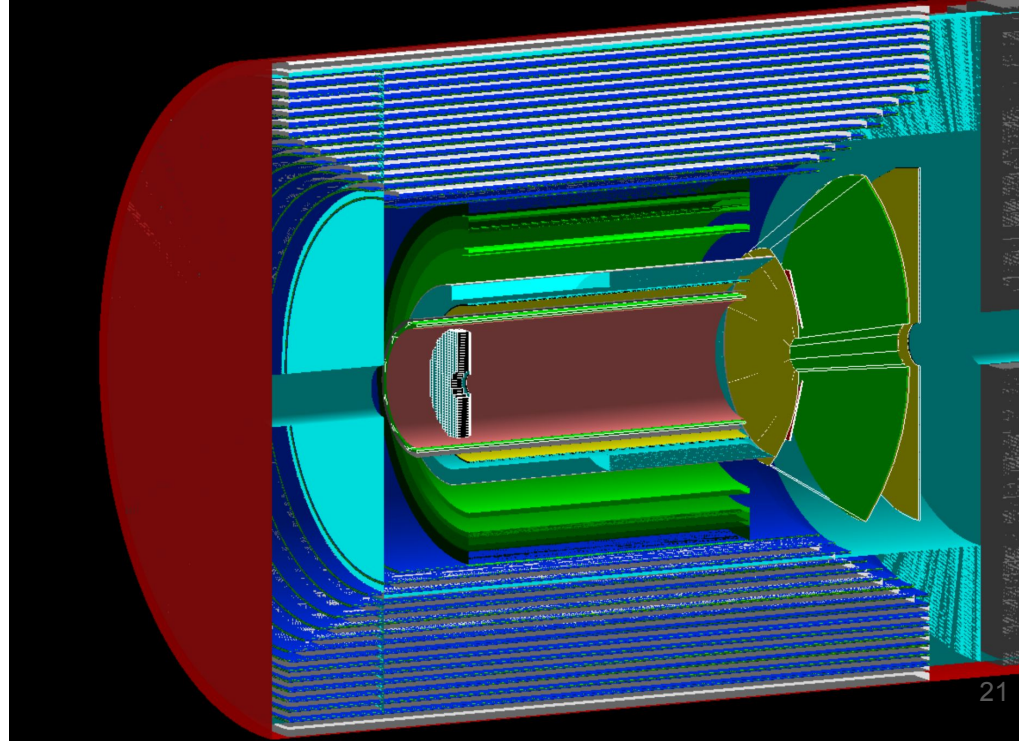

FIG. 3. Muon thresholds as a function of η for various B (left) and as a function of B for several η (right). The value of $p_{\mu,thr}$ is the muon momentum at which 50% reach the barrel KLM.

Current work at University of South Carolina

- Implemented layered KLM structure in the CORE Fun4All framework
- Started to work on hit readout simulation



Further R&D goals

- Feasibility of integration in an EIC central magnet
- Characterization of neutral hadron response
 - Belle II KLM R&D was focused only on K_L position
 - -> Study hadronic response, benchmark against thin HCALs
- Improved timing for ToF, hadronic momentum determination, hit localisation
 - Current state WLS fibers don't use potential time resolution of organic scintillators down to 10s of ps
 - R&D need for scintillators, readout geometry and electronics!
- Suitability as a thin HCAL
 - need for new algorithm development
- Development of improved reconstruction algorithms

Scintillator timing

- Scintillator timing resolution
 - Current state (Belle II) WLS fibers don't use potential time resolution of organic scintillators down to 10s of ps.
 - First tests of direct SiPM to Scintillator coupling and direct photon detection show timing resolutions down to ~50ps with standard leading-edge discrimination and post-processing
 - Initial bench tests with EJ-2xx series, possibly others in coming years
- Electronics
 - Uncertain when HDSoc readout boards will be available for new pulse shape discrimination
 - Using custom adaptation of HELIX readout system for first test setups
- Could achieve ~10% momentum resolution via ToF for 1.2 GeV KL at 1.4m radius with 60 ps time resolution, 50% at 1.8 GeV
- Timing resolution and double sided readout could allow few cm localization along the scintillator -> possibly fewer layers, compact design

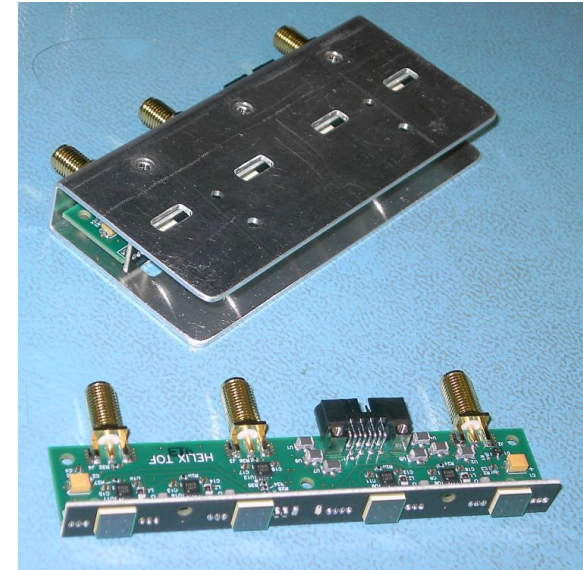

Summary

- Adding muon detection to an EIC 2nd detector can extend the physics reach of the EIC and has been identified as of high interest
- The KLM concept of scintillator-strips within the solenoid return steel can provide cost-effective clean muon ID in a compact design
- Neutral hadron (K_L and neutron) ID can be optimized together with muon ID
- R&D can determine double use as thin HCAL and ToF capabilities beyond Belle II state-of-the-art
- Investigations of these capabilities matched to the needs of the EIC physics program to provide a cost-effective generic baseline detector design guide
- Let us know if you have thoughts, suggestions or want to get involved!

References

Previous Talks:

- 1st International Workshop on a Second Detector for the EIC (Temple U):
<https://indico.bnl.gov/event/18414/contributions/76449/> (flash talk)
- EICUG 2nd Detector Meeting (CFNS)
<https://indico.bnl.gov/event/17693/contributions/70916/> (talk by Will Jacobs)

R&D proposals:

- Continuation of EIC KLM R&D Proposal (2023 update):
https://www.jlab.org/research/eic_rd_prm/receivedproposals
- EIC KLM R&D Proposal (2022):
https://www.jlab.org/research/eic_rd_prm/receivedproposals

Other Papers and Documents:

- A. Abashian et al. (Belle), “The K(L) / mu detector subsystem for the BELLE experiment at the KEK B factory,” Nucl. Instrum. Meth. A 449, 112–124 (2000).
- T. Aushev et al., “A scintillator based endcap KL and muon detector for the Belle II experiment,” Nucl. Instrum. Meth. A 789, 134–142 (2015), arXiv:1406.3267 [physics.ins-det].