

Intégration Galerie 825

Intégration Galerie 825

Les modèles intégration de la galerie 825 découpé en 4 parties ~300m:

- ST1608334 Intégration 825 Partie1 4180 ← Zone Est
- ST1608351 Intégration 825 Partie2 4180
- ST1608355 Intégration 825 Partie3 4180
- ST1608360 Intégration 825 Partie4 4180 ← Zone Ouest

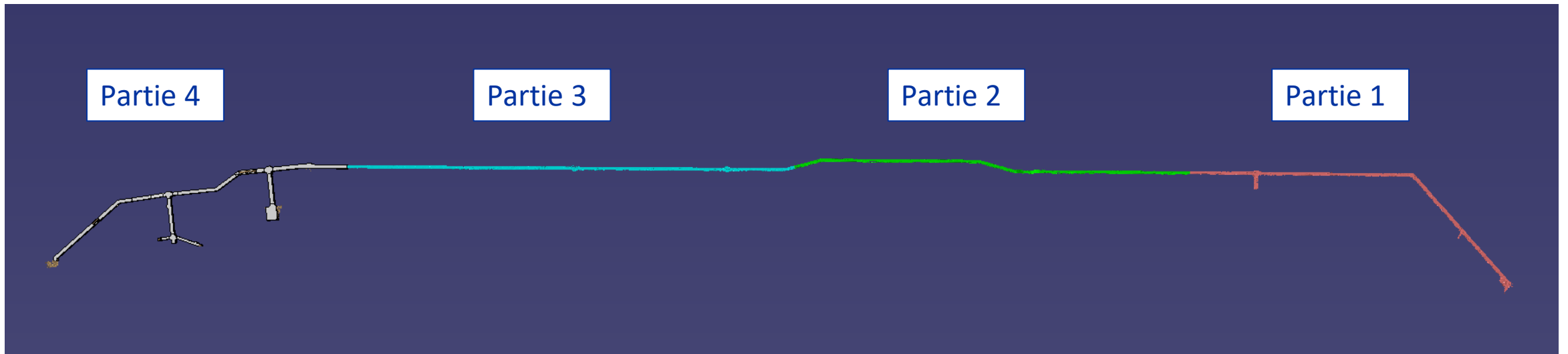
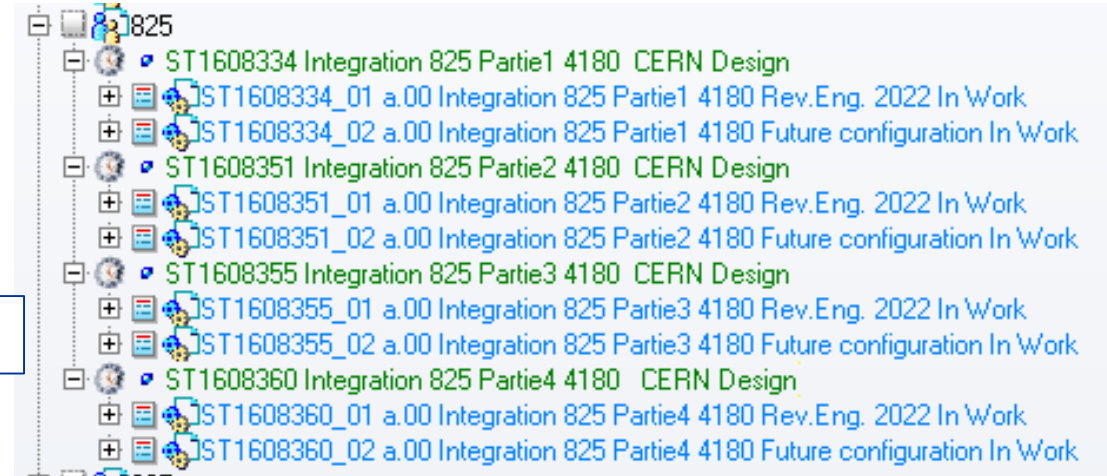

Intégration Galerie 825

zone ouest (Partie 4) :

- ST1608360 Integration 825 Partie4 4180 ← Zone Ouest

Priorités		Galerie	Numéro ST ASS GENERALE INT	Etat d'avancement par service					
				Scan survey	Maillage catia intégration	Génie civil	EL	CV	Tertiaire
2	825 Partie 4	Reverse	ST1608360_01	Finalisé	Finalisé	Finalisé	En cours	En cours	En cours
		Future	ST1608360_02	Finalisé	Finalisé	Finalisé	En cours	En cours	En cours

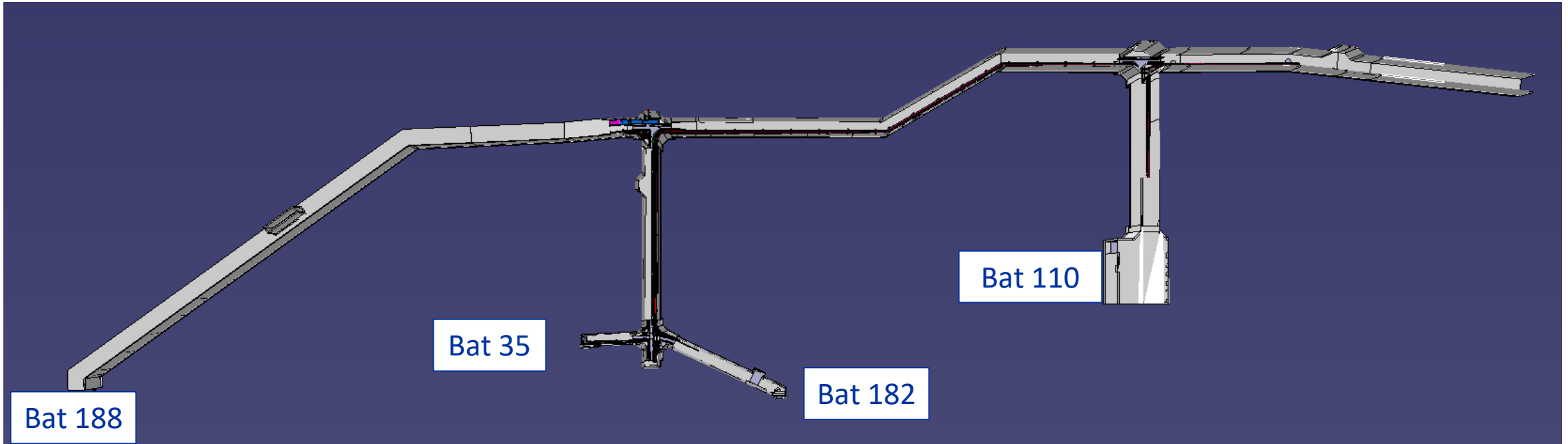

Intégration Galerie 825

zone ouest (Partie 4)

Livrable des modèles 3D:

GT825 (b.35-b.188):

- 3D proposal: 26/1/23
- 3D validation confirmed: 2/2/23

GT825 (b.35-b.110):

- 3D proposal: 16/2/23
- 3D validation confirmed: 2/3/23

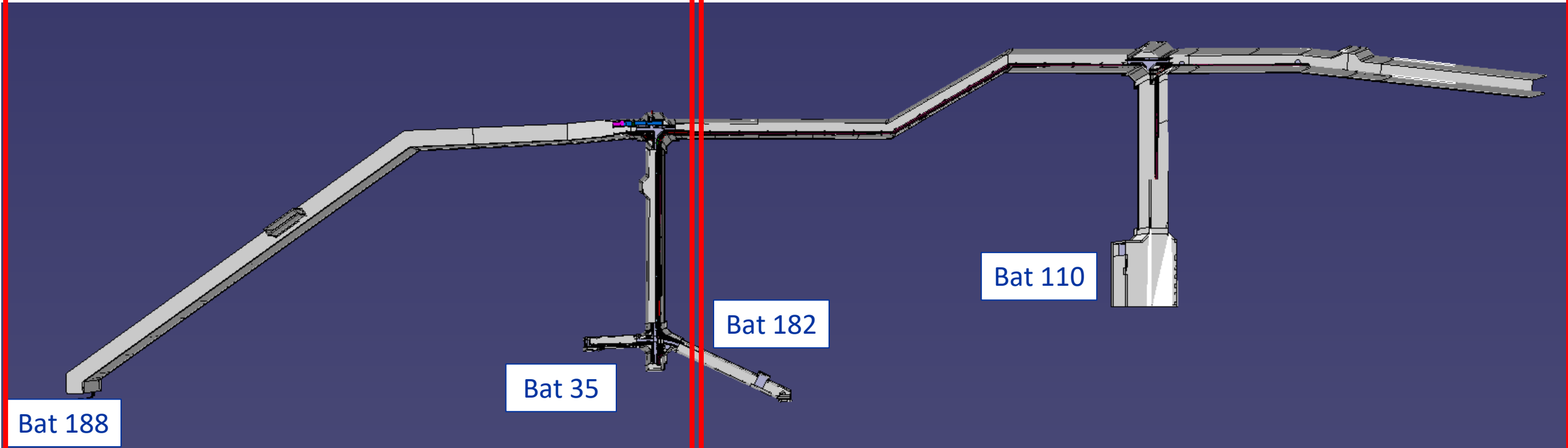

Intégration Galerie 825

zone ouest (Partie 4) **Reverse Eng** en cours:

Jonction 825/b.188 Dcum A-1190

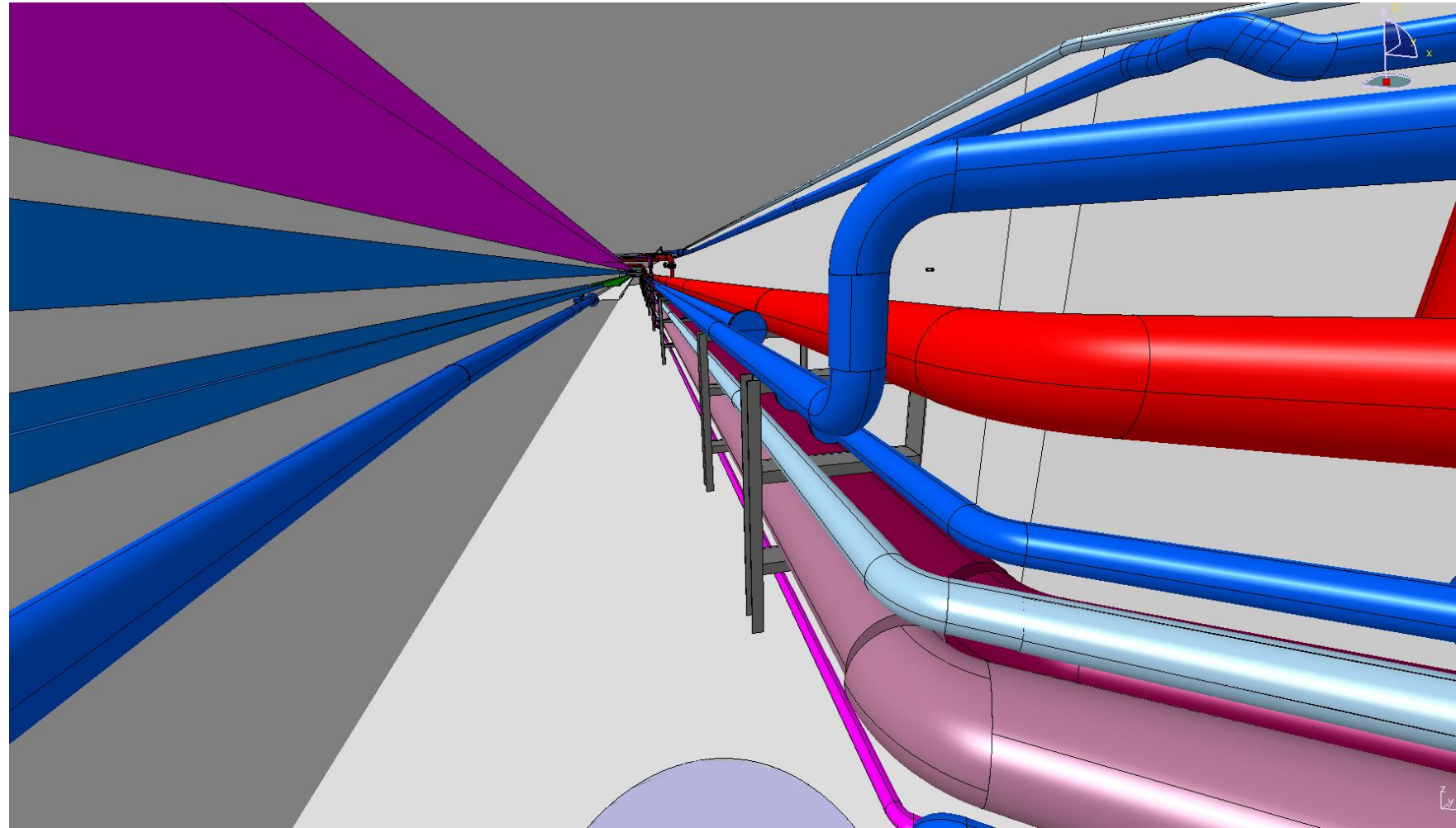

Intégration Galerie 825

zone ouest (Partie 4) **Reverse Eng** en cours:

Jonction 825/Dcum A-1090

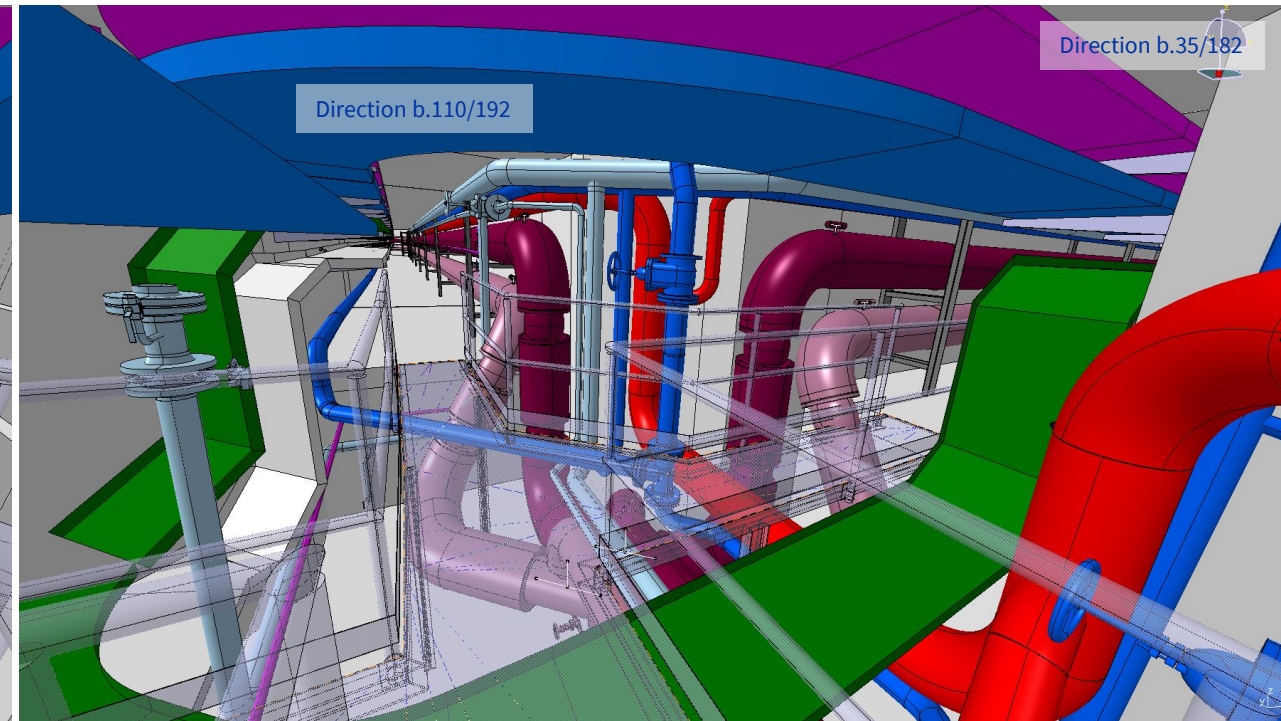
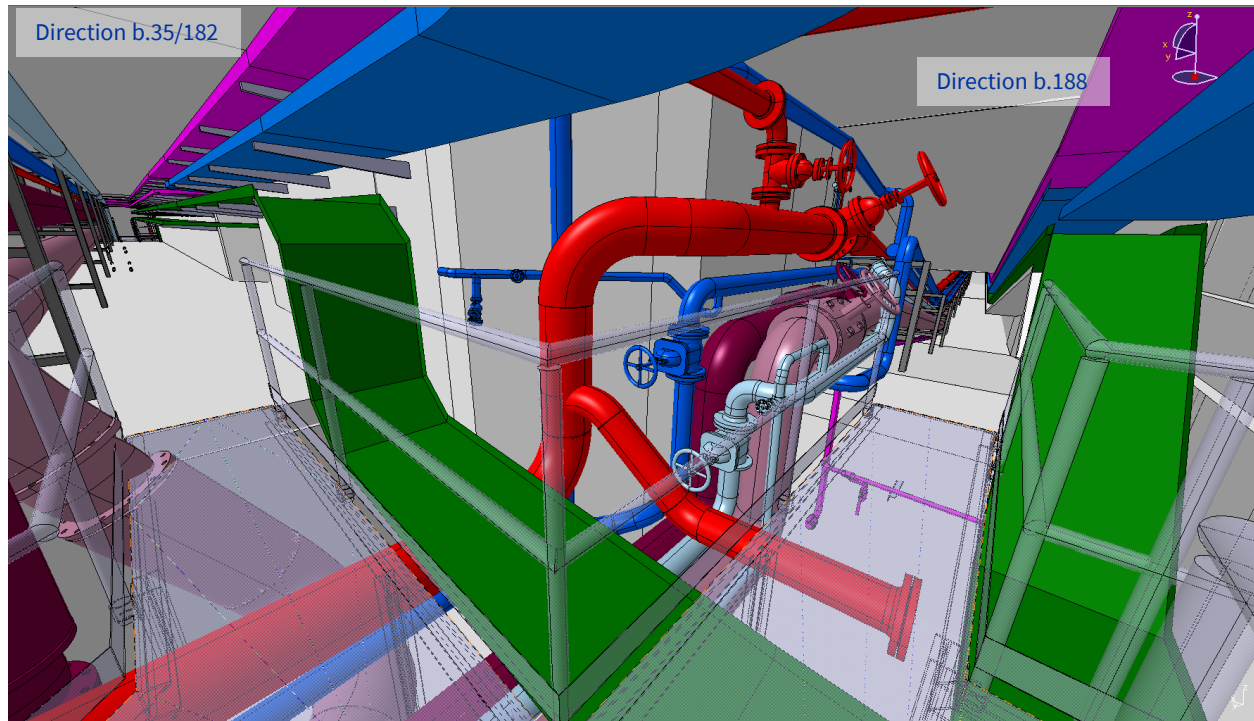
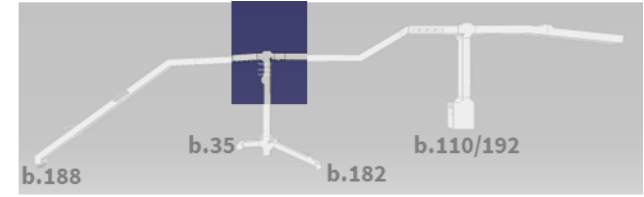

Intégration Galerie 825

zone ouest (Partie 4) **Reverse Eng** en cours:

Jonction 825/Dcum A-1090

- Tuyauterie SCE?

Rappel

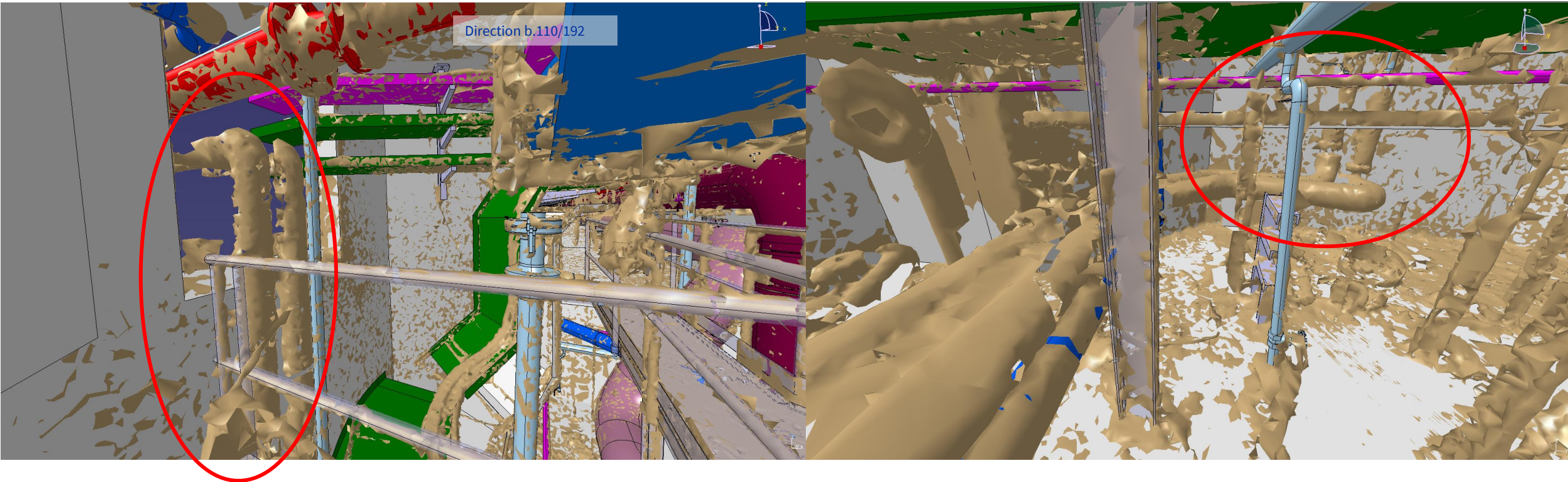
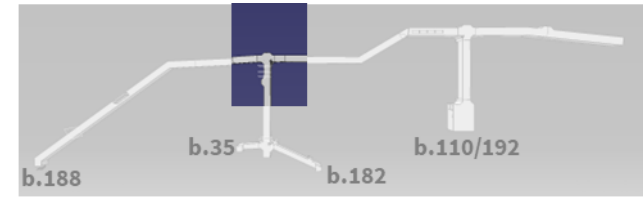

Intégration Galerie 825

zone ouest (Partie 4) **Reverse Eng** en cours:

Jonction 825 Dcum D-0030

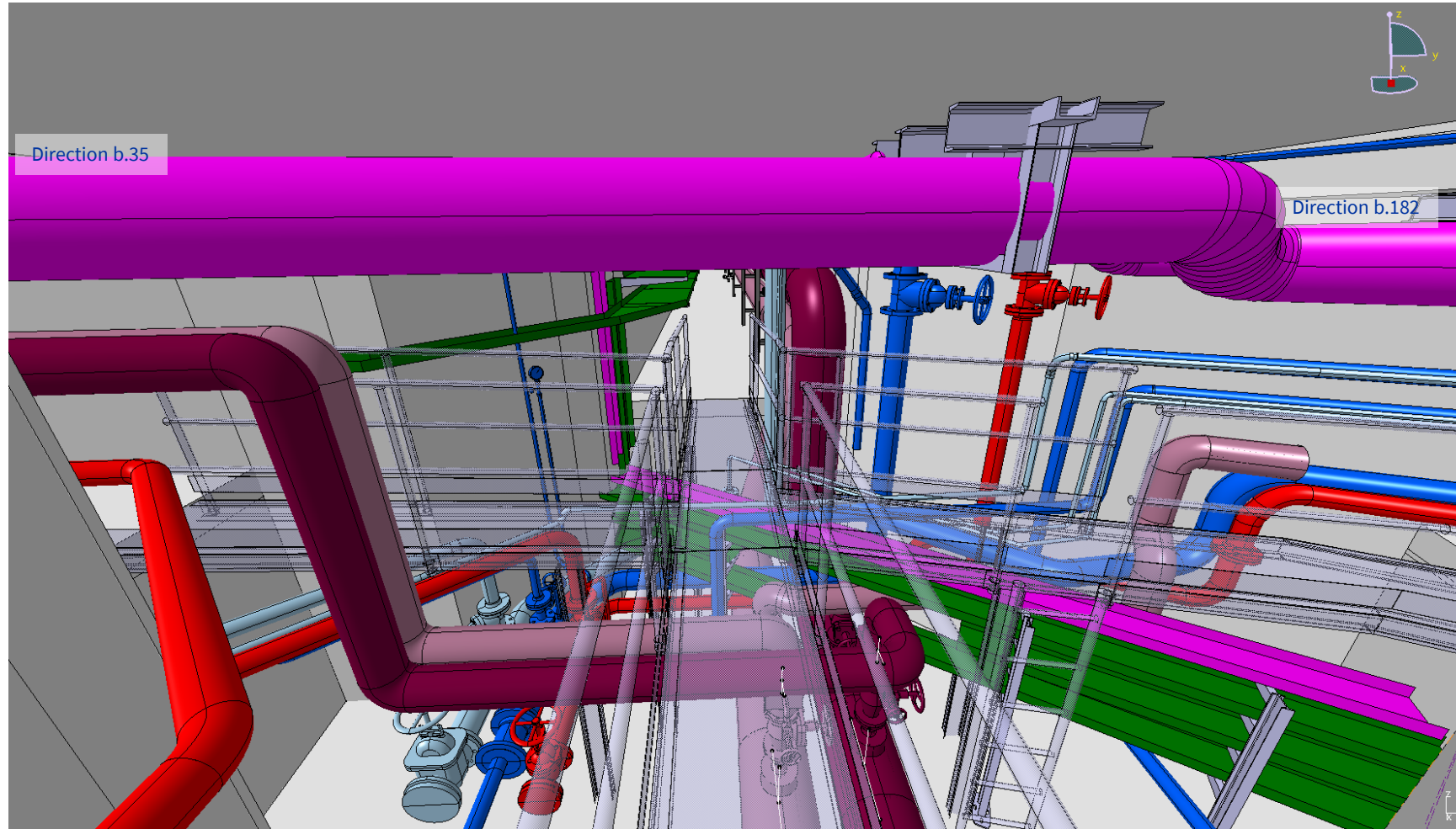
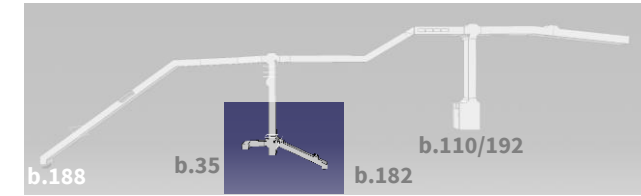

Intégration Galerie 825

zone ouest (Partie 4) **Reverse Eng en cours:**

Jonction 825 Dcum D-0030

- Tuyauterie SCE

Rappel

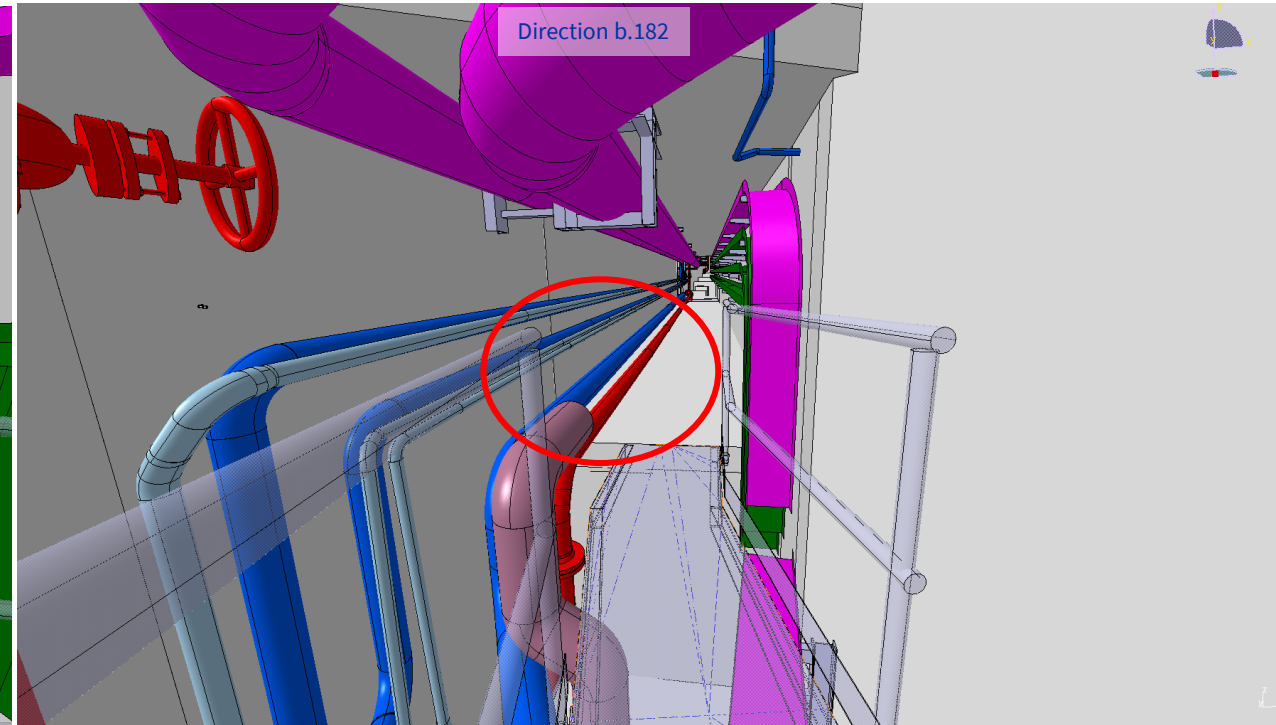
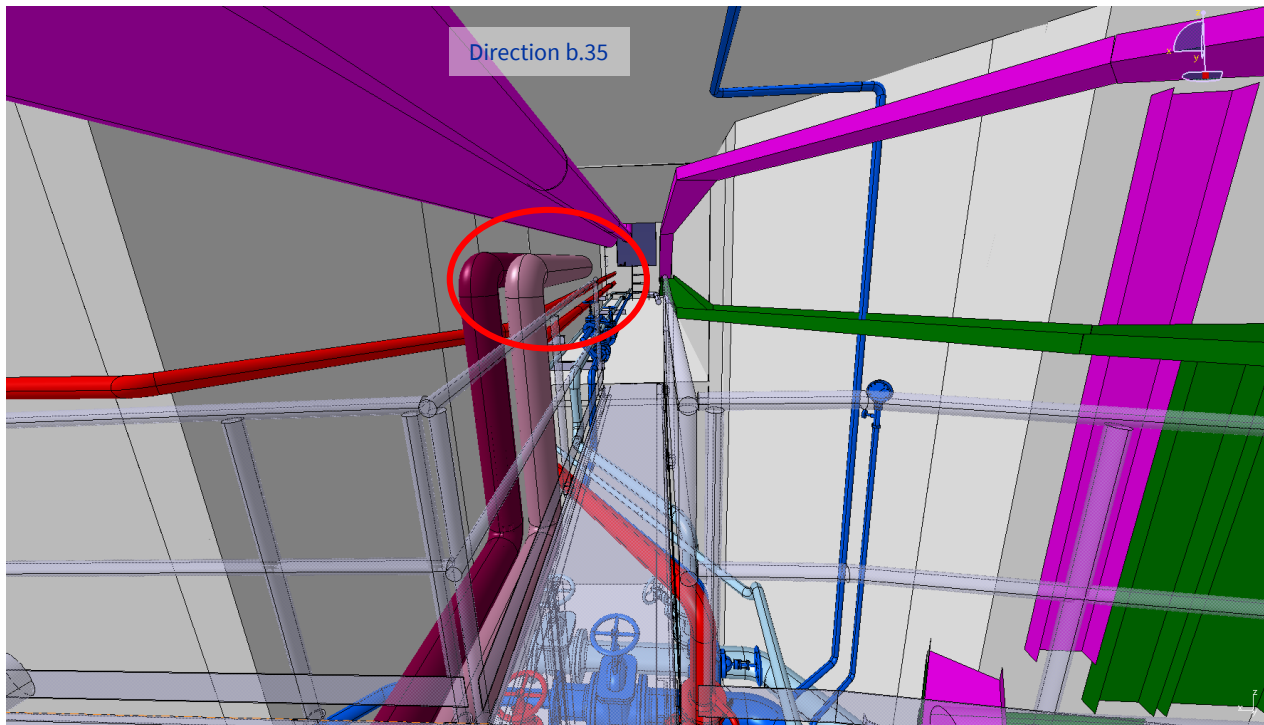
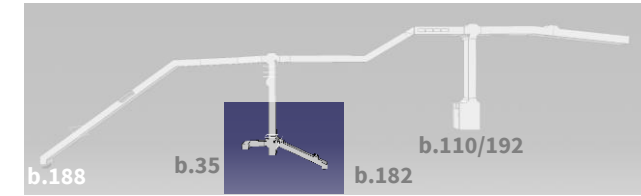

Intégration Galerie 825

zone ouest (Partie 4) **Reverse Eng** en cours:

- Jonction 825/Dcum A-1010:

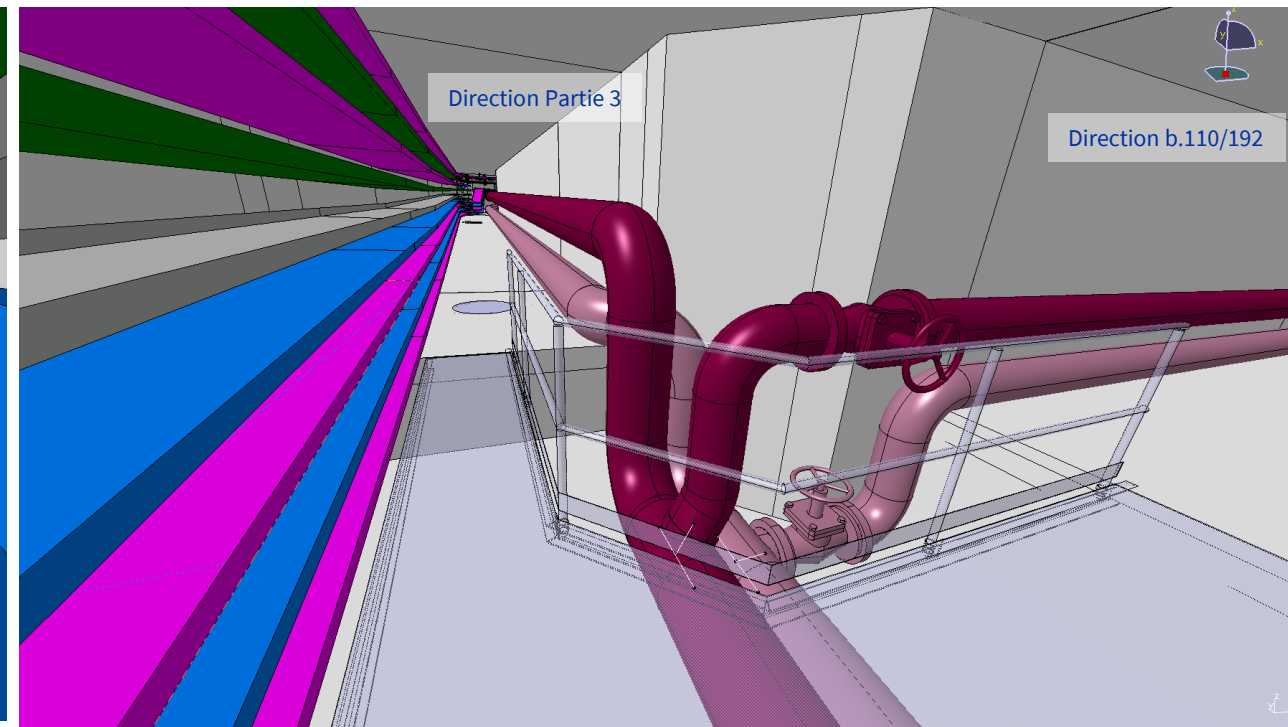
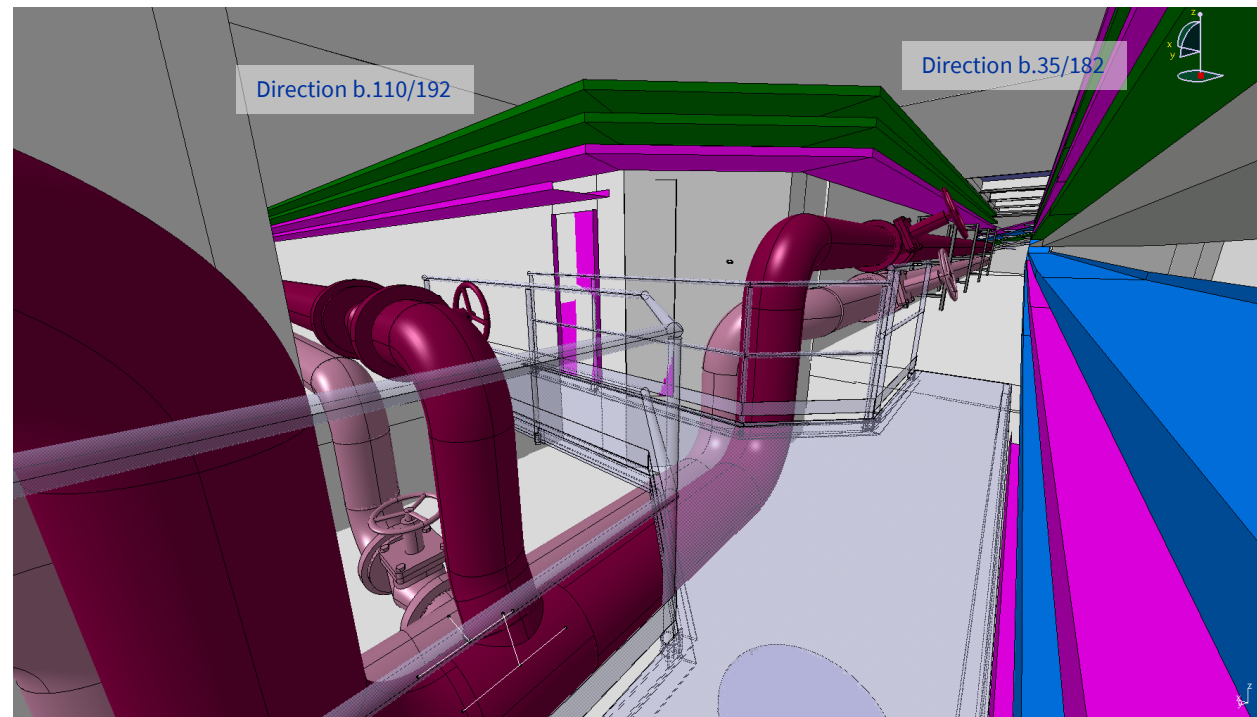
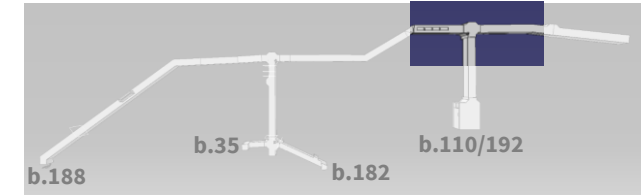

Intégration Galerie 825

zone ouest (Partie 4) **Future Configuration en cours:**

Jonction 825/b.188 Dcum A-1190

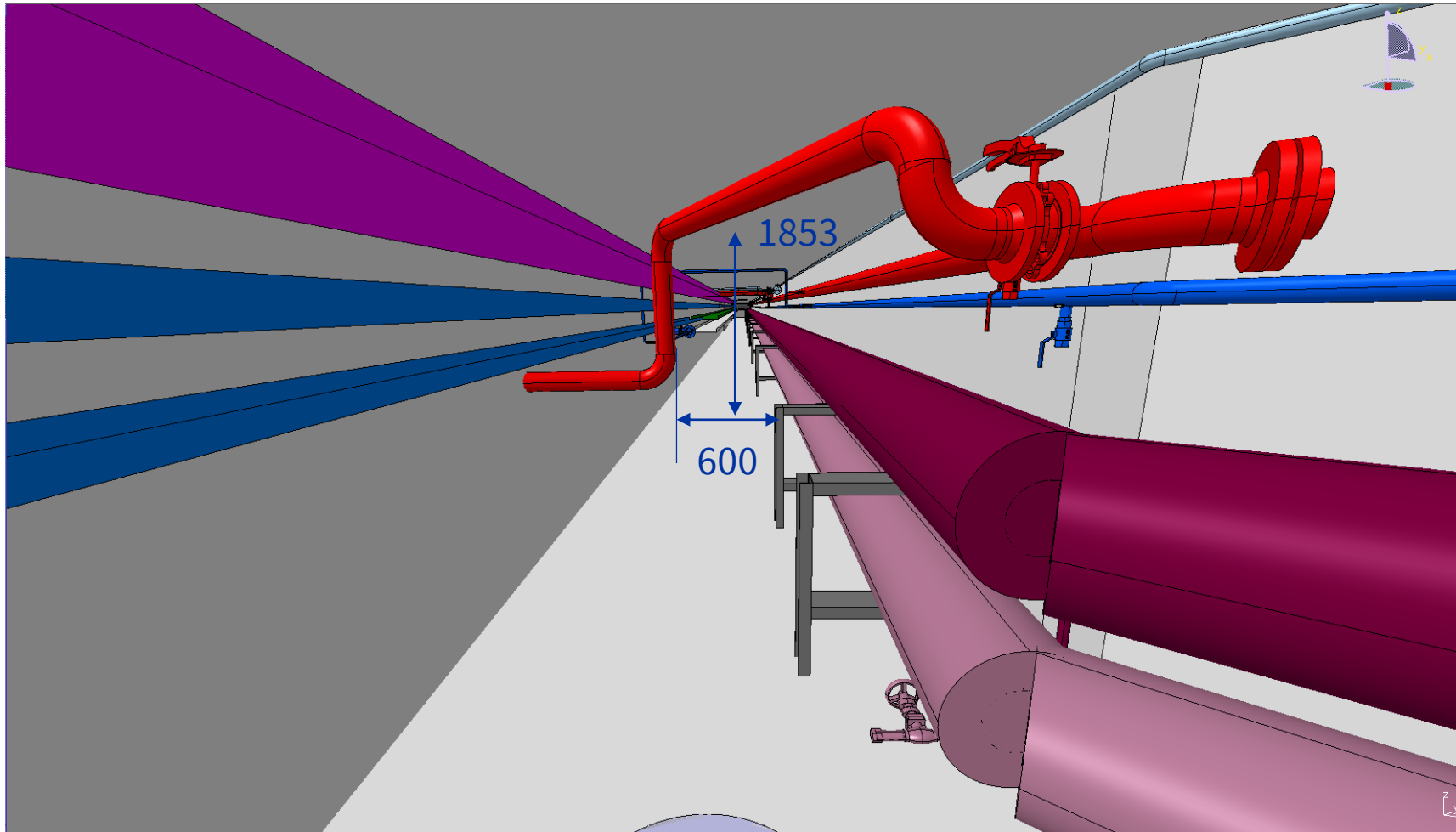

Intégration Galerie 825

zone ouest (Partie 4) **Future Configuration en cours:**

Jonction 825/b.188 Dcum A-1190

- Ouverture Génie civil après scan?

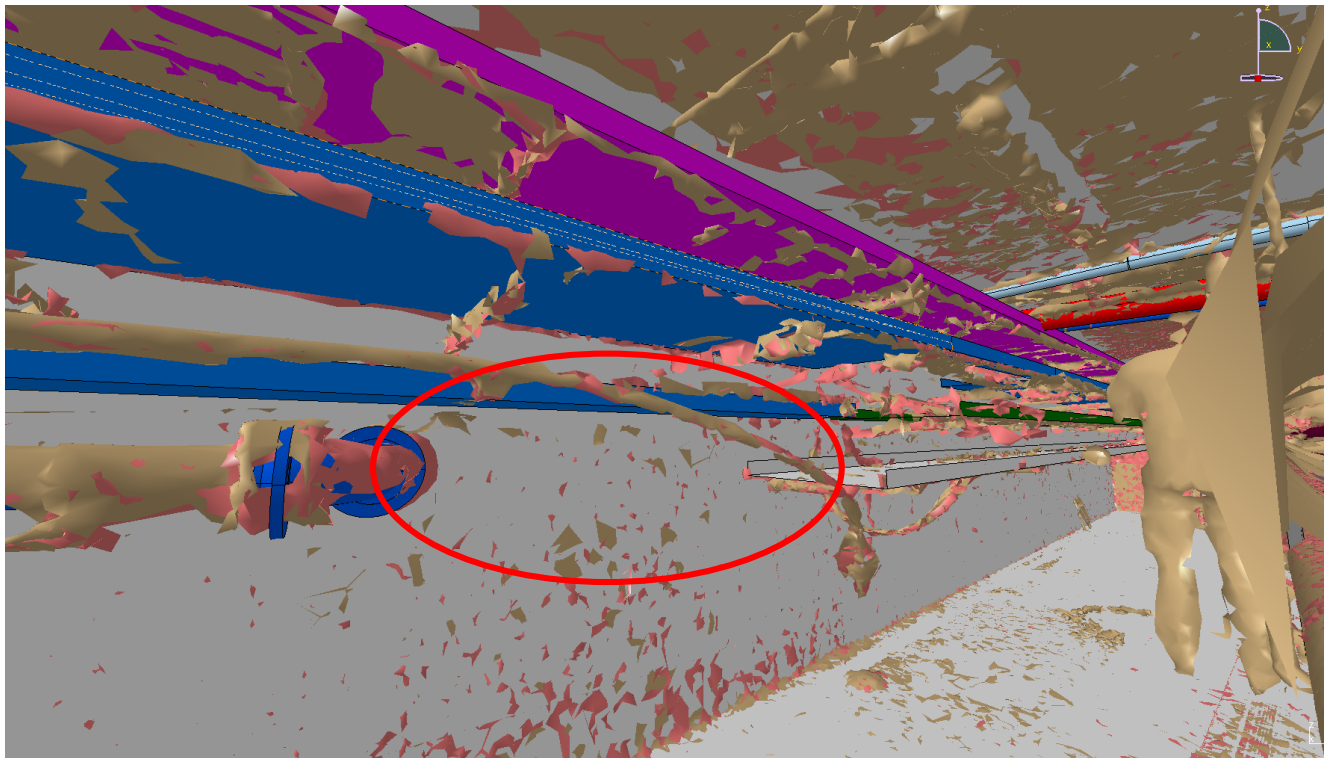

Intégration Galerie 825

zone ouest (Partie 4) **Future Configuration en cours:**

Jonction 825/Dcum A-1090

- Interférence Eau Incendie / Eau surchauffée

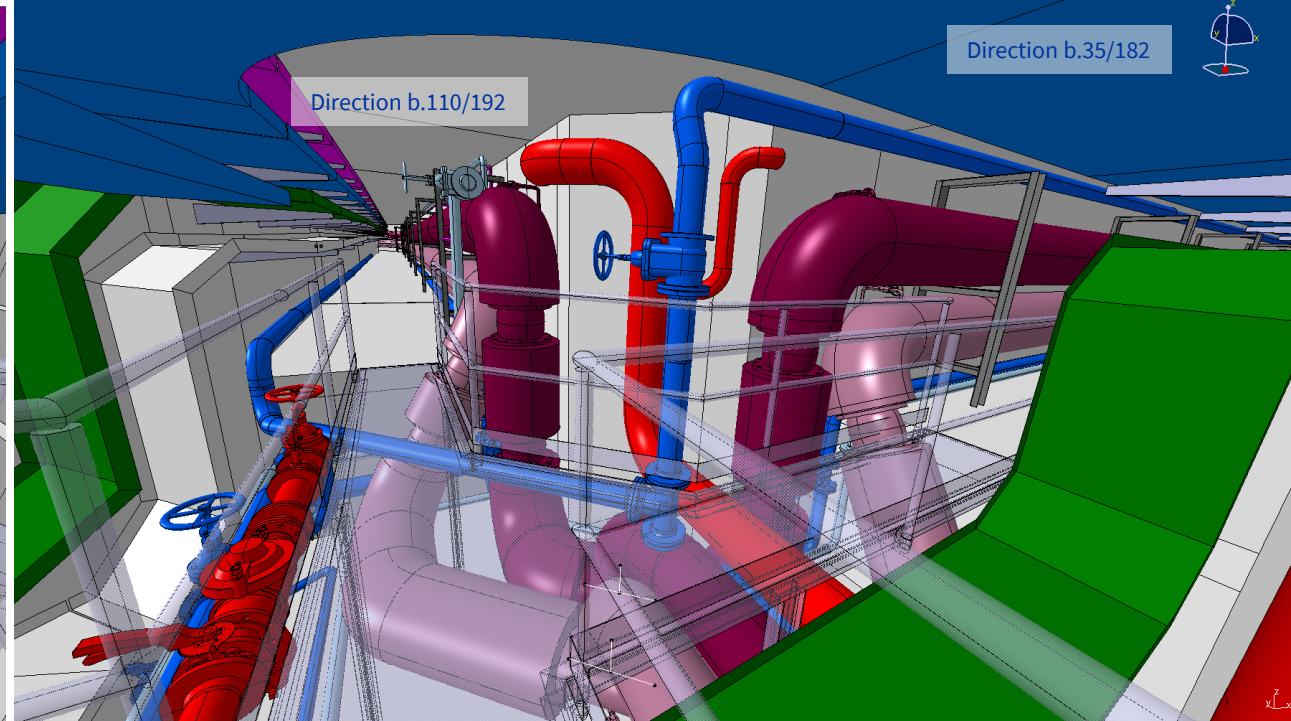
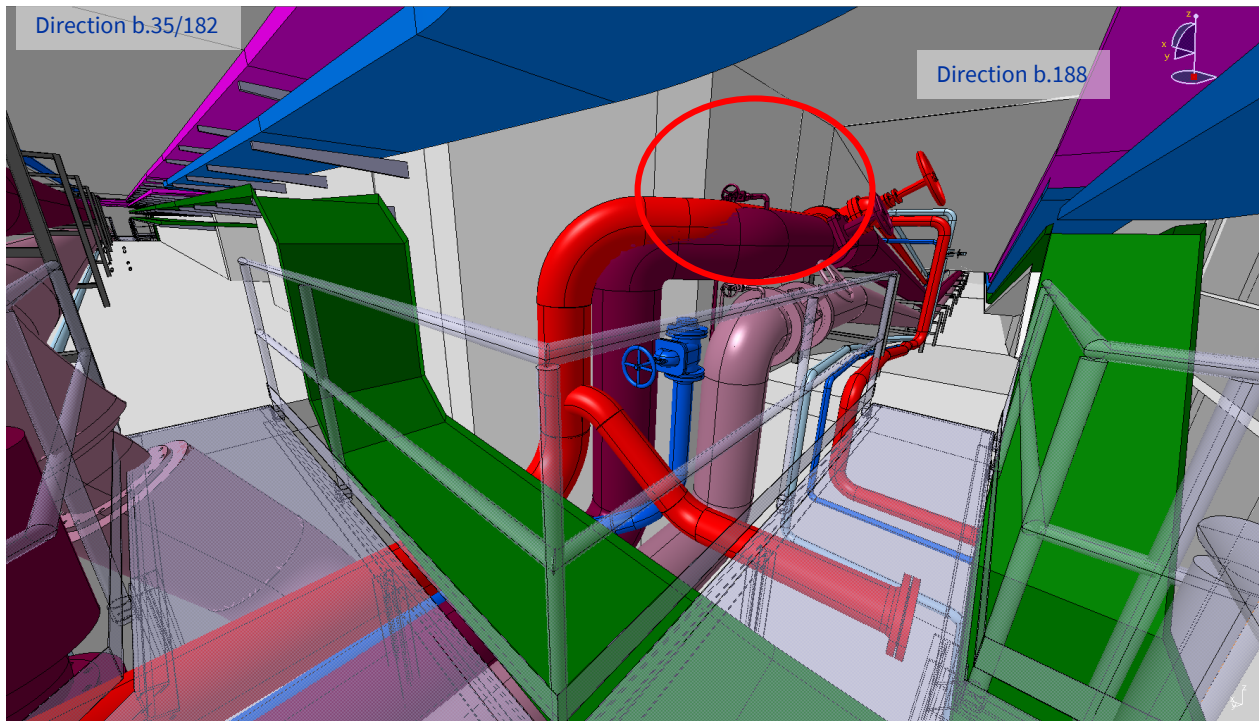
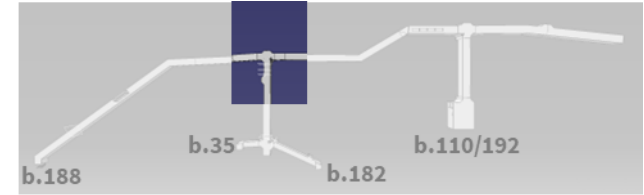

Intégration Galerie 825

zone ouest (Partie 4) **Future Configuration en cours:**

Jonction 825/Dcum A-1090

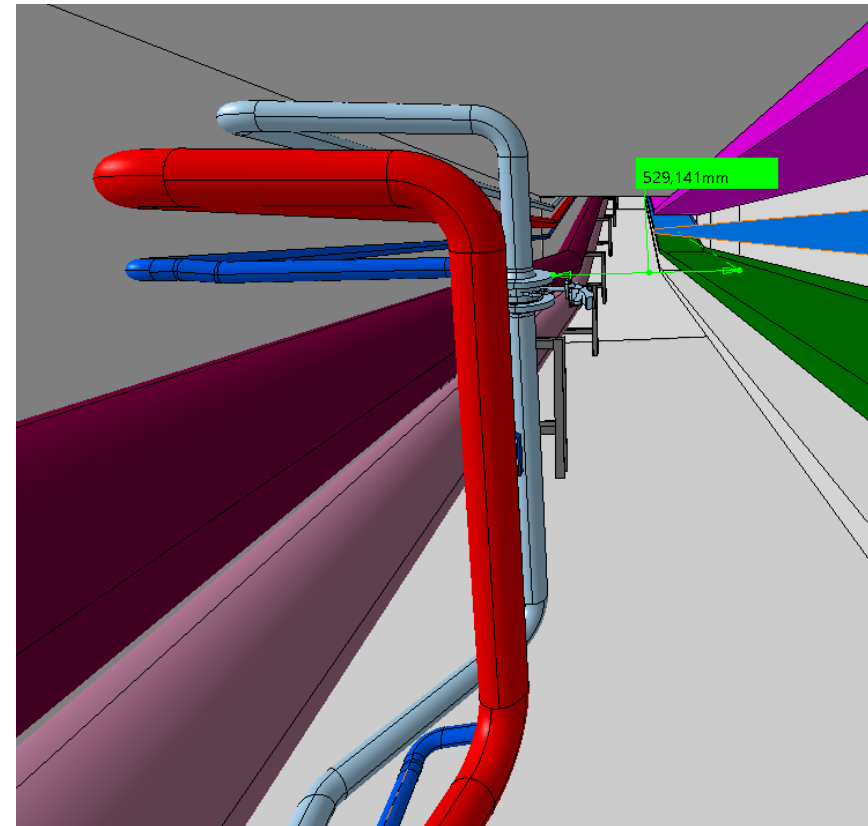
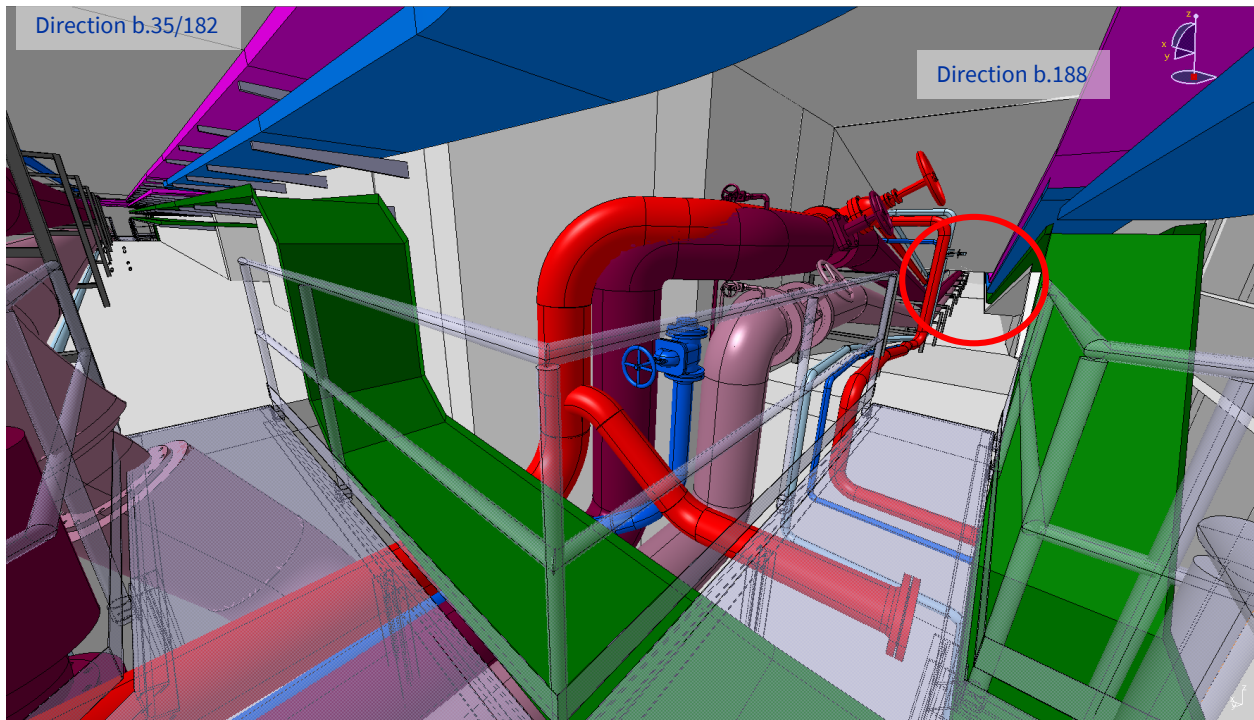
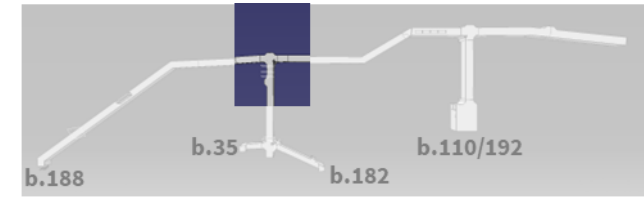

Intégration Galerie 825

zone ouest (Partie 4) **Future Configuration en cours:**

Jonction 825/Dcum A-1090

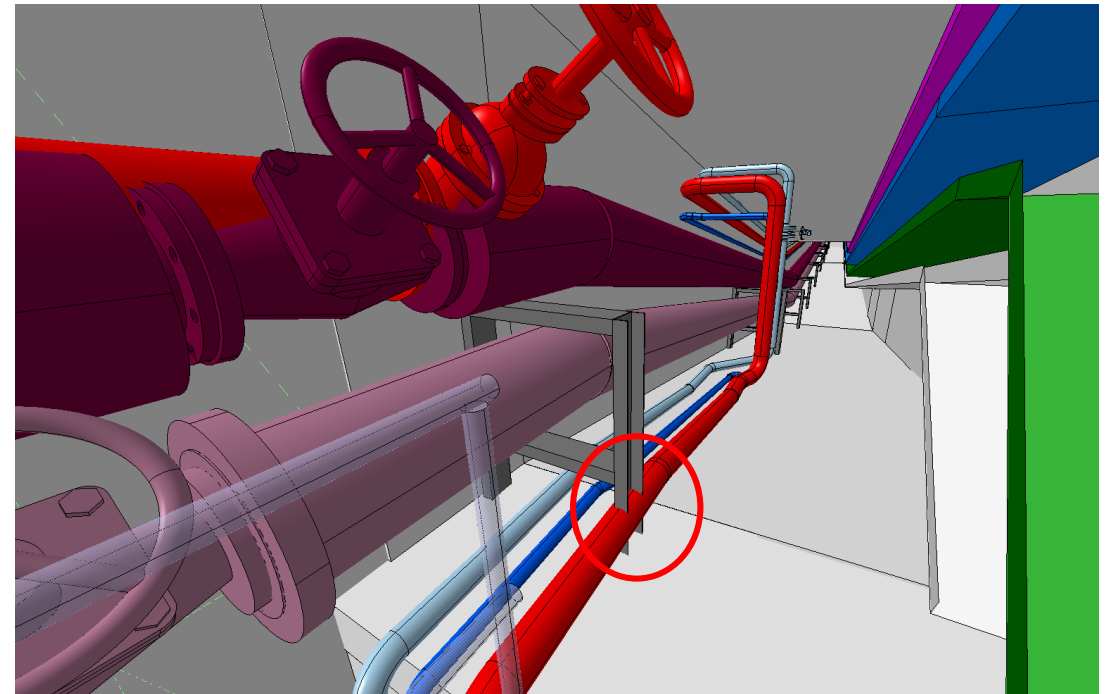
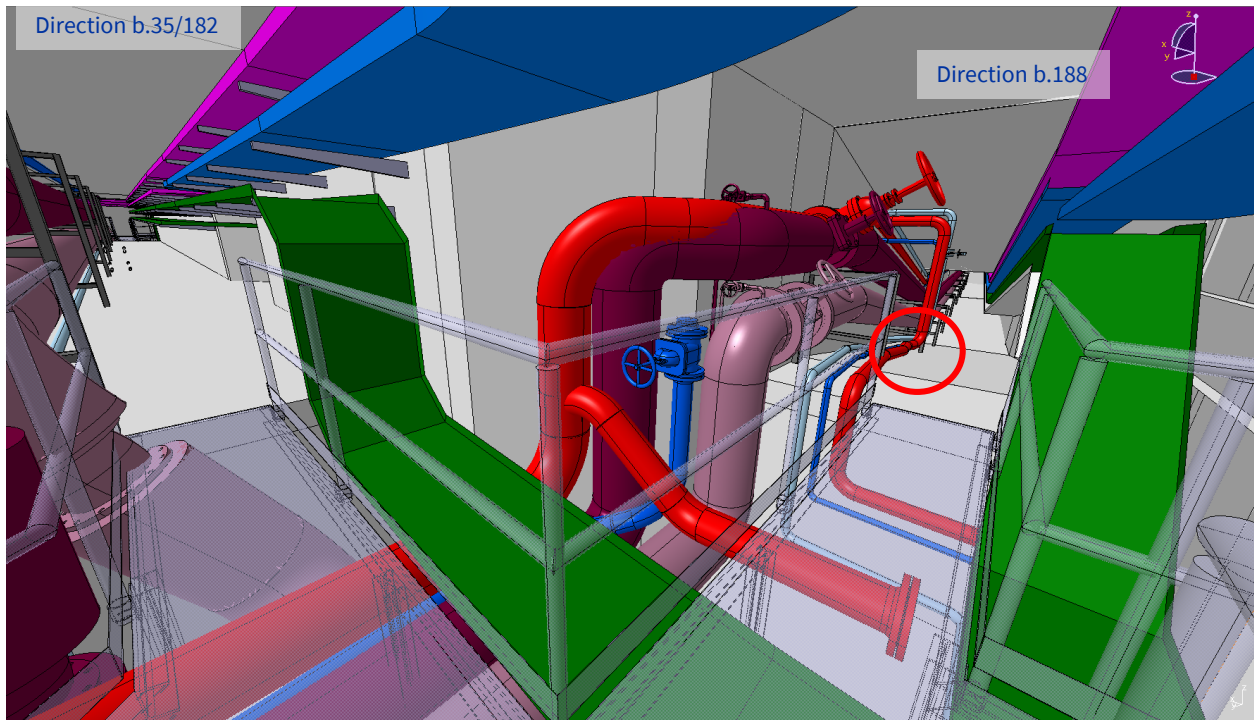
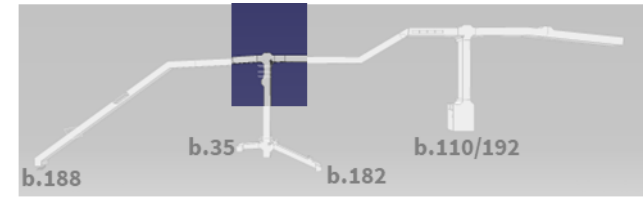

Intégration Galerie 825

zone ouest (Partie 4) **Future Configuration en cours:**

Jonction 825/Dcum A-1090

- Interférence Eau Surchauffée / EP
- Interférence Eau Surchauffée / Structure

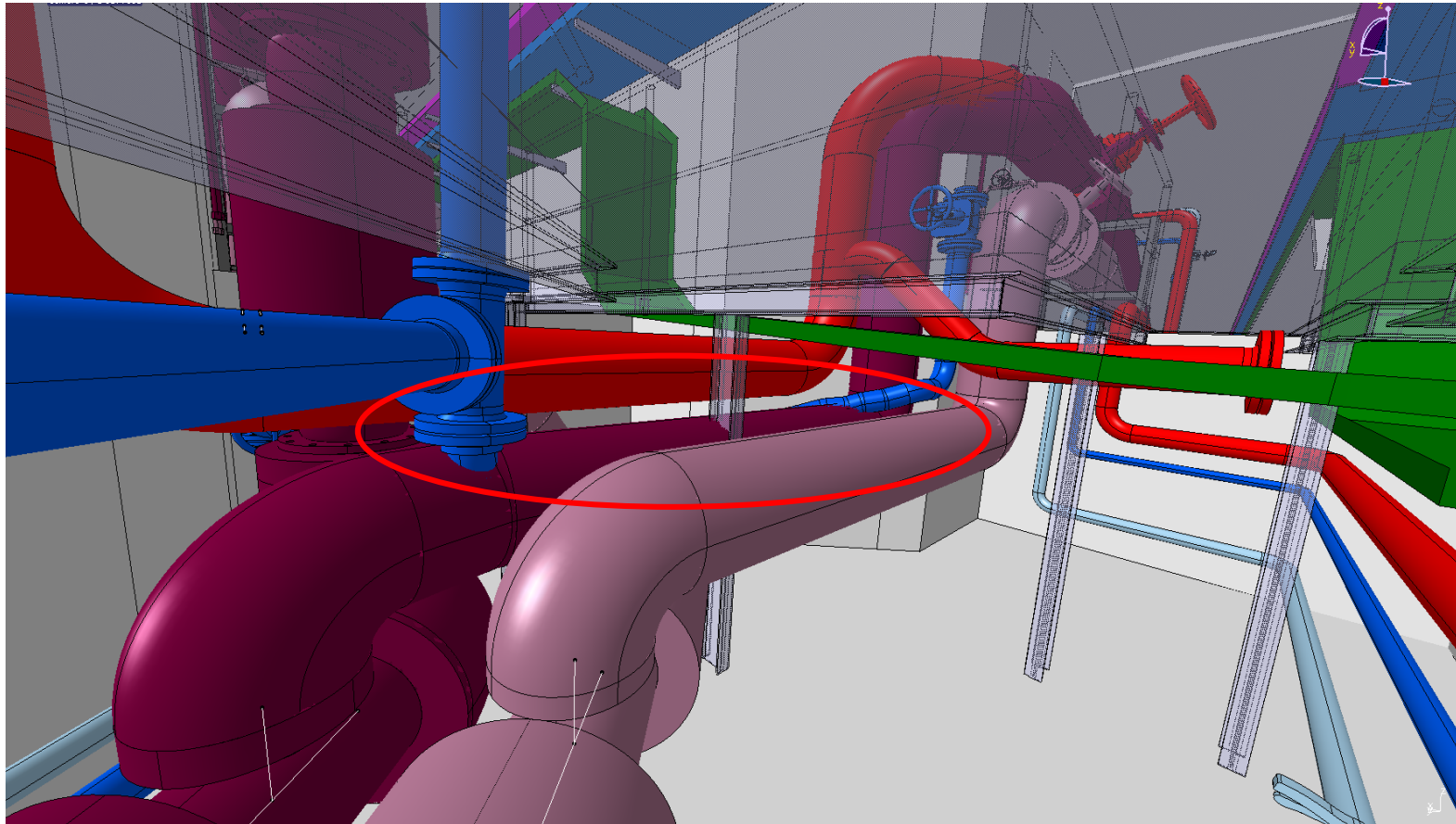
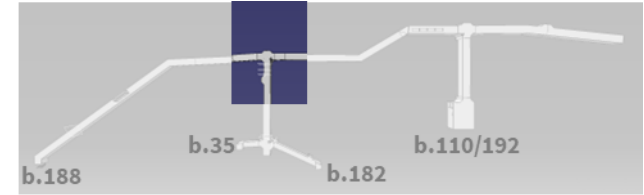

Intégration Galerie 825

zone ouest (Partie 4) **Future Configuration en cours:**

Jonction 825/Dcum A-1090

- Interférence AC et EP / Eau surchauffée

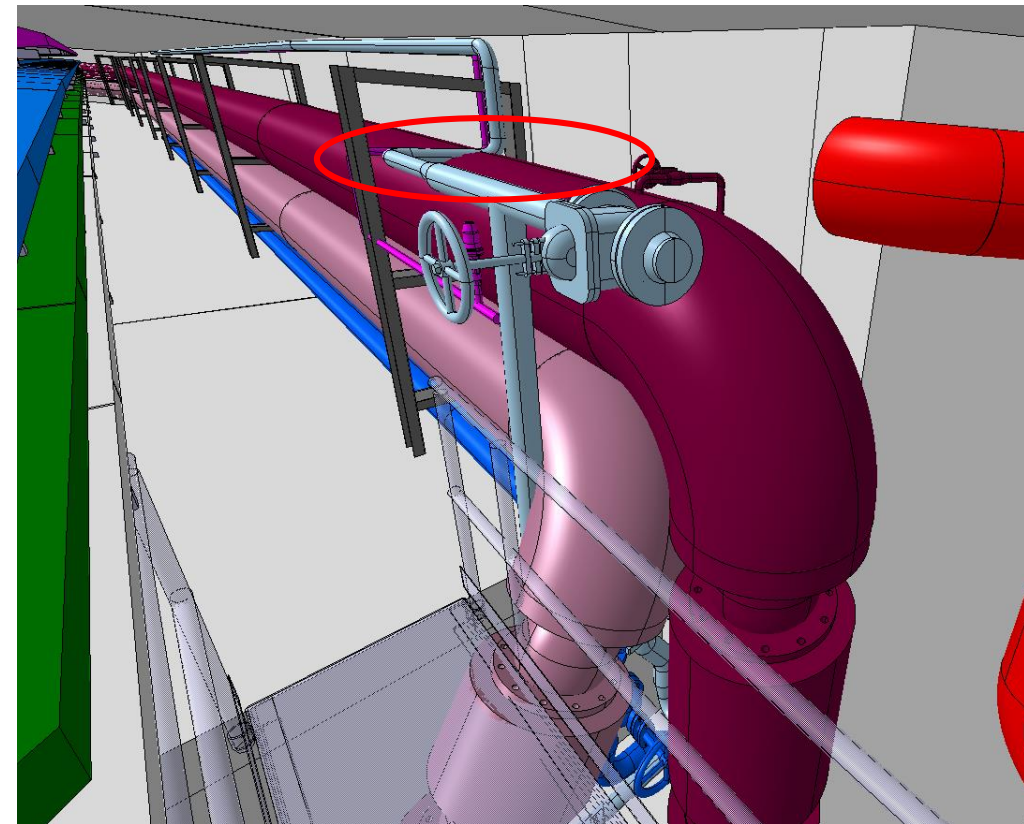
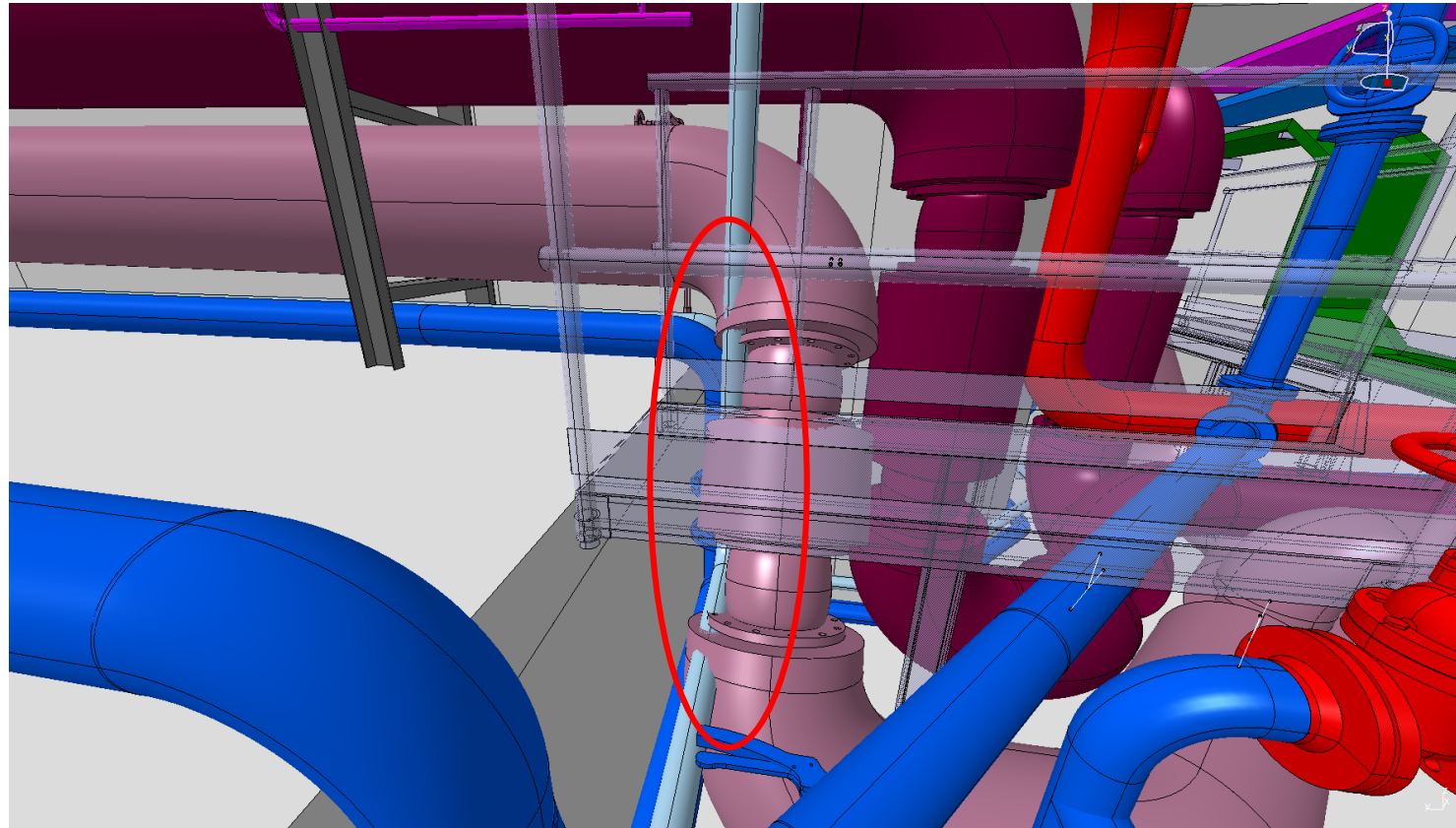
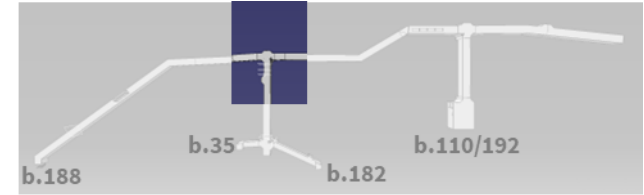

Intégration Galerie 825

zone ouest (Partie 4) **Future Configuration en cours:**

Jonction 825 Dcum D-0030

- Tuyauterie SCE: faire apparaitre calorifuge

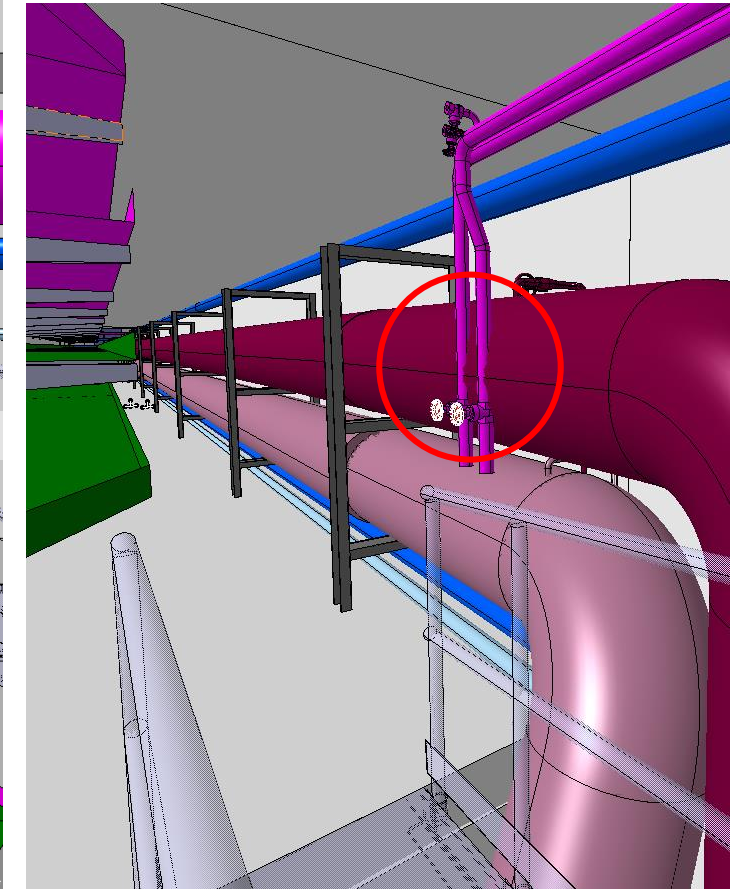
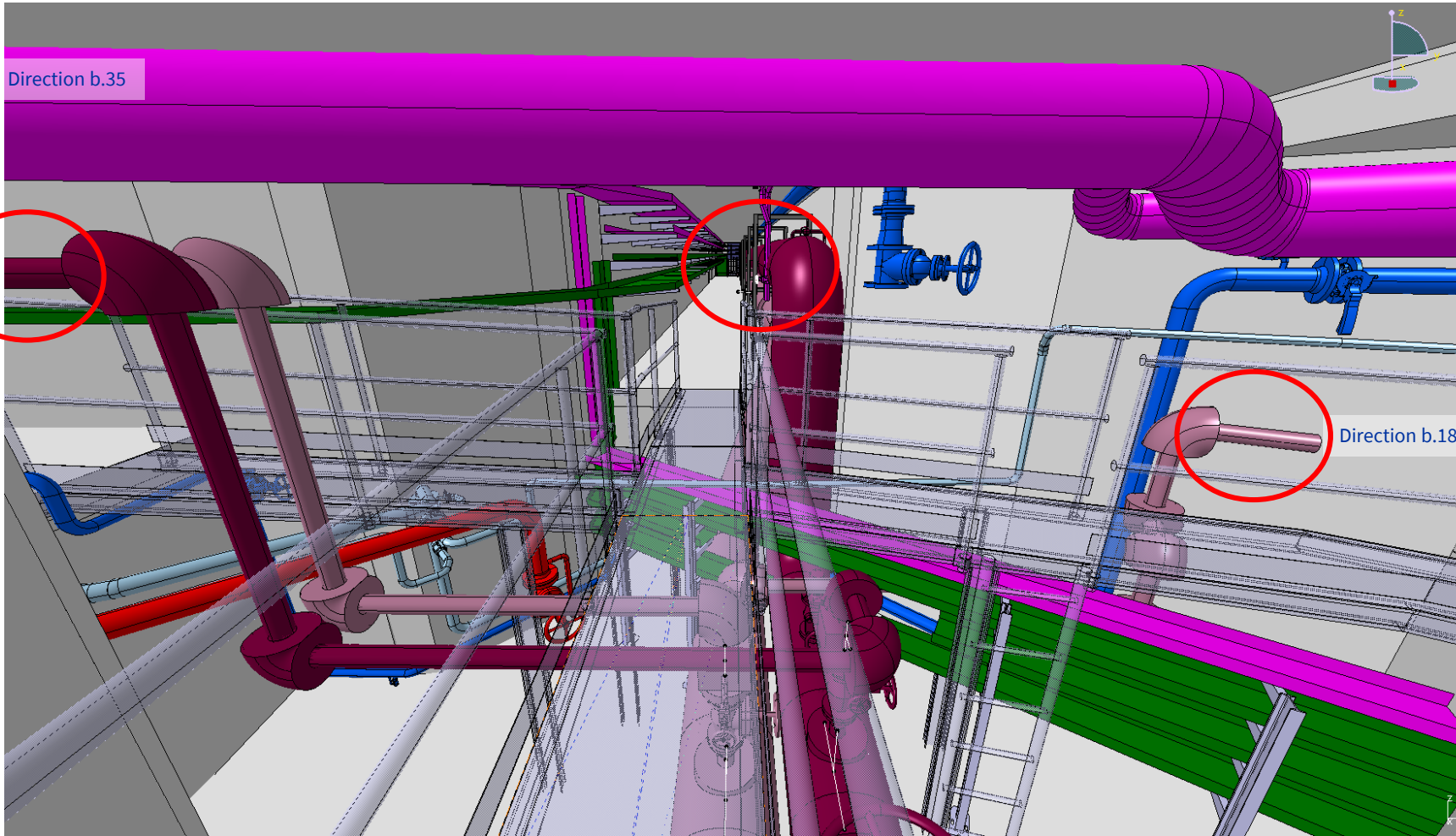
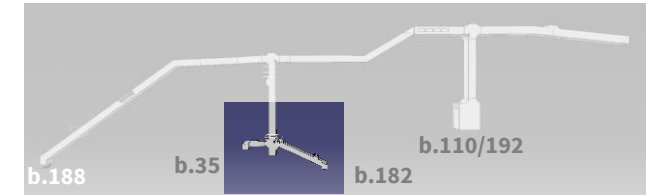

Intégration Galerie 825

Légende:

- document EDMS catalogue des échelles à câbles : 340478
- La couleur verte : basse tension (BT)
- La couleur turquoise : moyenne tension (MT – Réseau 18Kv)
- La couleur violet : Réseau contrôle



- Eau surchauffée aller en violet foncé
- Eau surchauffée retour en rose claire
- Eau potable
- Eau incendie
- Air comprimé
- Eau déminéralisée
- Eau glacée
- Hélium

Merci pour votre attention

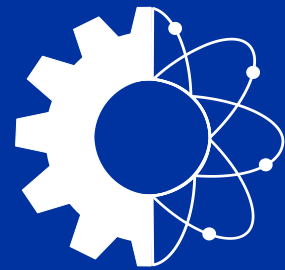

**ENGINEERING
DEPARTMENT**

Jean-Baptiste MAYOLINI EN-ACE-INT