

# High precision prediction for multi-scale processes at the LHC

---

Rene Poncelet



THE HENRYK NIEWODNICZAŃSKI  
INSTITUTE OF NUCLEAR PHYSICS  
POLISH ACADEMY OF SCIENCES

Presented research received  
funding from:

LEVERHULME  
TRUST



UNIVERSITY OF  
CAMBRIDGE



European Research Council  
Established by the European Commission

# What are the fundamental building blocks of matter?

Scattering experiments

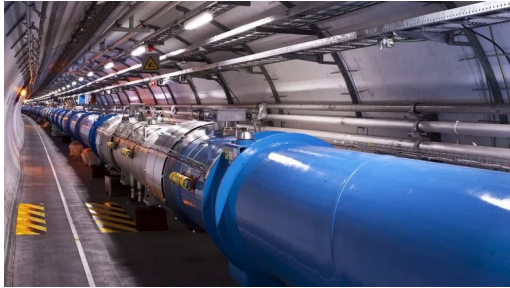

Credit: CERN

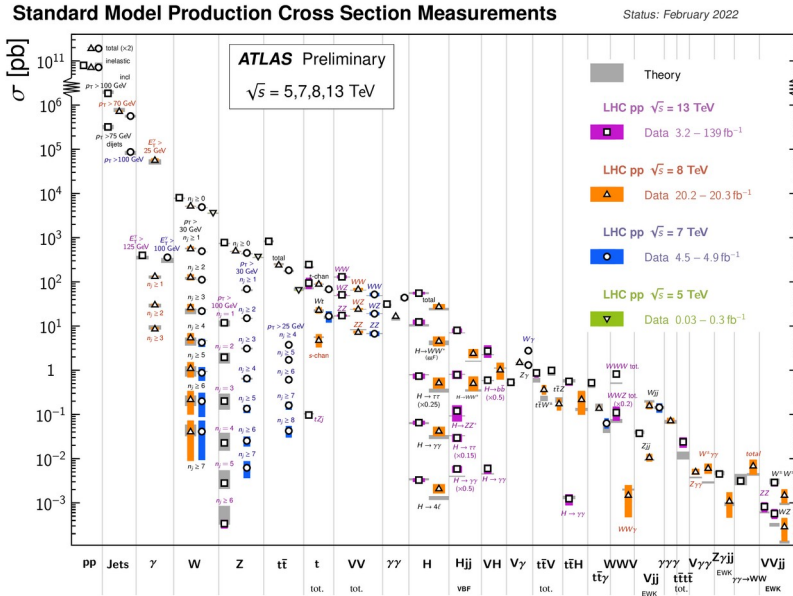

Theory/Model

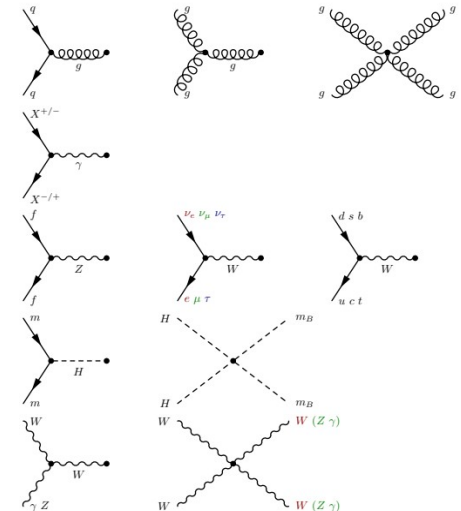

Credit: Jack Lindon, CERN

# Precision through higher orders

Hadronic cross section:

$$\sigma_{h_1 h_2 \rightarrow X} = \sum_{ij} \int_0^1 \int_0^1 dx_1 dx_2 \underbrace{\phi_{i,h_1}(x_1, \mu_F^2)}_{\text{Parton distribution functions}} \underbrace{\phi_{j,h_2}(x_2, \mu_F^2)}_{\text{Parton distribution functions}} \underbrace{\hat{\sigma}_{ij \rightarrow X}(\alpha_s(\mu_R^2), \mu_R^2, \mu_F^2)}_{\text{Partonic cross section}}$$

Parton distribution functions

Perturbative expansion of partonic cross section:

$$\hat{\sigma}_{ab \rightarrow X} = \underbrace{\alpha_s^0 \hat{\sigma}_{ab \rightarrow X}^{(0)}}_{\text{Leading order}} + \underbrace{\alpha_s^1 \hat{\sigma}_{ab \rightarrow X}^{(1)}}_{\text{Next-to-leading order}} + \underbrace{\alpha_s^2 \hat{\sigma}_{ab \rightarrow X}^{(2)}}_{\text{Next-to-next-to-leading order}} + \mathcal{O}(\alpha_s^3)$$

Leading order

Next-to-leading order

Next-to-next-to-leading order

Uncertainty:  
 $\alpha_s(m_Z) \approx 0.118$

Order of magnitude

O(10%)

O(1%)

**Next-to-next-to-leading order QCD needed to match experimental precision!**  
**→ In some cases even next-to-next-to-next-to-leading order!**

# Hadronic cross section in collinear factorization – NNLO QCD

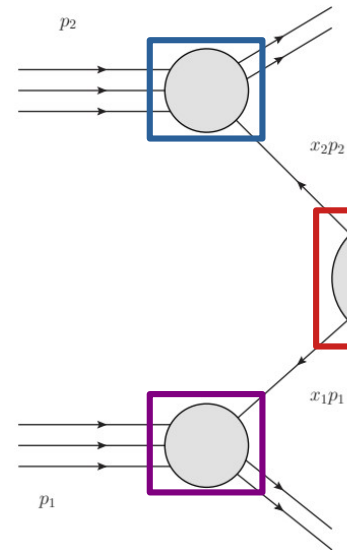

Hadronic X-section: 
$$\sigma_{h_1 h_2 \rightarrow X} = \sum_{ij} \int_0^1 \int_0^1 dx_1 dx_2 \phi_{i,h_1}(x_1, \mu_F^2) \phi_{j,h_2}(x_2, \mu_F^2) \hat{\sigma}_{ij \rightarrow X}(\alpha_s(\mu_R^2), \mu_R^2, \mu_F^2)$$

Parton distribution functions

Perturbative expansion of partonic cross section:

$$\hat{\sigma}_{ab \rightarrow X} = \hat{\sigma}_{ab \rightarrow X}^{(0)} + \hat{\sigma}_{ab \rightarrow X}^{(1)} + \hat{\sigma}_{ab \rightarrow X}^{(2)} + \mathcal{O}(\alpha_s^3)$$

The NLO bit: 
$$\hat{\sigma}_{ab}^{(1)} = \hat{\sigma}_{ab}^R + \hat{\sigma}_{ab}^V + \hat{\sigma}_{ab}^C$$

Real radiation

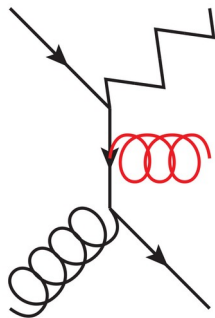

Virtual correction

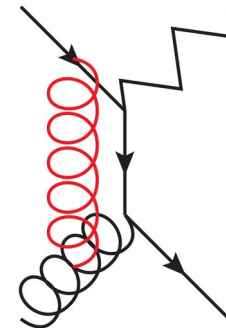

# Hadronic cross section in collinear factorization – NNLO QCD

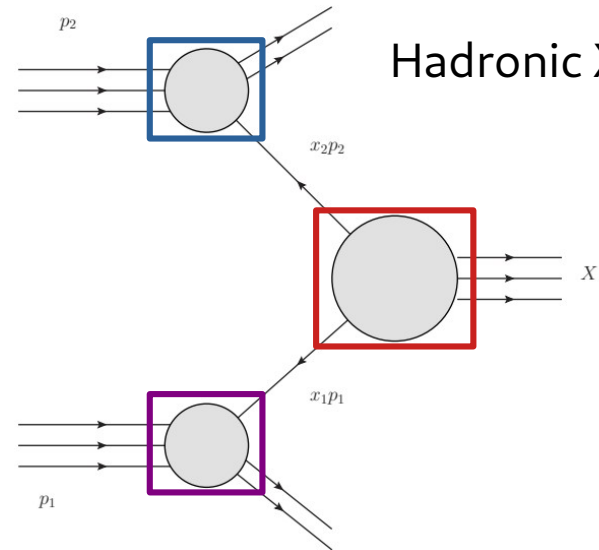

Hadronic X-section: 
$$\sigma_{h_1 h_2 \rightarrow X} = \sum_{ij} \int_0^1 \int_0^1 dx_1 dx_2 \phi_{i,h_1}(x_1, \mu_F^2) \phi_{j,h_2}(x_2, \mu_F^2) \hat{\sigma}_{ij \rightarrow X}(\alpha_s(\mu_R^2), \mu_R^2, \mu_F^2)$$

Parton distribution functions

Perturbative expansion of partonic cross section:

$$\hat{\sigma}_{ab \rightarrow X} = \hat{\sigma}_{ab \rightarrow X}^{(0)} + \hat{\sigma}_{ab \rightarrow X}^{(1)} + \hat{\sigma}_{ab \rightarrow X}^{(2)} + \mathcal{O}(\alpha_s^3)$$

The NNLO bit: 
$$\hat{\sigma}_{ab}^{(2)} = \hat{\sigma}_{ab}^{\text{RR}} + \hat{\sigma}_{ab}^{\text{RV}} + \hat{\sigma}_{ab}^{\text{VV}} + \hat{\sigma}_{ab}^{\text{C2}} + \hat{\sigma}_{ab}^{\text{C1}}$$

Double real radiation

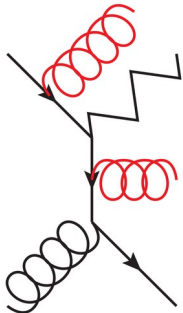

Real/Virtual correction

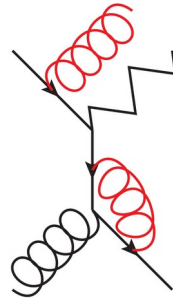

Double virtual corrections

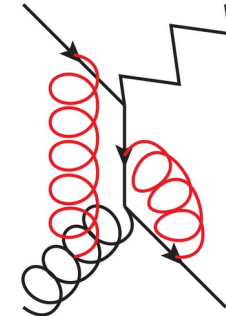

# NNLO QCD for 2→3 processes - inputs

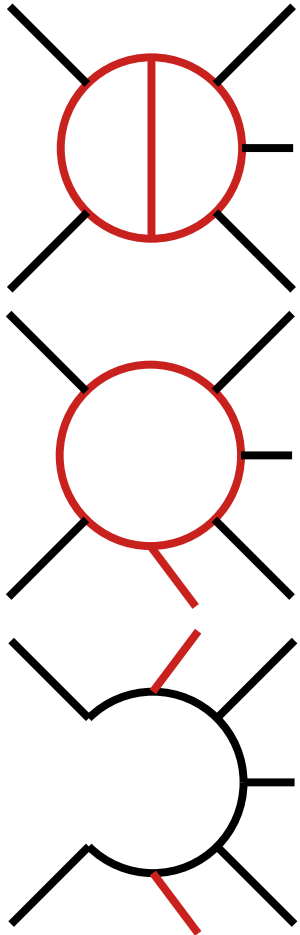

## Two-loop amplitudes

- (Non-) planar 5 point massless external states [Chawdry'19'20'21, Abreu'20'21'23, Agarwal'21'23, Badger'21'23]  
→ triggered by efficient MI representation [Chicherin'20]
- 5 point with one external mass [Abreu'20, Syrrakos'20, Canko'20, Badger'21'22, Chicherin'22]

## One-loop amplitudes → OpenLoops [Buccioni'19]

- Many legs and IR stable (soft and collinear limits)

## Double-real Born amplitudes → AvHlib [Bury'15]

- IR finite cross-sections → NNLO subtraction schemes  
qT-slicing [Catani'07], N-jettiness slicing [Gaunt'15/Boughezal'15], Antenna [Gehrmann'05-'08], Colorful [DelDuca'05-'15], Projctction [Cacciari'15], Geometric [Herzog'18], Unsubtraction [Aguilera-Verdugo'19], Nested collinear [Caola'17], Local Analytic [Magnea'18], **Sector-improved residue subtraction** [Czakon'10-'14,'19]

# NNLO QCD cross sections for massless $2 \rightarrow 3$ processes

$$pp \rightarrow \gamma\gamma\gamma$$

$$pp \rightarrow \gamma\gamma j$$

$$pp \rightarrow \gamma j j$$

$$pp \rightarrow j j j$$

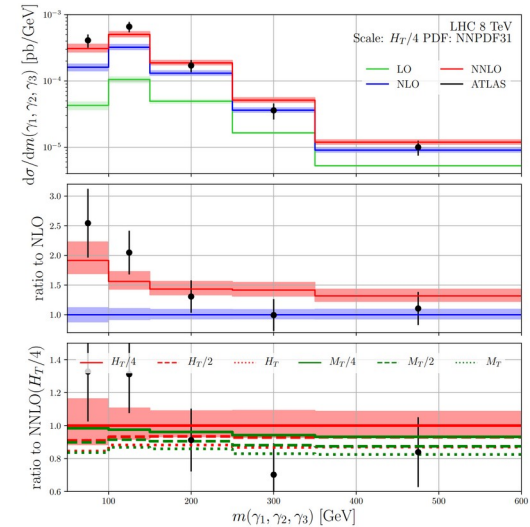

Chawdhry, Czakon, Mitov,  
RP [1911.00479]

Kallweit, Sotnikov,  
Wiesemann [2010.04681]

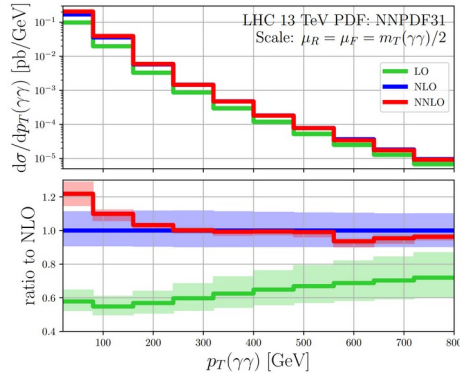

Chawdhry, Czakon, Mitov,  
RP [2103.04319]

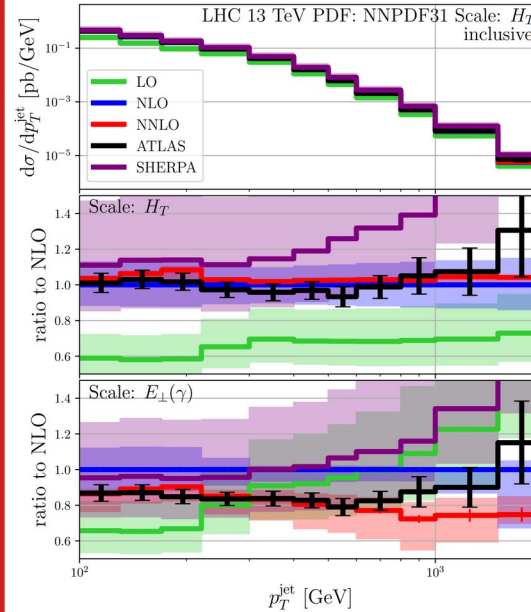

Badger, Czakon, Hartanto,  
Moodie, Peraro, RP, Zoia  
[2304.06682]

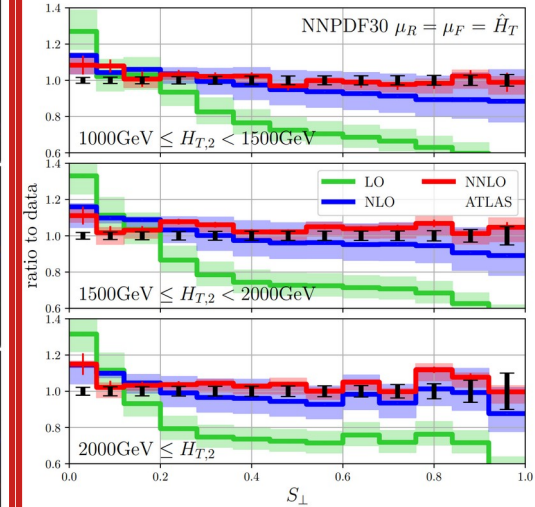

Czakon, Mitov, RP  
[2106.05331]  
+ Alvarez, Cantero, Llorente  
[2301.01086]

# Multi-jet observables

## Test of pQCD and extraction of strong coupling constant

NLO theory unc. > experimental unc.

- **NNLO QCD needed for precise theory-data** comparisons  
→ Restricted to two-jet data [Currie'17+later][Czakon'19]
- **New NNLO QCD three-jet** → access to more observables
- Jet ratios

**Next-to-Next-to-Leading Order Study of Three-Jet Production at the LHC**  
Czakon, Mitov, Poncelet [2106.05331]

$$R^i(\mu_R, \mu_F, \text{PDF}, \alpha_{S,0}) = \frac{d\sigma_3^i(\mu_R, \mu_F, \text{PDF}, \alpha_{S,0})}{d\sigma_2^i(\mu_R, \mu_F, \text{PDF}, \alpha_{S,0})}$$

- Event shapes

**NNLO QCD corrections to event shapes at the LHC**

Alvarez, Cantero, Czakon, Llorente, Mitov, Poncelet [2301.01086]

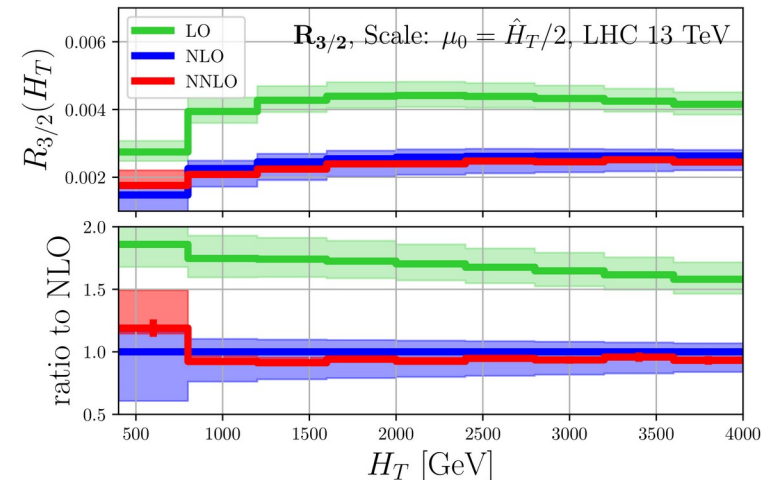
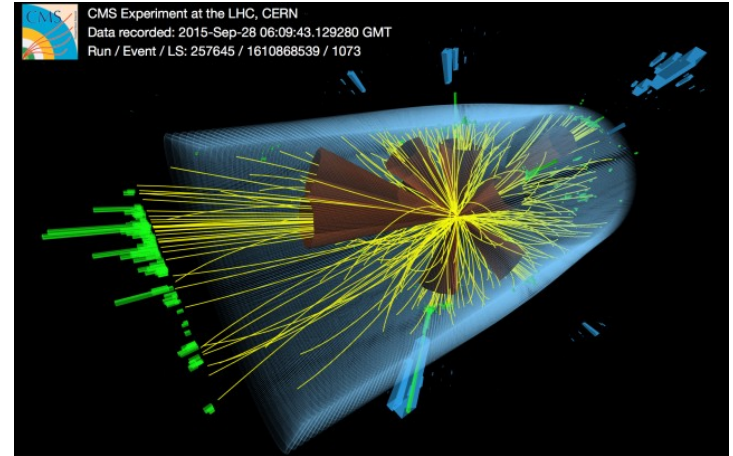



# Encoding QCD dynamics in event shapes

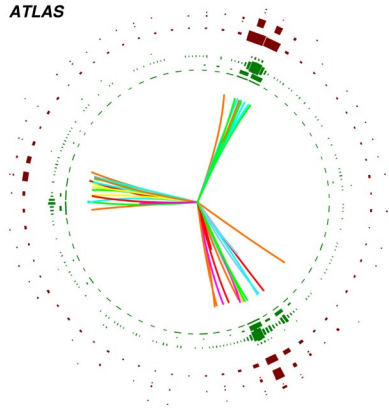

Using (global) event information to separate different regimes of QCD event evolution:

- **Thrust & Thrust-Minor**  $T_{\perp} = \frac{\sum_i |\vec{p}_{T,i} \cdot \hat{n}_{\perp}|}{\sum_i |\vec{p}_{T,i}|}$ , and  $T_m = \frac{\sum_i |\vec{p}_{T,i} \times \hat{n}_{\perp}|}{\sum_i |\vec{p}_{T,i}|}$ .
- **Energy-energy correlators**

$$\frac{1}{\sigma_2} \frac{d\sigma}{d \cos \Delta\phi} = \frac{1}{\sigma_2} \sum_{ij} \int \frac{d\sigma_{x_{\perp,i} x_{\perp,j}}}{dx_{\perp,i} dx_{\perp,j} d \cos \Delta\phi_{ij}} \delta(\cos \Delta\phi - \cos \Delta\phi_{ij}) dx_{\perp,i} dx_{\perp,j} d \cos \Delta\phi_{ij},$$

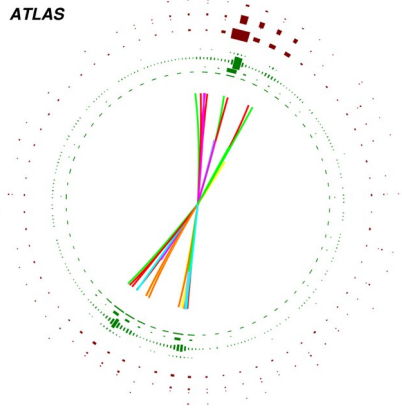

Separation of energy scales:  $H_{T,2} = p_{T,1} + p_{T,2}$

Ratio to 2-jet:

$$R^i(\mu_R, \mu_F, \text{PDF}, \alpha_{S,0}) = \frac{d\sigma_3^i(\mu_R, \mu_F, \text{PDF}, \alpha_{S,0})}{d\sigma_2^i(\mu_R, \mu_F, \text{PDF}, \alpha_{S,0})}$$

Here: **use jets as input** → experimentally advantageous  
(better calibrated, smaller non-pert.)

# Transverse Thrust @ NNLO QCD

## NNLO QCD corrections to event shapes at the LHC

Alvarez, Cantero, Czakon, Llorente, Mitov, Poncelet [2301.01086]

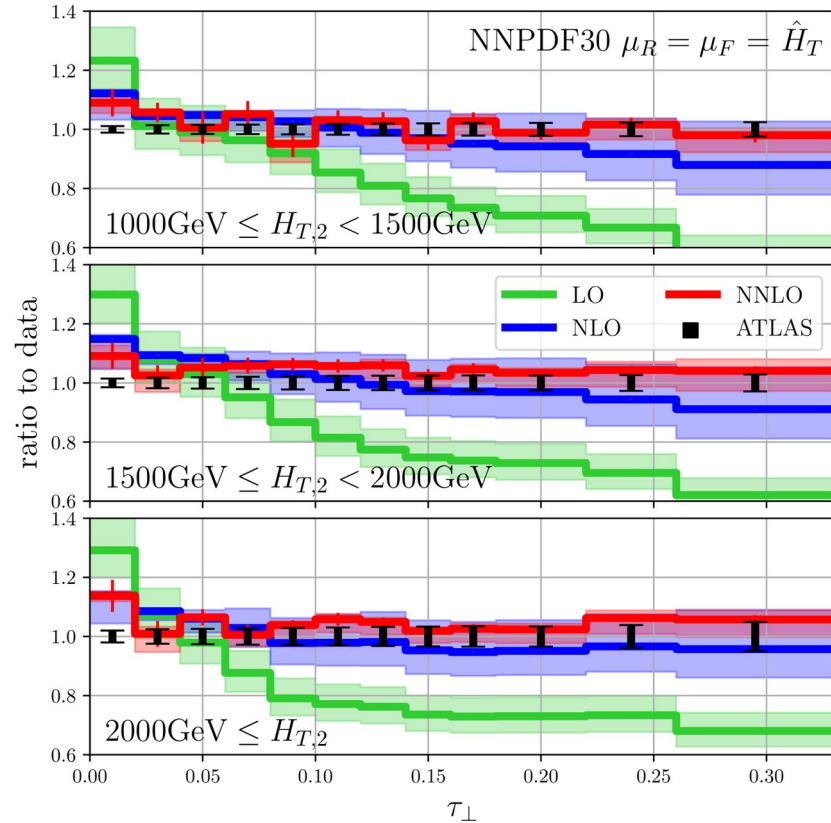

ATLAS [2007.12600]

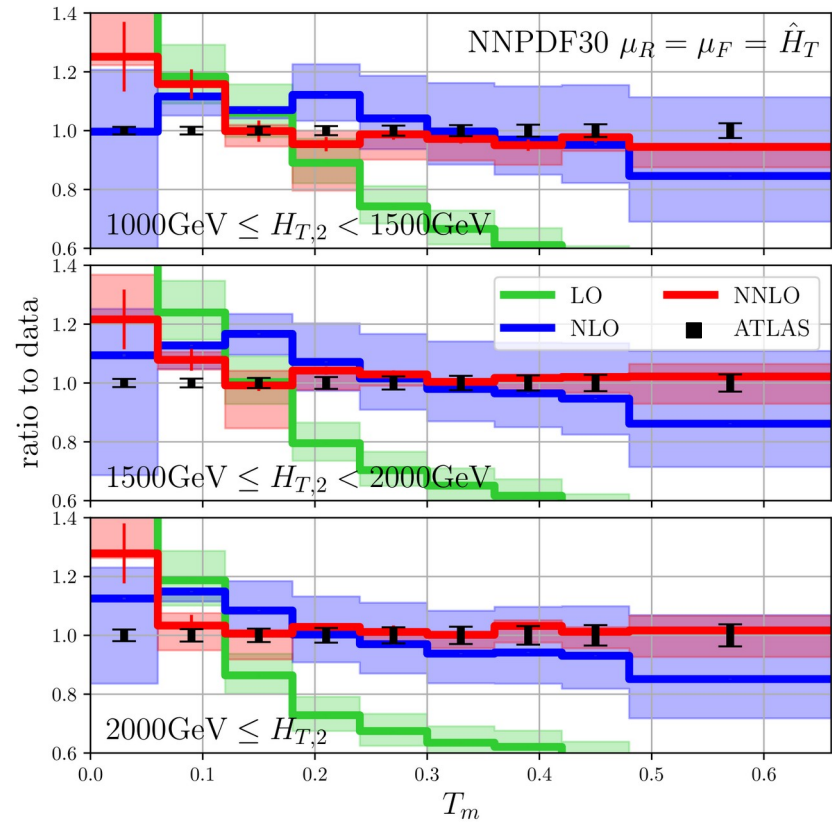

# The transverse energy-energy correlator

$$\frac{1}{\sigma_2} \frac{d\sigma}{d \cos \Delta\phi} = \frac{1}{\sigma_2} \sum_{ij} \int \frac{d\sigma_{x_{\perp,i}x_{\perp,j}}}{dx_{\perp,i}dx_{\perp,j}d \cos \Delta\phi_{ij}} \delta(\cos \Delta\phi - \cos \Delta\phi_{ij}) dx_{\perp,i} dx_{\perp,j} d \cos \Delta\phi_{ij},$$

- Insensitive to soft radiation through energy weighting  $x_{T,i} = E_{T,i} / \sum_j E_{T,j}$
- Event topology separation:
  - Central plateau contain isotropic events
  - To the right: self-correlations, collinear and in-plane splitting
  - To the left: back-to-back

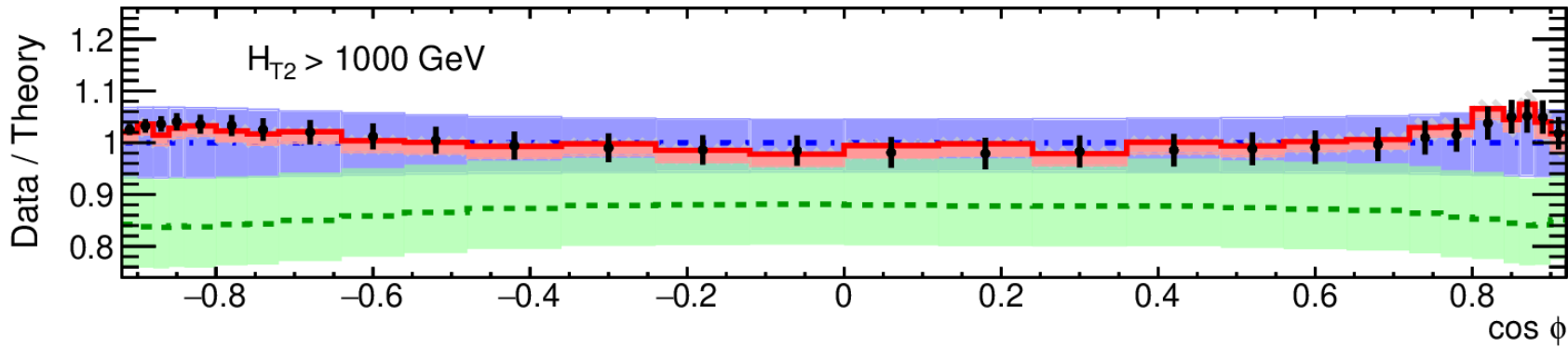

[ATLAS 2301.09351]

**ATLAS**

Particle-level TEEC

$\sqrt{s} = 13 \text{ TeV}; 139 \text{ fb}^{-1}$

anti- $k_t$   $R = 0.4$

$p_T > 60 \text{ GeV}$

$|\eta| < 2.4$

$\mu_{R,F} = \hat{P}_T$

$\alpha_s(m_Z) = 0.1180$

NNPDF 3.0 (NNLO)

—•— Data  
 - - - LO  
 - · - NLO  
 - - - NNLO

# Double differential TEEC

[ATLAS 2301.09351]

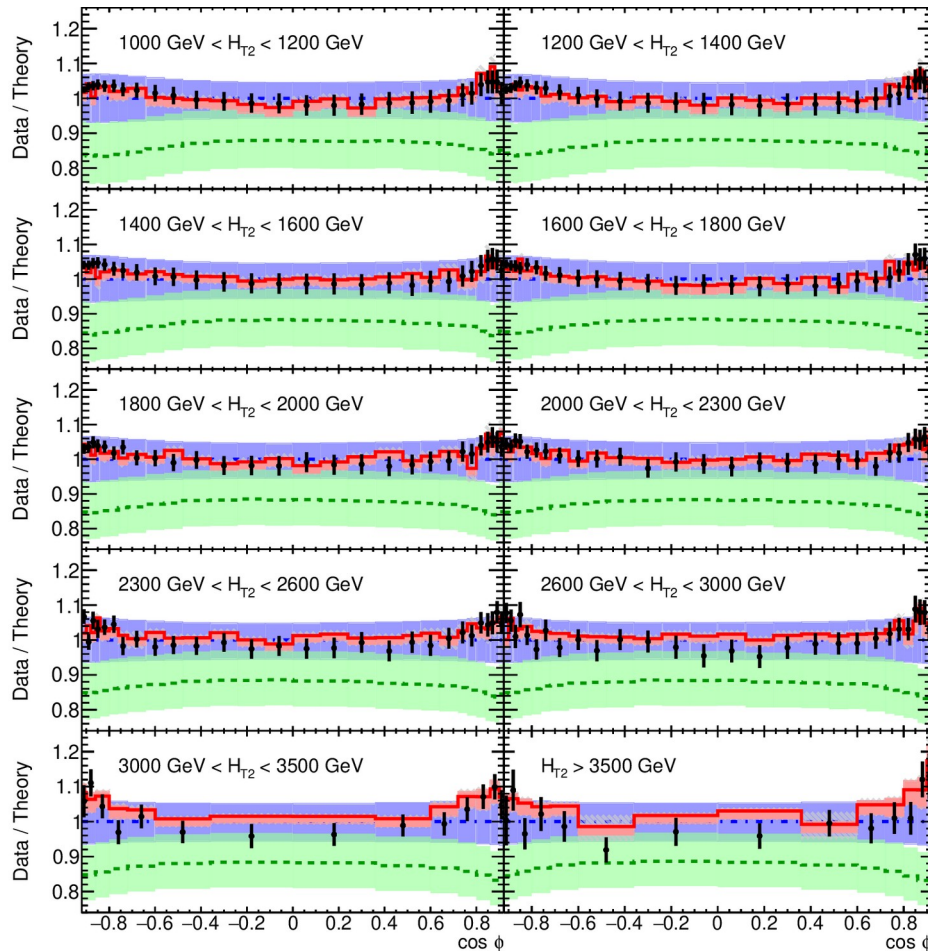

**ATLAS**

Particle-level TEEC

$\sqrt{s} = 13 \text{ TeV}; 139 \text{ fb}^{-1}$

anti- $k_t$   $R = 0.4$

$p_T > 60 \text{ GeV}$

$|\eta| < 2.4$

$\mu_{R,F} = \hat{p}_T$

$\alpha_s(m_Z) = 0.1180$

NNPDF 3.0 (NNLO)

— Data

--- LO

--- NLO

--- NNLO

# Running of $\alpha_s$

NLO QCD

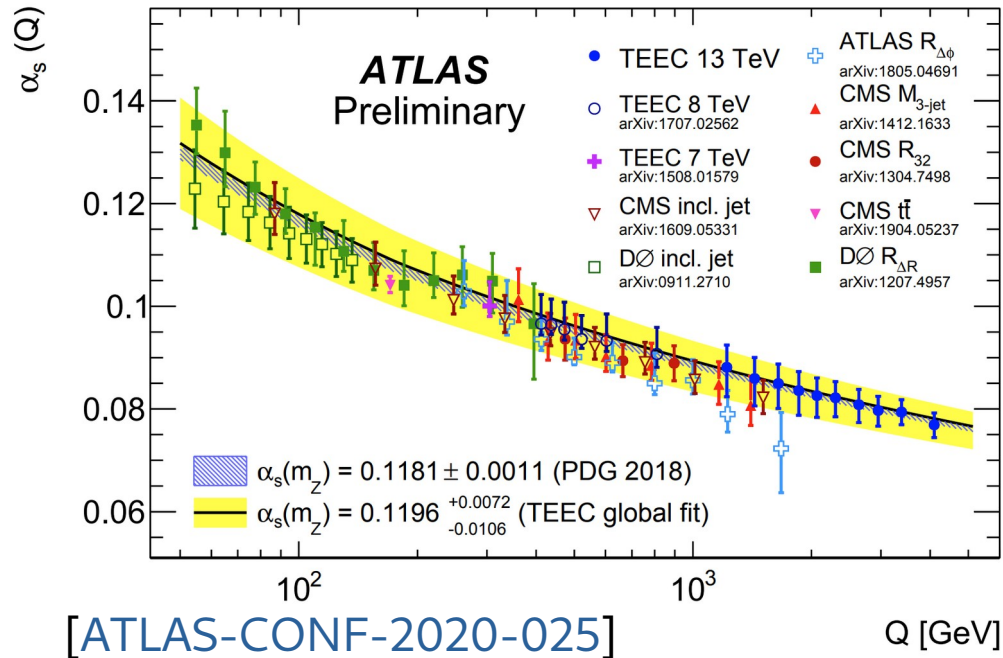

NNLO QCD

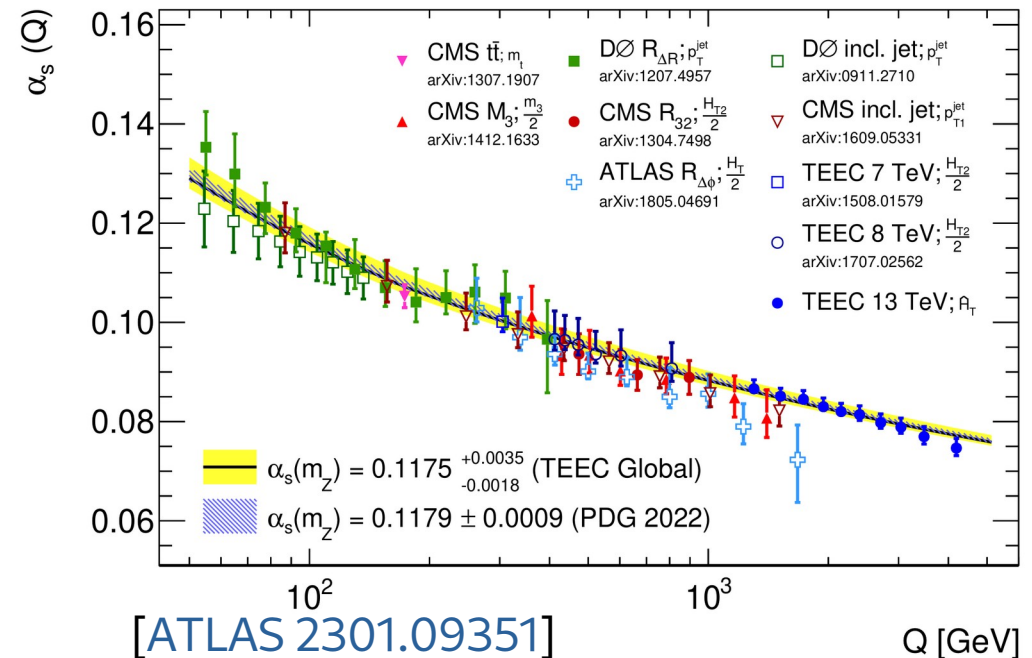

# Prompt photon production

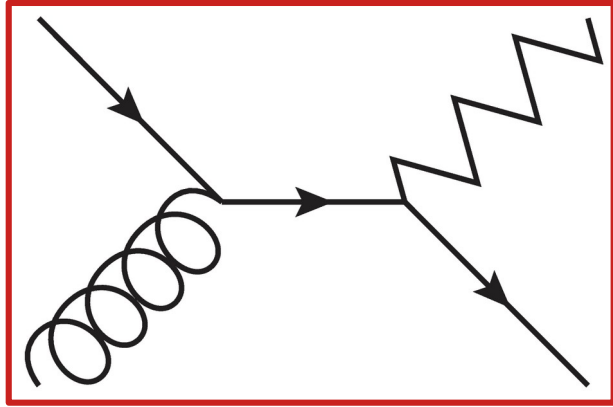

## Direct production

- Test of perturbative QCD
- Gluon PDF sensitivity
- Estimates for BSM backgrounds

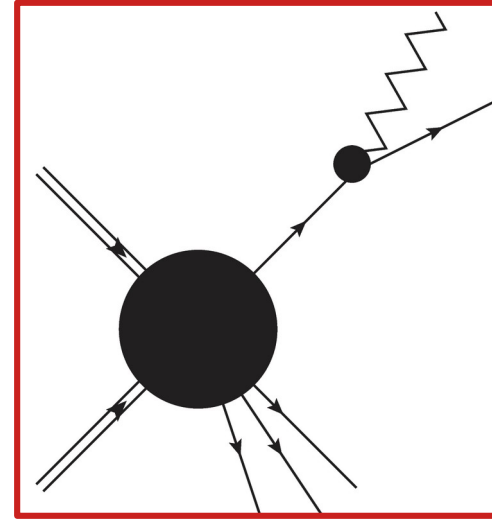

## Fragmentation

- Depends on non-perturbative fragmentation functions
- Separation from “direct” not unique

# Why photon plus a jet pair?

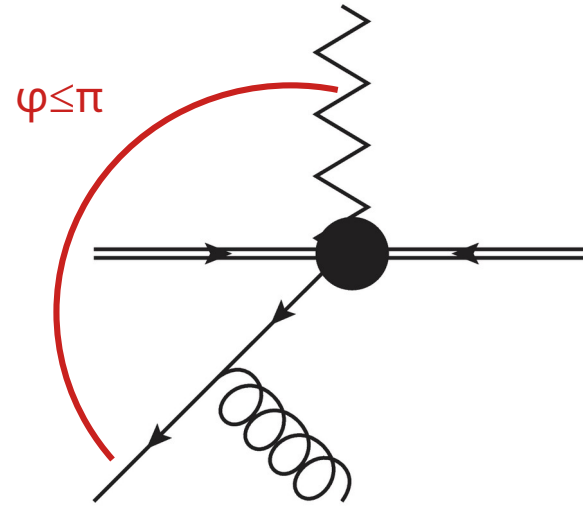
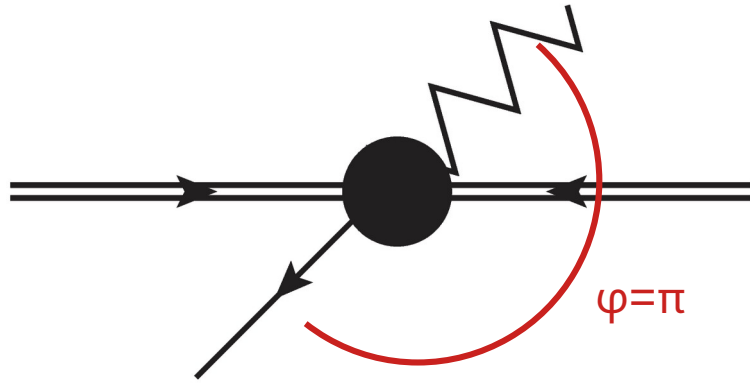

- Non-back-to-back Born configurations  
→ access to angular correlations between the photon and jets
- Access to different kinematic regimes through distinguishable photon  
→ enhance direct, high- or low- $z$  fragmentation
- Background process for BSM:  $pp \rightarrow \gamma + Y (\rightarrow jj)$

# Photon plus jet pair

Measurement of isolated-photon plus two-jet production in pp collisions at  $\sqrt{s} = 13$  TeV with the ATLAS detector [[1912.09866](#)]

<b>Requirements on photon</b>	$E_T^\gamma > 150$ GeV, $ \eta^\gamma  < 2.37$ (excluding $1.37 <  \eta^\gamma  < 1.56$ ) $E_T^{\text{iso}} < 0.0042 \cdot E_T^\gamma + 4.8$ GeV (reconstruction level) $E_T^{\text{iso}} < 0.0042 \cdot E_T^\gamma + 10$ GeV (particle level)		
<b>Requirements on jets</b>	at least two jets using anti- $k_r$ algorithm with $R = 0.4$ $p_T^{\text{jet}} > 100$ GeV, $ y^{\text{jet}}  < 2.5$ , $\Delta R^{\gamma\text{-jet}} > 0.8$		
<b>Phase space</b>	<b>total</b>	<b>fragmentation enriched</b>	<b>direct enriched</b>
		$E_T^\gamma < p_T^{\text{jet}2}$	$E_T^\gamma > p_T^{\text{jet}1}$
<b>Number of events</b>	755 270	111 666	386 846

Modelled with hybrid isolation

$$E_\perp(r) \leq E_{\perp\text{max}}(r) = 0.1 E_\perp(\gamma) \left( \frac{1 - \cos(r)}{1 - \cos(R_{\text{max}})} \right)^2 \quad \text{for } r \leq R_{\text{max}} = 0.1$$

+

$$E_\perp(r) \leq E_{\perp\text{max}} = 0.0042 E_\perp(\gamma) + 10 \text{ GeV} \quad \text{for } r \leq R_{\text{max}} = 0.4$$



No fragmentation contribution  
 → Purely pQCD through NNLO  
 → focus on “inclusive” and “direct” PS



# Theory - data comparisons

## NNLO QCD

- Describes data well
- Improvements on the shape
- Small corrections
- Small remaining scale dependence

## Comment on the SHERPA predictions

- Large NLO scale uncertainties
- The shape is not well described
- Maybe an artefact of multi-jet merging?

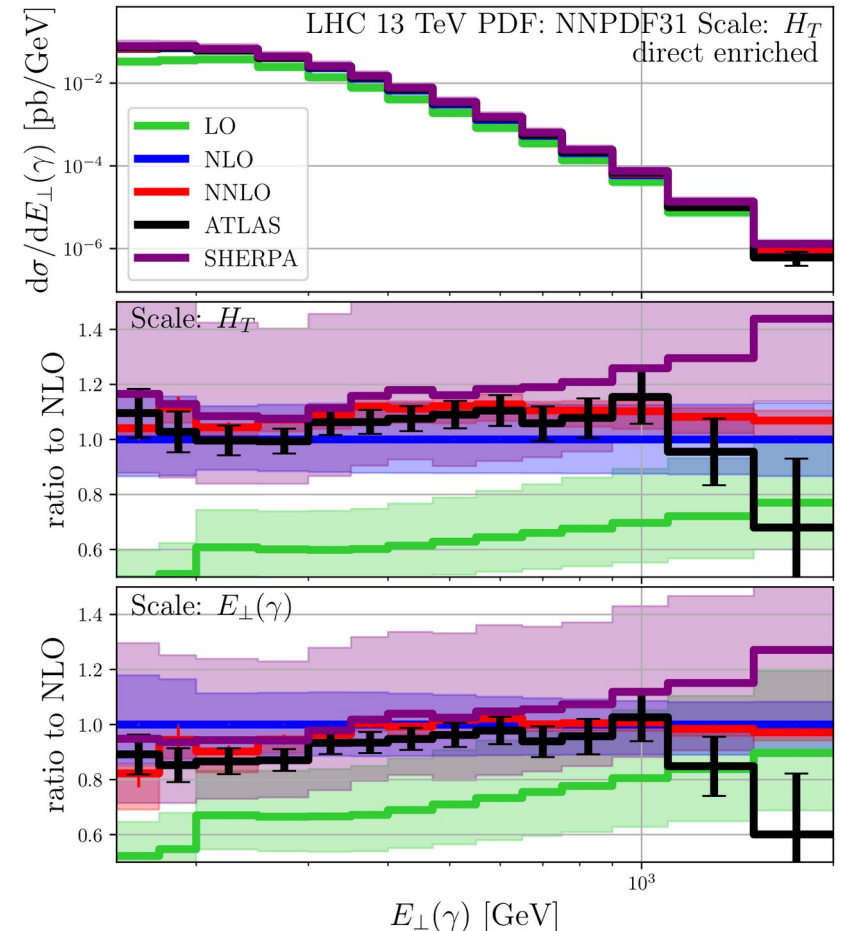

# Inclusive vs. direct vs. fragmentation

## Inclusive

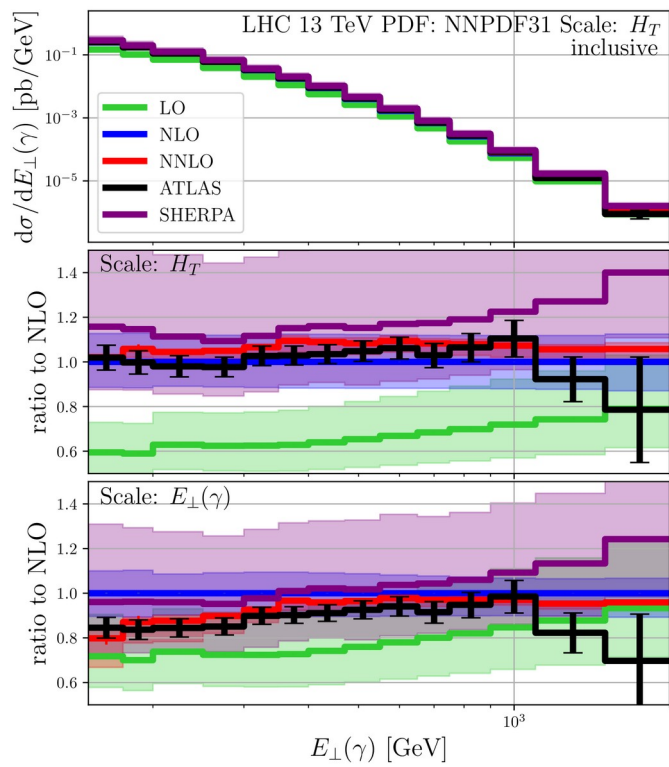

## Direct-enriched

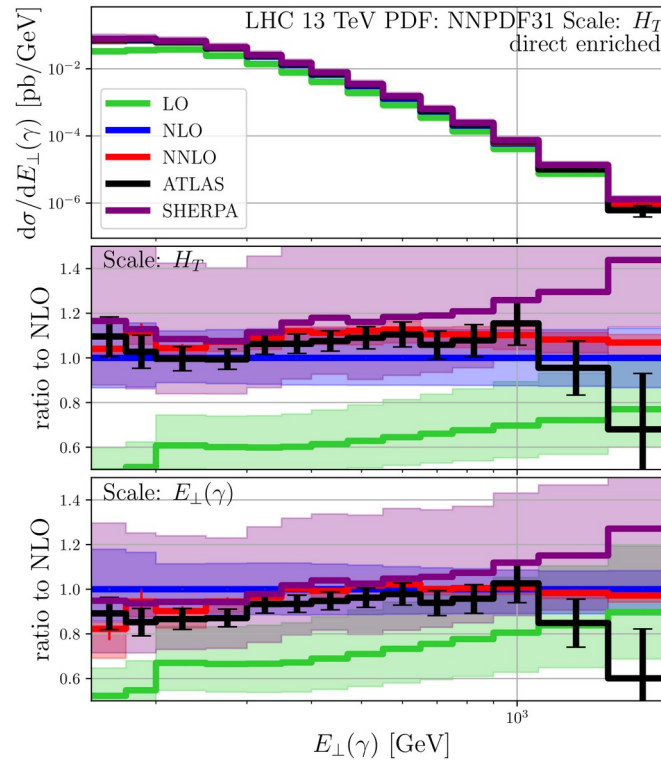

## Fragmentation

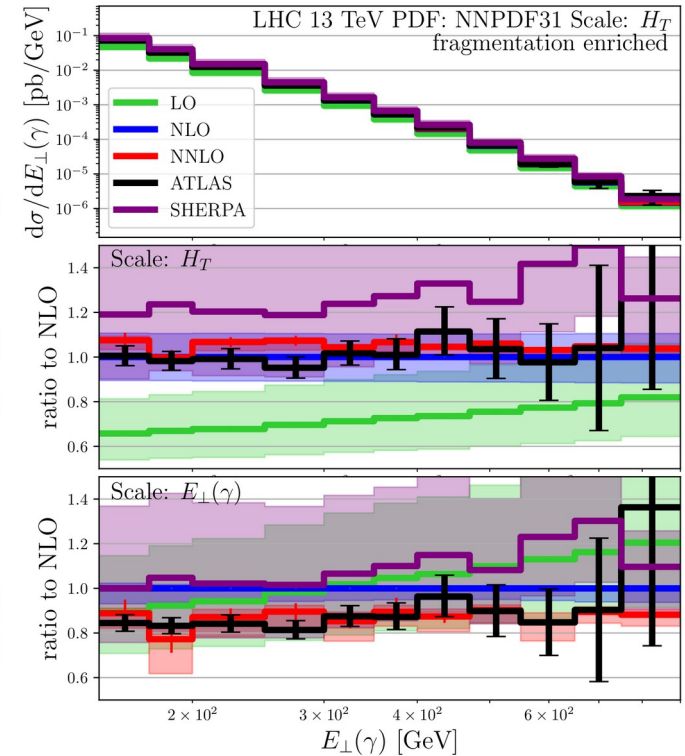

Transverse photon energy

# Scale choice

*Full tree kinematics*

$$\mu_R = \mu_F = H_T = E_{\perp}(\gamma) + p_T(j_1) + p_T(j_2)$$
$$\mu_R = \mu_F = E_{\perp}(\gamma),$$

*Only photon*

## Perturbative convergence

NNLO result similar **but**  $E_{\perp}(\gamma)$

- Larger (negative) NNLO corrections
- Larger scale dependence (for jet obs.)

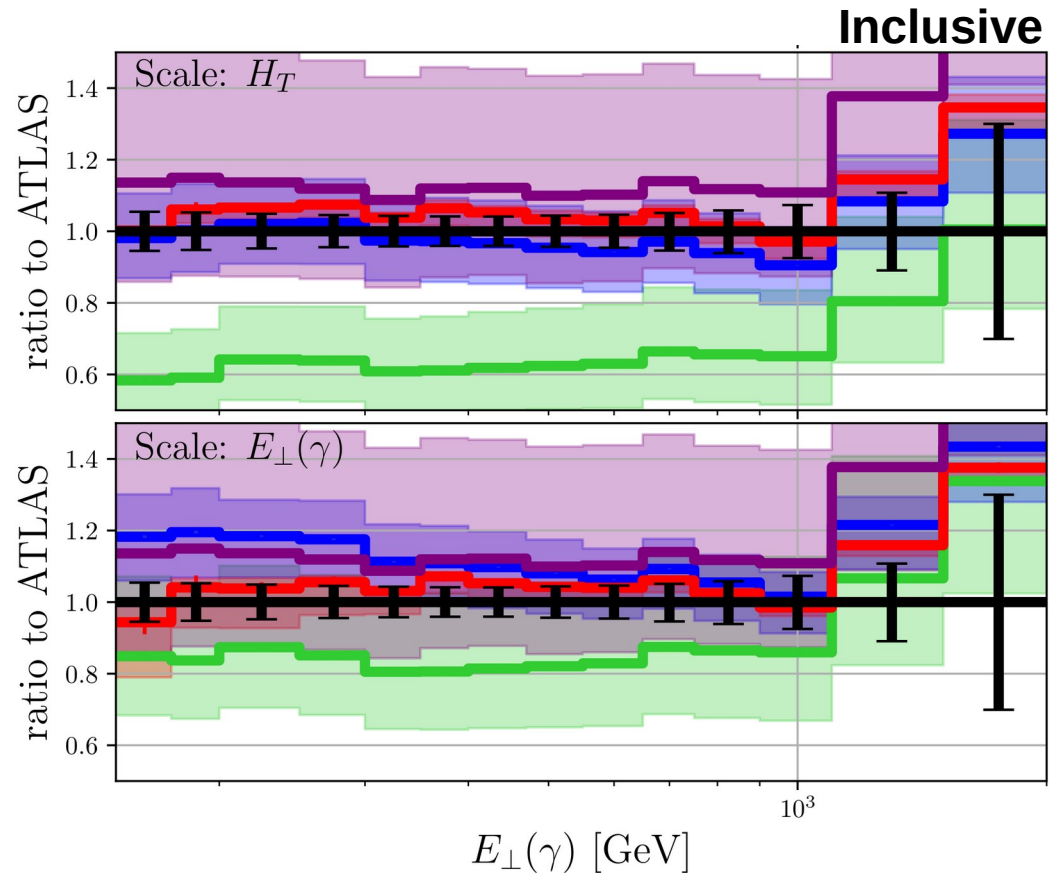

# Scale choice

*Full tree kinematics*

$$\mu_R = \mu_F = H_T = E_\perp(\gamma) + p_T(j_1) + p_T(j_2)$$
$$\mu_R = \mu_F = E_\perp(\gamma),$$

*Only photon*

## Perturbative convergence

NNLO result similar **but**  $E_\perp(\gamma)$

- Larger (negative) NNLO corrections
- Larger scale dependence (for jet obs.)

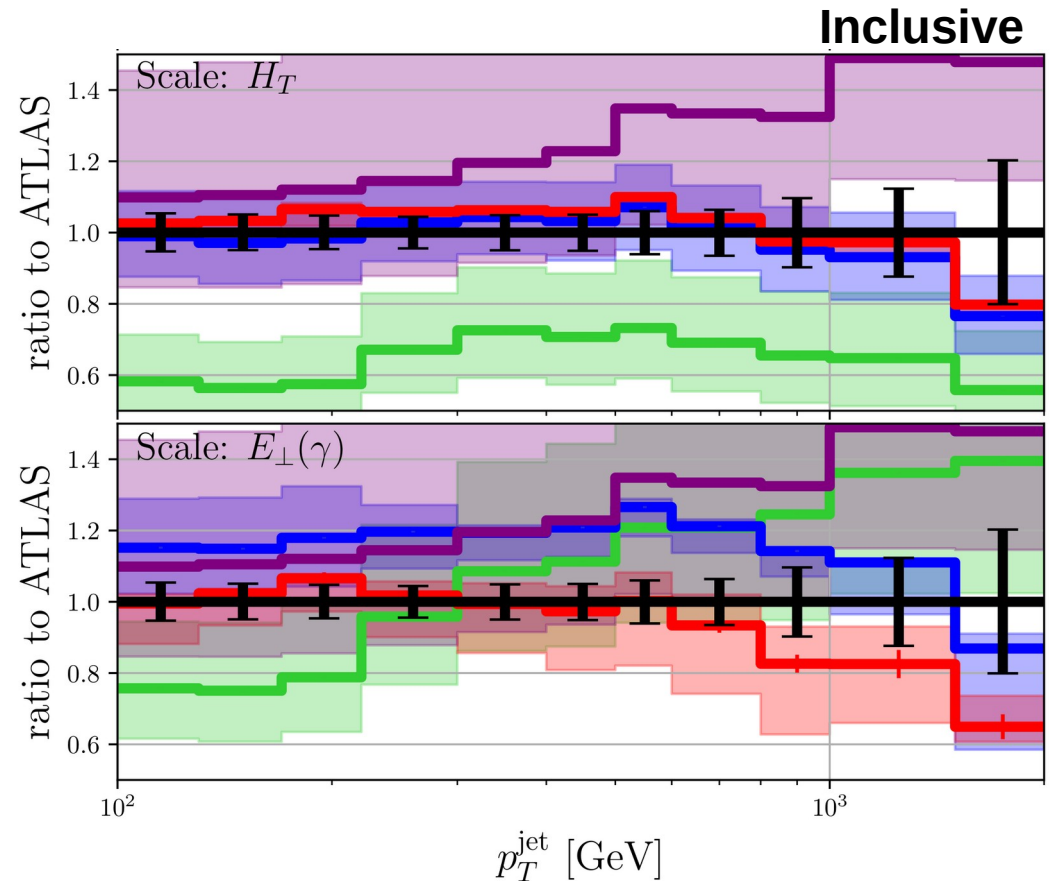

# Scale choice

→  $E_{\perp}(\gamma)$  does not capture relevant scales for  $pp \rightarrow \gamma + 2j$

- Better for “direct” enriched phase space  $p_T(\gamma) > p_T(j_1)$   
 →  $E_{\perp}(\gamma)$  closer to  $H_T = p_T(\gamma) + p_T(j_1) + p_T(j_2)$

**NNLO QCD needed  
for this conclusion**

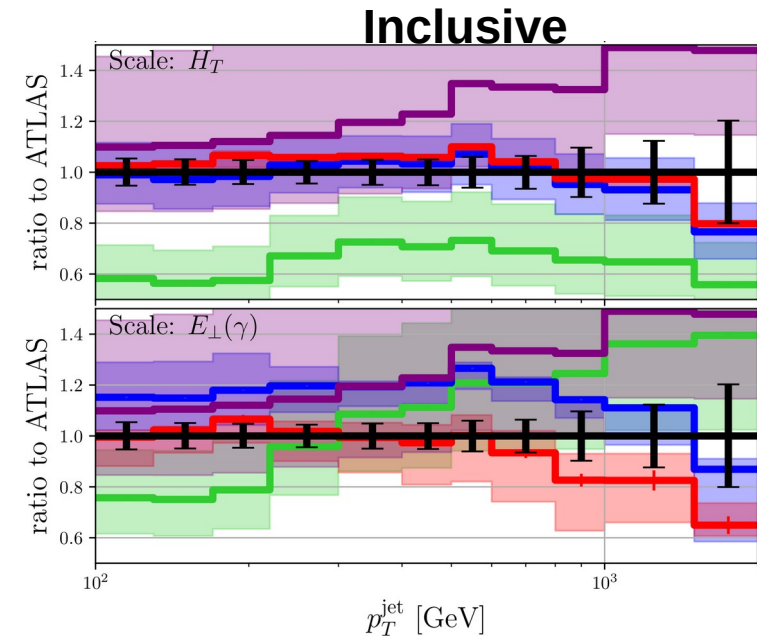
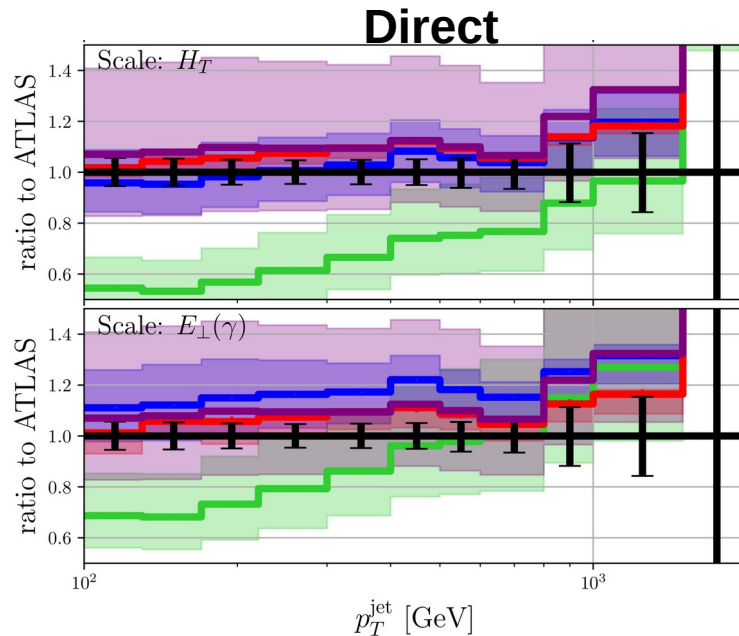

# Take home messages

---

- **Very good description of data** using NNLO QCD
  - Significantly improved theory uncertainty estimates
  - First phenomenological applications: extraction of the strong coupling constant
  
- Completion of **massless 2→3** processes at hadron colliders through NNLO QCD
  - $pp \rightarrow \gamma\gamma\gamma$      $pp \rightarrow \gamma\gamma j$      $pp \rightarrow \gamma jj$      $pp \rightarrow jjj$
  
- Most important bottlenecks:
  - Monte Carlo integration of real radiation contributions → improved methods needed!
  - Two-loop amplitudes  
(including external/internal masses are the current frontier)

# Backup

---

# Hadronic cross section

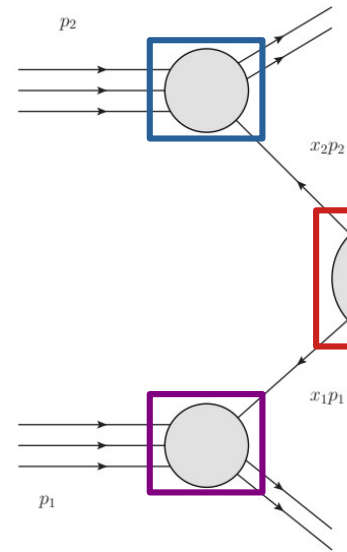

Hadronic X-section: 
$$\sigma_{h_1 h_2 \rightarrow X} = \sum_{ij} \int_0^1 \int_0^1 dx_1 dx_2 \underbrace{\phi_{i/h_1}(x_1, \mu_F^2)}_{\text{parton distribution functions}} \underbrace{\phi_{j/h_2}(x_2, \mu_F^2)}_{\text{parton distribution functions}} \underbrace{\hat{\sigma}_{ij \rightarrow X}(\alpha_s(\mu_R^2), \mu_R^2, \mu_F^2)}_{\text{partonic cross section}}$$

Parton distribution functions

Perturbative expansion of partonic cross section:

$$\hat{\sigma}_{ab \rightarrow X} = \hat{\sigma}_{ab \rightarrow X}^{(0)} + \hat{\sigma}_{ab \rightarrow X}^{(1)} + \hat{\sigma}_{ab \rightarrow X}^{(2)} + \mathcal{O}(\alpha_s^3)$$

The NNLO bit: 
$$\hat{\sigma}_{ab}^{(2)} = \hat{\sigma}_{ab}^{\text{RR}} + \hat{\sigma}_{ab}^{\text{RV}} + \hat{\sigma}_{ab}^{\text{VV}} + \hat{\sigma}_{ab}^{\text{C2}} + \hat{\sigma}_{ab}^{\text{C1}}$$

Double real radiation

$$\hat{\sigma}_{ab}^{\text{RR}} = \frac{1}{2\hat{s}} \int d\Phi_{n+2} \langle \mathcal{M}_{n+2}^{(0)} | \mathcal{M}_{n+2}^{(0)} \rangle F_{n+2}$$

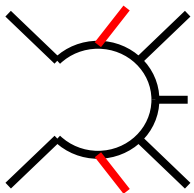

Real/Virtual correction

$$\hat{\sigma}_{ab}^{\text{RV}} = \frac{1}{2\hat{s}} \int d\Phi_{n+1} 2\text{Re} \langle \mathcal{M}_{n+1}^{(0)} | \mathcal{M}_{n+1}^{(1)} \rangle F_{n+1}$$

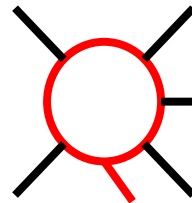

Double virtual corrections

$$\hat{\sigma}_{ab}^{\text{VV}} = \frac{1}{2\hat{s}} \int d\Phi_n \left( 2\text{Re} \langle \mathcal{M}_n^{(0)} | \mathcal{M}_n^{(2)} \rangle + \langle \mathcal{M}_n^{(1)} | \mathcal{M}_n^{(1)} \rangle \right) F_n$$

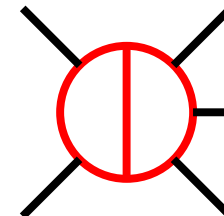



# Partonic cross section beyond LO

Perturbative expansion of partonic cross section:

$$\hat{\sigma}_{ab \rightarrow X} = \hat{\sigma}_{ab \rightarrow X}^{(0)} + \hat{\sigma}_{ab \rightarrow X}^{(1)} + \hat{\sigma}_{ab \rightarrow X}^{(2)} + \mathcal{O}(\alpha_s^3)$$

Contributions with different multiplicities and # convolutions:

$$\hat{\sigma}_{ab}^{(2)} = \hat{\sigma}_{ab}^{\text{RR}} + \hat{\sigma}_{ab}^{\text{RV}} + \hat{\sigma}_{ab}^{\text{VV}} + \hat{\sigma}_{ab}^{\text{C2}} + \hat{\sigma}_{ab}^{\text{C1}}$$



Each term separately IR divergent. But sum is:

→ finite

→ regularization scheme independent

Considering CDR ( $d = 4 - 2\epsilon$ ):

→ Laurent expansion:

$$\hat{\sigma}_{ab}^{\text{C}} = \sum_{i=-4}^0 c_i \epsilon^i + \mathcal{O}(\epsilon)$$

$$\hat{\sigma}_{ab}^{\text{RR}} = \frac{1}{2\hat{s}} \int d\Phi_{n+2} \langle \mathcal{M}_{n+2}^{(0)} | \mathcal{M}_{n+2}^{(0)} \rangle F_{n+2}$$

$$\hat{\sigma}_{ab}^{\text{RV}} = \frac{1}{2\hat{s}} \int d\Phi_{n+1} 2\text{Re} \langle \mathcal{M}_{n+1}^{(0)} | \mathcal{M}_{n+1}^{(1)} \rangle F_{n+1}$$

$$\hat{\sigma}_{ab}^{\text{VV}} = \frac{1}{2\hat{s}} \int d\Phi_n \left( 2\text{Re} \langle \mathcal{M}_n^{(0)} | \mathcal{M}_n^{(2)} \rangle + \langle \mathcal{M}_n^{(1)} | \mathcal{M}_n^{(1)} \rangle \right) F_n$$

$$\hat{\sigma}_{ab}^{\text{C1}} = (\text{single convolution}) F_{n+1}$$

$$\hat{\sigma}_{ab}^{\text{C2}} = (\text{double convolution}) F_n$$

# Sector decomposition I

Considering working in CDR:

→ Virtuals are usually done in this regularization

→ Real radiation:

→ Very difficult integrals, analytical impractical (except very simple cases)!

→ Numerics not possible, integrals are divergent:  $\varepsilon$ -poles!

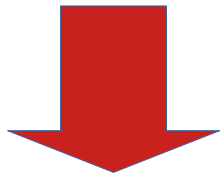

How to extract these poles? → Sector decomposition!

**Divide and conquer** the phase space:

$$1 = \sum_{i,j} \left[ \sum_k \mathcal{S}_{ij,k} + \sum_{k,l} \mathcal{S}_{i,k;j,l} \right] \quad \longrightarrow \quad \hat{\sigma}_{ab}^{\text{RR}} = \frac{1}{2\hat{s}} \int d\Phi_{n+2} \sum_{i,j} \left[ \sum_k \mathcal{S}_{ij,k} + \sum_{k,l} \mathcal{S}_{i,k;j,l} \right] \langle \mathcal{M}_{n+2}^{(0)} | \mathcal{M}_{n+2}^{(0)} \rangle_{\text{F}_{n+2}}$$

# Sector decomposition II

Divide and conquer the phase space:

→ Each  $\mathcal{S}_{ij,k}/\mathcal{S}_{i,k;j,l}$  has simpler divergences.

appearing as  $1/s_{ijk}$   $1/s_{ik}/s_{jl}$

Soft and collinear (w.r.t parton k,l) of partons i and j

→ Parametrization w.r.t. reference parton:

$$\hat{\eta}_i = \frac{1}{2}(1 - \cos \theta_{ir}) \in [0, 1] \quad \hat{\xi}_i = \frac{u_i^0}{u_{\max}^0} \in [0, 1]$$

→ Subdivide to factorize divergences

$$s_{u_1 u_2 k} = (p_k + u_1 + u_2)^2 \sim \hat{\eta}_1 u_1^0 + \hat{\eta}_2 u_2^0 + \hat{\eta}_3 u_1^0 u_2^0$$

→ double soft factorization:

$$\theta(u_1^0 - u_2^0) + \theta(u_2^0 - u_1^0)$$

→ triple collinear factorization

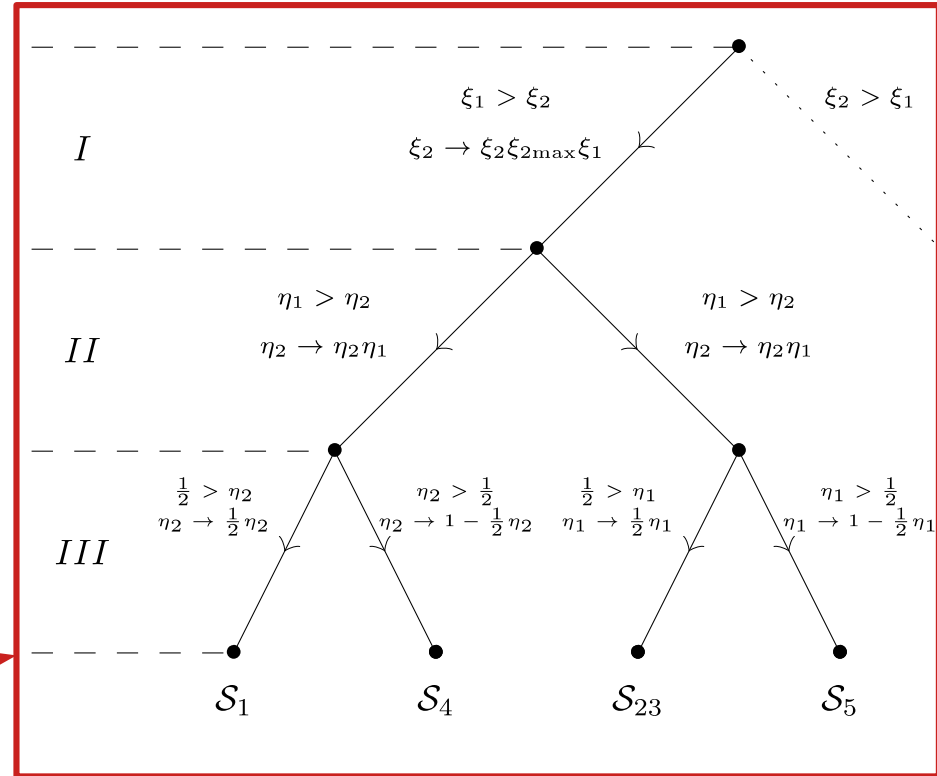

[Czakon'10, Caola'17]

# Sector decomposition III

Factorized singular limits in each sector:

$$\frac{1}{2\hat{s}} \int d\Phi_{n+2} \mathcal{S}_{kl,m} \langle \mathcal{M}_{n+2}^{(0)} | \mathcal{M}_{n+2}^{(0)} \rangle F_{n+2} = \sum_{\text{sub-sec.}} \int d\Phi_n \prod dx_i \underbrace{x_i^{-1-b_i\epsilon}}_{\text{singular}} d\tilde{\mu}(\{x_i\}) \underbrace{\prod x_i^{a_i+1} \langle \mathcal{M}_{n+2} | \mathcal{M}_{n+2} \rangle}_{\text{regular}} F_{n+2}$$

Regularization of divergences:

$$x^{-1-b\epsilon} = \underbrace{\frac{-1}{b\epsilon}}_{\text{pole term}} + \underbrace{[x^{-1-b\epsilon}]_+}_{\text{reg. + sub.}} \quad \int_0^1 dx [x^{-1-b\epsilon}]_+ f(x) = \int_0^1 \frac{f(x) - f(0)}{x^{1+b\epsilon}}$$

# Finite NNLO cross section

$$\hat{\sigma}_{ab}^{RR} = \frac{1}{2\hat{s}} \int d\Phi_{n+2} \langle \mathcal{M}_{n+2}^{(0)} | \mathcal{M}_{n+2}^{(0)} \rangle F_{n+2}$$

$$\hat{\sigma}_{ab}^{C1} = (\text{single convolution}) F_{n+1}$$

$$\hat{\sigma}_{ab}^{RV} = \frac{1}{2\hat{s}} \int d\Phi_{n+1} 2\text{Re} \langle \mathcal{M}_{n+1}^{(0)} | \mathcal{M}_{n+1}^{(1)} \rangle F_{n+1}$$

$$\hat{\sigma}_{ab}^{C2} = (\text{double convolution}) F_n$$

$$\hat{\sigma}_{ab}^{VV} = \frac{1}{2\hat{s}} \int d\Phi_n \left( 2\text{Re} \langle \mathcal{M}_n^{(0)} | \mathcal{M}_n^{(2)} \rangle + \langle \mathcal{M}_n^{(1)} | \mathcal{M}_n^{(1)} \rangle \right) F_n$$



sector decomposition and master formula

$$x^{-1-b\epsilon} = \underbrace{\frac{-1}{b\epsilon}}_{\text{pole term}} + \underbrace{[x^{-1-b\epsilon}]_+}_{\text{reg. + sub.}}$$

$$(\sigma_F^{RR}, \sigma_{SU}^{RR}, \sigma_{DU}^{RR}) \quad (\sigma_F^{RV}, \sigma_{SU}^{RV}, \sigma_{DU}^{RV}) \quad (\sigma_F^{VV}, \sigma_{DU}^{VV}, \sigma_{FR}^{VV}) \quad (\sigma_{SU}^{C1}, \sigma_{DU}^{C1}) \quad (\sigma_{DU}^{C2}, \sigma_{FR}^{C2})$$



re-arrangement of terms  $\rightarrow$  4-dim. formulation [Czakon'14, Czakon'19]

$$\underline{(\sigma_F^{RR})} \quad \underline{(\sigma_F^{RV})} \quad \underline{(\sigma_F^{VV})} \quad \underline{(\sigma_{SU}^{RR}, \sigma_{SU}^{RV}, \sigma_{SU}^{C1})} \quad \underline{(\sigma_{DU}^{RR}, \sigma_{DU}^{RV}, \sigma_{DU}^{VV}, \sigma_{DU}^{C1}, \sigma_{DU}^{C2})} \quad \underline{(\sigma_{FR}^{RV}, \sigma_{FR}^{VV}, \sigma_{FR}^{C2})}$$

separately finite:  $\epsilon$  poles cancel

# C++ framework

---

- Formulation allows efficient algorithmic implementation
- **High degree of automation:**
  - Partonic processes (taking into account all symmetries)
  - Sectors and subtraction terms
  - Interfaces to Matrix-element providers:  
AvH, OpenLoops, Recola, NJET, HardCoded  
→ Only two-loop matrix elements required
- **Broad range of applications** through additional facilities:
  - Narrow-Width & Double-Pole Approximation
  - Fragmentation
  - Polarised intermediate massive bosons
  - (Partial) Unweighting → Event generation for **HighTEA**
  - Interfaces: FastNLO, FastJet

# Improved phase space generation

New phase space parametrization:

Minimization of # of different subtraction kinematics in each sector

Mapping from  $n+2$  to  $n$  particle phase space:  $\{P, r_j, u_k\} \rightarrow \{\tilde{P}, \tilde{r}_j\}$

Requirements:

- Keep direction of reference  $r$  fixed
- Invertible for fixed  $u_i$  :  $\{\tilde{P}, \tilde{r}_j, u_k\} \rightarrow \{P, r_j, u_k\}$
- Preserve Born invariant mass:  $q^2 = \tilde{q}^2$ ,  $\tilde{q} = \tilde{P} - \sum_{j=1}^{n_{fr}} \tilde{r}_j$

Main steps:

- Generate Born configuration
- Generate unresolved partons  $u_i$
- Rescale reference momentum  $r = x\tilde{r}$
- Boost non-reference momenta of the Born configuration

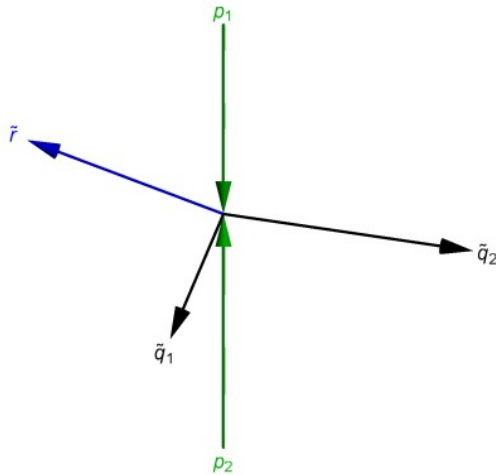

# Improved phase space generation

New phase space parametrization:

Minimization of # of different subtraction kinematics in each sector

Mapping from  $n+2$  to  $n$  particle phase space:  $\{P, r_j, u_k\} \rightarrow \{\tilde{P}, \tilde{r}_j\}$

Requirements:

- Keep direction of reference  $r$  fixed
- Invertible for fixed  $u_i$  :  $\{\tilde{P}, \tilde{r}_j, u_k\} \rightarrow \{P, r_j, u_k\}$
- Preserve Born invariant mass:  $q^2 = \tilde{q}^2$ ,  $\tilde{q} = \tilde{P} - \sum_{j=1}^{n_{fr}} \tilde{r}_j$

Main steps:

- Generate Born configuration
- Generate unresolved partons  $u_i$
- Rescale reference momentum  $r = x\tilde{r}$
- Boost non-reference momenta of the Born configuration

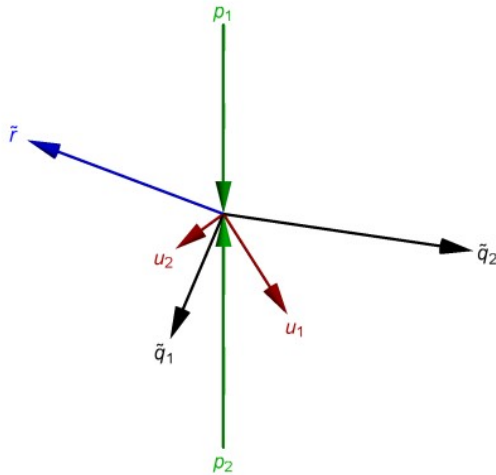



# Improved phase space generation

New phase space parametrization:

Minimization of # of different subtraction kinematics in each sector

Mapping from  $n+2$  to  $n$  particle phase space:  $\{P, r_j, u_k\} \rightarrow \{\tilde{P}, \tilde{r}_j\}$

Requirements:

- Keep direction of reference  $r$  fixed
- Invertible for fixed  $u_i$  :  $\{\tilde{P}, \tilde{r}_j, u_k\} \rightarrow \{P, r_j, u_k\}$
- Preserve Born invariant mass:  $q^2 = \tilde{q}^2$ ,  $\tilde{q} = \tilde{P} - \sum_{j=1}^{n_{fr}} \tilde{r}_j$

Main steps:

- Generate Born configuration
- Generate unresolved partons  $u_i$
- Rescale reference momentum  $r = x\tilde{r}$
- Boost non-reference momenta of the Born configuration

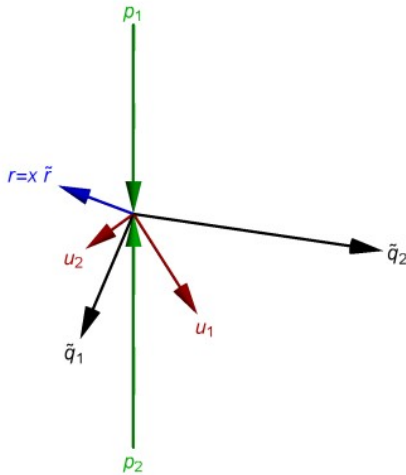

# Improved phase space generation

New phase space parametrization:

Minimization of # of different subtraction kinematics in each sector

Mapping from  $n+2$  to  $n$  particle phase space:  $\{P, r_j, u_k\} \rightarrow \{\tilde{P}, \tilde{r}_j\}$

Requirements:

- Keep direction of reference  $r$  fixed
- Invertible for fixed  $u_i$  :  $\{\tilde{P}, \tilde{r}_j, u_k\} \rightarrow \{P, r_j, u_k\}$
- Preserve Born invariant mass:  $q^2 = \tilde{q}^2$ ,  $\tilde{q} = \tilde{P} - \sum_{j=1}^{n_{fr}} \tilde{r}_j$

Main steps:

- Generate Born configuration
- Generate unresolved partons  $u_i$
- Rescale reference momentum  $r = x\tilde{r}$
- Boost non-reference momenta of the Born configuration

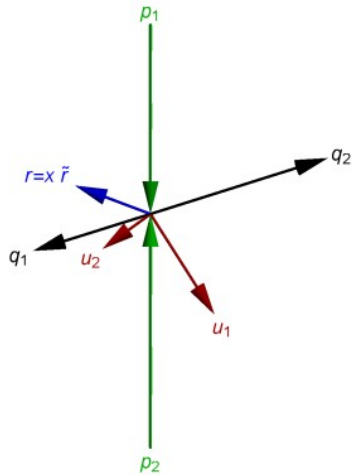

# Systematic Uncertainties TEEC

## Experimental uncertainties

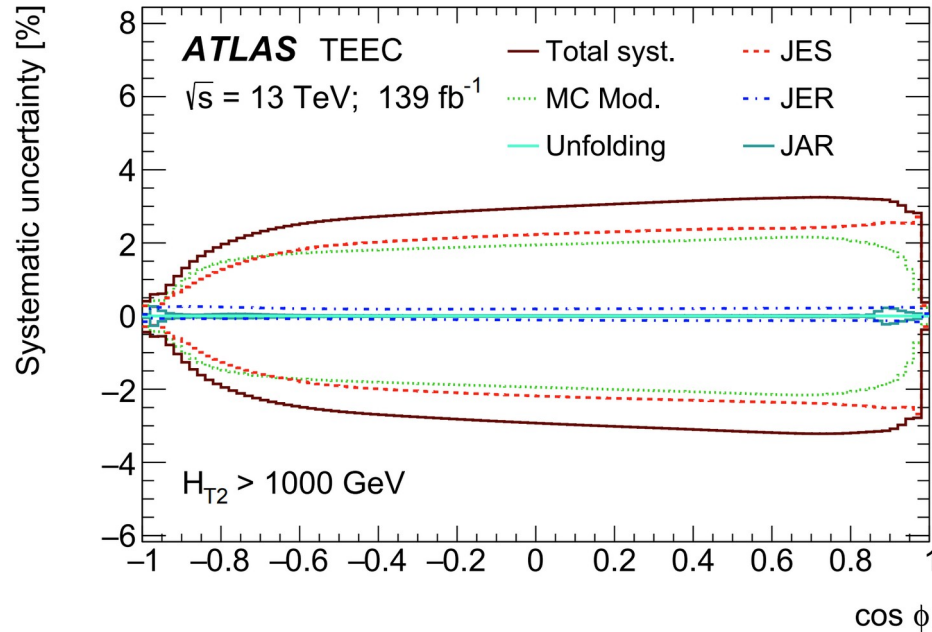

## Theory uncertainties

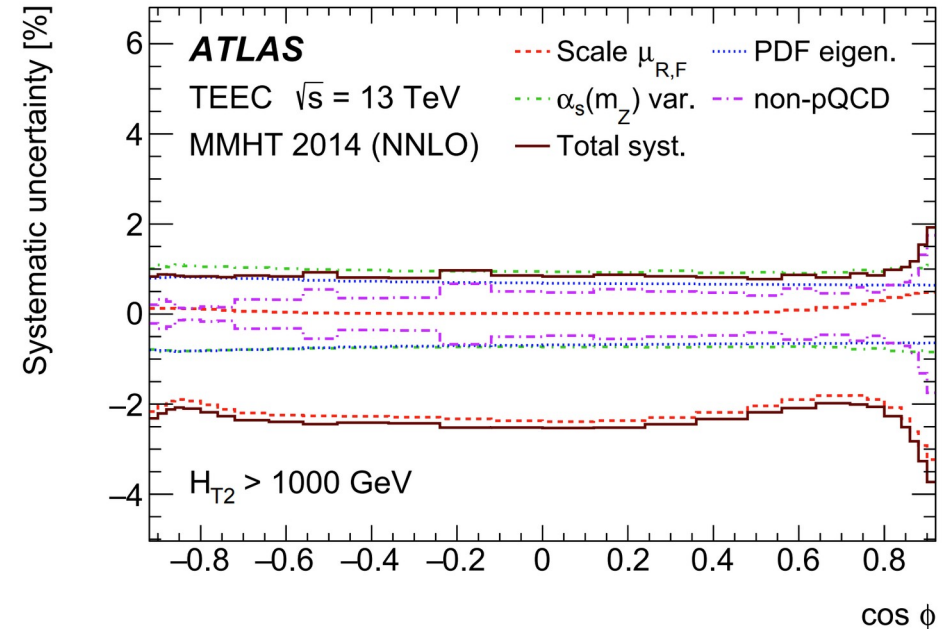

Scale dependence is the dominating uncertainty  $\rightarrow$  **NNLO QCD required to match exp.**

# Strong coupling dependence

## Thrust

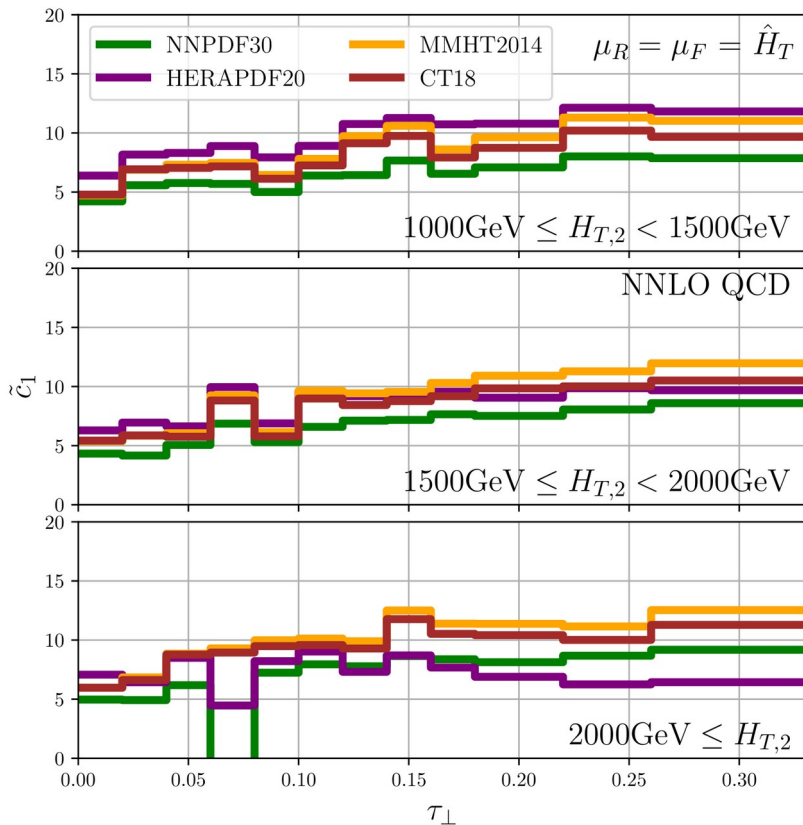

## TEEC

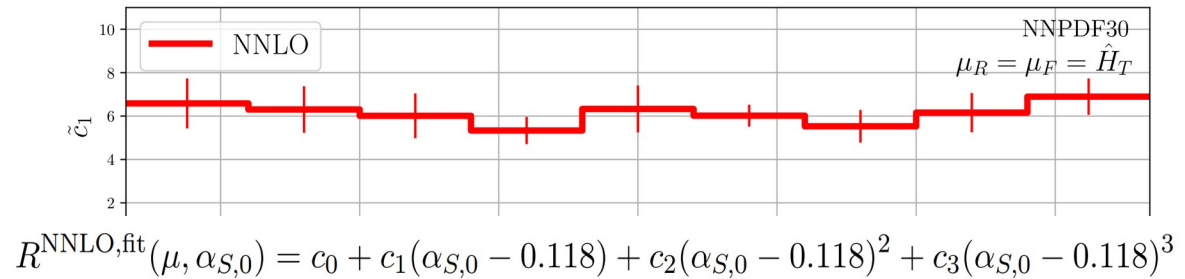

$$R^{\text{NNLO,fit}}(\mu, \alpha_{S,0}) = c_0 + c_1(\alpha_{S,0} - 0.118) + c_2(\alpha_{S,0} - 0.118)^2 + c_3(\alpha_{S,0} - 0.118)^3$$

mostly linear dependence

Visualisation of  $\alpha_S$  dependence

$$\tilde{c}_1 = \frac{c_1}{R^{\text{NNLO}}(\alpha_{S,0} = 0.118)}$$

For comparison:  
scale dependence (dominant theory uncertainty)

- TEEC (  $H_{T,2} > 1 \text{ TeV}$  ) : ~2%
  - Thrust : ~3-5 %
- }  **$O(1\%)$  sensitivity**

# $\alpha_s$ from TEEC @ NNLO by ATLAS

[ATLAS 2301.09351]

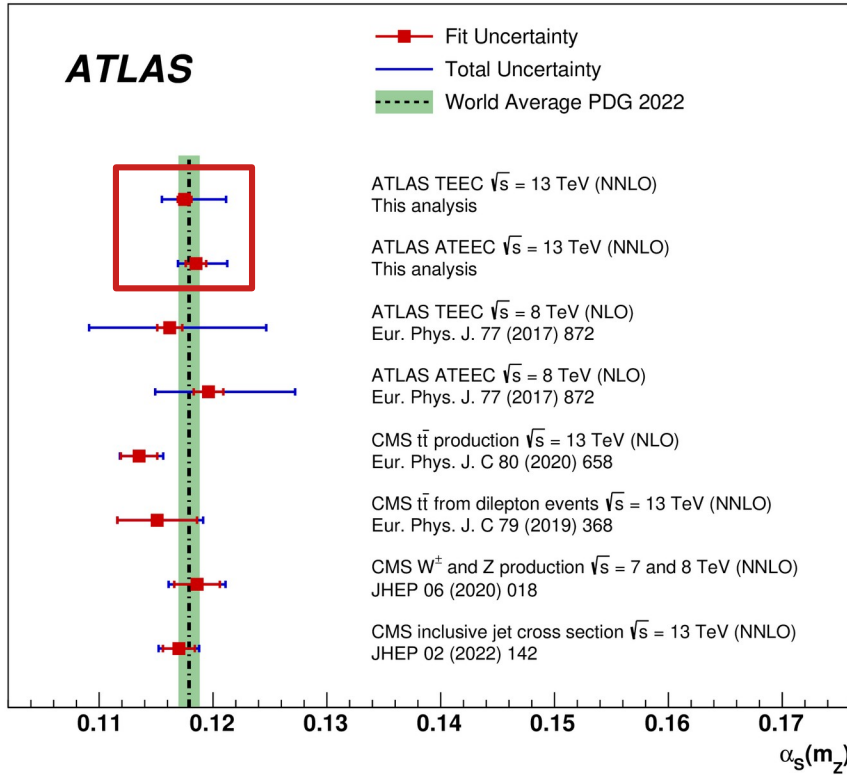

- NNLO QCD extraction from multi-jets  $\rightarrow$  will contribute to **PDG for the first time**
- **Significant improvement to 8 TeV**  $\rightarrow$  driven by **NNLO QCD corrections**
- Individual precision large but comparable to top or jets-data.
- However: extraction at high energy scales

# Using the running of $\alpha_S$ to probe NP

[Llorente, Nachman 1807.00894]

Indirect constraints to NP through modified running:

$$\alpha_s(Q) = \frac{1}{\beta_0 \log z} \left[ 1 - \frac{\beta_1 \log(\log z)}{\beta_0^2 \log z} \right]; \quad z = \frac{Q^2}{\Lambda_{\text{QCD}}^2}$$

$$\beta_0 = \frac{1}{4\pi} \left( 11 - \frac{2}{3}n_f - \frac{4}{3}n_X T_X \right)$$

$$\beta_1 = \frac{1}{(4\pi)^2} \left[ 102 - \frac{38}{3}n_f - 20n_X T_X \left( 1 + \frac{C_X}{5} \right) \right]$$

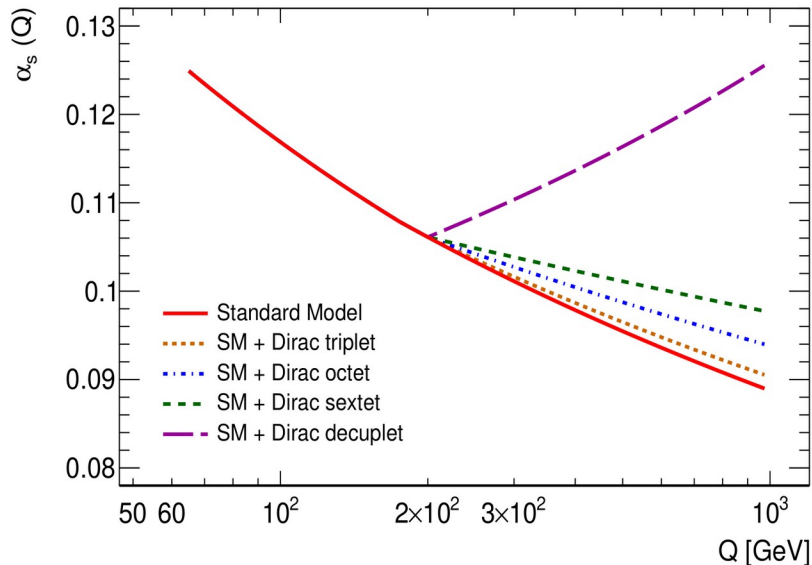

ATLAS  
TEEC @ 7 TeV  
data

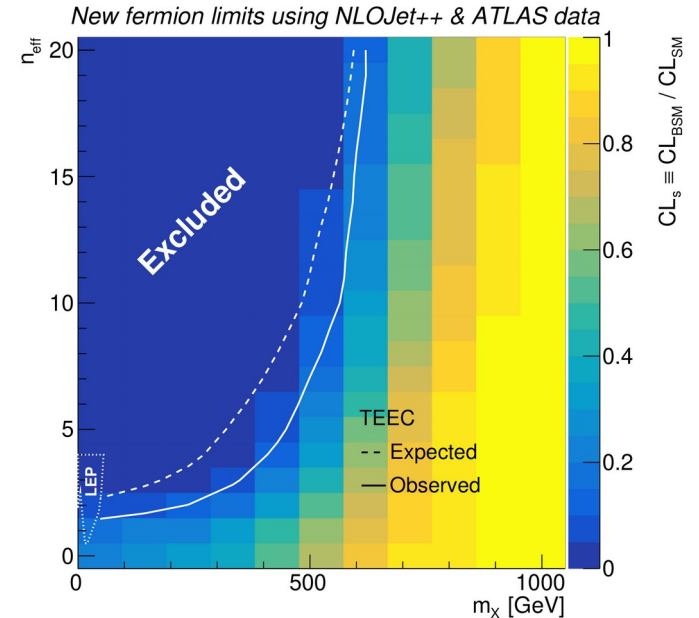

Update with TEEC@13 TeV  
→ much improved bounds

# ... or 'new' SM dynamics

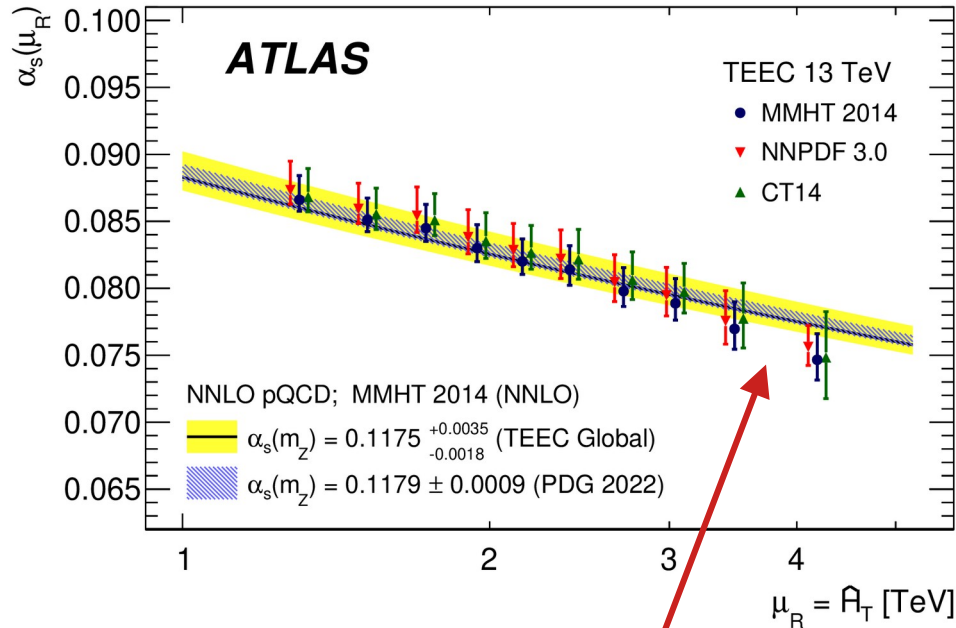

Systematic slope  
→ New physics?

## Possible SM explanations

- Residual PDF effects → high  $x, Q^2$  ?
- EW corrections?
- Maybe effect from LC approximation in two-loop ME?

$$\begin{aligned} \mathcal{R}^{(2)}(\mu_R^2) &= 2 \operatorname{Re} \left[ \mathcal{M}^{\dagger(0)} \mathcal{F}^{(2)} \right] (\mu_R^2) + |\mathcal{F}^{(1)}|^2(\mu_R^2) \\ &\equiv \mathcal{R}^{(2)}(s_{12}) + \sum_{i=1}^4 c_i \ln^i \left( \frac{\mu_R^2}{s_{12}} \right) \\ \mathcal{R}^{(2)}(s_{12}) &\approx \mathcal{R}^{(2)l.c.}(s_{12}) \end{aligned}$$

- Experimental systematics?
- Resummation?

**Either case interesting!**

# Photon isolation

## Hard cone

- Experimental hard cone:

$$E_{\perp}(r) \leq E_{\perp\text{max}} = 0.0042 E_{\perp}(\gamma) + 10 \text{ GeV} \quad \text{for } r \leq R_{\text{max}} = 0.4$$

- Theory perspective:

Not collinear safe in perturbative QCD  
due to  $q \rightarrow q\gamma$  splittings

→ Non-vanishing fragmentation contribution  
(NNLO QCD with frag. [[2201.06982](#)][[2205.01516](#)])

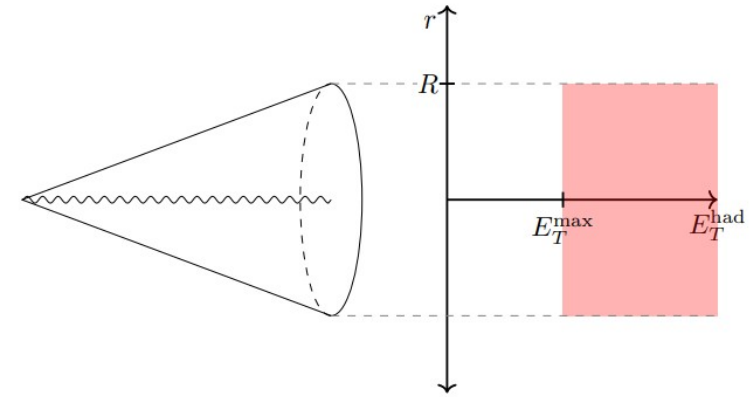

Credit: Marius Hofer (talk@SM@LHC22)

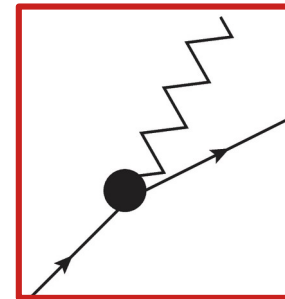



# Photon isolation

## Smooth cone

- by Frixione [[hep-ph/9801442](#)]

$$E_{\perp}(r) \leq E_{\perp\max}(r) = 0.1 E_{\perp}(\gamma) \left( \frac{1 - \cos(r)}{1 - \cos(R_{\max})} \right)^2 \quad \text{for } r \leq R_{\max} = 0.1$$

- Theoretically convenient
- Removes fragmentation contribution
- Experimentally limited by detector resolution

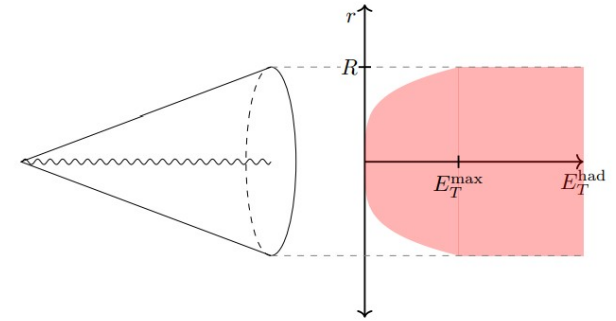

## Hybrid cone

- [[1611.07226](#)][[2205.01516](#)]
- Combines smooth & hard cone
- Fair approx. to hard cone [[2205.01516](#)]

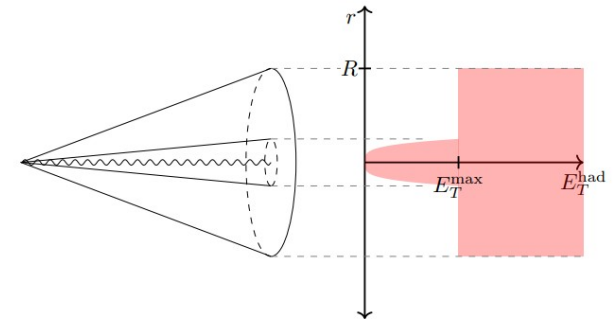

Credit: Marius Hofer (talk@SM@LHC22)

# Fragmentation contribution

- ATLAS photon requirements (same as for  $pp \rightarrow \gamma + 2j$ )
- Comparison between:
  - “default” NNLO with fragmentation
  - “hybrid” NNLO with hybrid isolation
- Fragmentation contr.
  - $\sim 5\%$  at small  $E_T(\gamma)$
  - $\sim <1\%$  at high  $E_T(\gamma)$

[2205.01516]

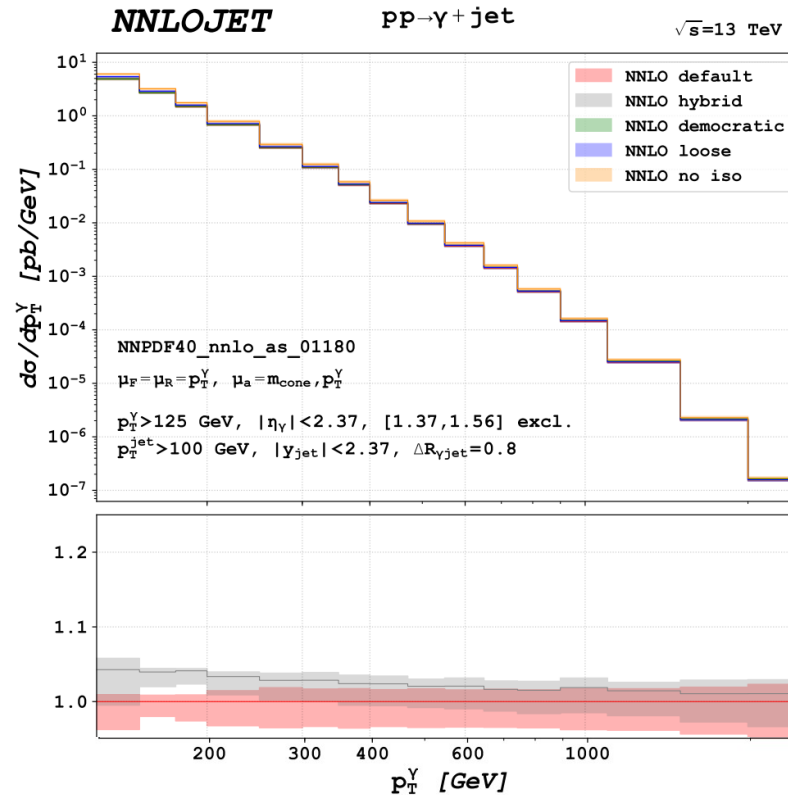

# Missing effects

## Electro-weak corrections

- EW Sudakov logs at high  $E_{\perp}(\gamma)$
- $\sim O(-10\%)$  above 1 TeV
- Further improvement of theory/data

## Fragmentation

- More relevant at small  $E_{\perp}(\gamma)$
- For  $pp \rightarrow \gamma + X$  :  $\sigma(\text{hybrid}) > \sigma(\text{frag.})$
- Inclusion might cure slightly high normalisation

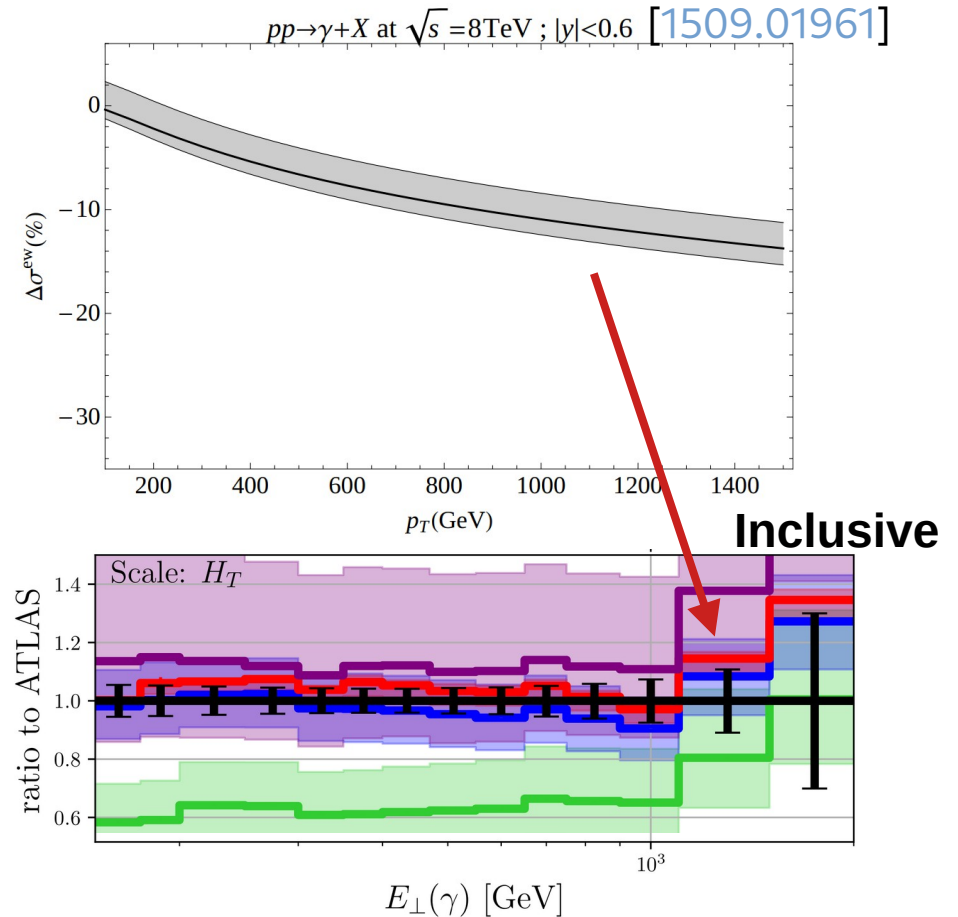

# Missing effects

## Electro-weak corrections

- EW Sudakov logs at high  $E_{\perp}(\gamma)$
- $\sim O(-10\%)$  above 1 TeV
- Further improvement of theory/data

## Fragmentation

- More relevant at small  $E_{\perp}(\gamma)$
- For  $pp \rightarrow \gamma + X$  :  $\sigma(\text{hybrid}) > \sigma(\text{frag.})$
- Inclusion might cure slightly high normalisation

