

Confinement and False Vacuum Decay in Quantum Spin Chains

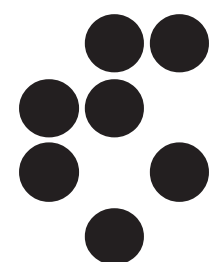

Experiments/Quantum simulators

Rydberg Neutral Atoms

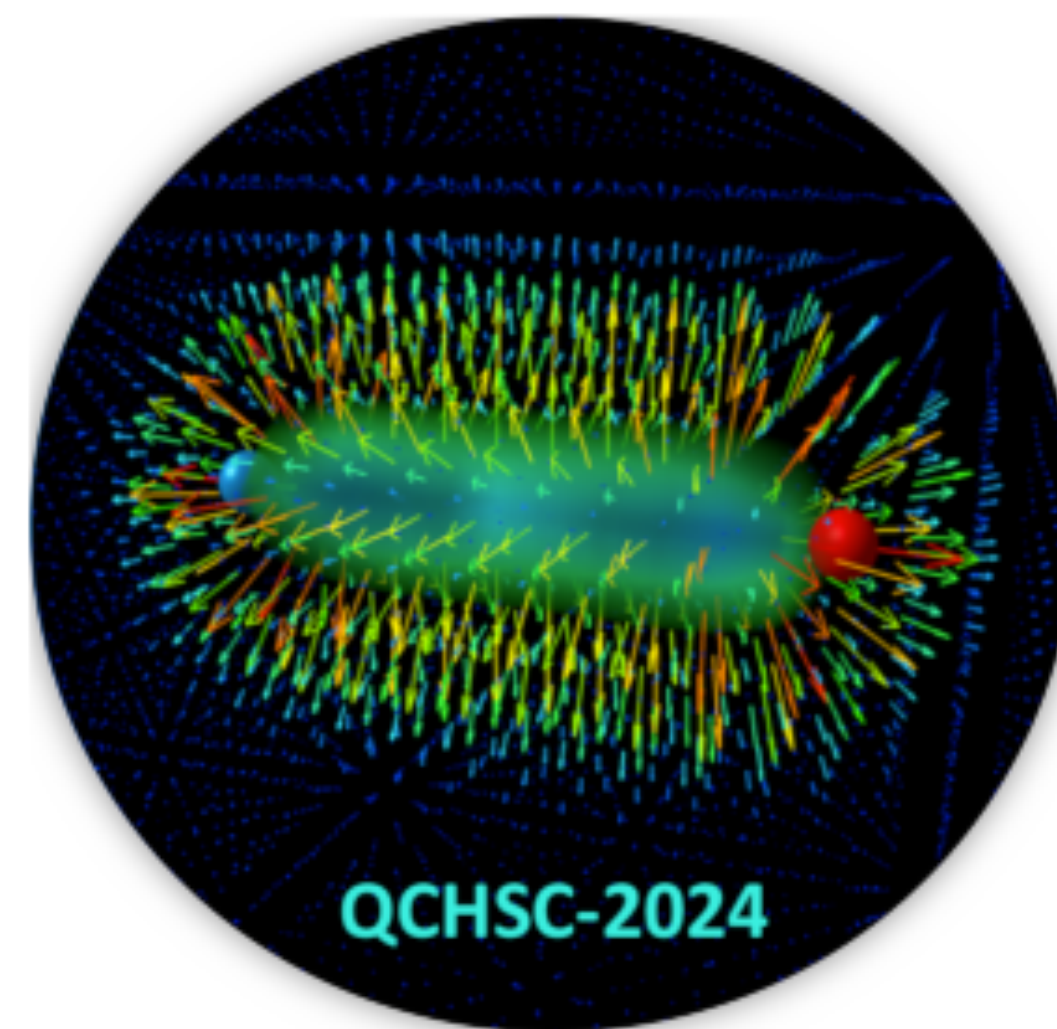
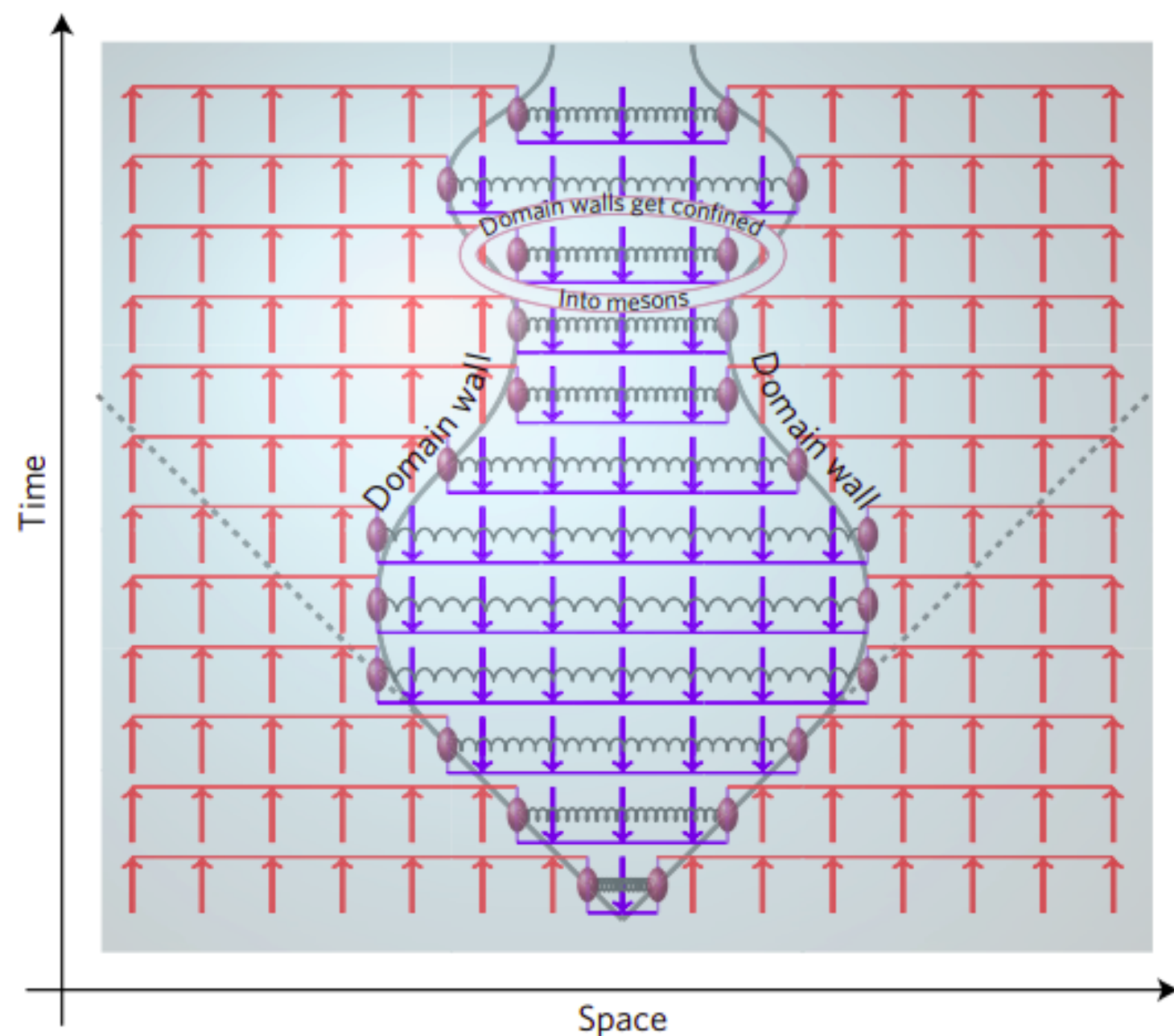
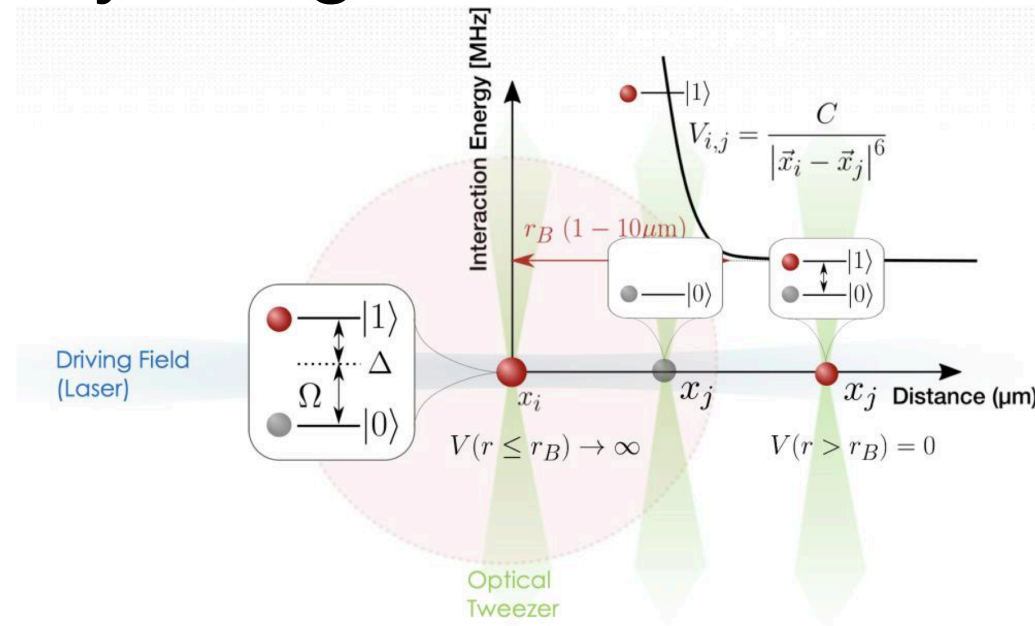

J. Wurtz et al., arXiv:2306.11727

Cryogenic Trapped Ions

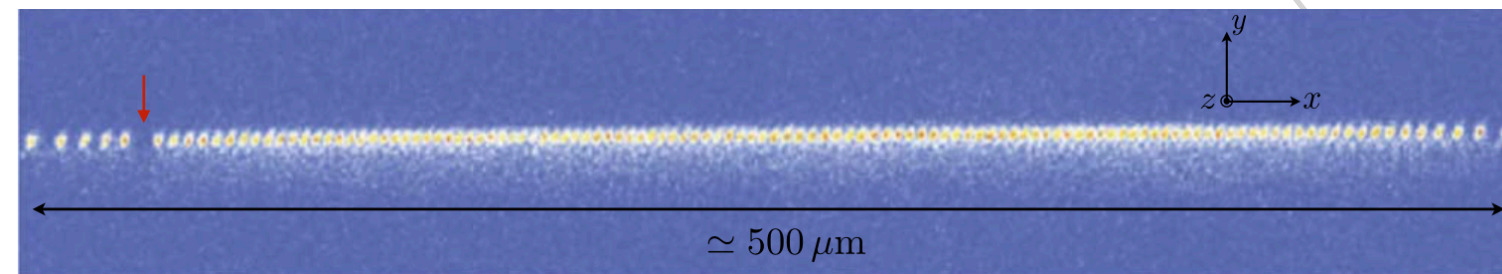

G. Pagano et al., Quantum Sci. Technol. 2019

Superconducting Qubits

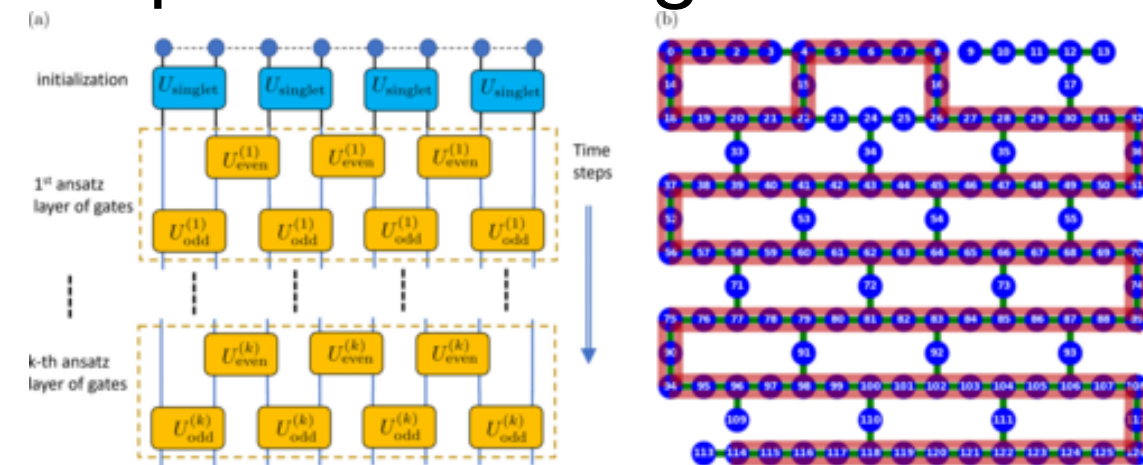

H. Yu, Y. Zhao, Tzu-Chieh Wei, Phys. Rev. Research 2023

Analytical (Integrability, CFT...)

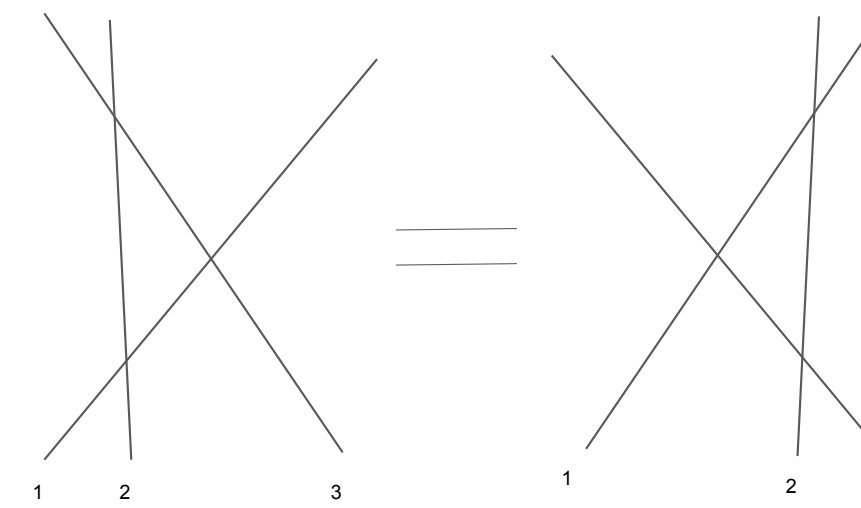

Franchini, Springerlink LNP 940

Quantum Spin Chains

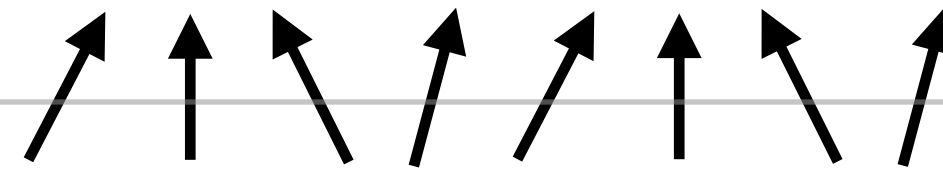

Numerical methods (Tensor Networks, TEBD, DMRG)

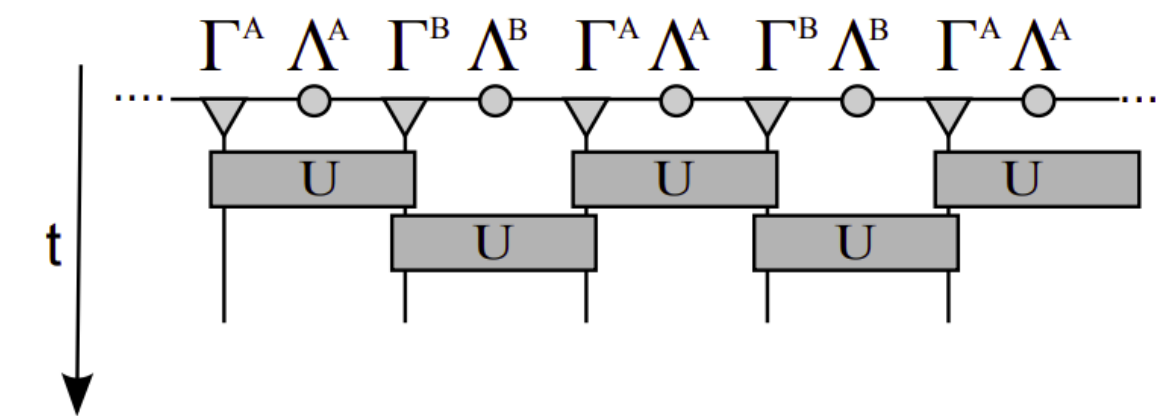

J. Hauschild, F. Pollmann, SciPost Phys. 2018

Key concepts

- 1) Real-time out-of-equilibrium dynamics of many-body systems

Key concepts

- 1) Real-time out-of-equilibrium dynamics of many-body systems
- 2) Isolated systems \leftrightarrow Pure unitary time evolution

Key concepts

- 1) Real-time out-of-equilibrium dynamics of many-body systems
- 2) Isolated systems \leftrightarrow Pure unitary time evolution
- 3) Zero temperature \leftrightarrow No thermal fluctuations

Key concepts

- 1) Real-time out-of-equilibrium dynamics of many-body systems
- 2) Isolated systems \leftrightarrow Pure unitary time evolution
- 3) Zero temperature \leftrightarrow No thermal fluctuations

“Introduction to ‘Quantum Integrability in Out of Equilibrium Systems’”

Calabrese, Essler, Mussardo J. Stat. Mech. 2016

Overview

- 1) The Model: Transverse Field Quantum Ising Chain

Overview

1) The Model: Transverse Field Quantum Ising Chain

2) Confinement:

“Real time confinement following a quantum quench to a non-integrable model”

Kormos, Collura, Takacs, Calabrese, Nature Physics 2017

Overview

1) The Model: Transverse Field Quantum Ising Chain

2) Confinement:

“Real time confinement following a quantum quench to a non-integrable model”

Kormos, Collura, Takaks, Calabrese, Nature Physics 2017

3) False Vacuum Decay:

“False vacuum decay in quantum spin chains”

Lagnese, Surace, Kormos, Calabrese PRB 2021

Overview

1) The Model: Transverse Field Quantum Ising Chain

2) Confinement:

“Real time confinement following a quantum quench to a non-integrable model”

Kormos, Collura, Takaks, Calabrese, Nature Physics 2017

3) False Vacuum Decay:

“False vacuum decay in quantum spin chains”

Lagnese, Surace, Kormos, Calabrese PRB 2021

4) Another Model

The Model

The model: Transverse Field Quantum Ising Chain

Classical Ising: $E = -J \sum_{\langle ij \rangle} s_i s_j$ $s_i \in \{-1, 1\}$

The model: Transverse Field Quantum Ising Chain

Classical Ising: $E = -J \sum_{\langle ij \rangle} s_i s_j \quad s_i \in \{-1, 1\}$

$s_i \rightarrow \sigma_i^z$

1+1 D Quantum Ising: $H = -J \sum_i \left(\sigma_i^z \sigma_{i+1}^z - h_x \sigma_i^x \right)$

The model: Transverse Field Quantum Ising Chain

Classical Ising: $E = -J \sum_{\langle ij \rangle} s_i s_j$ $s_i \in \{-1, 1\}$

$s_i \rightarrow \sigma_i^z$

Pauli Operators

1+1 D Quantum Ising: $H = -J \sum_i \left(\sigma_i^z \sigma_{i+1}^z - h_x \sigma_i^x \right)$ Transverse Field \leftrightarrow Quantum Fluctuations

The model: Transverse Field Quantum Ising Chain

Classical Ising: $E = -J \sum_{\langle ij \rangle} s_i s_j$ $s_i \in \{-1, 1\}$

$s_i \rightarrow \sigma_i^z$

Pauli Operators

1+1 D Quantum Ising: $H = -J \sum_i \left(\sigma_i^z \sigma_{i+1}^z - h_x \sigma_i^x \right)$ Transverse Field \leftrightarrow Quantum Fluctuations

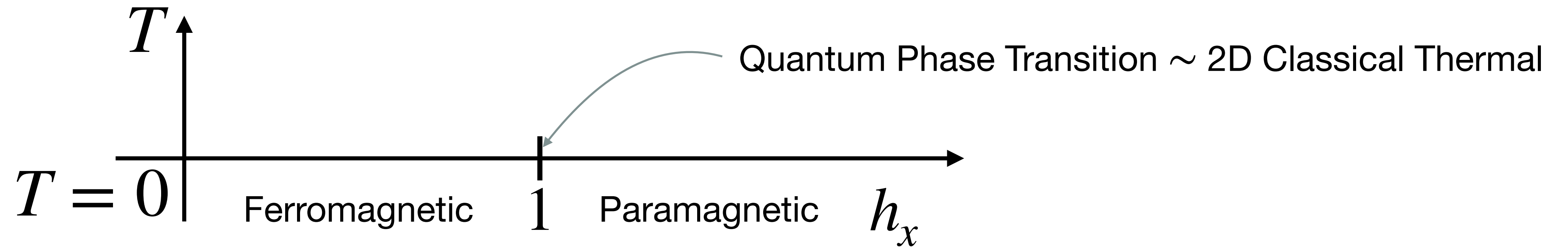

The model: Transverse Field Quantum Ising Chain

$$H = - \sum_i \sigma_i^z \sigma_{i+1}^z - h_x \sigma_i^x$$

$|h_x| < 1 \Rightarrow$ Two **Degenerate** Ferromagnetic ground states

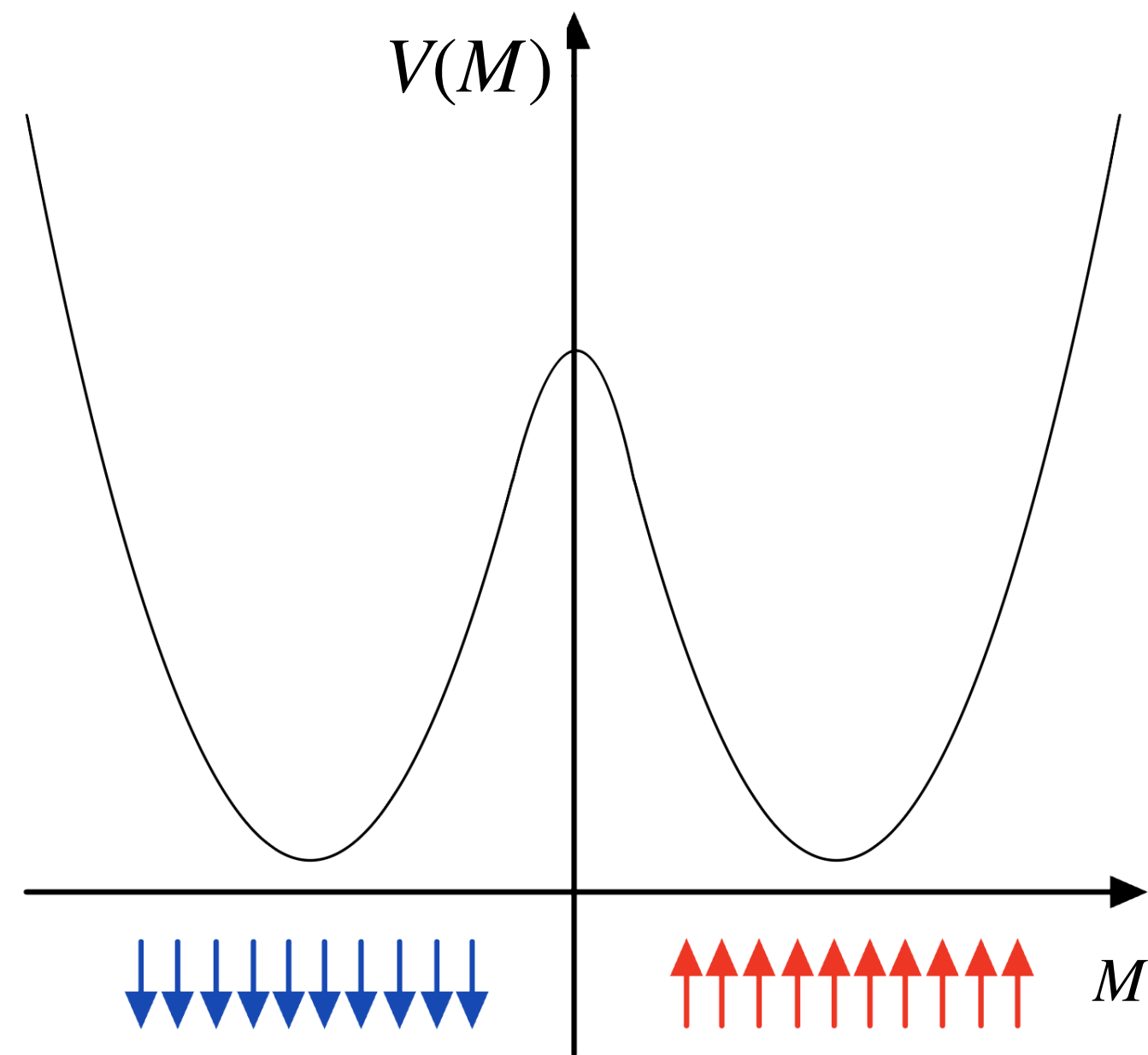

The model: Transverse Field Quantum Ising Chain

$$H = - \sum_i \sigma_i^z \sigma_{i+1}^z - h_x \sigma_i^x$$

$$|h_x| \ll 1 \Rightarrow H \approx - \sum_j 2|j\rangle\langle j| - h_x (|j\rangle\langle j+1| + h.c.)$$

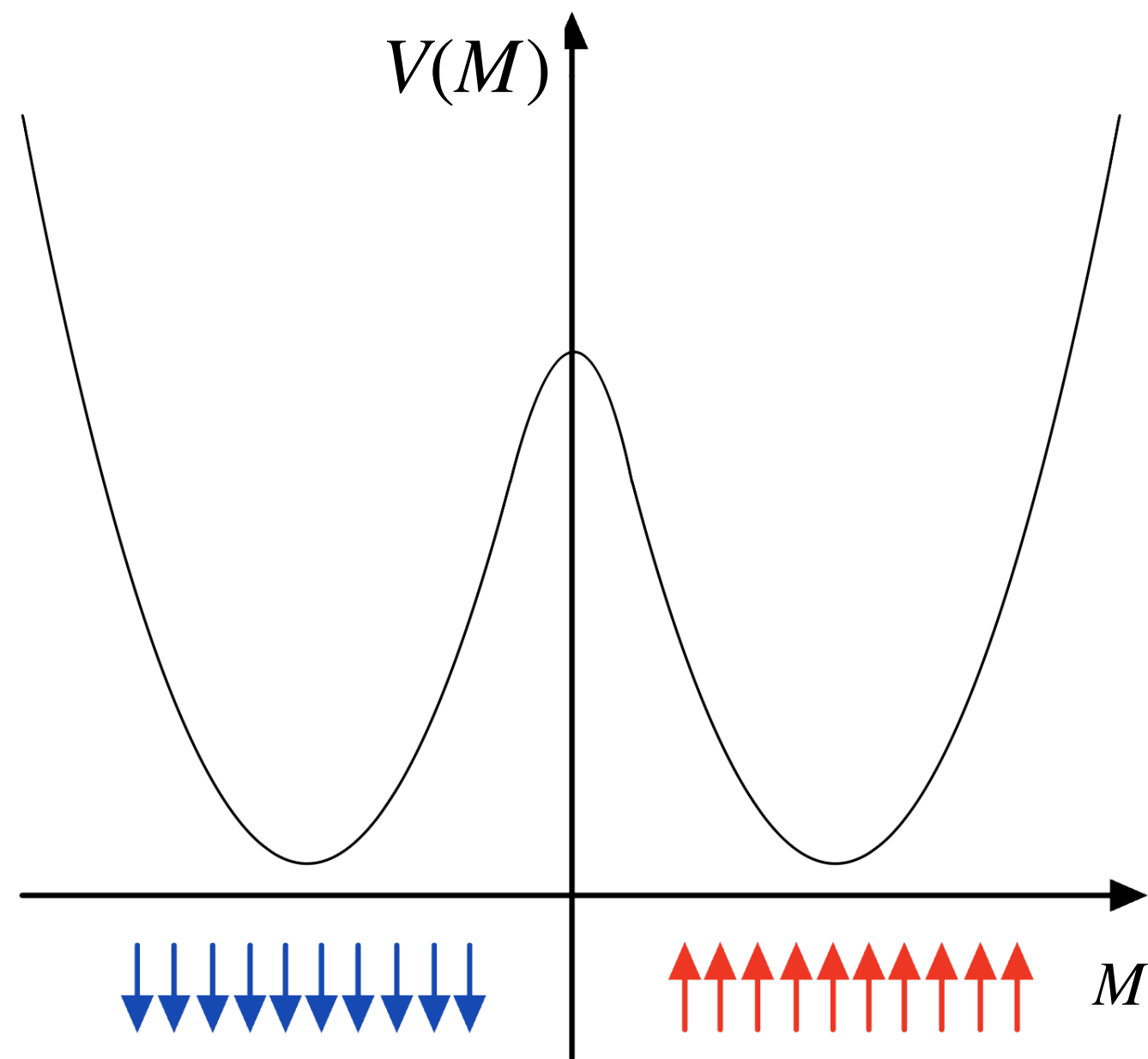

The model: Transverse Field Quantum Ising Chain

$$H = - \sum_i \sigma_i^z \sigma_{i+1}^z - h_x \sigma_i^x$$

$$|h_x| \ll 1 \Rightarrow H \approx - \sum_j 2|j\rangle\langle j| - h_x (|j\rangle\langle j+1| + h.c.)$$

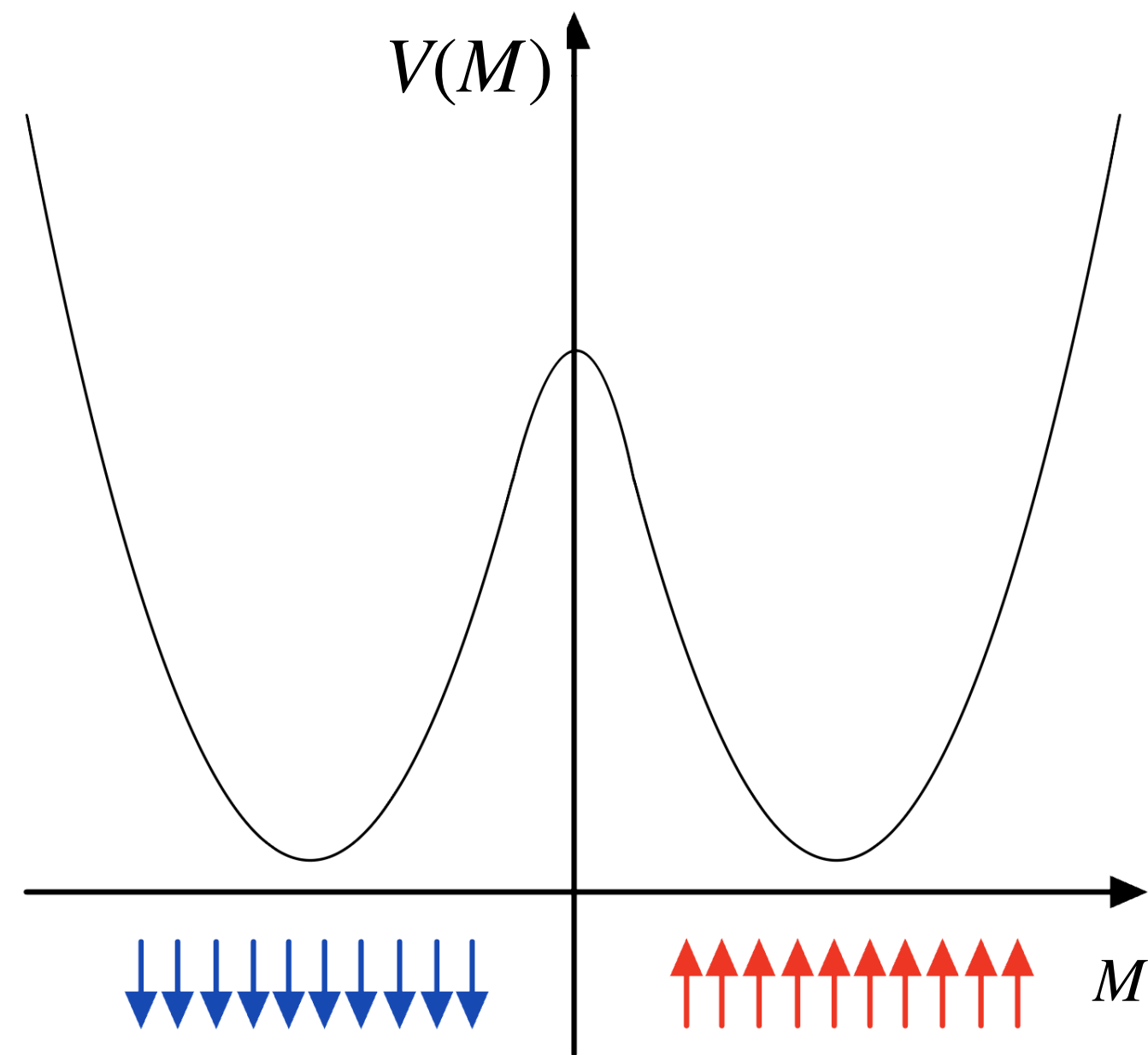

Domain-wall excitations:

$$|j\rangle = \begin{array}{ccccccc} \downarrow & \downarrow & \downarrow & \downarrow & \downarrow & \uparrow & \uparrow & \uparrow & \uparrow & \uparrow \\ & & & & \circ & & & & & \\ & & & & j & & & & & \end{array}$$

The model: Transverse Field Quantum Ising Chain

$$H = - \sum_i \sigma_i^z \sigma_{i+1}^z - h_x \sigma_i^x$$

$$|h_x| < 1 \Rightarrow H = \sum_k \varepsilon_k \eta_k^\dagger \eta_k + \text{const}$$

Free Fermion mapping (Jordan-Wigner) + Bogoliubov + Fourier

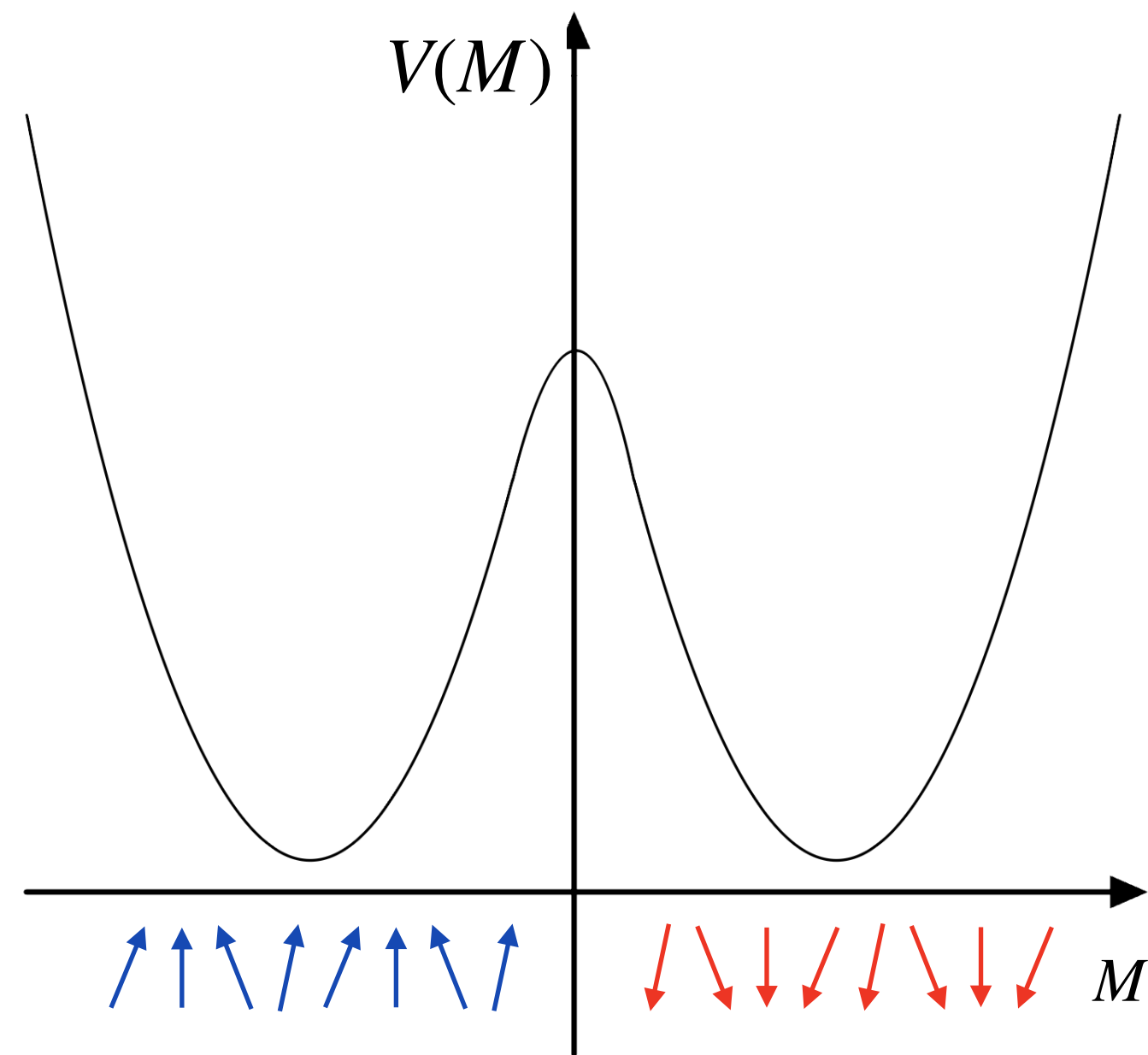

Domain-wall excitations:

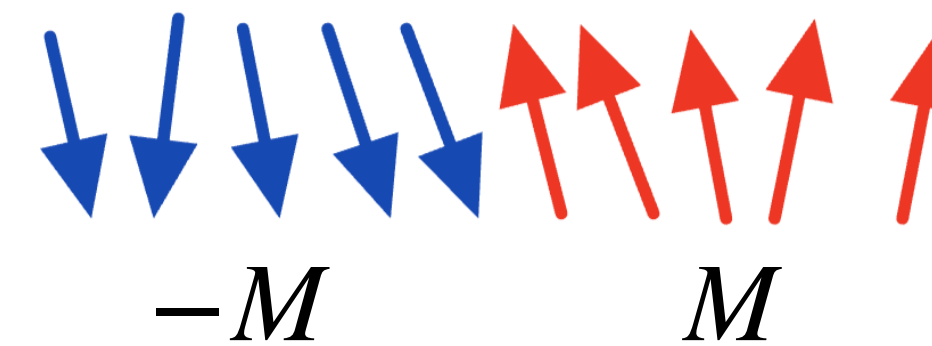

$$M = (1 - h_x)^{1/8}$$

Energy cost / Mass gap: $\Delta = 2(1 - h_x)$

The model: Transverse Field Quantum Ising Chain

$$H = - \sum_i \sigma_i^z \sigma_{i+1}^z - h_x \sigma_i^x - h_z \sigma_i^z$$

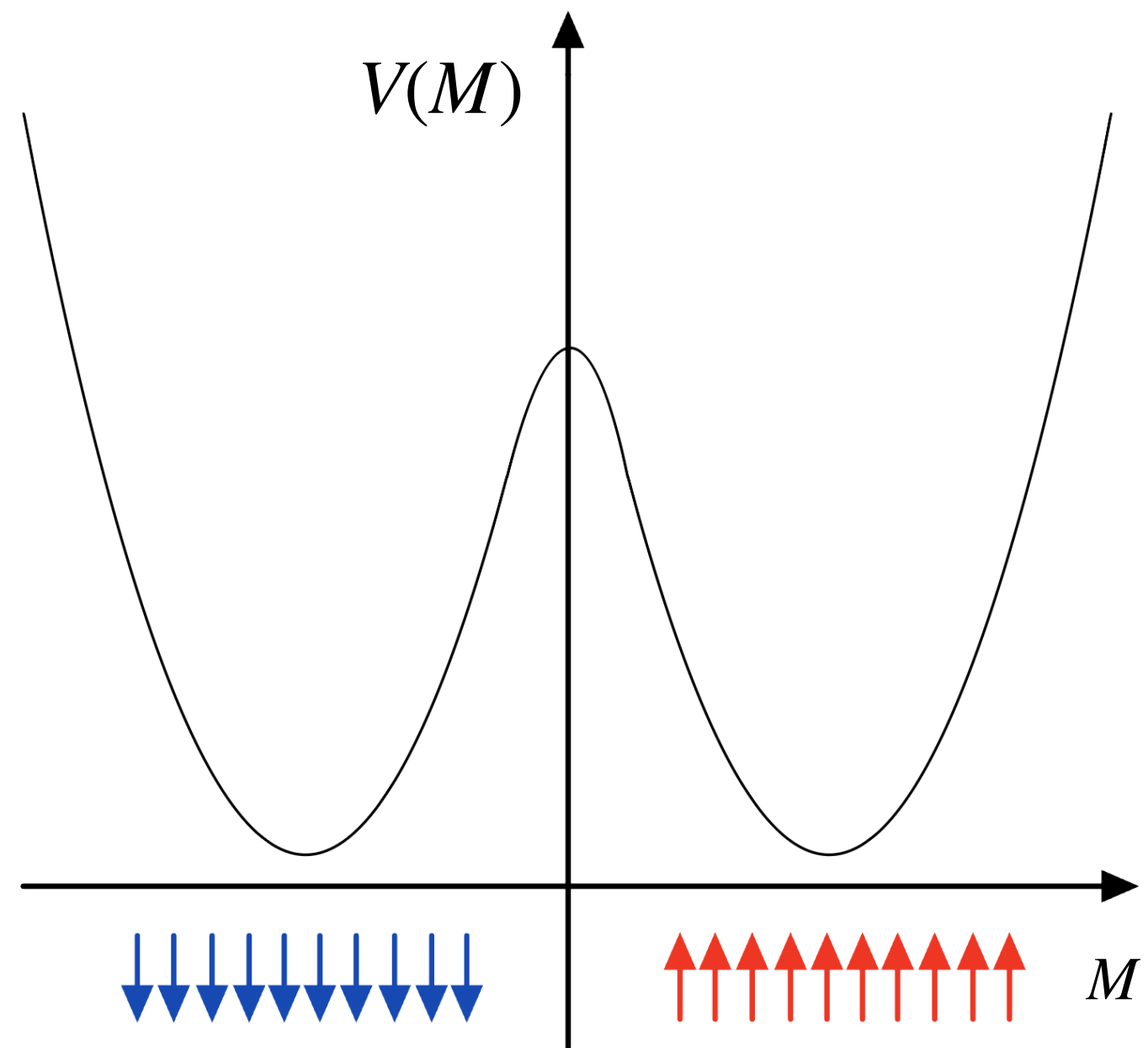

The model: Transverse Field Quantum Ising Chain

$$H = - \sum_i \sigma_i^z \sigma_{i+1}^z - h_x \sigma_i^x - h_z \sigma_i^z$$

The longitudinal field h_z lifts the degeneracy

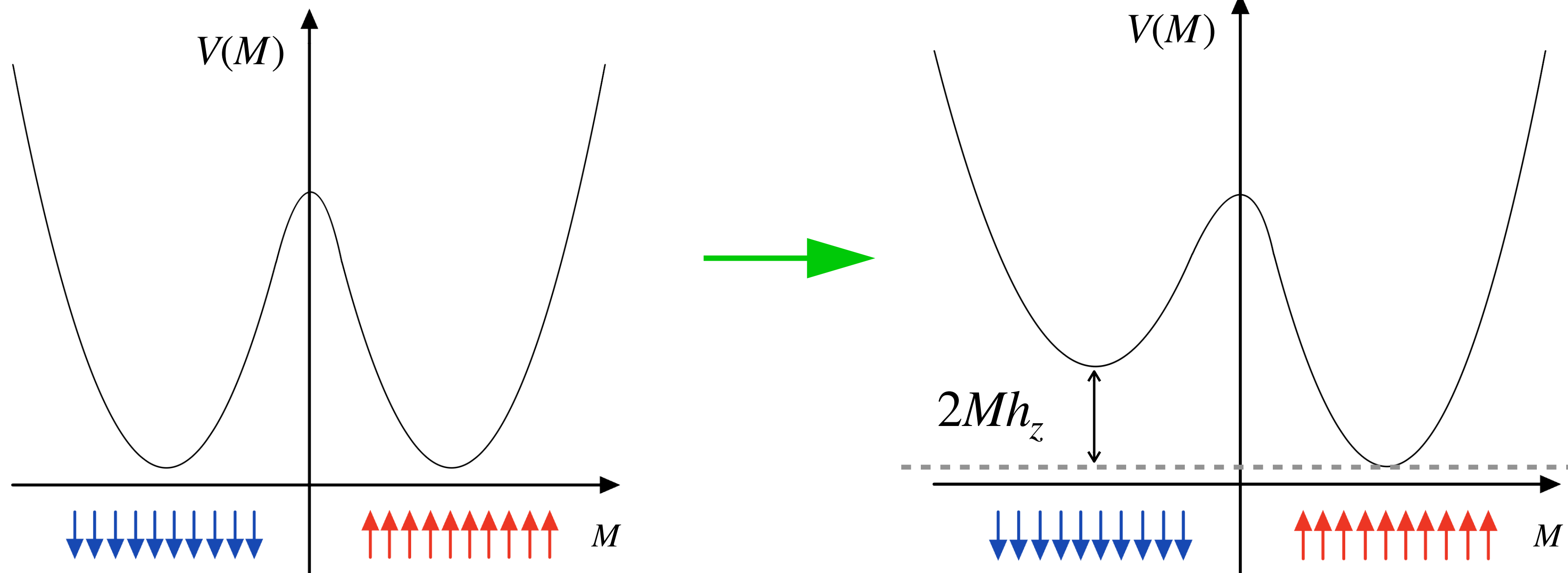

The model: Transverse Field Quantum Ising Chain

$$H = - \sum_i \sigma_i^z \sigma_{i+1}^z - h_x \sigma_i^x - h_z \sigma_i^z$$

The longitudinal field h_z lifts the degeneracy

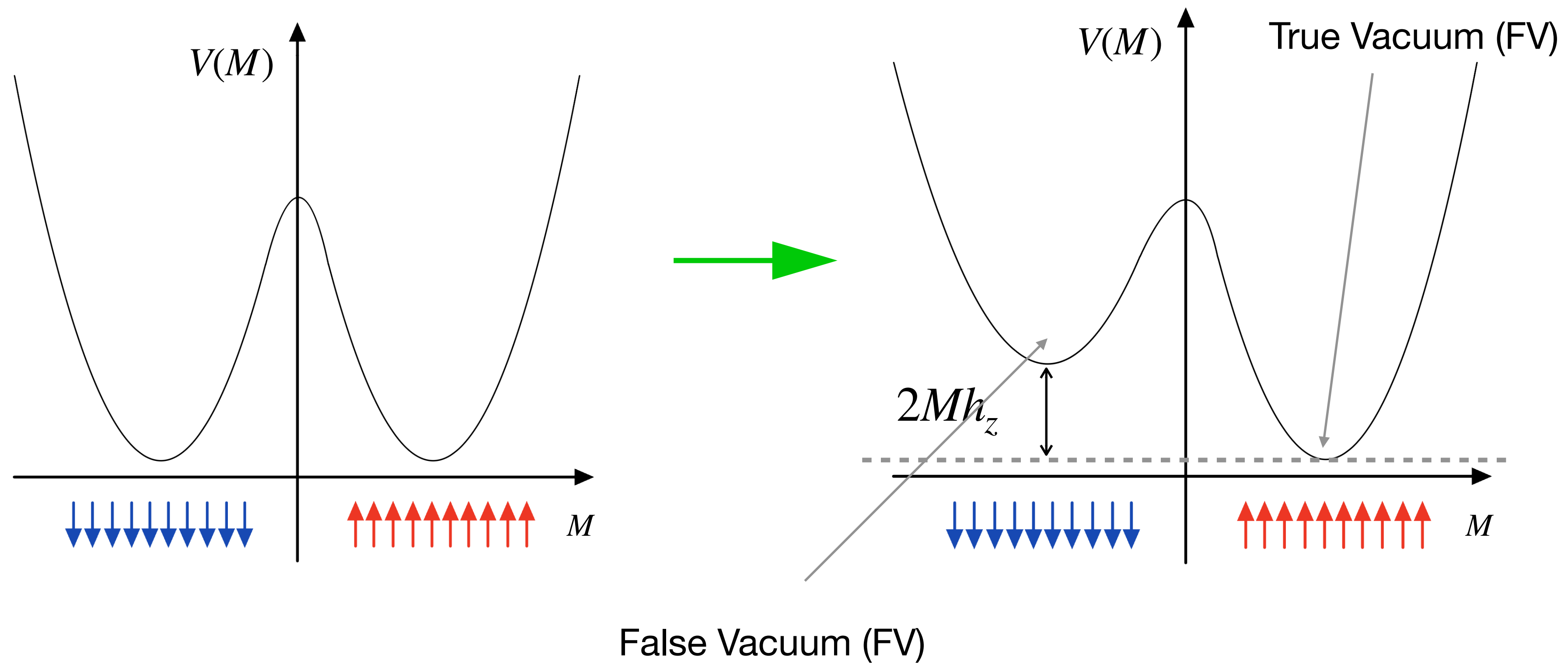

The model: Transverse Field Quantum Ising Chain

$$H = - \sum_i \sigma_i^z \sigma_{i+1}^z - h_x \sigma_i^x - h_z \sigma_i^z$$

The longitudinal field h_z lifts the degeneracy \longrightarrow Distinctive effects in the dynamics

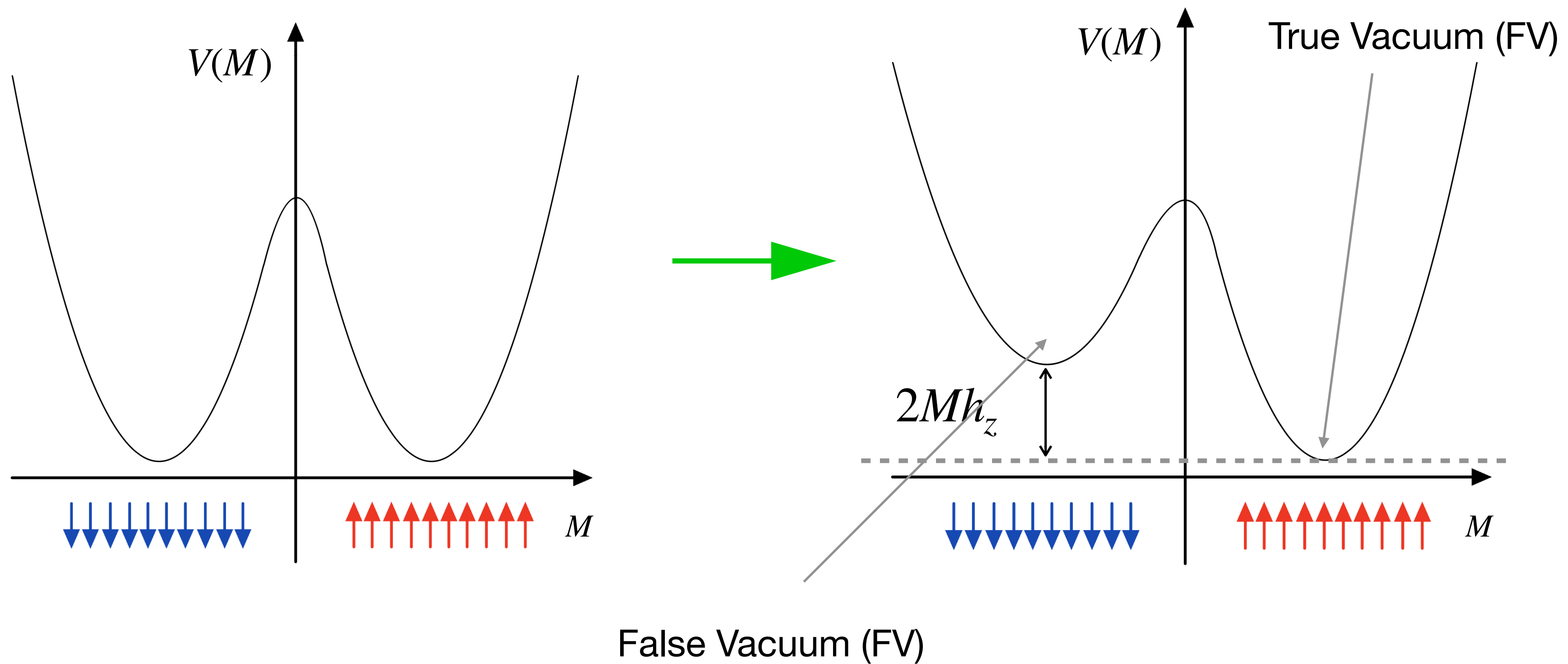

Confinement

The Quench Protocol

1 - Prepare ground state $|\psi_0\rangle$ of $H_0 = H(g_0)$.

$$g = (h_x, h_z)$$

The Quench Protocol

1 - Prepare ground state $|\psi_0\rangle$ of $H_0 = H(g_0)$. $g = (h_x, h_z)$

2 - At $t = 0$ **suddenly** change parameters $g_0 \rightarrow g$. $H_1 = H(g)$

The Quench Protocol

1 - Prepare ground state $|\psi_0\rangle$ of $H_0 = H(g_0)$. $g = (h_x, h_z)$

2 - At $t = 0$ **suddenly** change parameters $g_0 \rightarrow g$. $H_1 = H(g)$

3 - At $t > 0$ evolve with the new Hamiltonian $|\psi(t)\rangle = \exp(-iH_1 t) |\psi_0\rangle$

Quench Spectroscopy

$$\langle \sigma^z \rangle(t) = \frac{1}{L} \sum_i \langle \psi(t) | \sigma_i^z | \psi(t) \rangle$$

$$h_x = 0.5, h_z = 0 \rightarrow h_x = 0.25, h_z = 0.1$$

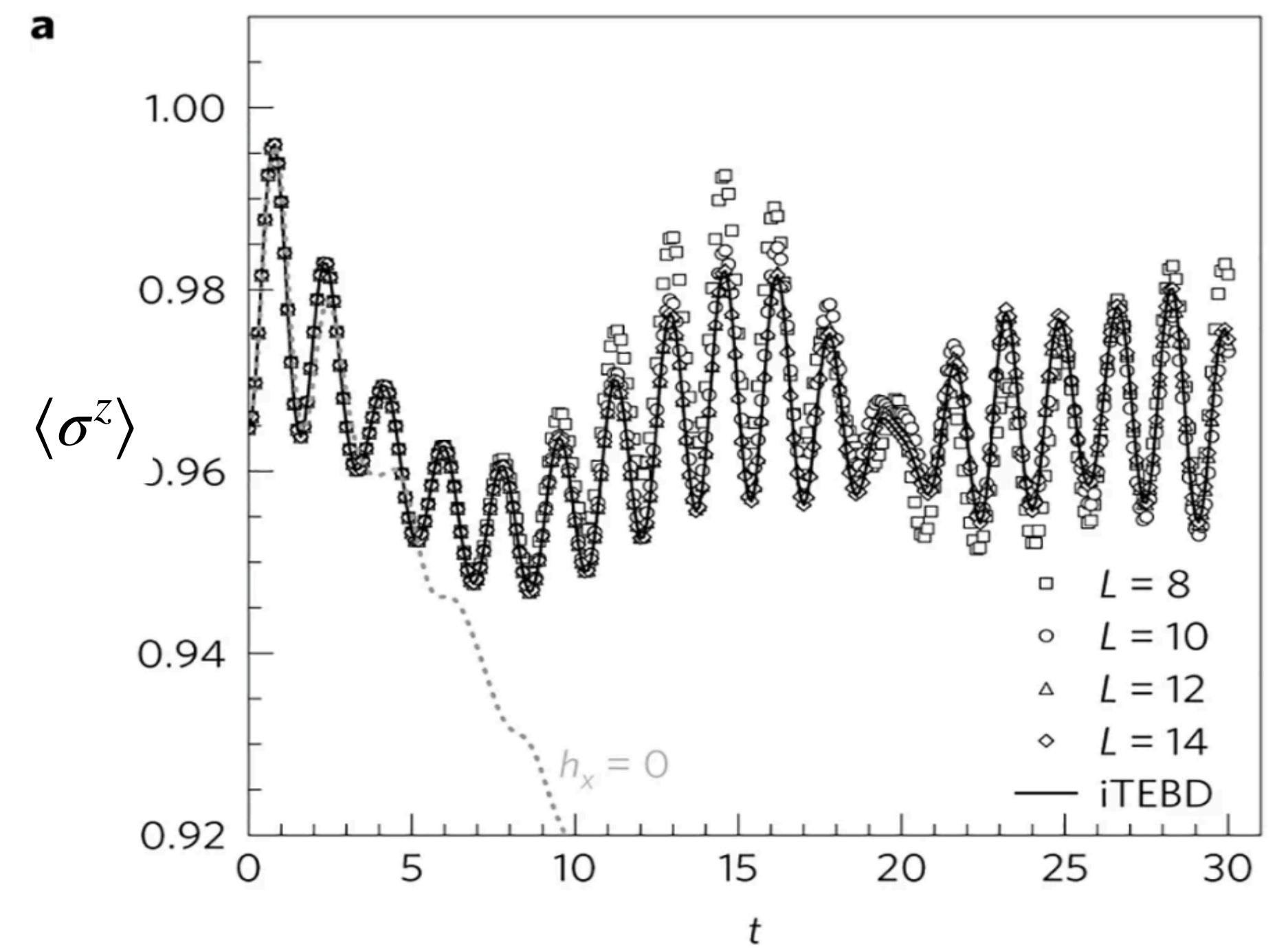

Quench Spectroscopy

$$\langle \sigma^z \rangle(t) = \sum_i \langle \psi(t) | \sigma_i^z | \psi(t) \rangle / L$$

Oscillations + Slow relaxation

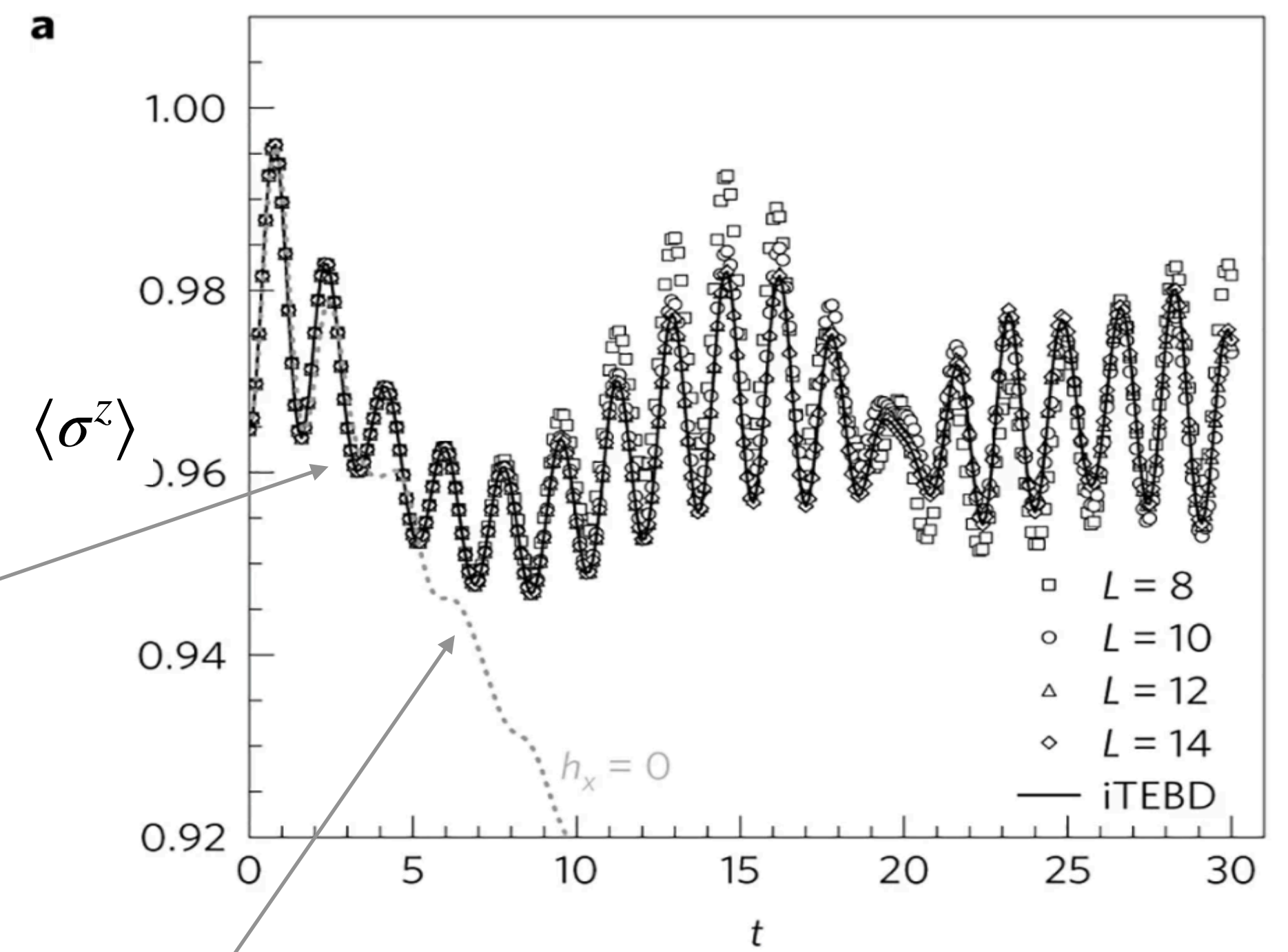

$$\langle \sigma^x \rangle(t) \approx e^{-kt}$$

Calabrese, Essler, Fagotti PRL 2011

Quench Spectroscopy

$$\langle \sigma^z \rangle(t) = \sum_i \langle \psi(t) | \sigma_i^z | \psi(t) \rangle / L$$

$|\Psi_0\rangle$ is not an eigenstate of H_1

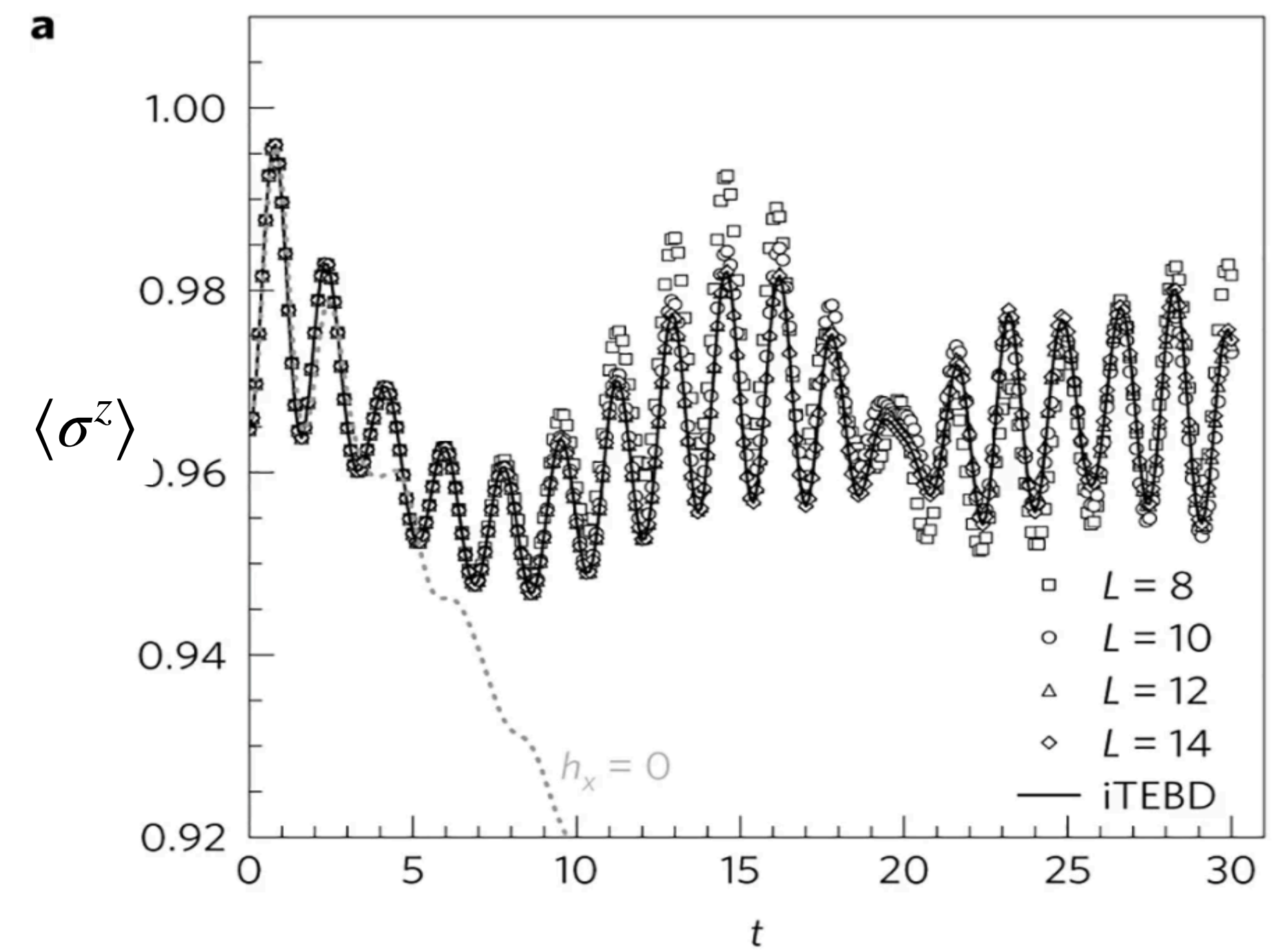

Quench Spectroscopy

$$\langle \sigma^z \rangle(t) = \sum_i \langle \psi(t) | \sigma_i^z | \psi(t) \rangle / L$$

$|\Psi_0\rangle$ is not an eigenstate of H_1

$$\Rightarrow |\psi(t)\rangle = \exp(-iHt) |\psi_0\rangle = \sum_i a_i e^{-iE_i t} |e_i\rangle$$

$$a_i = \langle e_i | \psi \rangle$$

$$H_1 |e_i\rangle = E_i |e_i\rangle$$

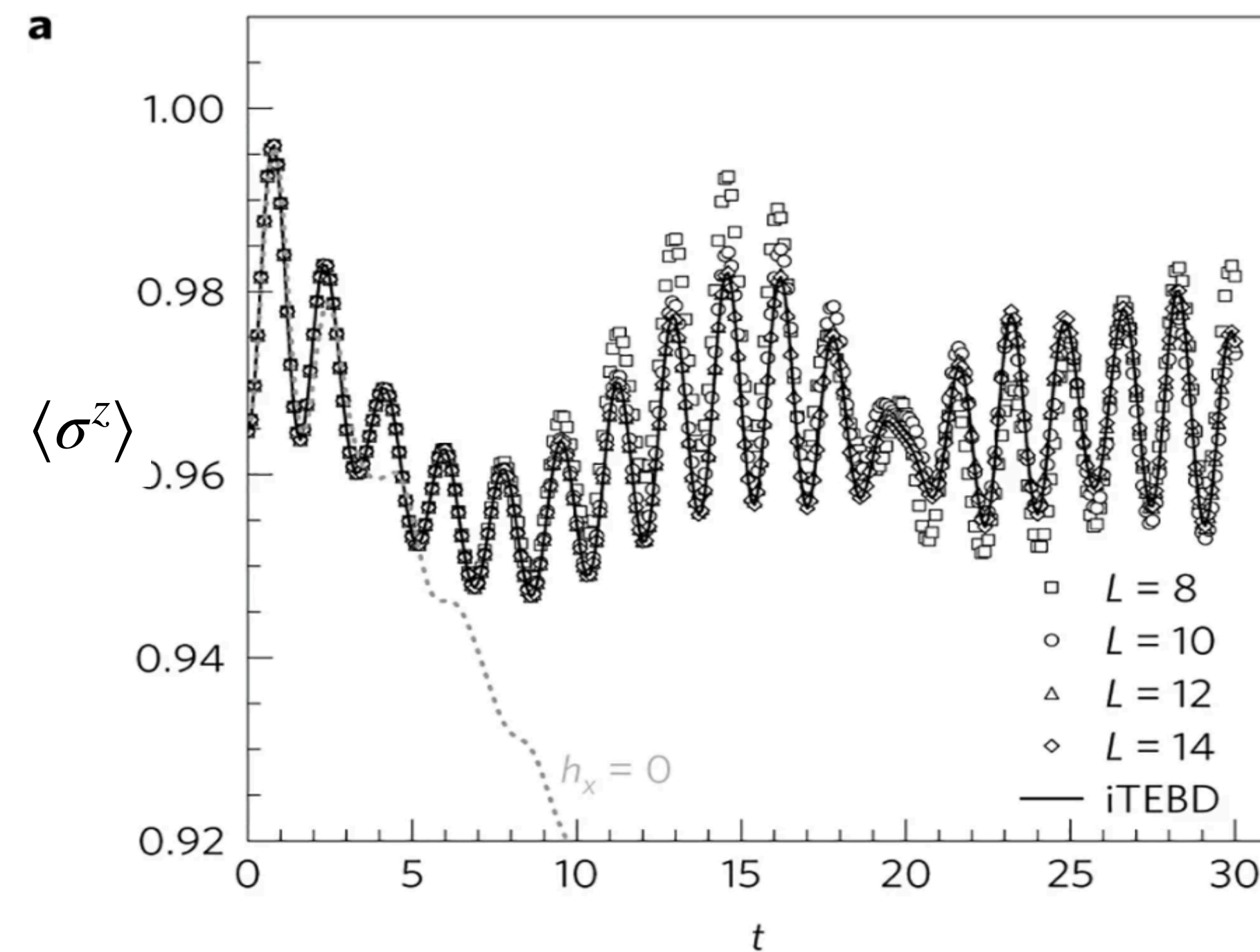

Quench Spectroscopy

$$\langle \sigma^z \rangle(t) = \frac{1}{L} \sum_i \langle \psi(t) | \sigma_i^z | \psi(t) \rangle$$

$|\Psi_0\rangle$ is not an eigenstate of H_1

$$\Rightarrow |\psi(t)\rangle = \exp(-iHt) |\psi_0\rangle = \sum_i a_i e^{-iE_i t} |e_i\rangle$$

$$\Rightarrow \langle \sigma^z \rangle(t) = \sum_{ij} a_i a_j^* e^{-i(E_i - E_j)t} \langle e_j | \sigma^z | e_i \rangle$$

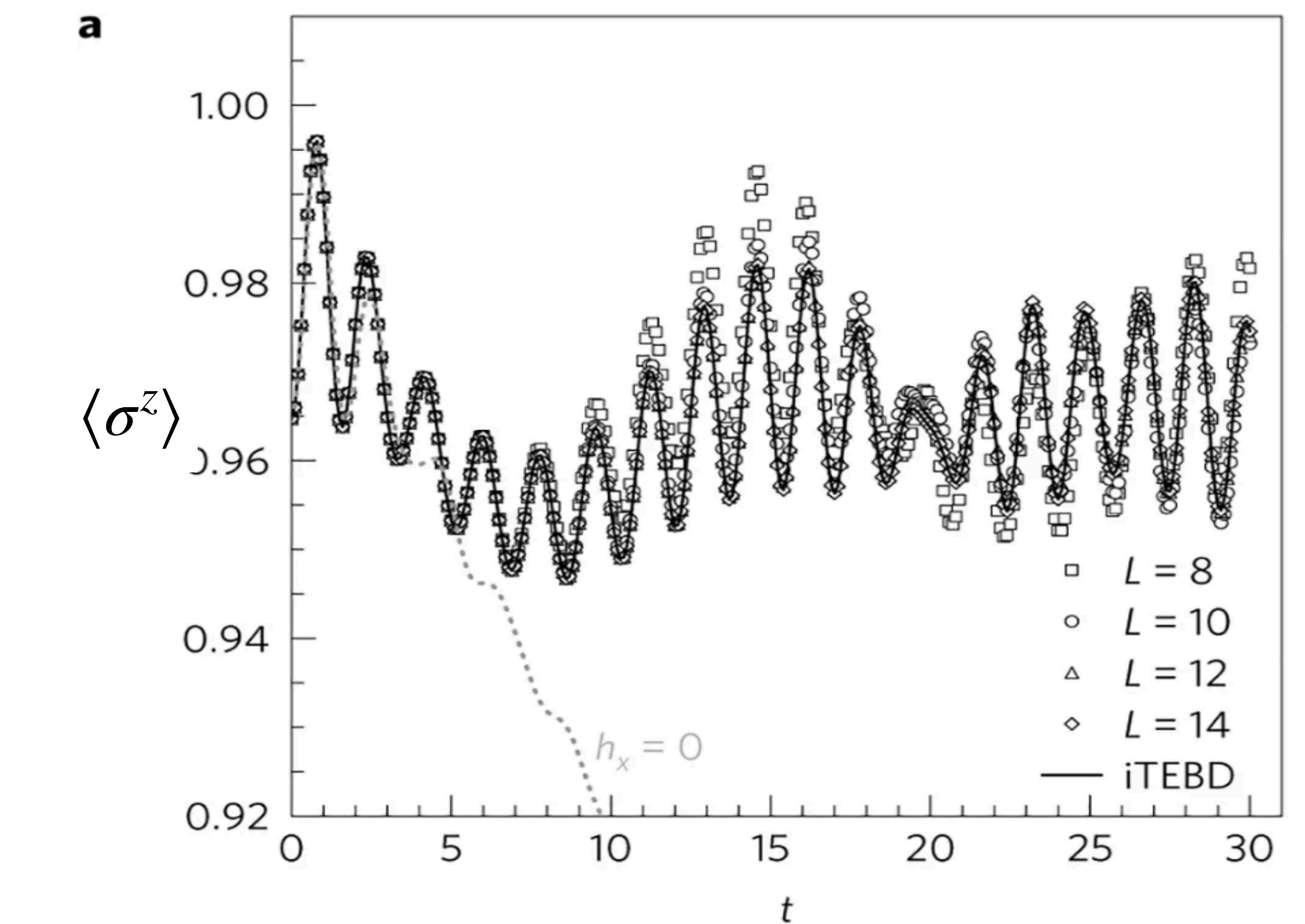

$$a_i = \langle e_i | \psi \rangle$$

$$H_1 |e_i\rangle = E_i |e_i\rangle$$

Quench Spectroscopy

$$\langle \sigma^z \rangle(t) = \frac{1}{L} \sum_i \langle \psi(t) | \sigma_i^z | \psi(t) \rangle$$

$$|\langle \sigma^z \rangle(\omega)|^2 = \left| \int dt e^{i\omega t} \langle \sigma^z \rangle(t) \right|^2$$

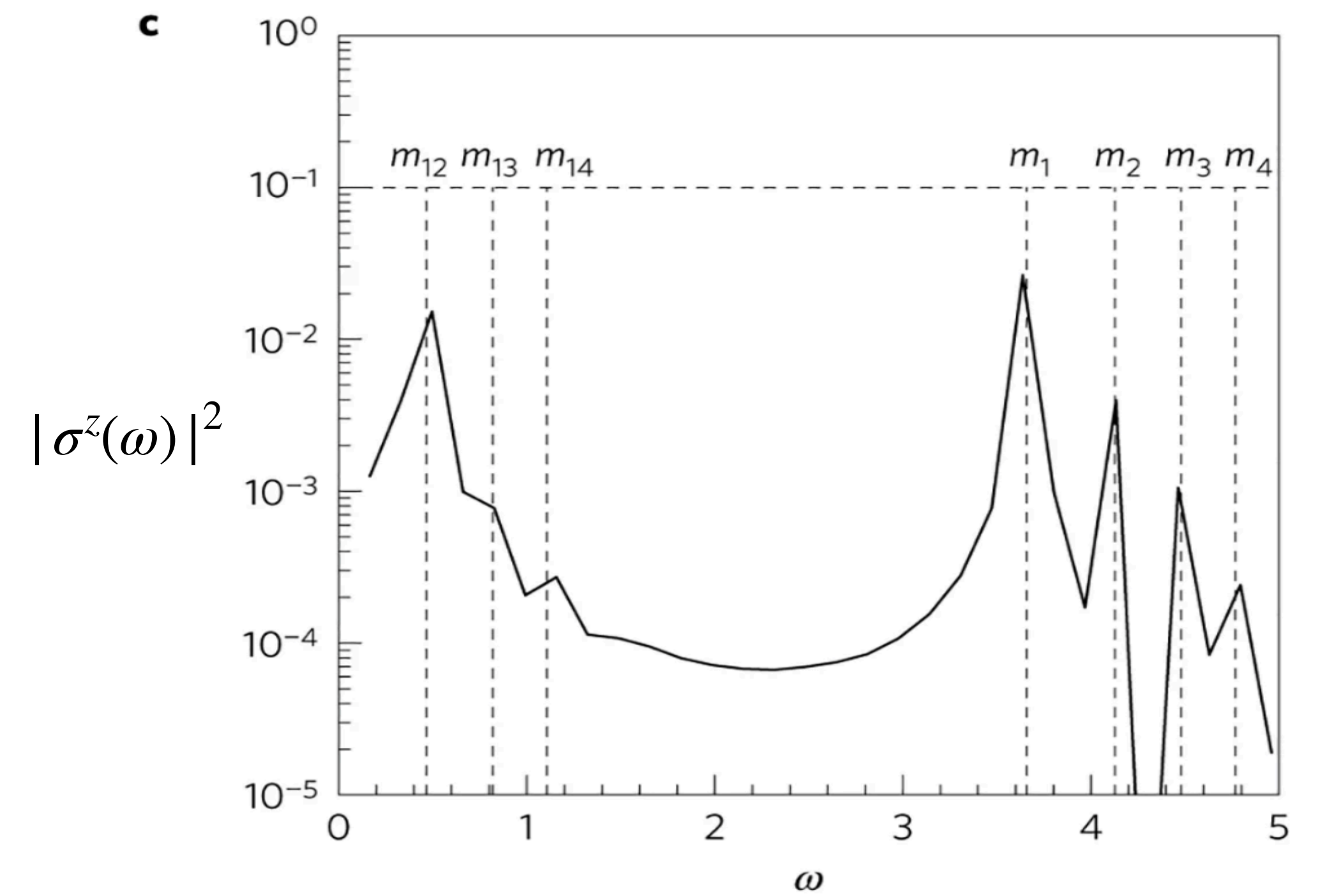
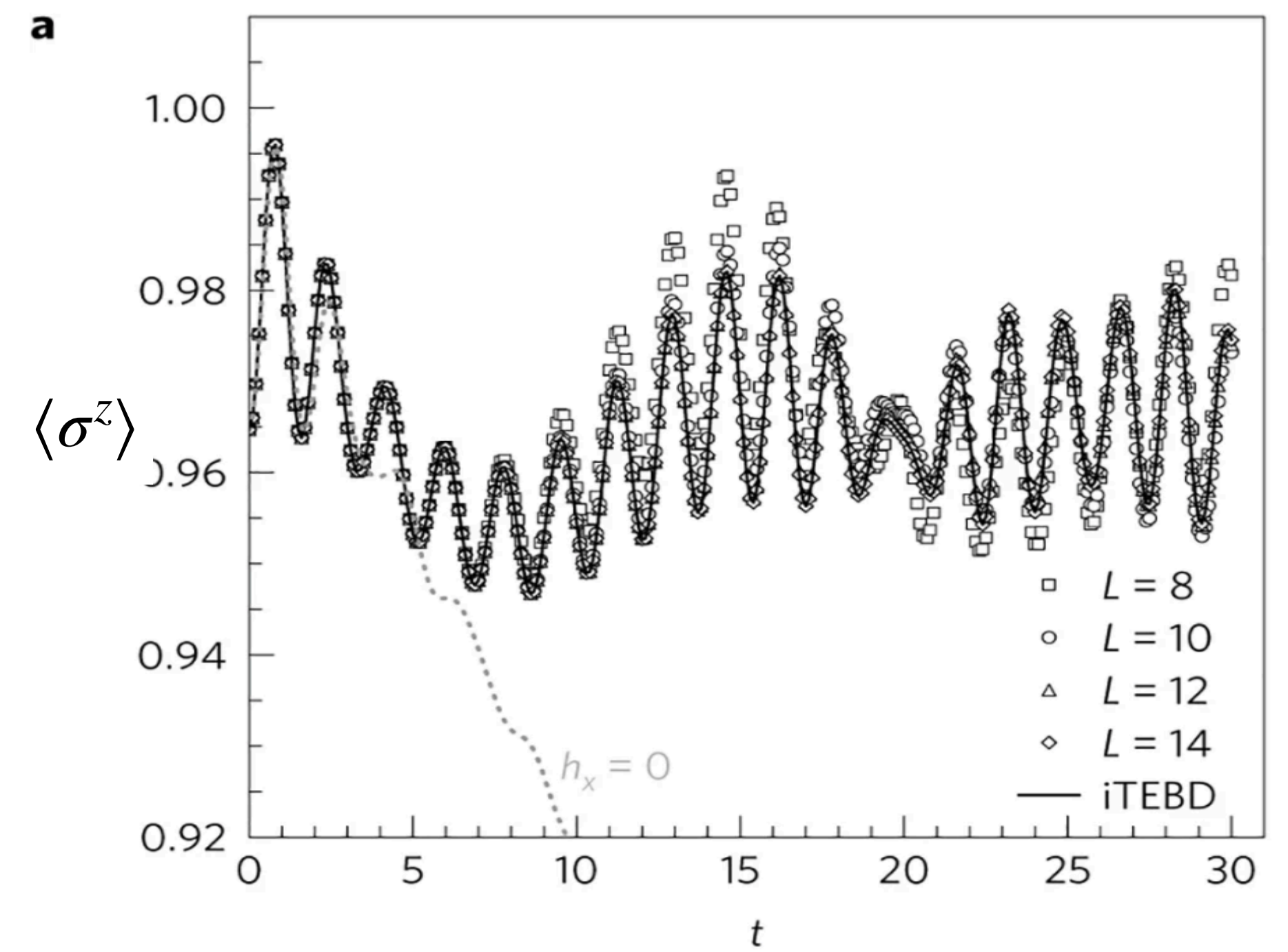

Quench Spectroscopy

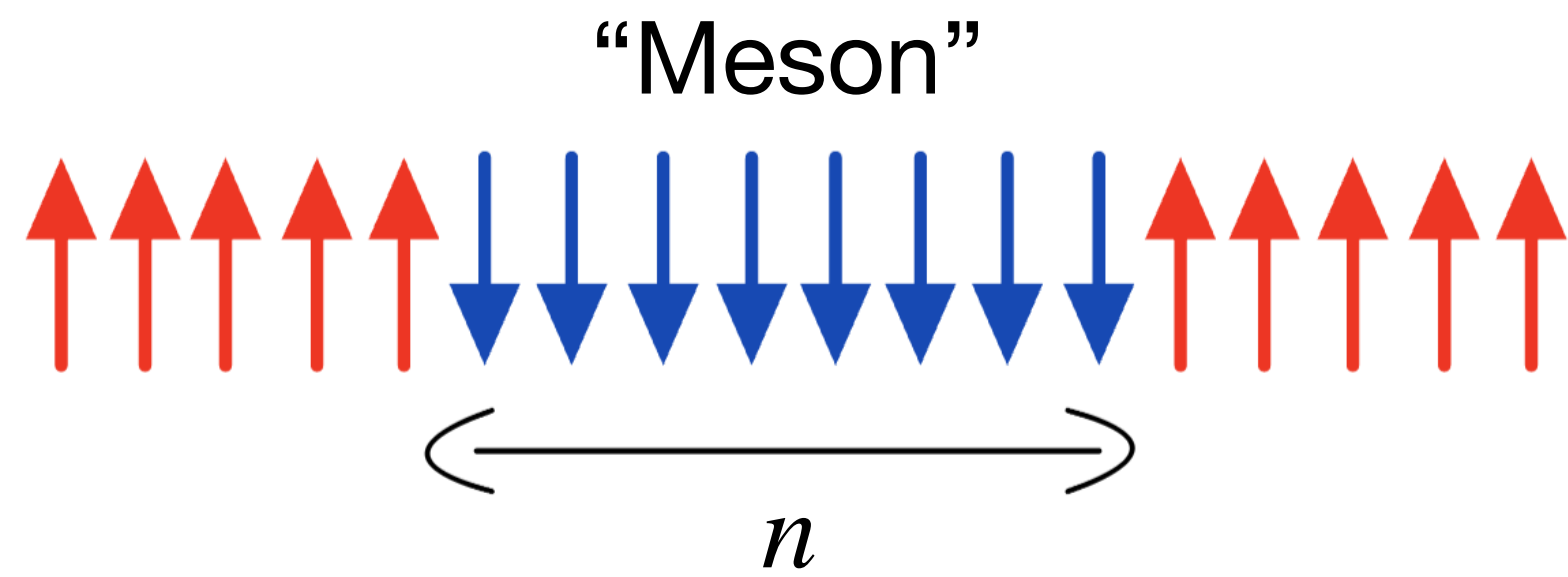

$$E_n = 2\Delta + 2Mh_z n$$

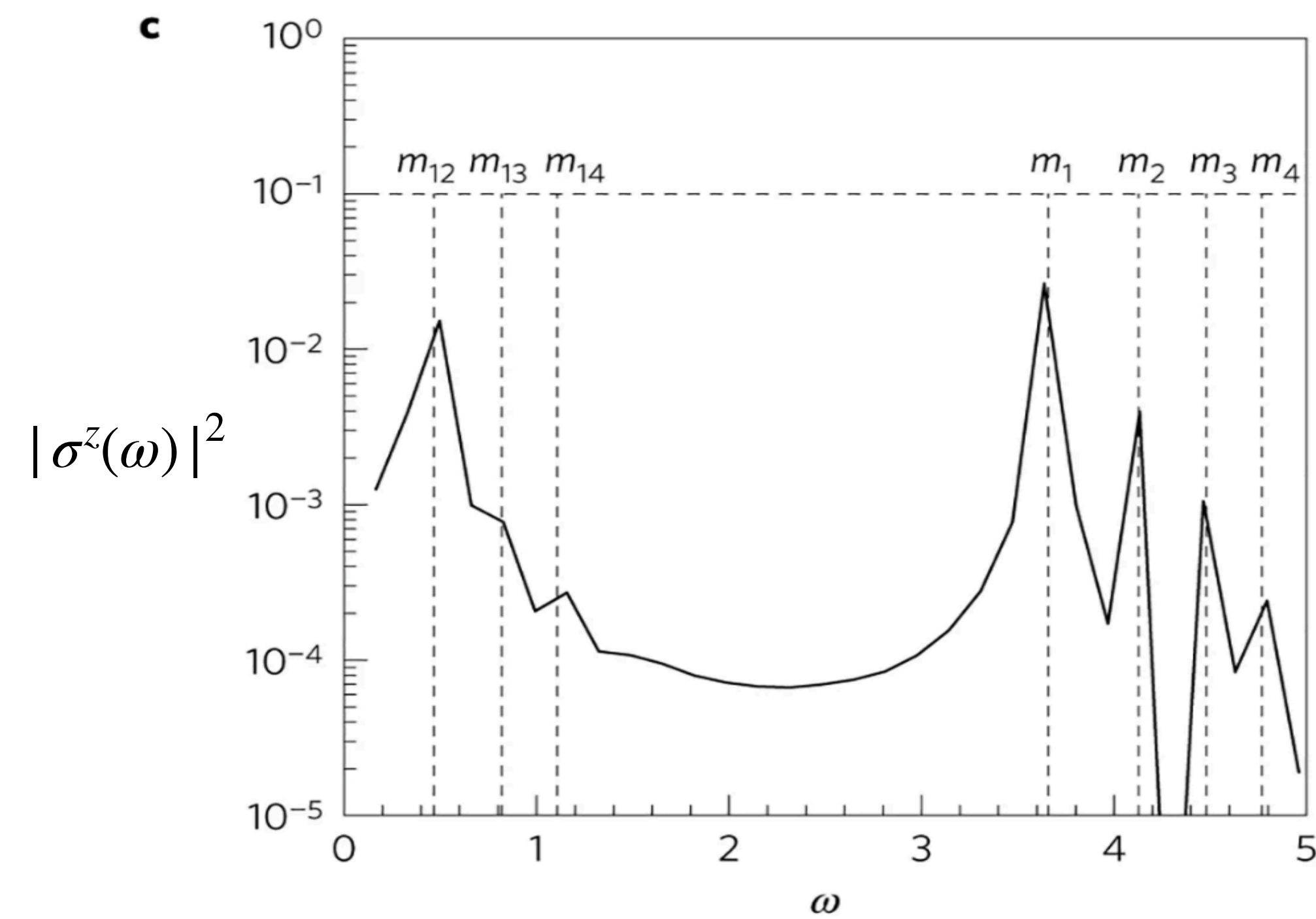
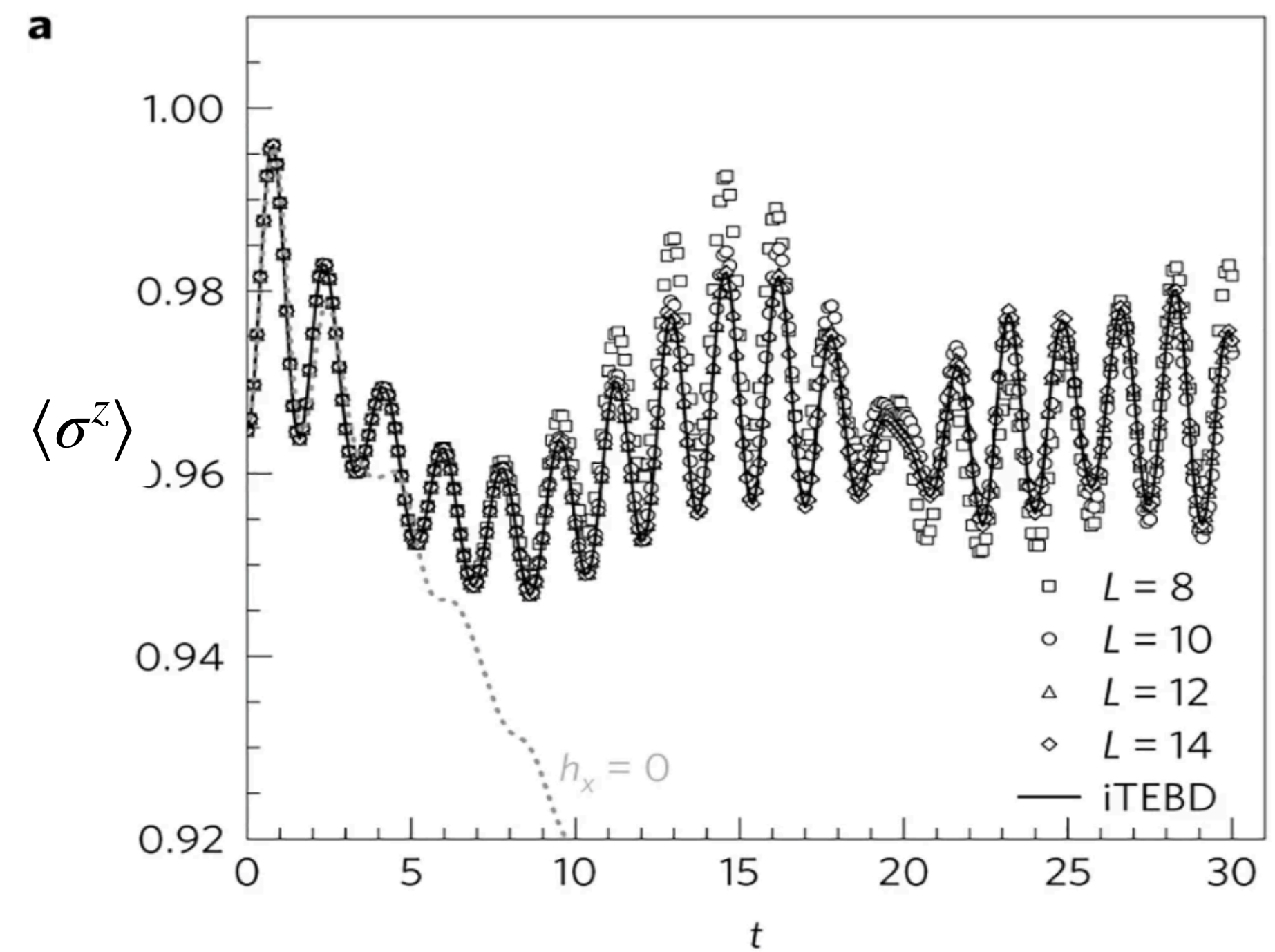

Quench Spectroscopy

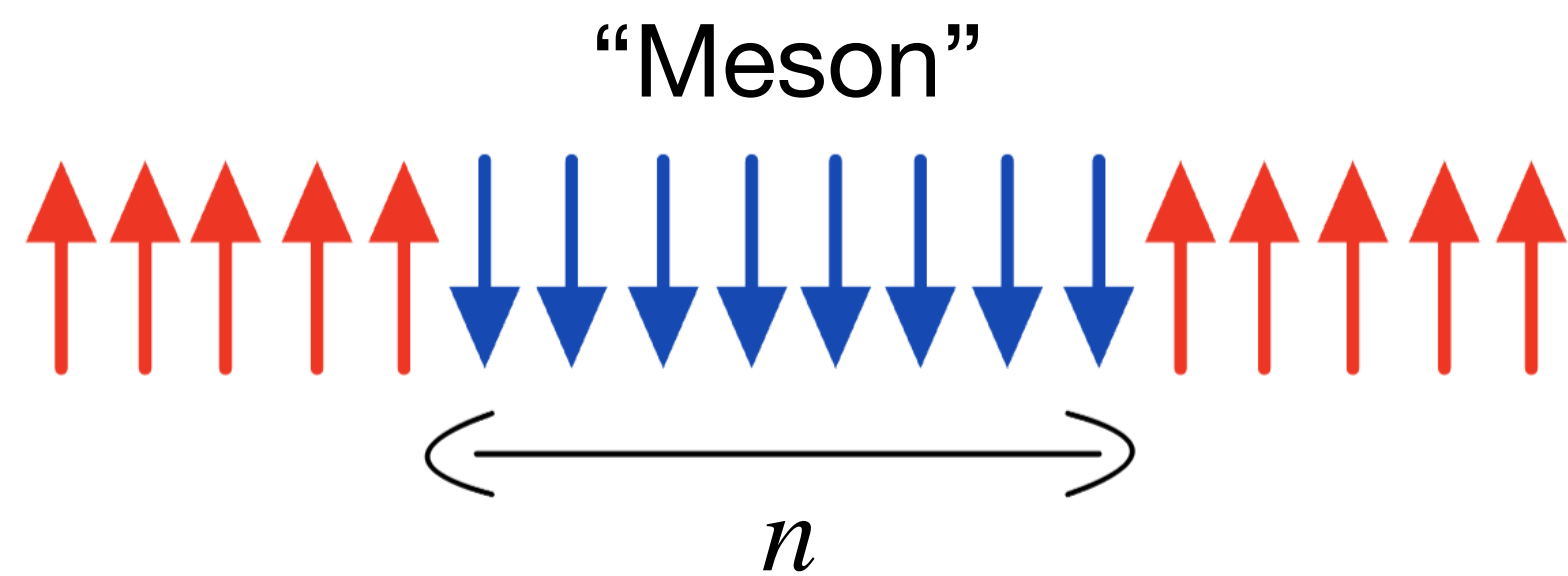

$$E_n = 2\Delta + 2Mh_z n$$

Kink's mass

Energy density

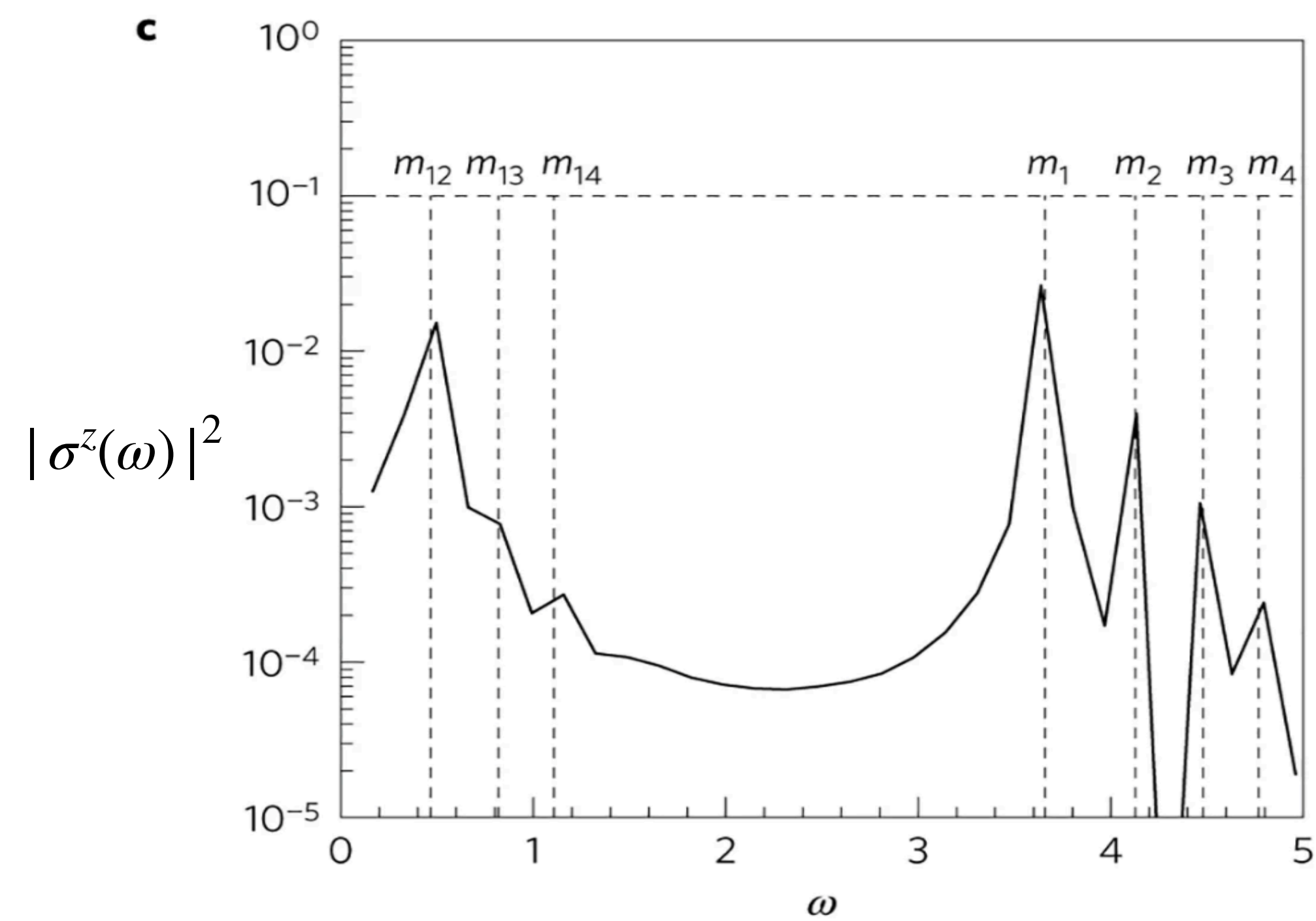
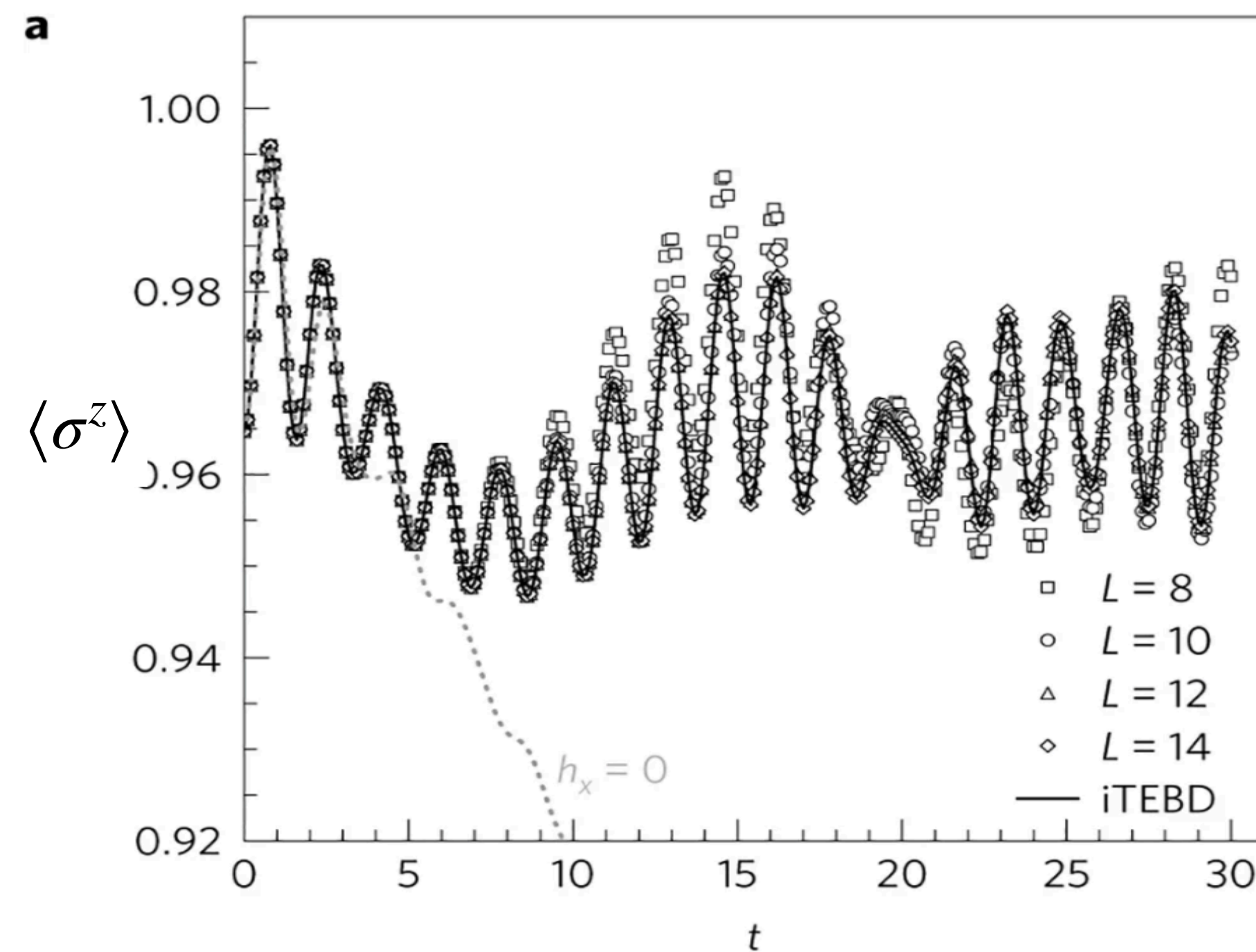

Quench Spectroscopy

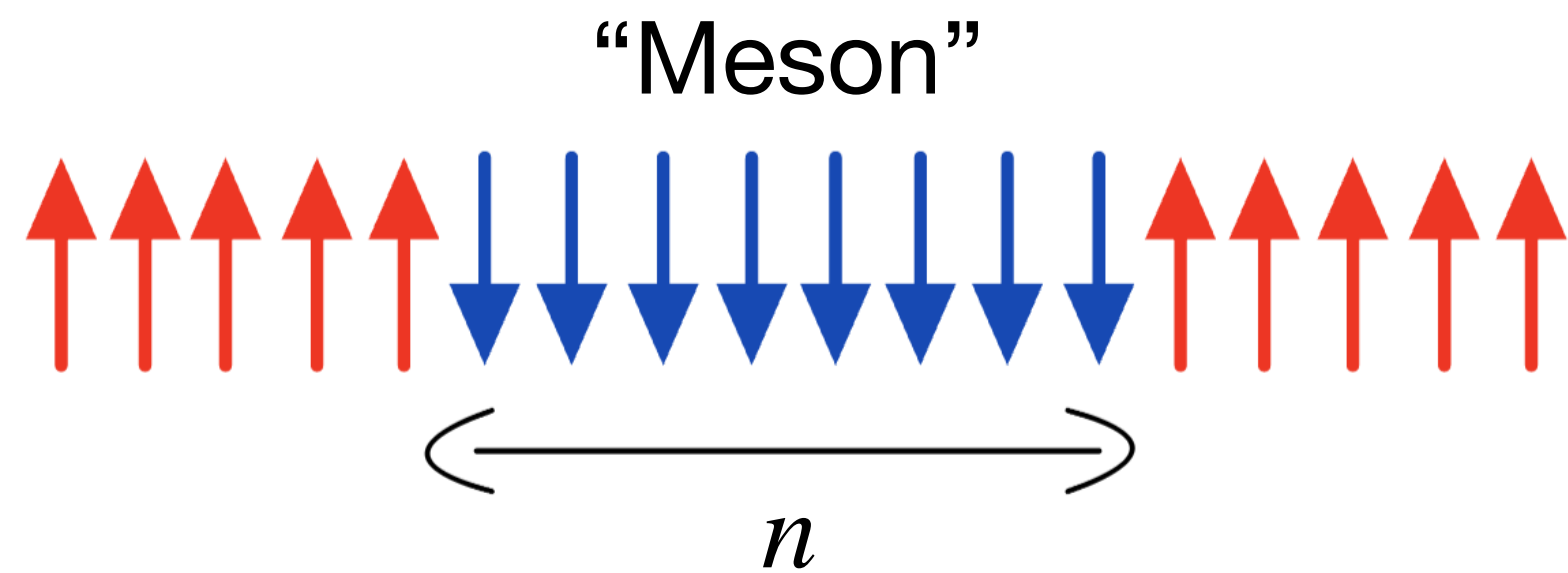

$$E_n = 2\Delta + 2Mh_z n$$

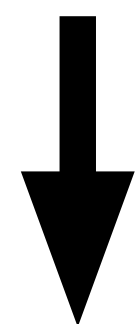

Effective two-body model:

$$H_{eff} = \varepsilon_{k_1} + \varepsilon_{k_2} + 2Mh_z n$$

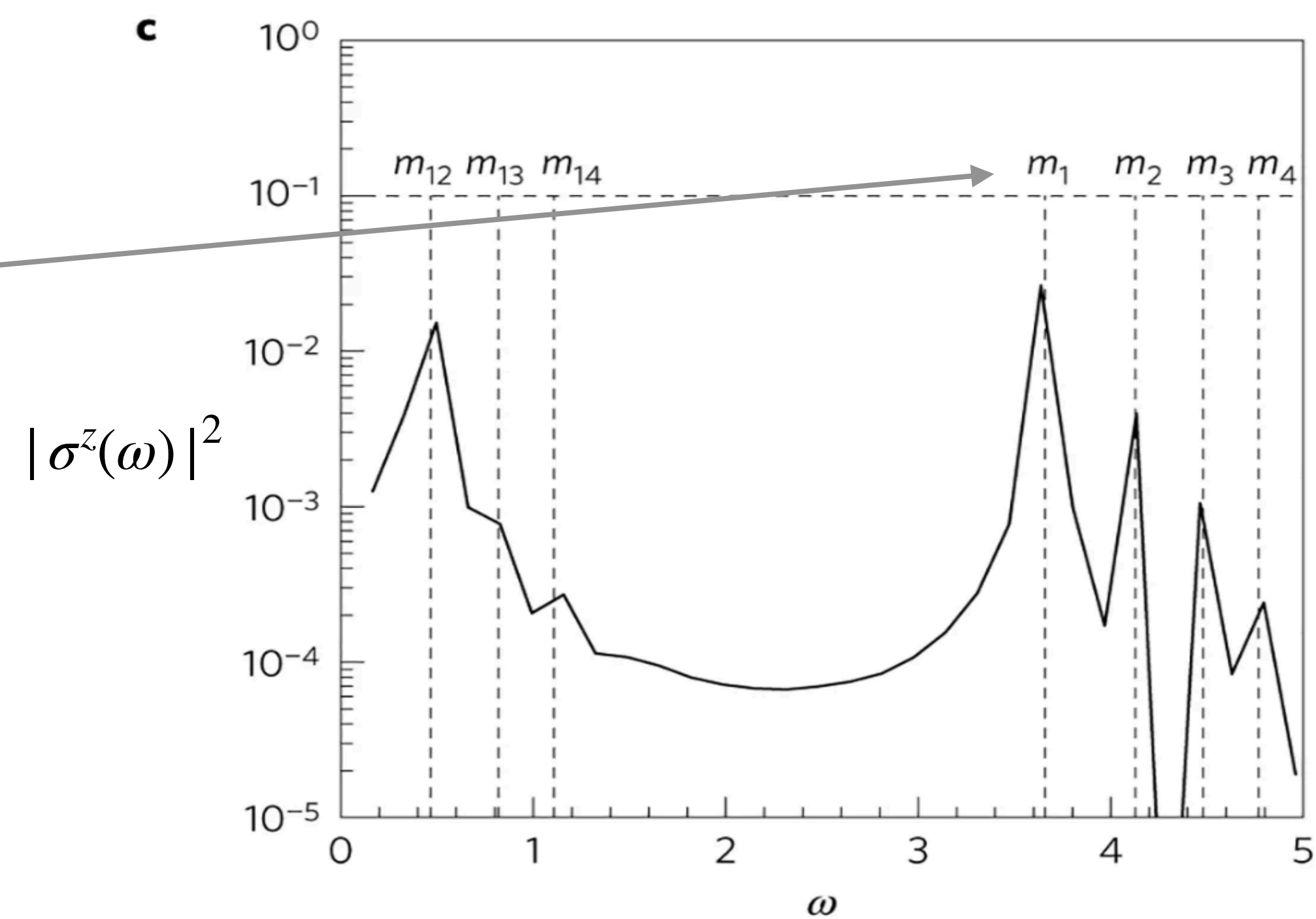
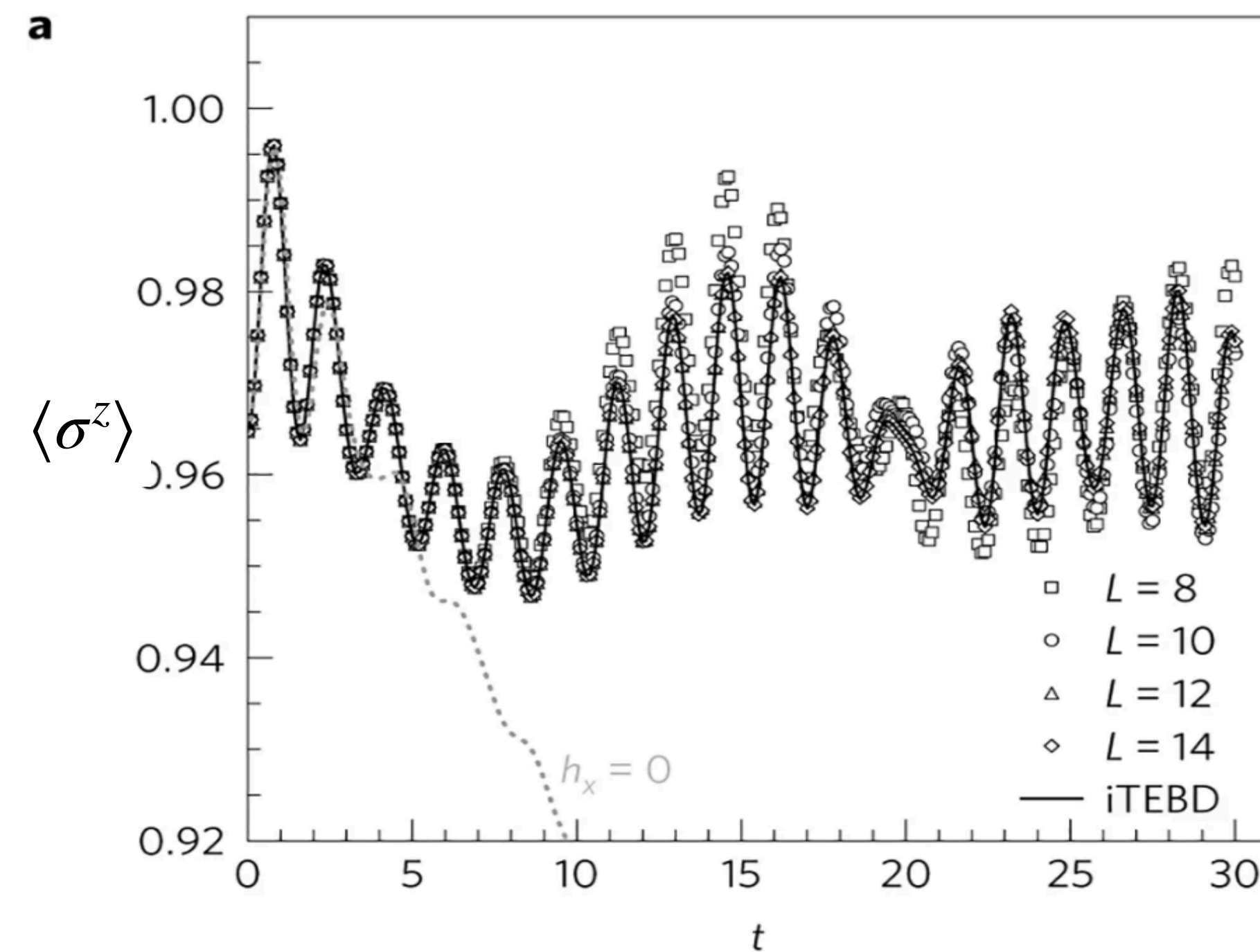

Connected Correlations

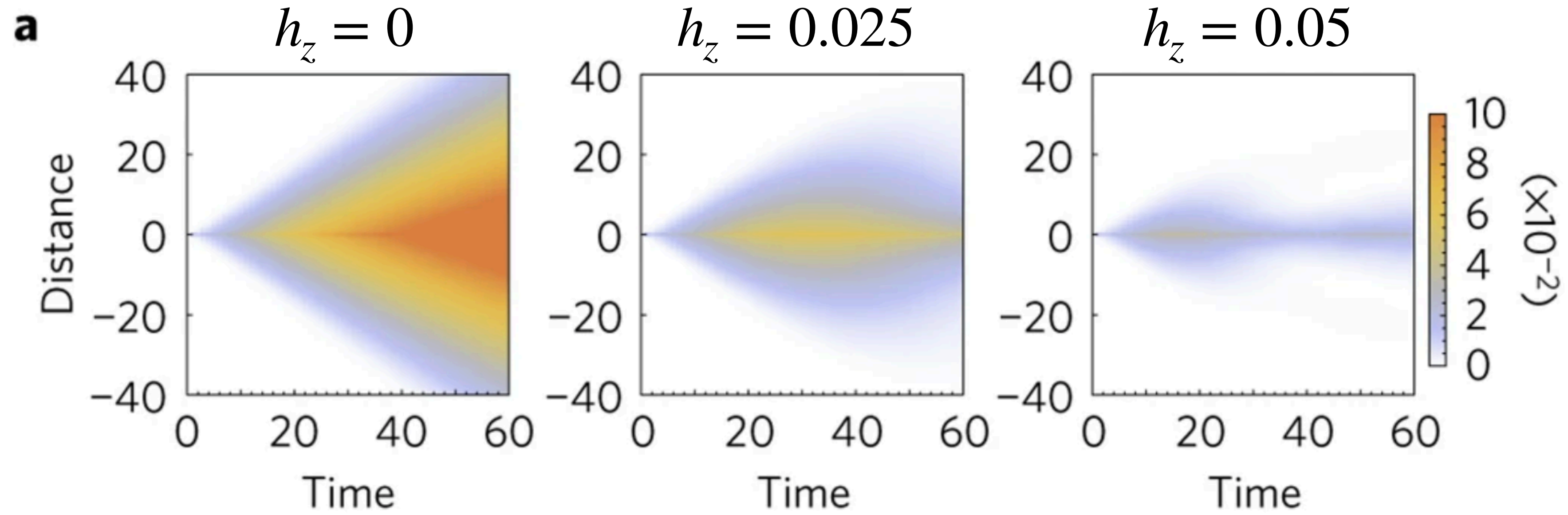

$$\langle \sigma_1^z \sigma_{1+d}^z \rangle_c = \langle \sigma_1^z \sigma_{1+d}^z \rangle - \langle \sigma_1^z \rangle \langle \sigma_{1+d}^z \rangle$$

Quasi-particle Picture

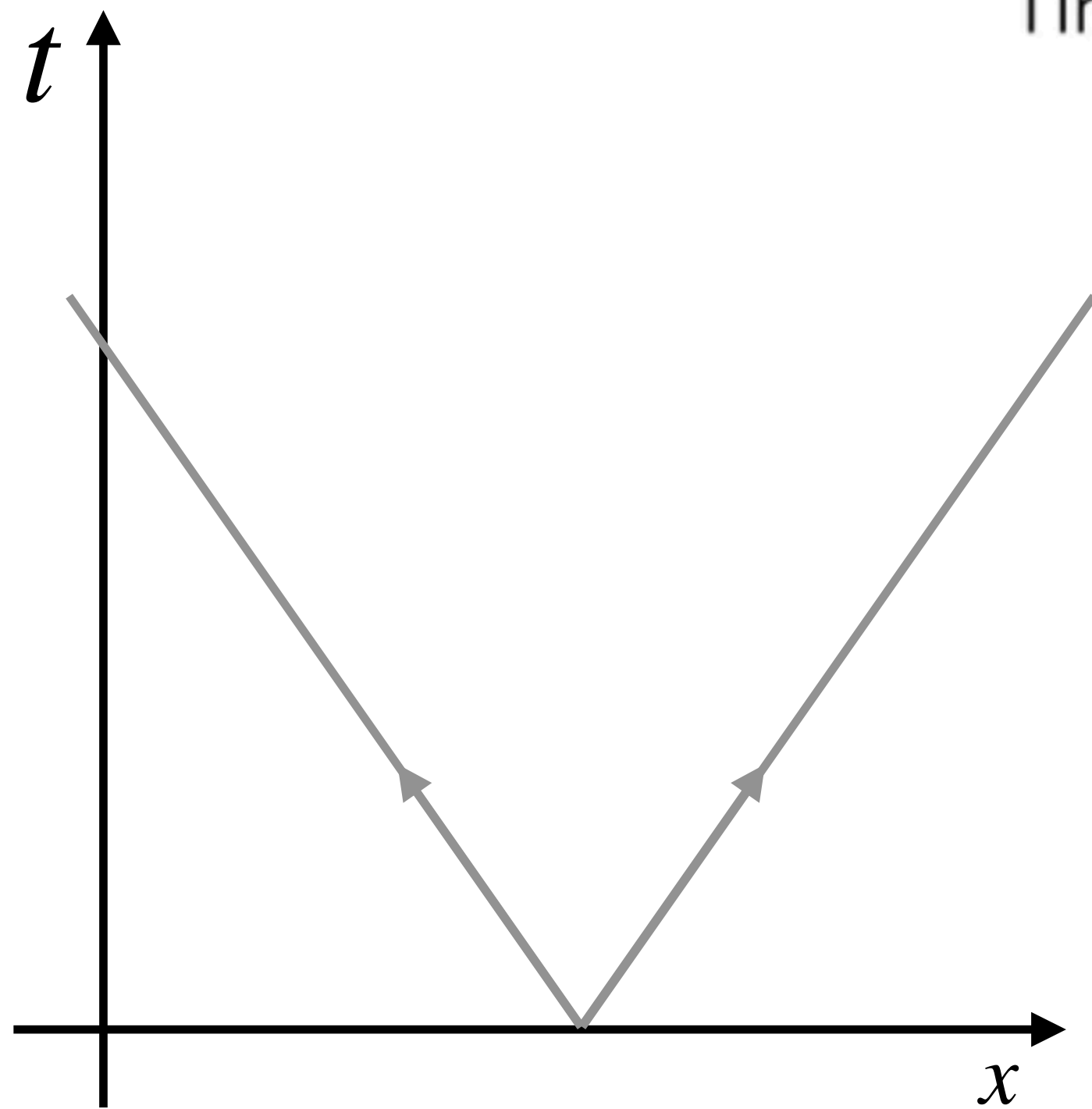
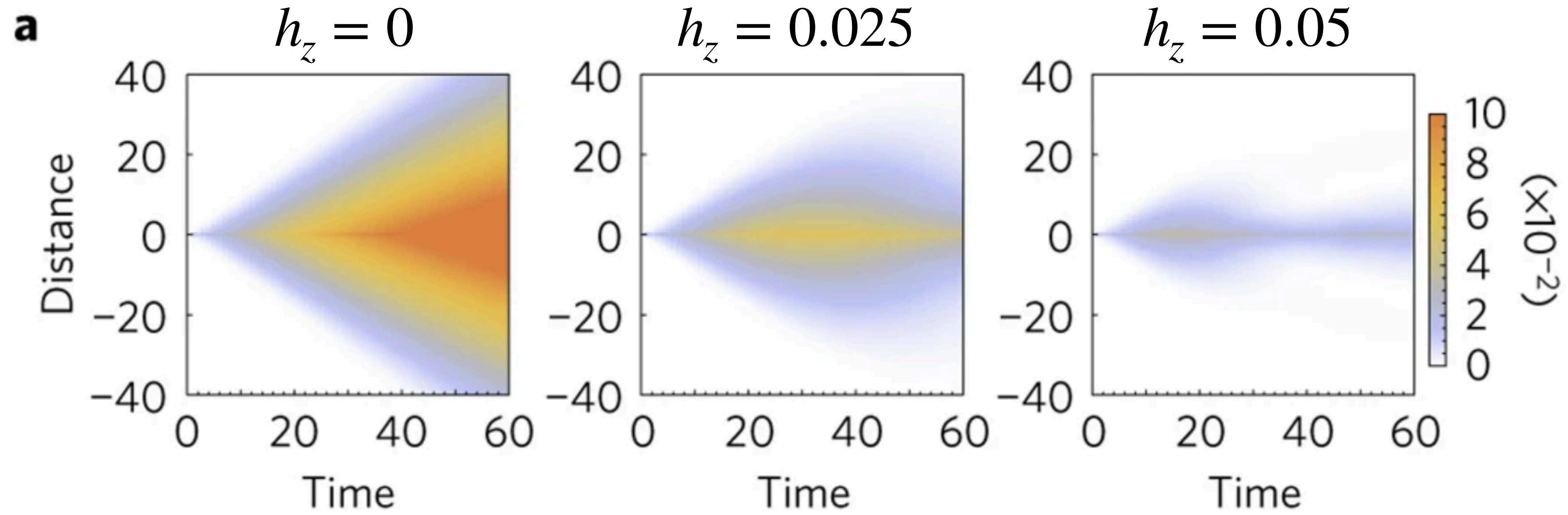

$|\Psi_0\rangle$ acts as a source of excitations

Quasi-particle Picture

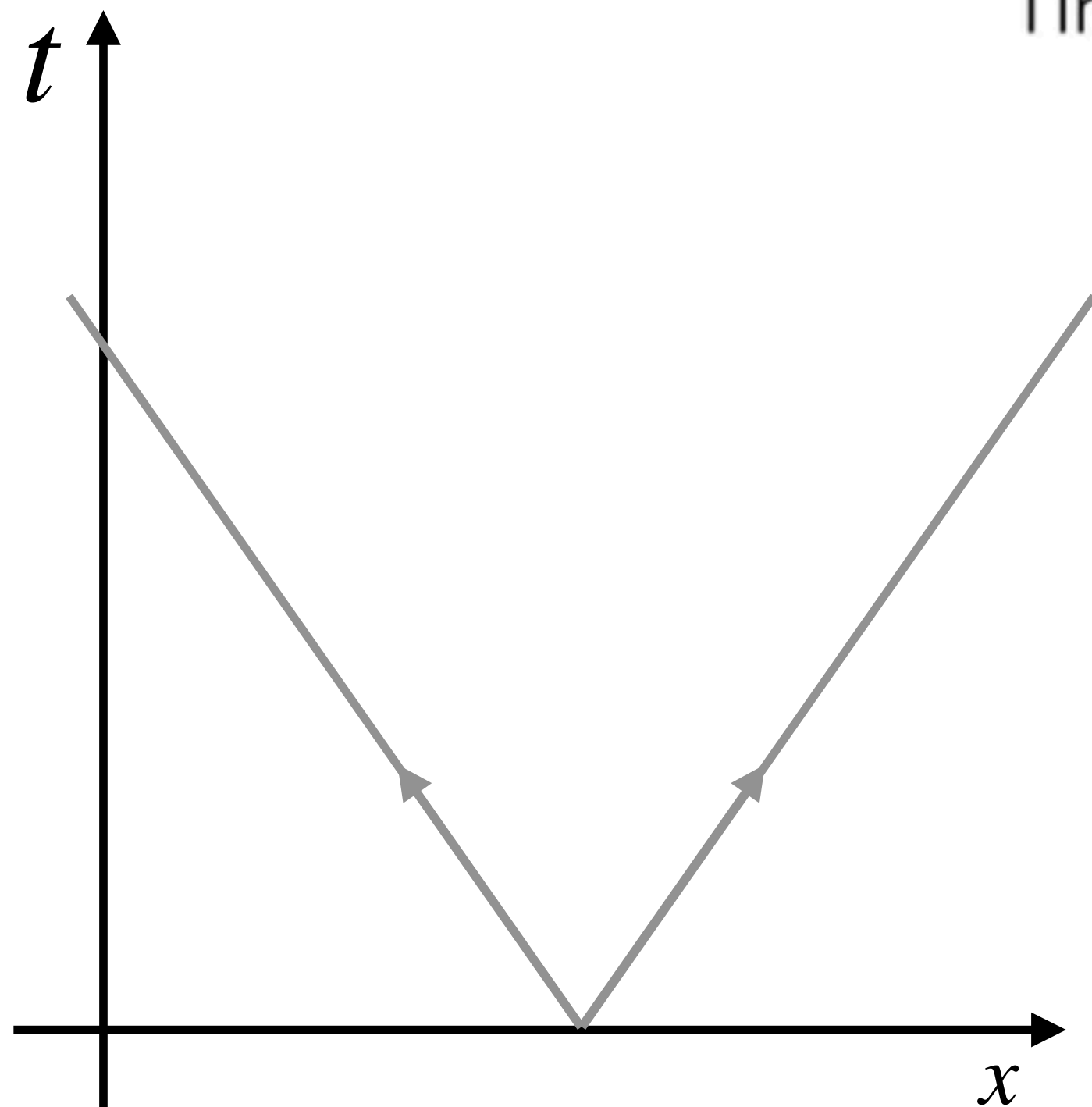
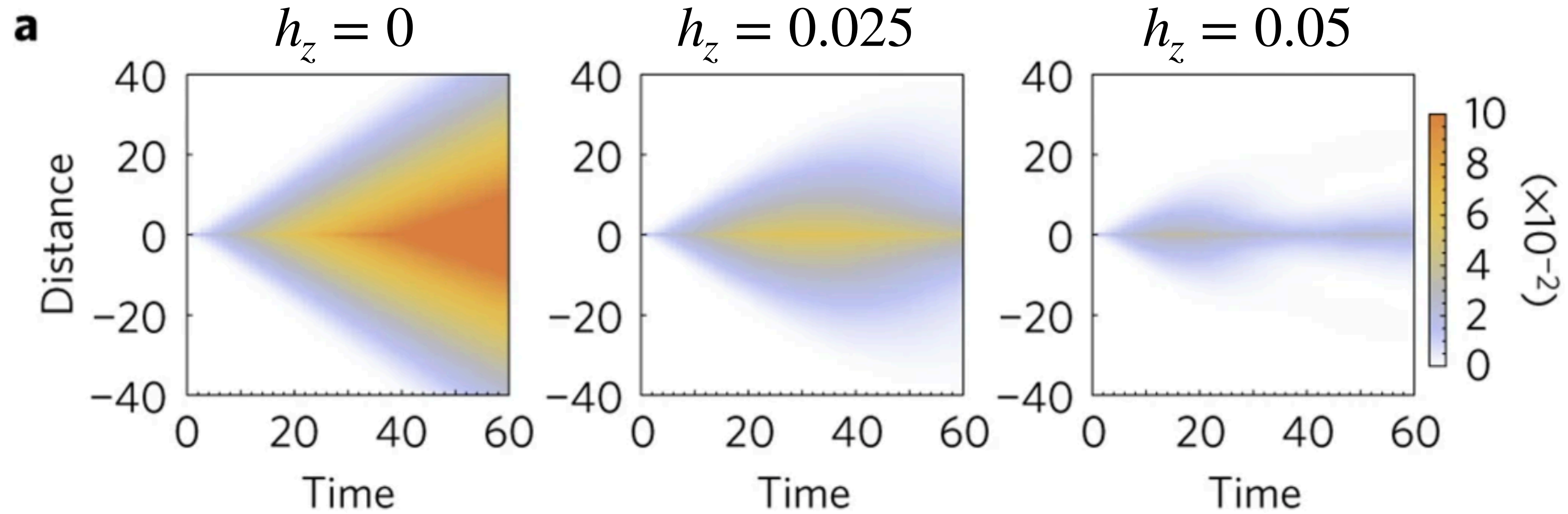

$|\Psi_0\rangle$ acts as a source of excitations

And

$$v_k = \frac{d\varepsilon}{dk} \quad v_{max} \geq v_k \quad \forall k$$

Lieb-Robinson bound

Quasi-particle Picture

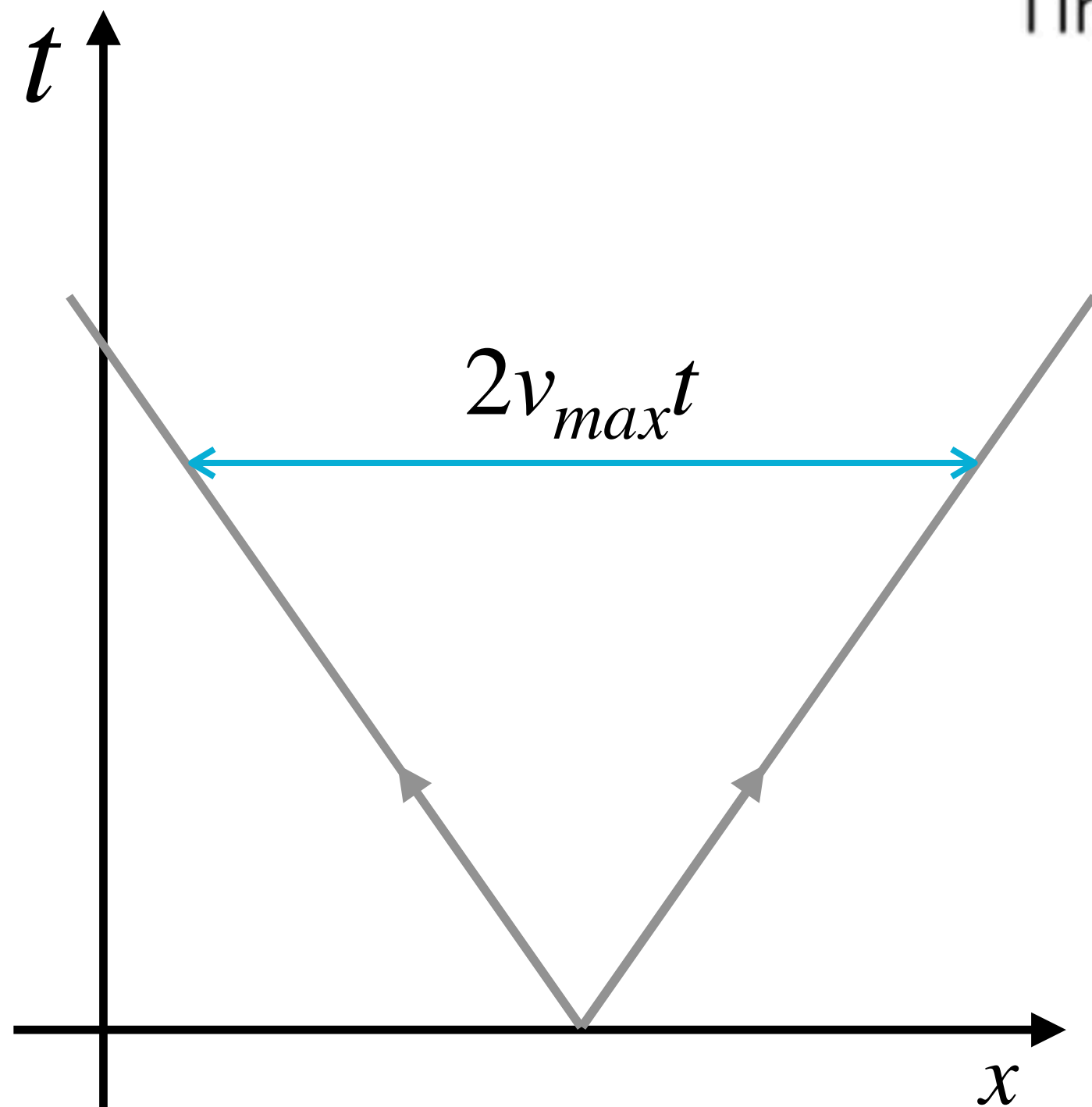
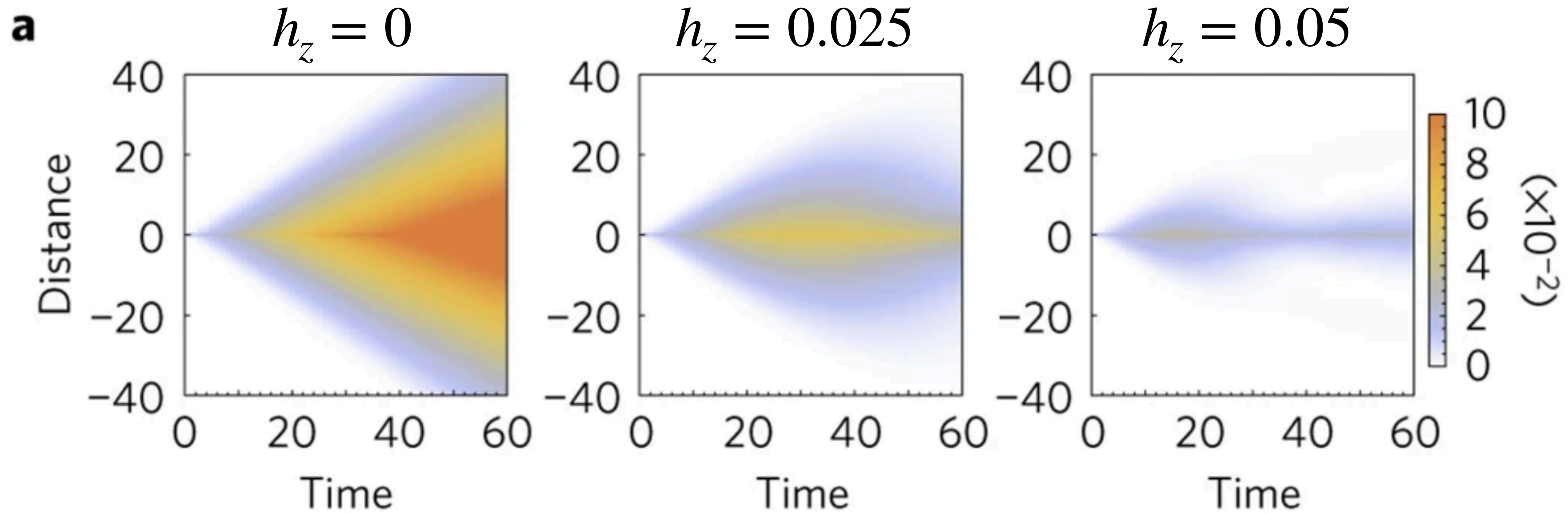

$|\Psi_0\rangle$ acts as a source of excitations

And

$$v_k = \frac{d\varepsilon}{dk} \quad v_{max} \geq v_k \quad \forall k$$

Lieb-Robinson bound

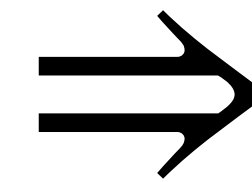

All correlators vanishing for

$$d > 2v_{max}t$$

Calabrese, Cardy PRL 2006

Secondary light cone

b

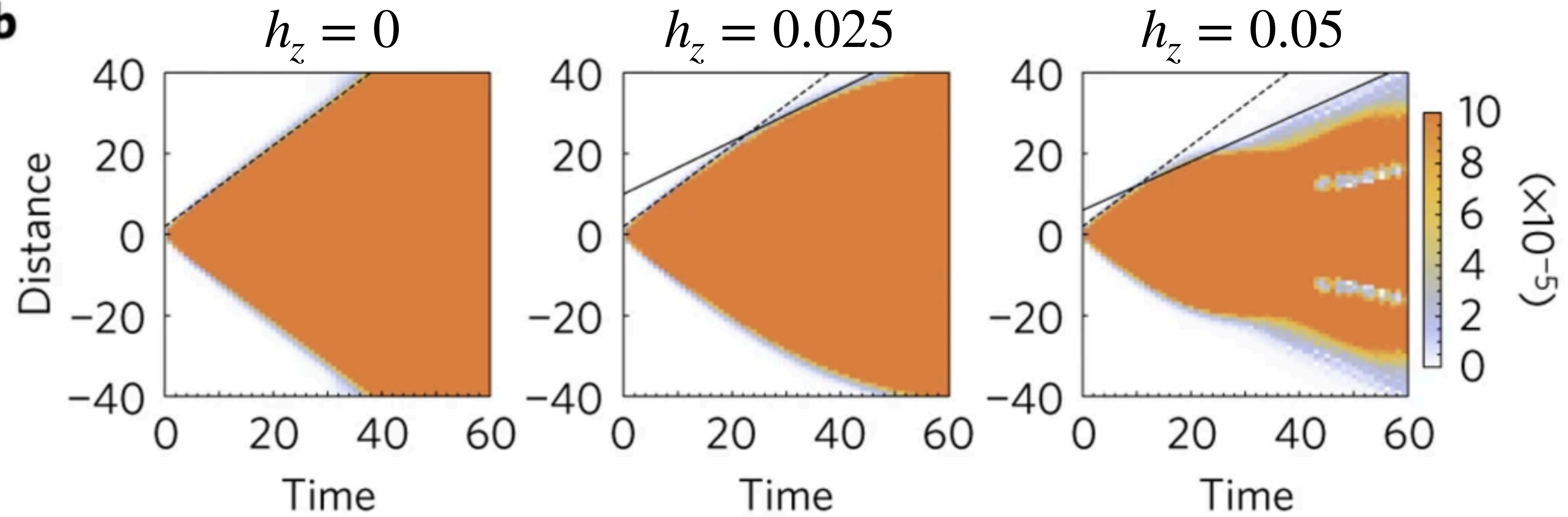

Absence for $h_x > 1$

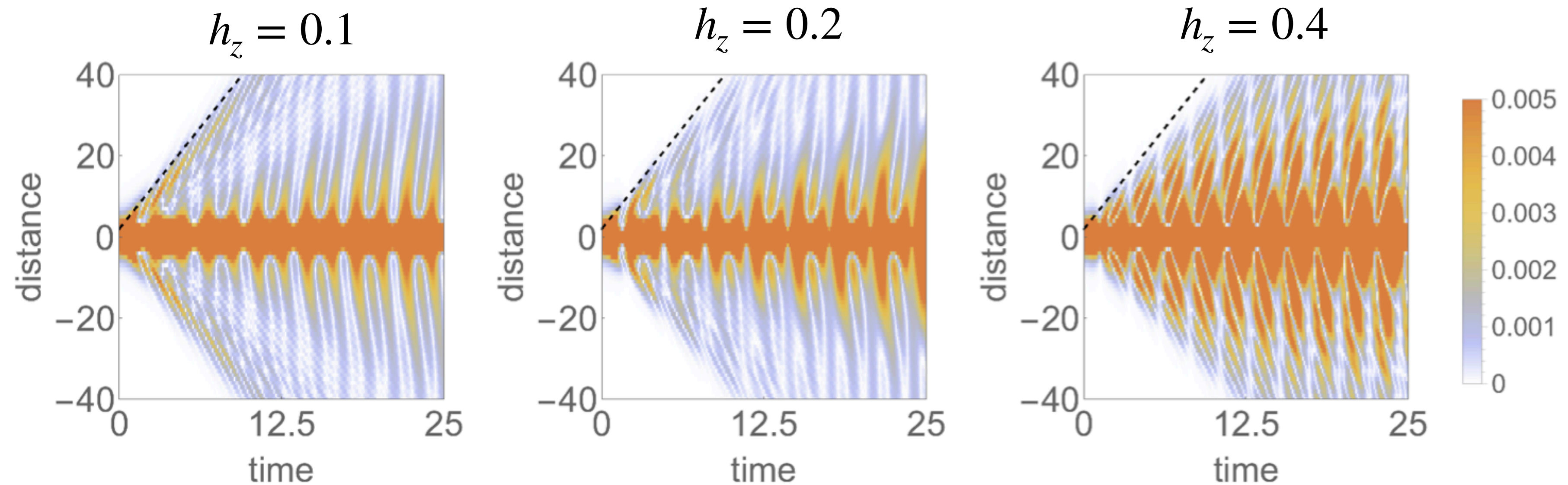

Experiments

Trapped Ions

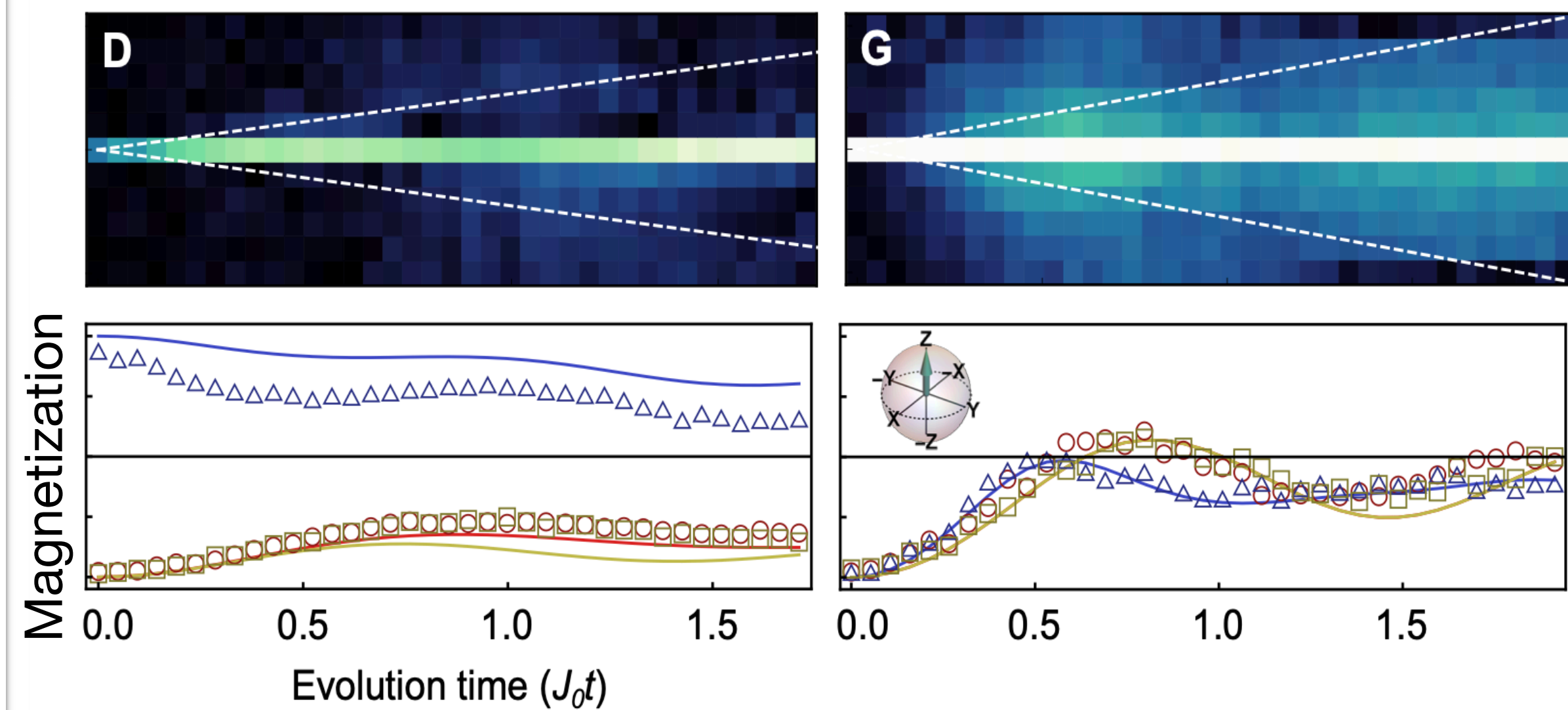

W.L. Tan et al Nature Physics 2021

IBM Quantum computer

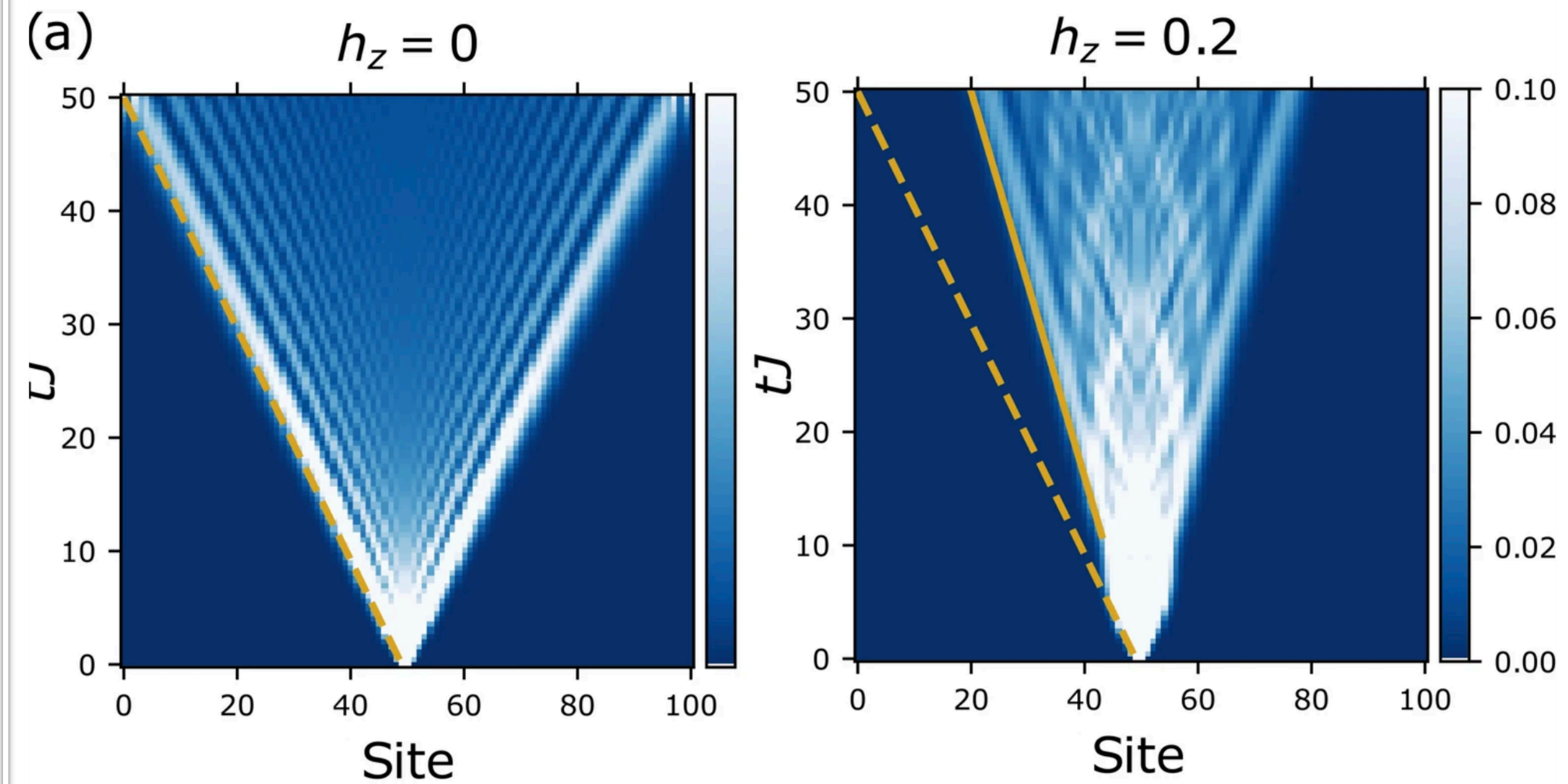

W.L. Tan et al Nature Physics 2021

False Vacuum Decay

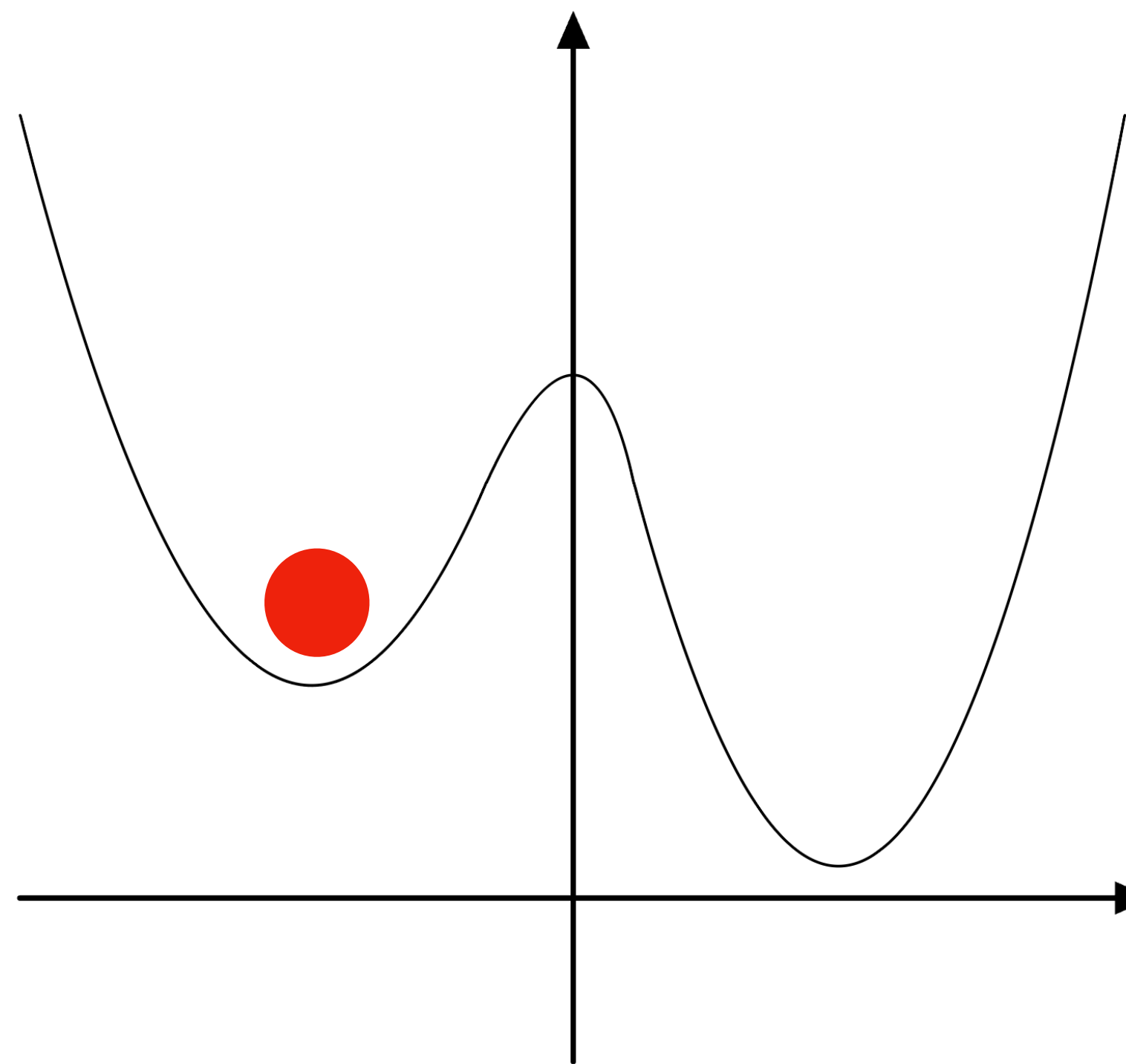
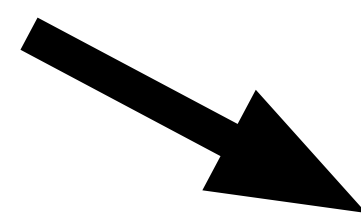
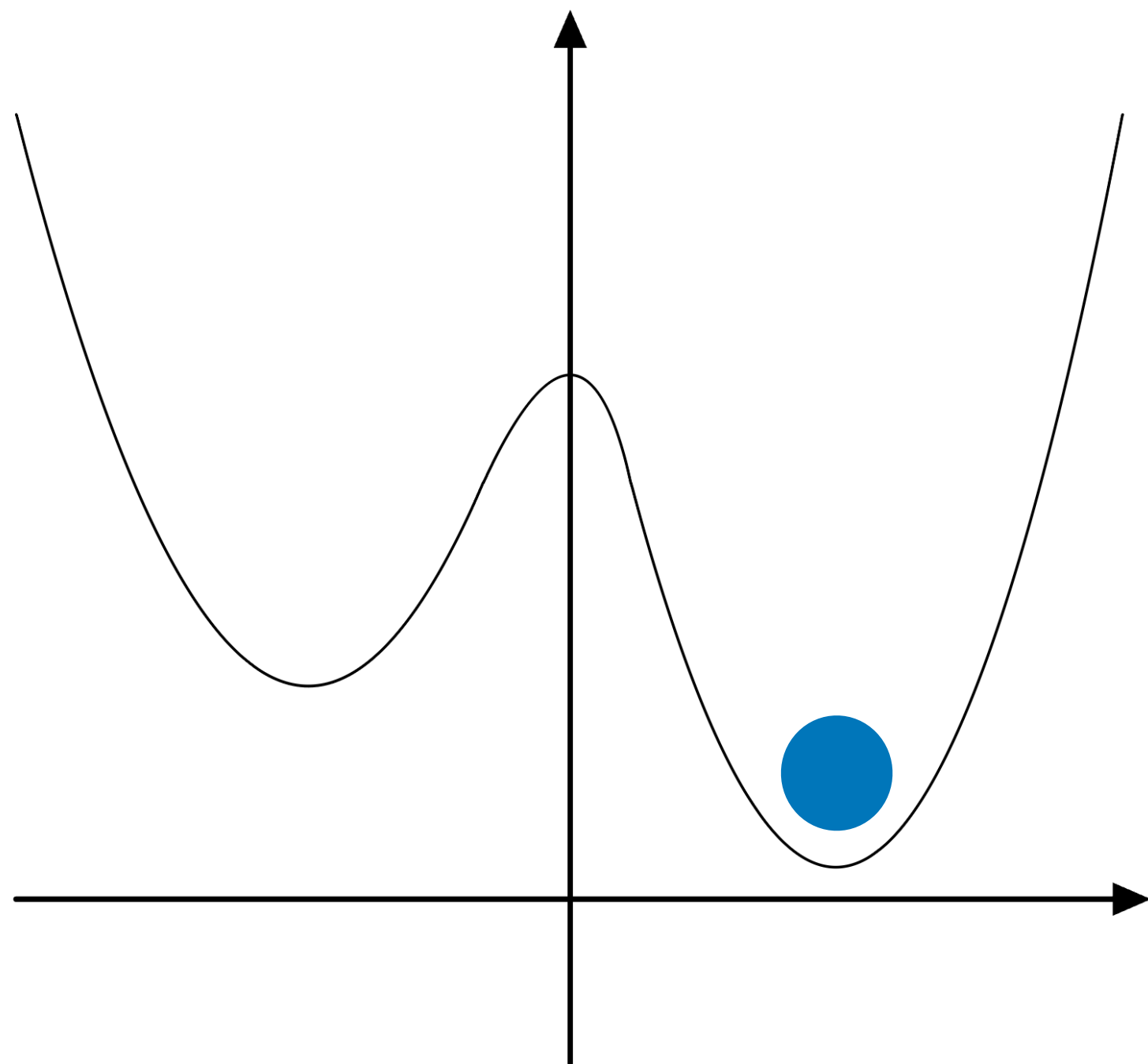

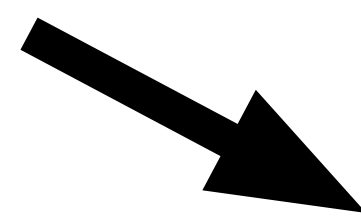
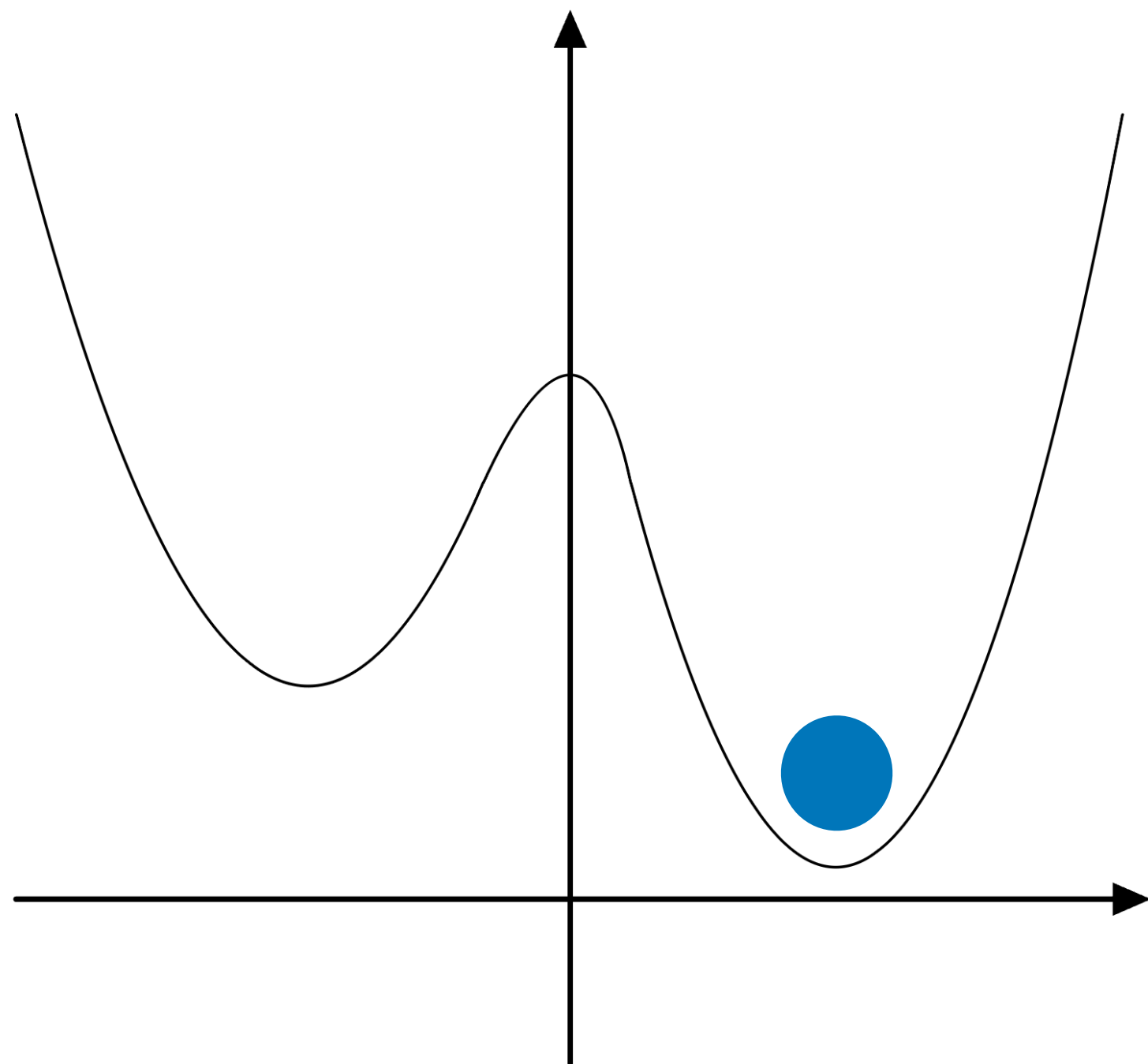

Decay by quantum fluctuations

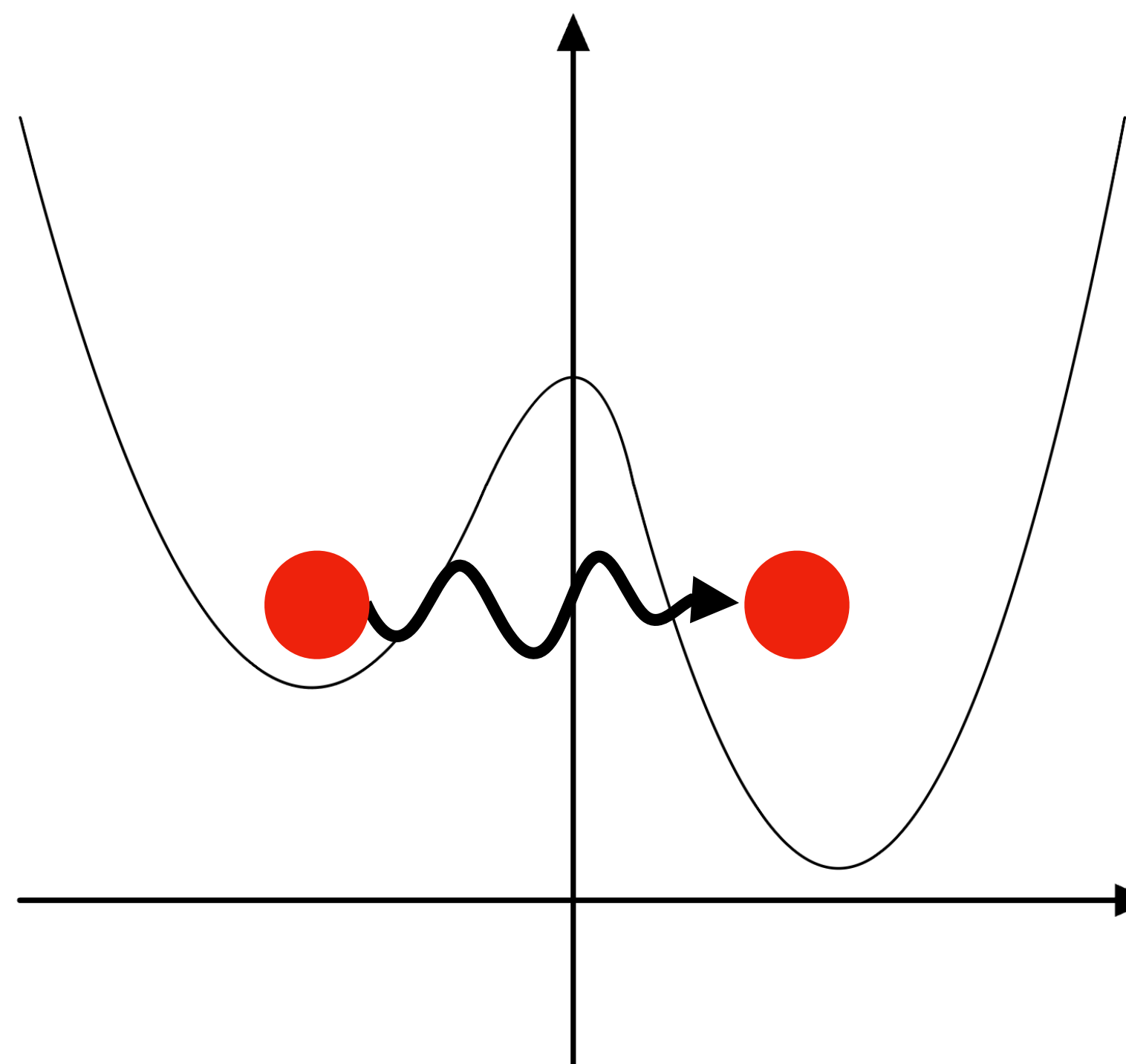

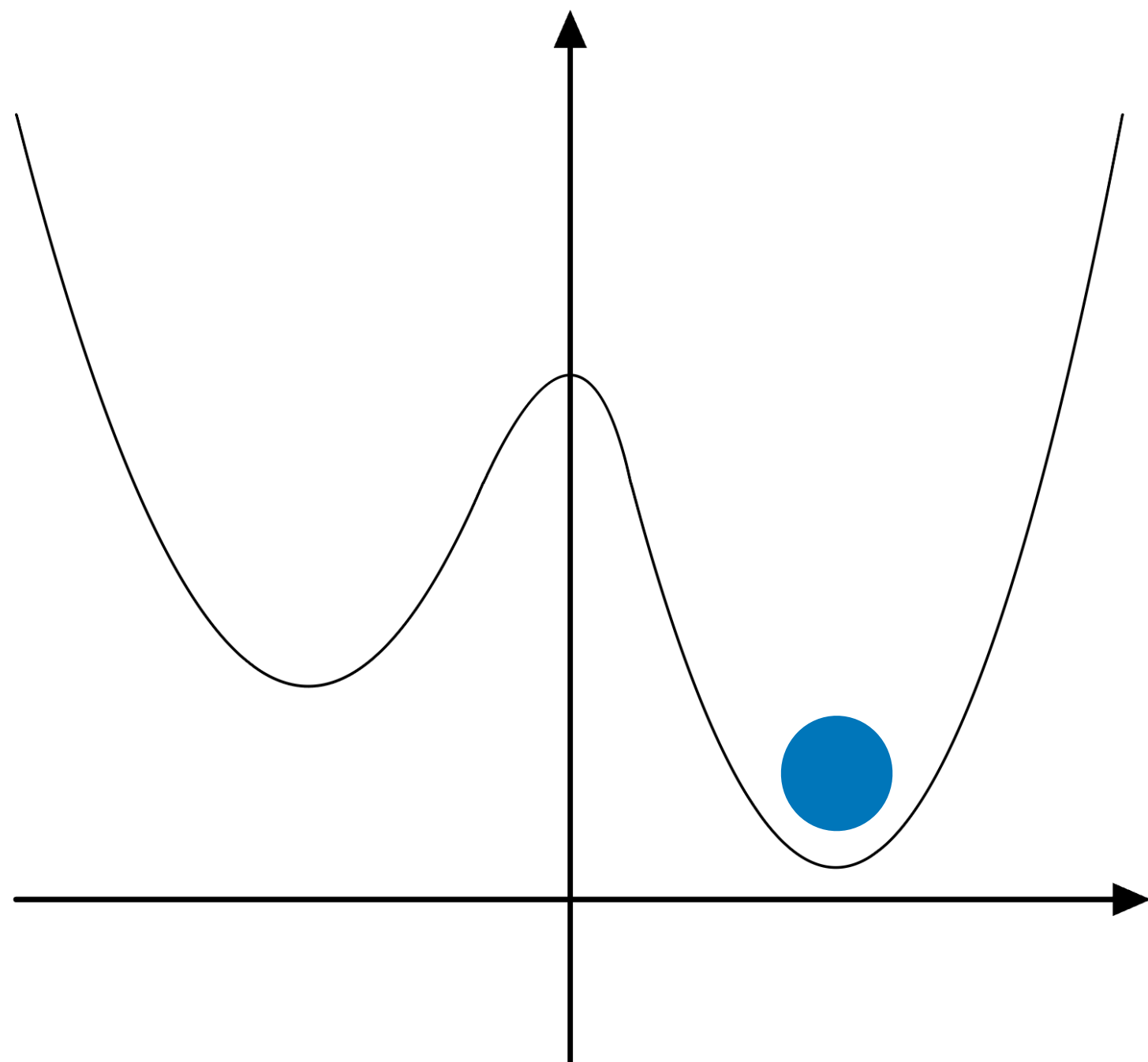

Decay by quantum fluctuations

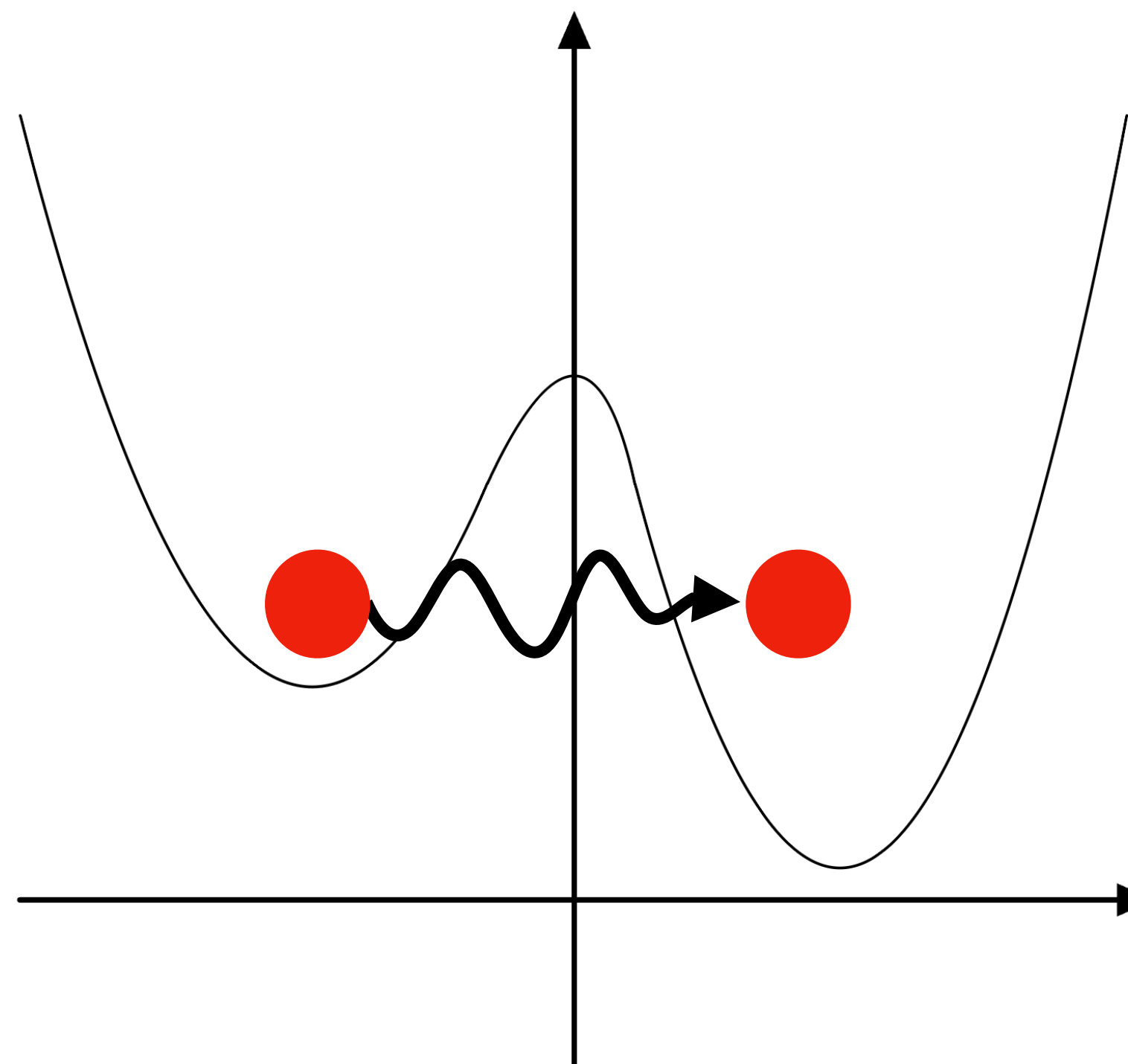
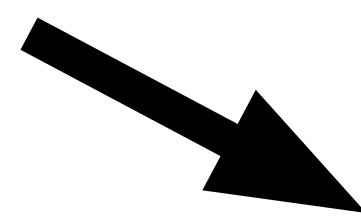

$$|\langle FV | U(t) | FV \rangle|^2 \approx \exp(-L \gamma t)$$

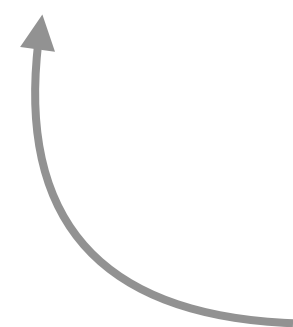

Unitary time evolution

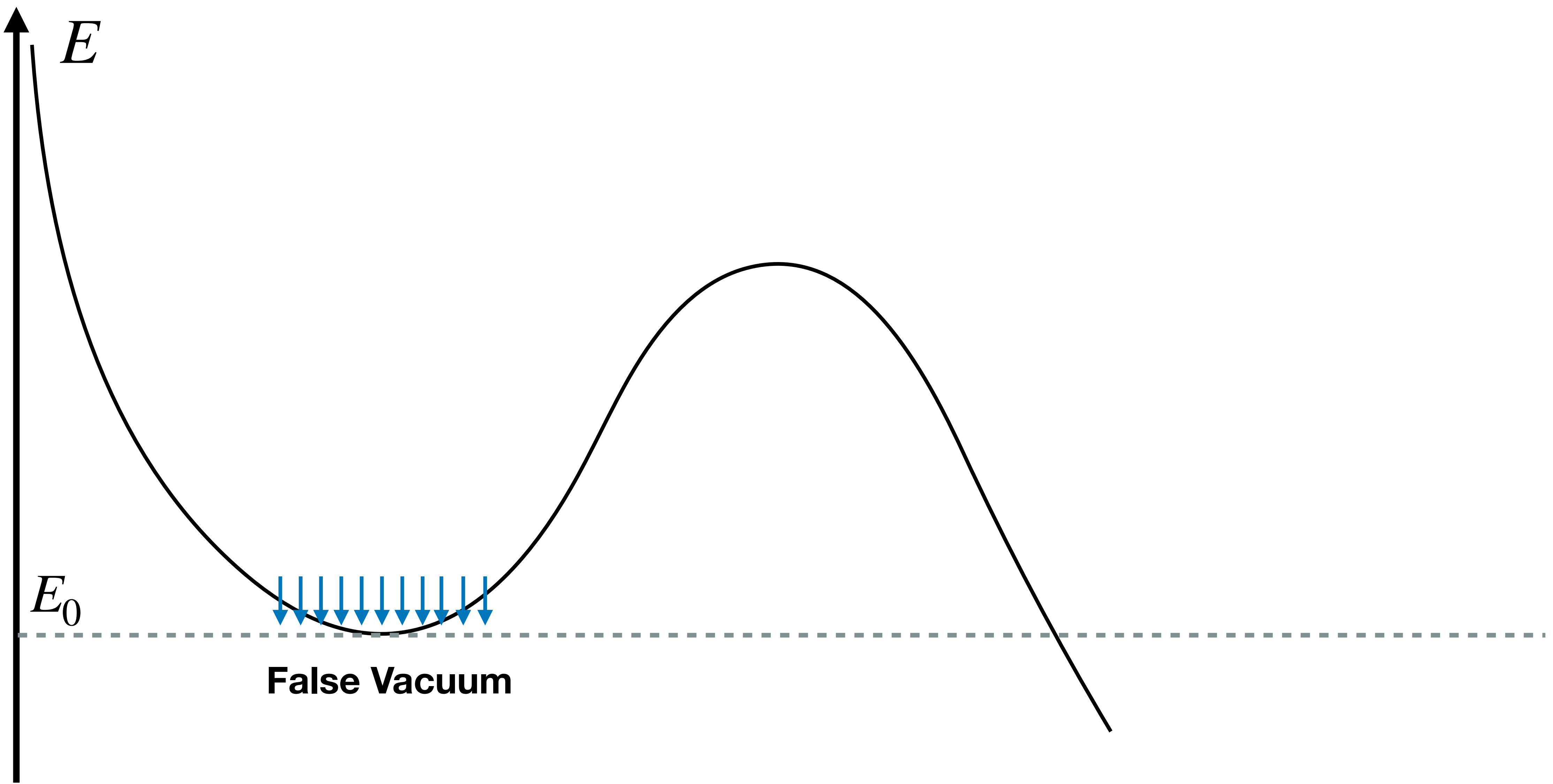

False Vacuum

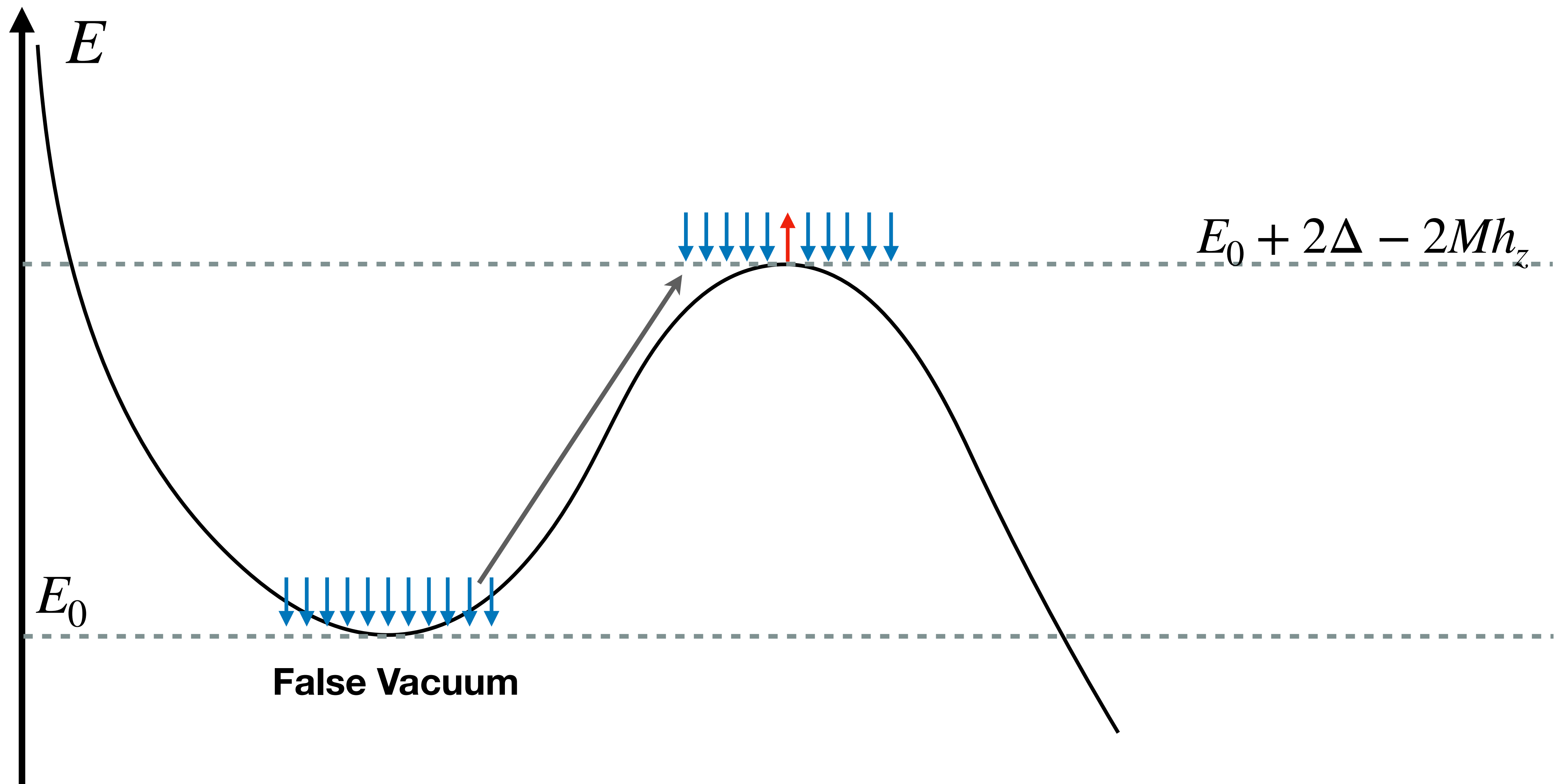

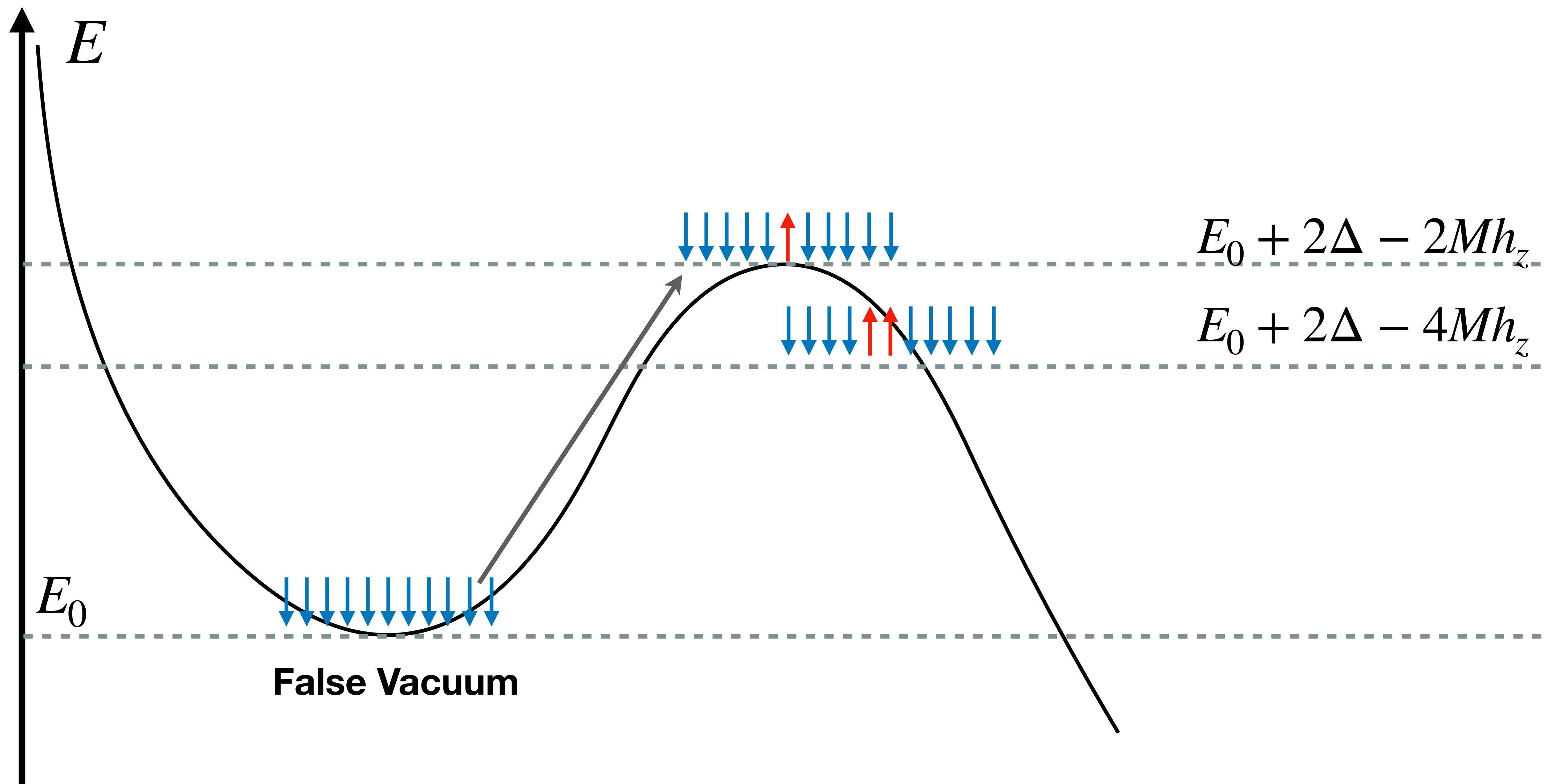

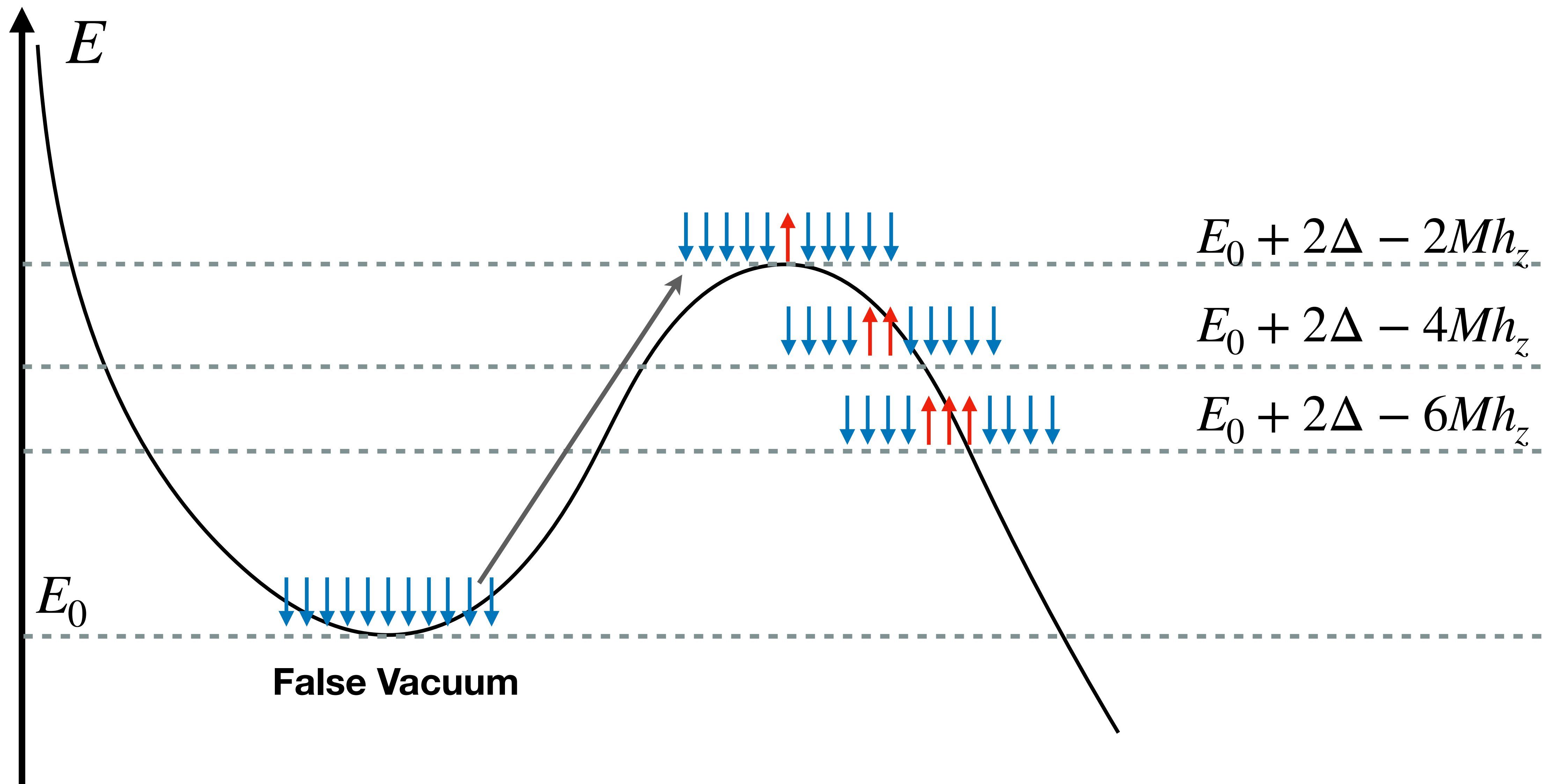

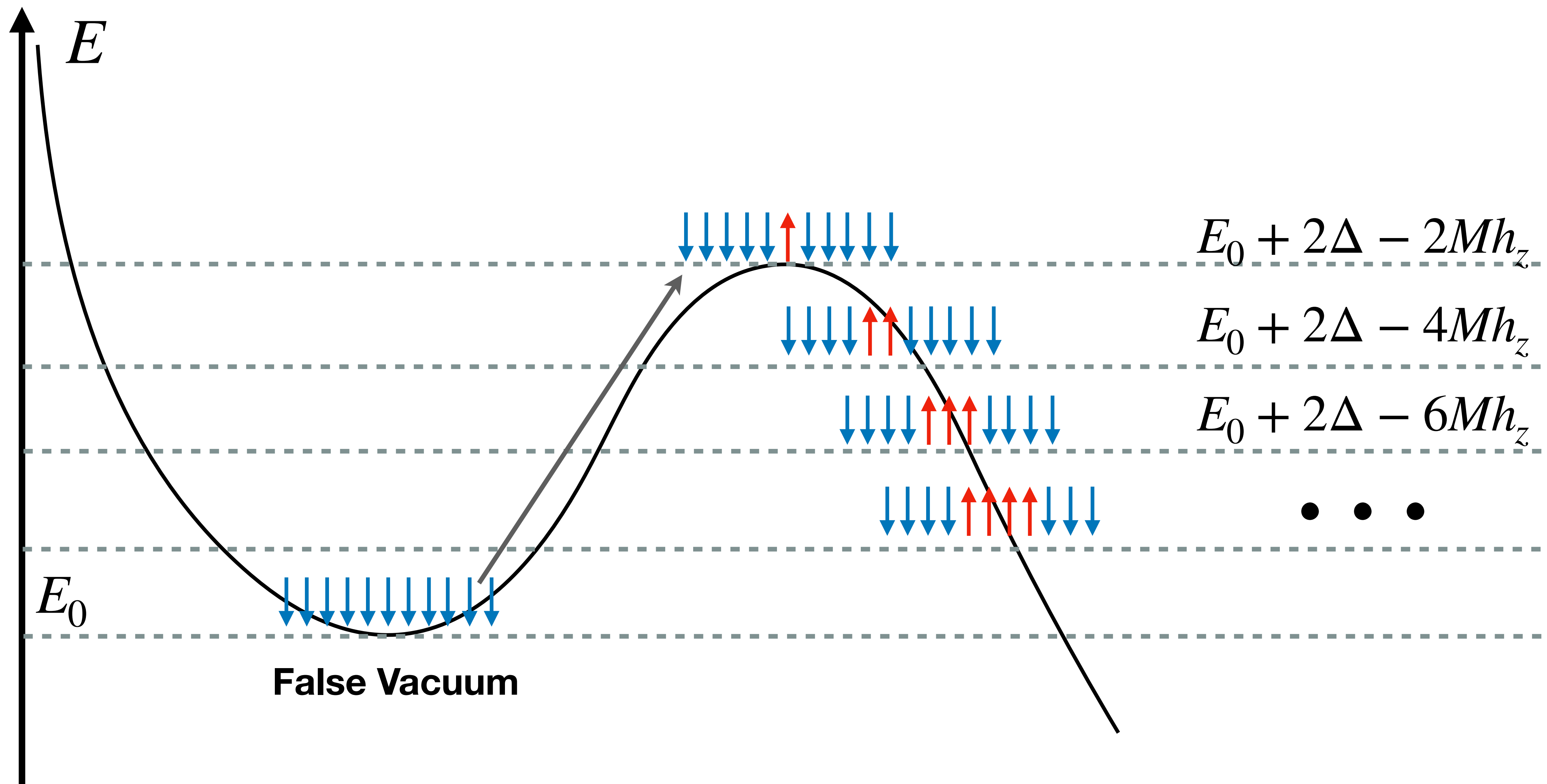

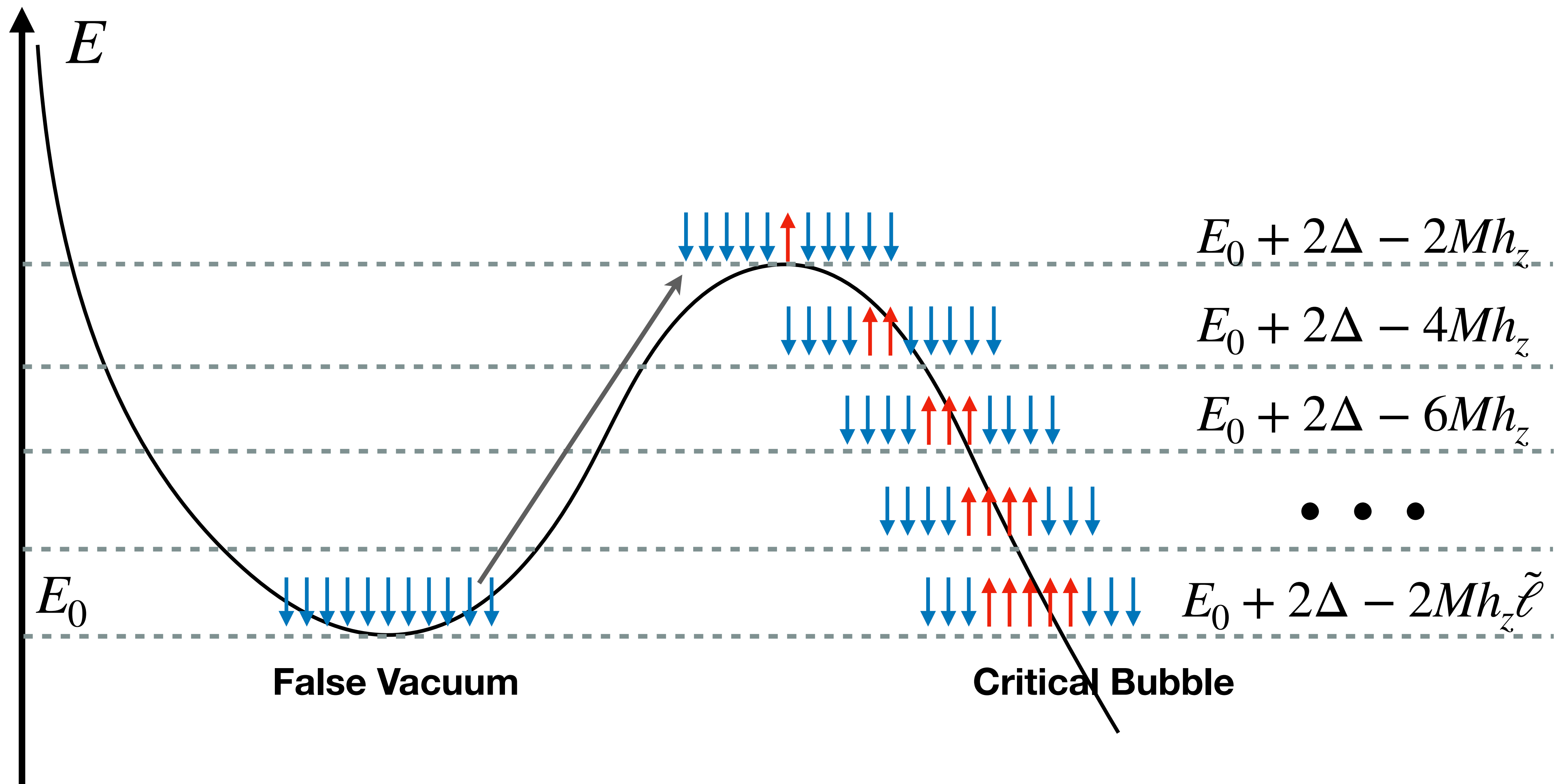

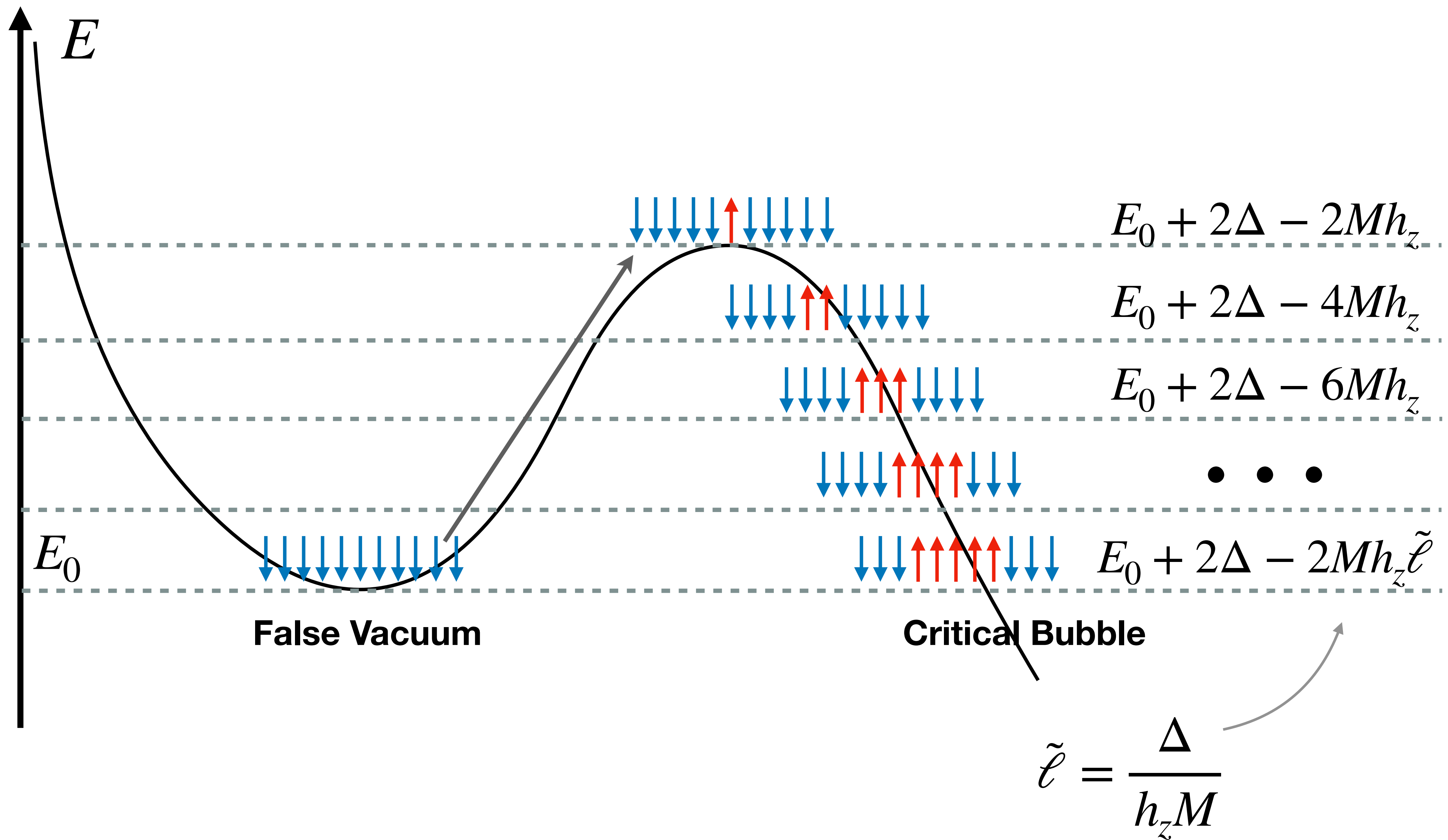

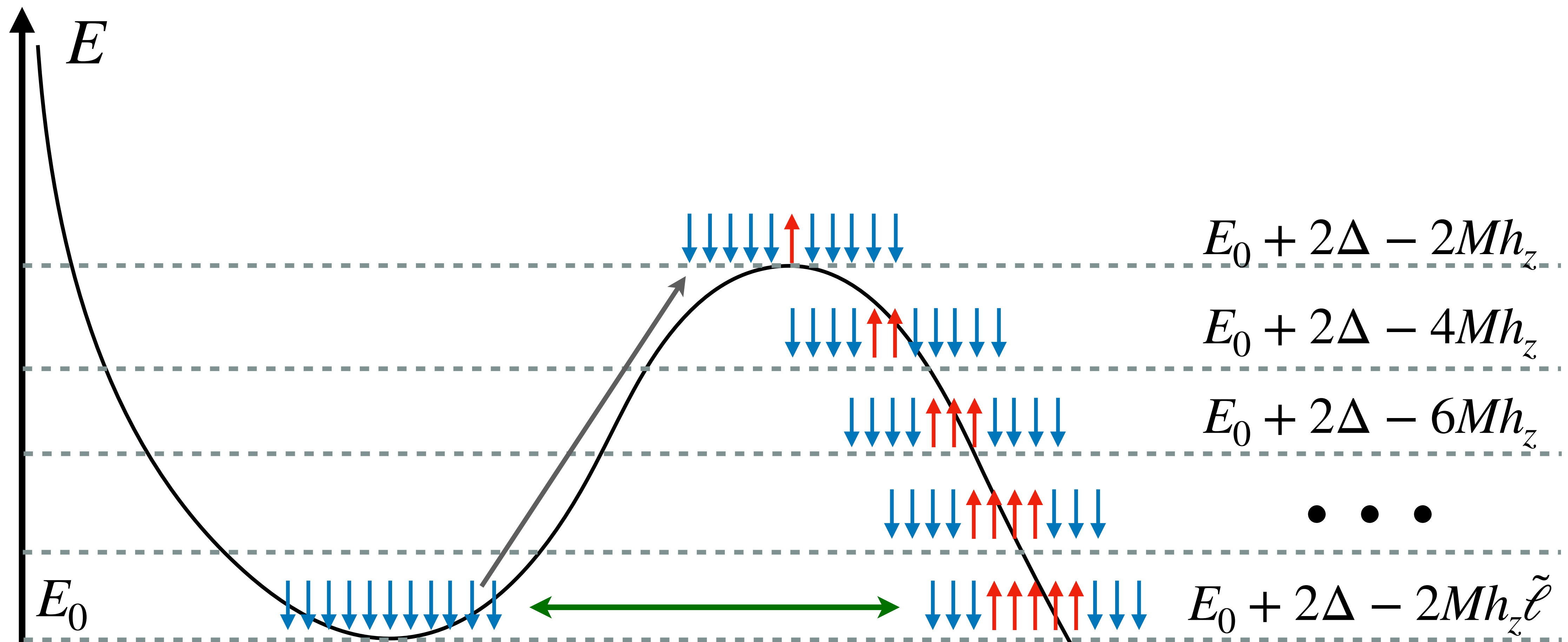

False Vacuum

Critical Bubble

$$\gamma \approx \exp(-c\tilde{\ell}) \approx \exp(-c'/h_z)$$

$$\tilde{\ell} = \frac{\Delta}{h_z M}$$

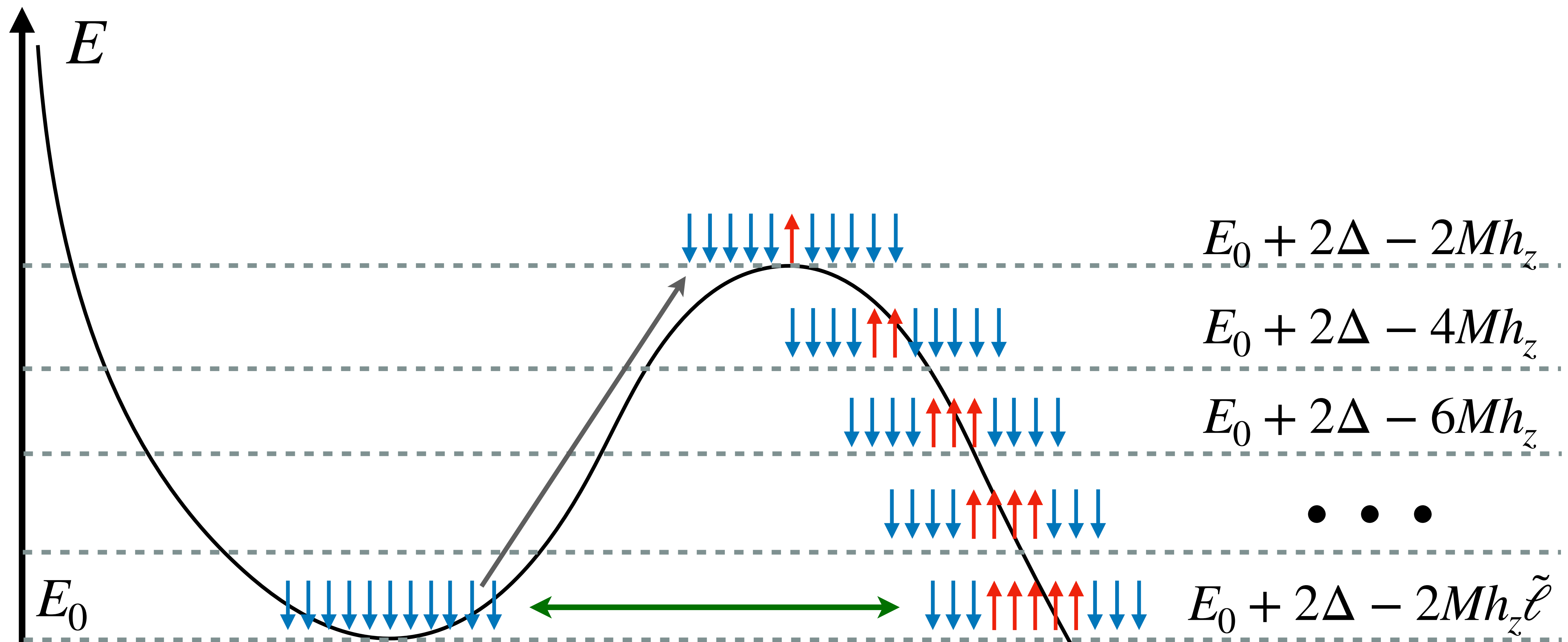

$$\gamma \approx \exp(-c\tilde{\ell}) \approx \exp(-c'/h_z)$$

$$\tilde{\ell} = \frac{\Delta}{h_z M}$$

$h_z M \ll \Delta$ Rutkevich 1999 PRB

The Quench Protocol

1 - Prepare $|\psi_{\downarrow}\rangle = \bigotimes_i |\downarrow\rangle_i$: Ground state of $H(h_x = 0, h_z = 0)$

The Quench Protocol

1 - Prepare $|\psi_{\downarrow}\rangle = \otimes_i |\downarrow\rangle_i$: Ground state of $H(h_x = 0, h_z = 0)$

2 - Approach ground state of $H(0 < h_x < 1, -h_z)$:

$$|0\rangle = \exp[-\tau H(h_x, -h_z)] |\psi_{\downarrow}\rangle$$

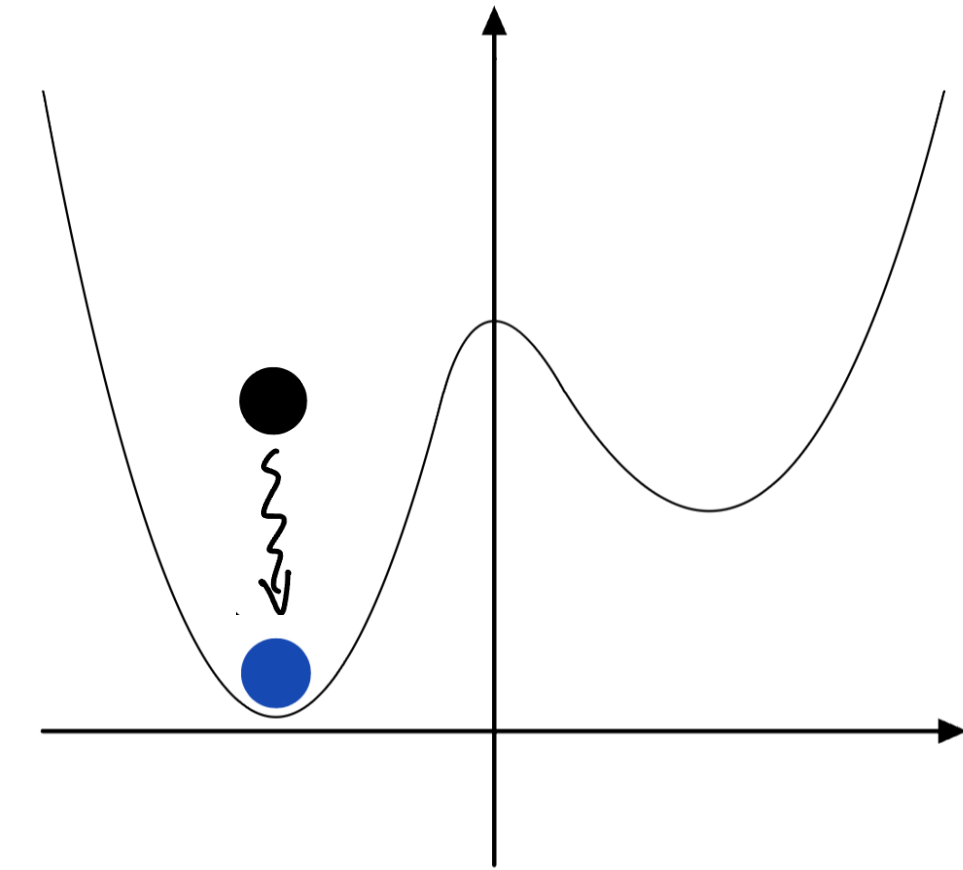

The Quench Protocol

1 - Prepare $|\psi_{\downarrow}\rangle = \otimes_i |\downarrow\rangle_i$: Ground state of $H(h_x = 0, h_z = 0)$

2 - Approach ground state of $H(0 < h_x < 1, -h_z)$:

$$|0\rangle = \exp[-\tau H(h_x, -h_z)] |\psi_{\downarrow}\rangle$$

3 - **Switch $-h_z$ to $+h_z$** and evolve with $\exp[-i H(h_x, +h_z) t]$:

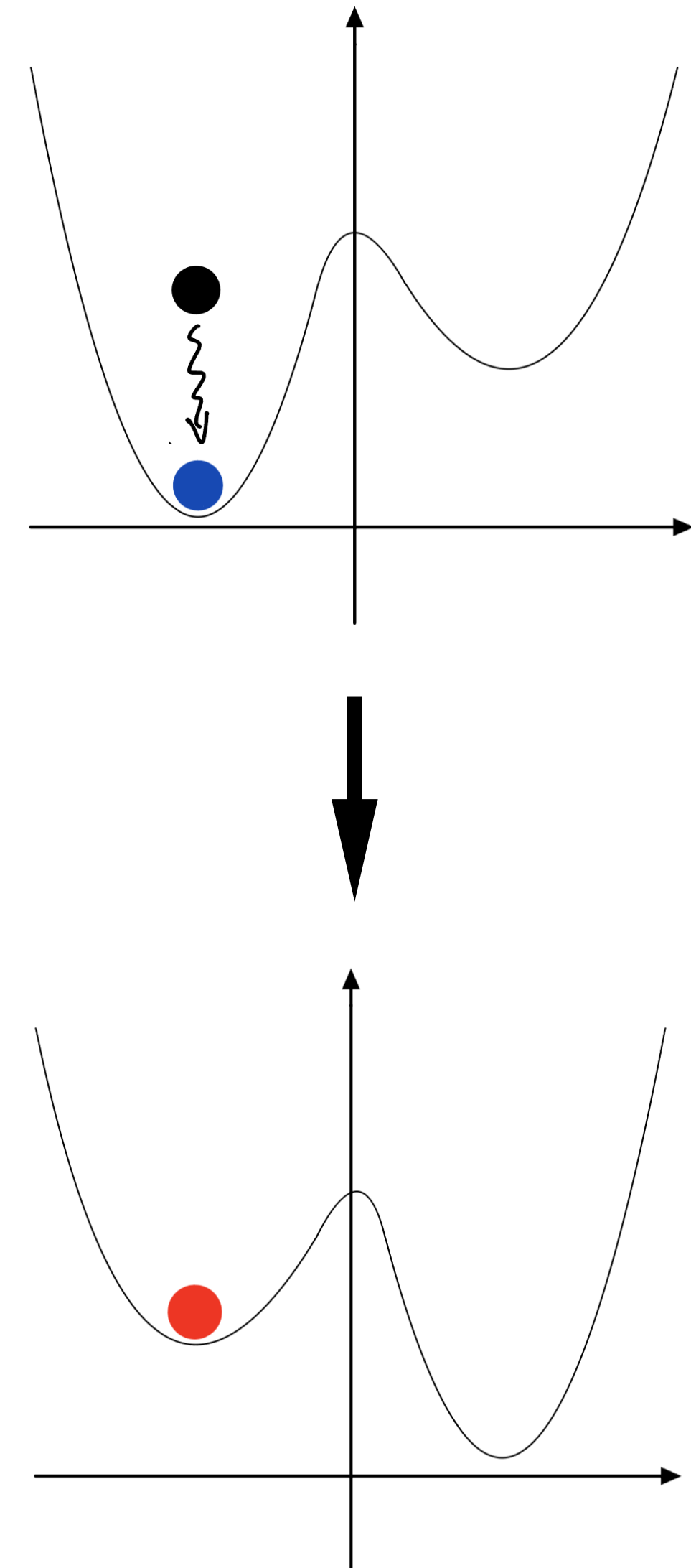

Rate extraction

Two-sites observable
 $G(t) = 1 - ||\rho(t) - \rho(0)||_1$

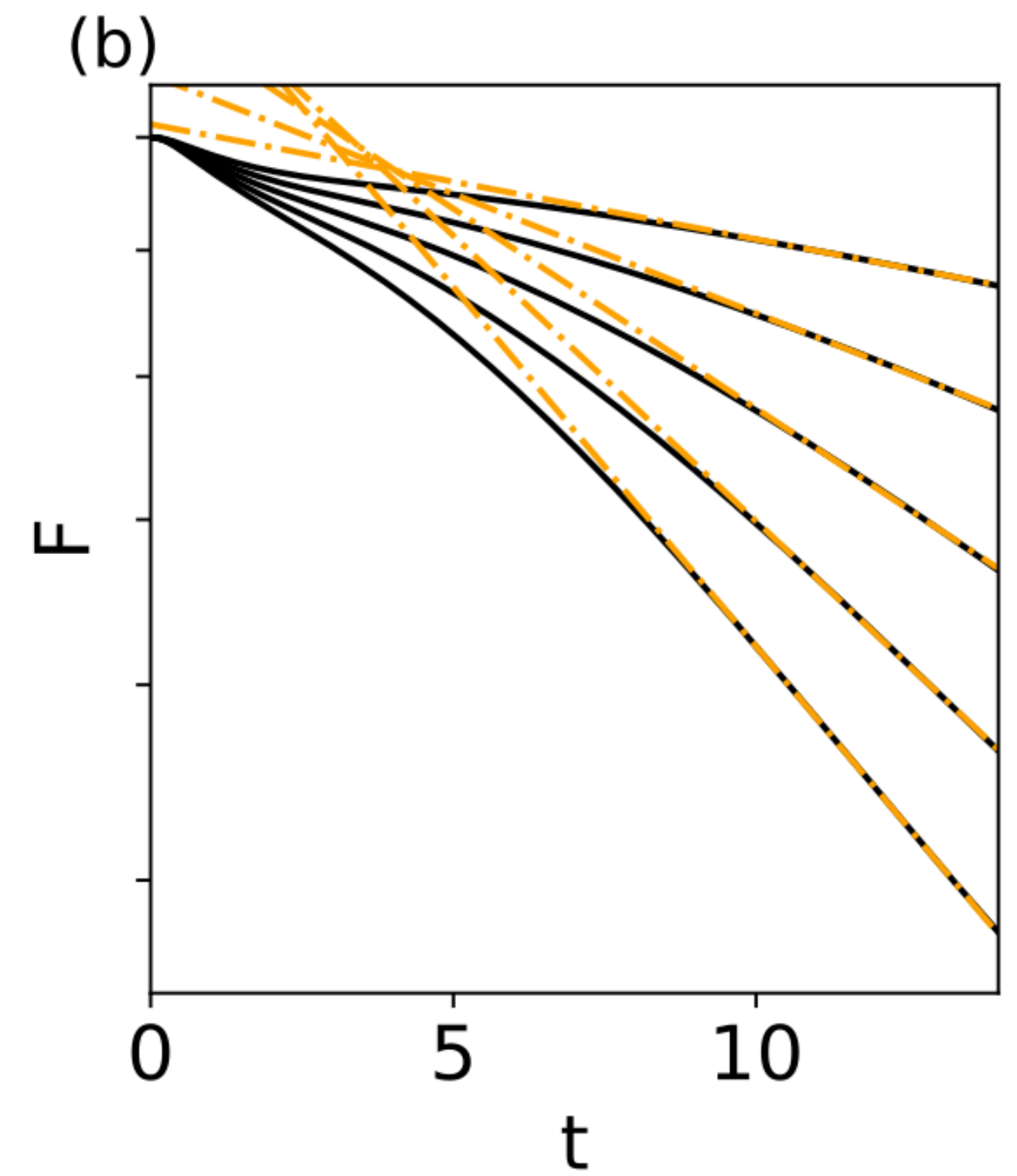
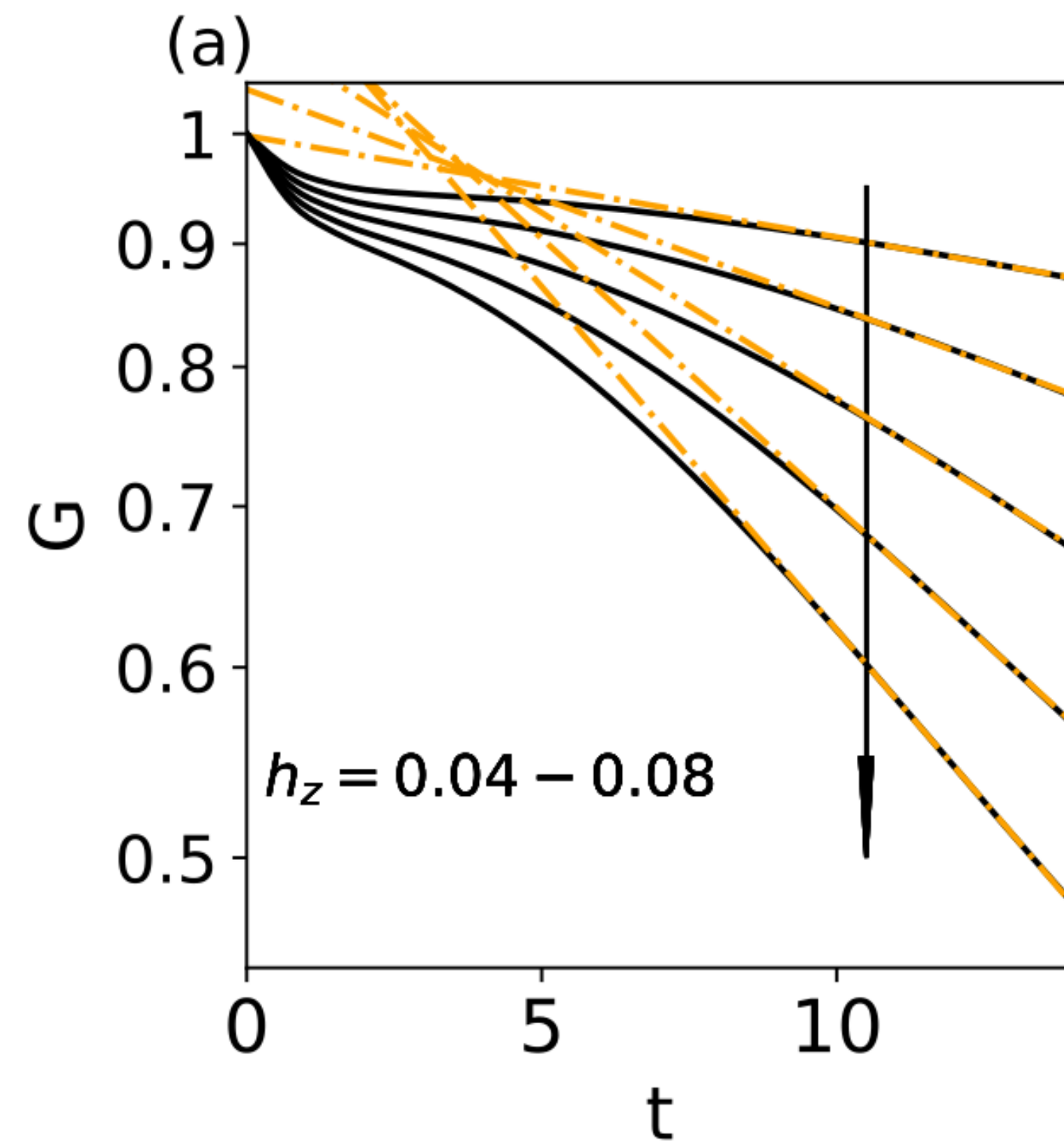

Rescaled Magnetisation

$$F(t) = \frac{\langle \sigma^z(t) \rangle + \langle \sigma^z(0) \rangle}{2\langle \sigma^z(0) \rangle}$$

Rate extraction

Two-sites observable
 $G(t) = 1 - ||\rho(t) - \rho(0)||_1$

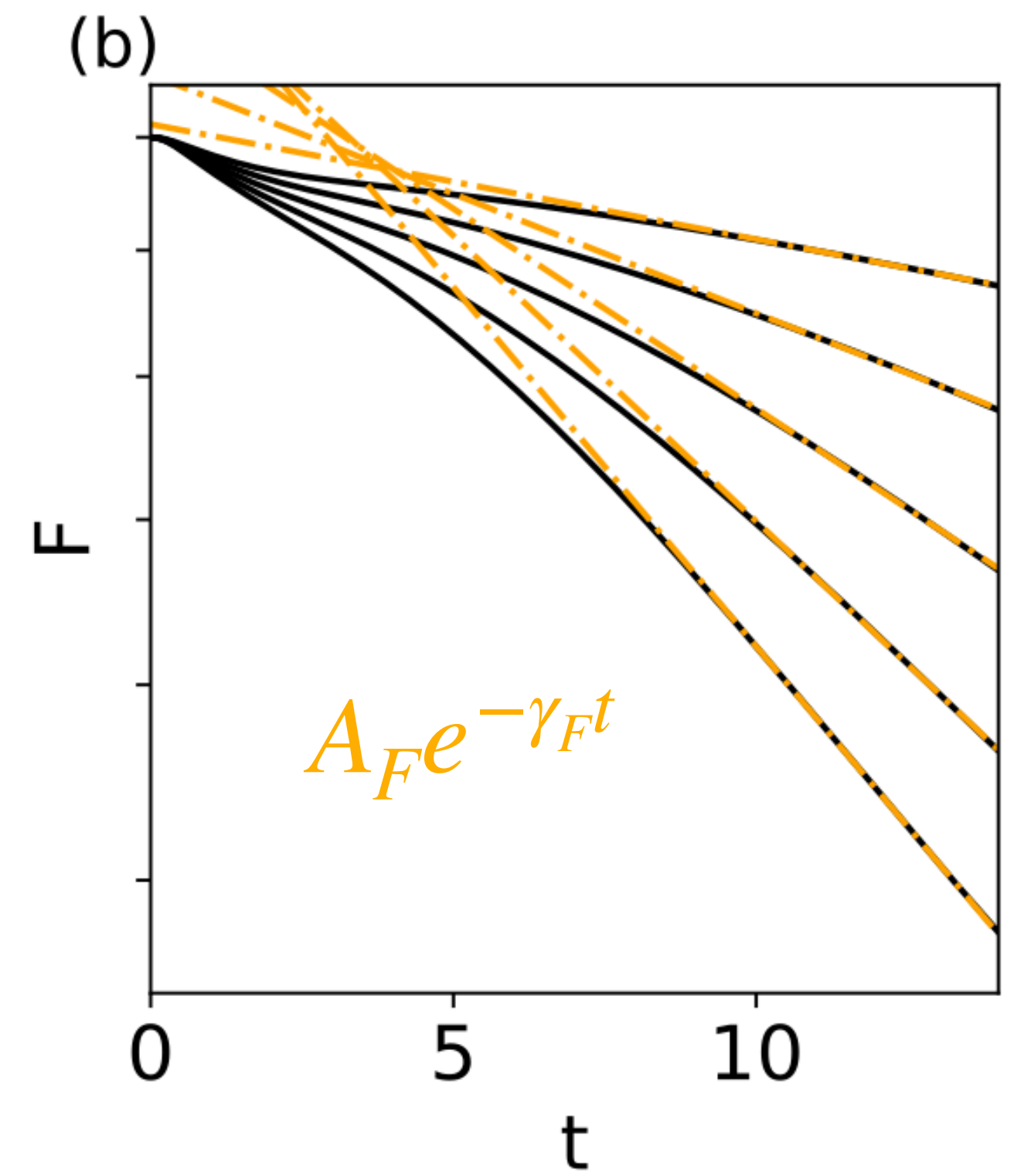
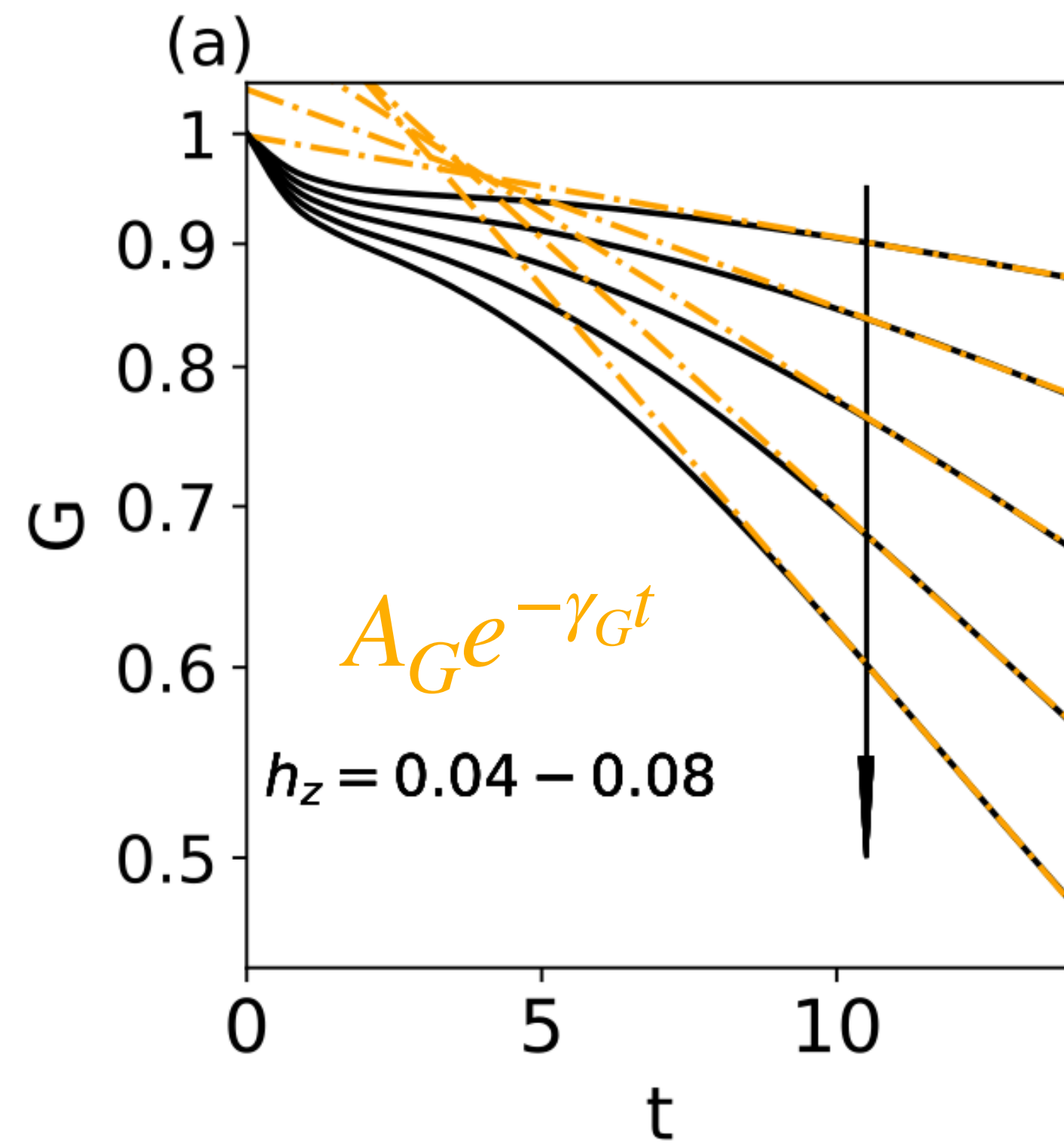

Rescaled Magnetisation

$$F(t) = \frac{\langle \sigma^z(t) \rangle + \langle \sigma^z(0) \rangle}{2\langle \sigma^z(0) \rangle}$$

Comparison with theoretical prediction

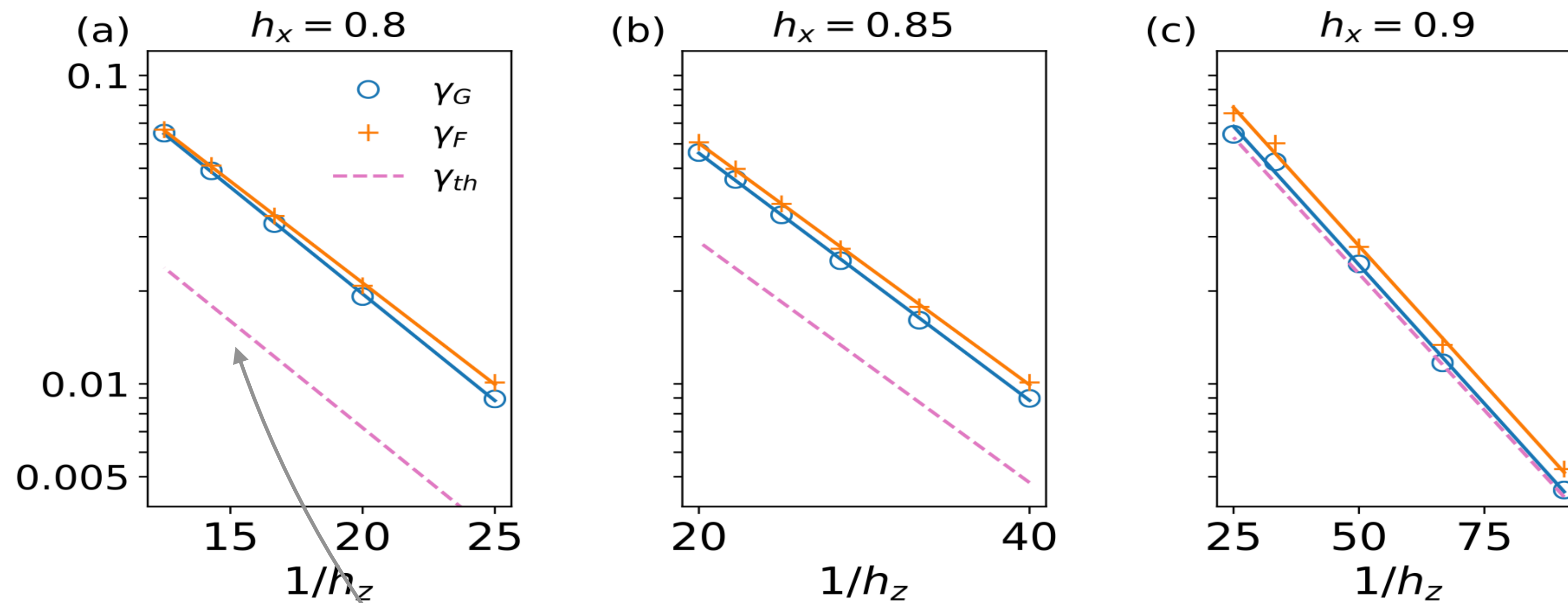

$$\gamma_{th} = c(h_x) \exp\left(-\frac{q_h}{h_z}\right)$$

Rutkevich 1999 PRB

Comparison with theoretical prediction

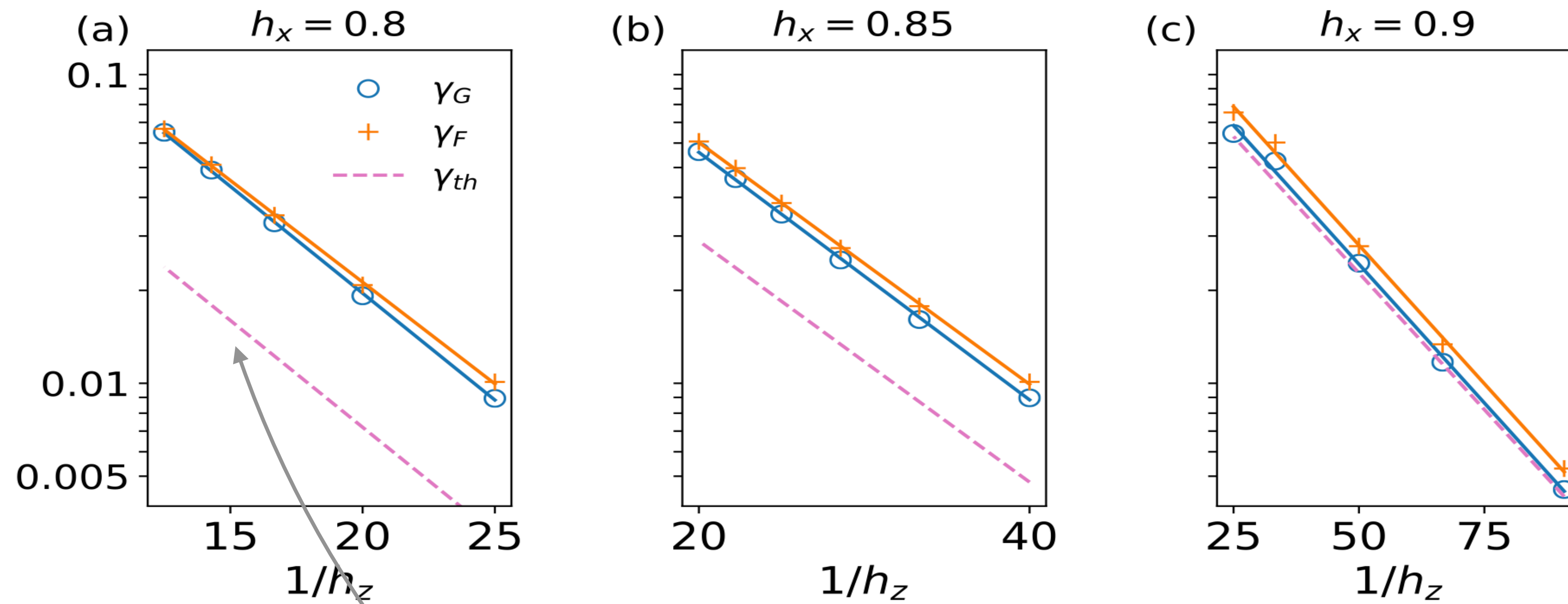

$$\gamma_{th} = c(h_x) \exp\left(-\frac{q_h}{h_z}\right)$$

Rutkevich 1999 PRB

Prefactor is off !

Comparison with theoretical prediction

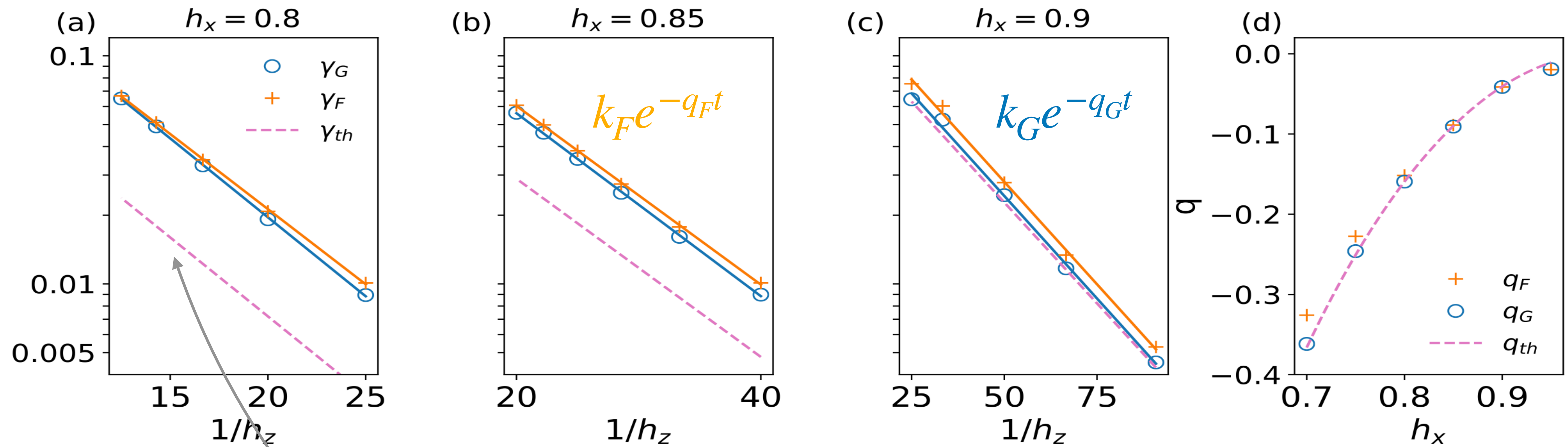

$$\gamma_{th} = c(h_x) \exp\left(-\frac{q_h}{h_z}\right)$$

Rutkevich 1999 PRB

Comparison with theoretical prediction

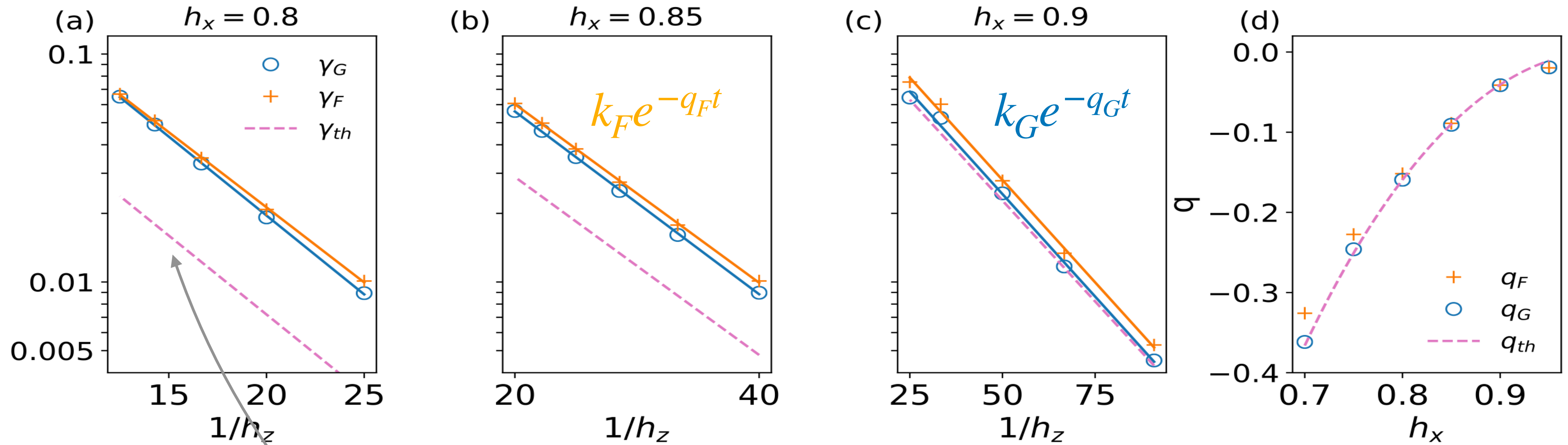

$$\gamma_{th} = c(h_x) \exp\left(-\frac{q_h}{h_z}\right)$$

Rutkevich 1999 PRB

Exponential coefficient is good!

More on the oscillations

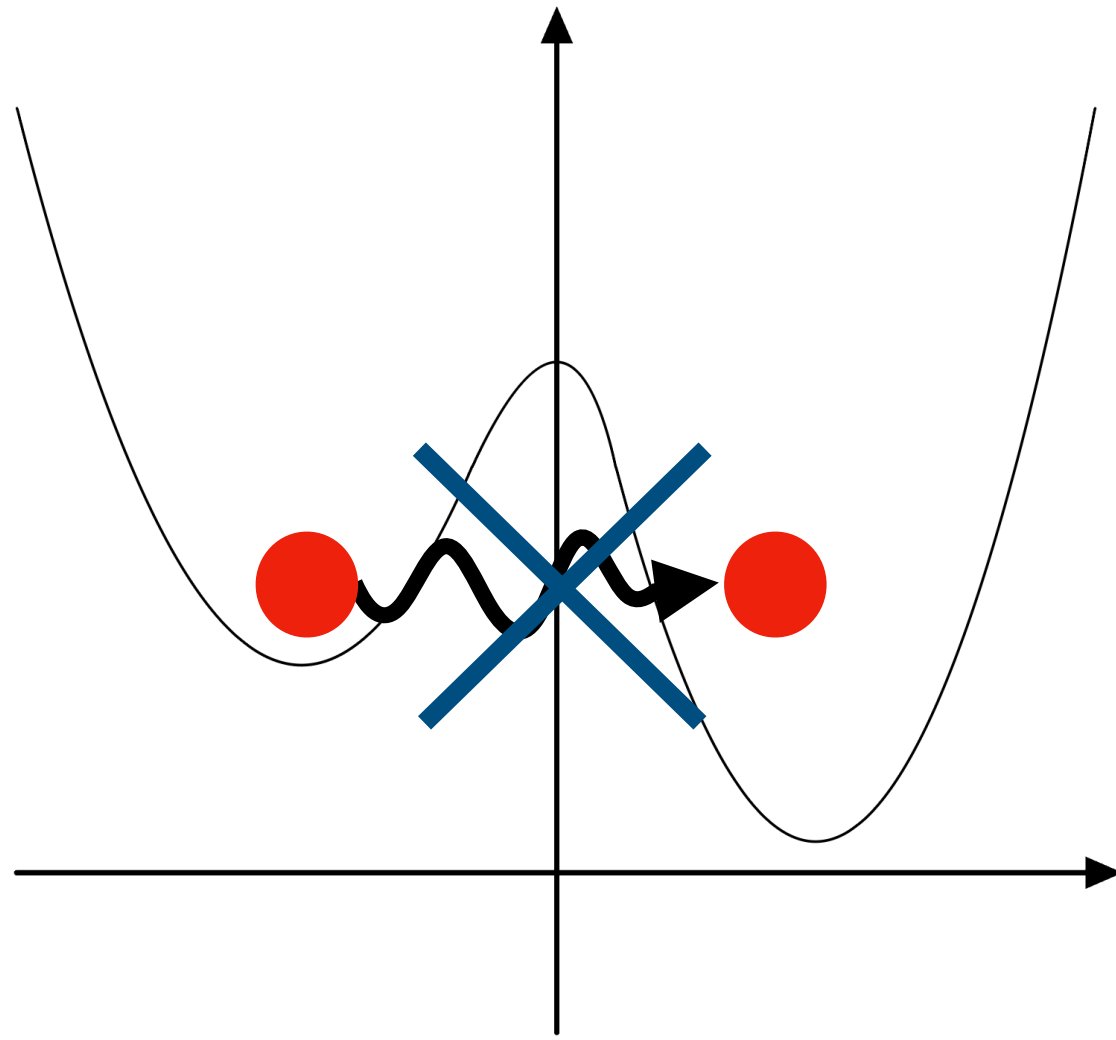

More on the oscillations

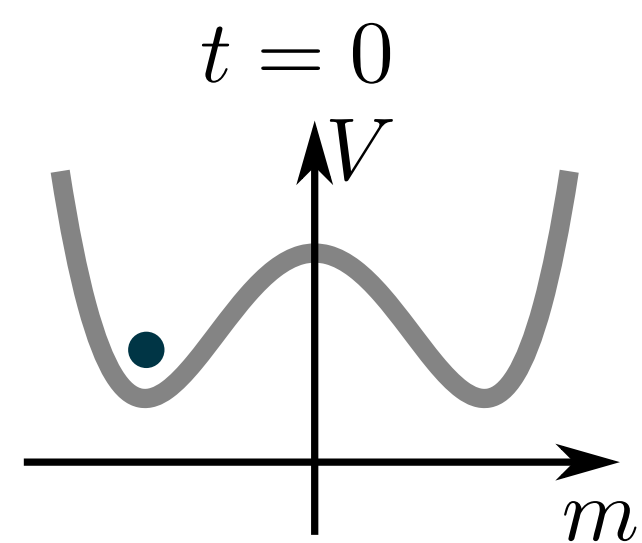
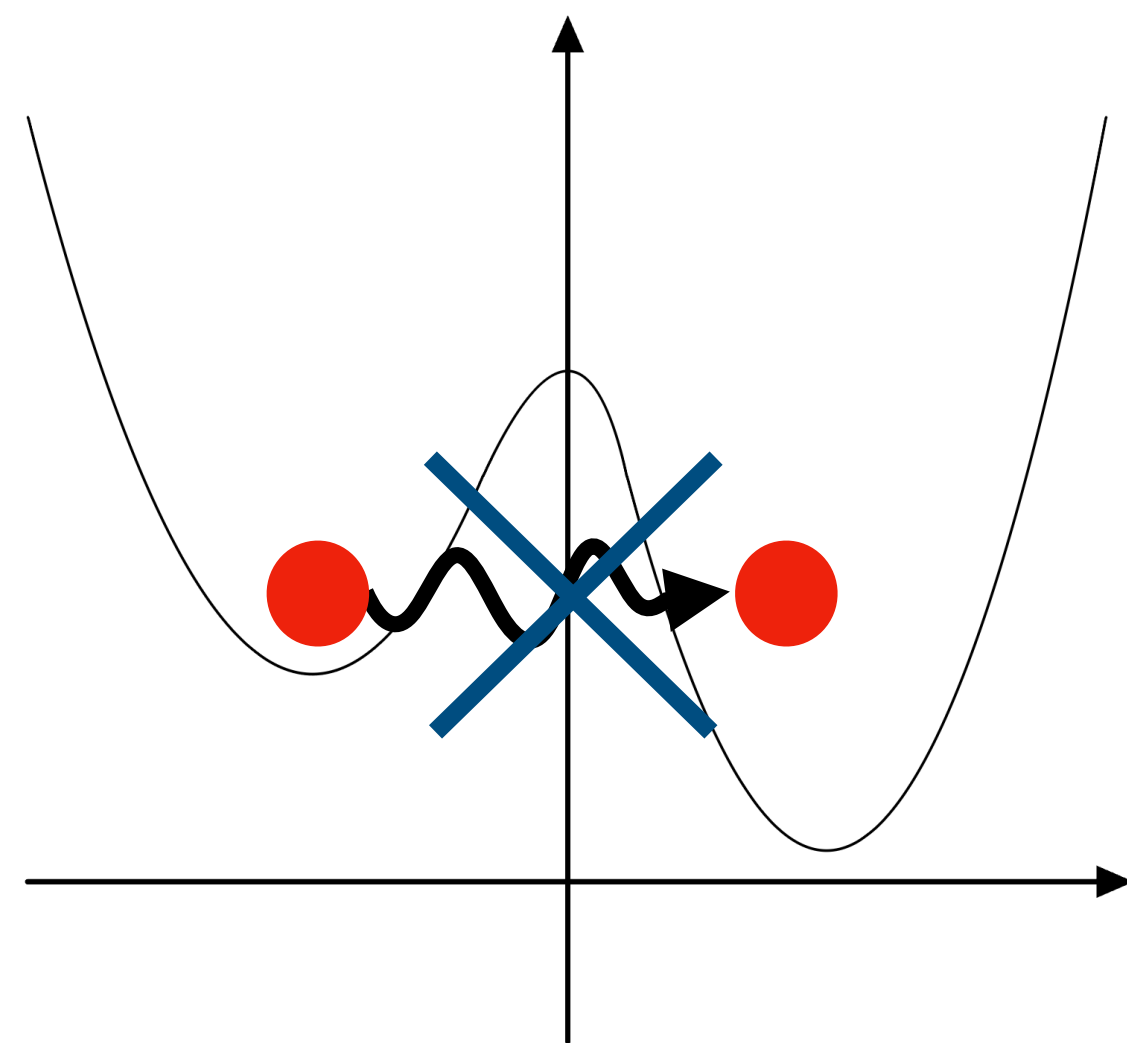

Quench

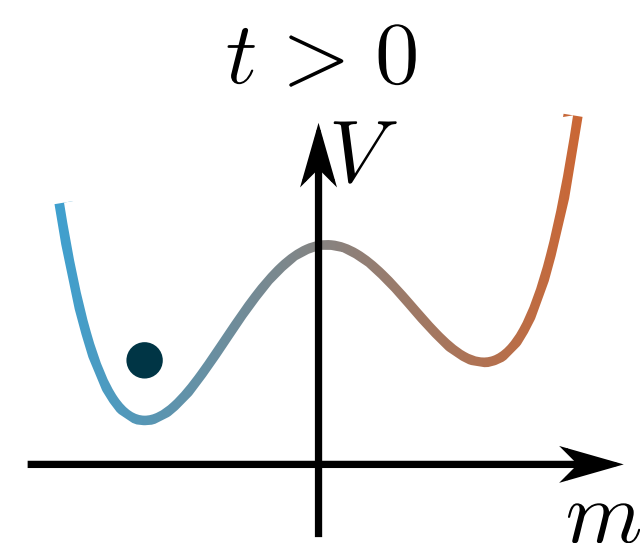

True vacuum

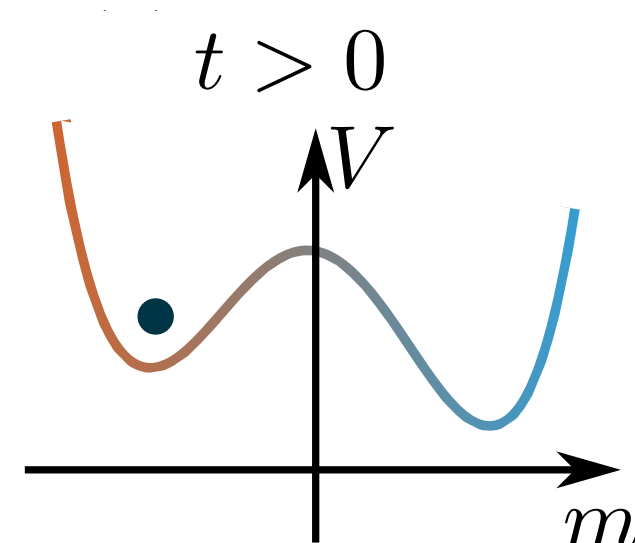

False vacuum

More on the oscillations

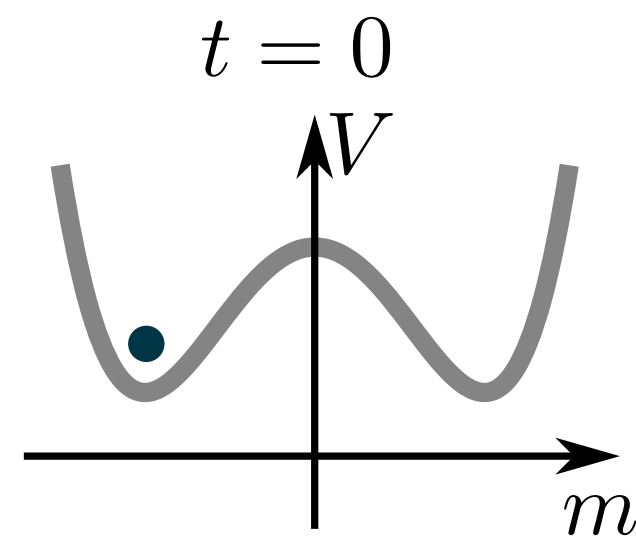
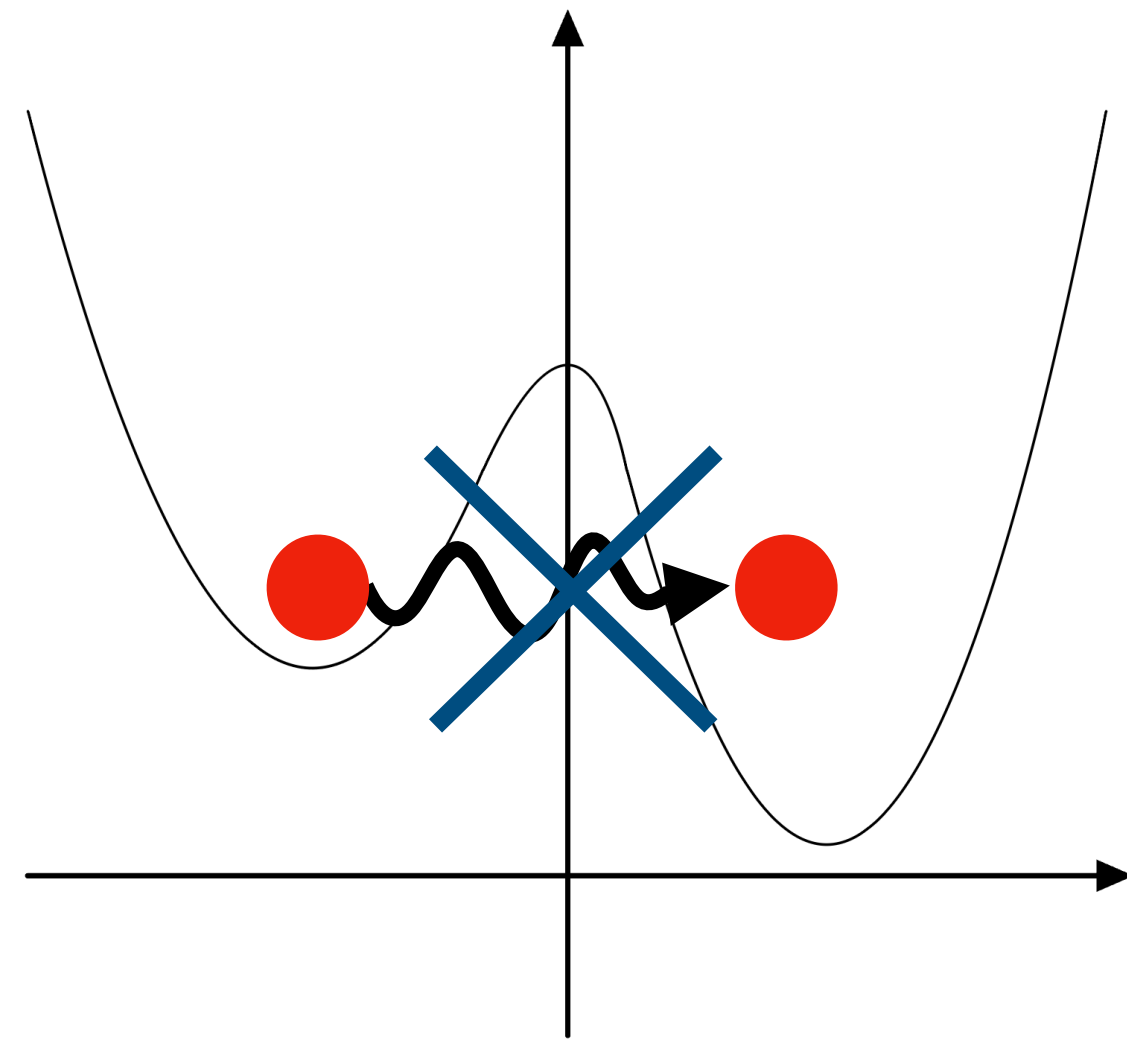

Quench

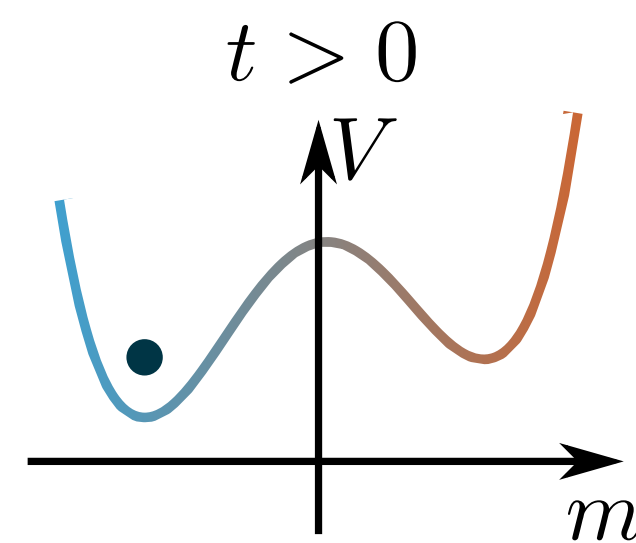

True vacuum

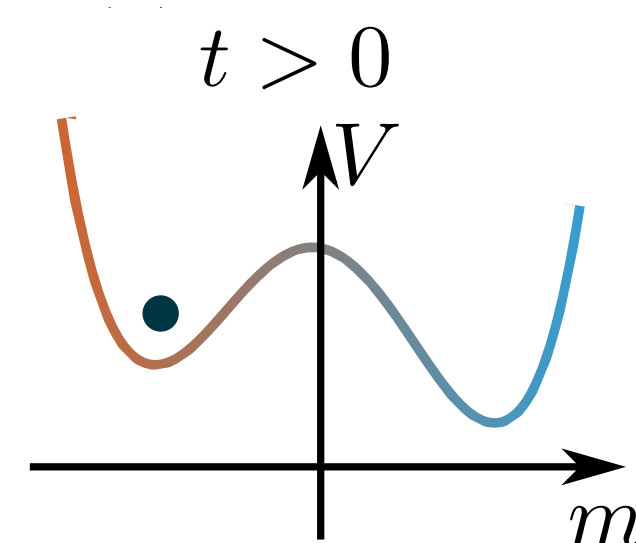

False vacuum



$\langle O \rangle$

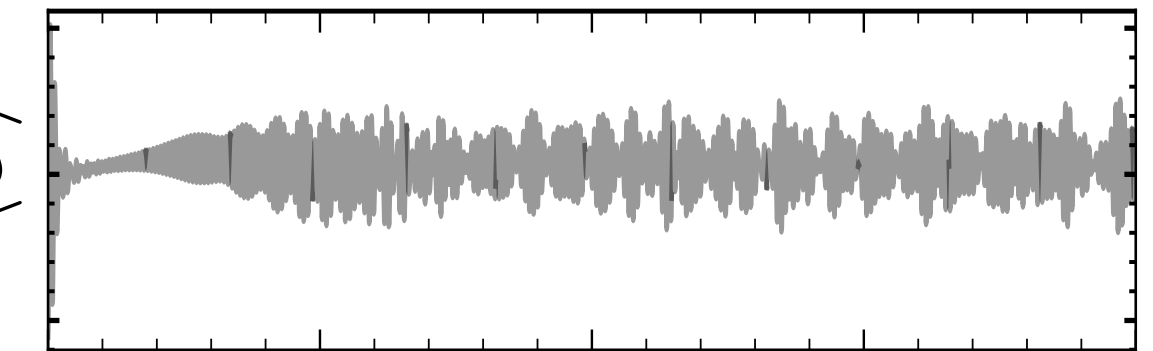

Time evolution:
local observable

time

More on the oscillations

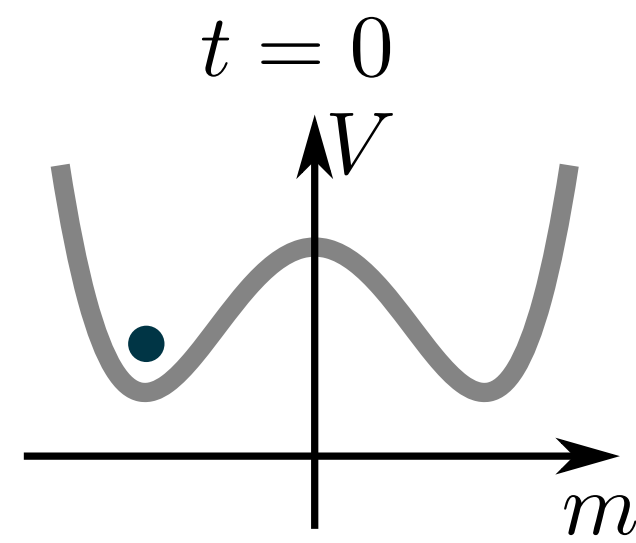
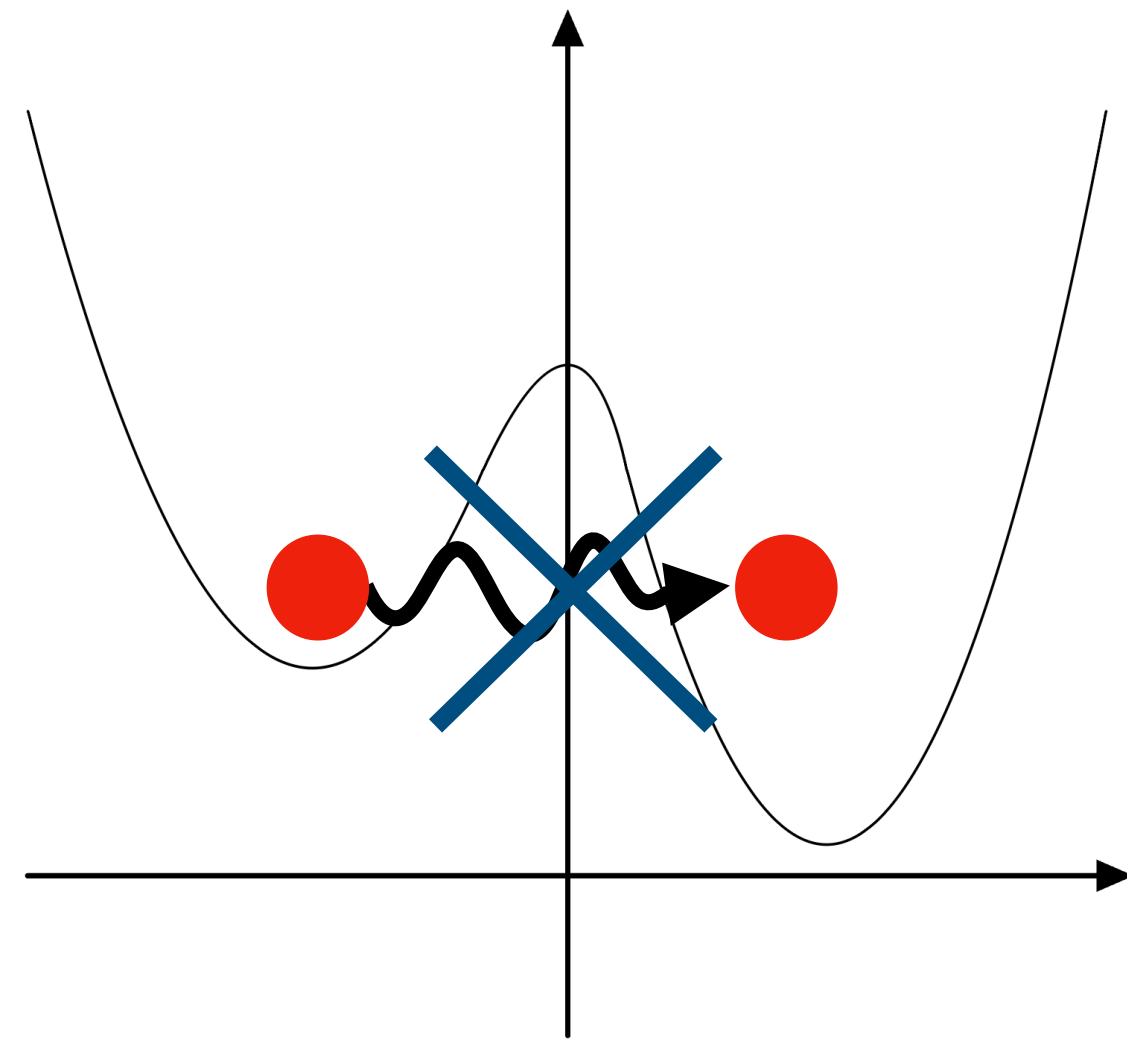

Quench

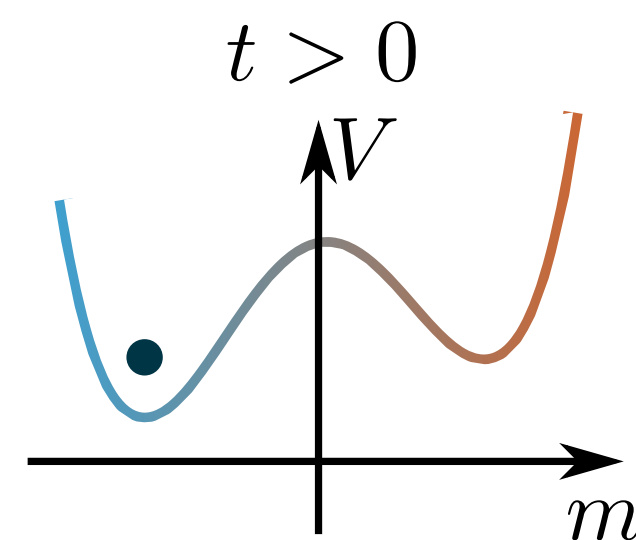

True vacuum

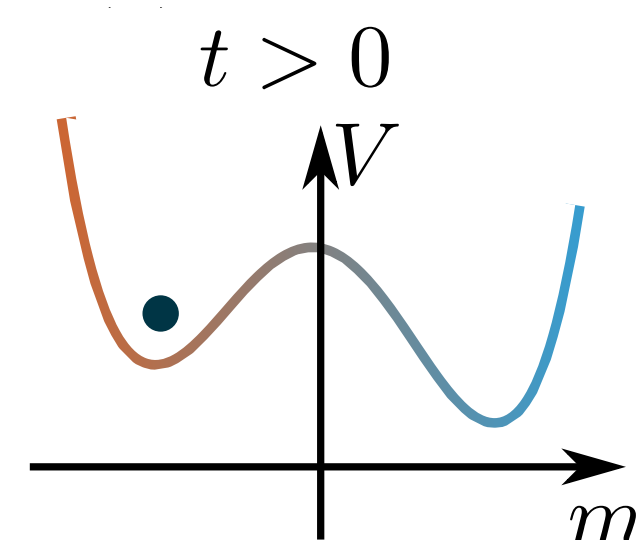

False vacuum

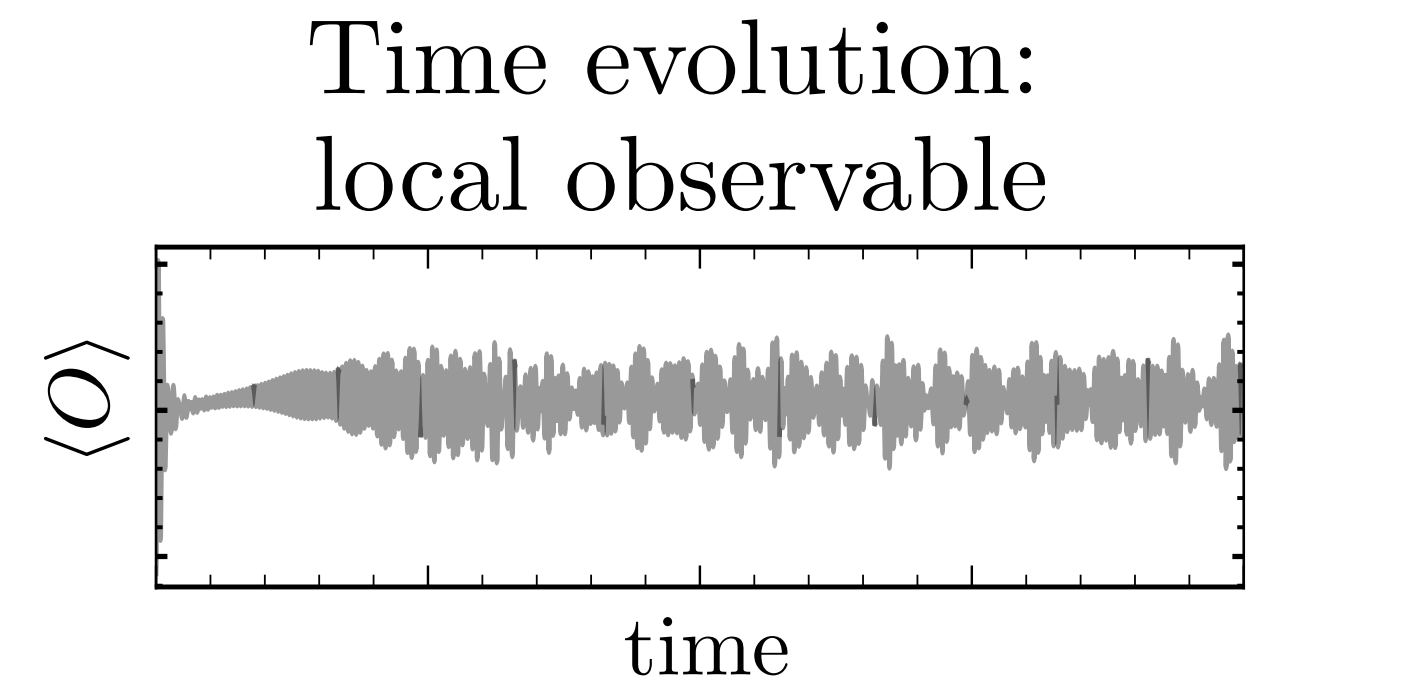

Fourier transform

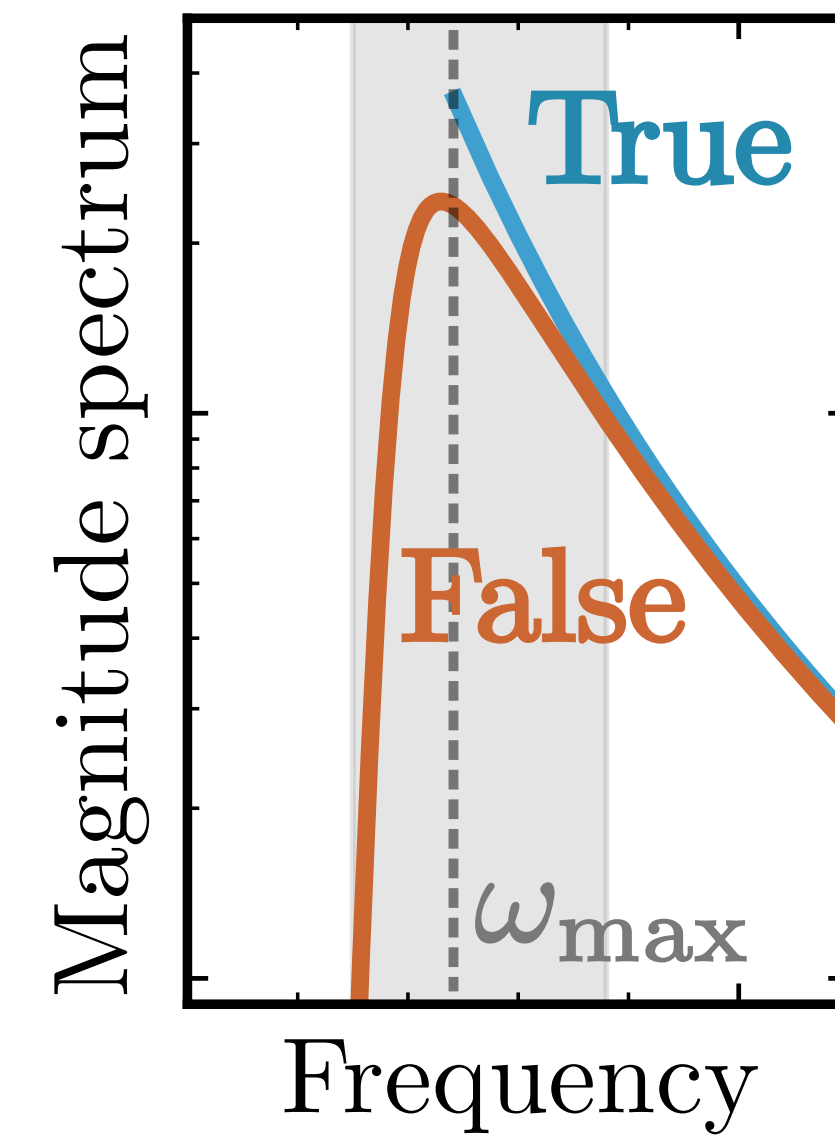

Another Model

XXZ Ladder

$$H = \frac{1}{2} \sum_j \sum_{\alpha=1,2} \left(\sigma_{j,\alpha}^x \sigma_{j+1,\alpha}^x + \sigma_{j,\alpha}^y \sigma_{j+1,\alpha}^y + \Delta_{\parallel} \sigma_{j,\alpha}^z \sigma_{j+1,\alpha}^z \right) + \Delta_{\perp} \sigma_{j,1}^z \sigma_{j+1,2}^z$$

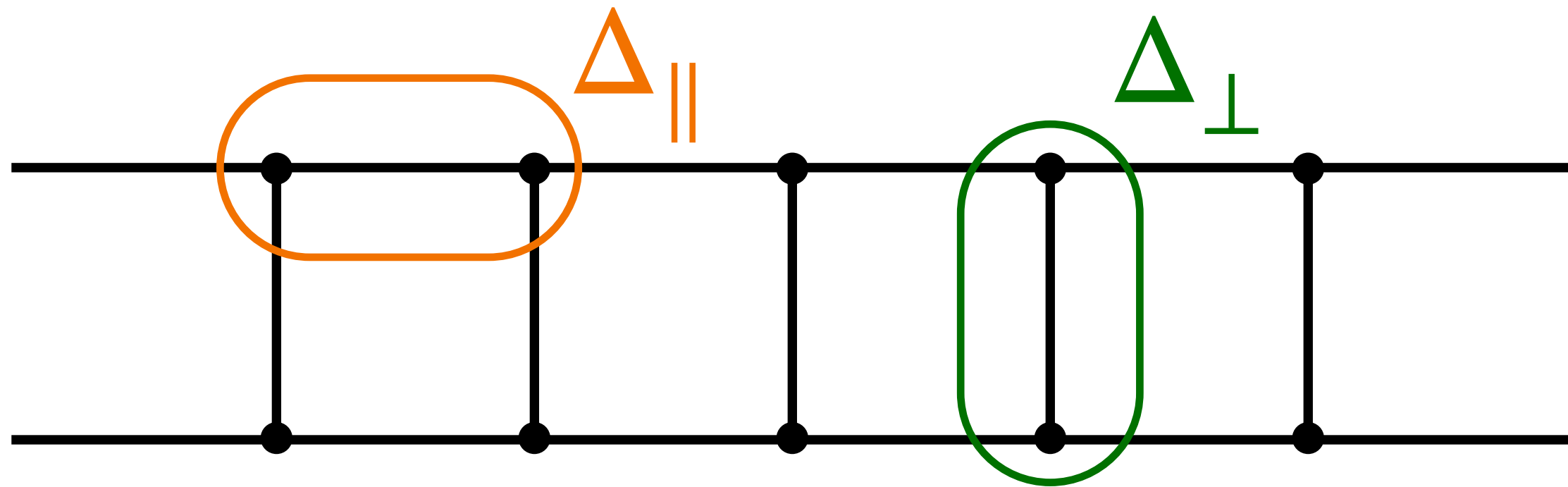

XXZ Ladder

$$H = \frac{1}{2} \sum_j \sum_{\alpha=1,2} \left(\sigma_{j,\alpha}^x \sigma_{j+1,\alpha}^x + \sigma_{j,\alpha}^y \sigma_{j+1,\alpha}^y + \Delta_{\parallel} \sigma_{j,\alpha}^z \sigma_{j+1,\alpha}^z \right) + \Delta_{\perp} \sigma_{j,1}^z \sigma_{j+1,2}^z$$

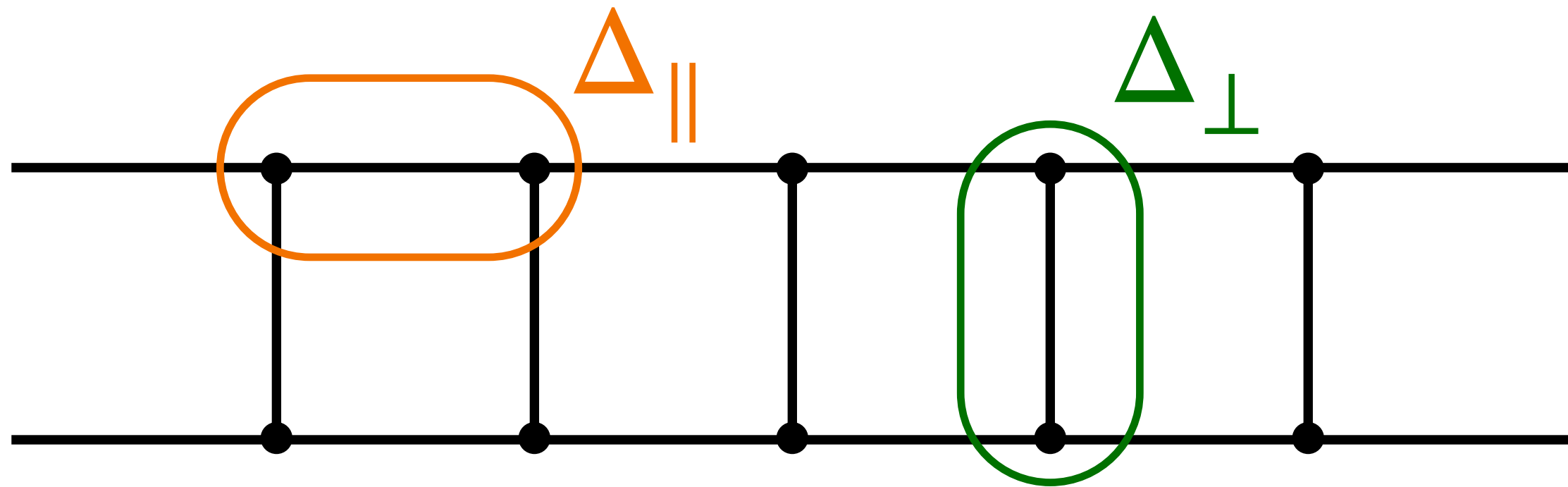

$$\Delta_{\perp} \leftrightarrow h_z$$

Interacting \leftrightarrow No Free Fermion Mapping

XXZ Ladder

$$H = \frac{1}{2} \sum_j \sum_{\alpha=1,2} \left(\sigma_{j,\alpha}^x \sigma_{j+1,\alpha}^x + \sigma_{j,\alpha}^y \sigma_{j+1,\alpha}^y + \Delta_{\parallel} \sigma_{j,\alpha}^z \sigma_{j+1,\alpha}^z \right) + \Delta_{\perp} \sigma_{j,1}^z \sigma_{j+1,2}^z$$

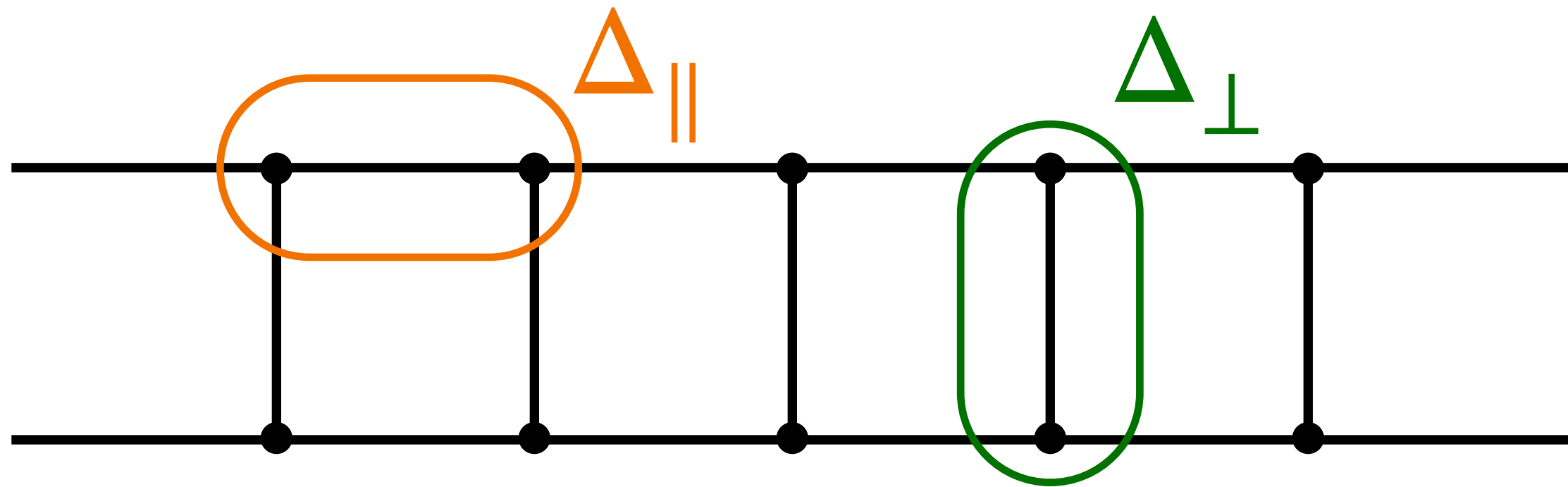

Lagnese, Surace, Kormos, Calabrese J. Phys A 2022

Lagnese, Surace, Kormos, Calabrese J. Stat. Mech. 2022

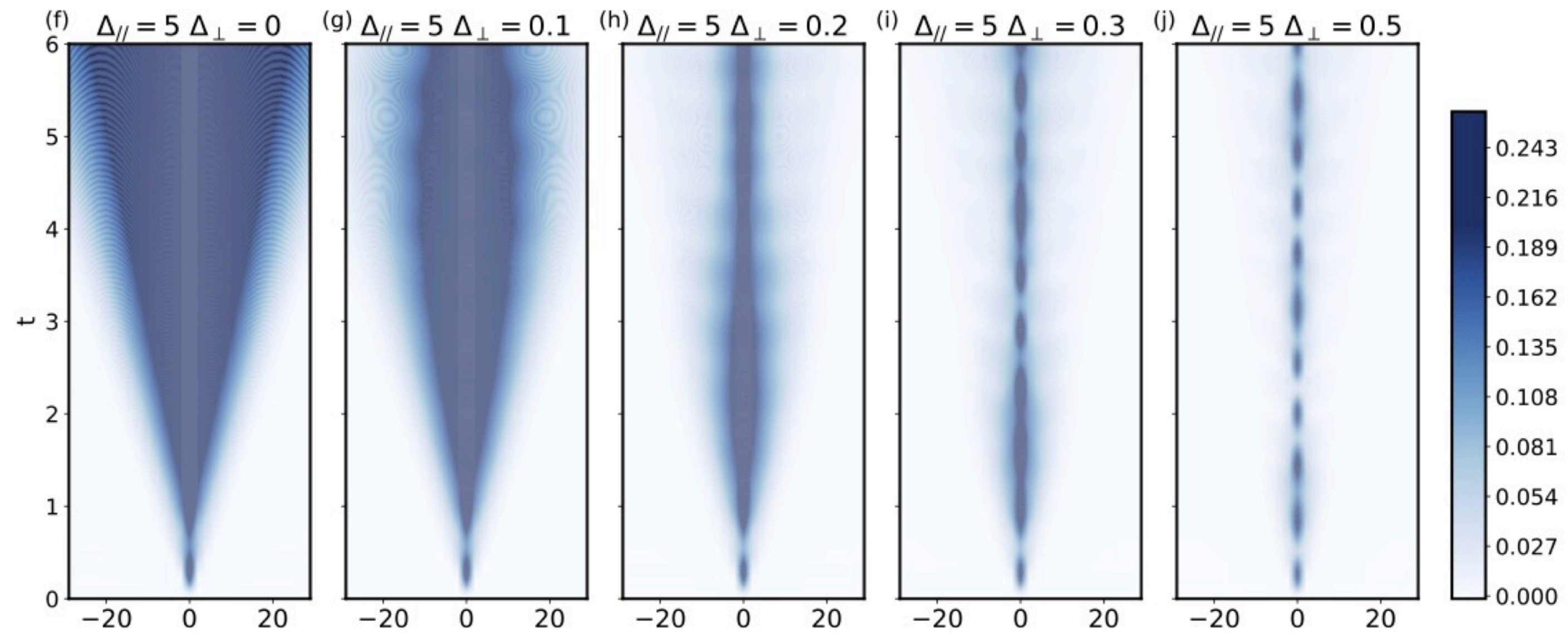

XXZ Ladder

$$H = \frac{1}{2} \sum_j \sum_{\alpha=1,2} \left(\sigma_{j,\alpha}^x \sigma_{j+1,\alpha}^x + \sigma_{j,\alpha}^y \sigma_{j+1,\alpha}^y + \Delta_{\parallel} \sigma_{j,\alpha}^z \sigma_{j+1,\alpha}^z \right) + \Delta_{\perp} \sigma_{j,1}^z \sigma_{j+1,2}^z$$

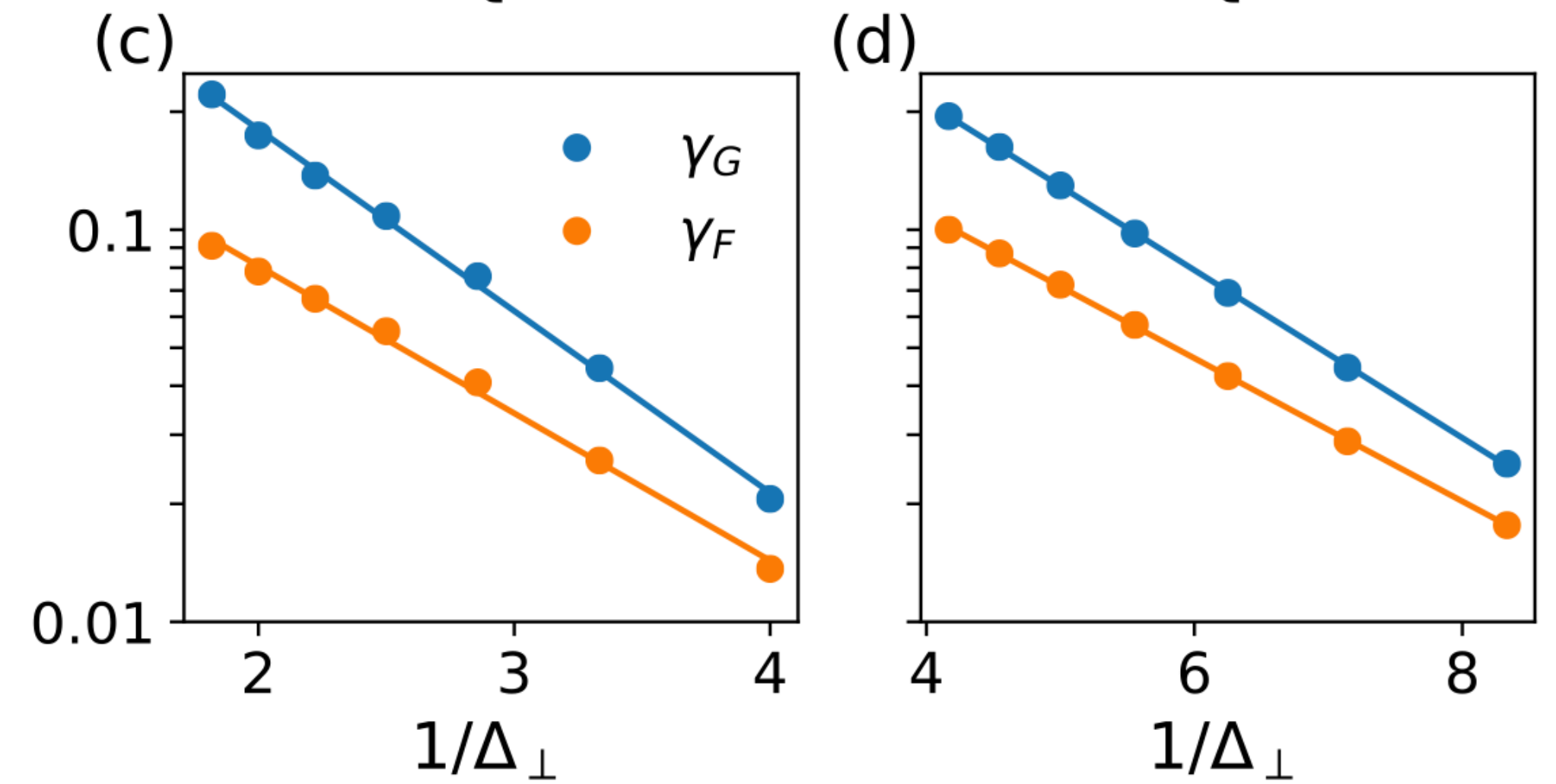
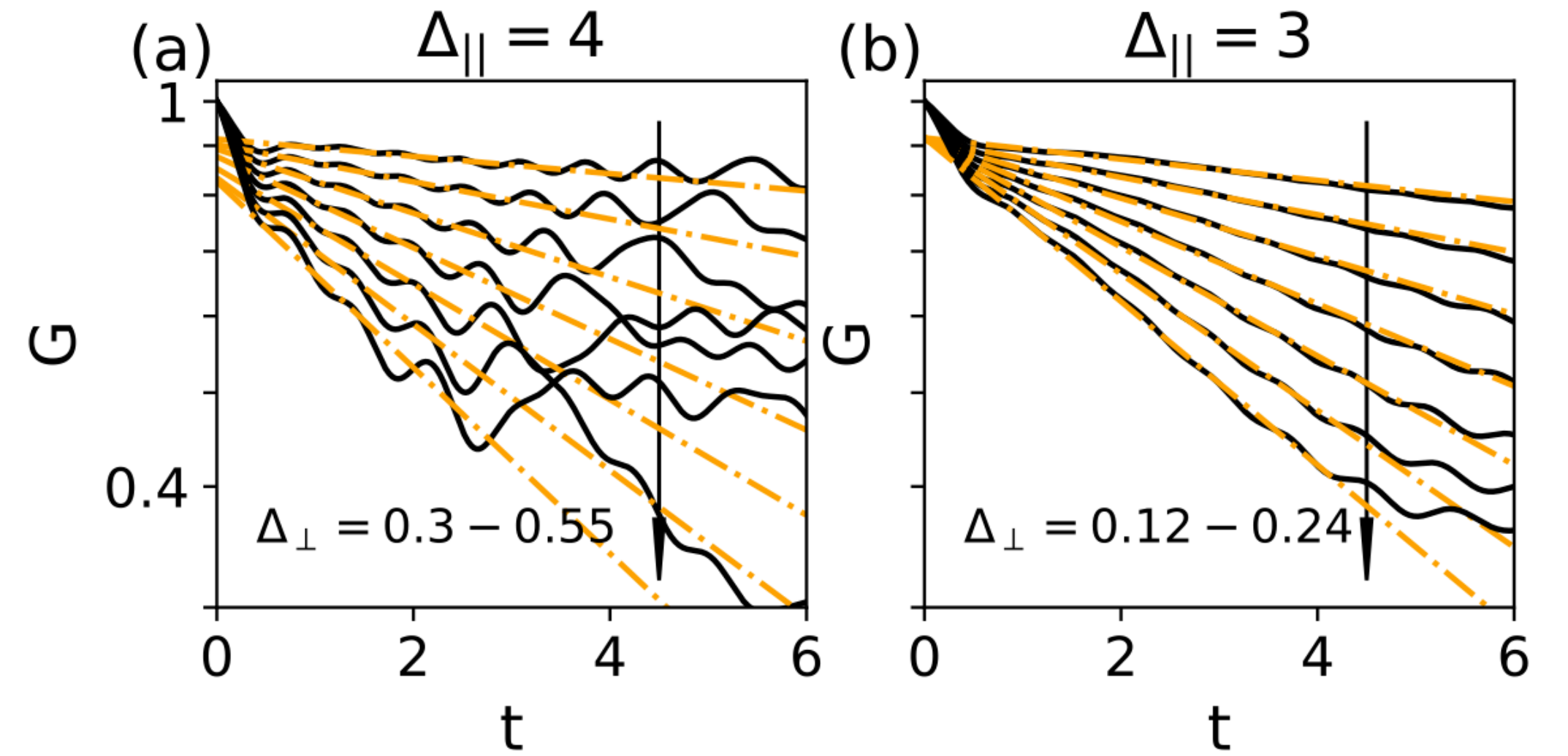
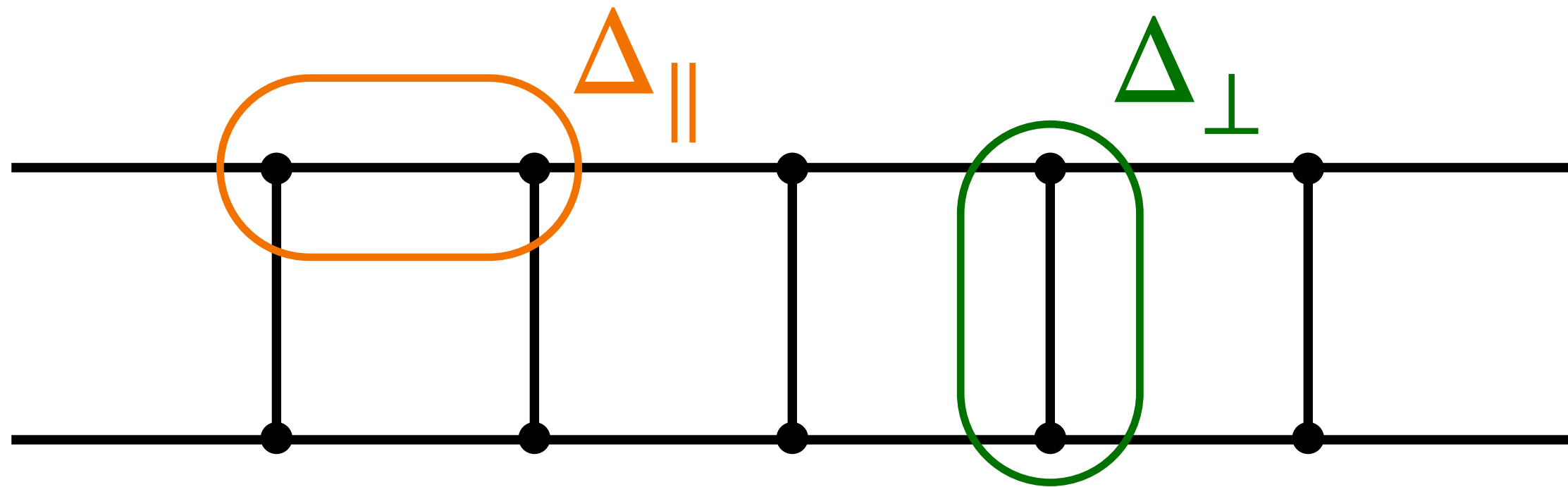

Outlook

More on Bubble Dynamics

(ii) near TCI

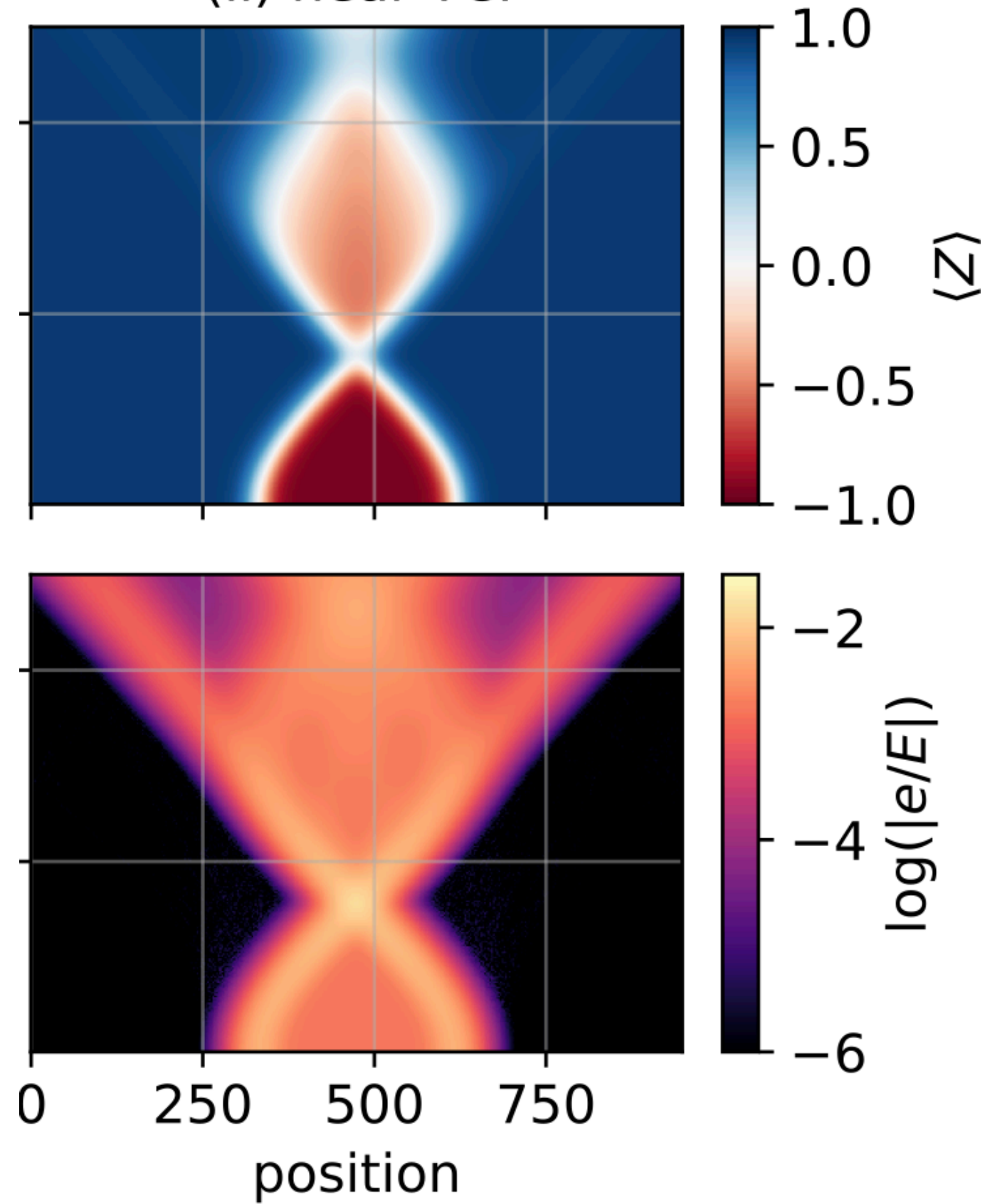

Milsted, Liu, Preskill, Vidal
PRX Quantum 2022

Prefactor in the decay rate

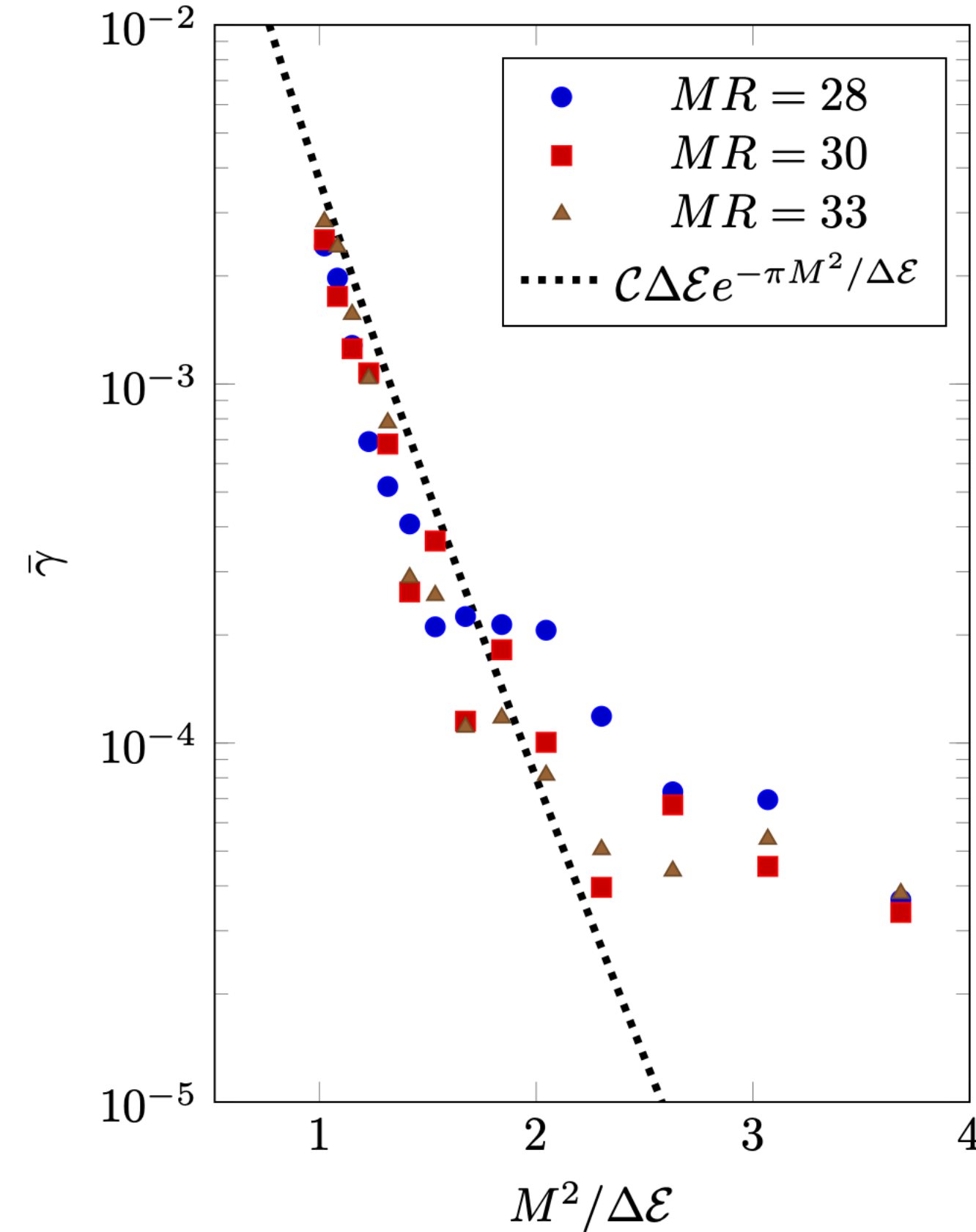

Lencses, Mussardo, Tacaks PRD 2022

Experiments

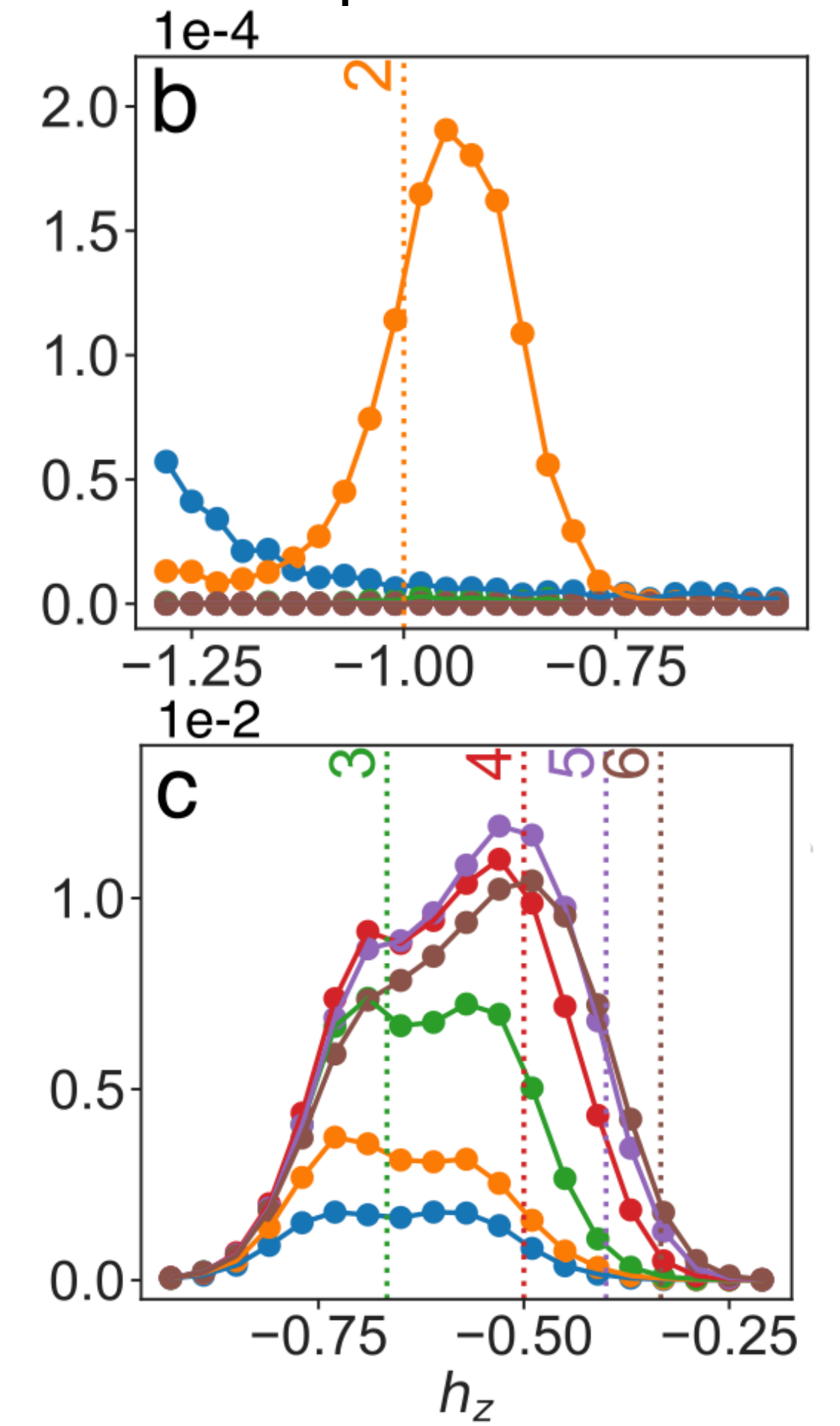

Jaka Vodeb et al. arXiv:2406.14718

Thanks for the attention !

Federica M. Surace



Pasquale Calabrese

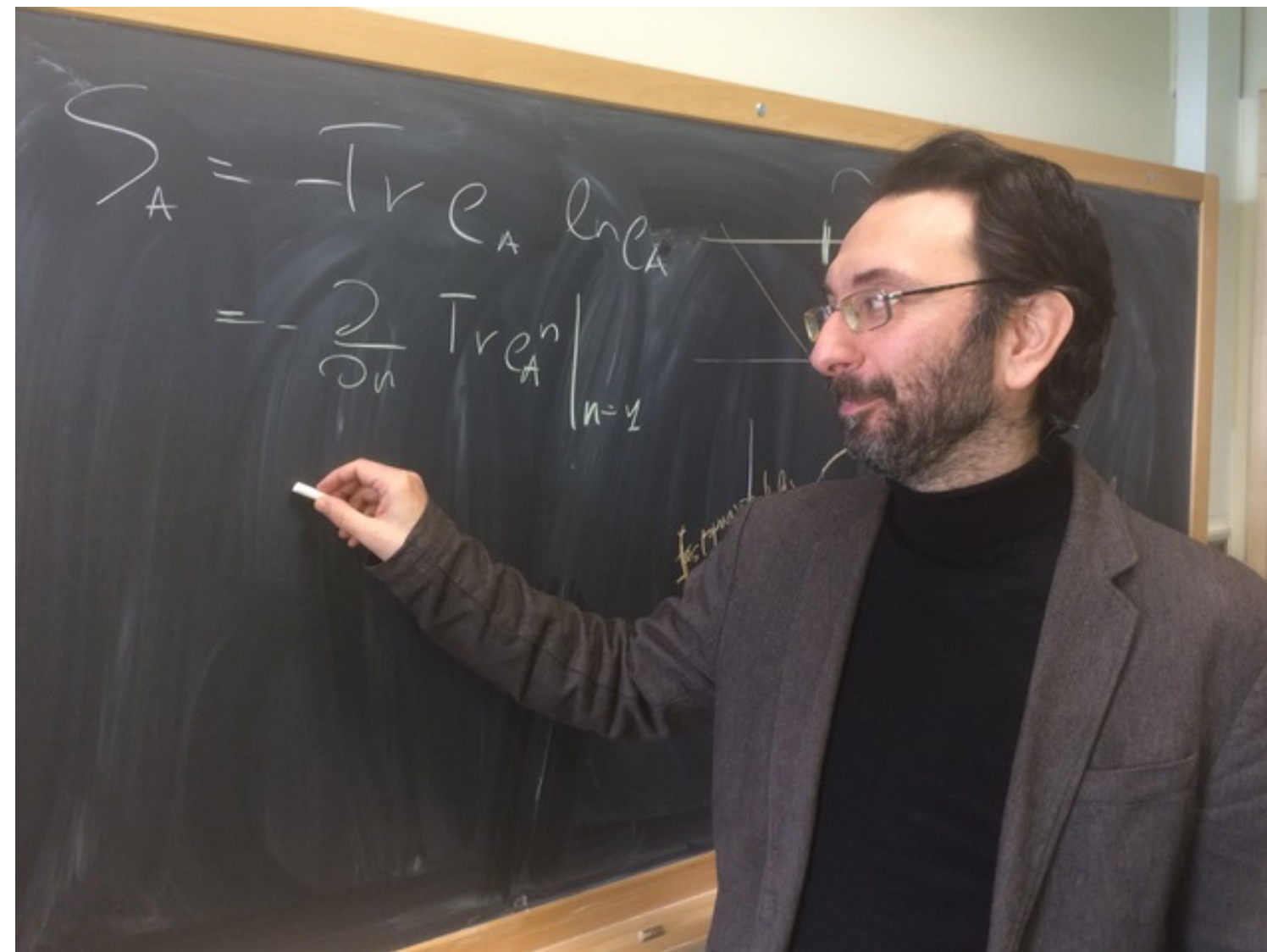

Marton Kormos

