

Optimization of cryogenic mixed-refrigerant cascades for intermediate cooling stations of the long-distance superconducting power cable SuperLink

F. Boehm, W. Batista de Sousa, S. Grohmann, International Cryogenic Engineering Conference, July 25, 2024

SuperLink – 15 km sc. HV cable in Munich

- Progressing electrification due to energy transition
- Upgrading power grid is imperative (age, performance)

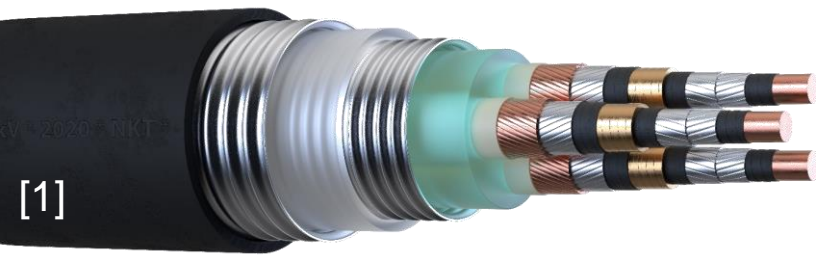

- Lower space demand
- No electromagnetic emissions
- No joule heating
- Higher transmission performance



[2] NKT

[1]

[1] www.nkt.de



SuperLink – Closed cycle cooling stations

- Cooling temperature below 77 K
- 15-30 kW per cooling station
- Low-maintenance → reliability
- Low space requirement
- Low energy demand

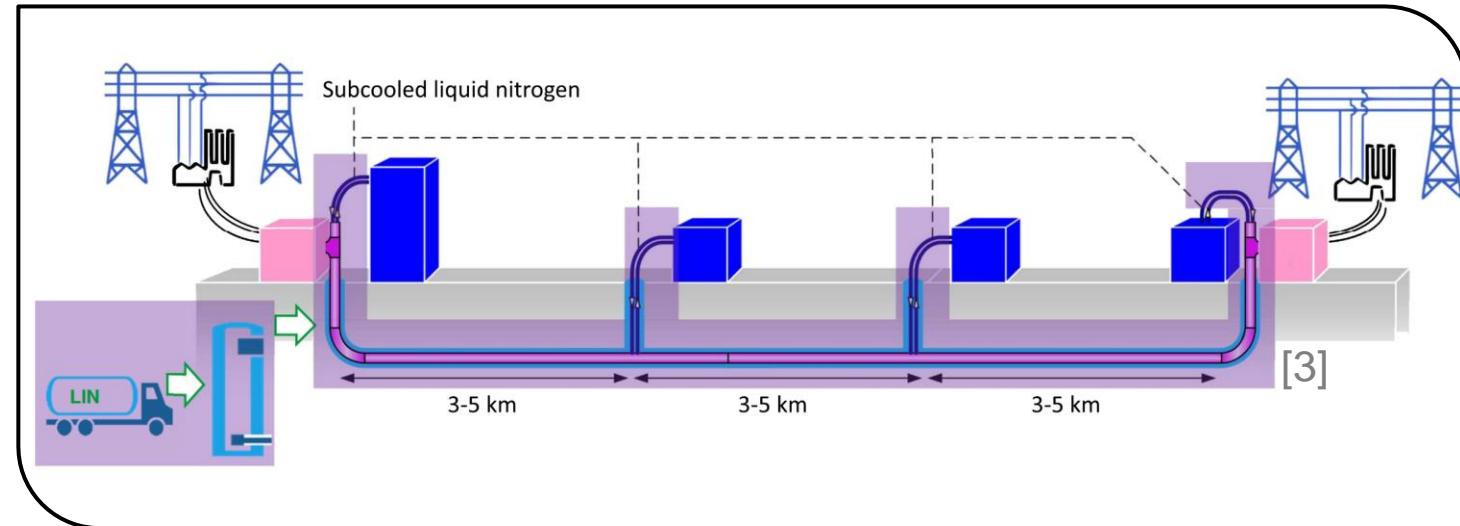

[3] Alekseev et al. 2020

- Cooling systems are the main contributor to energy demand
 - 1st and 2nd law of thermodynamics → $P = \sum T_U \cdot \dot{S}_{i,irr}$
 - $\Delta p: \dot{S}_{i,irr} \propto -\frac{v}{T} dp$
 - $\Delta T: \dot{S}_{i,irr} \propto \frac{T_1 - T_2}{T_1 \cdot T_2}$

Influence of ΔT and Δp increases
at cryogenic temperatures

Why mixed refrigerants? – The Linde Hampson Cycle

- Easiest cryogenic cooling cycle
 - Capacity flows do not match for pure refrigerants
 - ΔT increases entropy production

$$\Delta S_{\text{irr}} = \int \frac{T_h - T_c}{T_h T_c} dq$$

- Improvement by matching capacity flows
 - constant ΔT along inner CFHX
 - ... by adjusting massflows in CFHX
 - e.g. Claude process
 - ... by using wide boiling refrigerant mixtures
 - Cryogenic mixed-refrigerant cycle (CMRC)

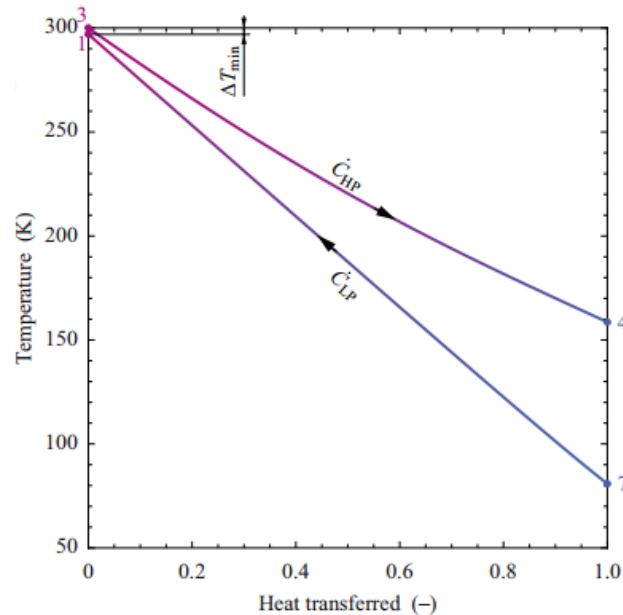
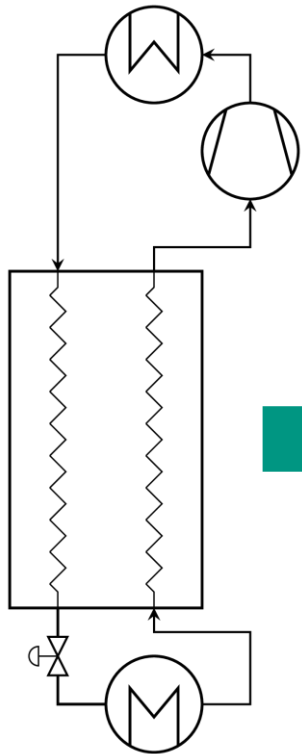

Why mixed refrigerants? – Refrigerant Design

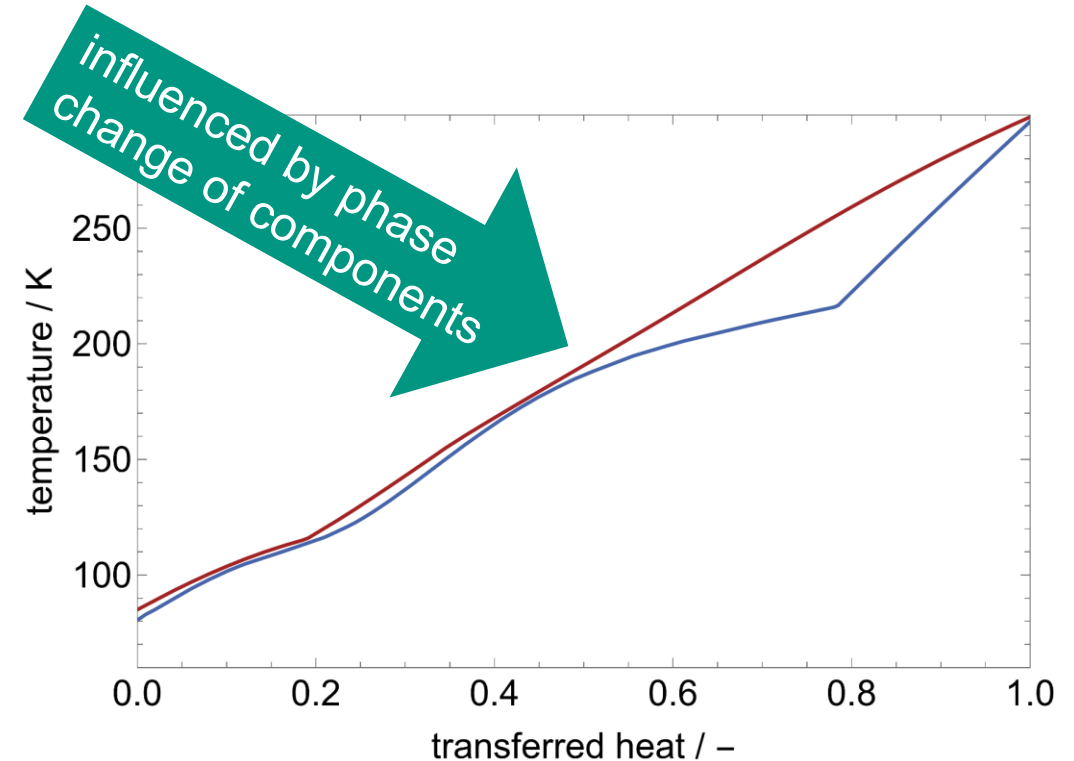
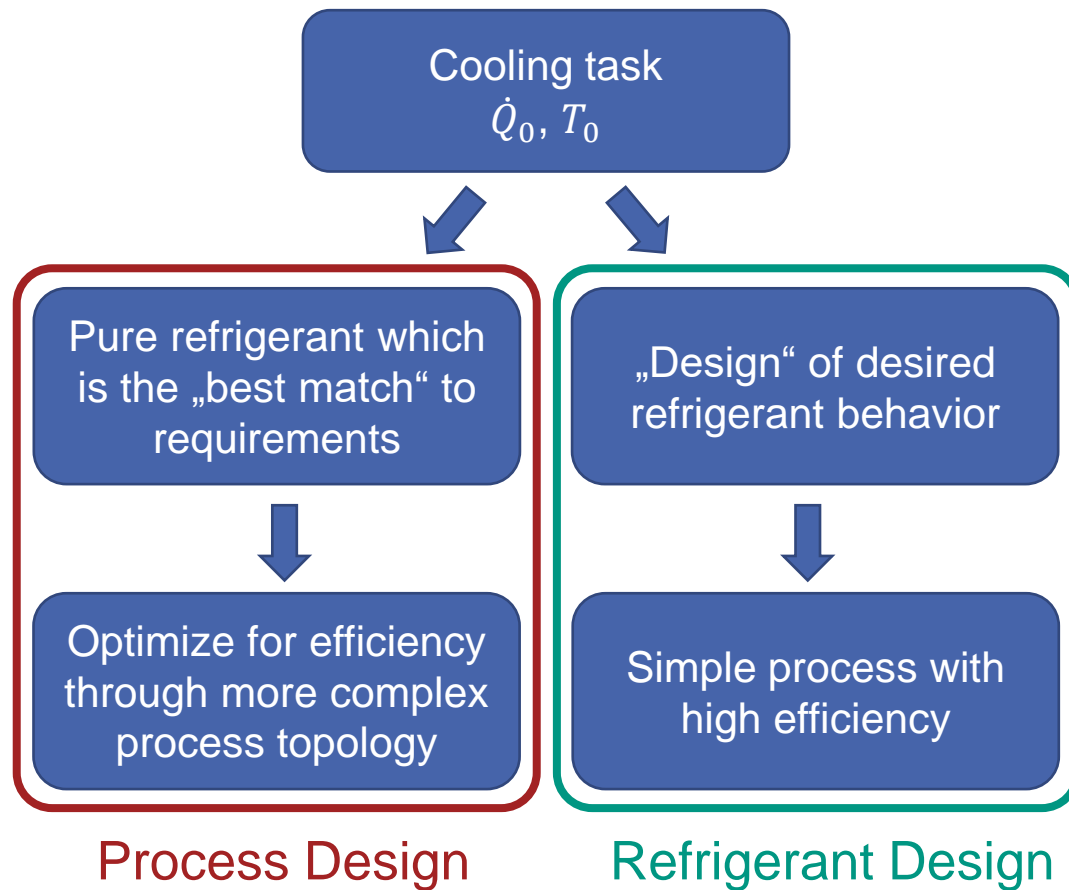

Key component of every cooling system is the refrigerant!

CMRC cascade

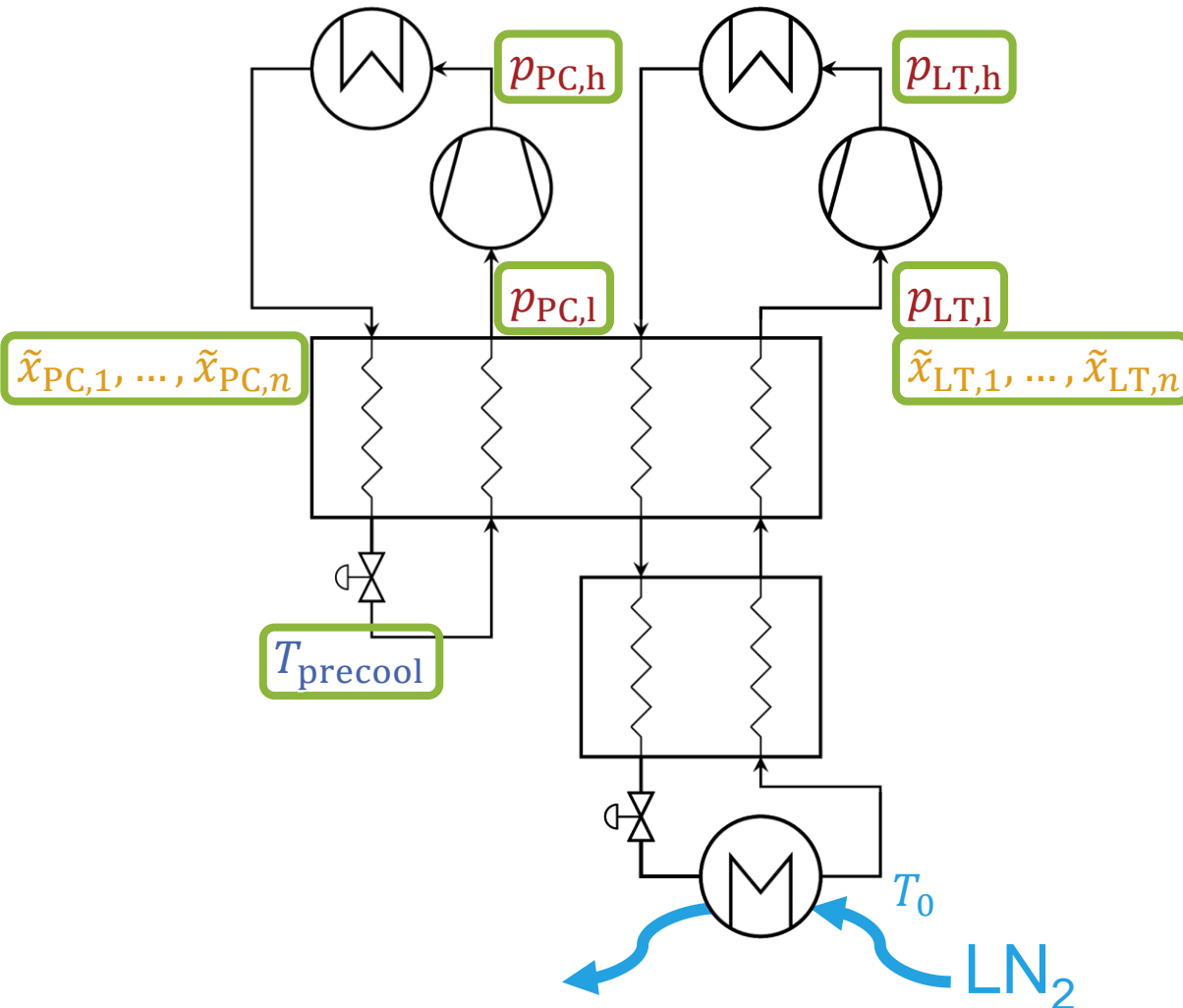

- Single-stage CMRC inefficient for very low temperatures (70 K)
 - Amount of high boiling components must be drastically reduced to avoid freeze-out

→ CMRC cascade

- precooling (PC) stage
 - cooling down to T_{precool}
- low temperature (LT) stage
 - cooling at T_0

Process simulation

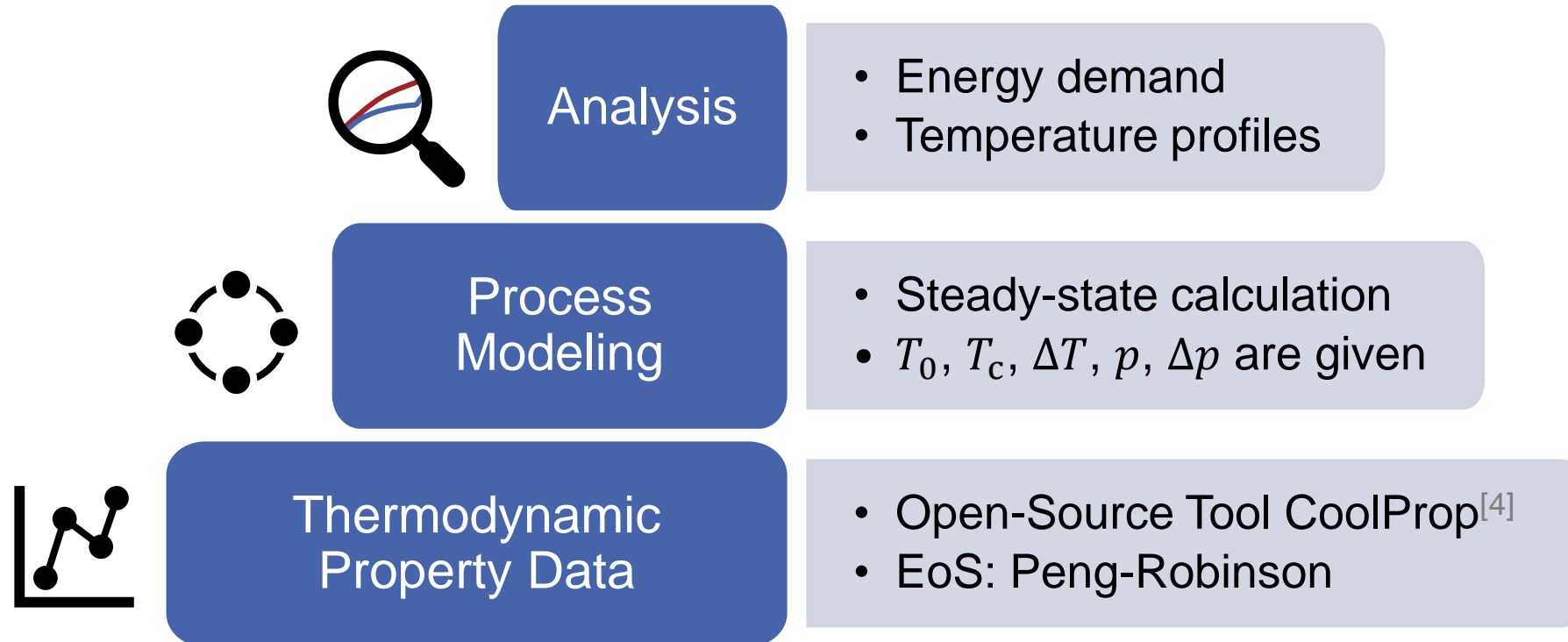

[4] I.H. Bell et al. 2014

Optimization by genetic algorithm^[5]

- Differential Evolution (DE) ^[6,7]
 - No derivatives needed
 - Global optimization → „Exploration & Exploitation“

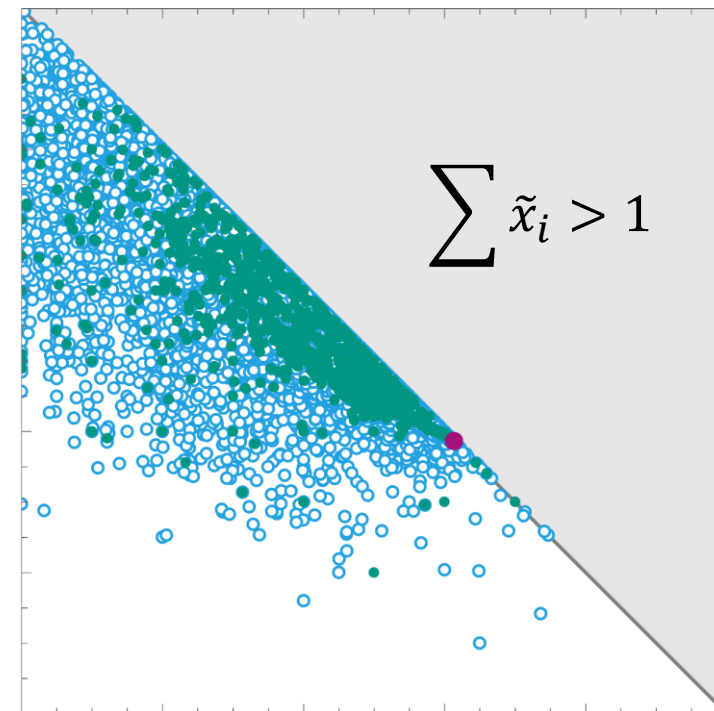
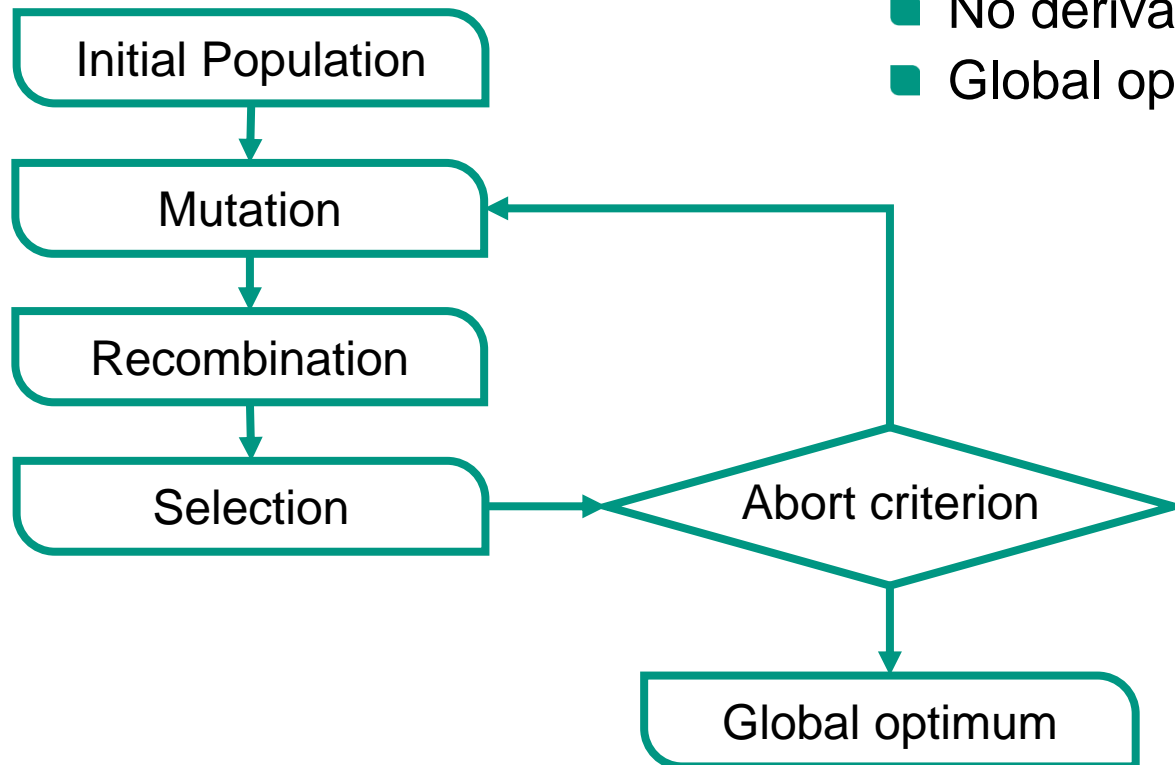

- candidates
- former populations
- current population

[6] R. Storn und K. Price 1997

[7] K. Price et al. 2005

Optimization by genetic algorithm^[5]

- DE is predestined to parallelization
 - Different candidates in the same generation can be calculated independently

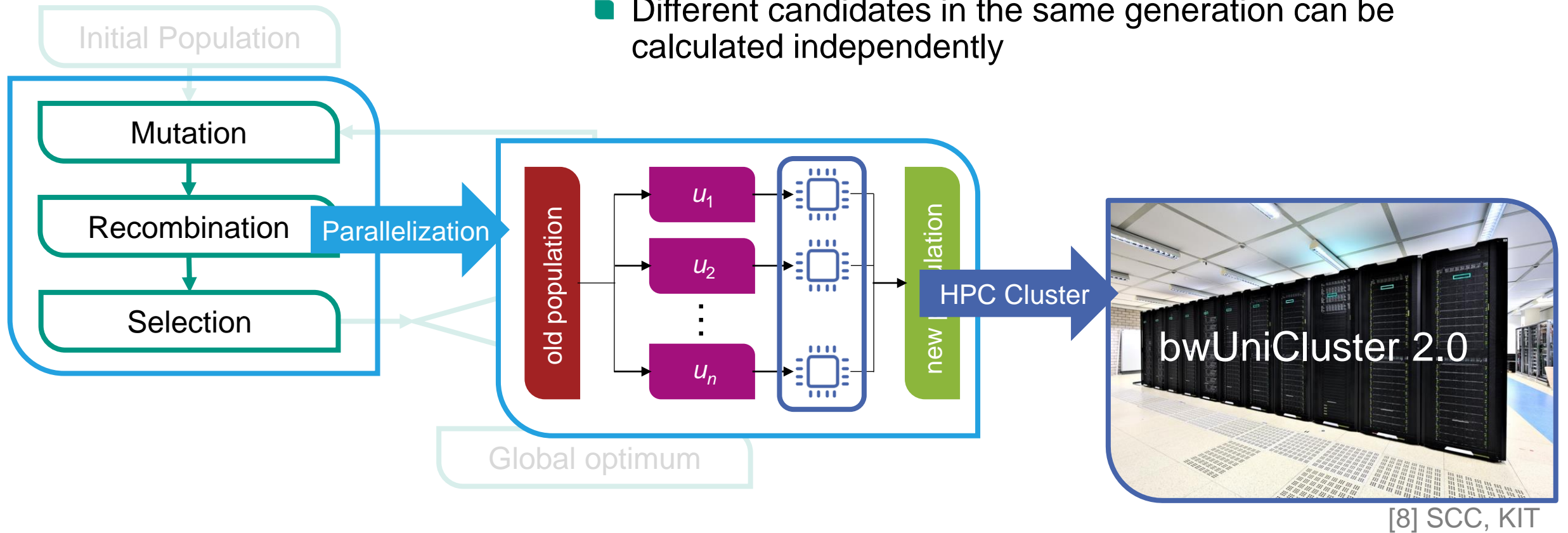

Total Carnot efficiency for different T_{precool}

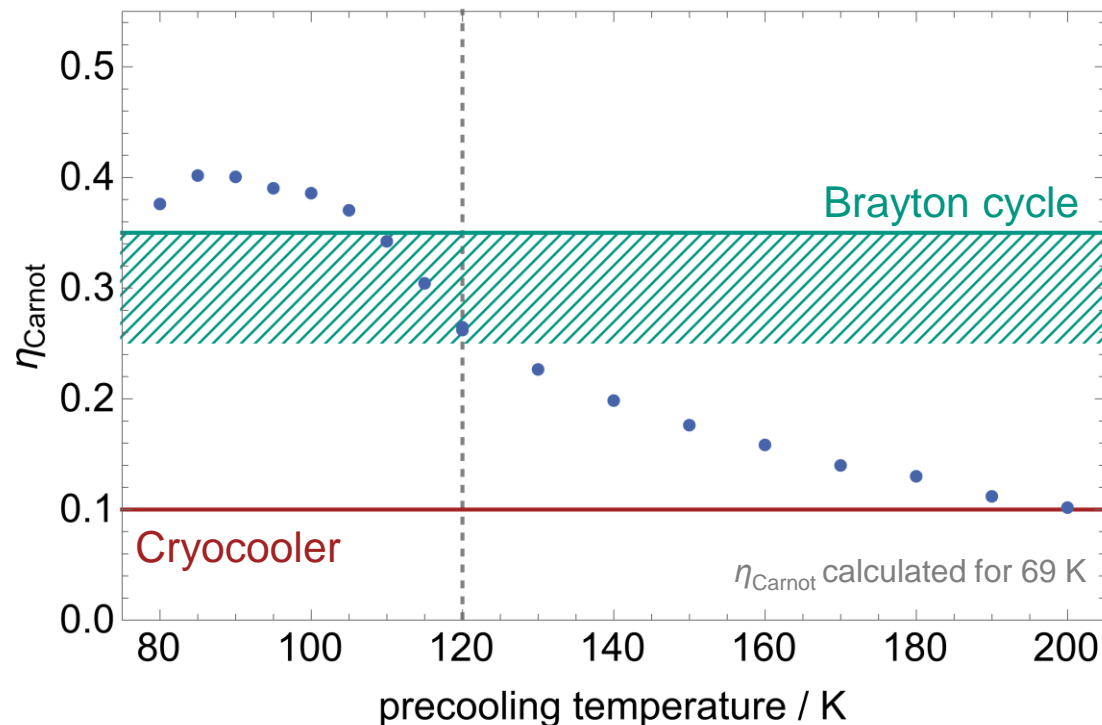

T_0	64 K – 74 K
T_a	293.15 K
ΔT_a	5 K
ΔT_{min}	2 K
η_{is}	0.7

T_{precool}	80 ... 200 K
p_{ND}	1 ... 20 bar
p_{HD}	10 ... 60 bar
\tilde{x}_i	0 ... 1

- liquid refrigerant supply (LRS) to HX2 for $T \leq 120$ K
 → significantly improves efficiency of low temperature stage

HX temperature profiles and T-h plot for LT stage

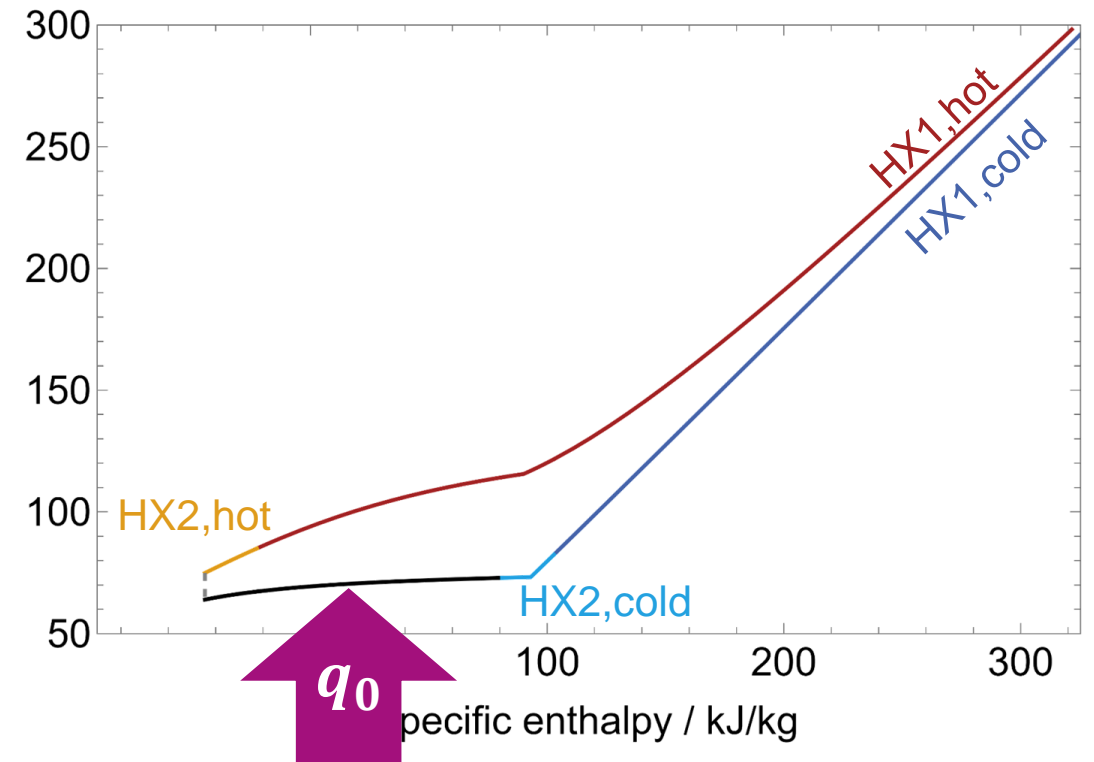
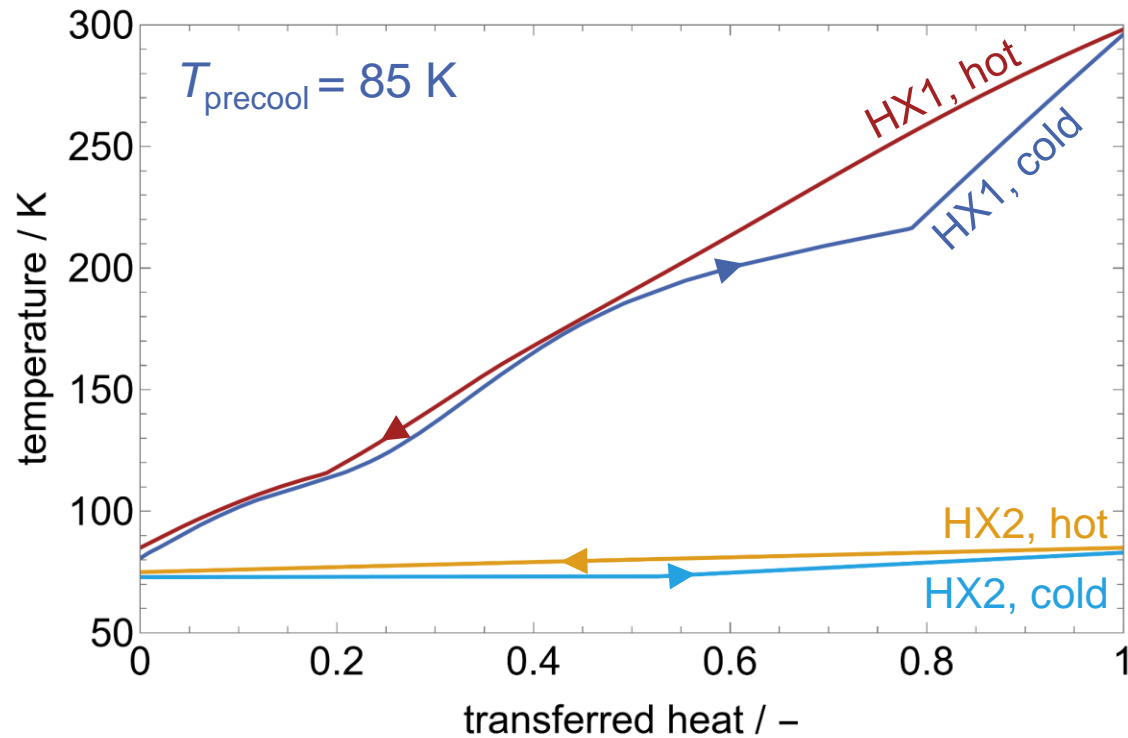

Conclusions and outlook

Simulation results

- Successful implementation of genetic CMRC cascade optimization algorithm
- Precooling temperatures below 120 K improve efficiency
- Very good match of capacity flow rates within heat exchangers

Technology outlook

- Compared to Turbo-Brayton cycles, **CMRC cascades** have
 - higher Carnot efficiency ($> 40\%$)
 - higher power density (2-phase)
 - no cold expanders
 - scalable technology
- **Next steps**
 - Prototype development?
 - Test facility COMPASS^[9] available

Thank you for your attention!

Bibliography

- [1] <https://www.nkt.de/presse-events/nkt-entwickelt-den-prototyp-fuer-das-weltweit-laengste-supraleitende-stromkabel>, last checked: 17 July 2024,
- [2] NKT, private communication
- [3] A. Alekseev, S. Grohmann and L. Decker, „Anforderungen an das Kühlsystem für lange HTSL-Leistungskabel“, german, 2020. DKV Tagung 2020 online, A I.11, 19-20 November 2020
- [4] I.H. Bell, J. Wronski, S. Quoilin and V. Lemort, “Pure and Pseudo-pure Fluid Thermophysical Property Evaluation and the Open-Source Thermophysical Property Library CoolProp”, *Industrial & Engineering Chemistry Research* 53, S. 2498–2508, ISSN 0888-5885. 2014.
- [5] F. Boehm and S. Grohmann, "Modelling and optimization of cryogenic mixed-refrigerant cycles for the cooling of superconducting power cables." *IOP Conference Series: Materials Science and Engineering*. Vol. 1301. No. 1. IOP Publishing, 2024. doi: 10.1088/1757-899X/1301/1/012132
- [6] R. Storn and K. Price, „Differential Evolution - A Simple and Efficient Heuristic for global Optimization over Continuous Spaces“, *Journal of Global Optimization*, 11, S. 341-359, 1997. doi: 10.1023/A:1008202821328
- [7] K. Price, R. Storn and J. Lampinen, „Differential Evolution - A Practical Approach to Global Optimization“, Springer Berlin, Heidelberg. ISBN: 978-3-540-20950-8. 2005.
- [8] https://www.scc.kit.edu/dienste/bwUniCluster_2.0.php, last checked: 17 July 2024
- [9] J. Arnsberg, M. Stamm, and S. Grohmann. “Design of a High-Current Cryogenic Test Stand for Compact Accelerator Systems”. In: 26th IIR International Congress of Refrigeration - Refrigeration Science and Technology Proceedings. 26th IIR International Congress of Refrigeration. Vol. 1. Paris, France, Aug. 21, 2023, pp. 231–239. DOI: 10.18462/iir.icr.2023.0290.