



Update on CLIC detector forward region studies

(in collaboration with FCAL + MDI teams)

presented by Konrad Elsener (CERN),
for the CLIC detector study team

- 1) CLIC detectors for CDR: CLIC_SiD and CLIC_ILD
- 2) CLIC detector layout and opening scenario
- 3) QD0 and anti-solenoid
- 4)
 - a) Radiation to QD0
 - b) full beam loss on QD0
- 5) Pre-Isolator: update
- 6) Vacuum layout: update
- 7) Summary and outlook

1) CLIC detectors for CDR

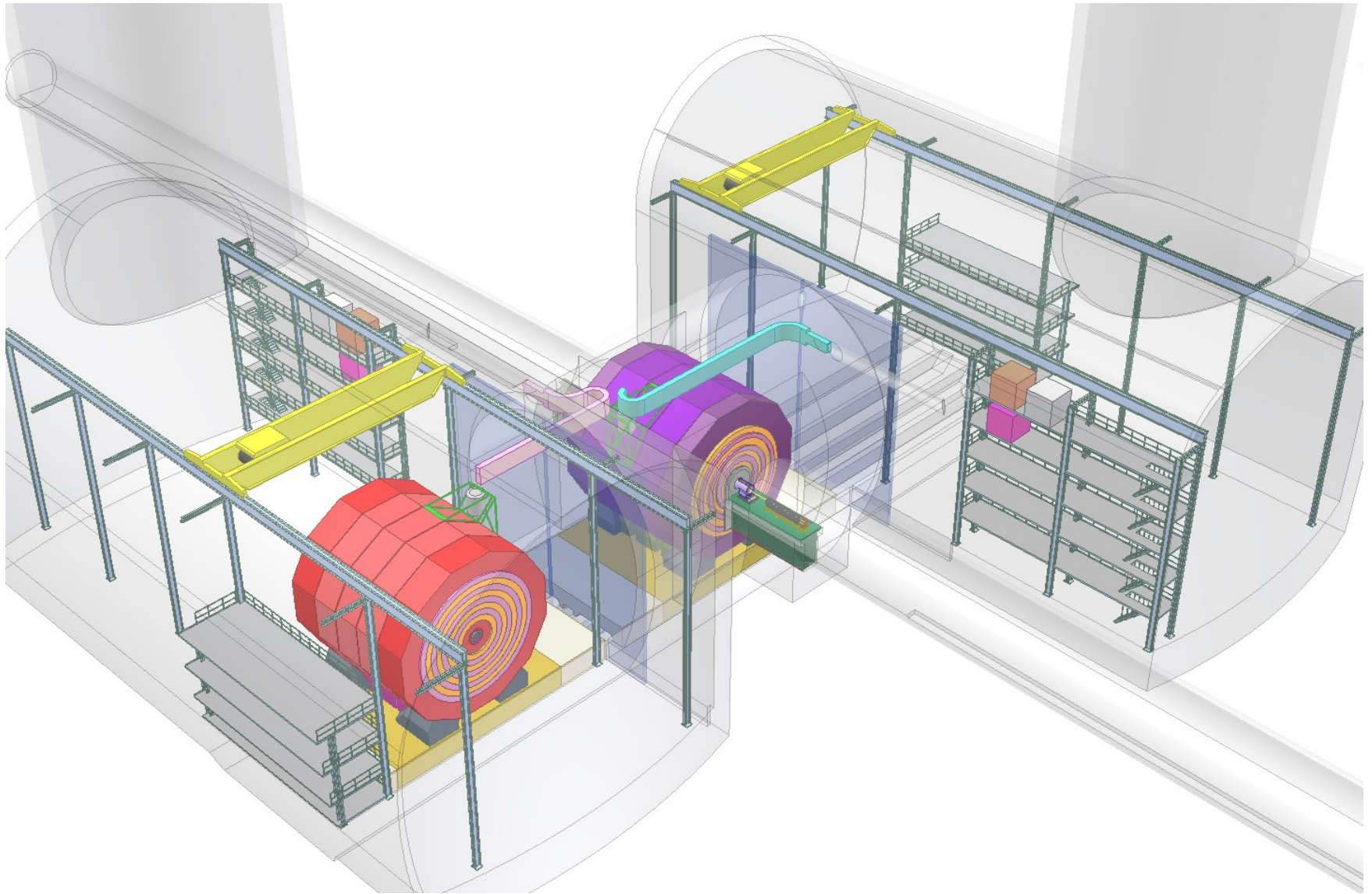

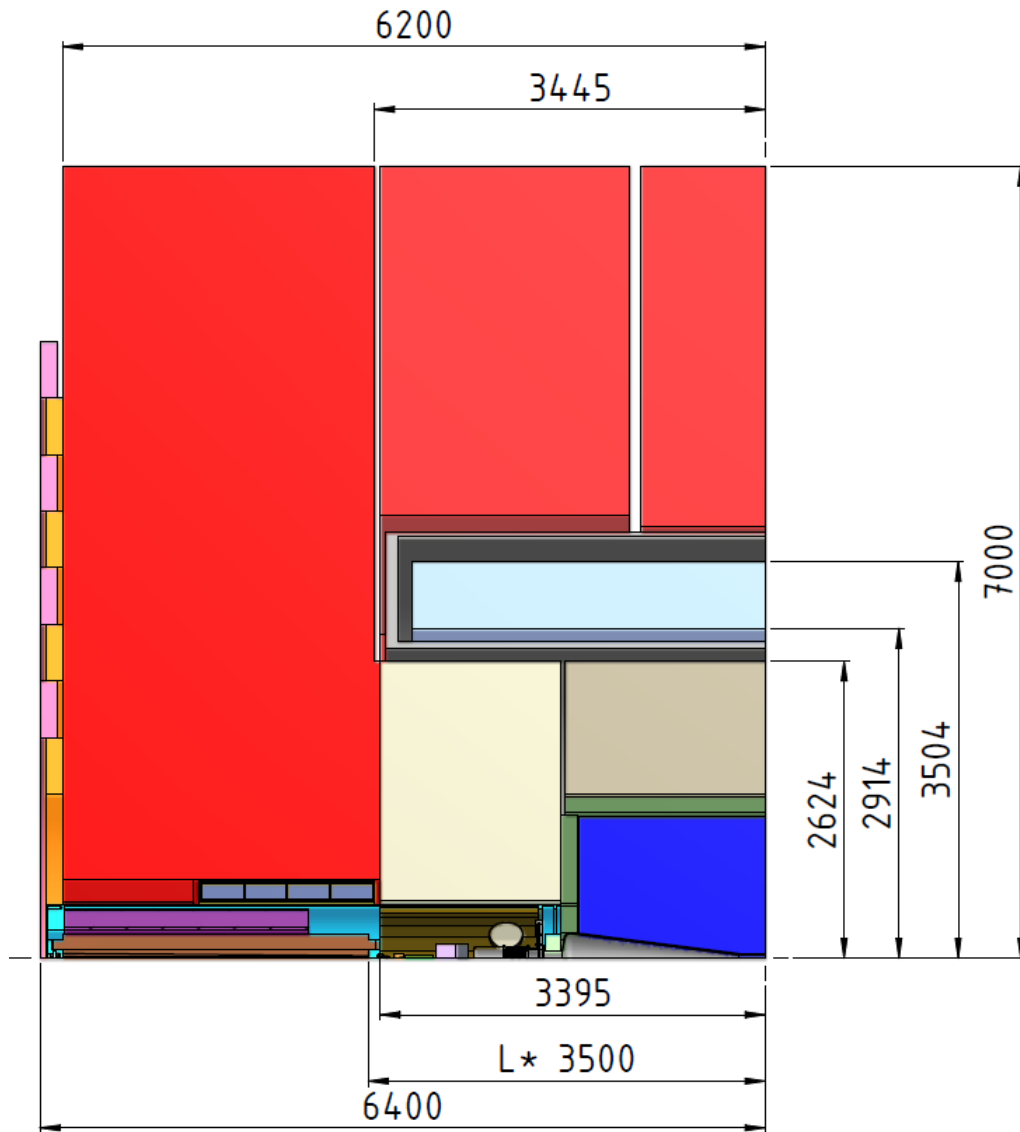

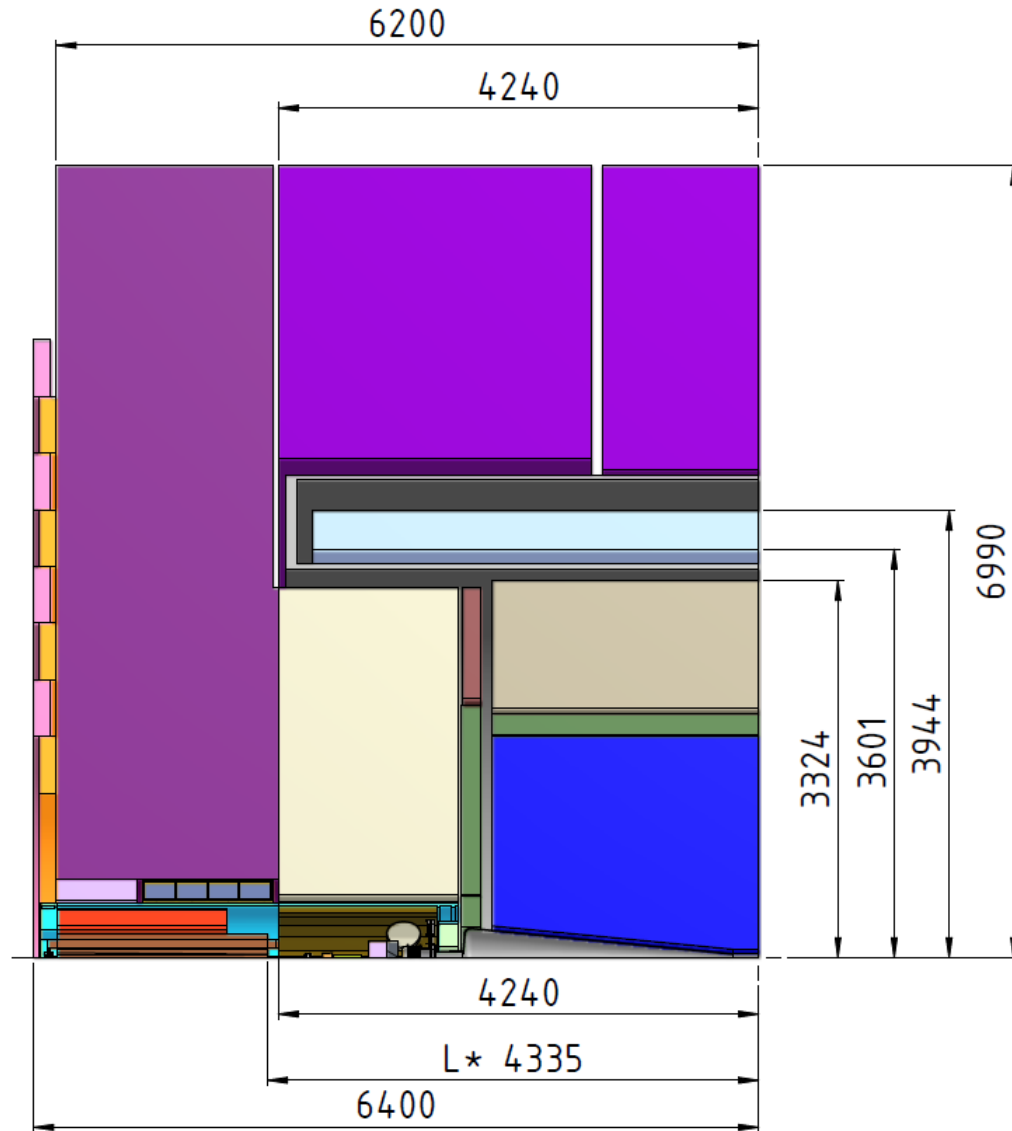

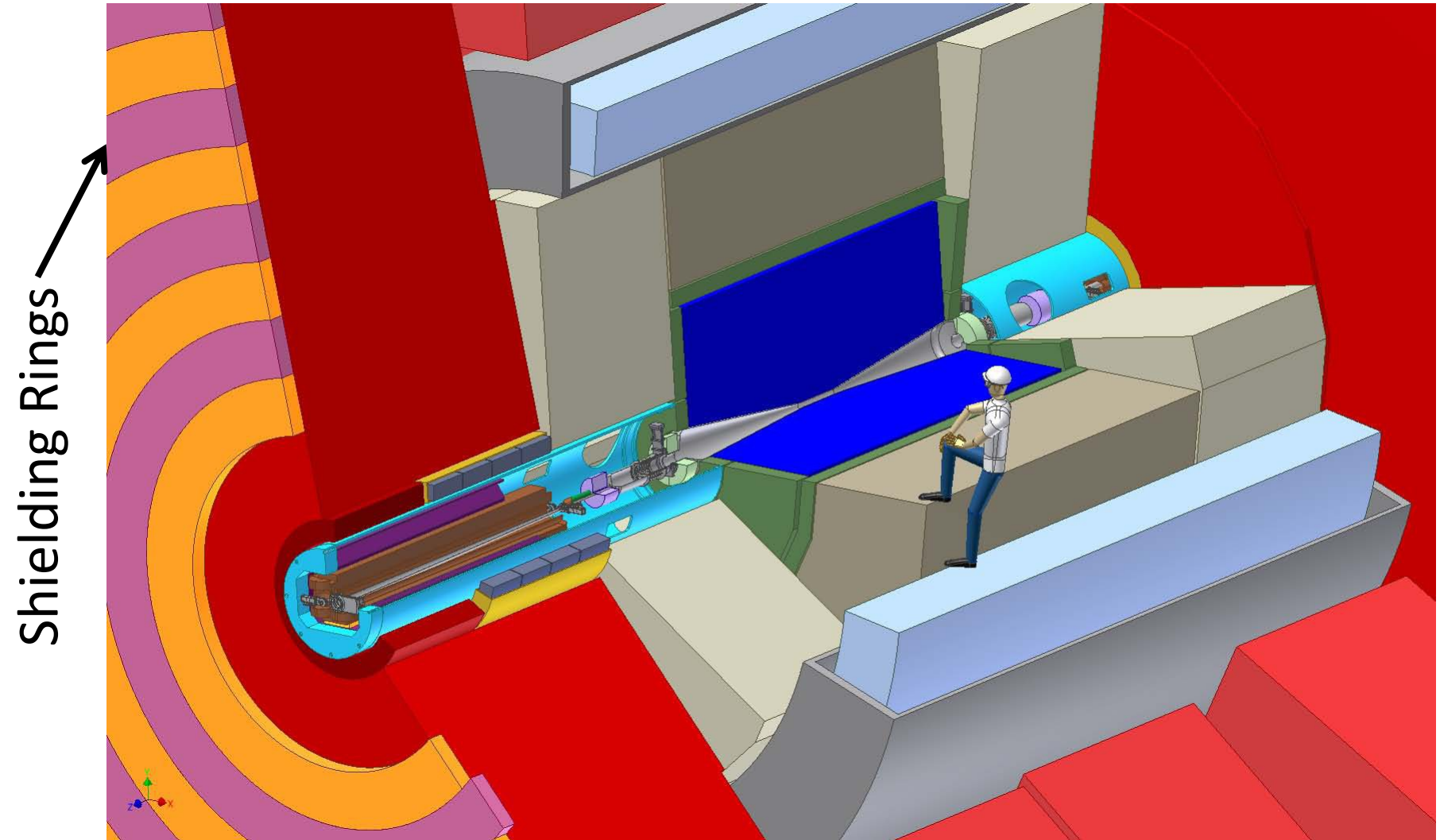

reminder: opening the detector

(caution: drawings of 2009 model)

1

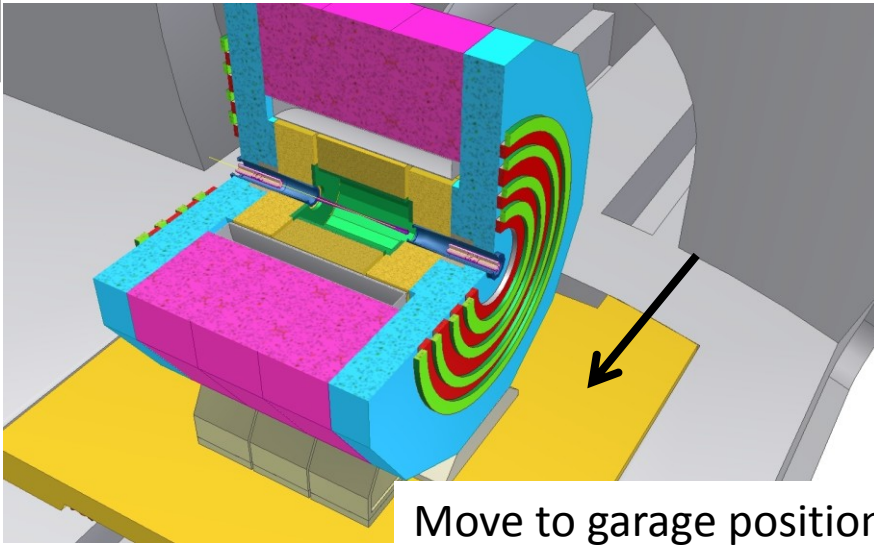

Move to garage position

2

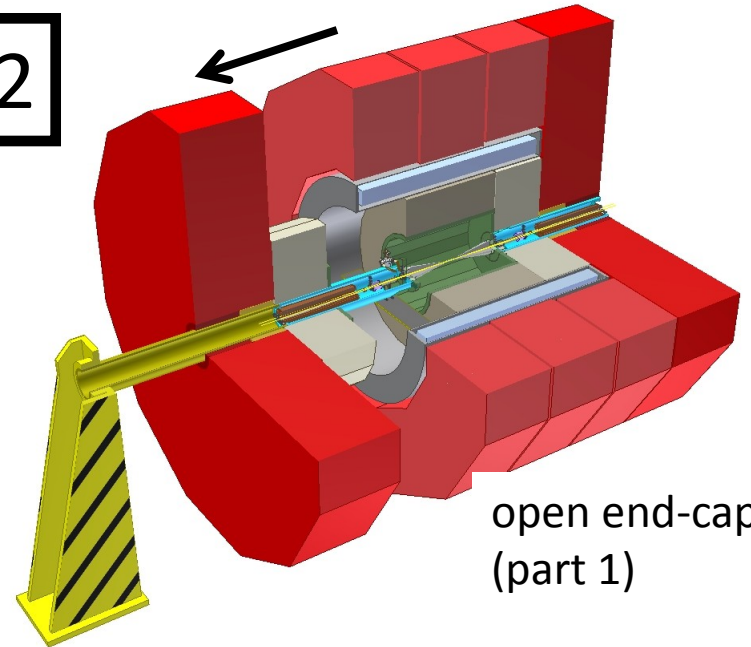

open end-cap
(part 1)

3

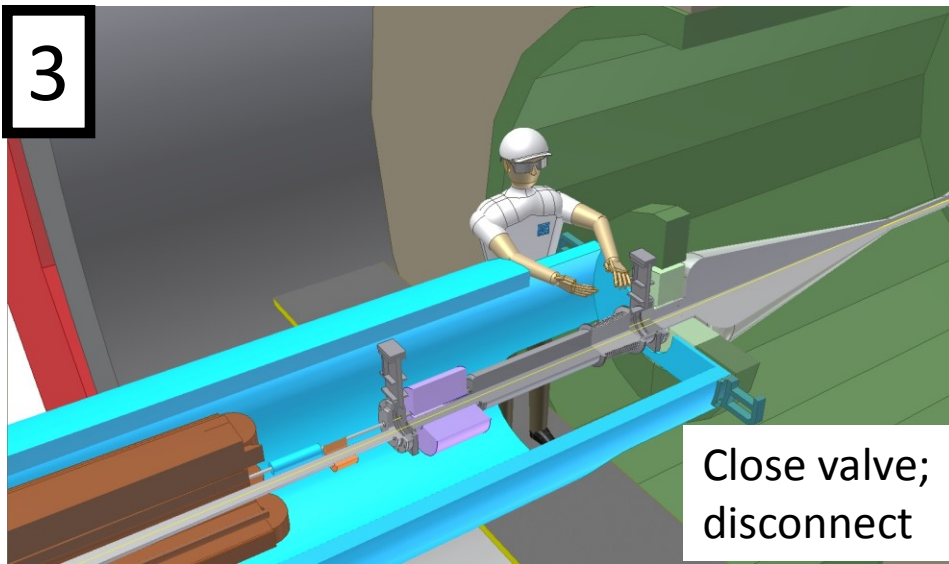

Close valve;
disconnect

4

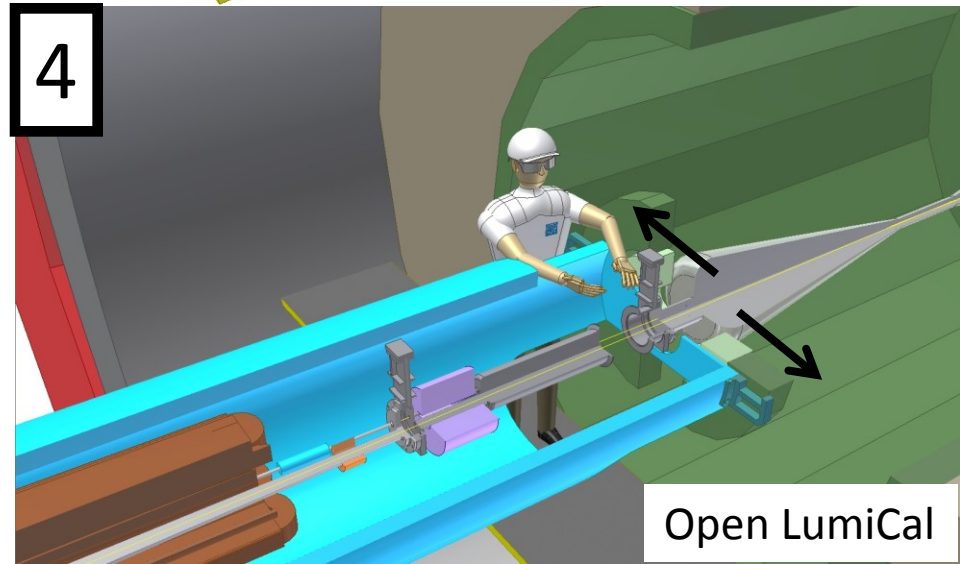

Open LumiCal

reminder: opening the detector (2)

(caution: drawings of 2009 model)

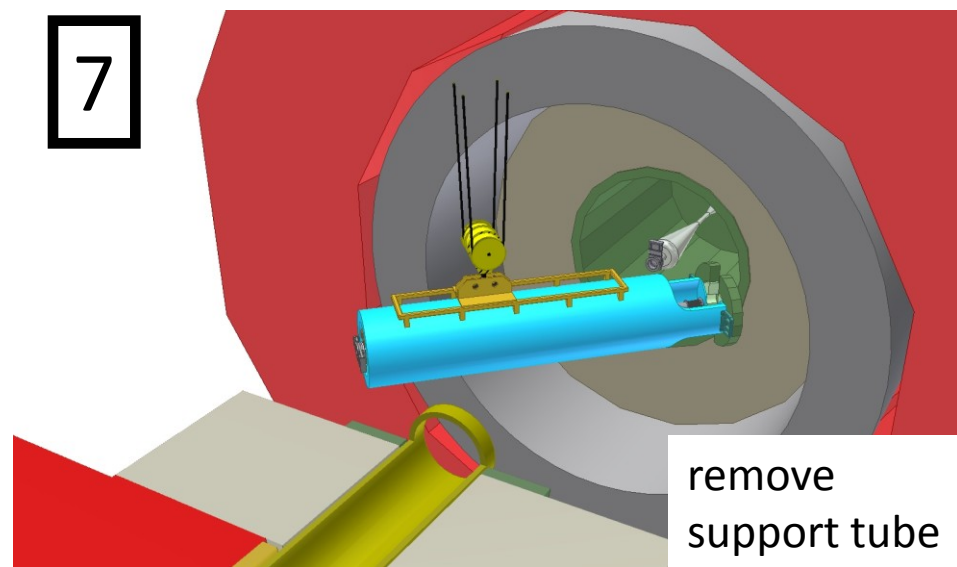
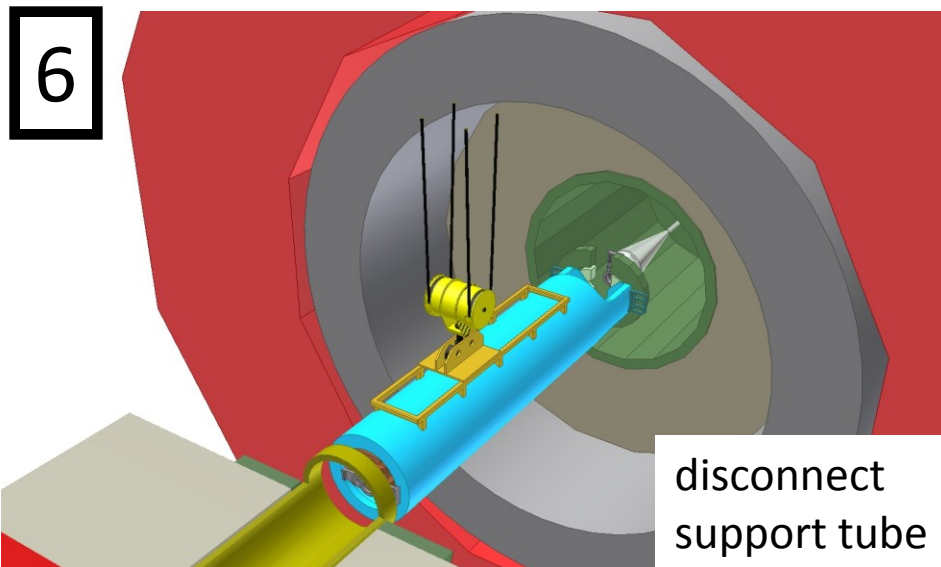
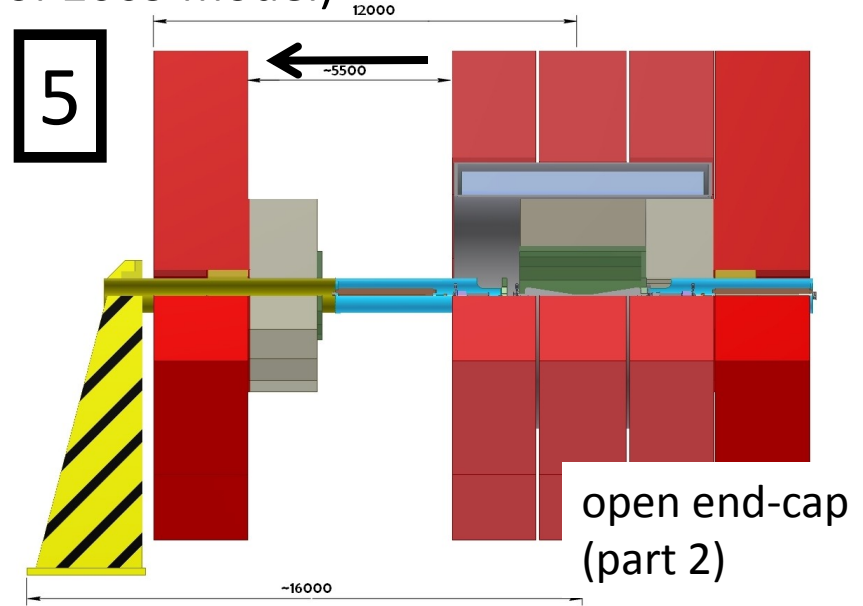
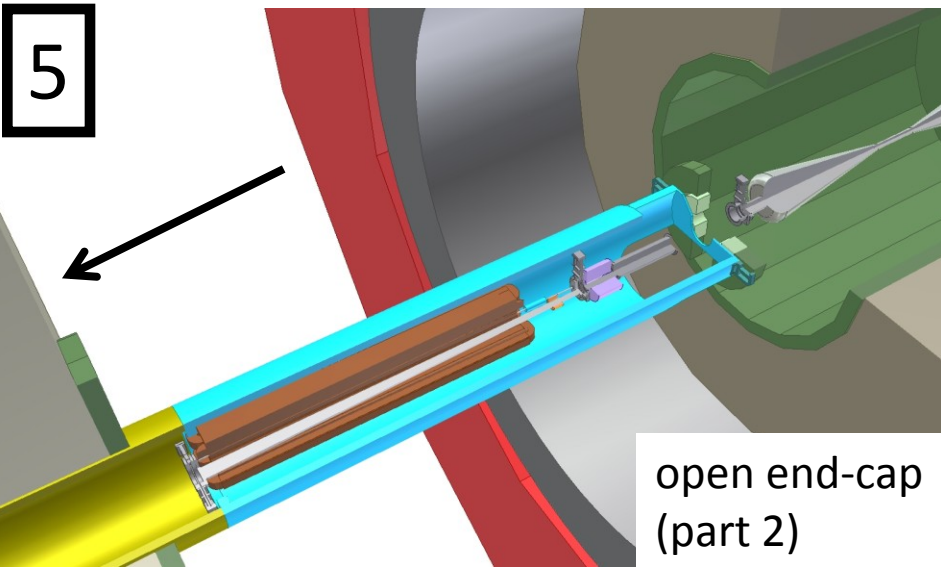

QD0 and Anti-Solenoid

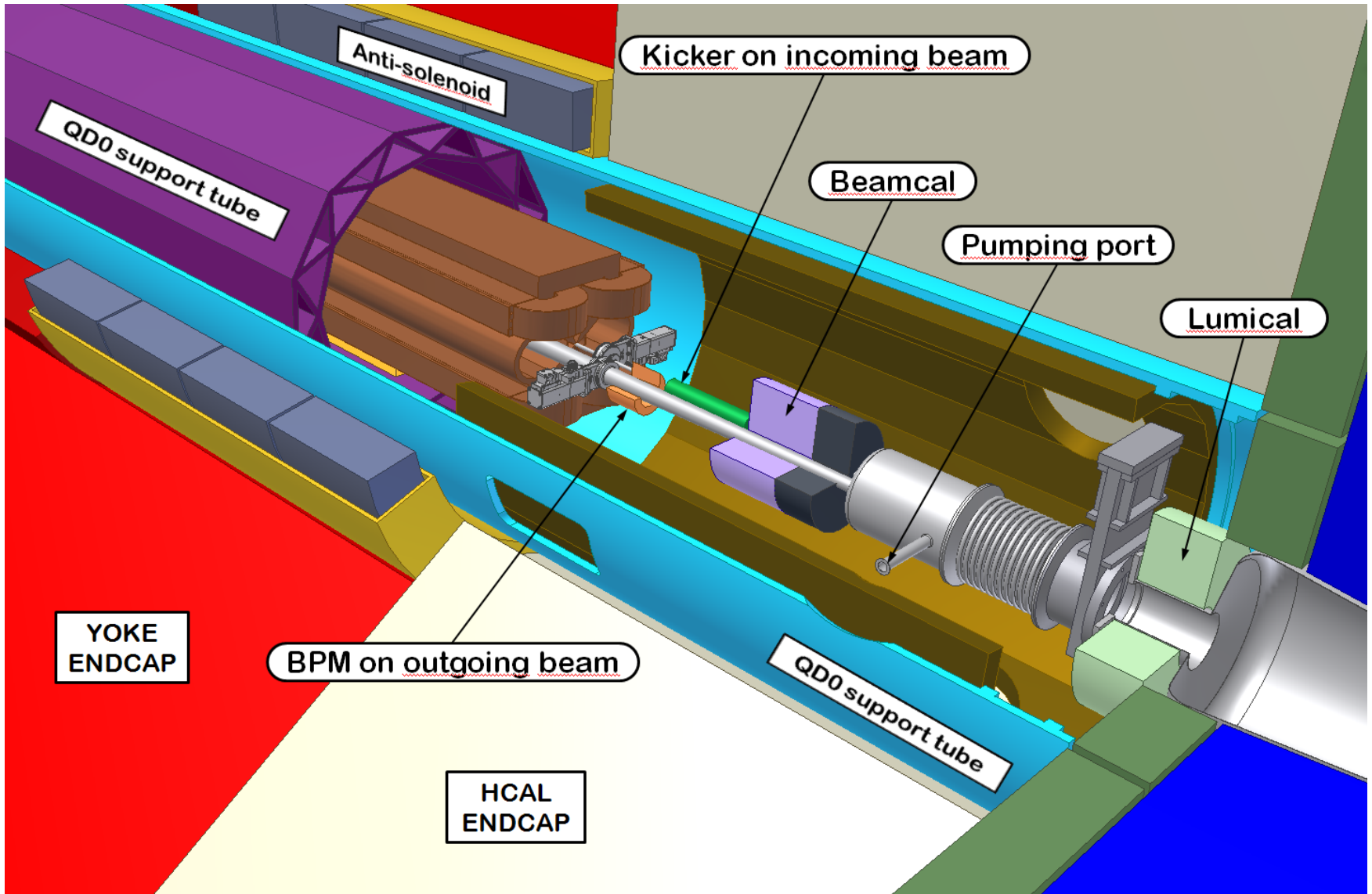

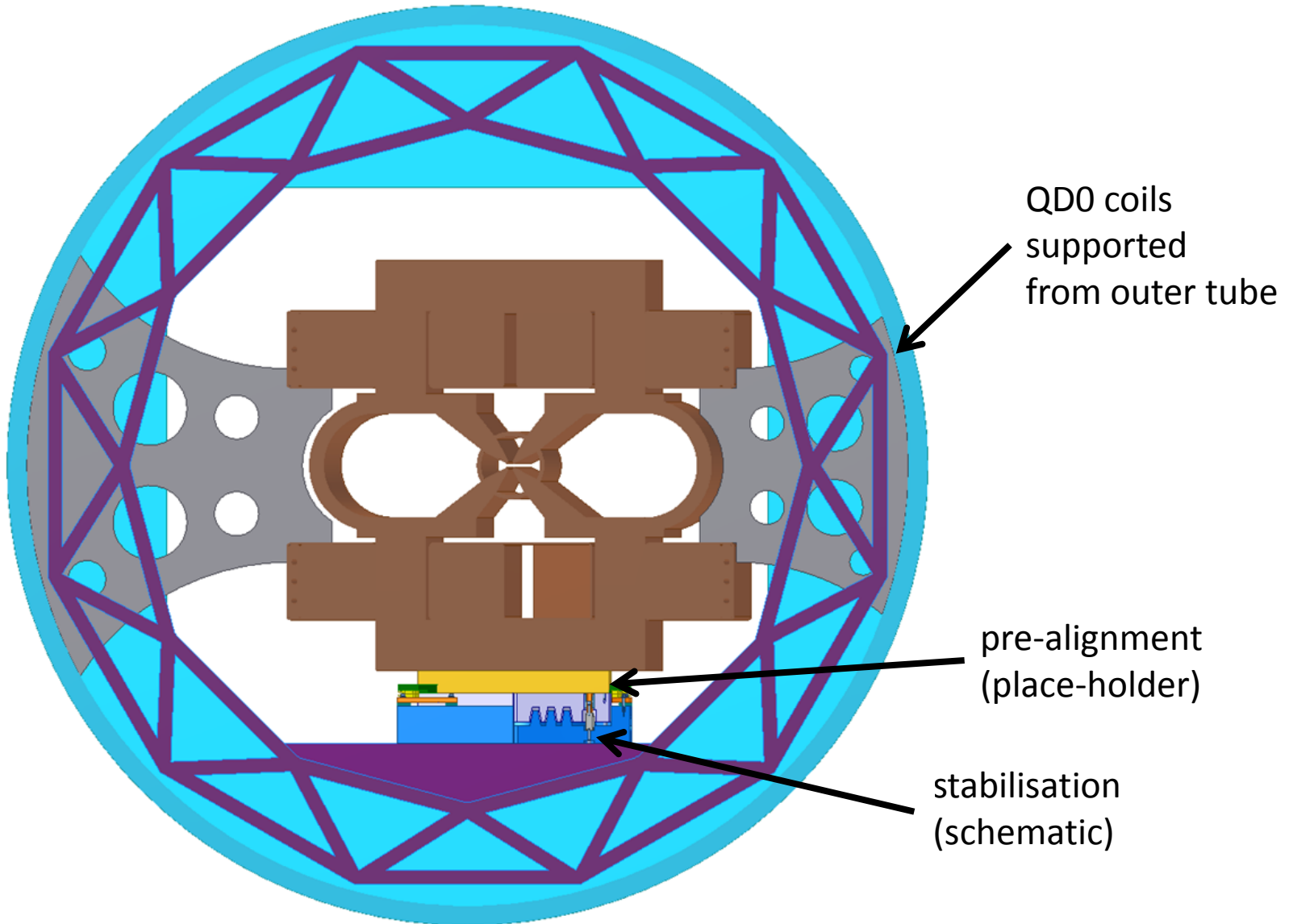

QD0 – 10 cm prototype under construction

5.75 T/m, $R = 4.2$ mm

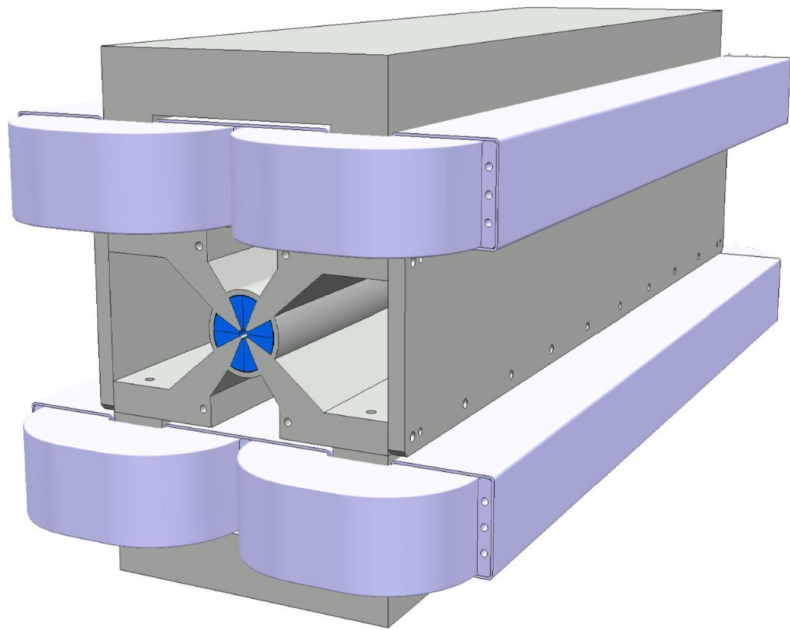

permendur

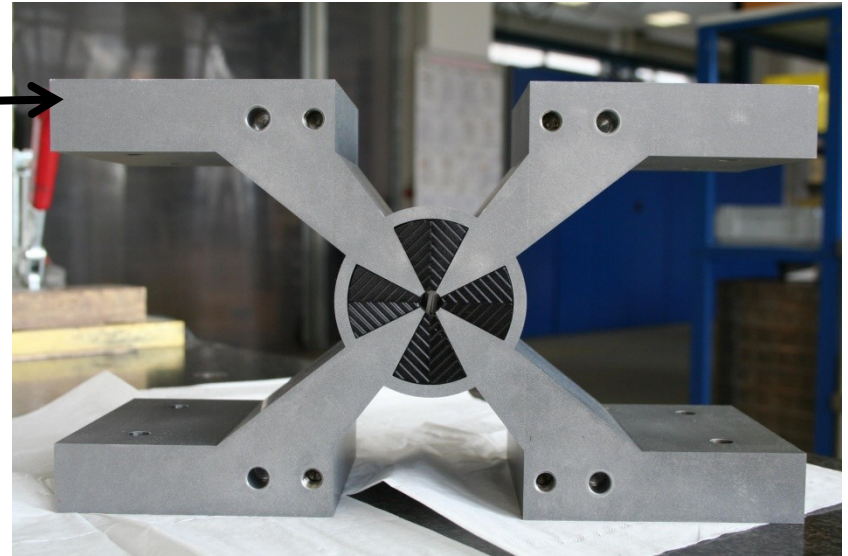

SmCo

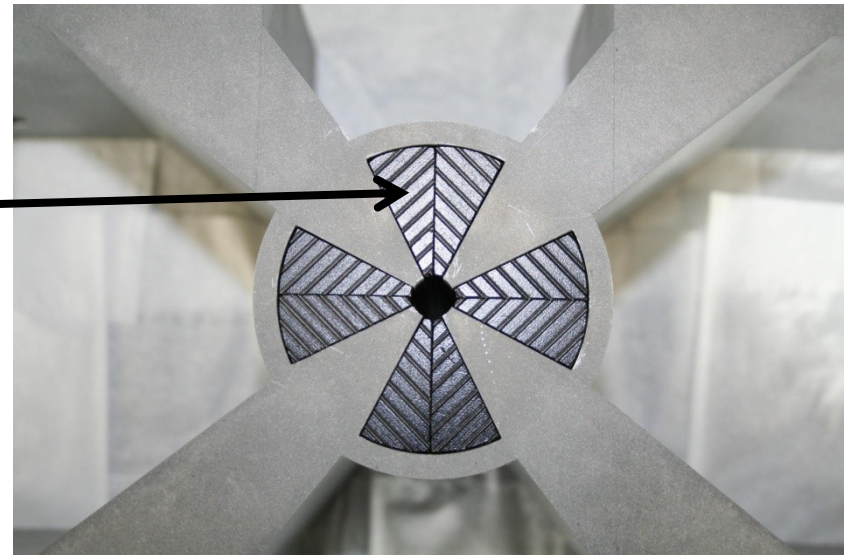

- Magnet conceptual and detailed design: CERN
- Manufacturing of main components (quadrupole core in Permendur by electro-erosion ; PM blocks): Vacuumschmelze (D)
- Manufacturing of return yoke and coils: CERN

QD0 and Anti-Solenoid

(reduce B-field affecting the beam)

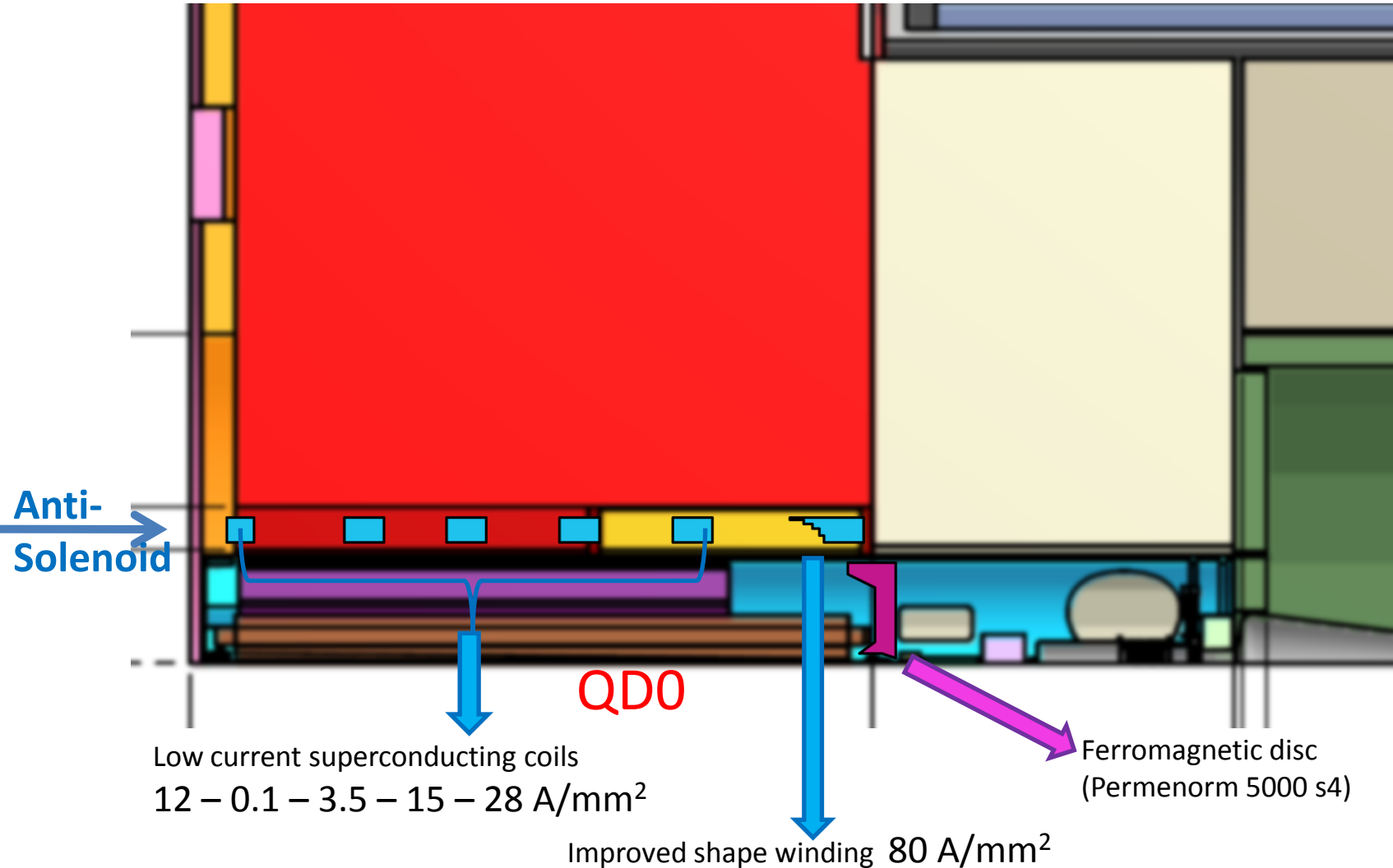

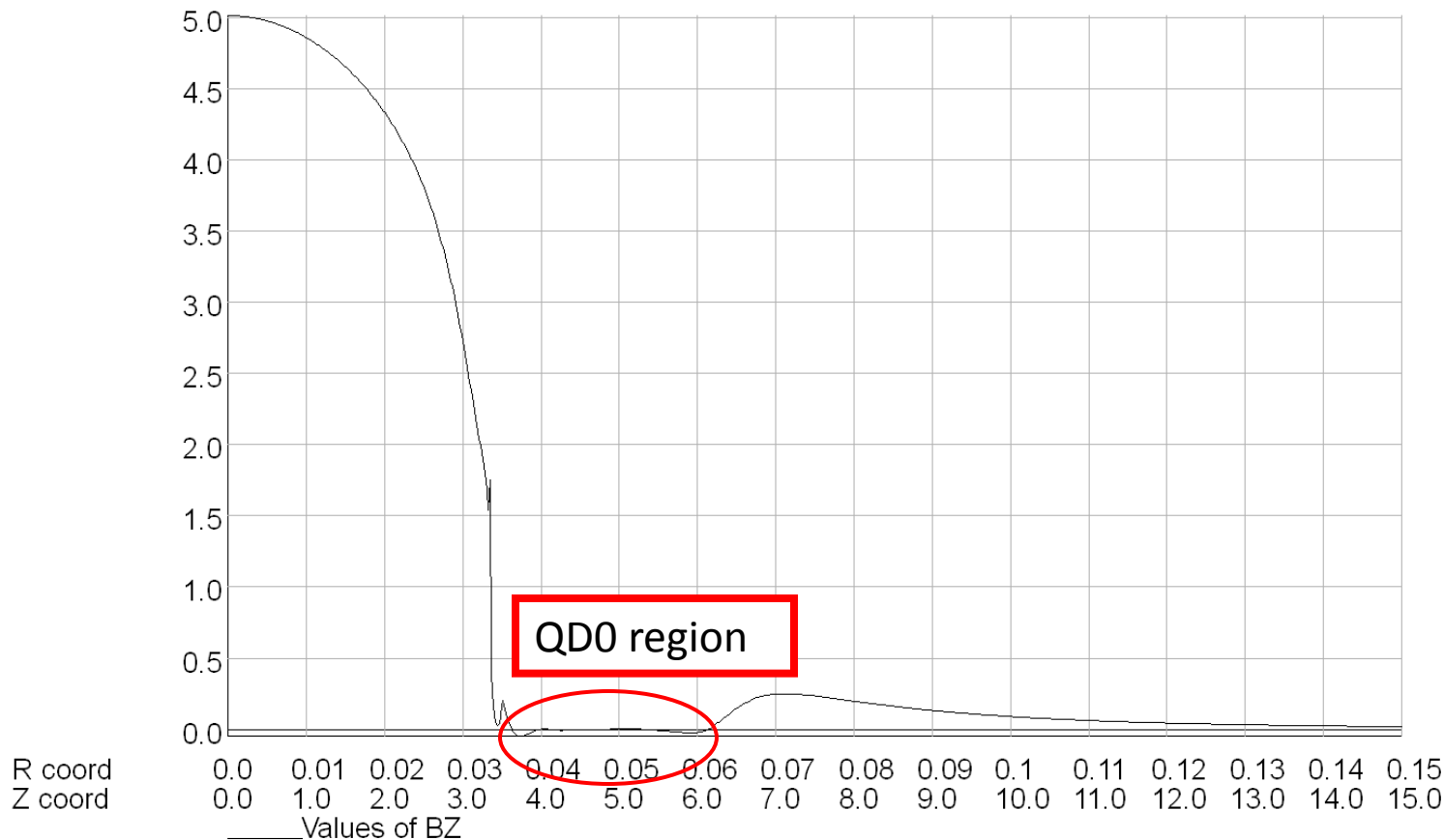

UNITS

Length	: m
Flux density	: T
Field strength	: A m ⁻¹
Potential	: Wb m ⁻¹
Conductivity	: S m ⁻¹
Source density	: A m ⁻²
Power	: W
Force	: N
Energy	: J
Mass	: kg

MODEL DATA

\cern.ch\dfs\Users\alab	
artale\Documents\Opera	
a Model\experiment_v	
er2c.st	
Linear elements	
Axi-symmetry	
Modified R [*] vec pot.	
Magnetic fields	
Static solution	
Scale factor: 1.0	
34402 elements	
17510 nodes	
12 regions	

resulting Bz on the beam axis

forces calculated (earlier layout):

both solenoid AND antisolenoid are energized

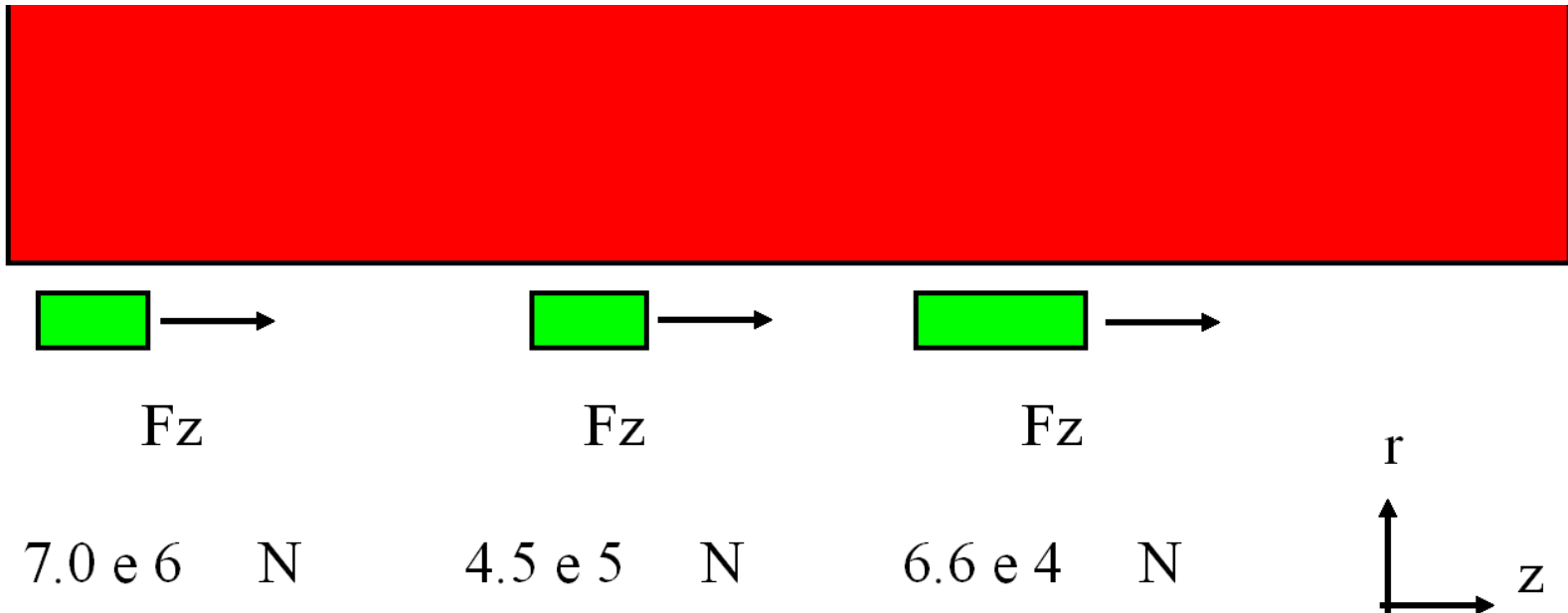

Resulting forces tend to push the antisolenoid **away** from the IP

Radiation to QD0 (using Mokka)

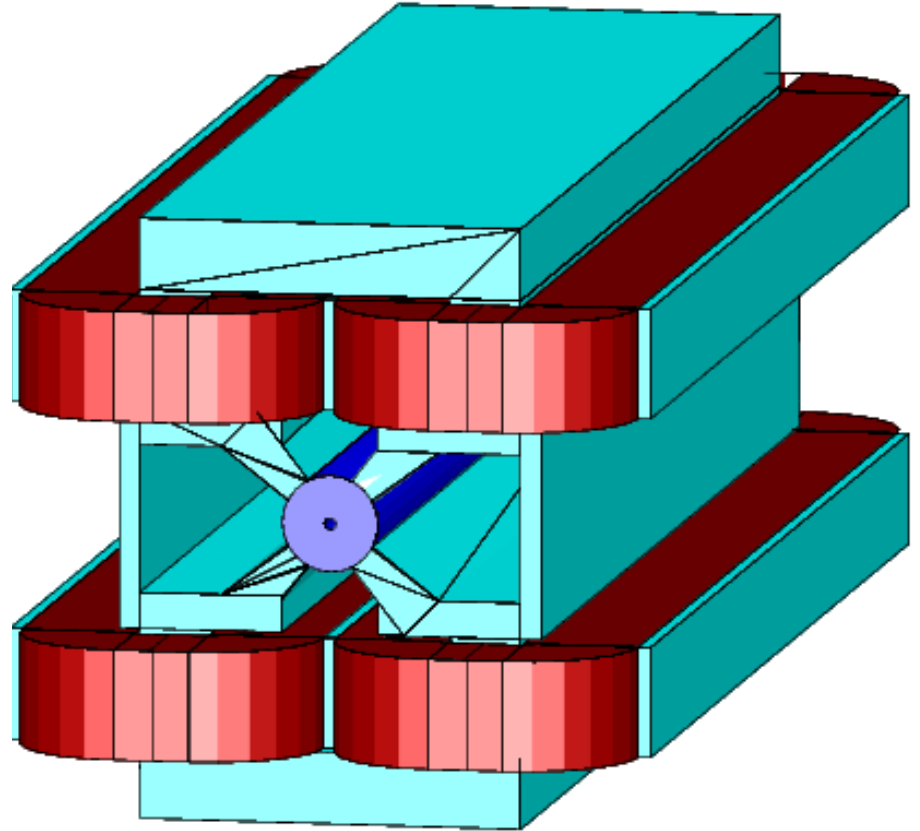
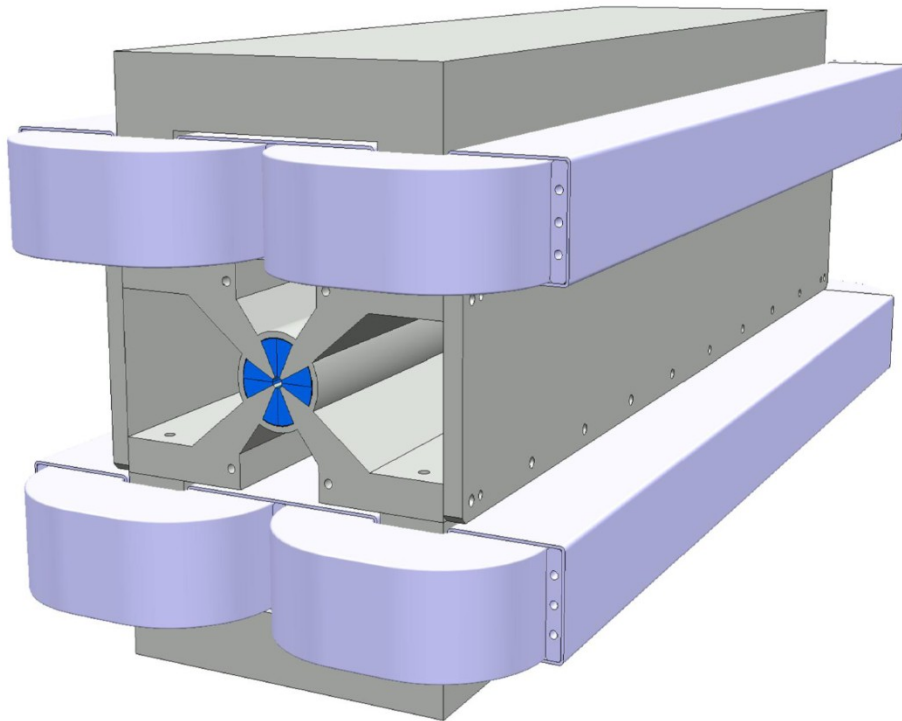

Radiation to QD0 (in Mokka)

Model contains 1 m long QD0, in CLIC_ILD detector

Cross section distribution,
dose integrated over full length

Longitudinal distribution,
dose integrated over full section

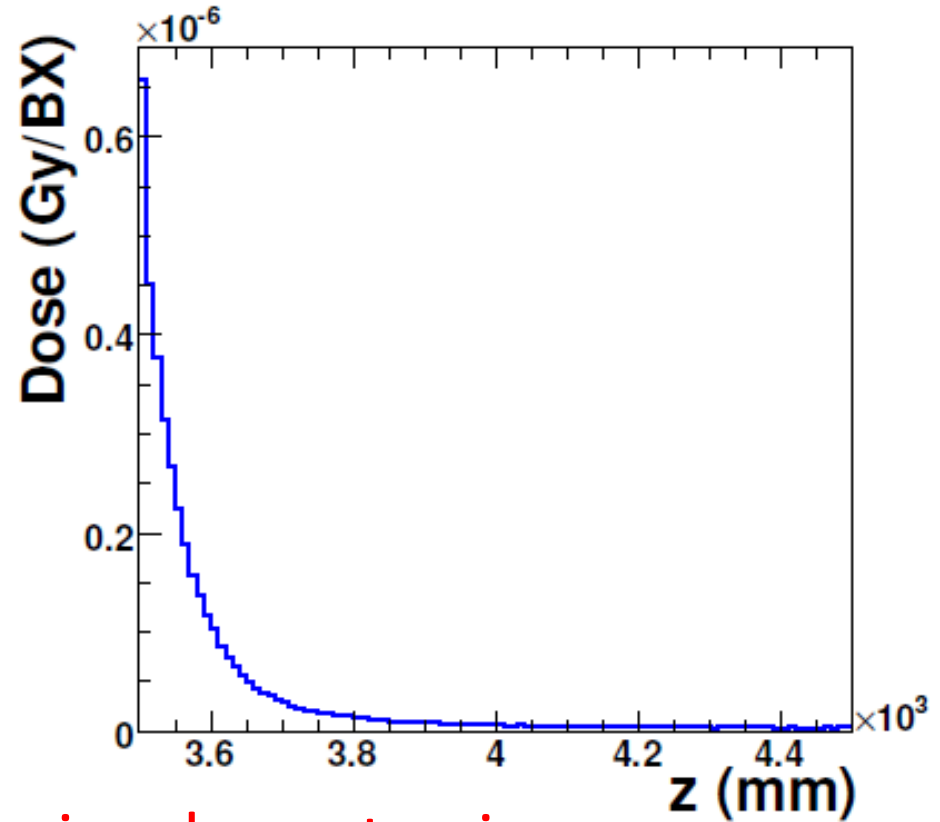
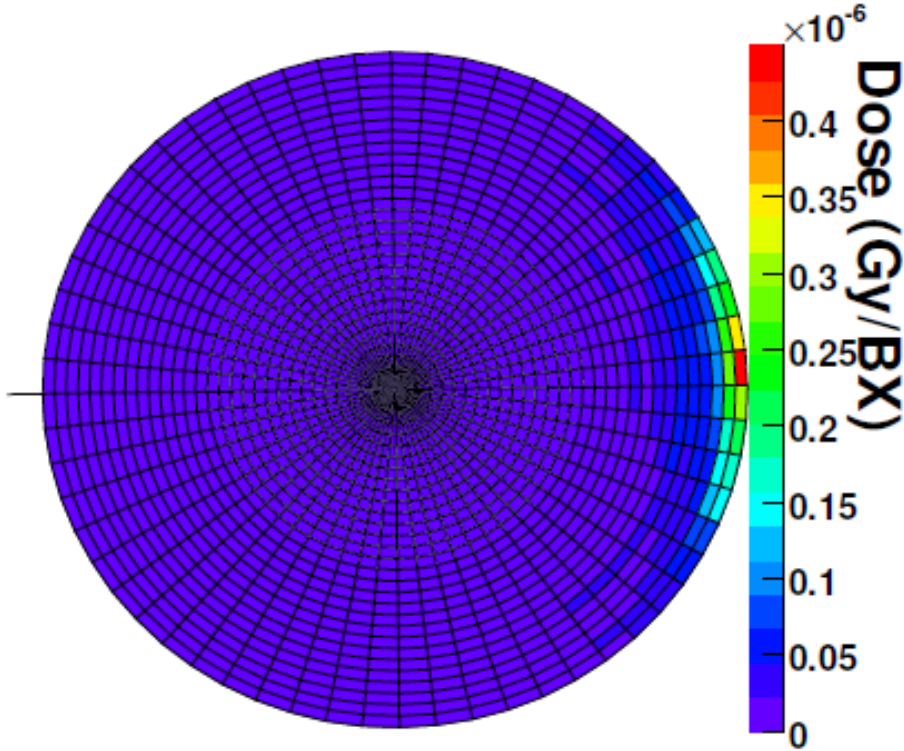

< 270 kGy/y from incoherent pairs

< 50 Gy/y from neutrons

VERY PRELIMINARY - without magnetic field

No Shielding Rings

With Shielding Rings

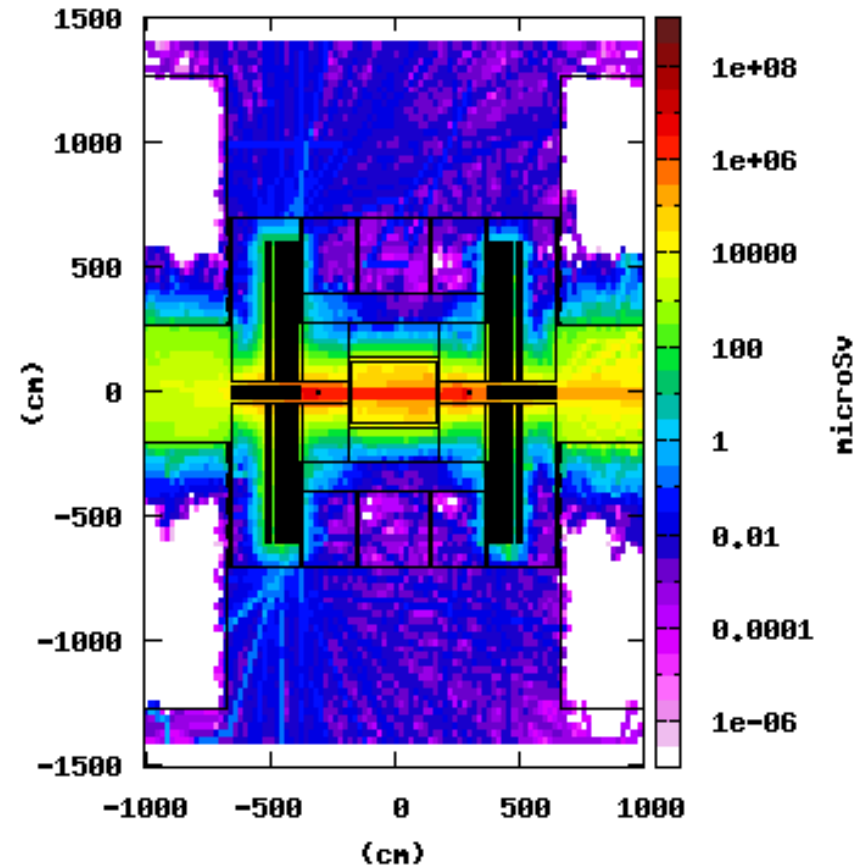
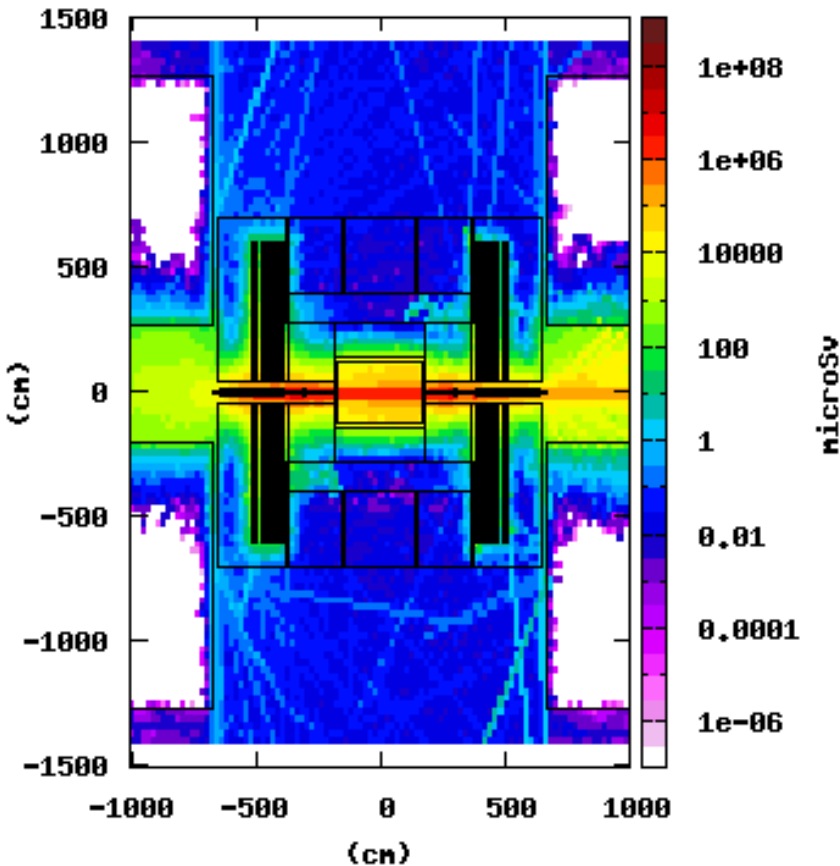

For this loss scenario, prompt dose $<10 \mu\text{Sv}$ outside detector

$H^*(10) > 0.5 \mu\text{Sv}\cdot\text{h}^{-1}$: Radiation Area

$H^*(10) < 10 \mu\text{Sv}\cdot\text{h}^{-1}$: Allows 'hands-on' interventions during intervention times measured in hours or days

1 train - full beam loss on QD0 (FLUKA)

VERY PRELIMINARY - without magnetic field

No Shielding Rings

With Shielding Rings

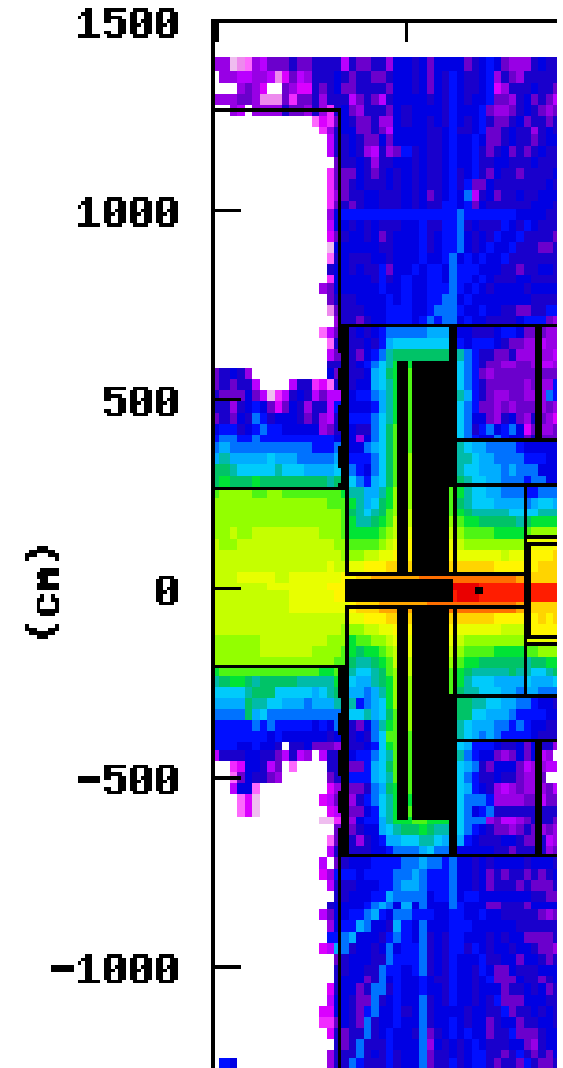
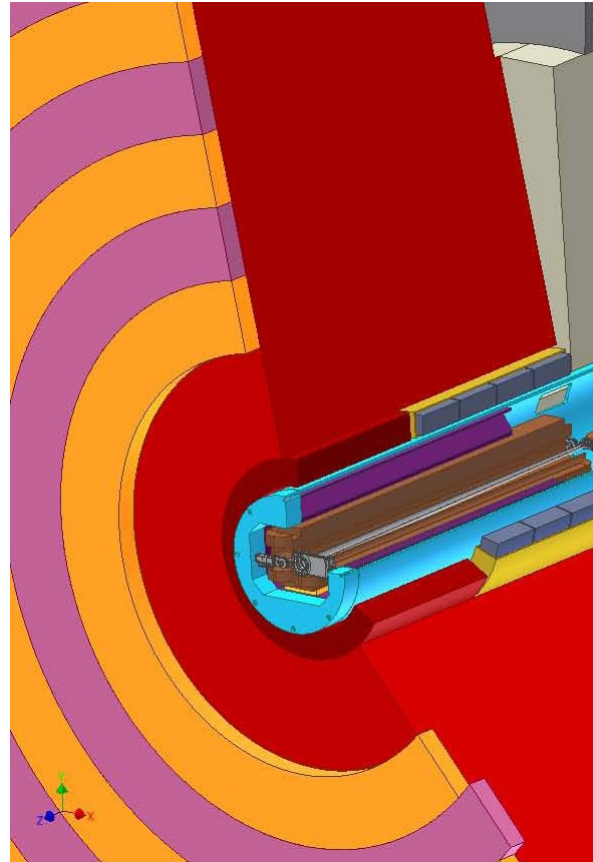
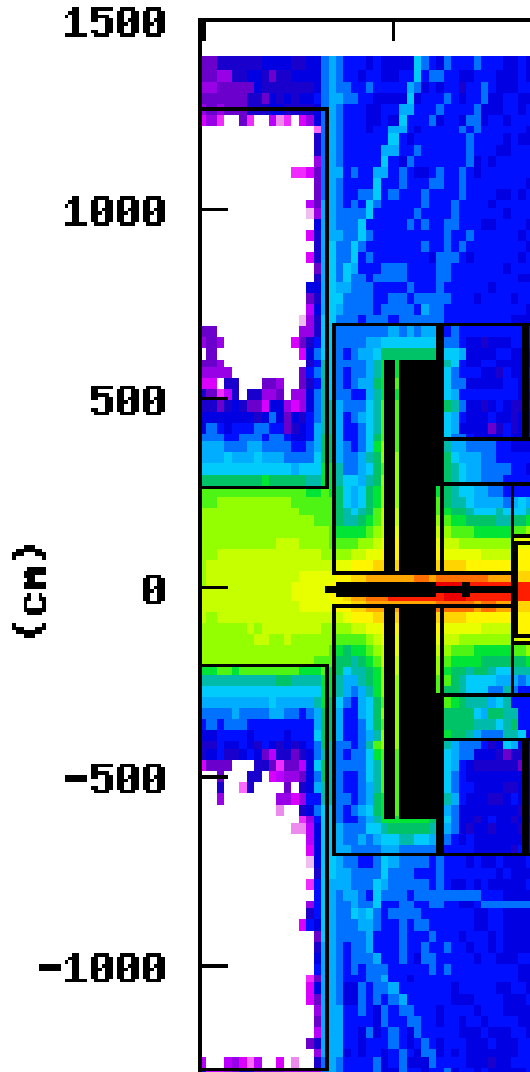

1 train - full beam loss on QD0 (FLUKA)

VERY PRELIMINARY - without shielding rings

No Field

5T Field

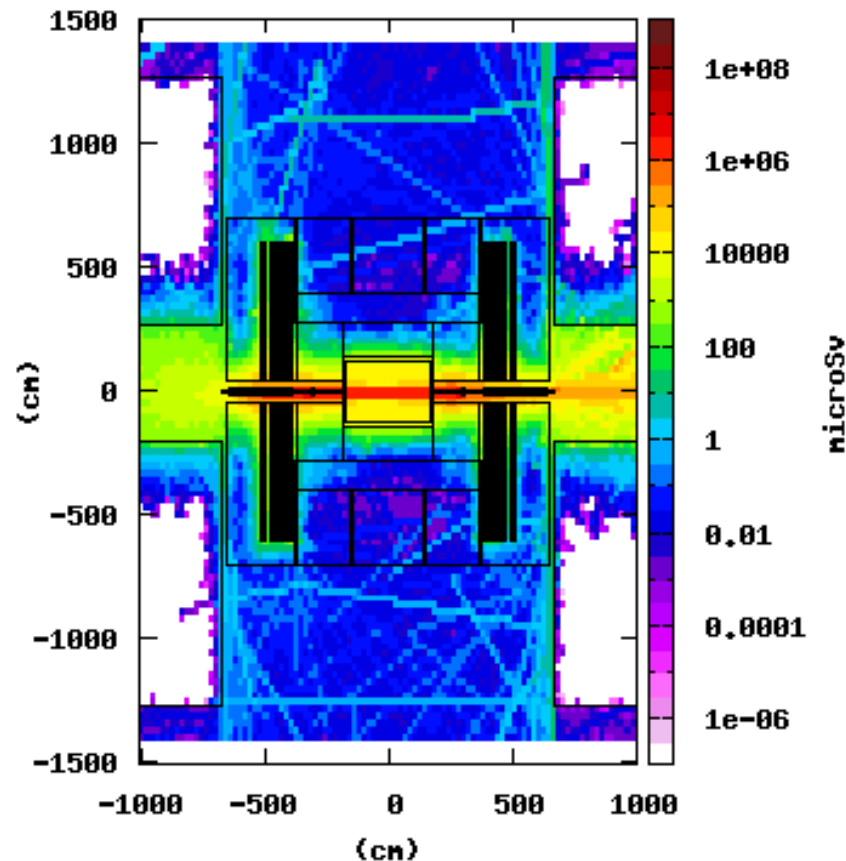
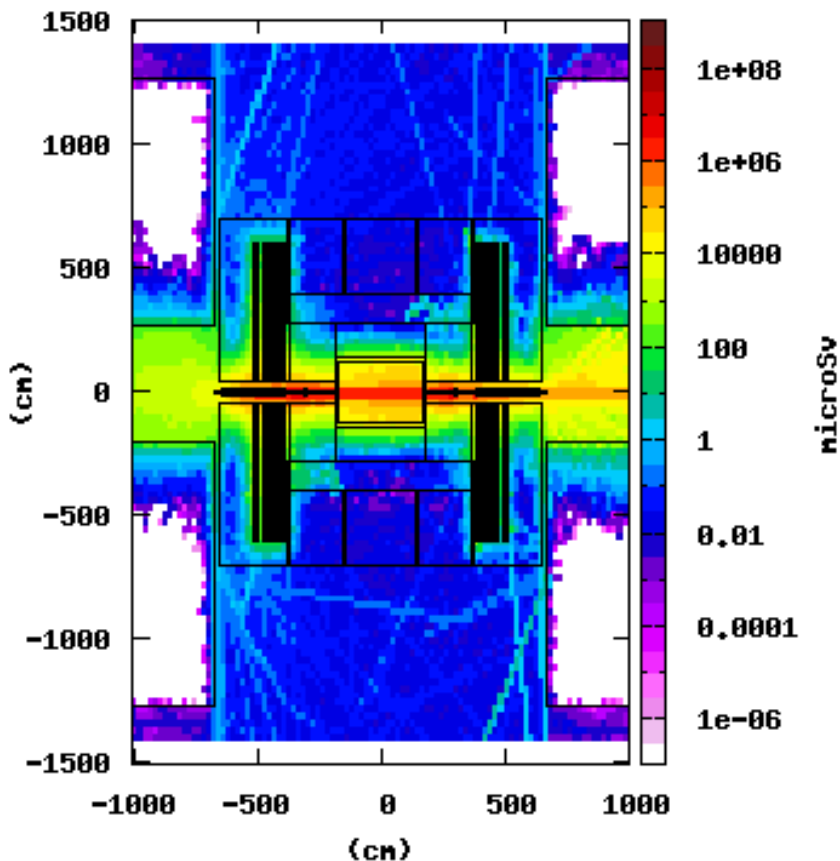

For this loss scenario,
prompt dose <10 μSv outside detector

For this loss scenario,
prompt dose <50 μSv outside detector

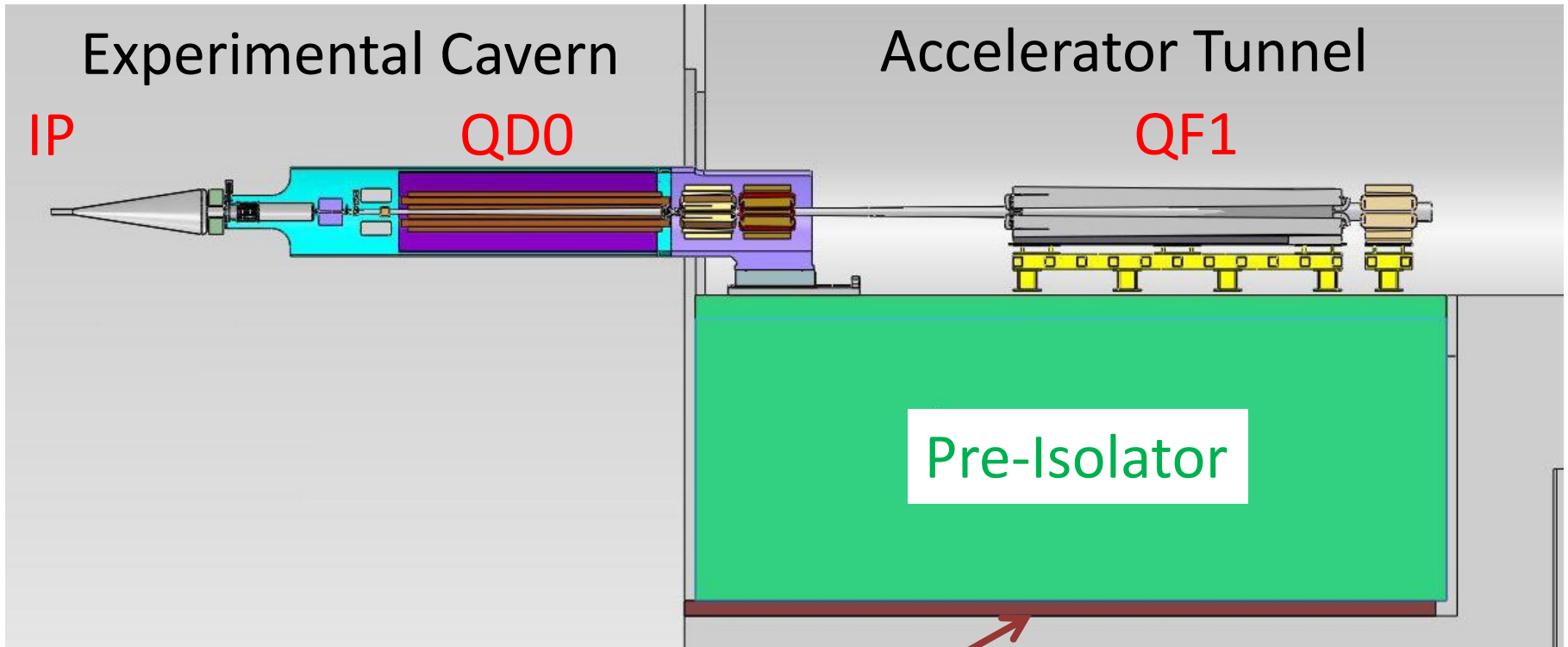

e.g. "air springs"

Vertical steady-state response at QD0

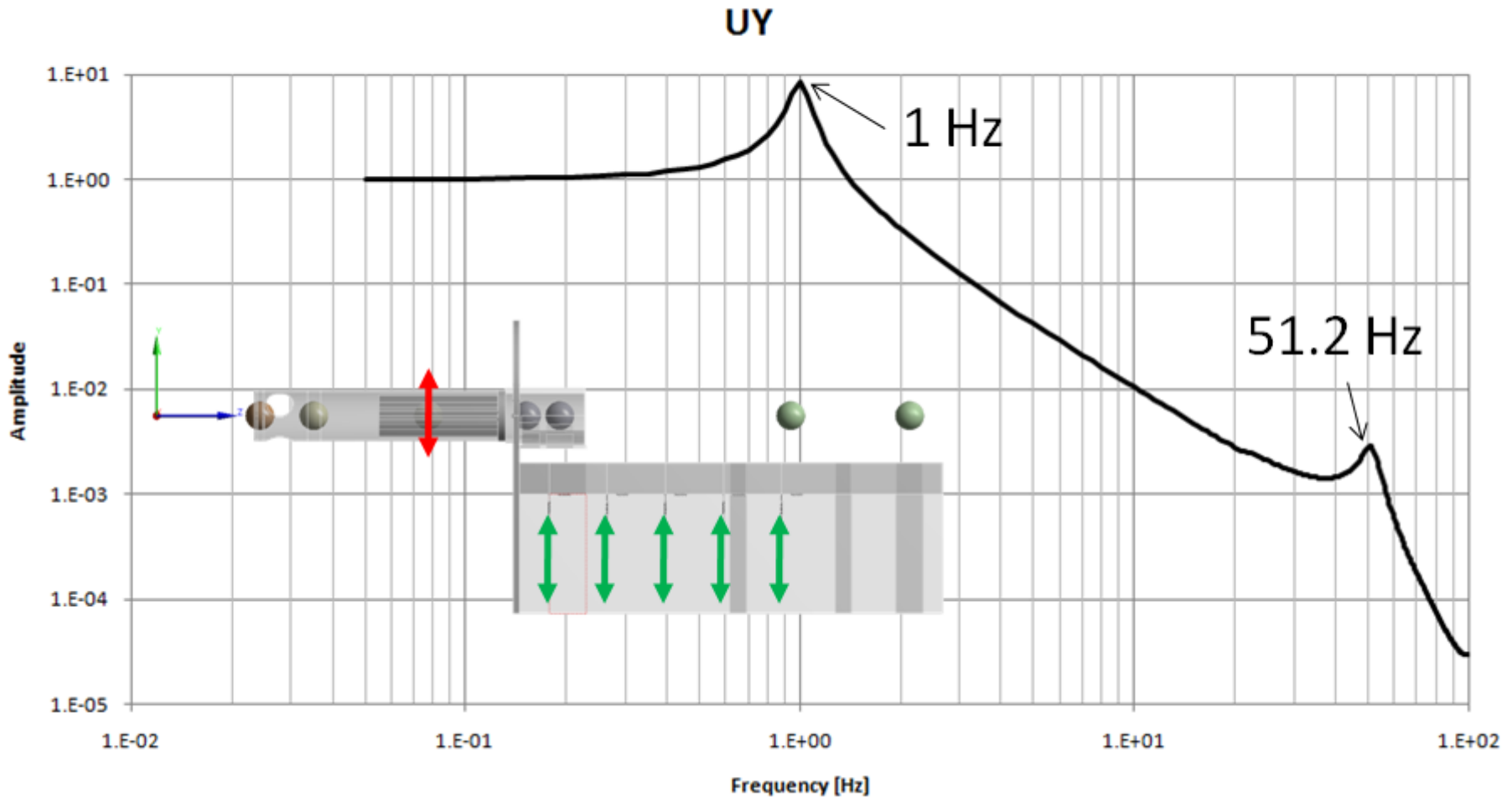

Pre-Isolator: Update – simple test set-up (more challenging for the model calculations !)

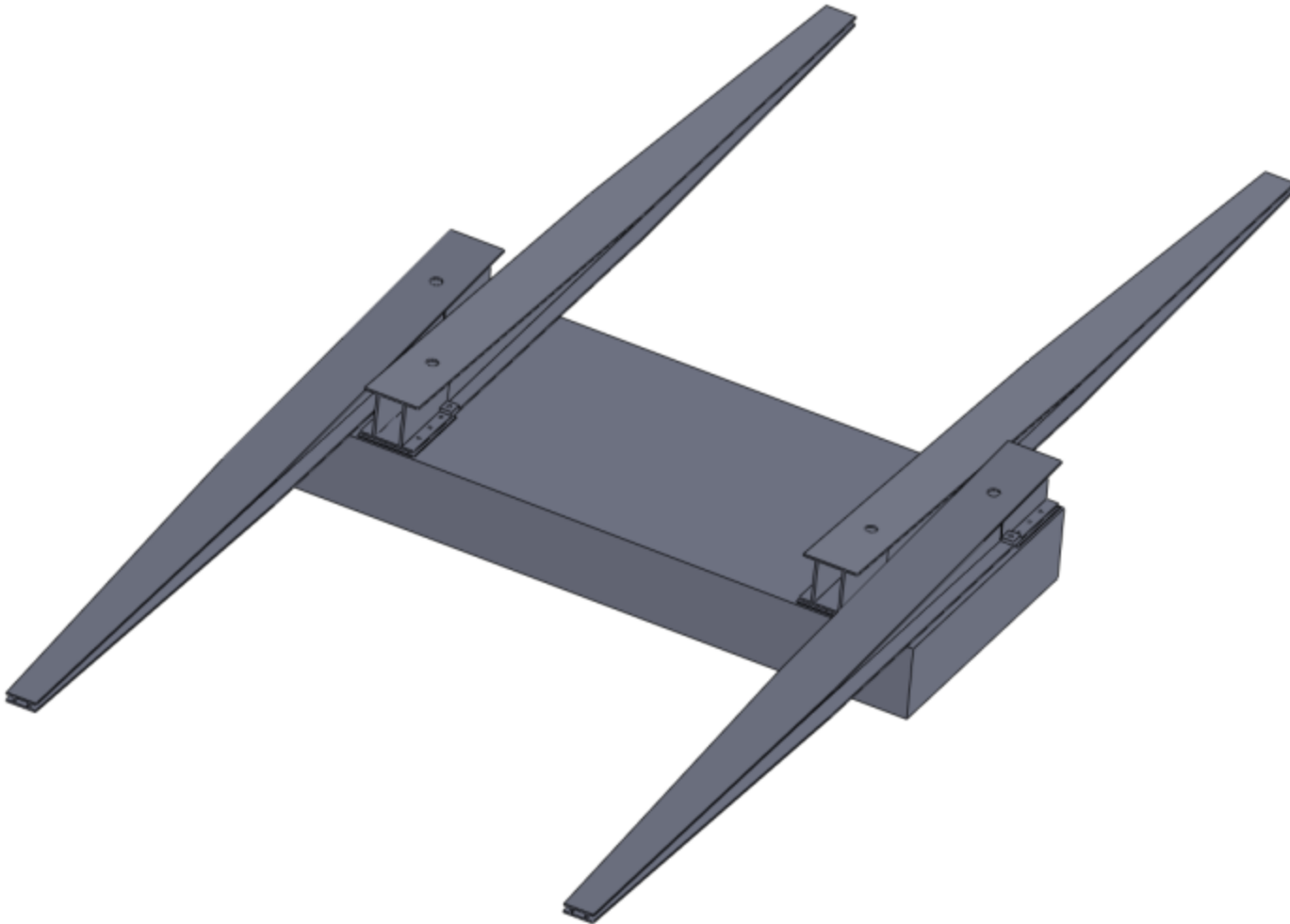

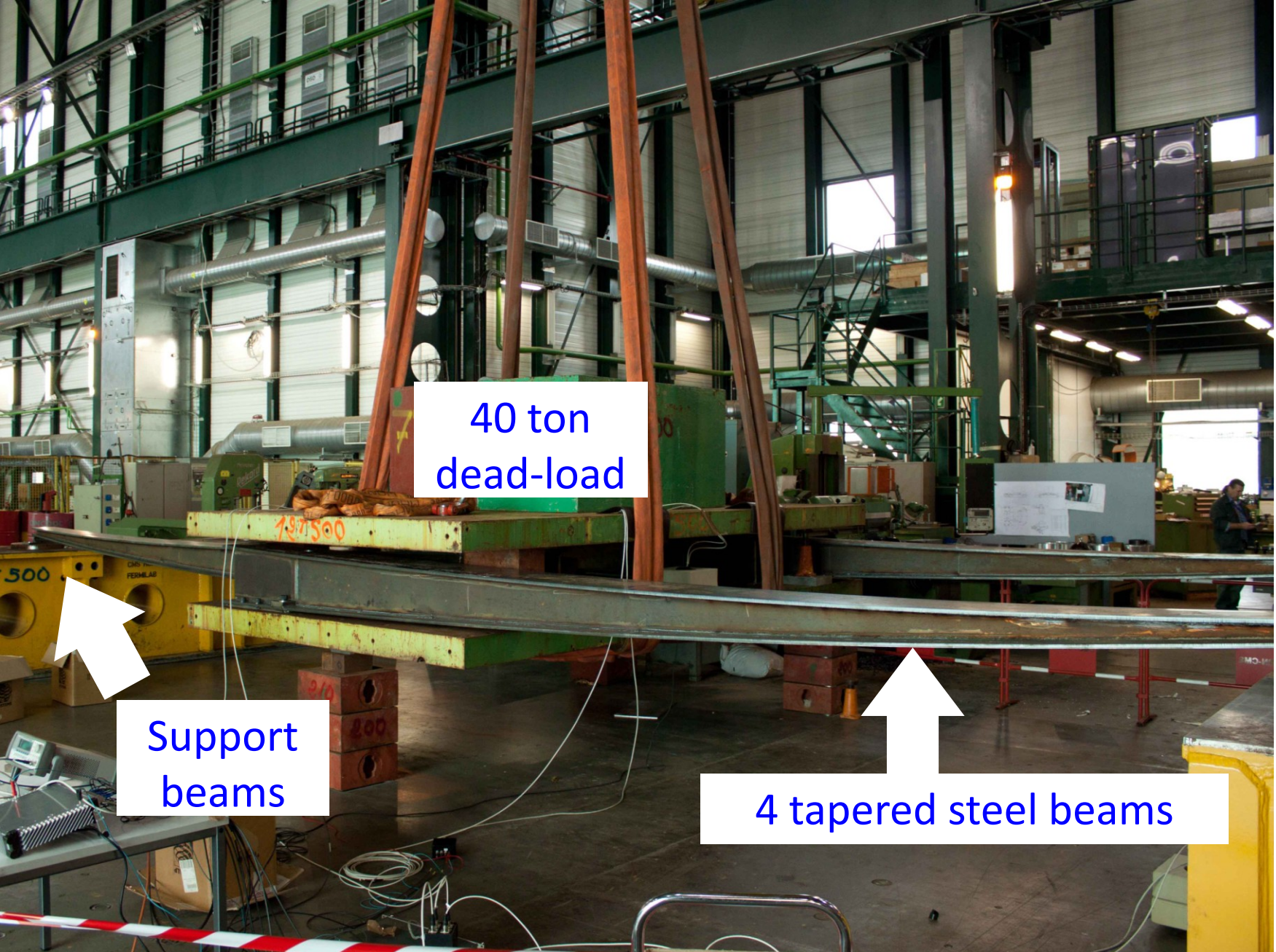

40 ton
dead-load

Support
beams

4 tapered steel beams

Combined harmonic response in the vertical direction

Simulated

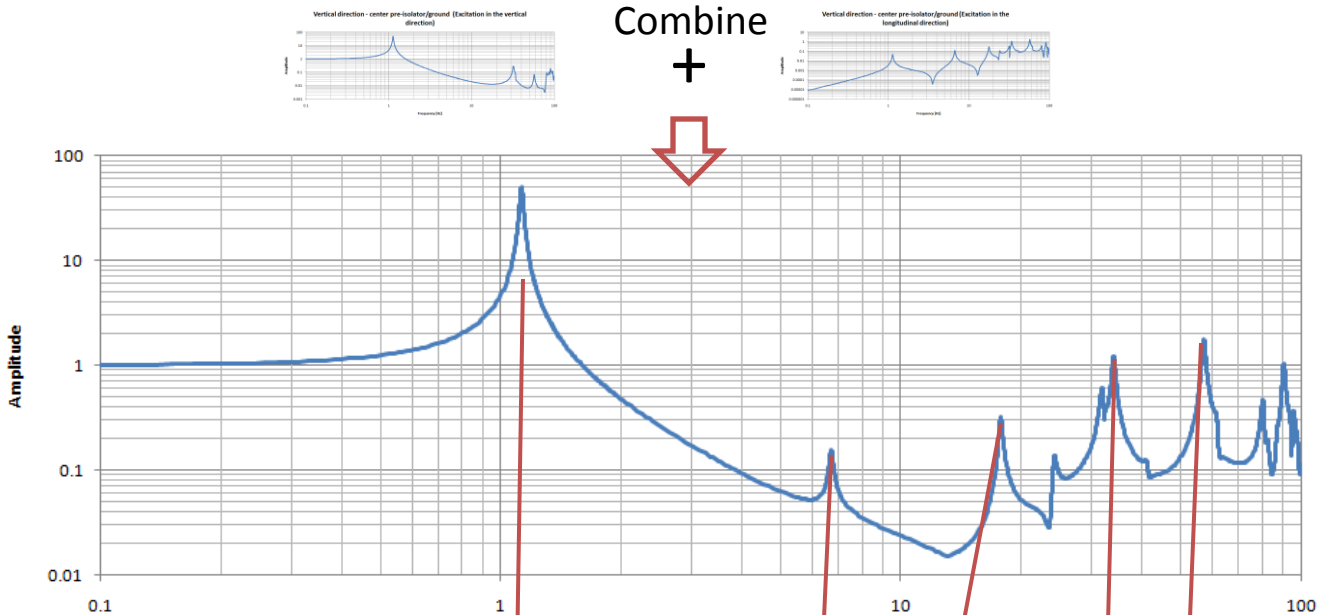

Measured

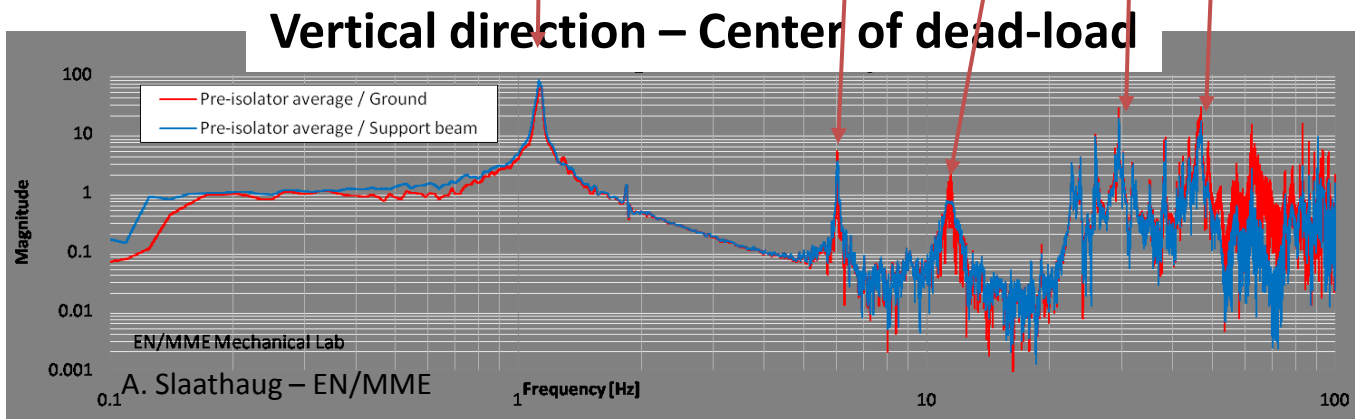

Initial design

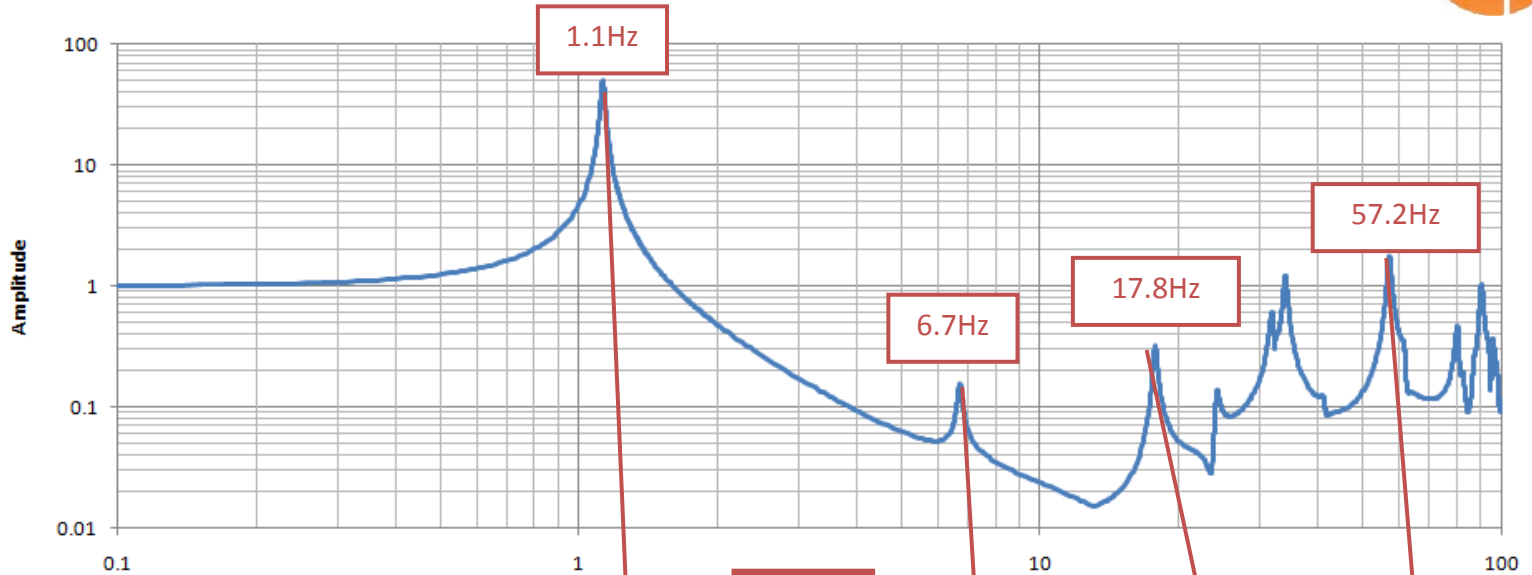

New design

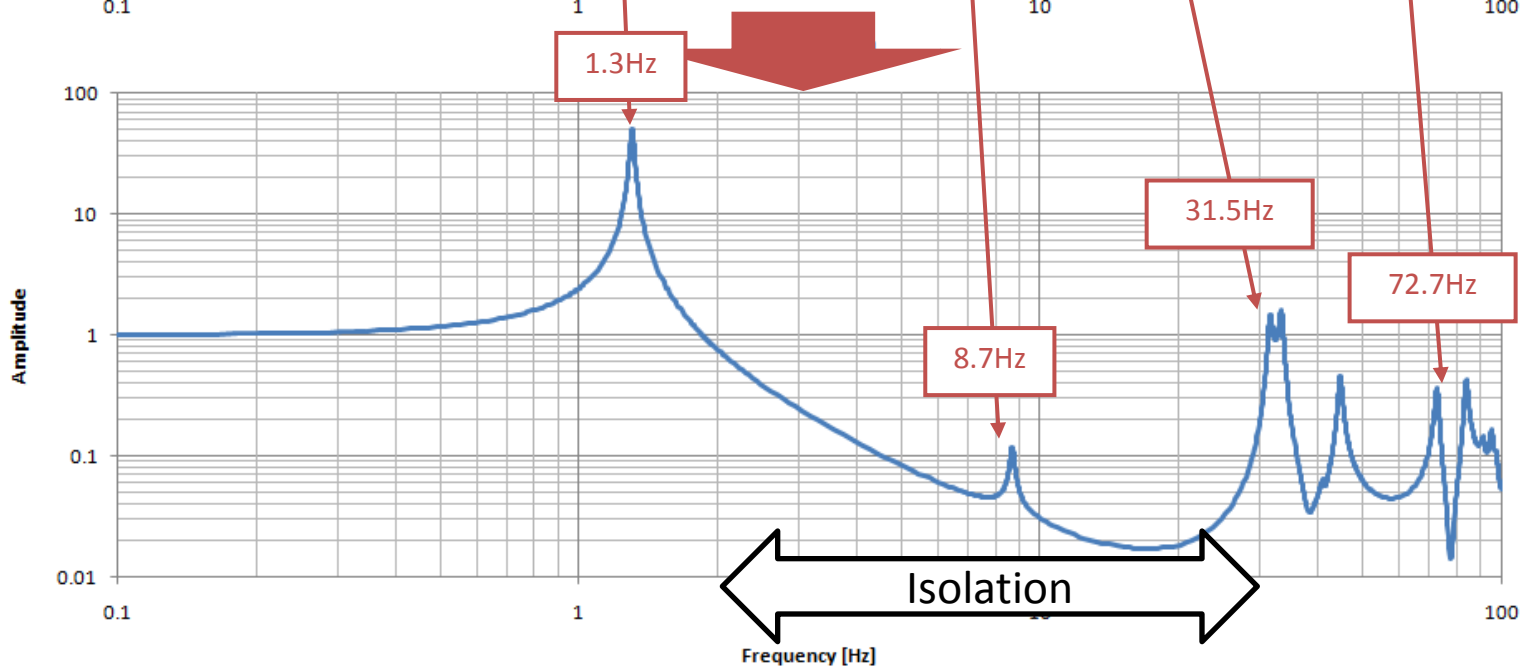



Pre-Isolator: Status



Results of measurements with the new, improved design of the test set-up have been communicated. Analysis is in progress.

Next steps: to be discussed.

In parallel, contacts with industry are on-going to check different solutions for a “final” version of the pre-isolator

conical section of vacuum pipe
now of 4 mm steel
to provide “mask”
(conceptual design!)

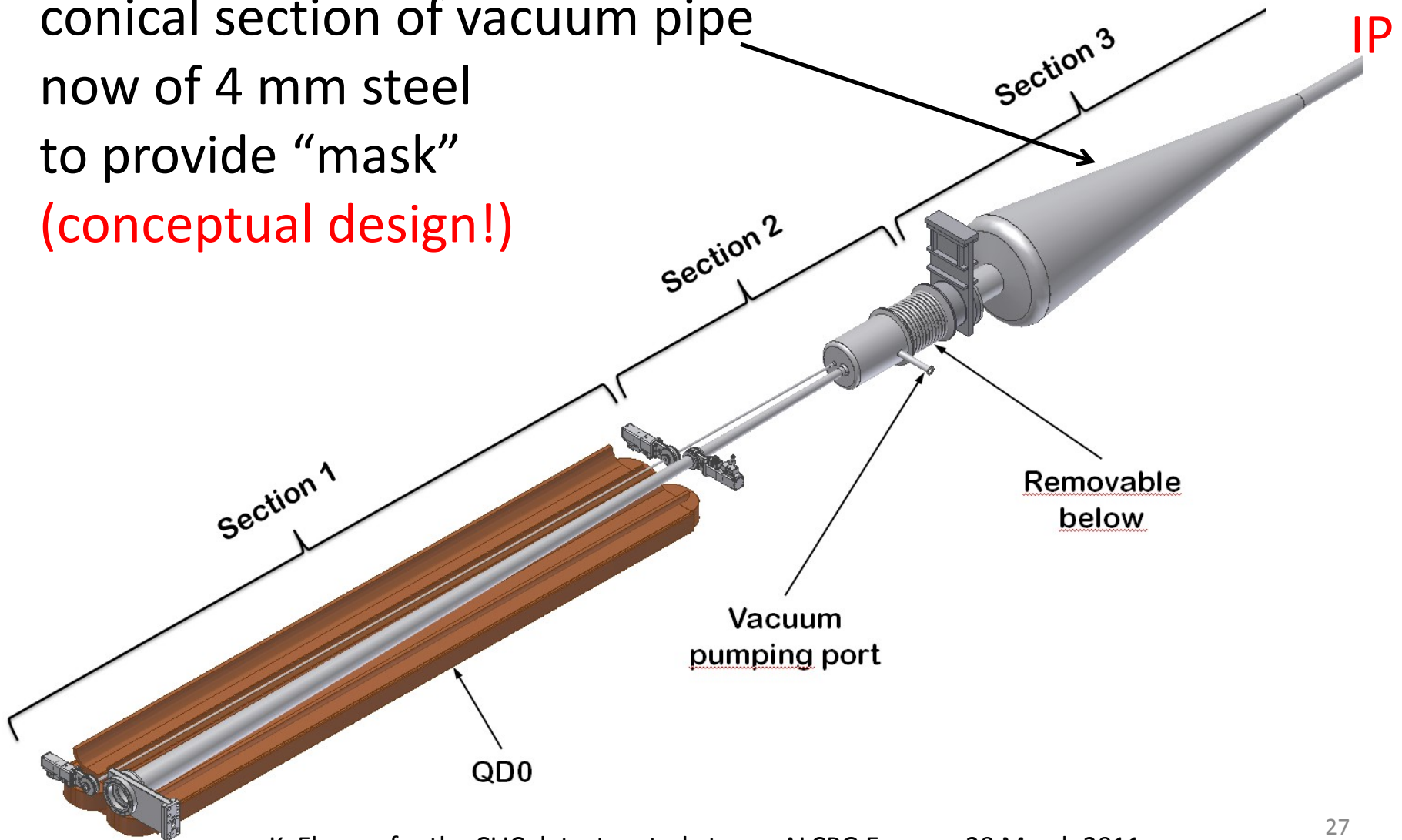

Vertex detector
hits from
incoherent pairs
(CLIC_ILD_CDR)

“now” :
direct hits
are dominant

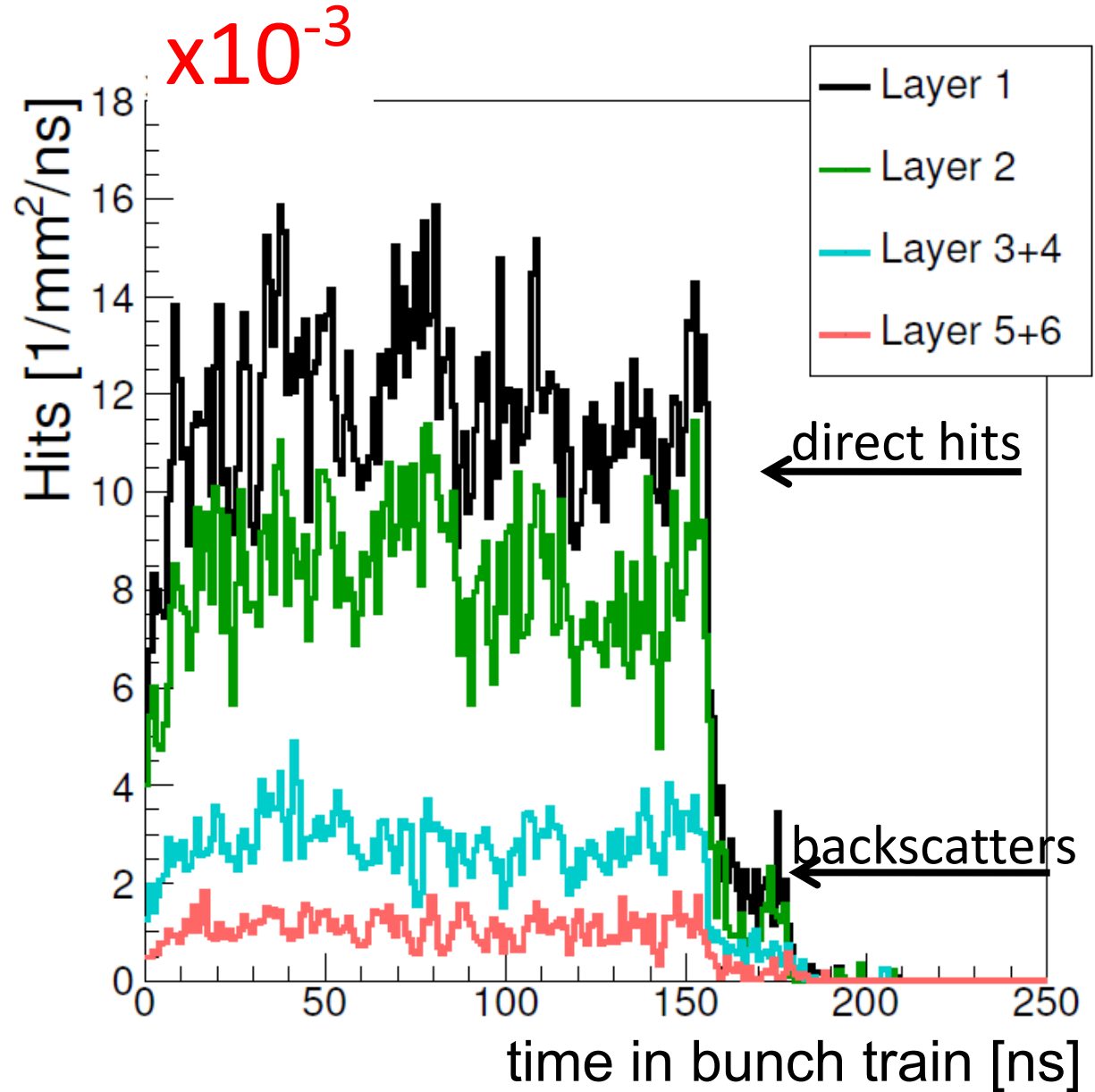



Summary



Progress is being made on a number of forward region and MDI issues around the CLIC detectors. Examples given here.

(see also Dominik Dannheim, Tuesday at 11:10

“Beam-induced backgrounds in the CLIC detector models”)

The corresponding chapters for the CLIC accelerator CDR (Vol. 1) are completed in first draft form – waiting for comments from the editors.

Chapters for the Physics and Detectors CDR (Vol. 2) exist in early draft forms – on “very forward region”, “magnet systems”, “interaction region and detector layout” - and are due to be ready end of April.

Thanks to all for helping to prepare this talk !



SPARES

MDI Region – FLUKA Representation

- Representation of MDI Region & Detector used in FLUKA simulations

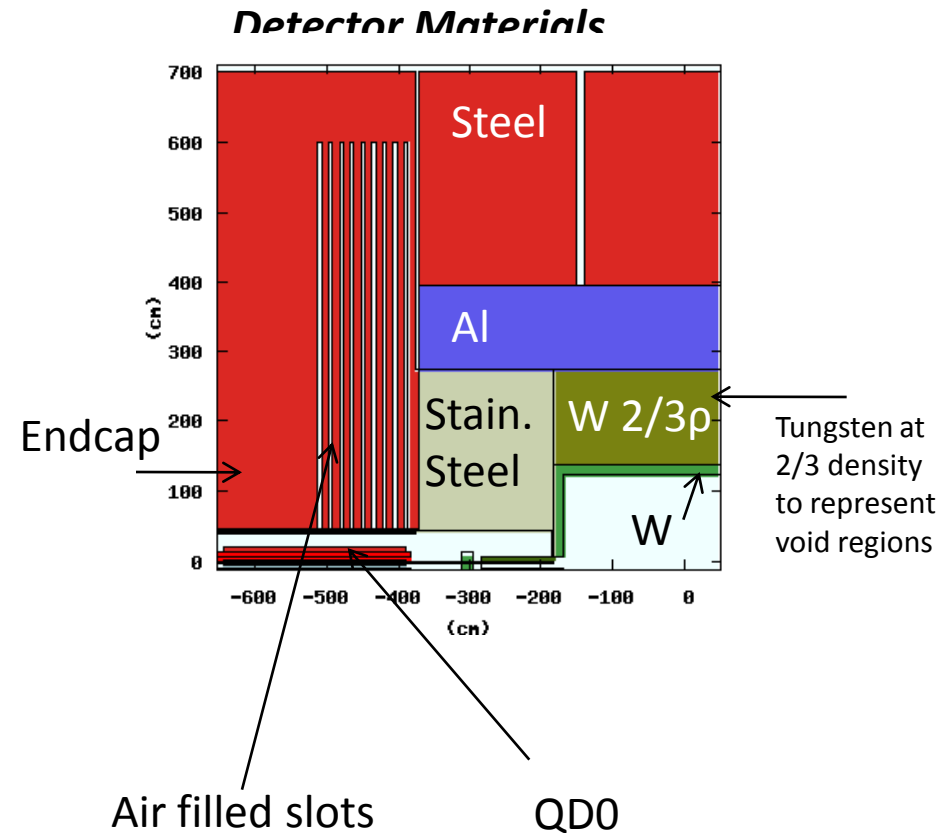
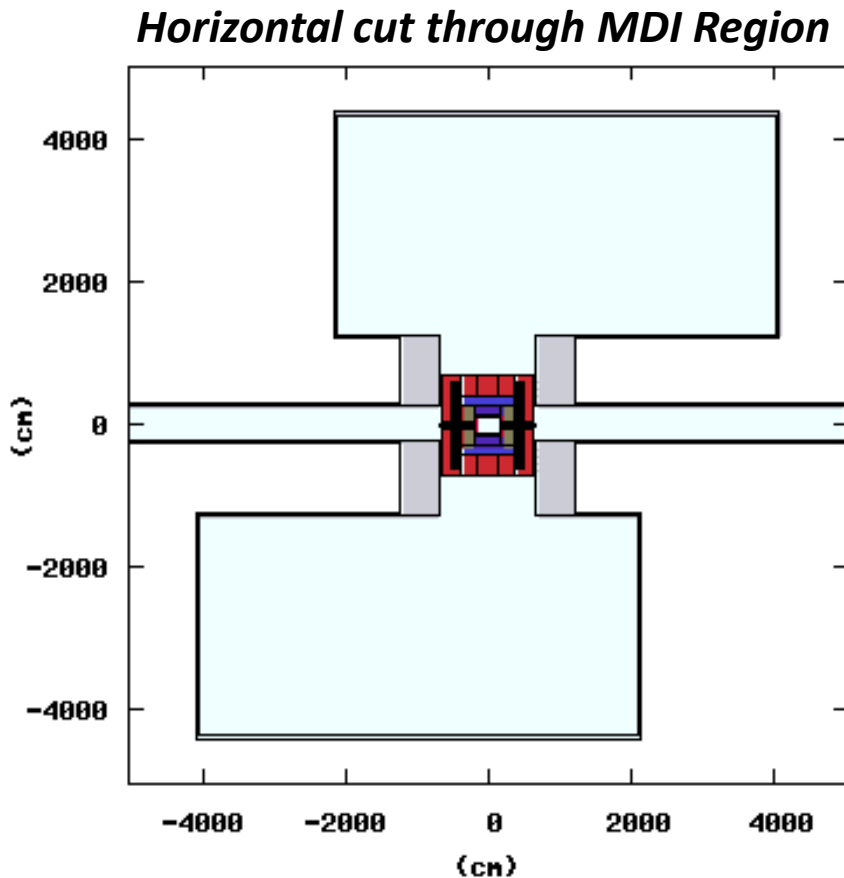

MDI Region – FLUKA Representation

- First Simulations: Beam Loss on QDO, with & without shielding.

Vertical cut through Detector

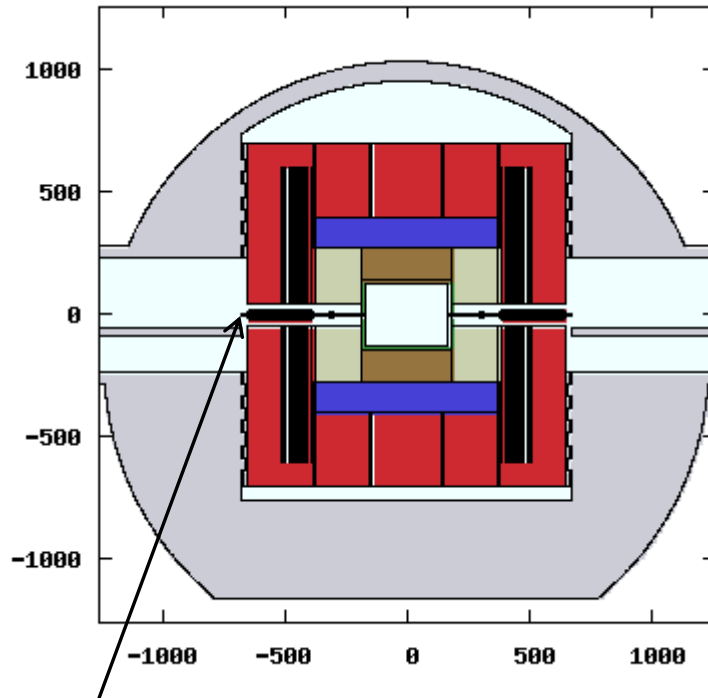

Beam Loss represented at 'edge' of QP

Shielding Rings

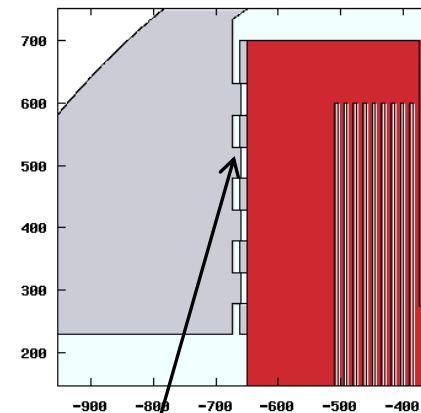

Possible shielding Design.
Rings (concrete?) attached to detector endcap -
Contractible for maneuver of detector from side caverns to interaction region. Rings overlap by 2 cm.

20 March 2011

Representation of Solenoid Field

Simple representation of solenoid field included in simulations

