

Uso de datos públicos del CERN en el aula

Una invitación y una microguía

y también física experimental de partículas en el aula

CosmicWatch, Taller MiniPIX

Motivación:

Imaginemos que vais a una clase de pintura y os encontráis esto:

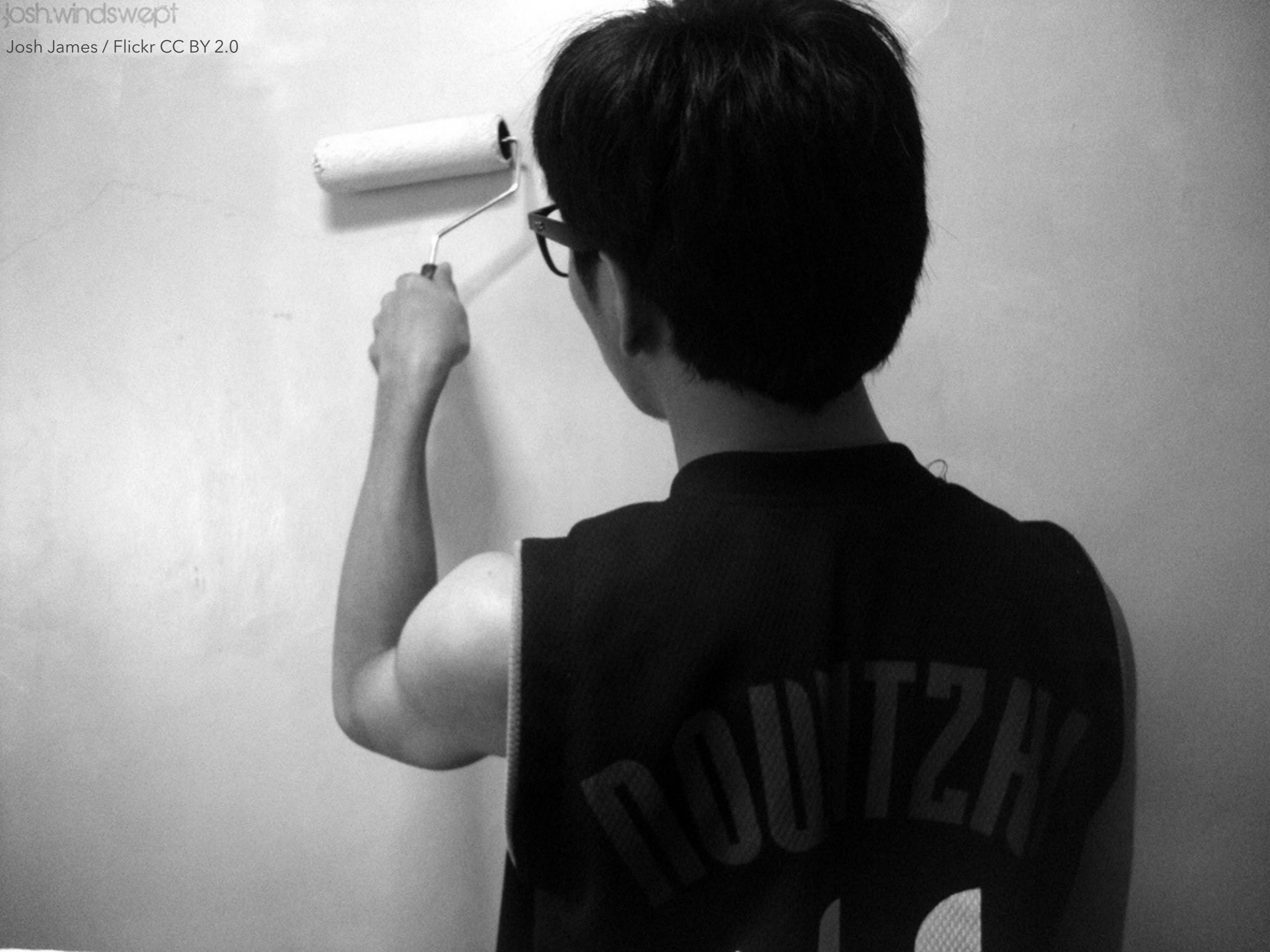

o que en clase de
matemáticas
no hay nada más que cosas
como esta:

$$\sqrt{6.42.53}$$

$$\underline{-4}$$

$$242$$

$$\underline{-225}$$

$$01753$$

$$\underline{-1509}$$

$$0244$$

$$253$$

$$2 \times 2 = 4$$

$$45 \times 5 = 225$$

$$503 \times 3 = 1509$$

o en física...

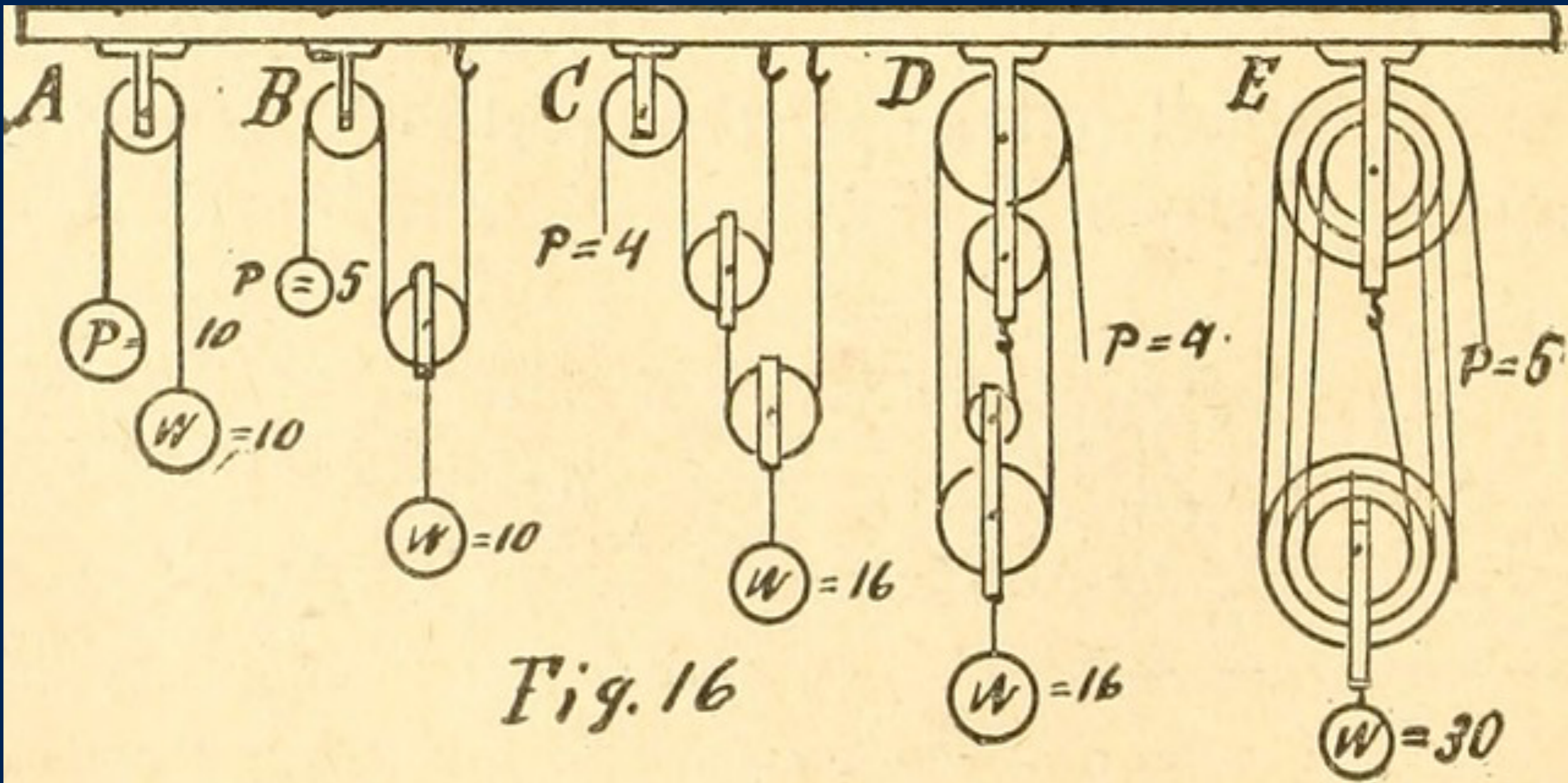

Image from page
45 of "Elementary
lessons in the
physics of
agriculture" (1894)

Hay alternativas...





ALIVE

Sessions

PREP BY
JOHN MARE
JUST BAE
CRAG
FBI
YKI
ORIGINAL RECORDING
MEMPHIS CITY

Diana González Yuste
The October Press, Alicante





Begoña V.

Flickr CC BY-NC-SA 2.0

Motivación



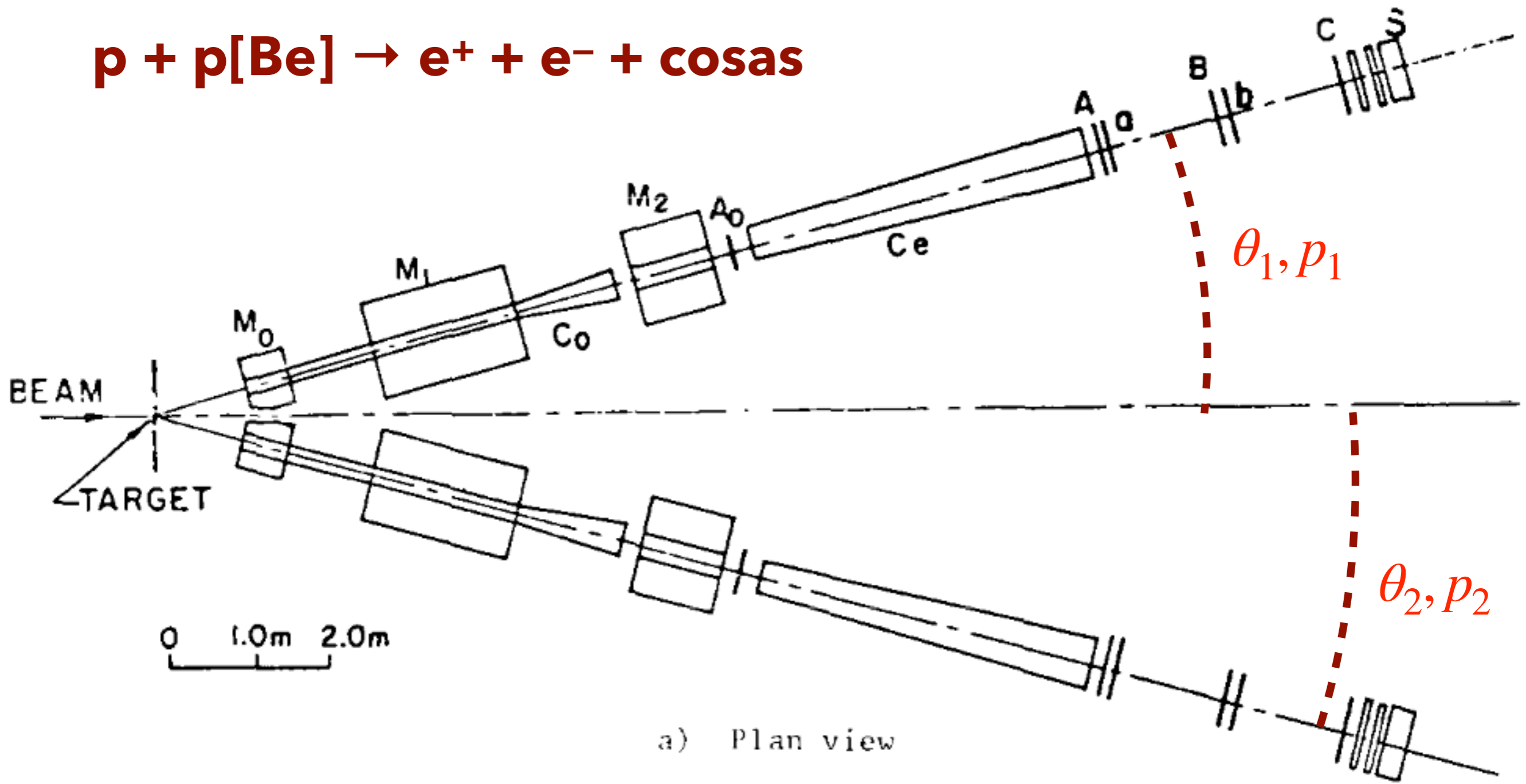

<https://www.nobelprize.org/uploads/2018/06/ting-lecture.pdf>

Si resulta que $p + p \rightarrow X \rightarrow e^+ + e^-$ la masa m de X será:

$$m^2 = m_1^2 + m_2^2 + 2[E_1 E_2 - p_1 p_2 \cos(\theta_1 + \theta_2)]$$

Experimental Observation of a Heavy Particle J^\dagger

J. J. Aubert, U. Becker, P. J. Biggs, J. Burger, M. Chen, G. Everhart, P. Goldhagen, J. Leong, T. McCorrison, T. G. Rhoades, M. Rohde, Samuel C. C. Ting, and Sau Lan Wu
*Laboratory for Nuclear Science and Department of Physics, Massachusetts Institute of Technology,
Cambridge, Massachusetts 02139*

and

Y. Y. Lee

Brookhaven National Laboratory, Upton, New York 11973

(Received 12 November 1974)

We report the observation of a heavy particle J , with mass $m = 3.1$ GeV and width approximately zero. The observation was made from the reaction $p + \text{Be} \rightarrow e^+ + e^- + x$ by measuring the e^+e^- mass spectrum with a precise pair spectrometer at the Brookhaven National Laboratory's 30-GeV alternating-gradient synchrotron.

This experiment is part of a large program to study the behavior of timelike photons in $p + p \rightarrow e^+ + e^- + x$ reactions¹ and to search for new particles which decay into e^+e^- and $\mu^+\mu^-$ pairs.

daily with a thin Al foil. The beam spot size is 3×6 mm², and is monitored with closed-circuit television. Figure 1(a) shows the simplified side view of one arm of the spectrometer. The two

J. J. Aubert, U. Becker, P. J. Biggs, J. Burger, M. Chen, G. Everhart, P. Goldhagen, J. Leong, T. McCorrison, T. G. Rhoades, M. Rohde, Samuel C. C. Ting, Sau Lan Wu, and Y. Y. Lee

Phys. Rev. Lett. 33, 1404 – Published 2 December 1974

We report the observation of a heavy particle J , with mass $m = 3.1$ GeV and width approximately zero. The observation was made from the reaction $p + Be \rightarrow e^+ + e^- + x$ by measuring the e^+e^- mass spectrum with a precise pair spectrometer at the Brookhaven National Laboratory's 30-GeV alternating-gradient synchrotron.

Received 12 November 1974

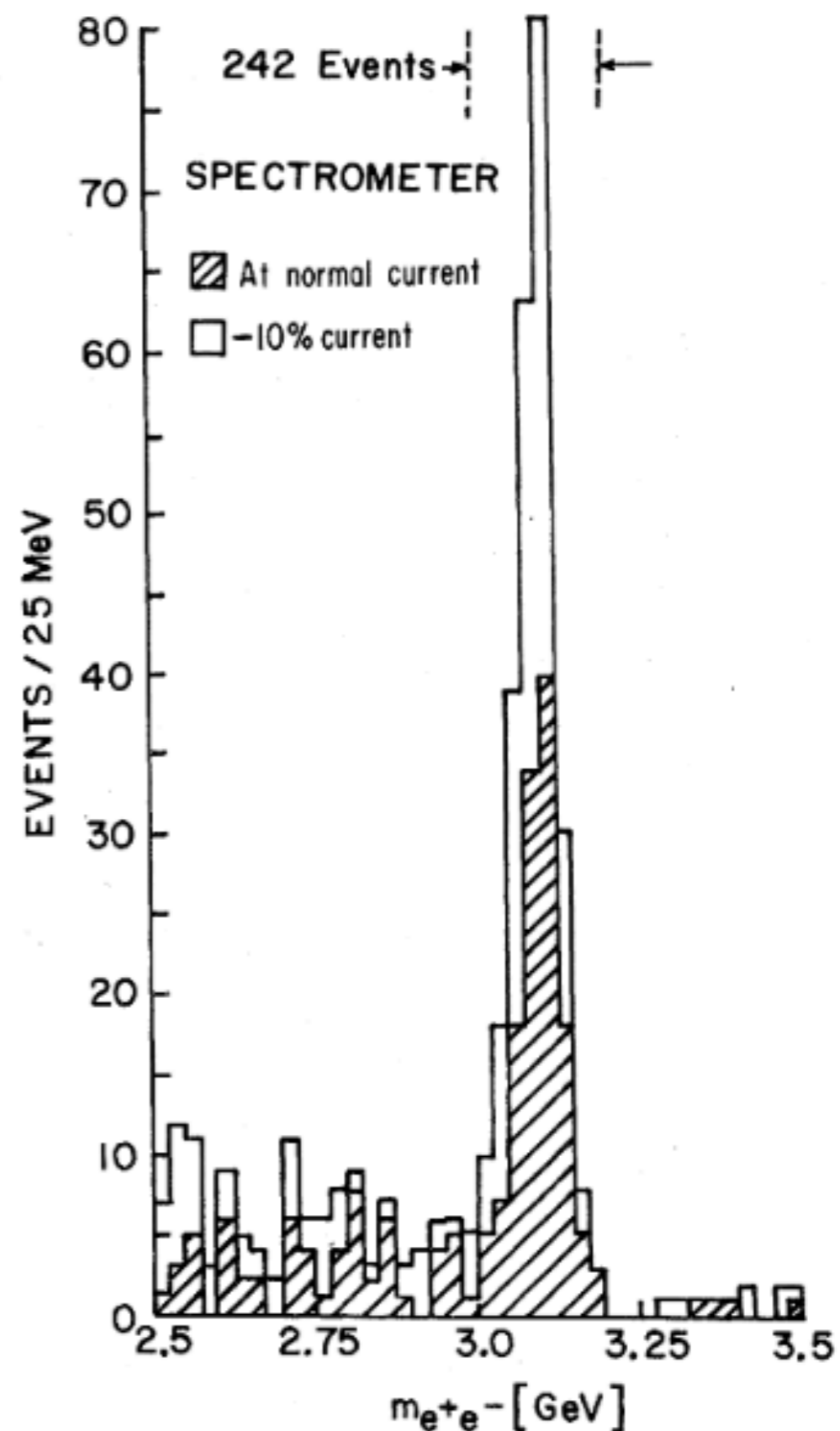

FIG. 2. Mass spectrum showing the existence of J . Results from two spectrometer settings are plotted showing that the peak is independent of spectrometer currents. The run at reduced current was taken two months later than the normal run.

Discovery of a Narrow Resonance in e^+e^- Annihilation

J. -E. Augustin *et al.*

Phys. Rev. Lett. 33, 1406 – Published 2 December 1974

Physics See Focus story: [Landmarks—The Charming Debut of a New Quark](#)

An article within the collection: [Letters from the Past - A PRL Retrospective](#)

La revolución de noviembre en la física de partículas

With the discovery of the J/Psi particle, we realized that many diverse strands of research were converging on a single theory of physics.

El modelo estándar

S. Glashow:

In 1969, John Iliopoulos and Luciano Maiani came to Harvard as research fellows. Together, we found the arguments that predicted the existence of charmed hadrons. Much of my later work was done in collaboration with Alvaro de Rujúla or Howard Georgi.

In early 1974, we predicted that charm would be discovered in neutrino physics or in $e^+ e^-$ annihilation. So it was.

With the discovery of the J/Psi particle, we realized that **many diverse strands of research were converging on a single theory of physics.**

<https://www.nobelprize.org/prizes/physics/1979/ghashow/biographical/>

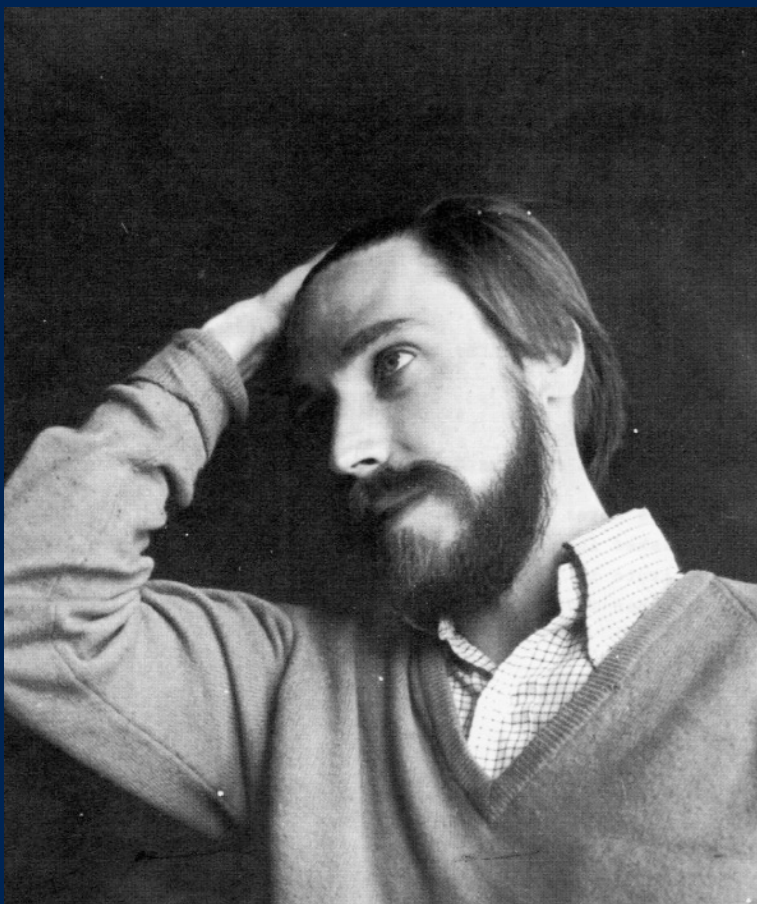

Álvaro de Rújula
AIP Emilio Segrè
Visual Archives



Sheldon Glashow
courtesy AIP Emilio Segrè
Visual Archives

Is Bound Charm Found?*

A. De Rújula

Lyman Laboratory of Physics, Harvard University, Cambridge, Massachusetts 02138

and

S. L. Glashow†

Center for Theoretical Physics, Massachusetts Institute of Technology, Cambridge, Massachusetts 02139

(Received 27 November 1974)

We argue that the newly discovered narrow resonance at 3.1 GeV is a 3S_1 bound state of charmed quarks and we show the consistency of this interpretation with known meson systematics. The crucial test of this notion is the existence of charmed hadrons near 2 GeV.

A surprisingly narrow resonance at $M = 3.1$ GeV was discovered in $p + \text{Be} \rightarrow e^+ + e^- + \dots$ ¹ and in e^+e^- annihilation.² Estimates³ of its decay

variant. It contributes to the singlet mass. We suggest that the remaining term is just the sum of the quark masses plus a common additive con-

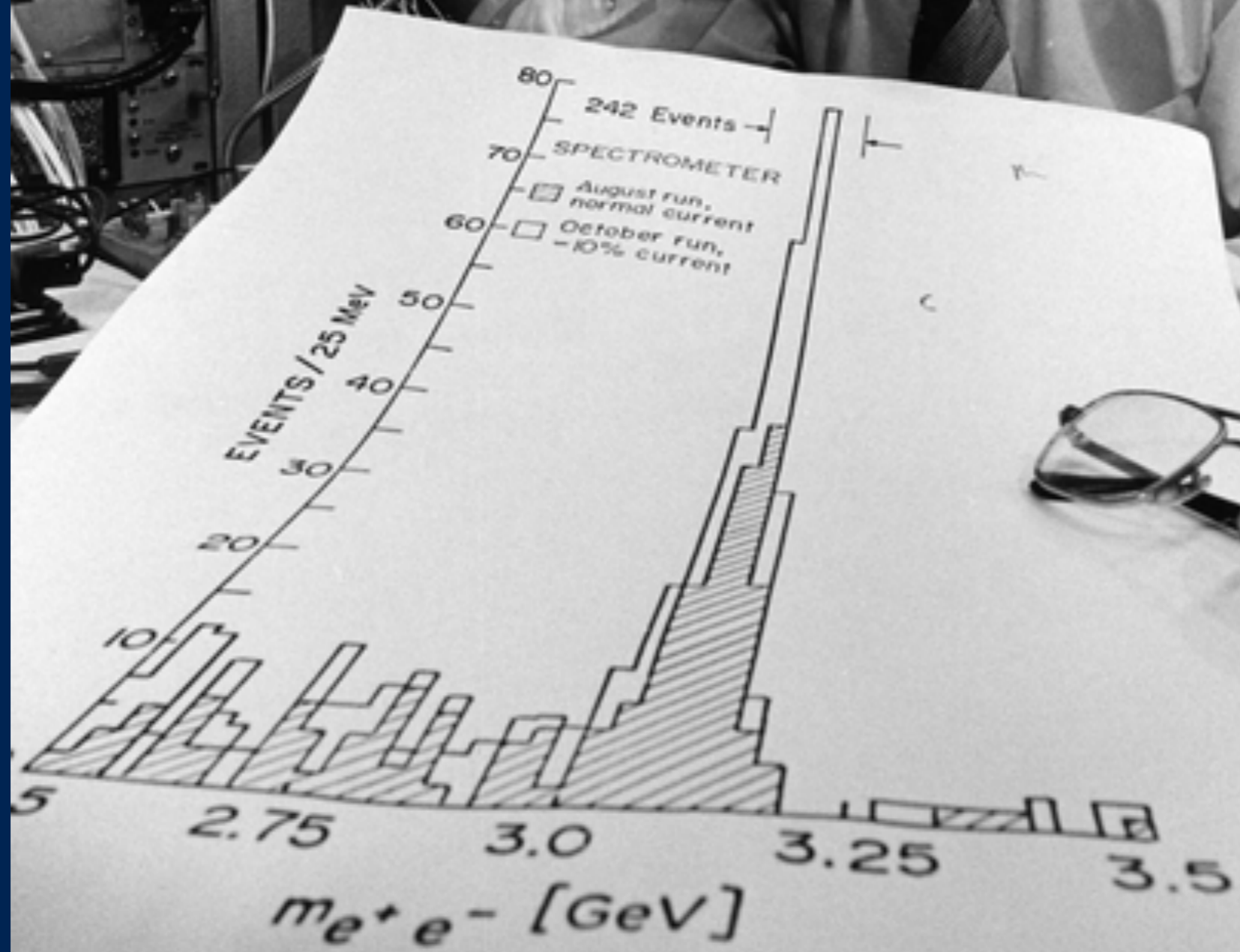
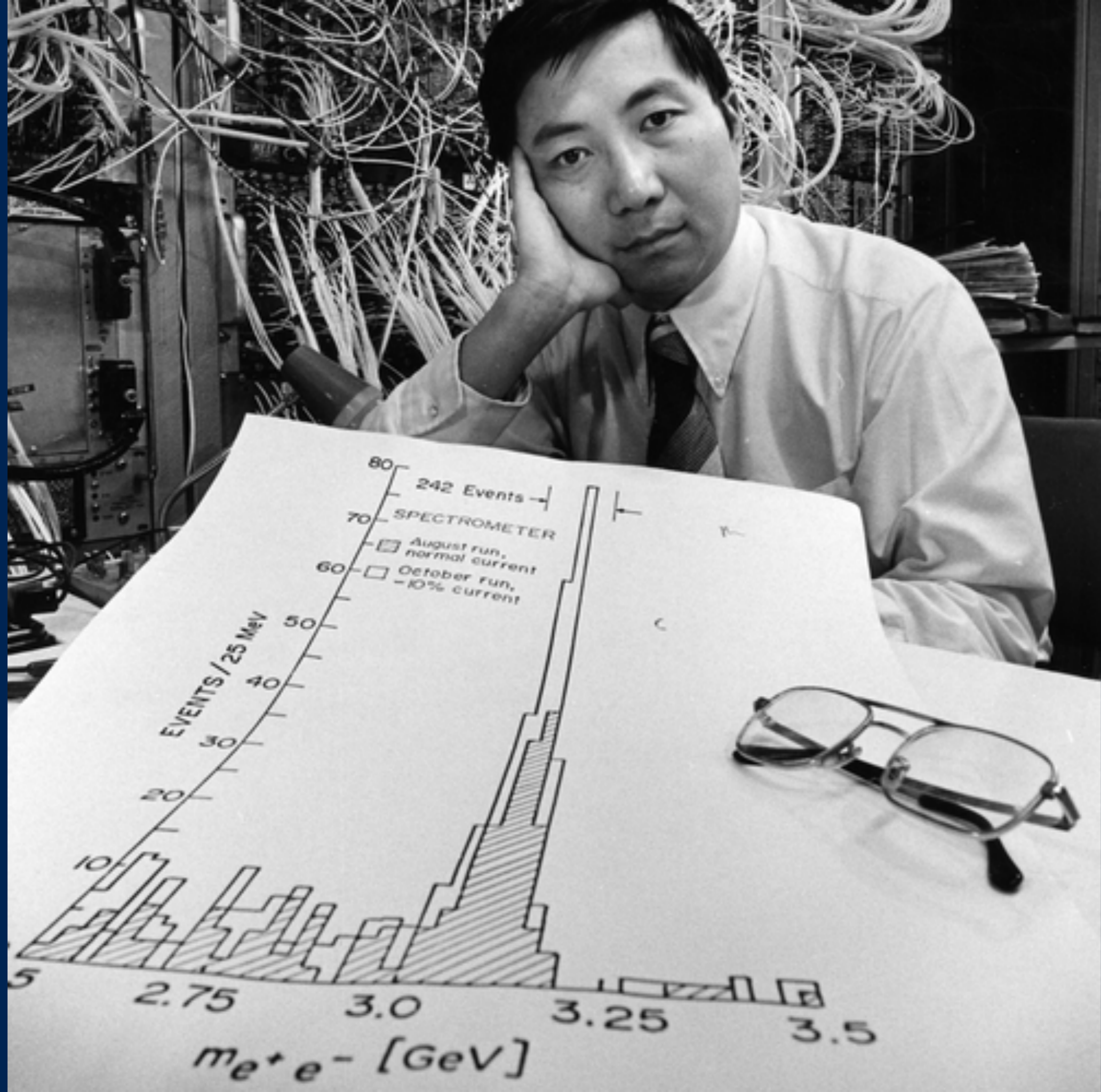

Objetivo

INSERT
YOUR FACE
HERE

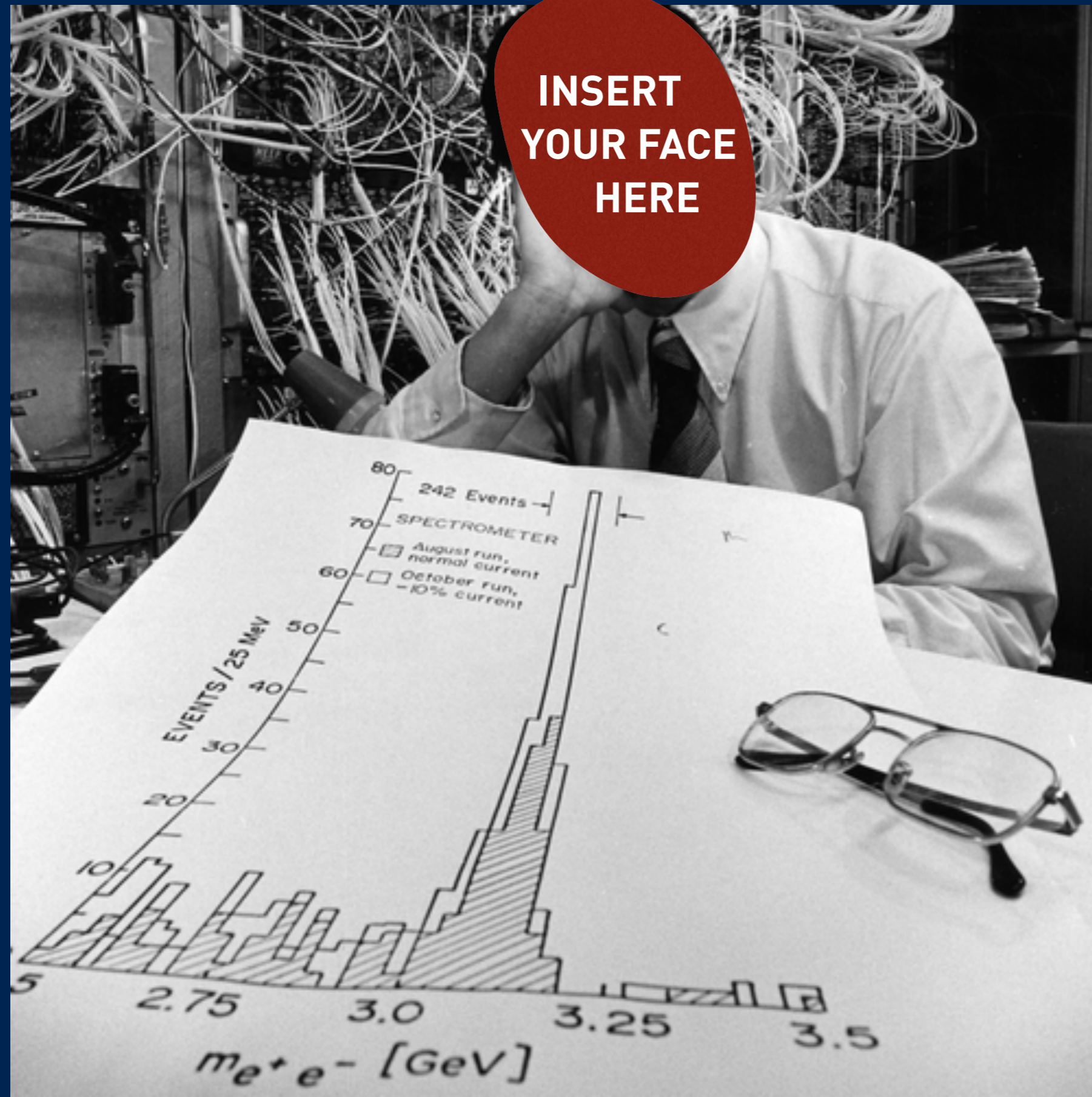

y también física experimental de partículas en el aula

CosmicWatch, Taller MiniPIX

Cosmic Watch

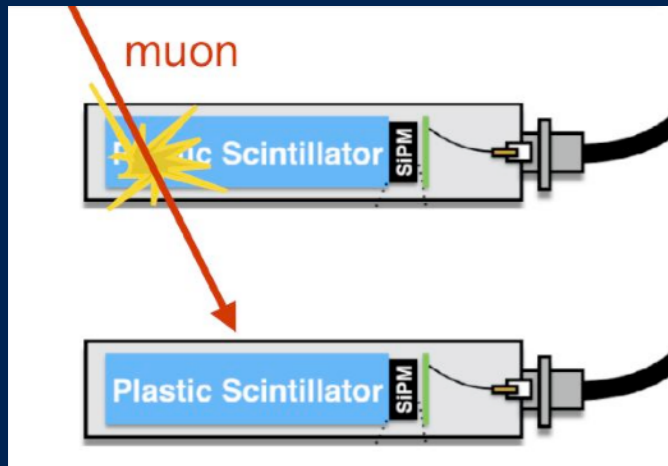

vuelo
MAD -> GVA

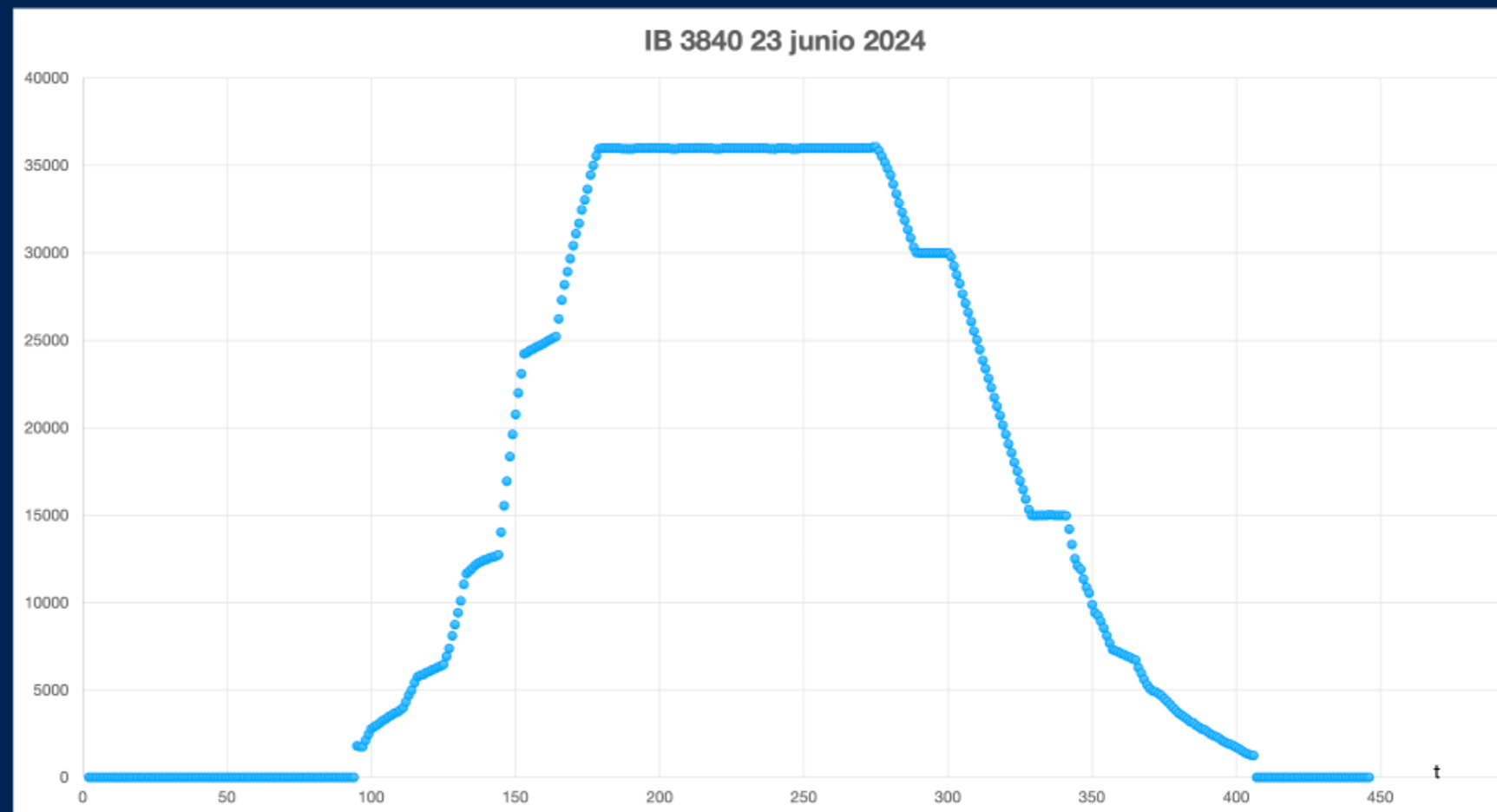
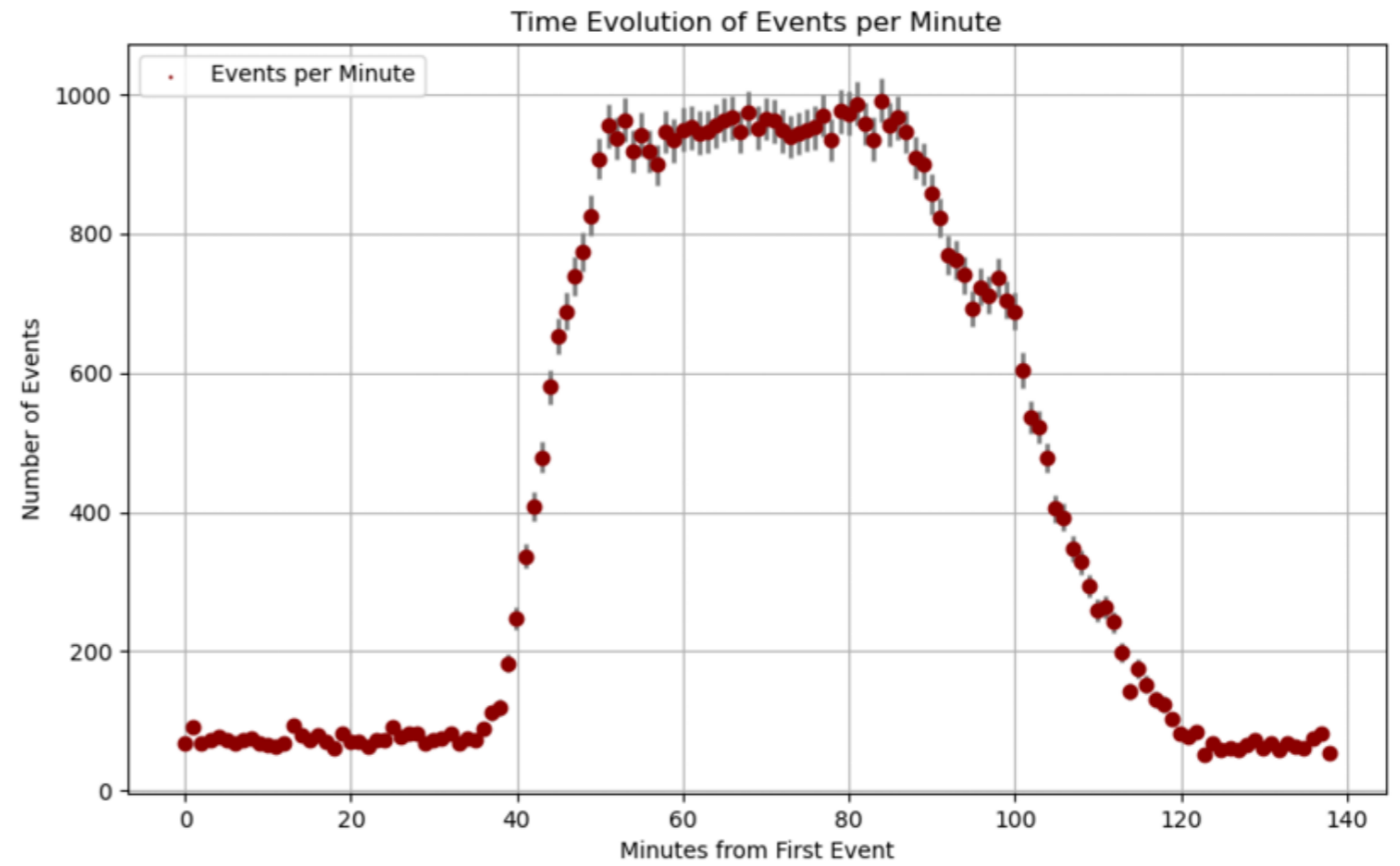

visita a la caverna de servicio de CMS

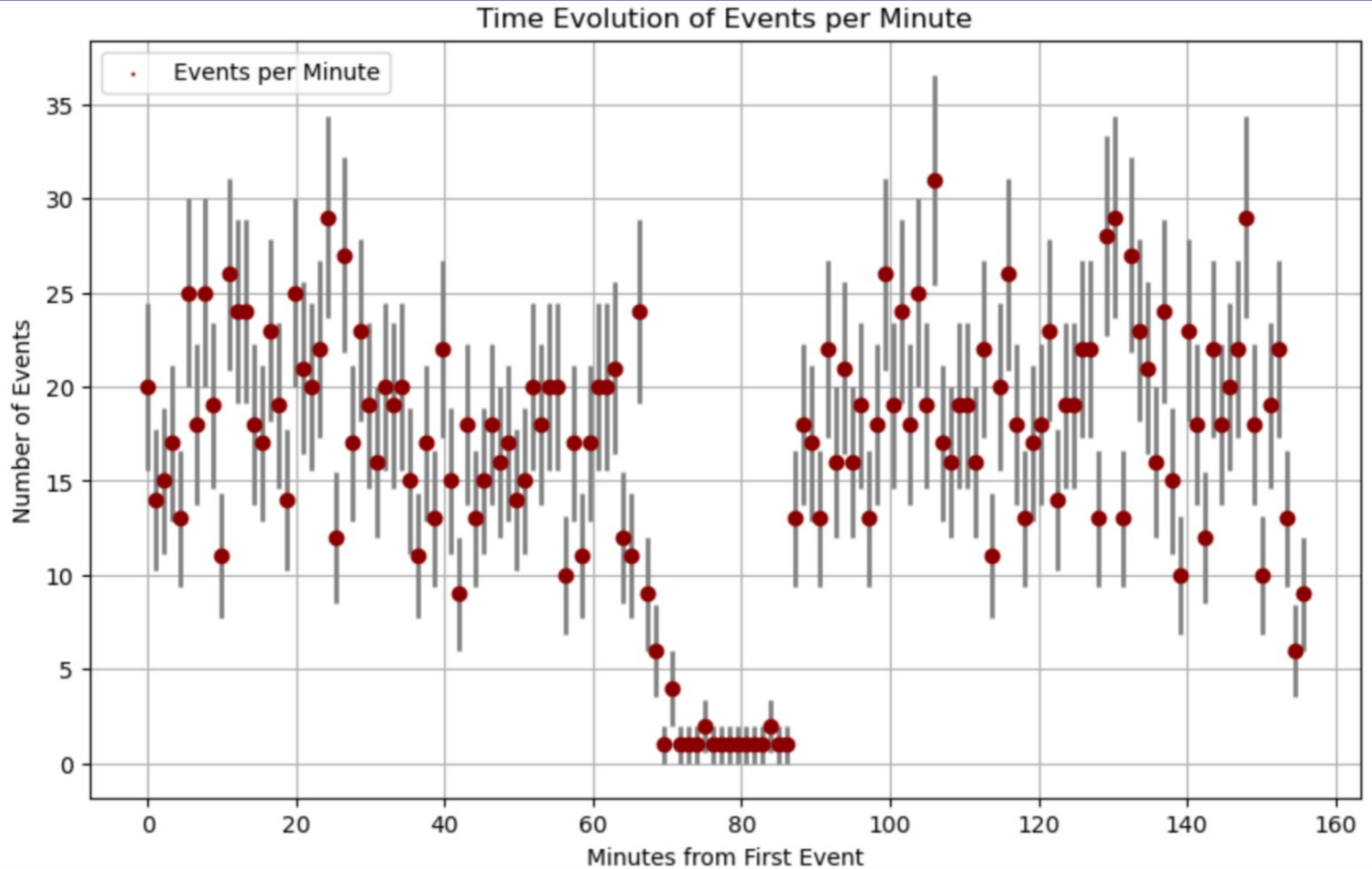

6 horas en el B39

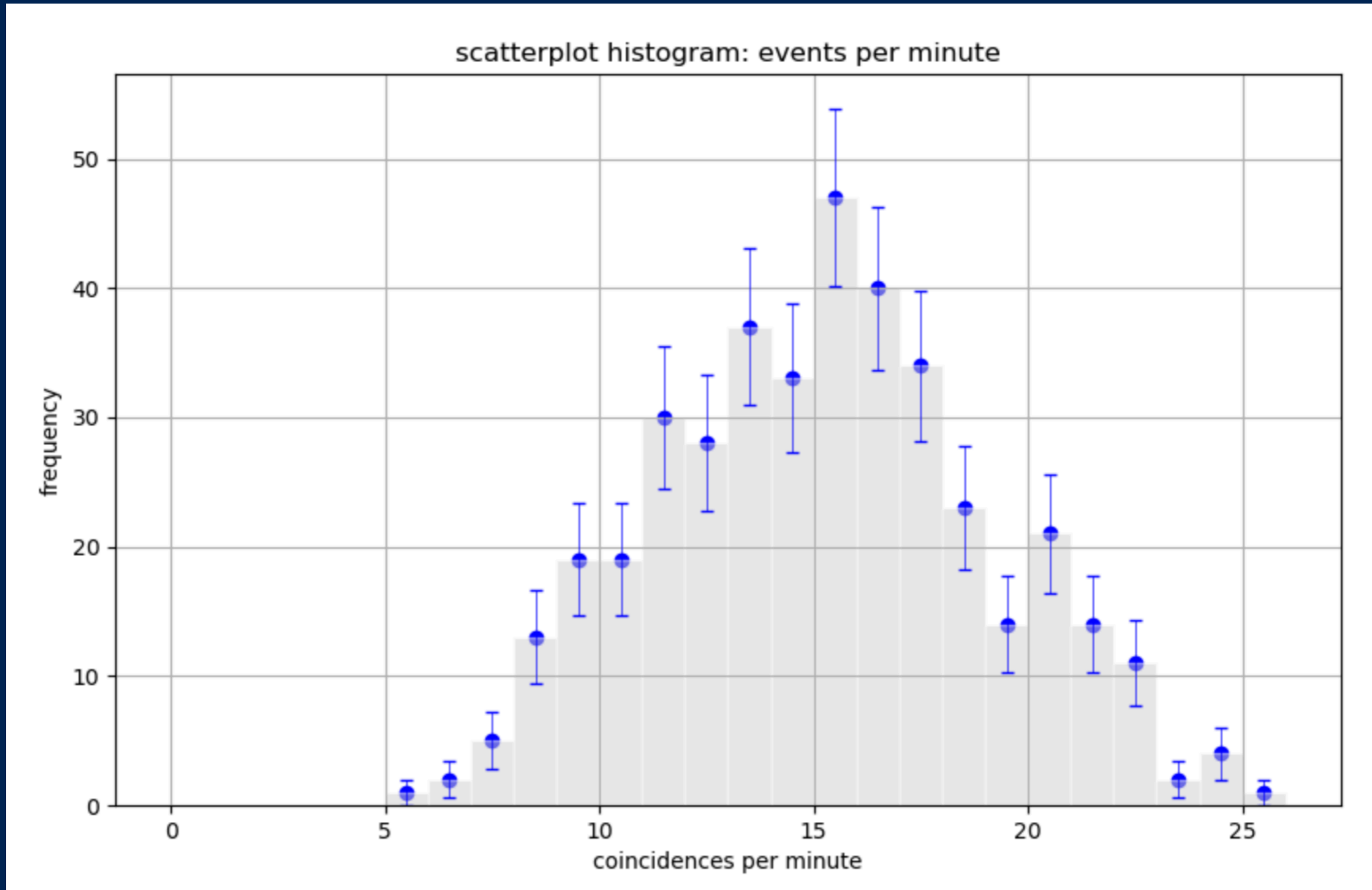

MiniPIX EDU

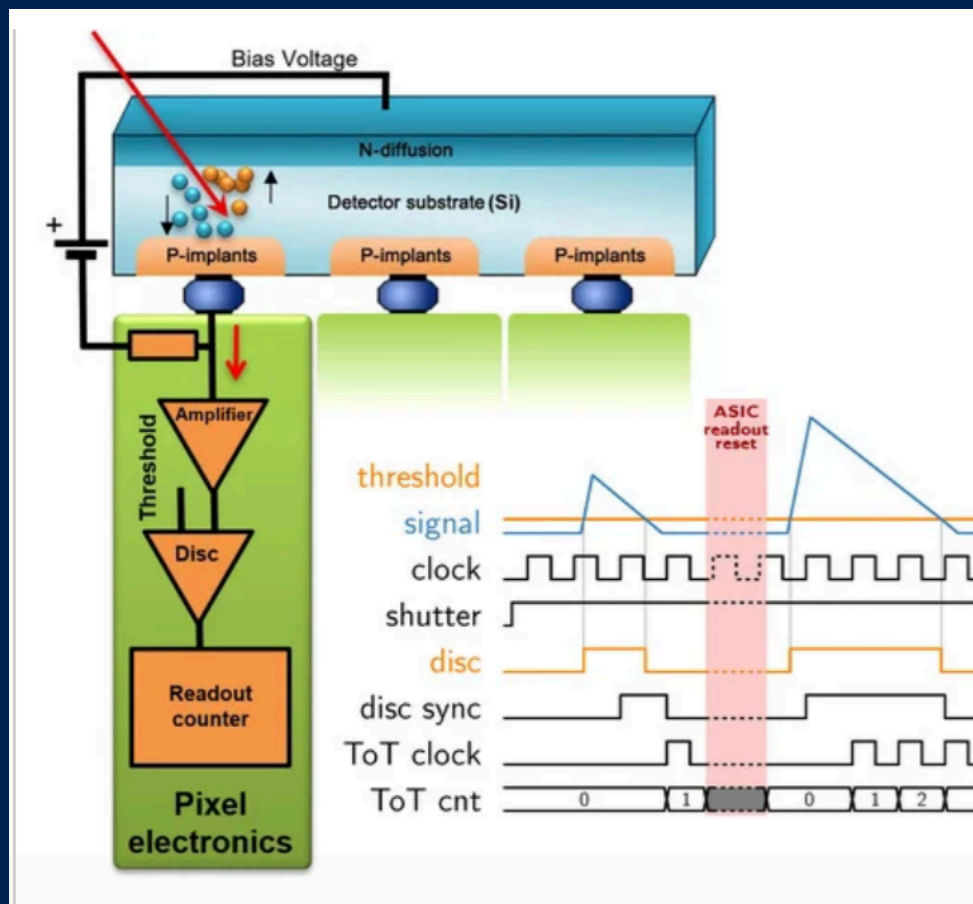
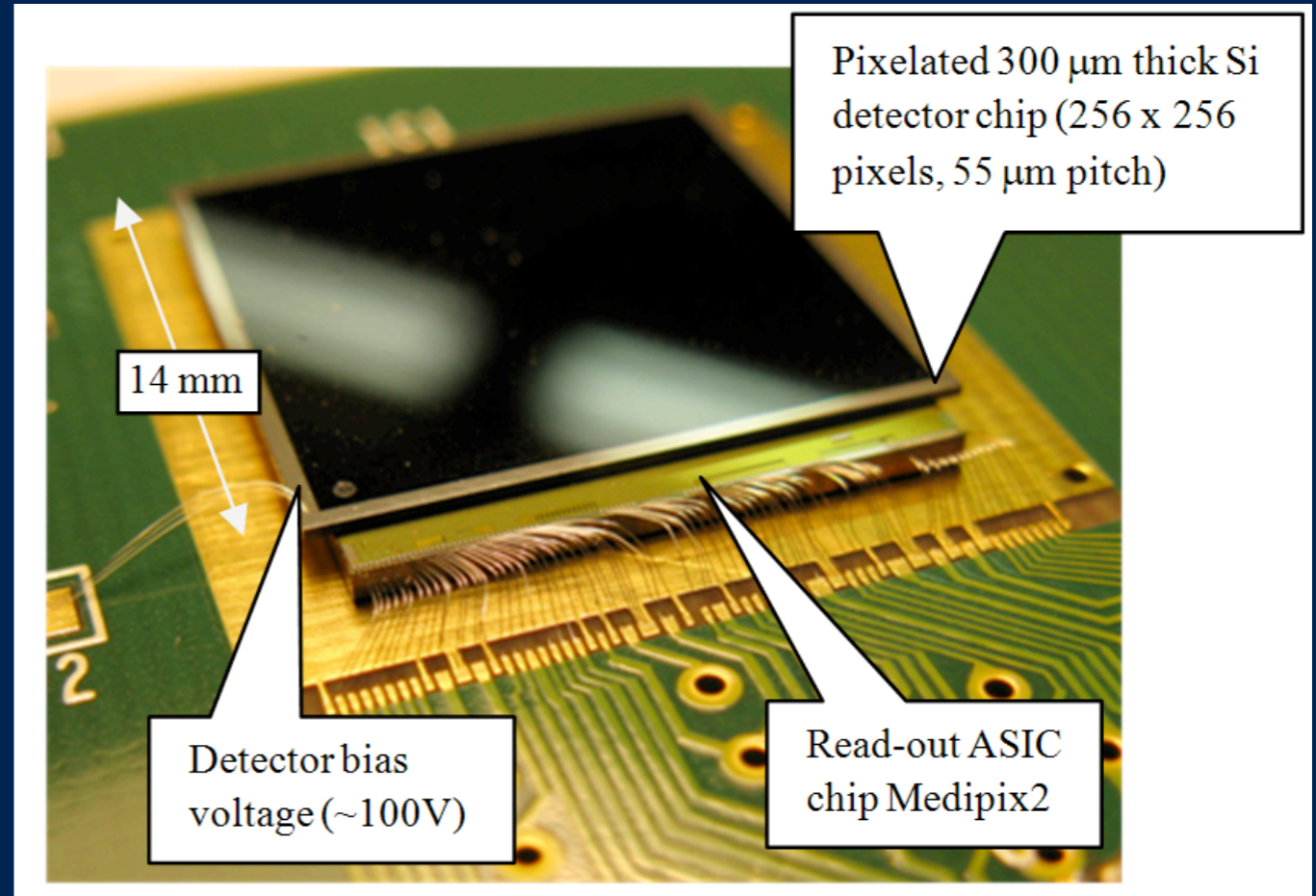



F11-W0349



PRO

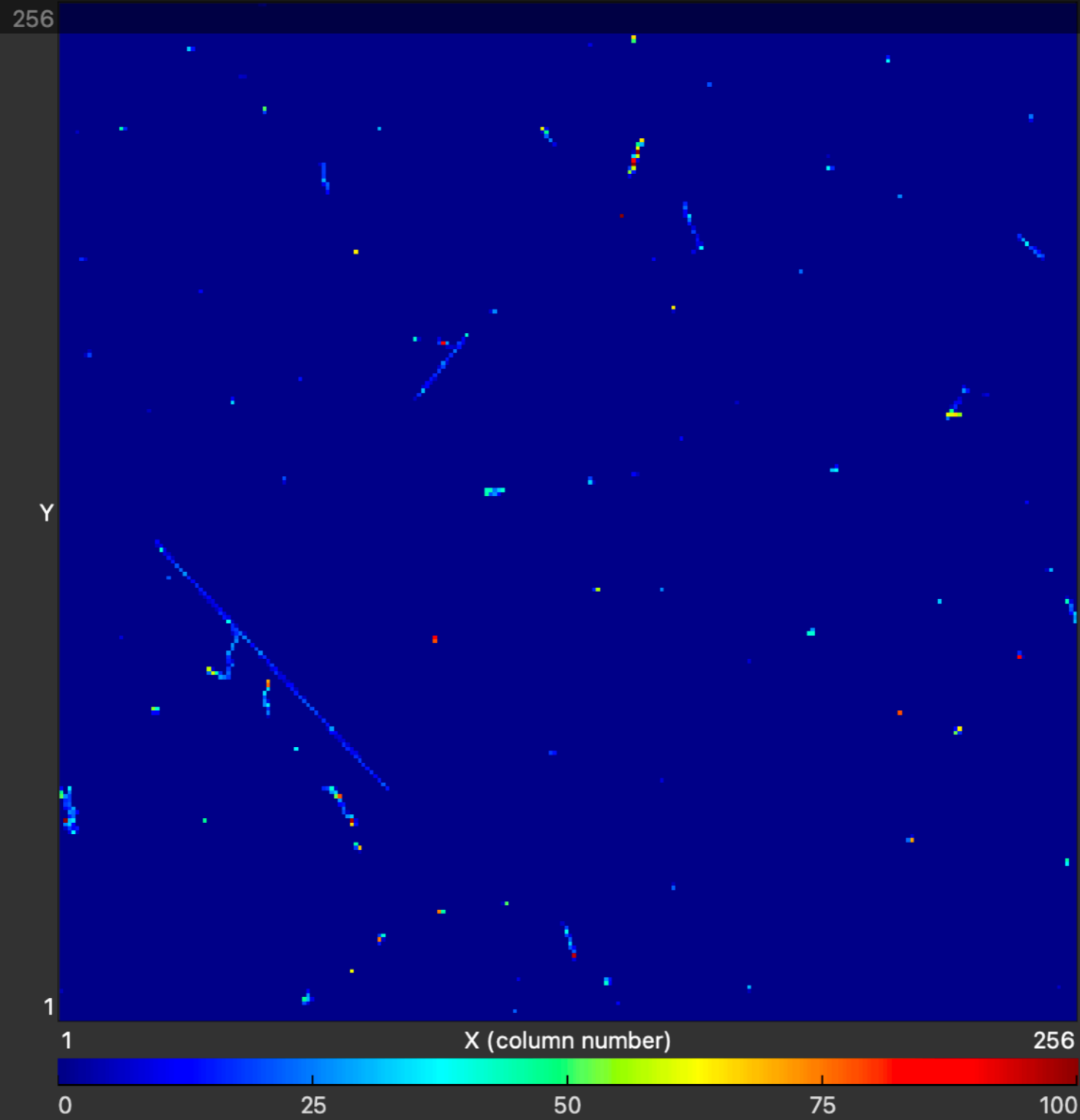

Image Properties

Min: 0 Max: 100

Slider control for image properties.

Measurement

Mode: Tracking Frames: 1800 Exposure [s]: 1

Sum

Image Info

[X,Y]:	[-,-]
Count:	0
Min:	0
Max:	130
Pixel Count:	446
Total:	10313
Mean:	0.157364

Info Tracks

Spectra

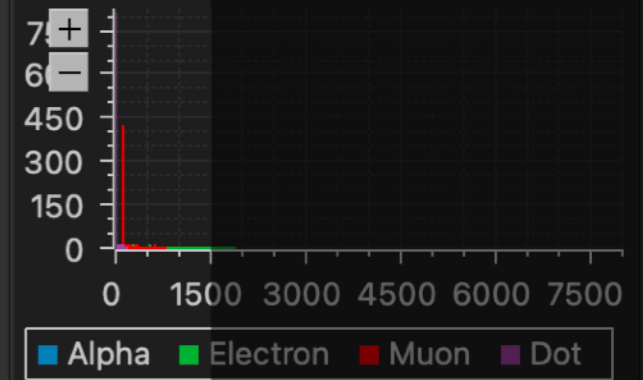

Energy [keV] Size [pix] Timeline

Frame: 414

1 Messages

T: 0:07:16.9 A: 413/1800

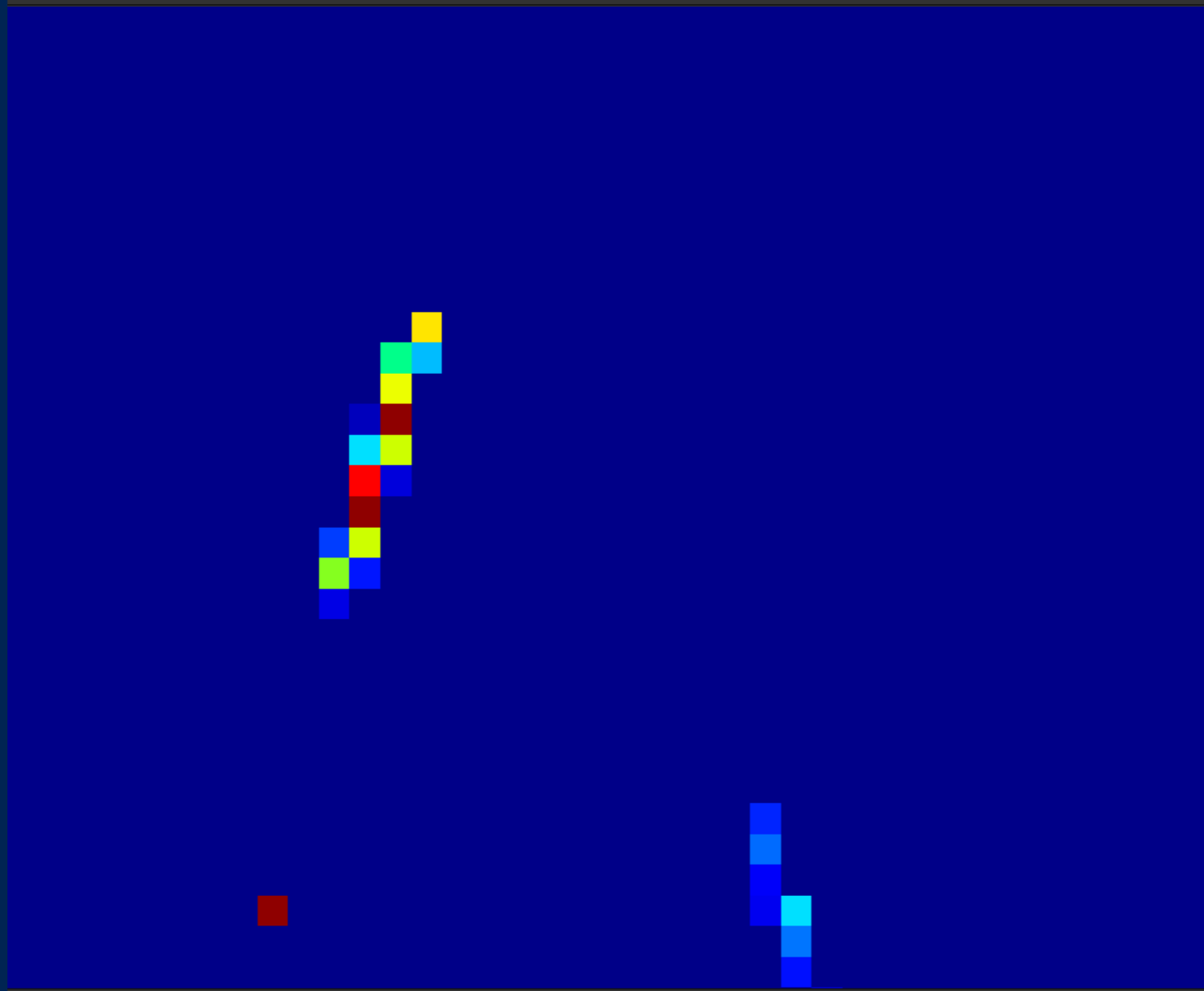

X (column number) 172



25 50 75 100

Frame: 356

Measurement

Mode: Tracking Frames: 1800 Exposure [s]: 1

Sum

Stop

Image

Image Info

[X,Y]: [-,-]
 Count: 0
 Min: 0
 Max: 130
 Pixel Count: 24
 Total: 1051
 Mean: 0.763808

Info Tracks

Spectra

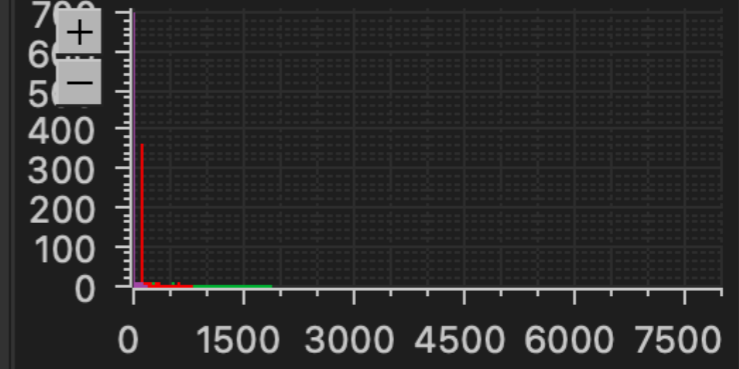

Alpha Electron Muon Dot

Energy [keV] Size [pix] Timeline