



Arthur B. McDonald
Canadian Astroparticle Physics Research Institute



Queen's
UNIVERSITY

The KDK+ Experiment: measurement of the β^+ branching ratio of potassium 40

Arnaud Lemaire* supervised by P. Di Stefano at Queen's University

With the contribution of:

Peter Skensved
Matthew Stukel
Lilianna Hariasz
Emma Ellingwood
Nicholas Swidinsky
Romain Arsenne
David Van Herpt

05/27/2024

***Supported by the McDonald Institute**

40K, one of the most common radioisotopes:

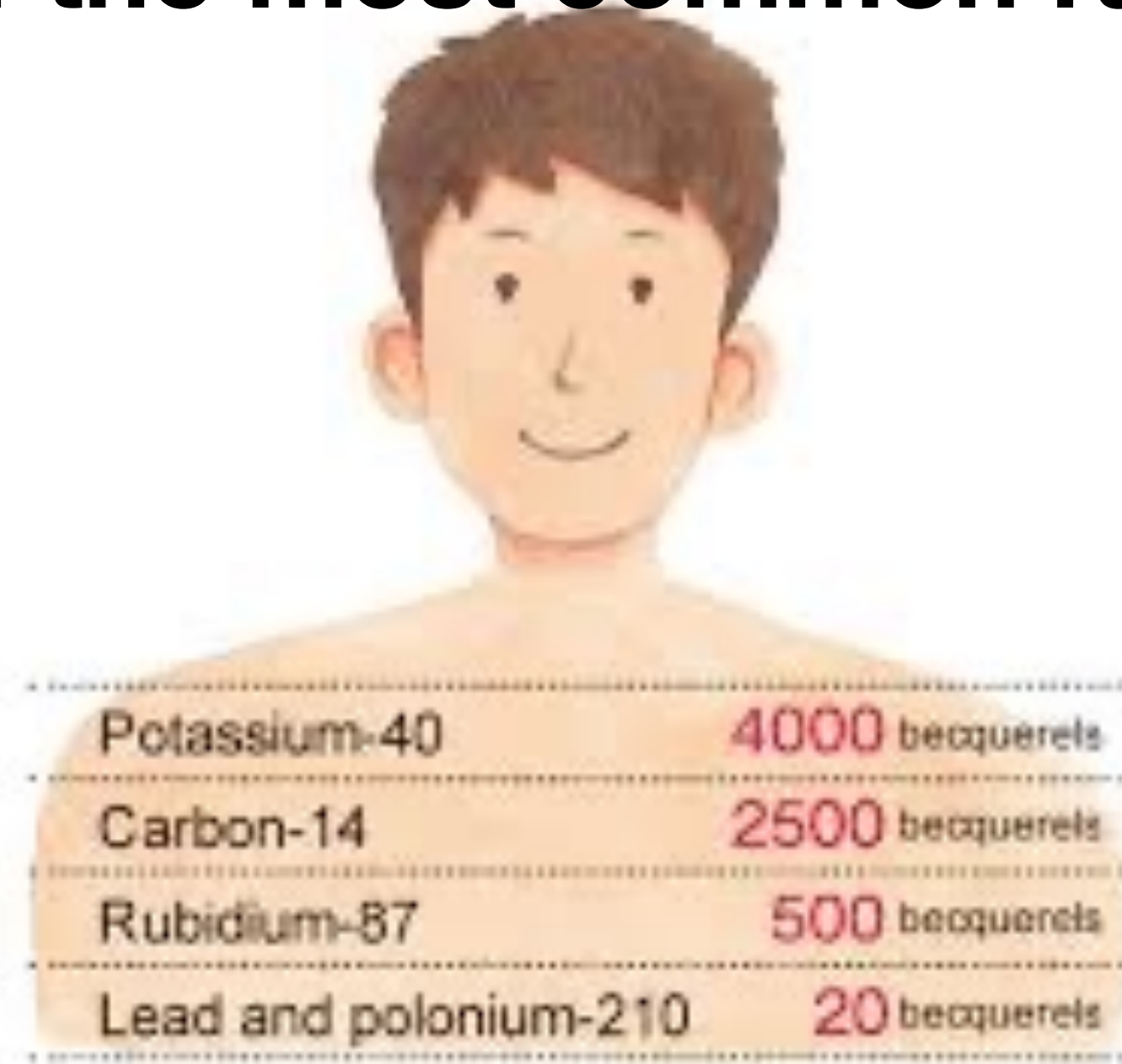

A typical 150-gram banana contains about half a gram of potassium, and has an activity of roughly 15 Bq (per 150 g of banana)



Total earth activity [10^{24} Bq]

40K	232Th	238U
30	11	11

Composition of Earth's crust

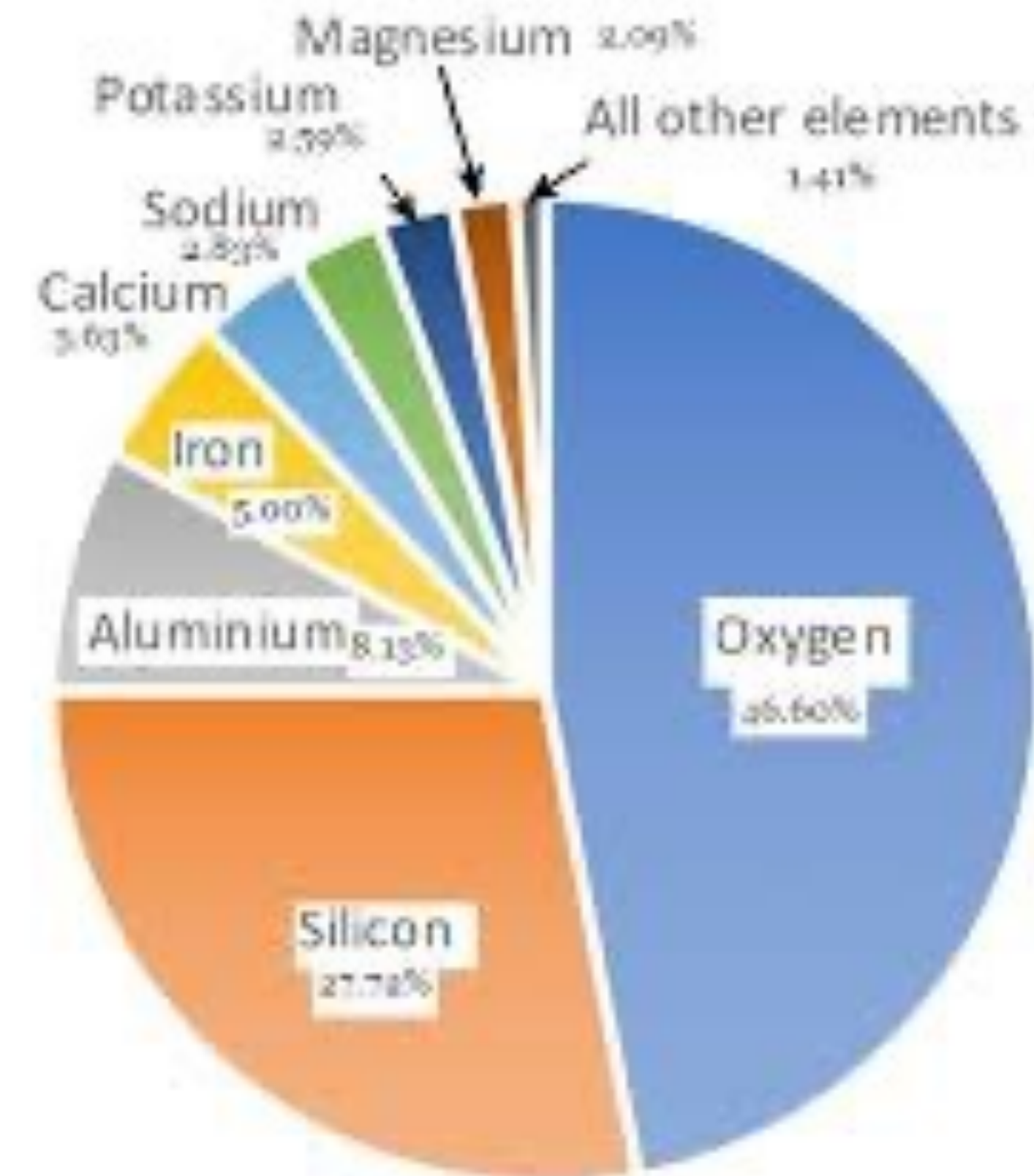

Decay scheme of ^{40}K : Re-measurement of β^+ branching ratio

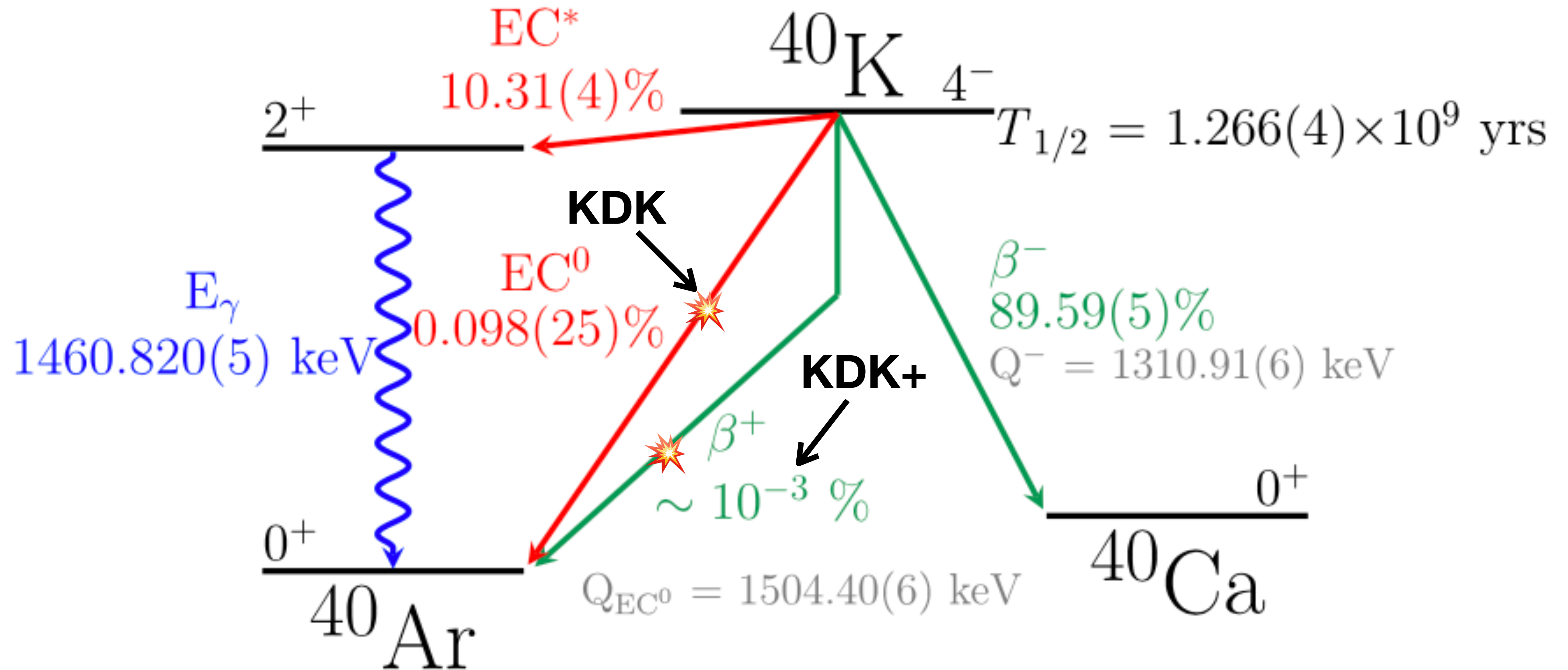

Motivation

Inconsistency

1. KDK expt 2023: $b_0/b^* = 0.0095 \pm 0.0022 \pm 0.0010$
2. Engelkemeir expt 1962: $b_+/b_- = (1.12 \pm 0.14) \times 10^{-5}$
3. Mougeot theory: $b_0/b_+ = 215.0 \pm 3.1$

Assuming 1. is correct, and taking Kossert 2022's evaluation for λ_- and λ^* , we find inconsistent values for λ_+ :

- 1+ 2 : $\lambda_+ = (5.5 \pm 0.7) \times 10^{-6}$ Gy
- 1+ 3 : $\lambda_+ = (2.5 \pm 0.6) \times 10^{-6}$ Gy

General concept to measure ^{40}K β^+ to within 10%

Triple coincidence experiment

Emitted β^+ annihilates into two 511keV γ back to back

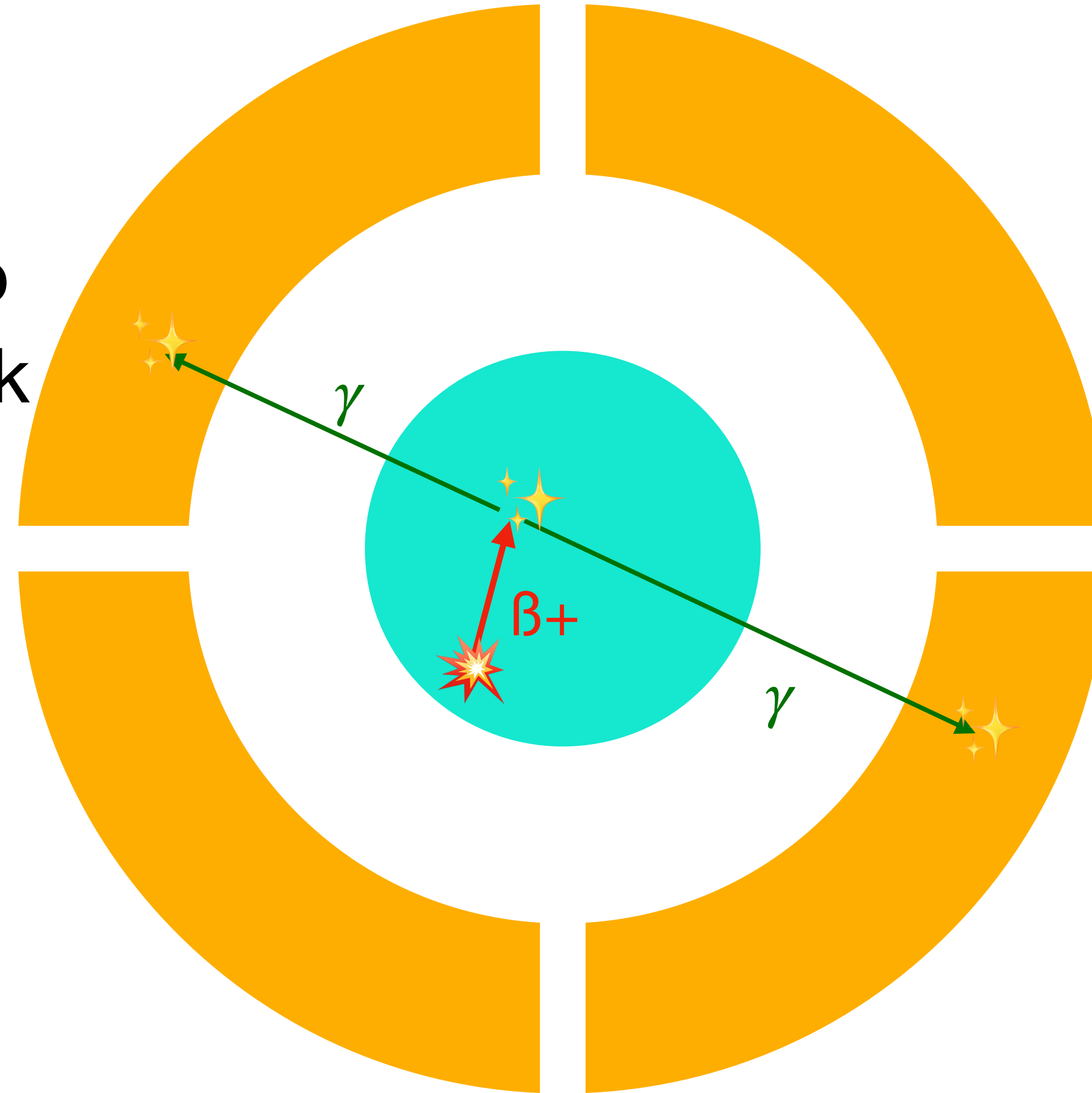

Gamma detector:
4 NaI crystals quadrants
connected to PMTs

Beta detector:
Liquid scintillator +
dissolved potassium 40

Loading a liquid scintillator with 40K

- Natural abundance: 0.0017 (1) %
- Half life 40K: 1.2504 (30) Gy
- β^+ branching ratio: 0.001 %

Goals:

- Dissolve a maximum amount of Potassium in the vial
- Make the cocktail with the best light yield
 - ✓ Find the best potassium salt
 - ✓ Optimize the concentration of salt in the liquid

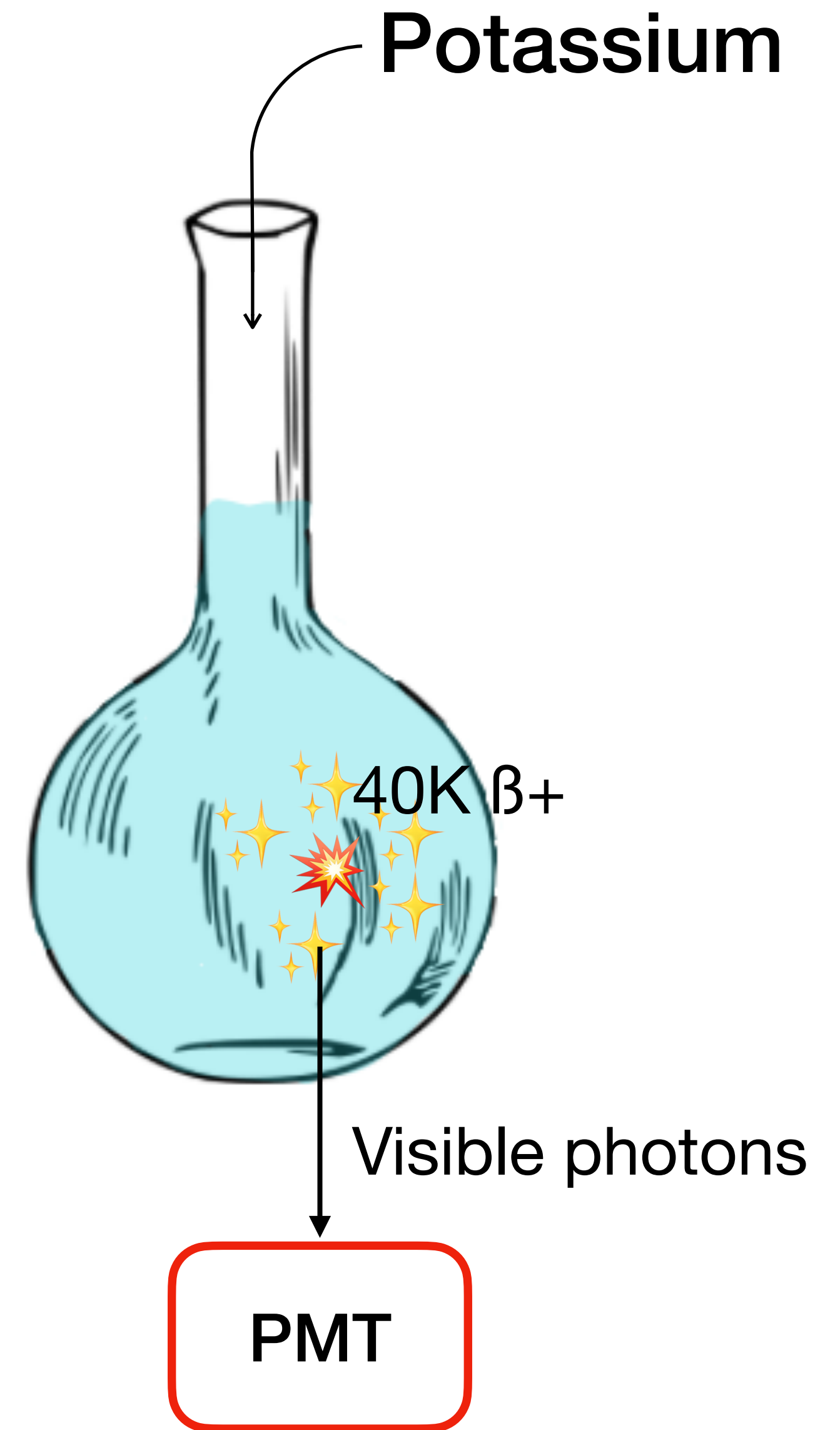

Liquid scintillator cocktail: Ultima Gold, PerkinElmer

Solvent: DIPN, Diisopropyl naphthalene

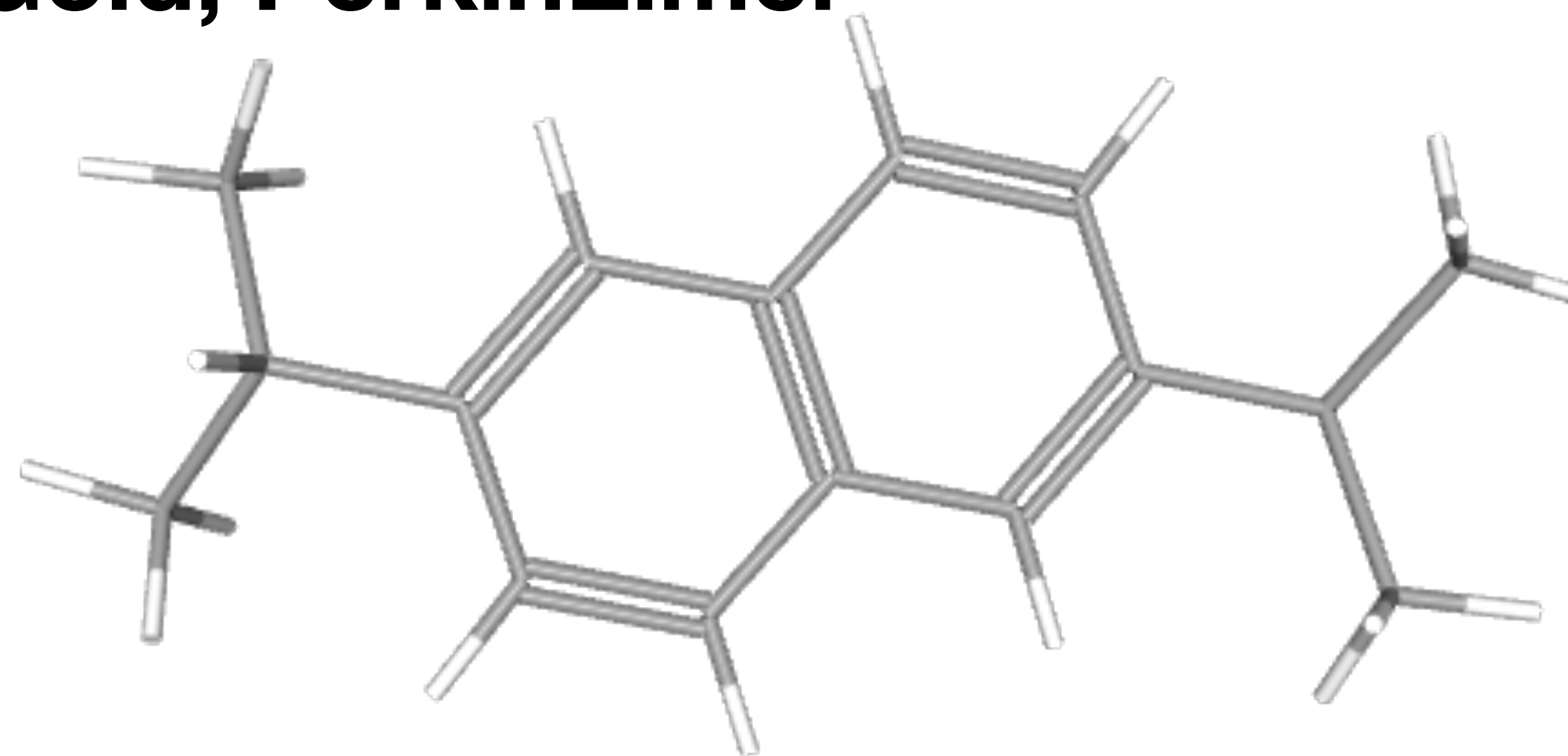

Primary scintillator: PPO
fluorescence maximum at 375 nm

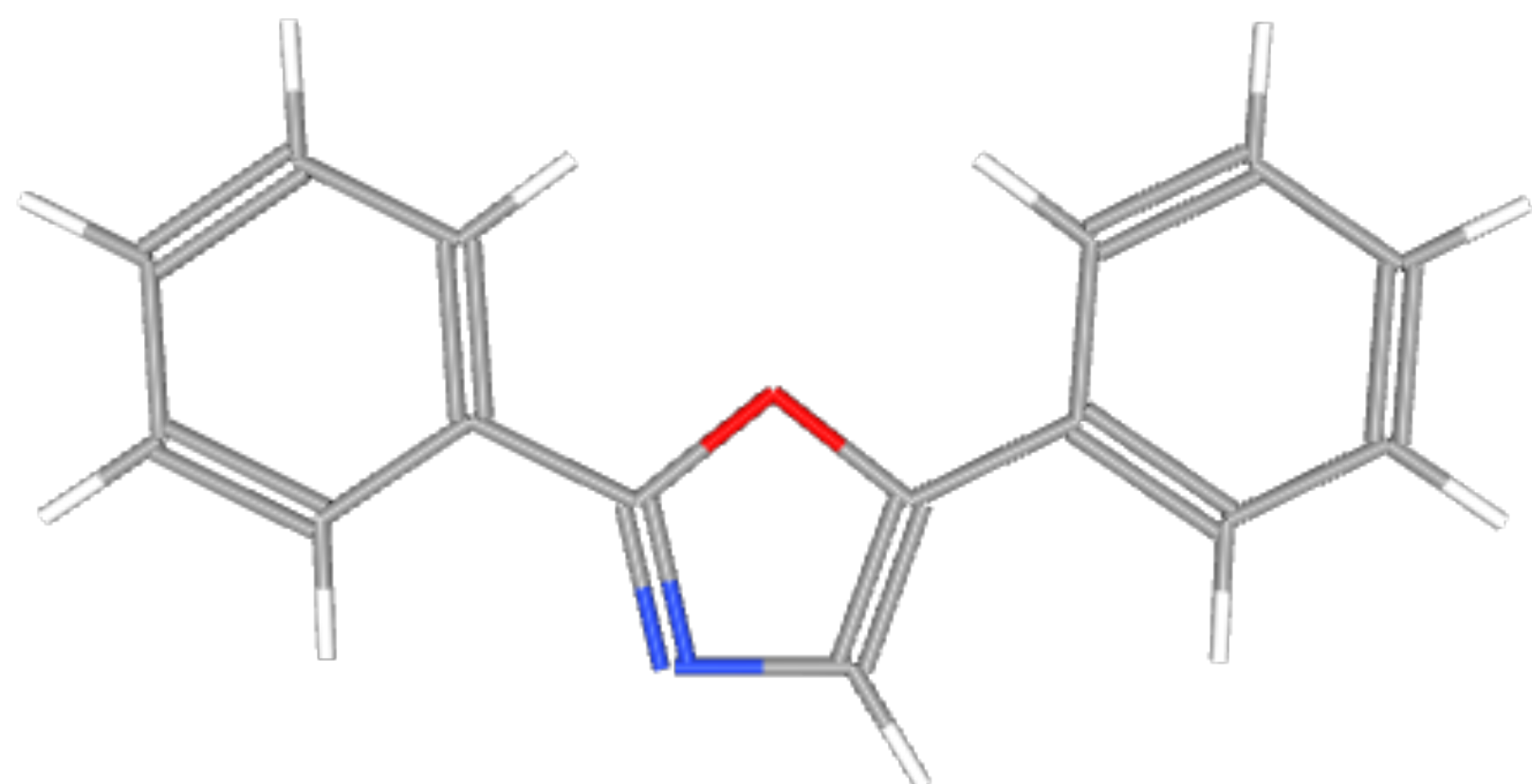

Secondary scintillator: POPOP
fluorescence at 415 nm

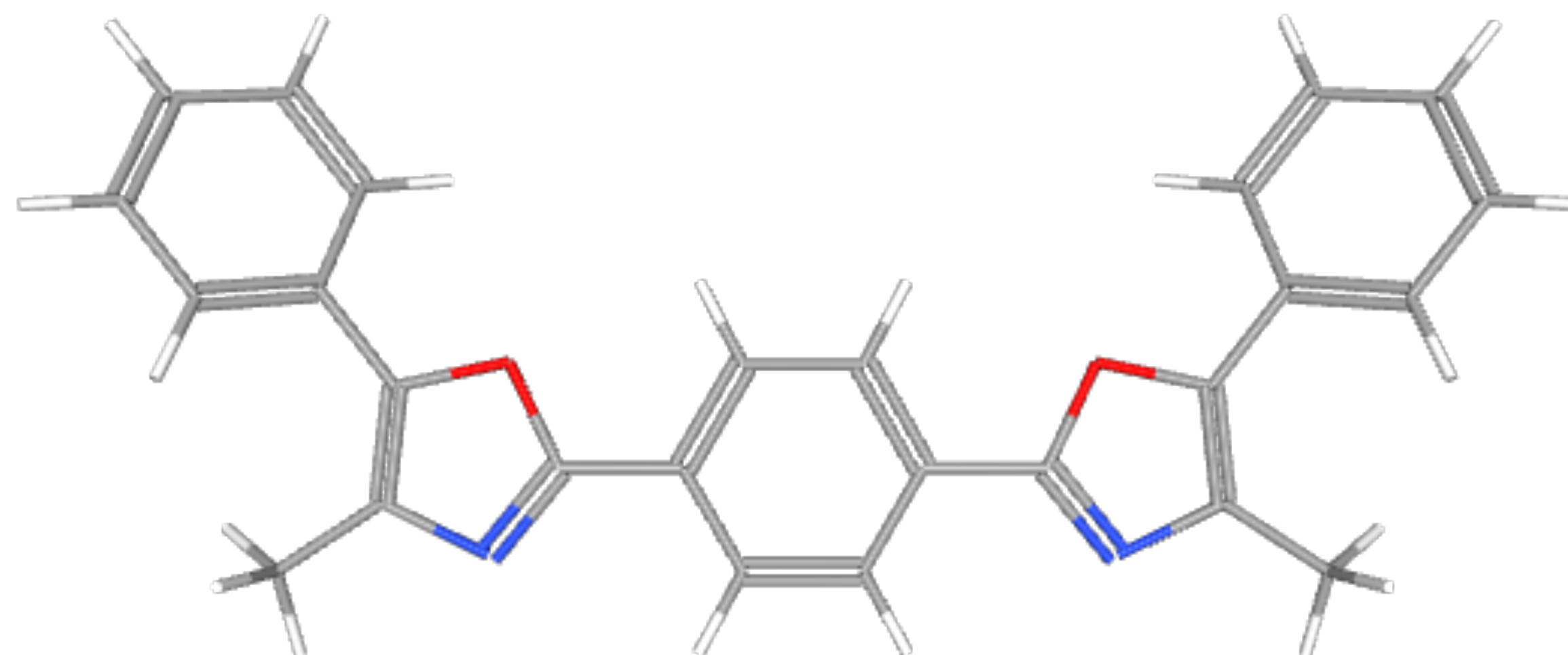

Loading a liquid scintillator with 40K: dissolving a potassium salt

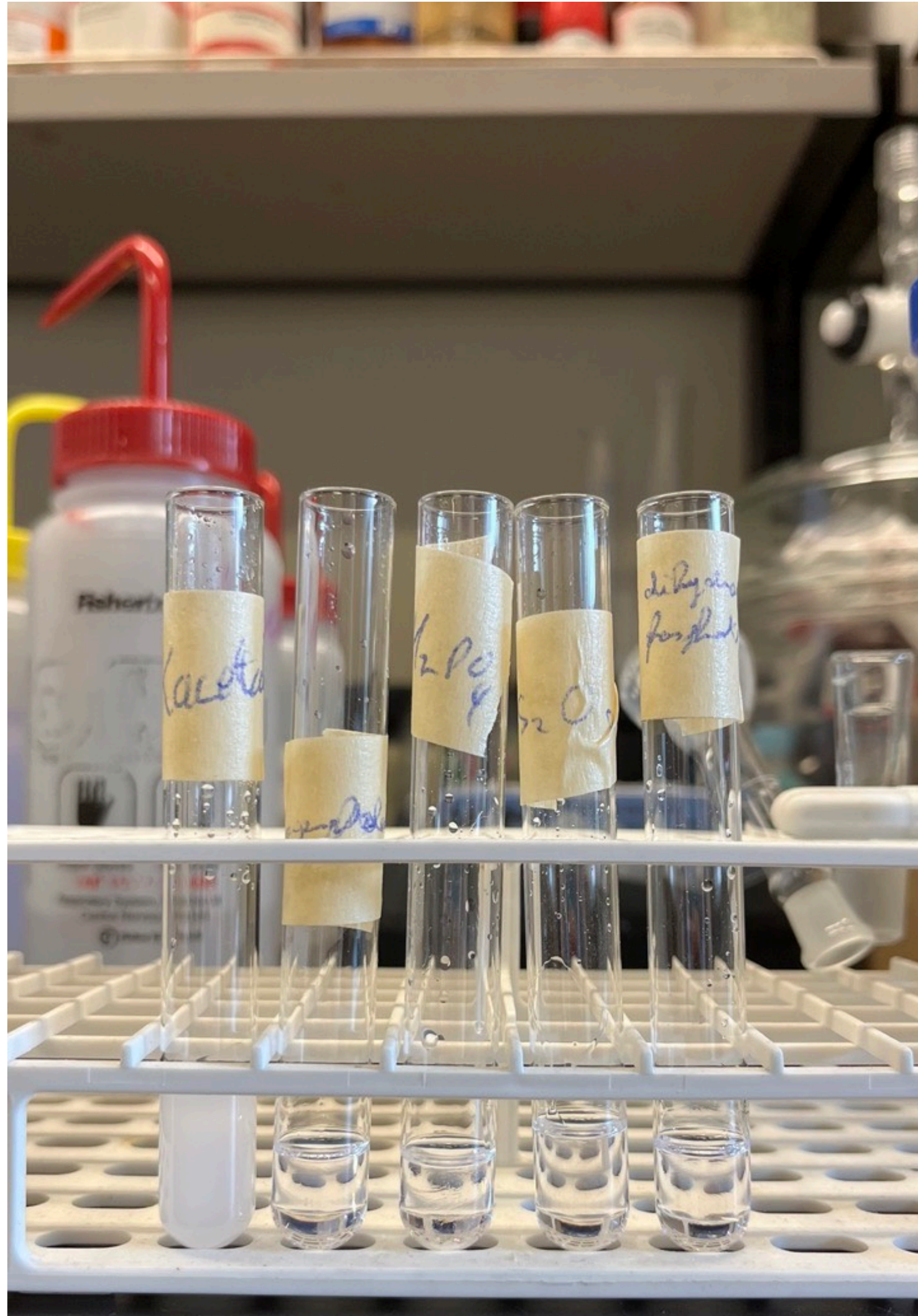

Loading a liquid scintillator with 40K: dissolving a potassium salt

Potassium Salt	KCl	KI	K ₂ CO ₃	KOH	KNO ₃	KF	KIO ₃	E212
Solubility in water g/L	360	1430	1120	1100	357	485	47	492
Concentration of K g/L	188	336	632	766	138	326	9	120

Basic ↓ Toxic ↓

Table 2: Solubility at saturation for a selection of Potassium salts in distilled water at 20°C. Data found on Wikipedia

Choice of salt depends on:

- ✓ High solubility
- ✓ Chemical compatibility with LSC and vial
- ✓ Supply with high purity
- ✓ Possible enrichment

Loading a liquid scintillator with 40K: find a stable emulsion

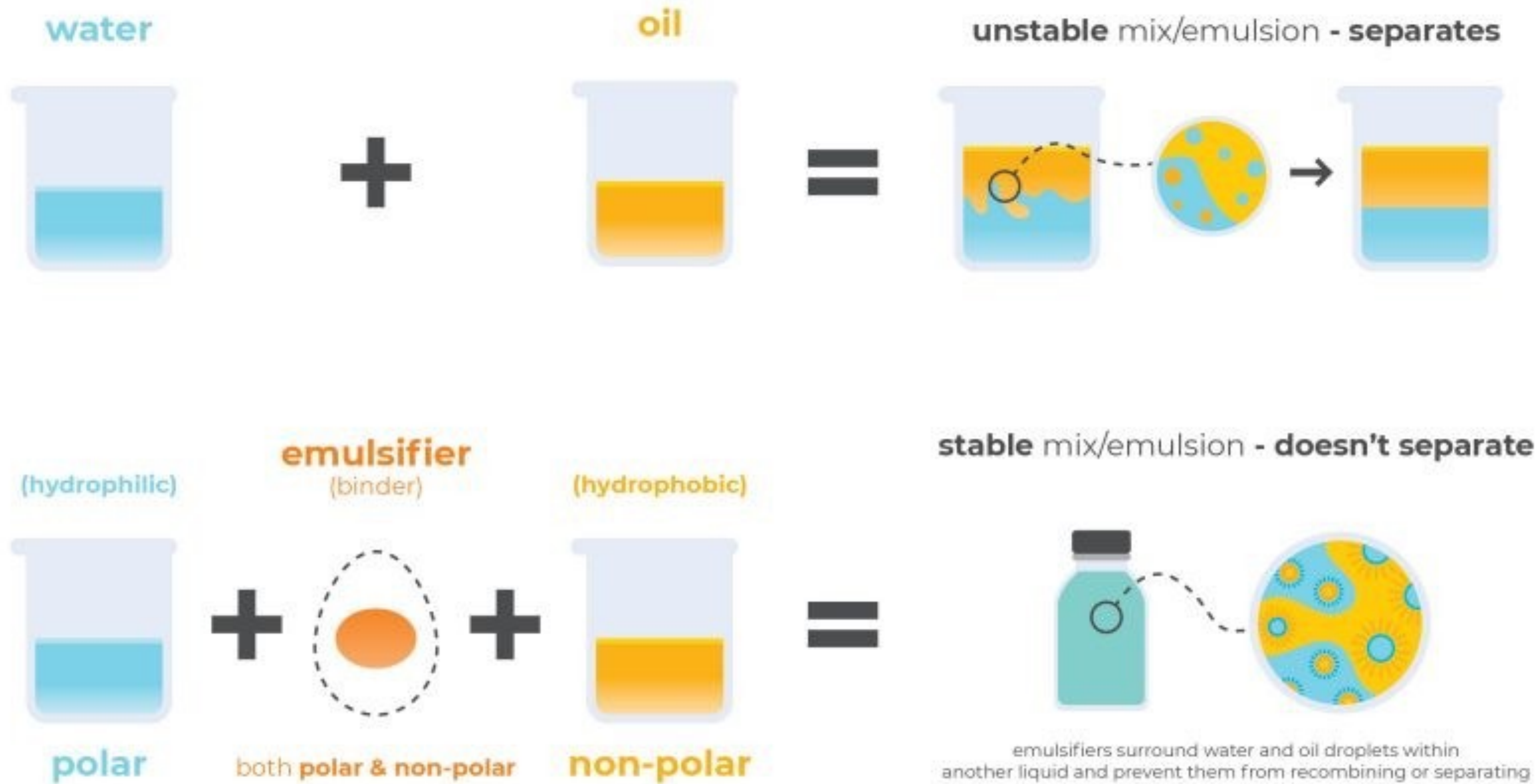

Emulsifier in Ultima Gold LLT
Sodium dioctyl sulfosuccinate

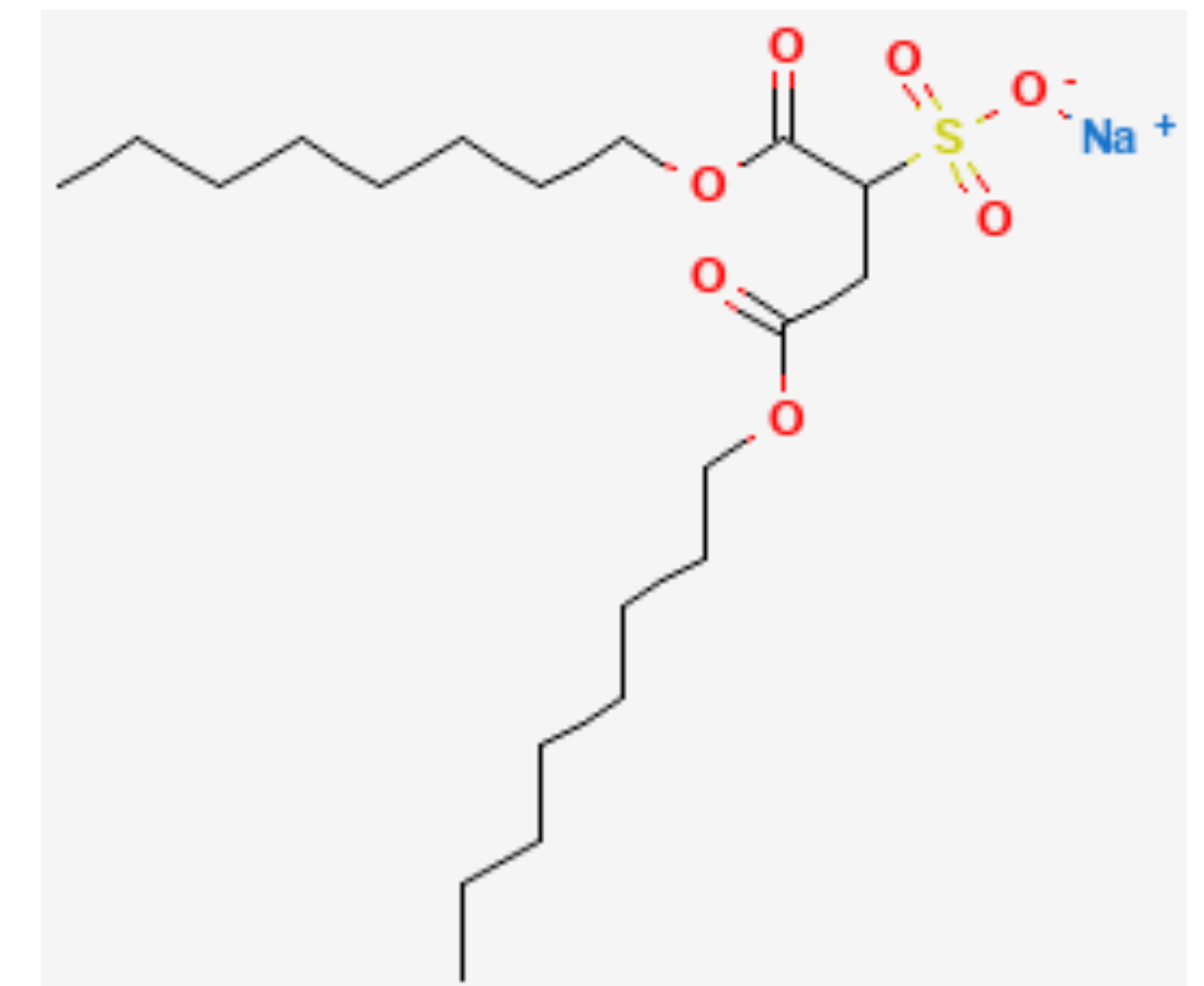

Loading a liquid scintillator with 40K: dissolving a potassium salt



✘



✘



✔

Energy calibration of the liquid scintillator

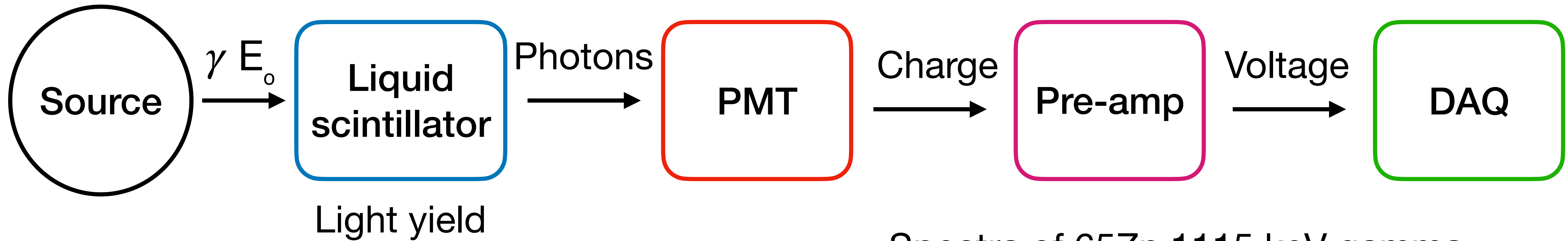

Spectra of ^{65}Zn 1115 keV gamma

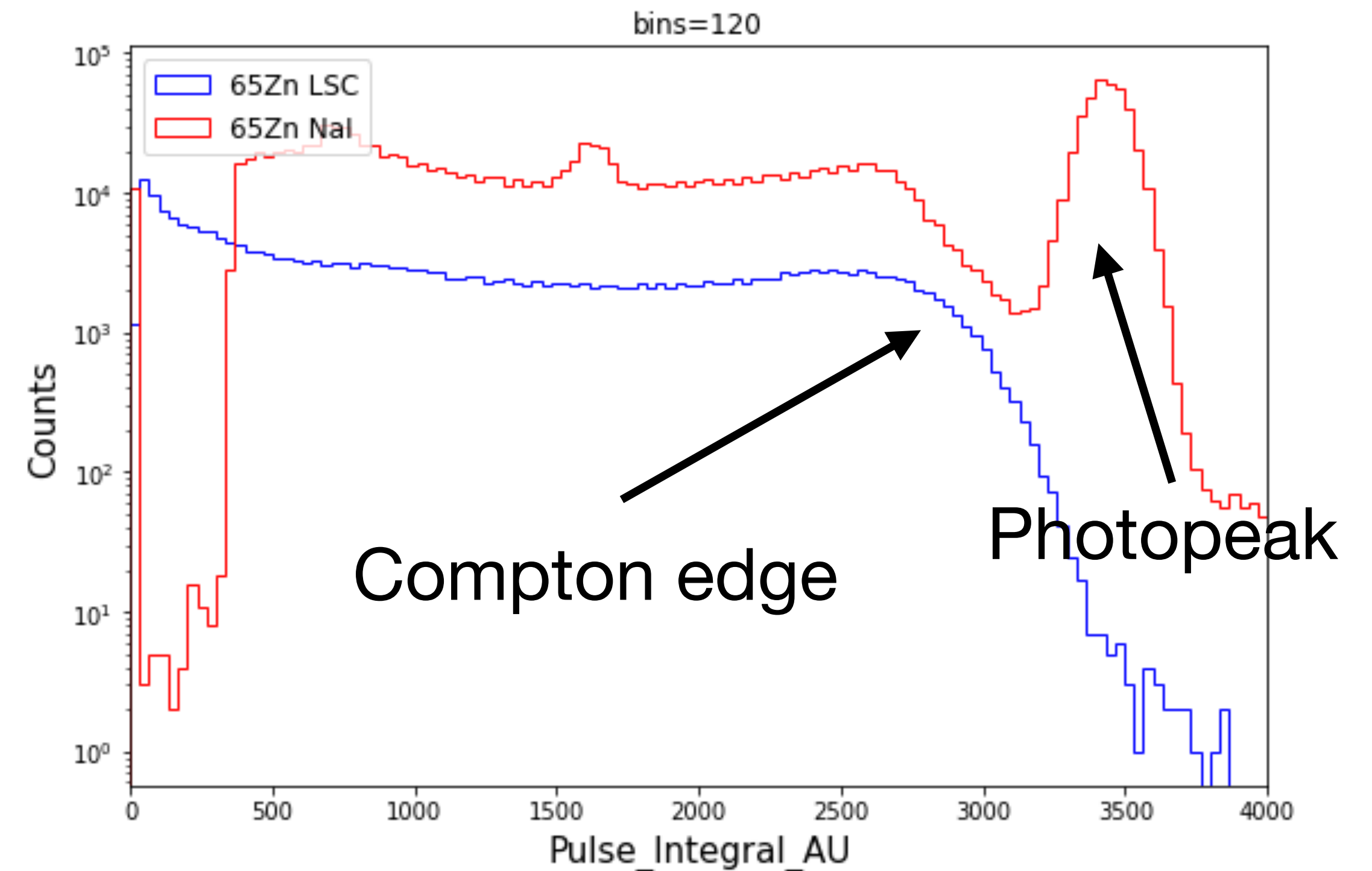
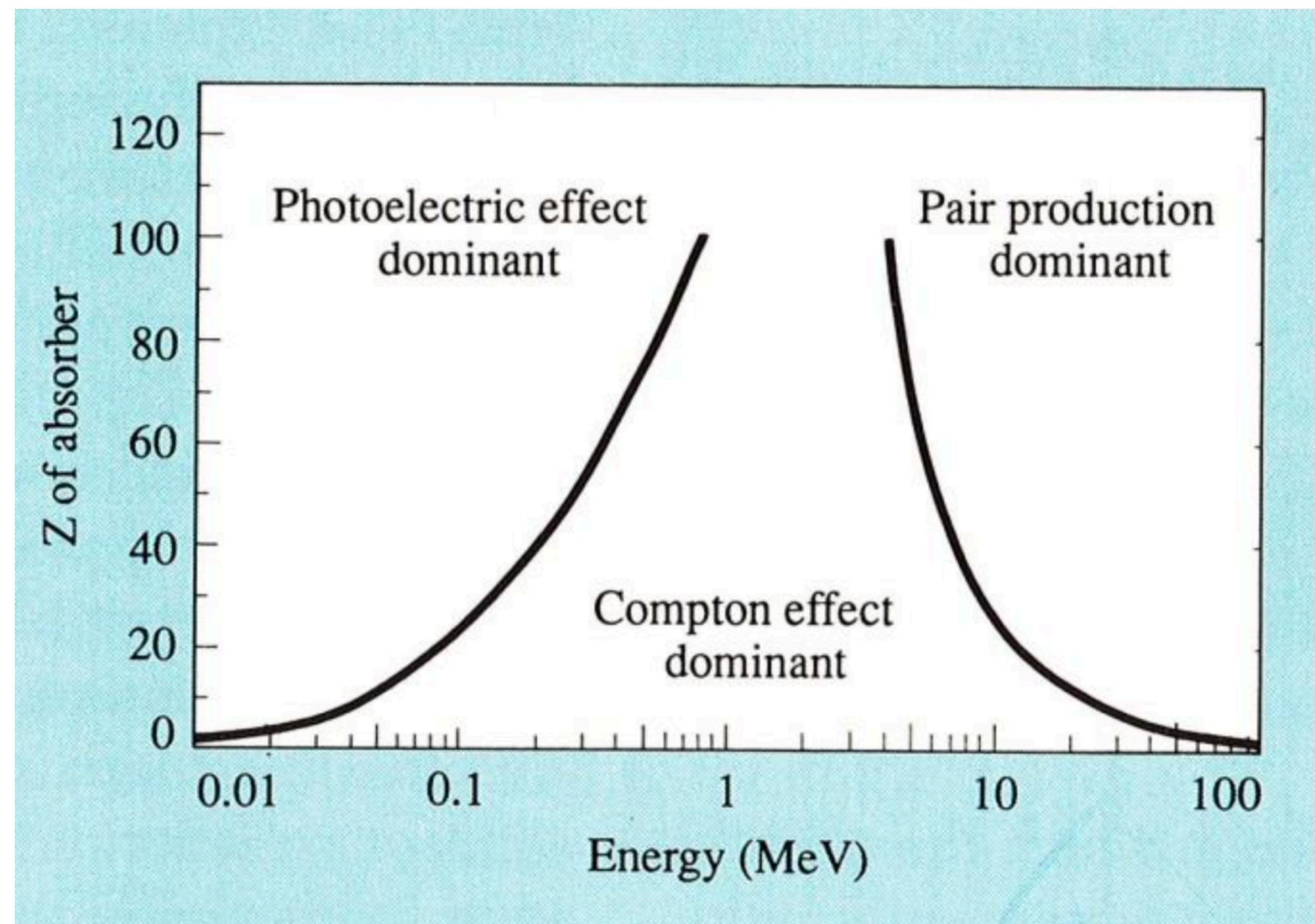

Energy calibration of the liquid scintillator: Compton experiment

Compton coincidence experiment - setup

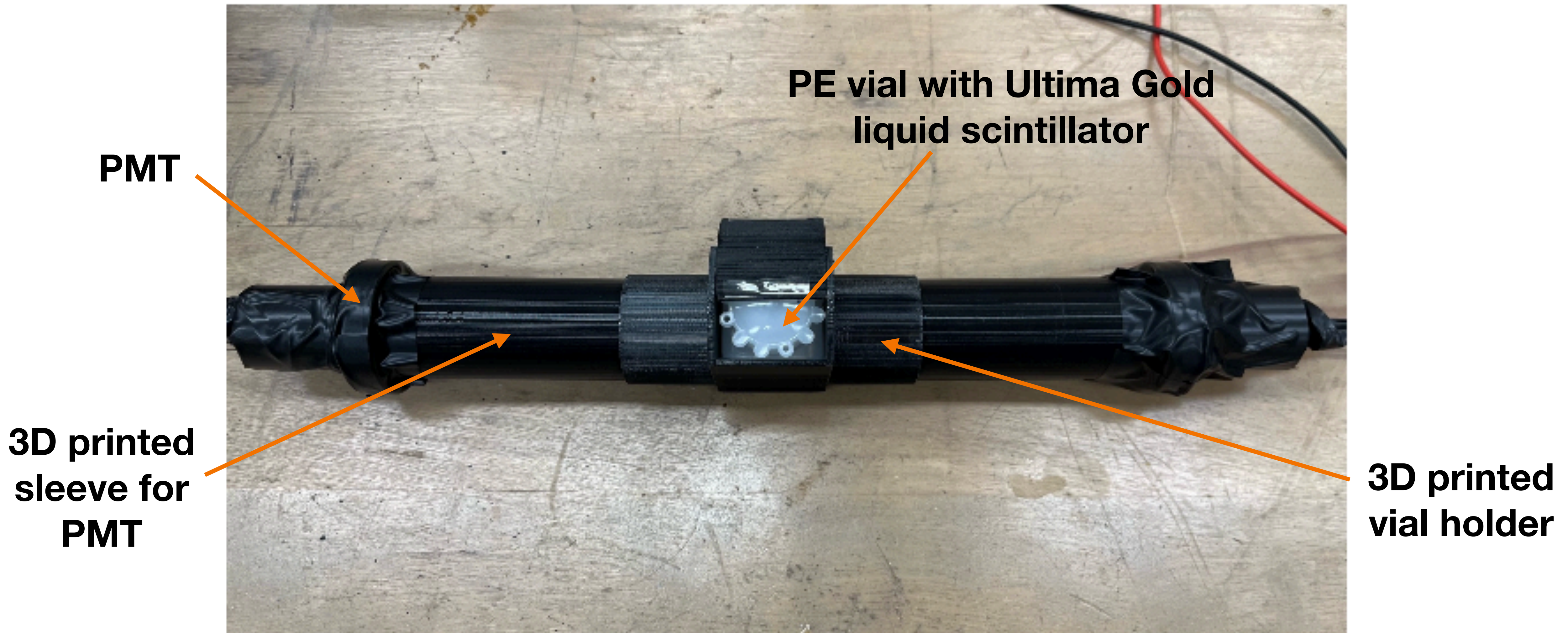

Energy calibration of the liquid scintillator: Compton experiment

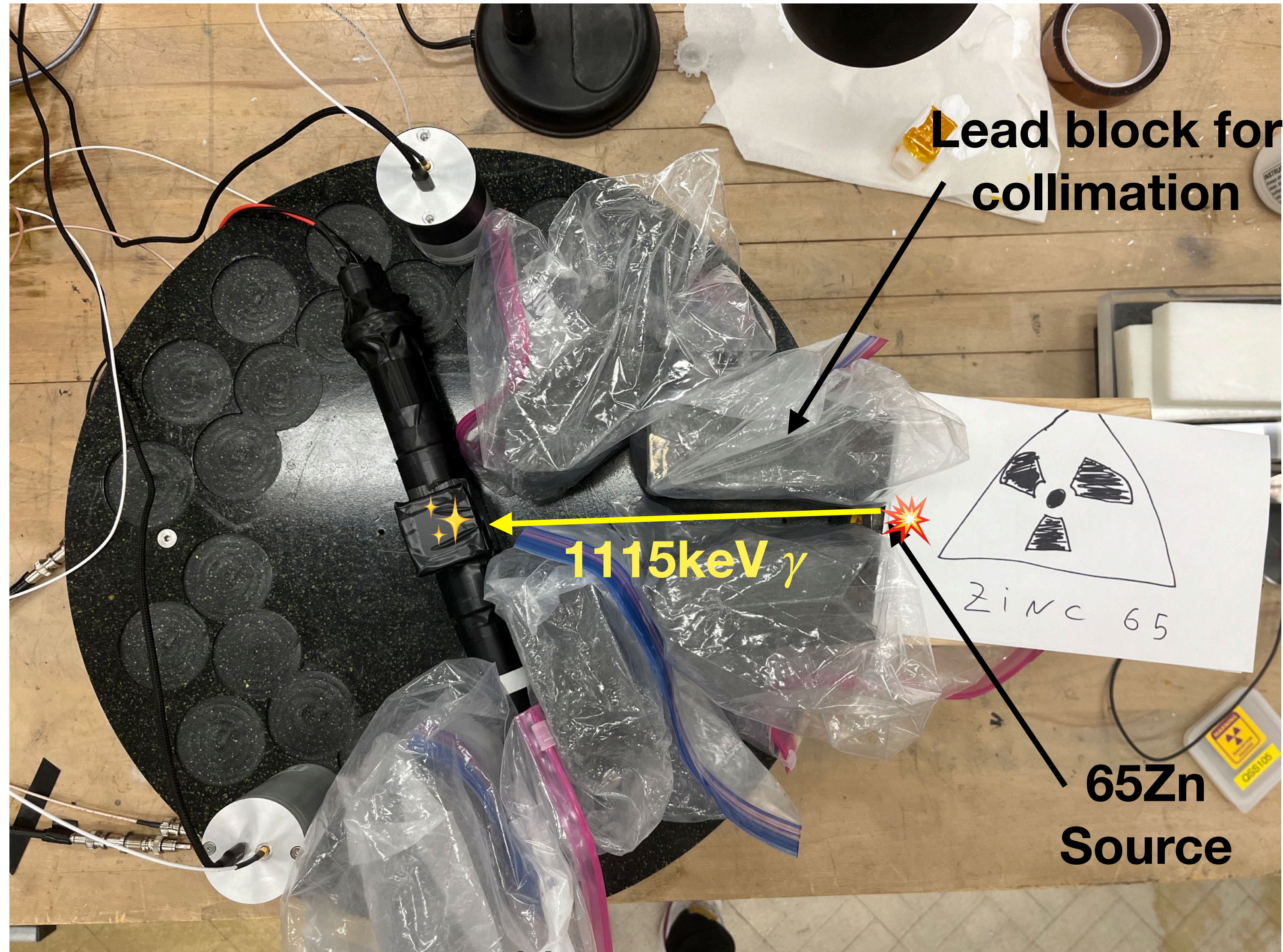

Energy calibration of the liquid scintillator: Compton experiment

Incident gamma scatters and deposits energy in the liquid scintillator

Scattered gamma detected on NaI crystal

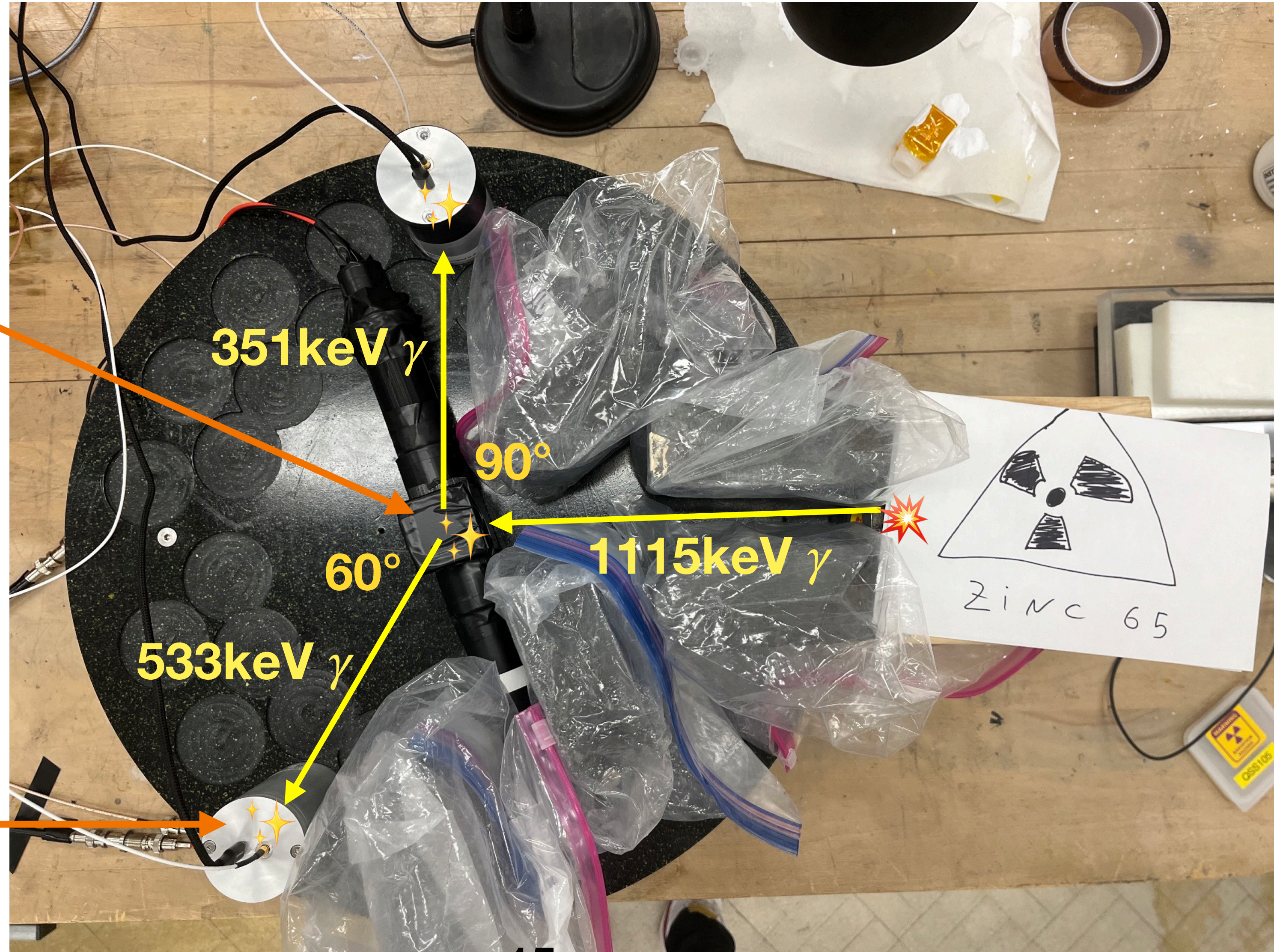

Energy calibration of the liquid scintillator

Kinetic energy of the electron after scattering with incident γ E_0 :

$$T_e = E_0 - E = E_0 - \frac{E_0}{1 + \alpha(1 - \cos \theta)}$$

$$\alpha = \frac{E_0}{m_e c^2}$$

✓ Compare light yield of different cocktail

✓ Energy calibration of beta detector

LSC_Energy_Deposition_Coincidence

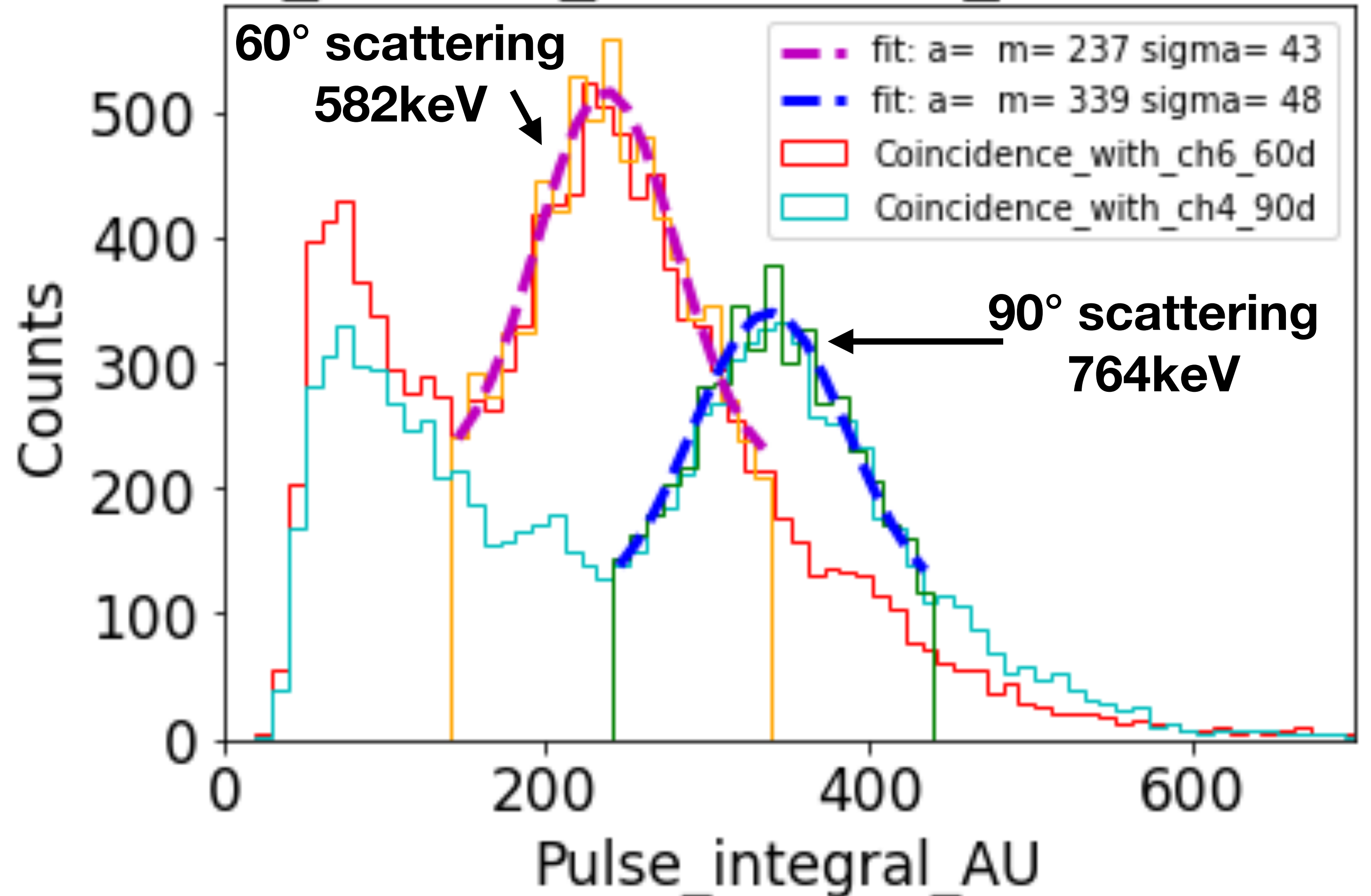

Liquid scintillator choice for the beta detector

Goal: Determining which cocktail should be used for KDK+ experiment:

- Liquid scintillator type: Ultima Gold, Ultima Gold LLT
- Potassium Salt: KCl, K₂CO₃, KI, KOH.
- Volume and concentration of the aqueous solution mixed with the LSC

Requirements:

- Liquid scintillator stable over time; experiment can be longer than a week.
- Potassium homogeneously dissolved in the vial.
- Maximum light yield.

Liquid scintillator choice for the beta detector: results

LSC study campaign

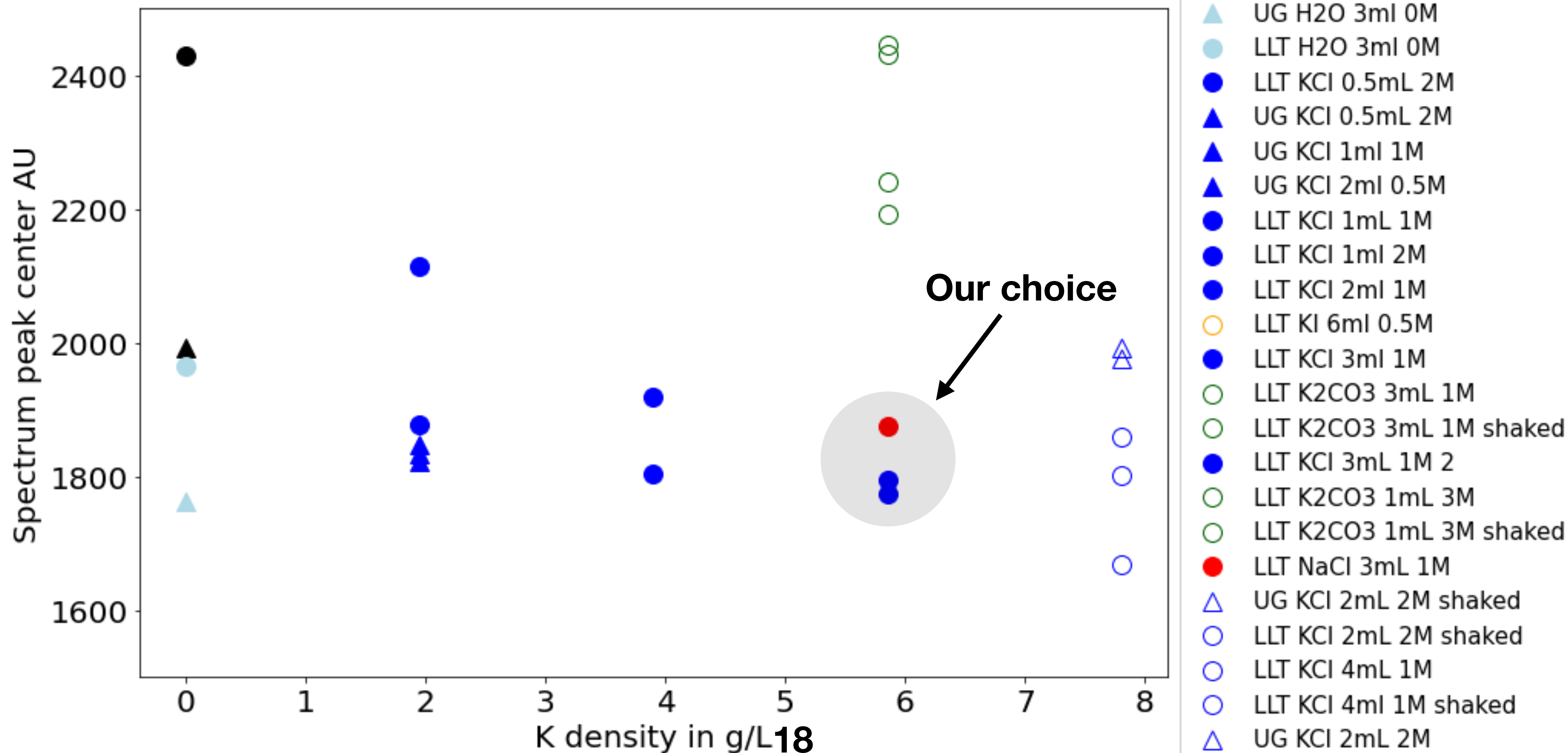

Loading a liquid scintillator with 40K: Results

Potassium Salt	KCl	K ₂ CO ₃	KI	KOH
Threshold in UltimaGold	1	-	-	-
Threshold in UltimaGold LLT	3	< 2	5	< 1

Table 3: Maximum amount of potassium in mmol dissolved in a 20mL vial with UltimaGold LLT before the emulsion collapses.

Target : 1000 β^+ emitted in the detector in a month of acquisition

- Concentration of K in LSC: 6 g/L
- Activity of the source of 40K= 38.2 Bq
- Mass of 40K: 0.14 mg
- Mass of potassium: 1.21 g
- Volume of liquid scintillator needed: 200mL

Gamma detector: NaI(Tl) annulus

Features:

- Dating from the 1970s
- 23cm deep
- 8.5cm inner diameter hole
- 4 big Quadrant of 8cm thickness to stop 511keV gammas
- Simulation gives a 35% Triple-coincidence efficiency

Work to be done:

- Energy calibration of the NaI crystals
- Determine the efficiency with ^{22}Na source

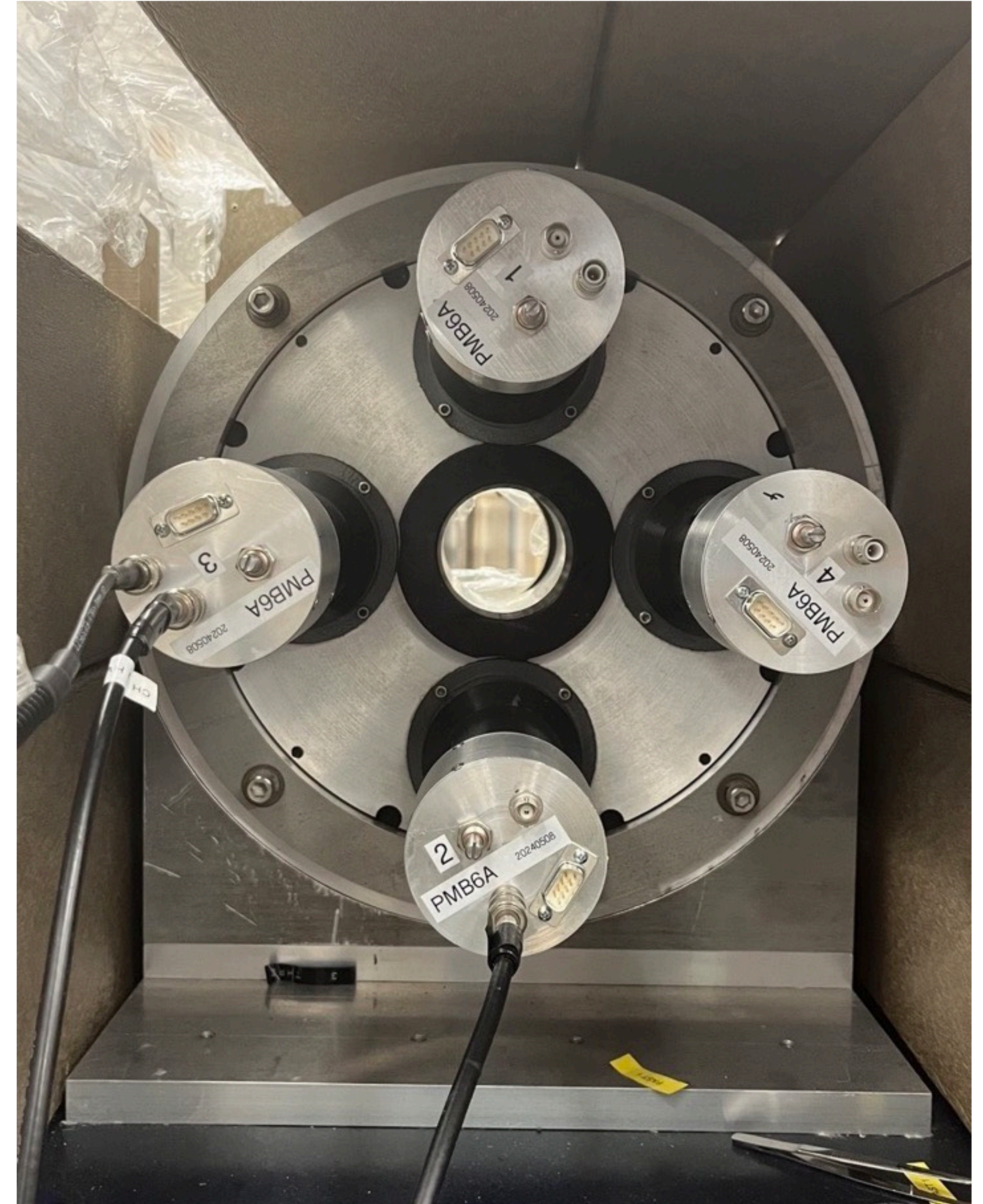

Gamma detector: NaI(Tl) annulus

Annulus spectra with new amplified sockets

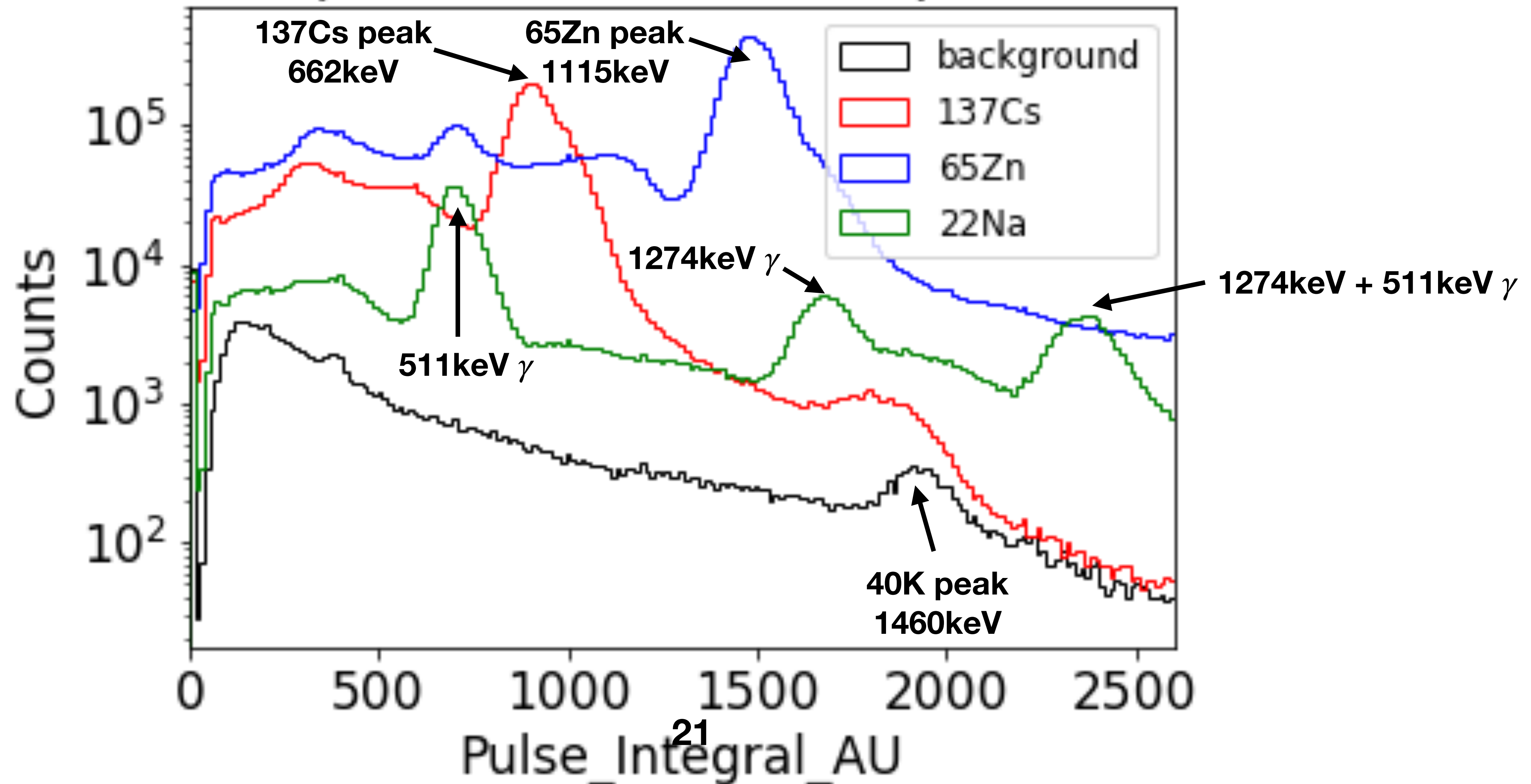

Design of a 300mL liquid scintillator for our detector

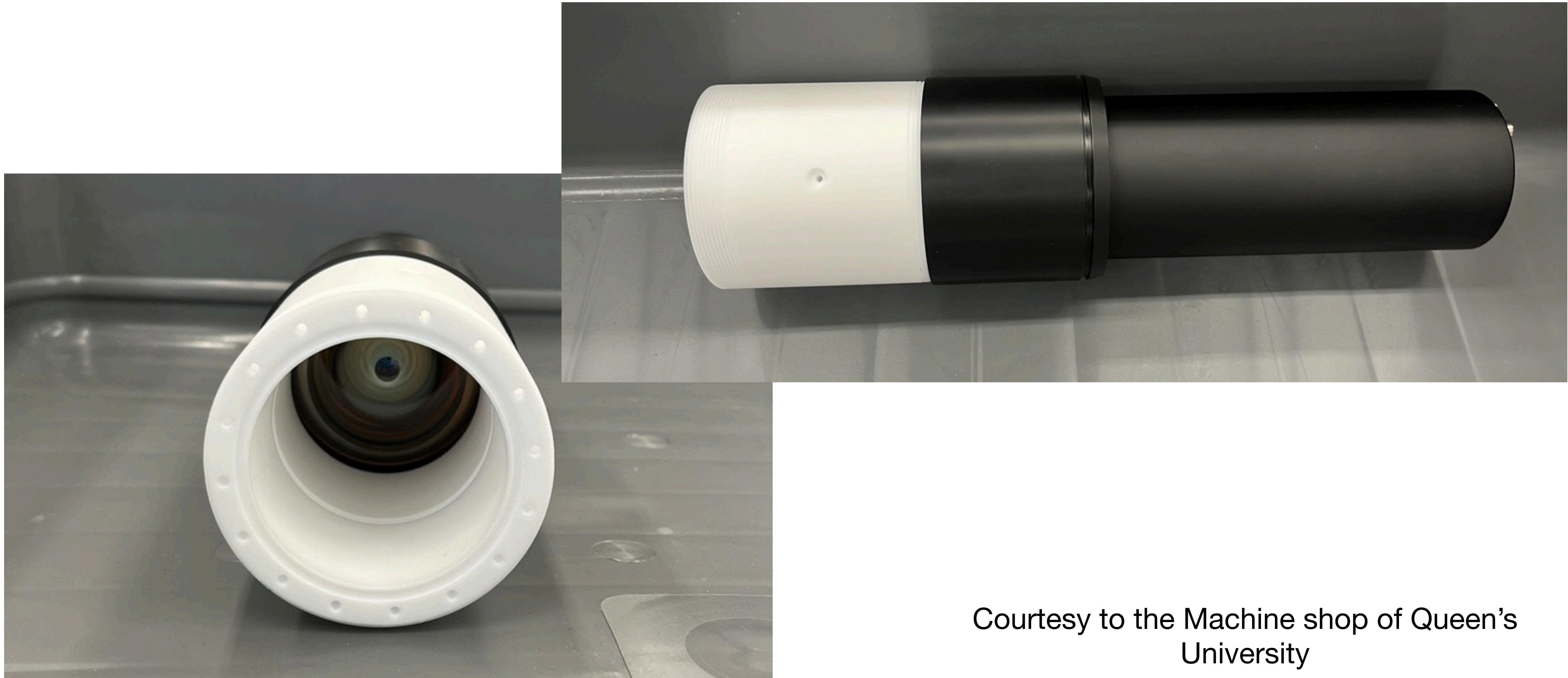

Courtesy to the Machine shop of Queen's University

Conclusion

Results:

- ✓ Method to load potassium in the LSC
- ✓ Choose the optimum LSC cocktail loaded with 40K
- ✓ Working Compton coincidence to calibrate energy and resolution of LSC
- ✓ Make the socket for NaI annulus and determine time resolution

Next steps for KDK+:

- ✓ Calibrate triple coincidence efficiency of the annulus with ^{22}Na
- ✓ Do experiment with 40K at natural abundance in 300mL Teflon vessel

Acknowledgment to Philippe Di Stefano's group at Queen's University



Annexe

Measuring Decays with Rock Dating Implications

Stephen Ellis Cox

Lamont-Doherty Earth Observatory, Columbia University, Palisades, NY, US

July 31, 2023 • *Physics* 16, 131

Researchers revisit a neglected decay mode with implications for fundamental physics and for dating some of the oldest rocks on Earth and in the Solar System.

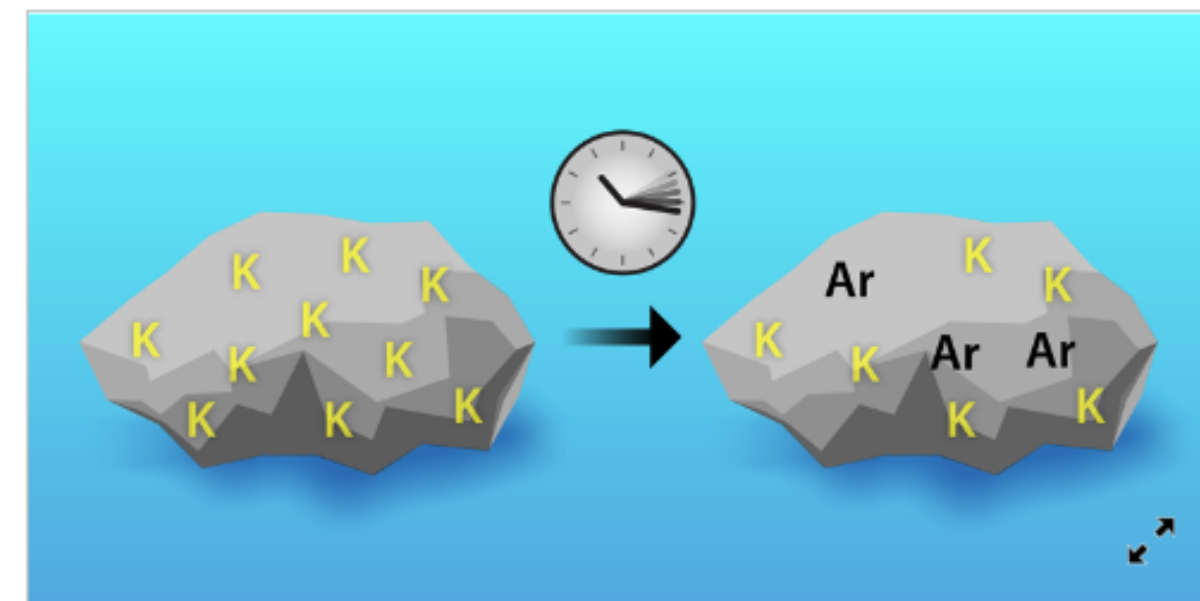

APS/Alan Stonebraker

Figure 1: As a rock forms, it traps a set of potassium-40 within the solid. Decays of this isotope produce argon-40. By measuring the amount of argon-40 relative to that of potassium-40, geologists can date the rock.

With a half-life of 1.25 billion years, potassium-40 does not decay often, but its decays have a big impact. As a relatively common isotope (0.012% of all potassium) of a very common metal (2.4% by mass of Earth's crust), potassium-40 is one of the primary sources of radioactivity we encounter in daily life. Its decays are the primary

Rare ^{40}K Decay with Implications for Fundamental Physics and Geochronology

M. Stukel *et al.* (KDK Collaboration)

Phys. Rev. Lett. 131, 052503 (2023)

Published July 31, 2023

Read PDF

Evidence for ground-state electron capture of ^{40}K

L. Hariasz *et al.* (KDK Collaboration)

Phys. Rev. C 108, 014327 (2023)

Published July 31, 2023

Read PDF

Recent Articles

Watching a Quantum System Thermalize

Atoms trapped in a one-dimensional optical lattice can mimic how—in a basic quantum field theory—massive particles reach, or fail to reach, thermal equilibrium.

The Search for WIMPs Continues

Two mammoth underground detectors have delivered more stringent upper limits on how

KCl loading in Liquid Scintillator: Ultima Gold, PerkinElmer

Table 3. Sample capacity of selected cocktails for various ionic strength buffers (sample capacities are for 10 mL cocktail at 20 °C).

Ionic Strength	Ultima Gold XR	Hionic-Fluor	Pico-Fluor Plus	Ultima Gold	Ultima Gold MV	Opti-F
0.5 M NaCl	9.0 mL	1.4 mL	3.0 mL	1.5 mL	1.25 mL	1.1 mL
0.75 M NaCl	6.5 mL	2.25 mL	2.75 mL	0.75 mL	0.75 mL	0.75 mL
1.0 M NaCl	5.5 mL	8.5 mL	2.3 mL	0.5 mL	0.5 mL	0.5 mL

Source: PerkinElmer

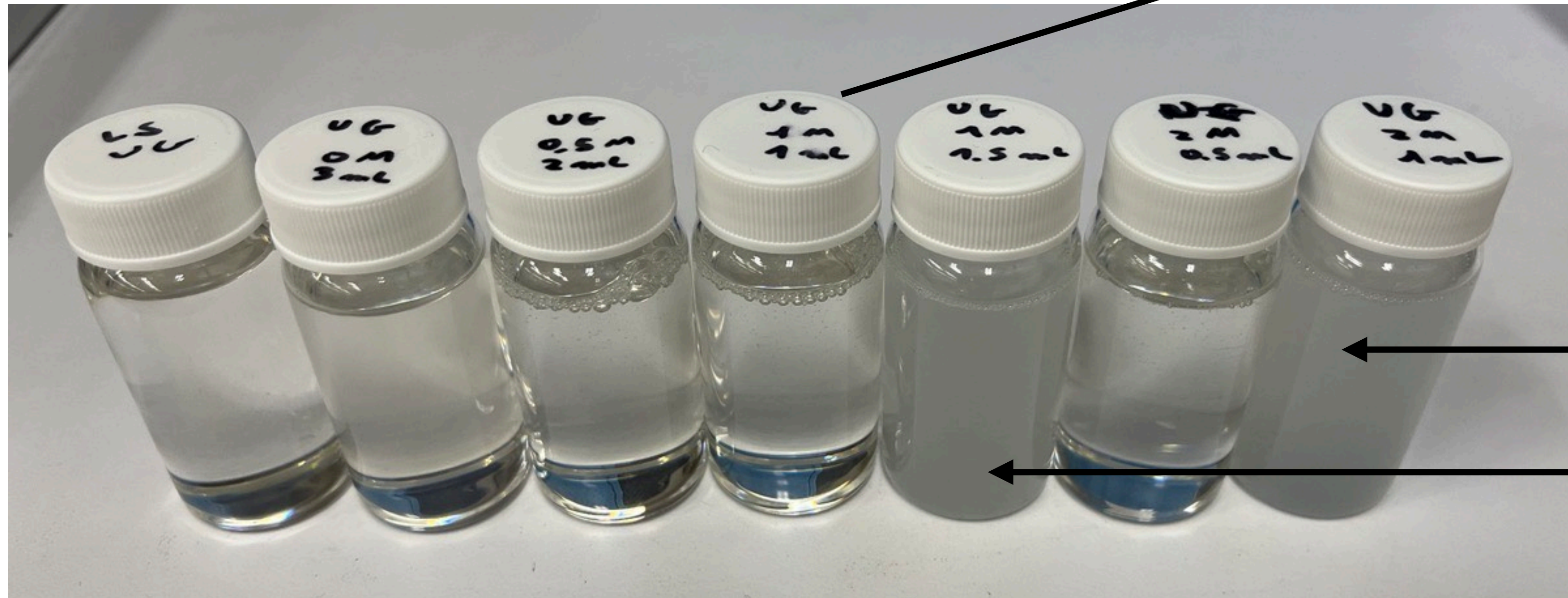

Too much aqueous solution or KCl: cocktail separates in 2 phases and becomes cloudy when shaken

Potassium salts

Basic



Toxic



Potassium Salt	KCl	KOH	KI	K ₂ CO ₃	KNO ₃	KF	KIO ₃
Solubility in water g · L ⁻¹	360	1100	1430	1120	357	485	47
K concentration g · L ⁻¹	188	766	336	632	138	326	9
Natural 40K concentration μg · mL ⁻¹	22,0	89,6	39,3	73,9	16,1	38,1	1,0
3% enriched 40K concentration mg · mL ⁻¹	5,6	23,0	10,1	19,0	4,1	9,8	0,3

Choice of salt depends on:

- ✓ Chemical compatibility with LSC and vial
- ✓ High solubility
- ✓ Supply with high purity
- ✓ Possible enrichment

Energy calibration of the liquid scintillator

2nd setup, less plastic



**Reflective foil to
improve light collection
by the PMT**

Energy calibration of the liquid scintillator

Platform



**Sodium Iodide module:
2" deep x 2" dia. crystals
with SiPM**

**Slots for NaI module
For every 10° from 0
to 140° at 20cm**

Energy calibration of the liquid scintillator

Vial holder for plastic vial with PMT on each side



Different kind a vial for liquid scintillation

**Machined Teflon vial with
borosilicate window
35mL**

**PE vial
25mL**

**Borosilicate vial
20mL**



Teflon Vessel for liquid scintillator

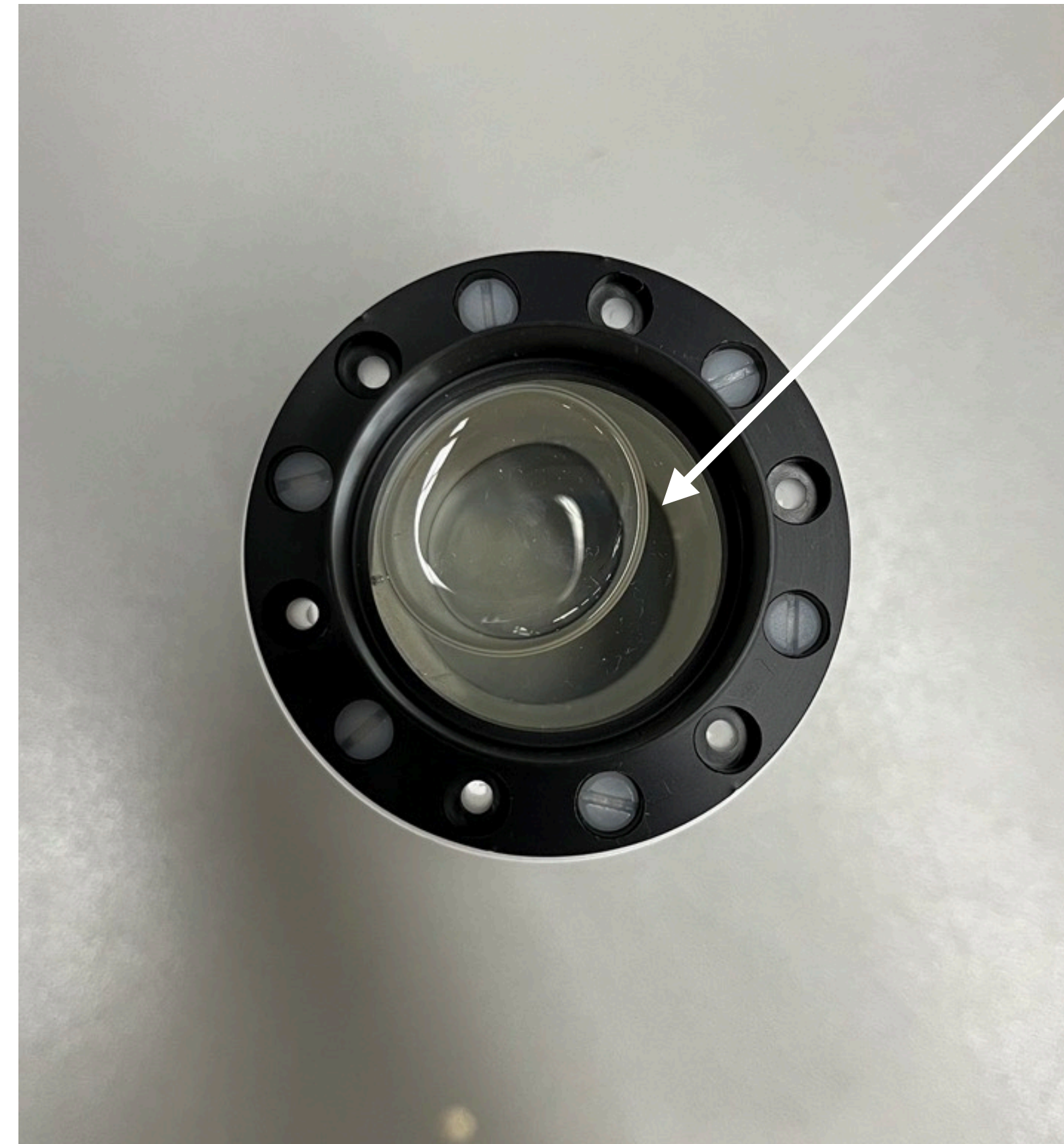
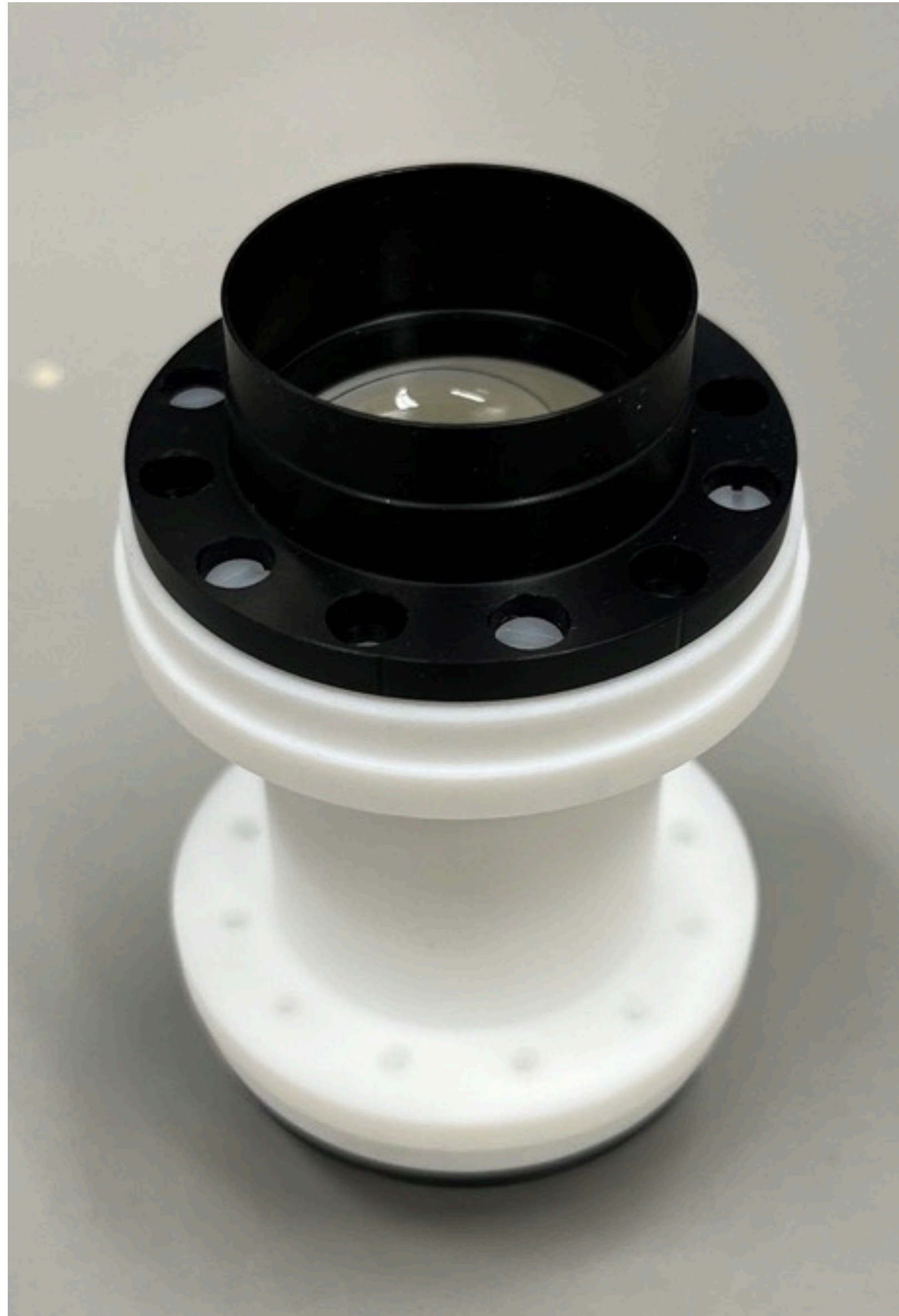

Liquid scintillator
Ultima Gold

Teflon Vessel test

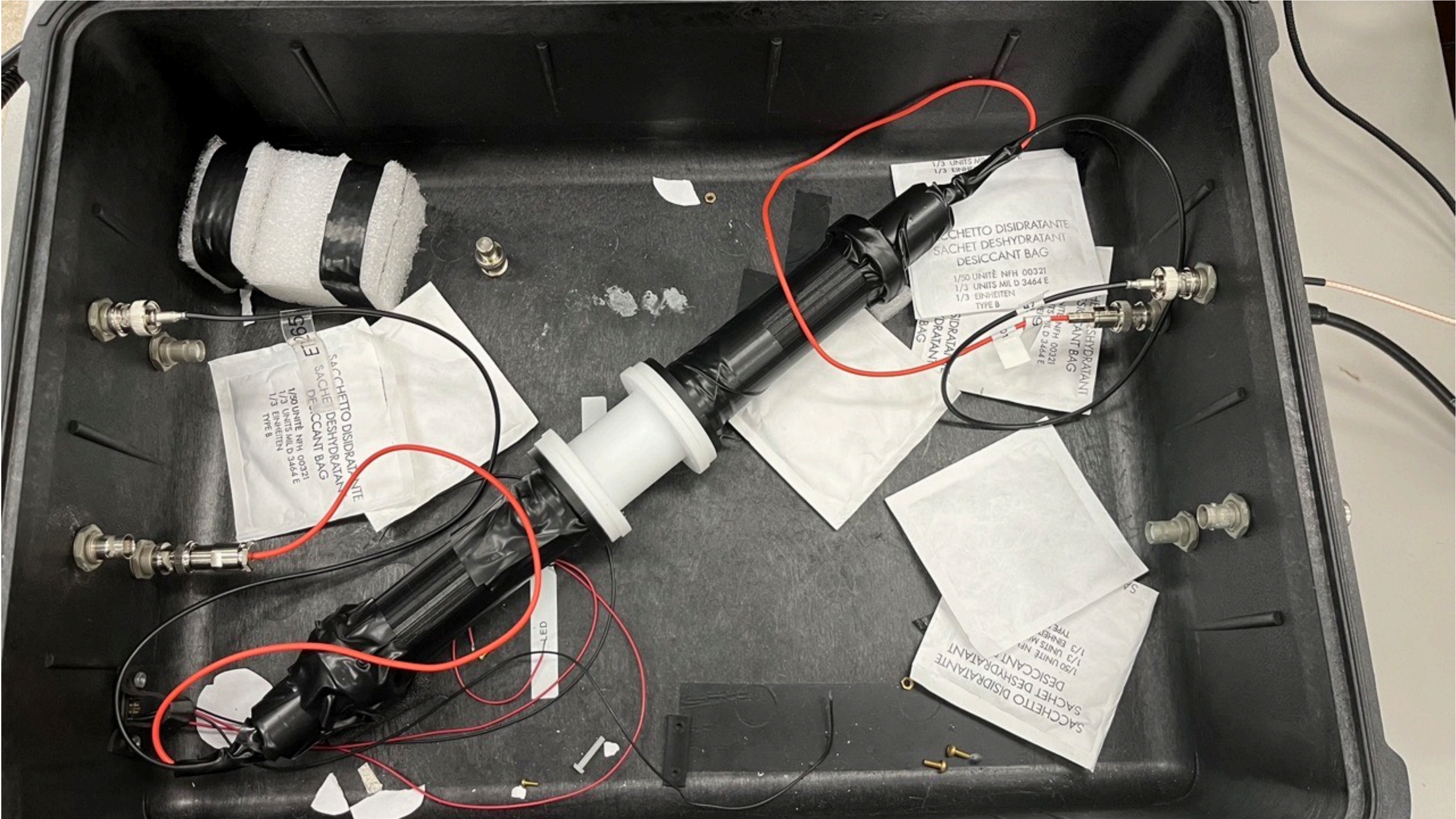

Energy calibration of the liquid scintillator

Data acquisition

CAEN Digitizer V1730

- 16 channels
- CoMPASS software
- Spectra and Coincidence in live
- Data written on CSV, binary or root files. Analysis carried out offline

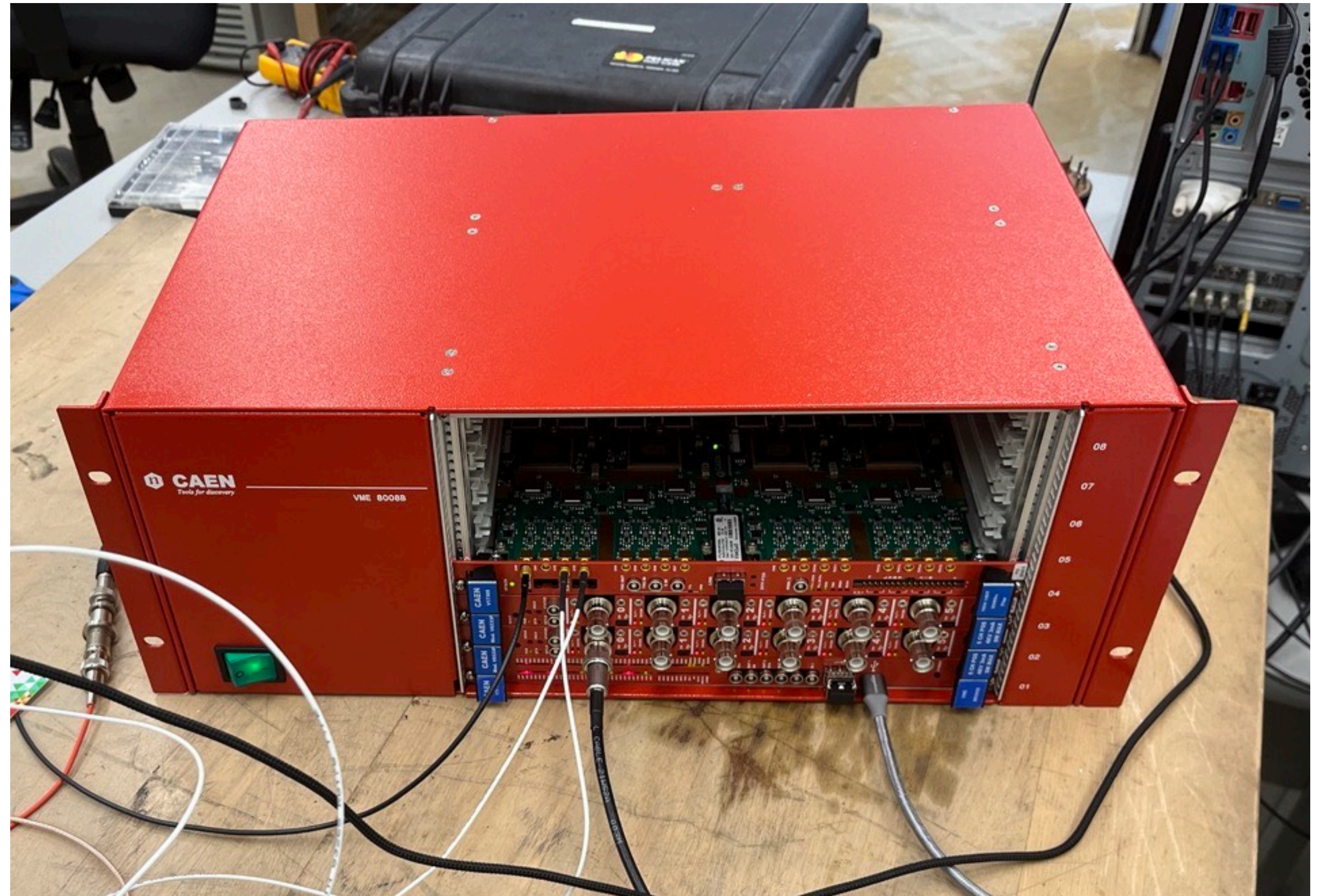

With the help of Emma and Nick to set up the computer and the configuration

Liquid scintillation study Campaign

Quantitative results: Fitting the Compton peak

90° scattering
764keV

LLT_3mL_1M_V2_CH4.png

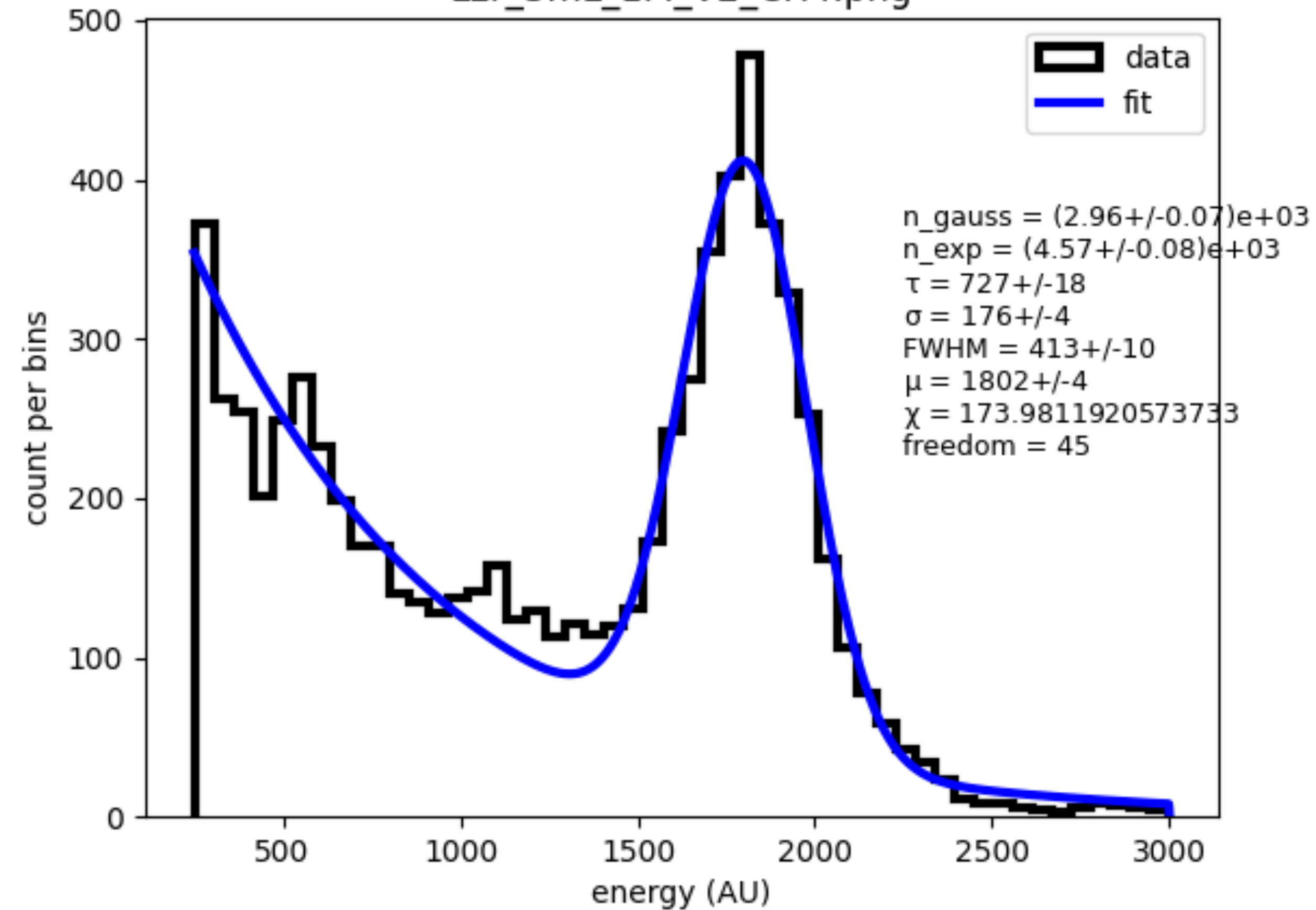

60° scattering
582keV

LLT_3mL_1M_V2_CH2.png

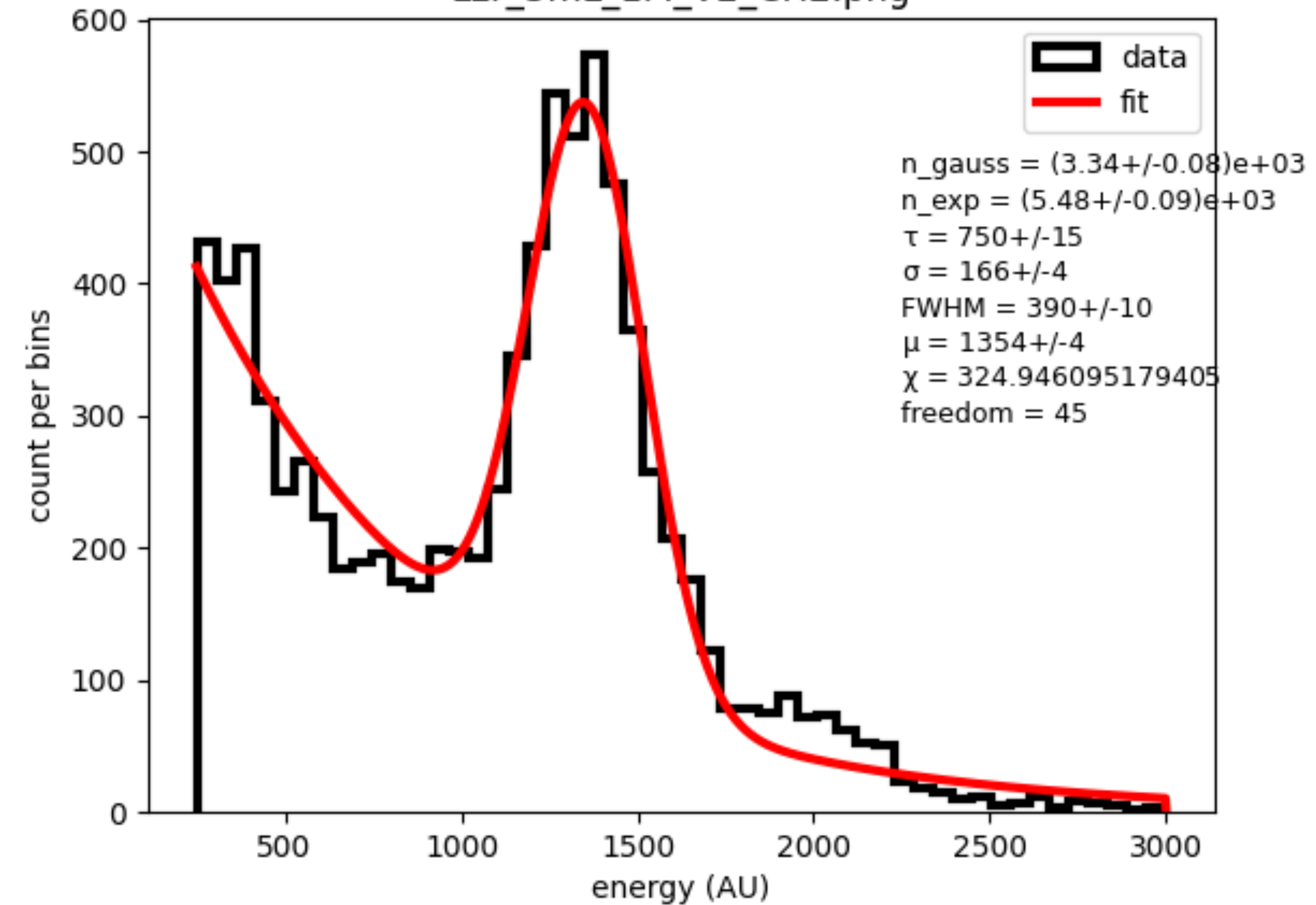

Liquid scintillation study Campaign

Quantitative results: Fitting the Compton peak

90° scattering
764keV

LLT_KCl_3mL_1M_CH4.png

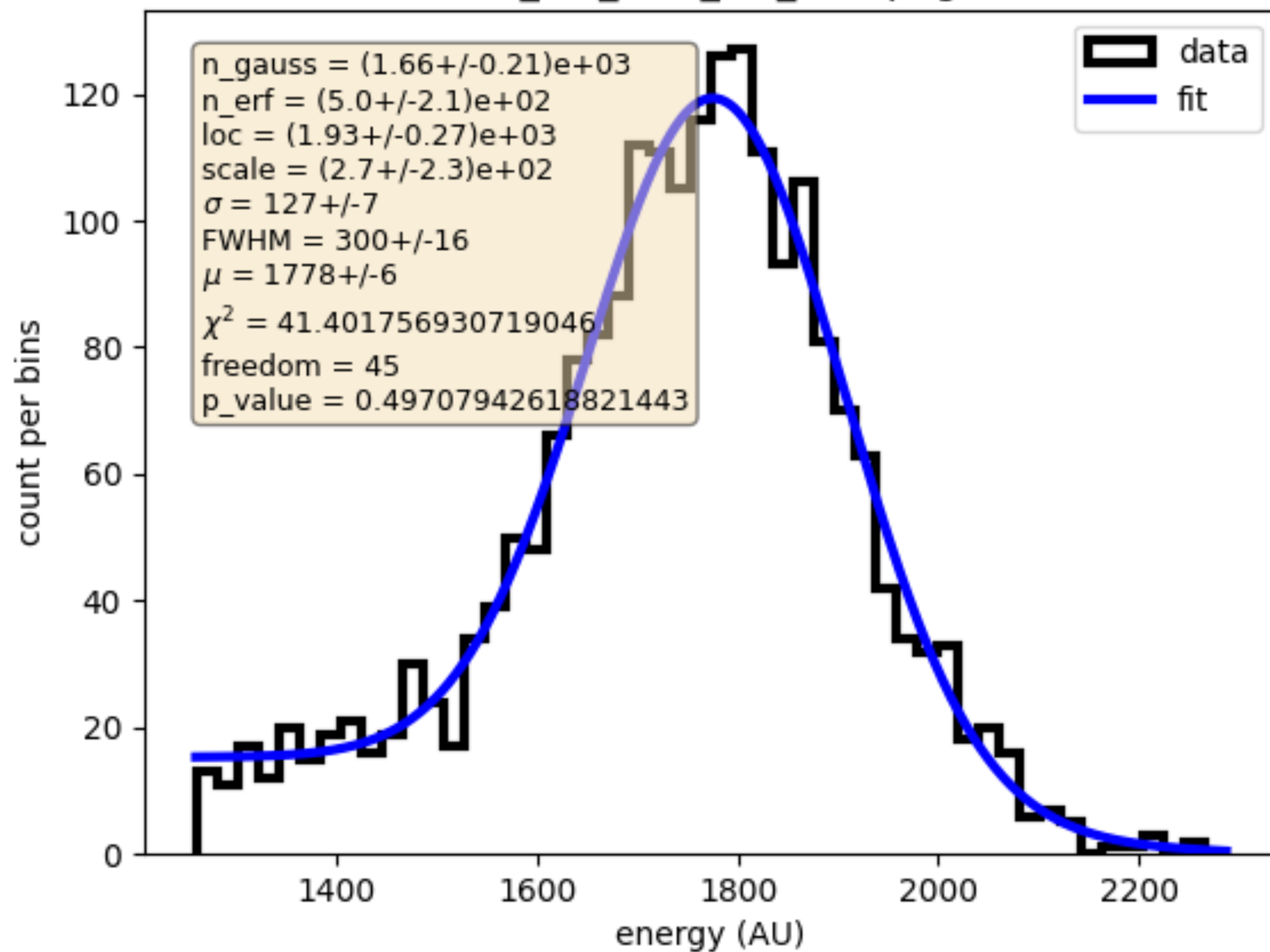

60° scattering
582keV

LLT_KCl_3mL_1M_CH2.png

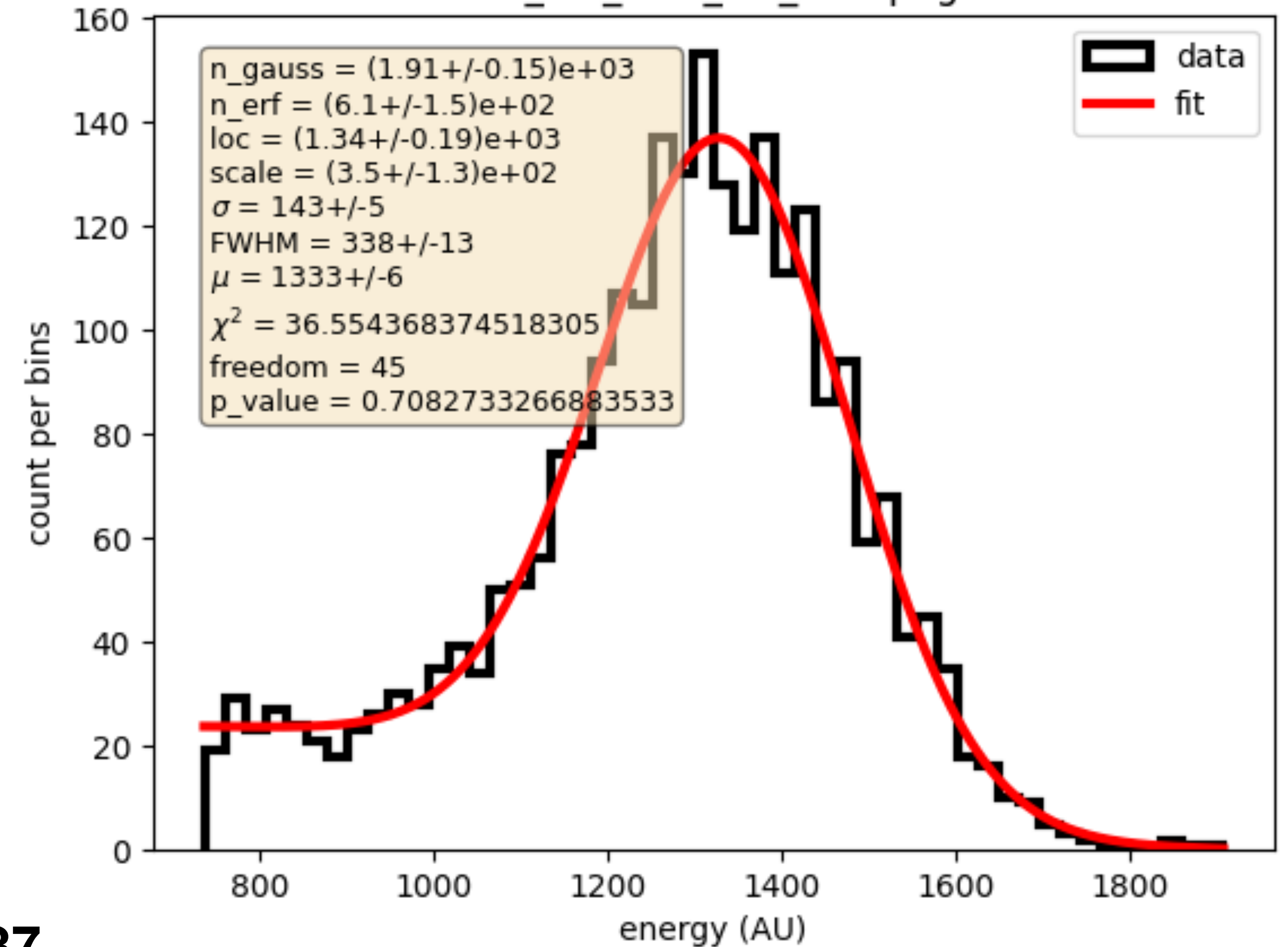

Liquid scintillation study Campaign

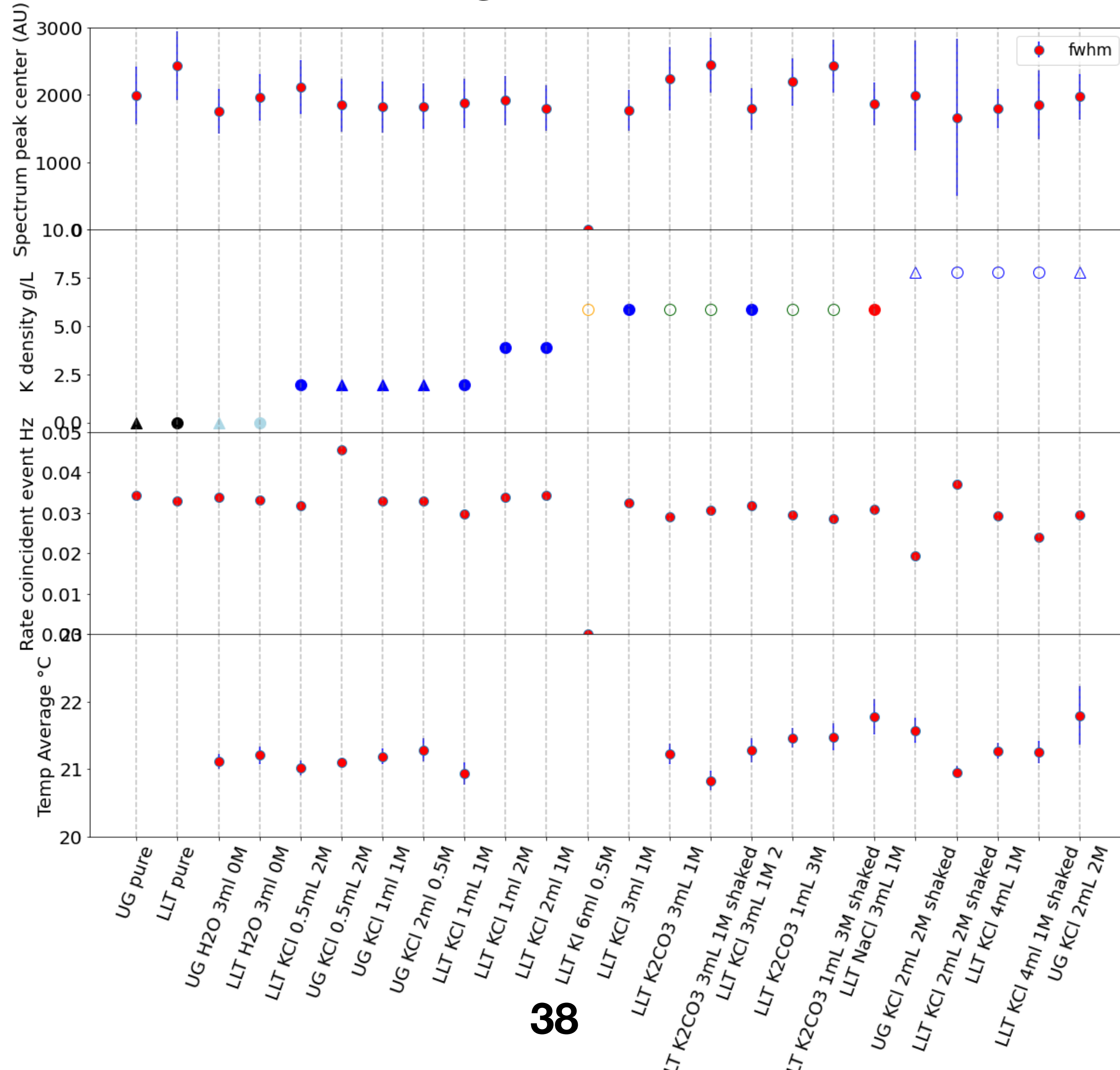

Liquid scintillation study Campaign

Quantitative results: LLT 3mmol

exp_peak_764keV, exp_peak_582keV by Main_name

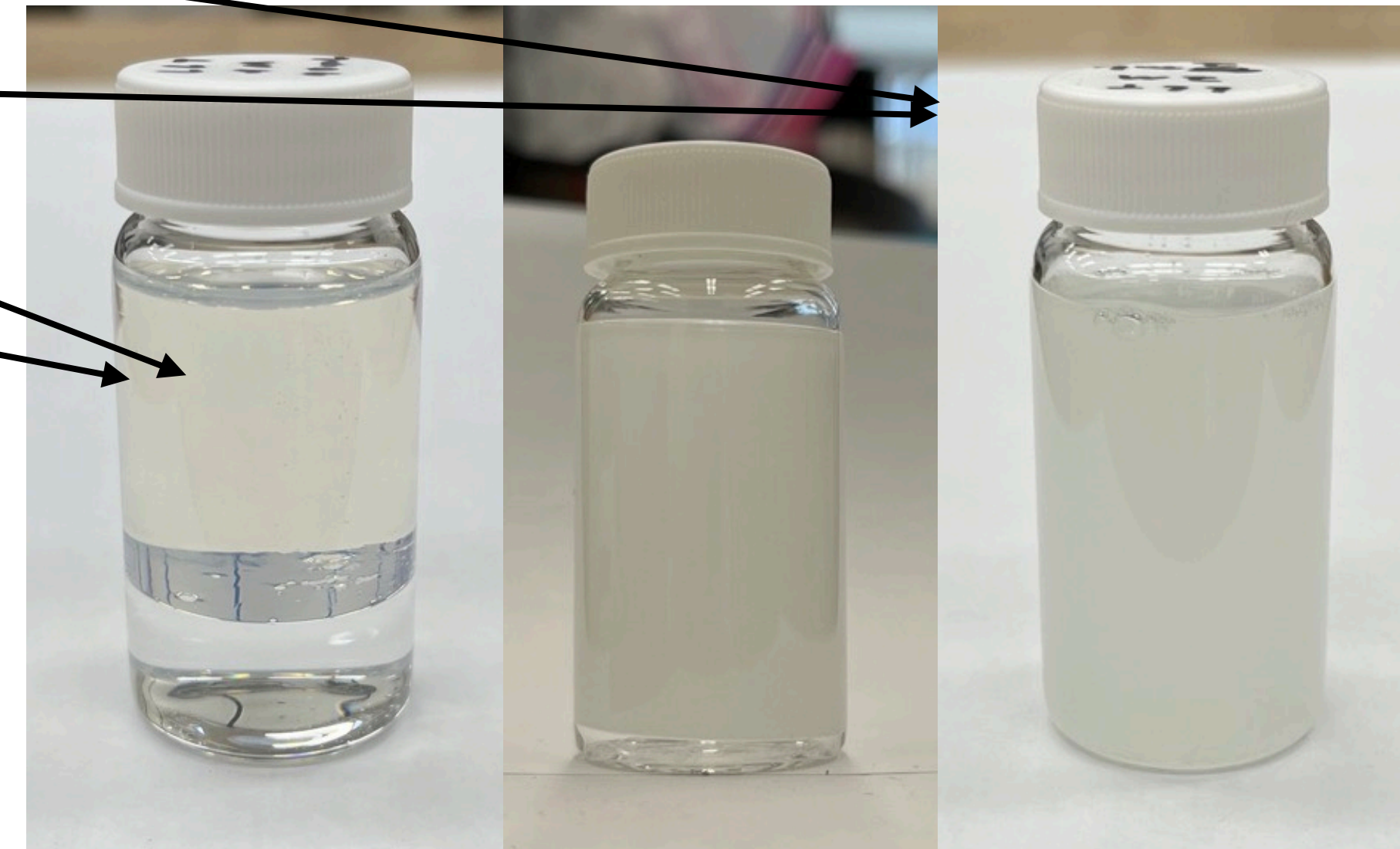
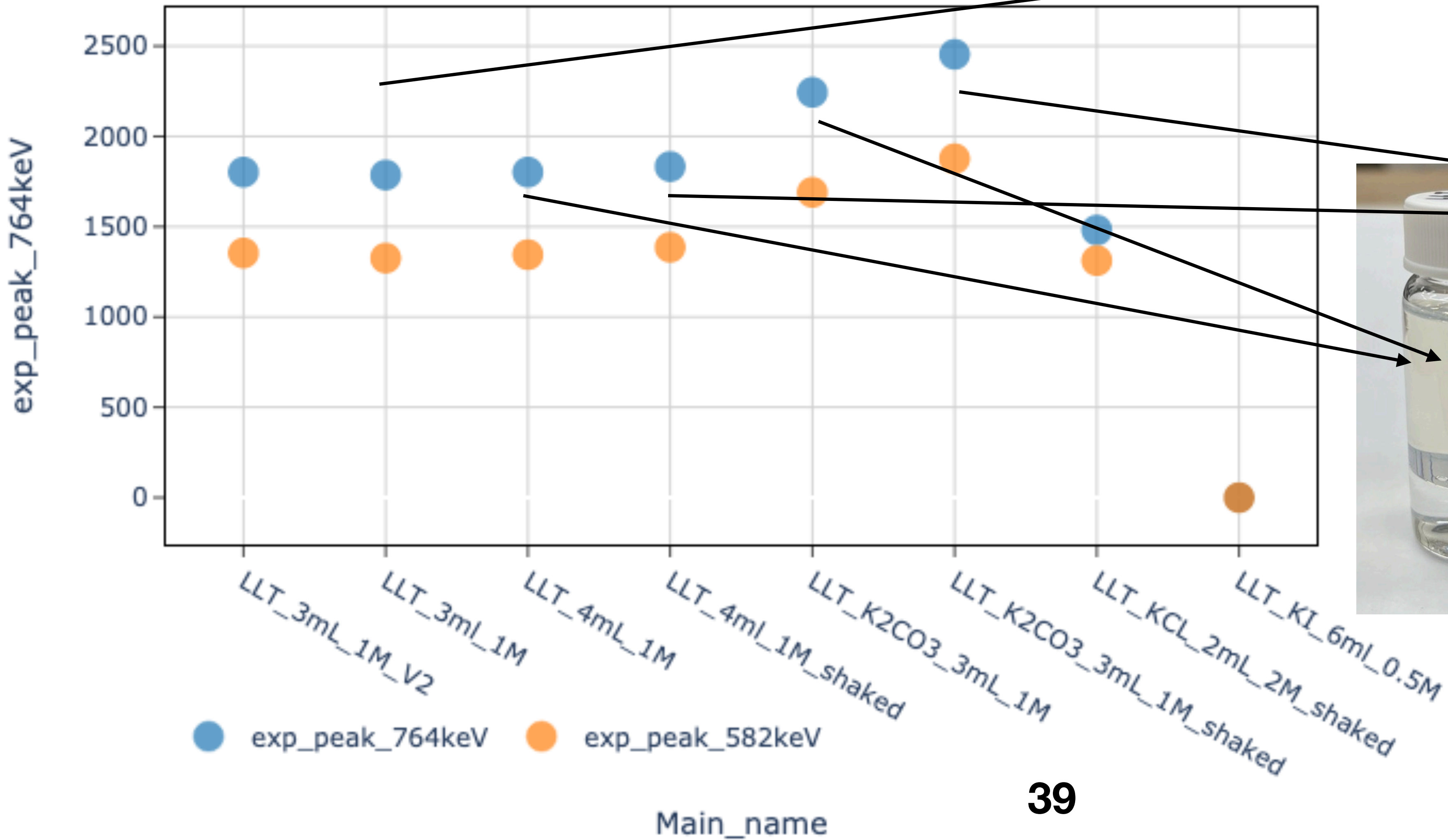

Liquid scintillation study Campaign

Quantitative results: UG vs LLT

exp_peak_764keV, exp_peak_582keV by Main_name

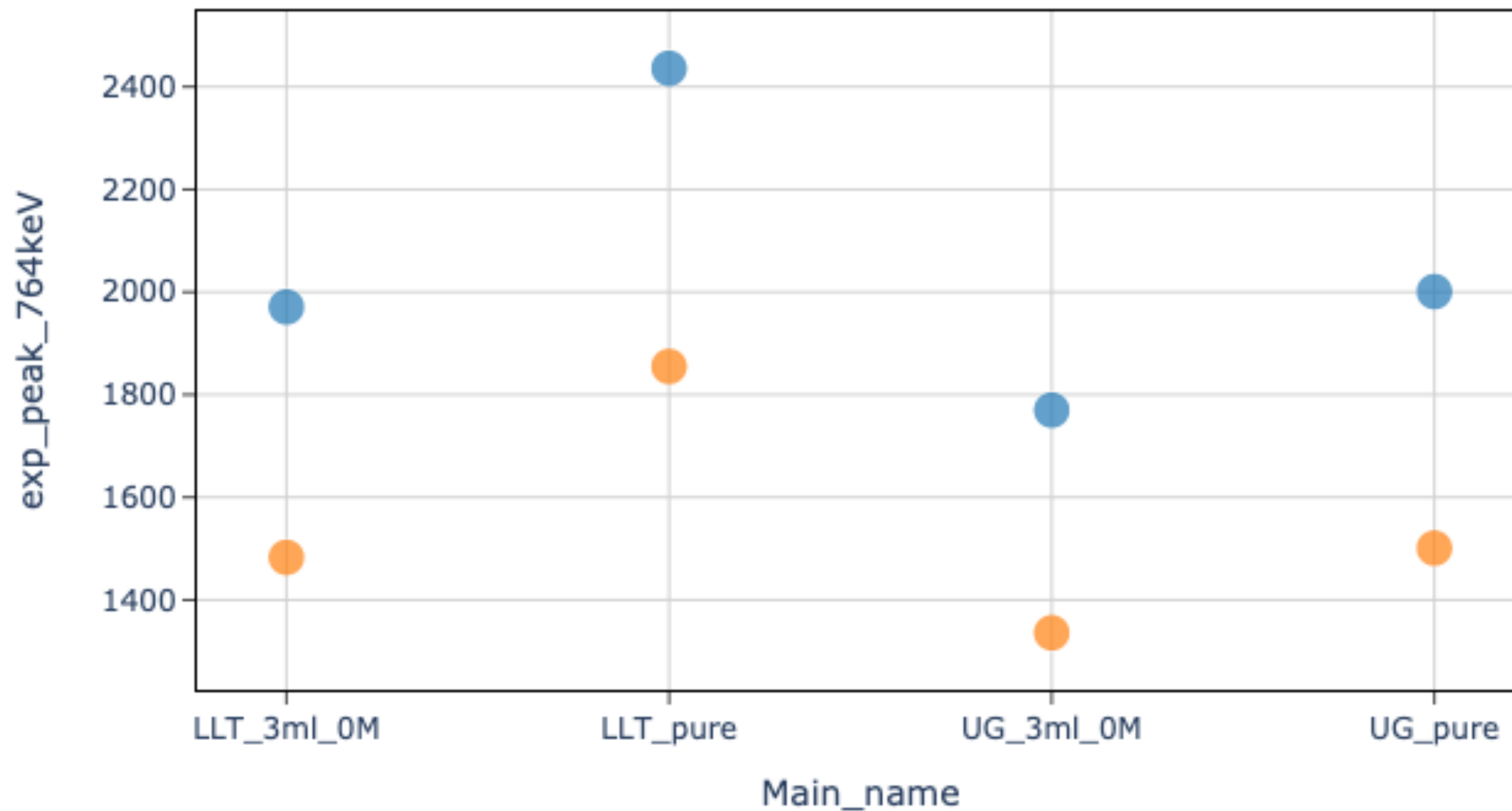

- Ultima Gold LLT has a better relative light yield
- Ultima Gold LLT diluted with water lose some light yield but less than UG does

● exp_peak_764keV ● exp_peak_582keV

Annulus PMT - New socket - 4 crystals comparison

1300 positive high voltage

Annulus spectra with new amplified sockets

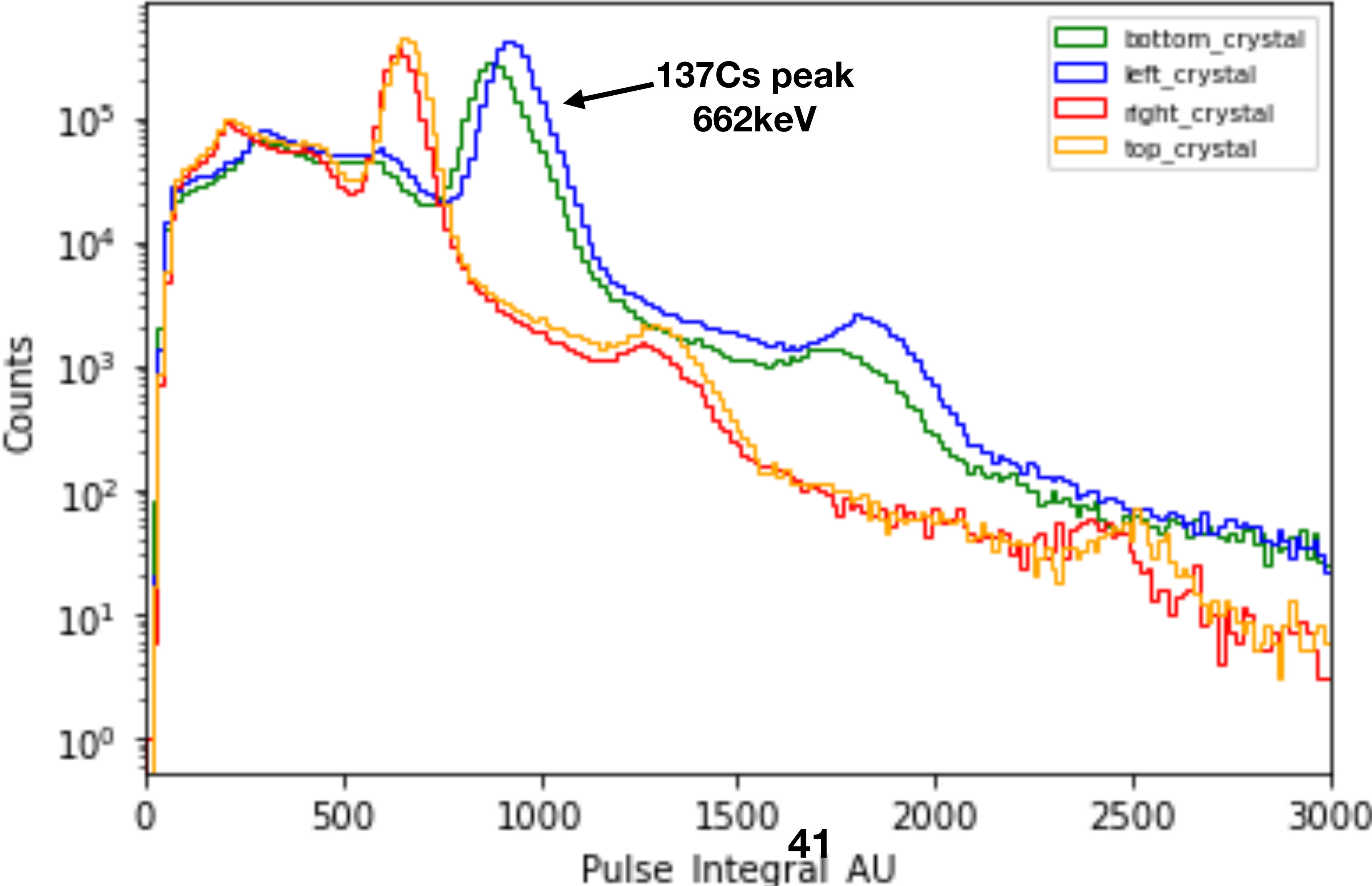

Simulation

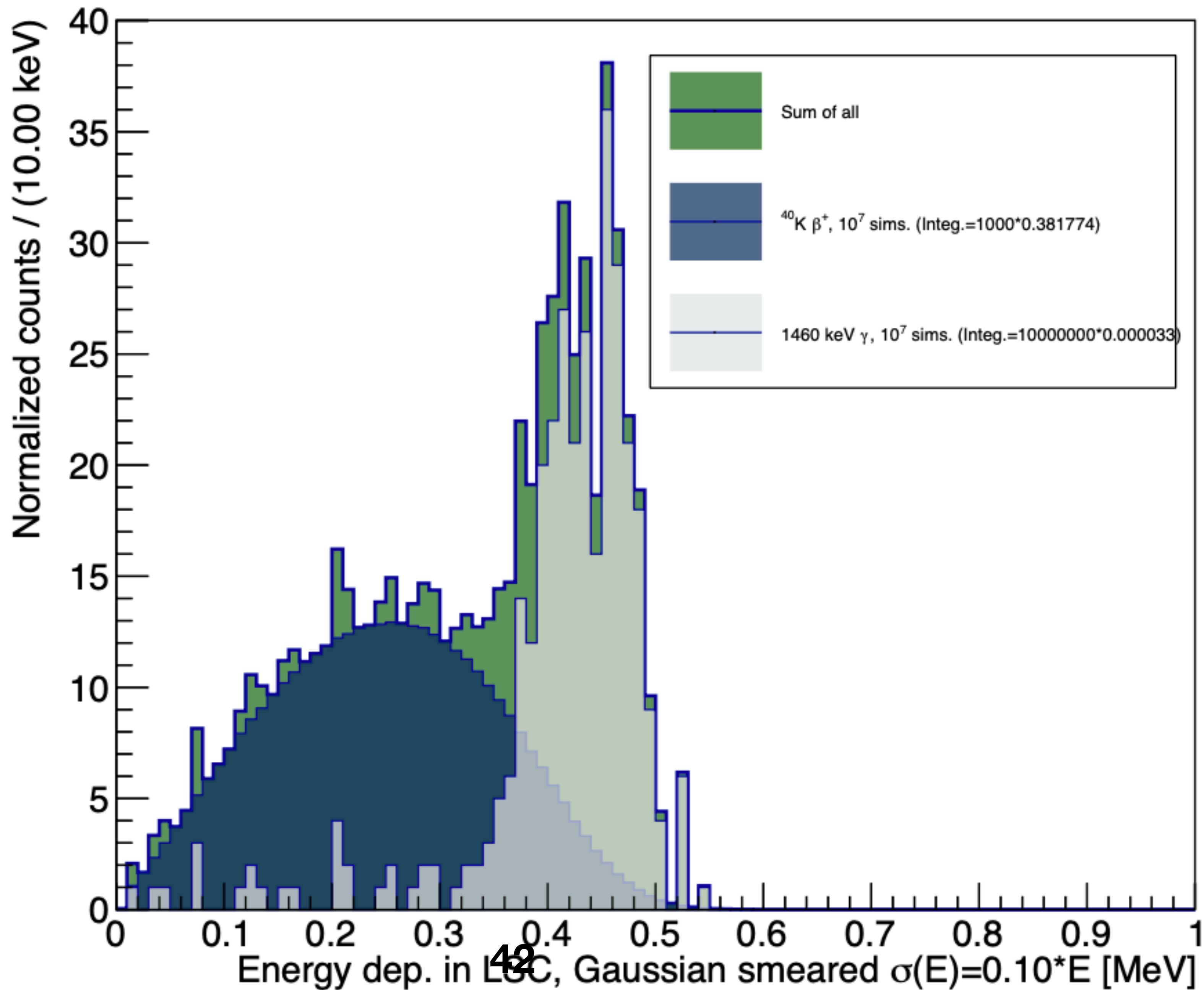

Simulation

β^+ sims have 10^6 events, 1460 keV γ sims have 10^7 . LSC volume in first two rows is almost identical.

Model	Triple-coincidence efficiency (%)	
	$^{40}\text{K } \beta^+$	1460 keV γ
Glass vial with plastic housing	≈ 40	$\approx 3 \times 10^{-3}$
Teflon housing (new)	38.38	3.9×10^{-3}
Teflon with $2\times$ volume (via length)	36.55	4.14×10^{-3}
Teflon with $2\times$ volume (via radius)	34.74	4.13×10^{-3}

With $I_{\beta^+} \sim 10^{-5}$, $I_{\gamma} \sim 0.1$: $\text{SNR} \sim 0.85 - 1$.

Gamma detector - MTAS at Michigan State University

- MTAS: Modular Total Absorption Spectrometer, at Facility of Rare Isotope Beam (FRIB).
- Consists of 19 NaI(Tl) hexagonal shaped detectors (53cm x 20cm) weighing in at ~54 kg each
- MTAS provides $\sim 4\pi$ coverage on tagging the 1460 keV gammas

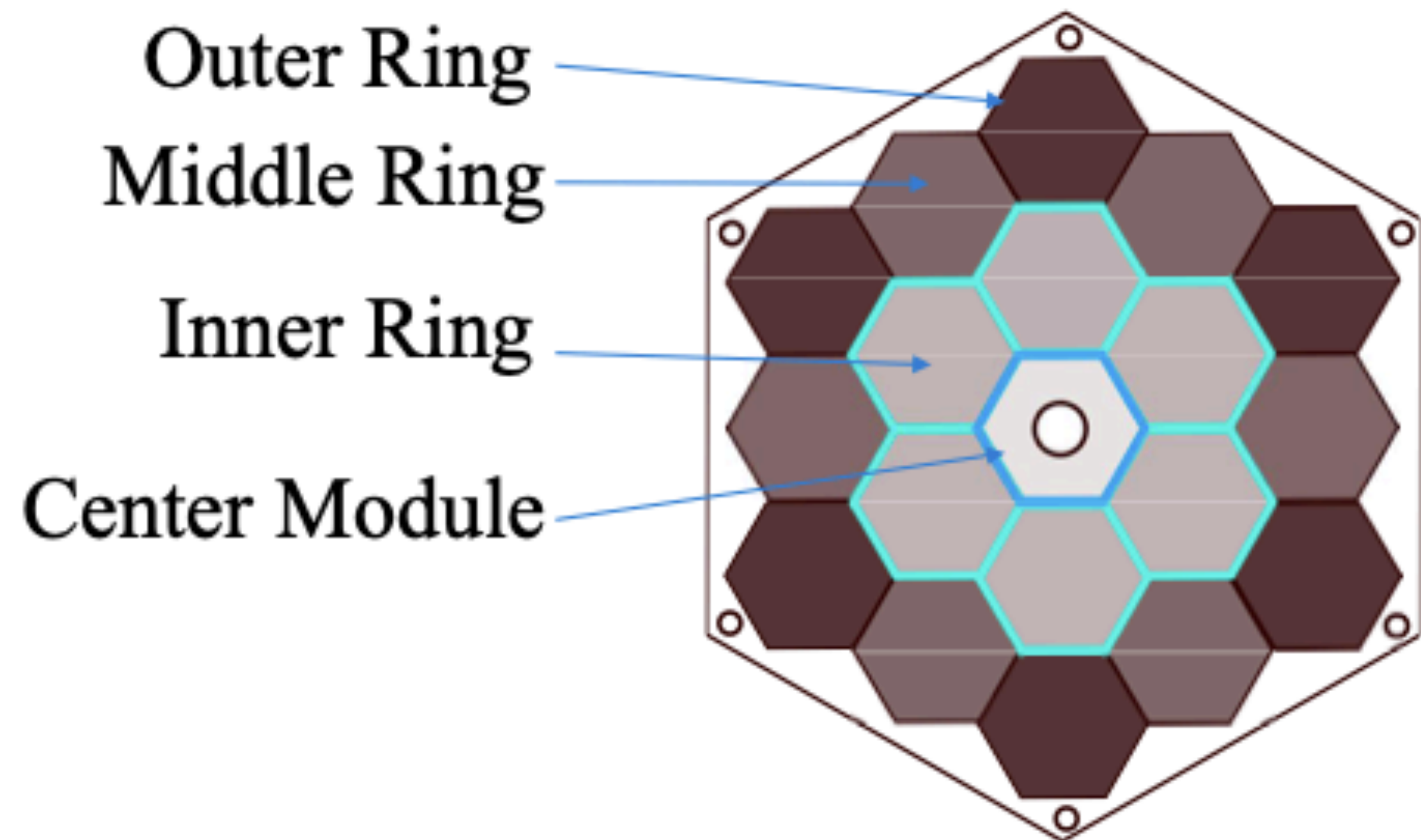
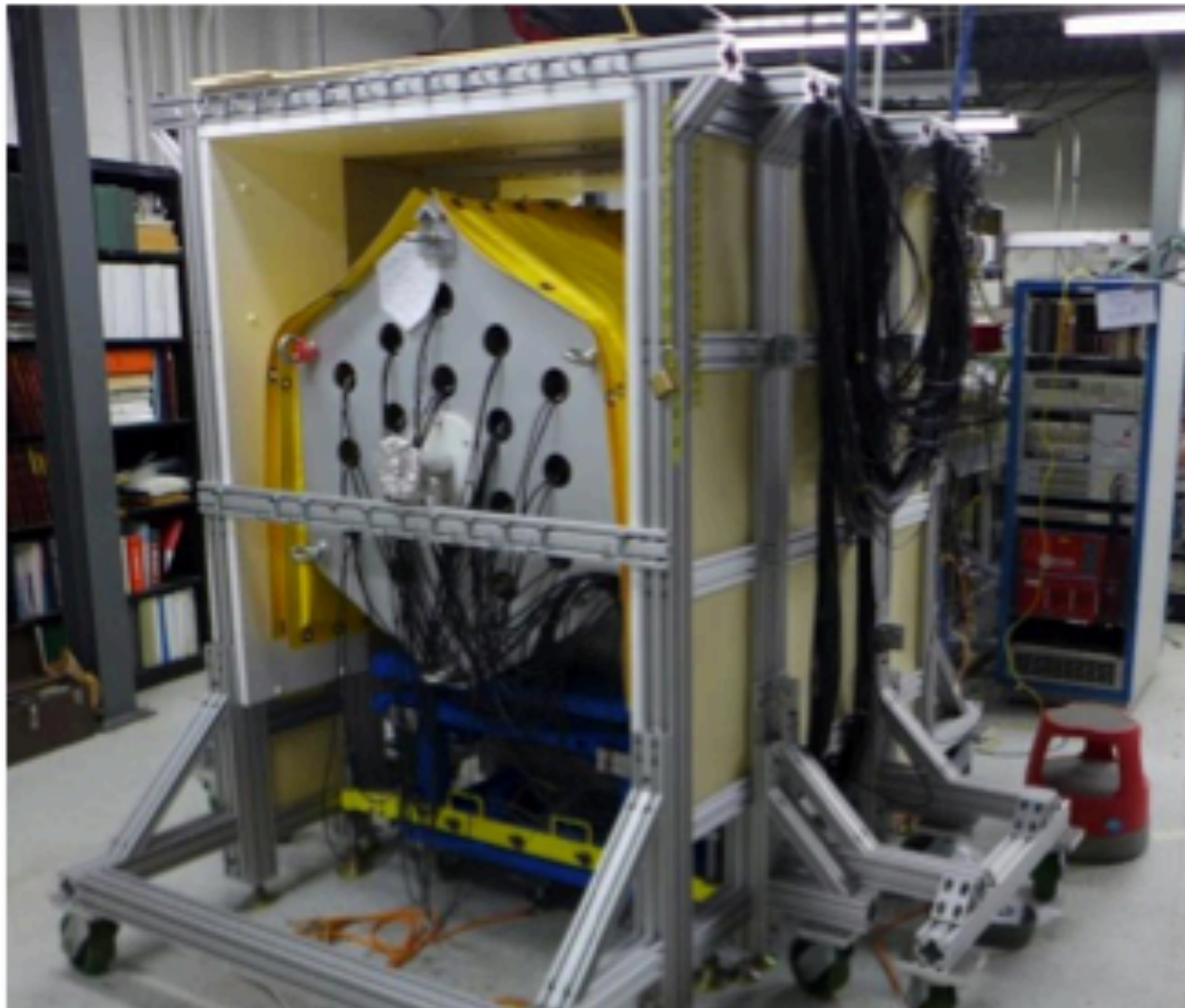

Source: Matthew Stukel, KDK, 2023/08/30

Annulus PMT - New socket - bottom crystal

^{137}Cs source

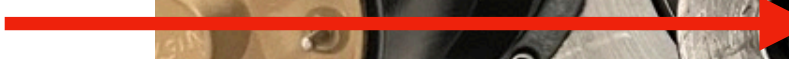

Iron collimator

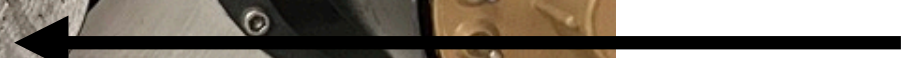

New socket

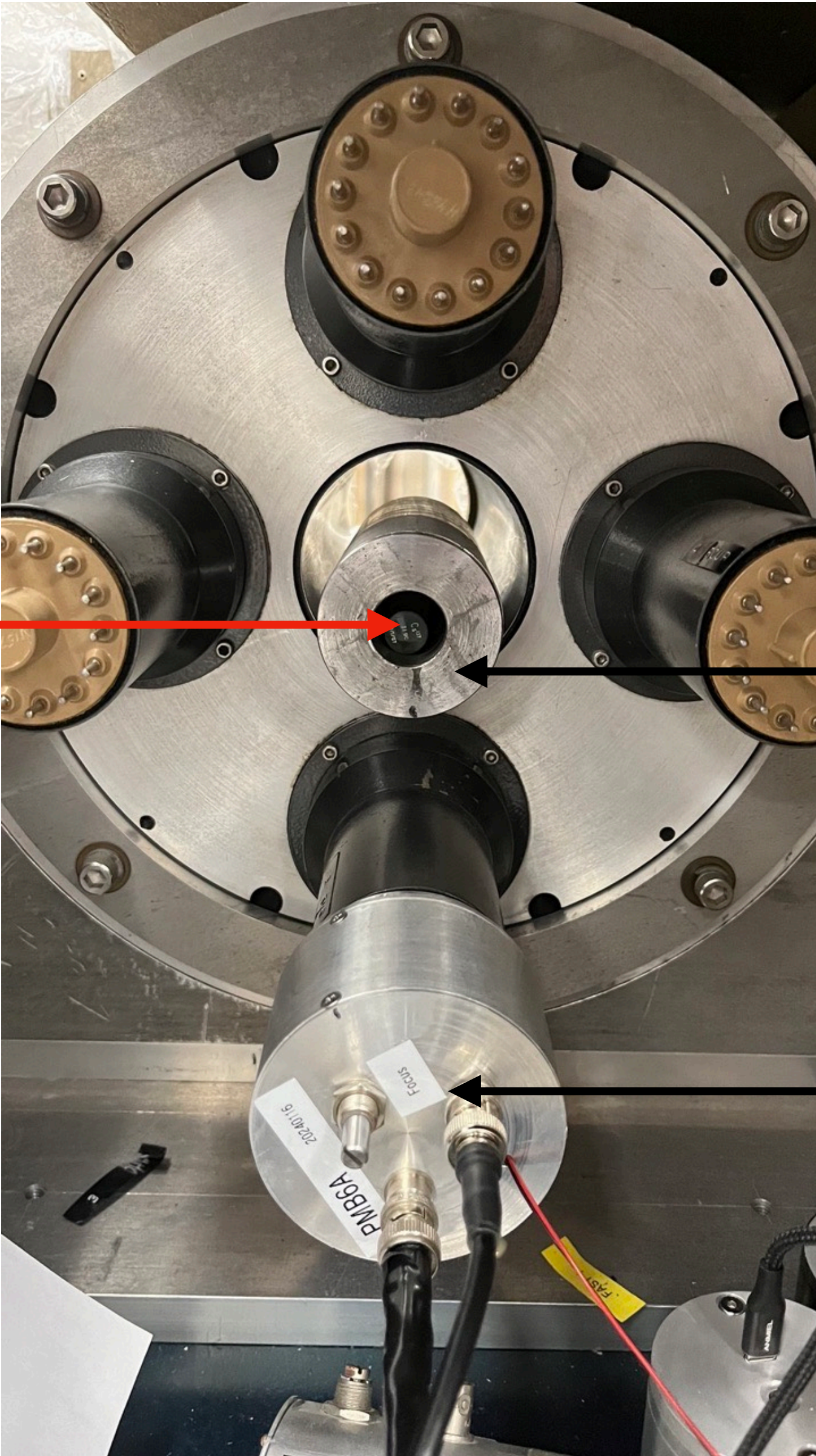
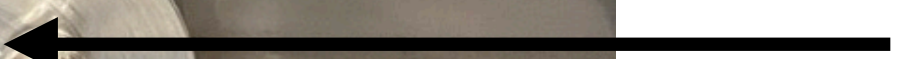

Annulus PMT - New socket - bottom crystal

1300 positive high voltage - ^{137}Cs source

Annulus spectra with new amplified sockets on bottom PMT

/Users/arnaudlemaire/ECL/Queens/Experiment/LS/annulus/2024/new_DAQ/study_waveform/
& DAQ/bottomPMT_bg/RAW/SDataR_bottomPMT_bg.CSV
& geometry/bottomPMT_137Cs_coli_avant2/RAW/SDataR_bottomPMT_137Cs_coli_avant2.CSV
& geometry/bottomPMT_137Cs_coli_milieu/RAW/SDataR_bottomPMT_137Cs_coli_milieu.CSV
& geometry/bottomPMT_137Cs_coli_fond/RAW/SDataR_bottomPMT_137Cs_coli_fond.CSV
& DAQ/bottomPMT_137Cs_nocoli/RAW/SDataR_bottomPMT_137Cs_nocoli.CSV

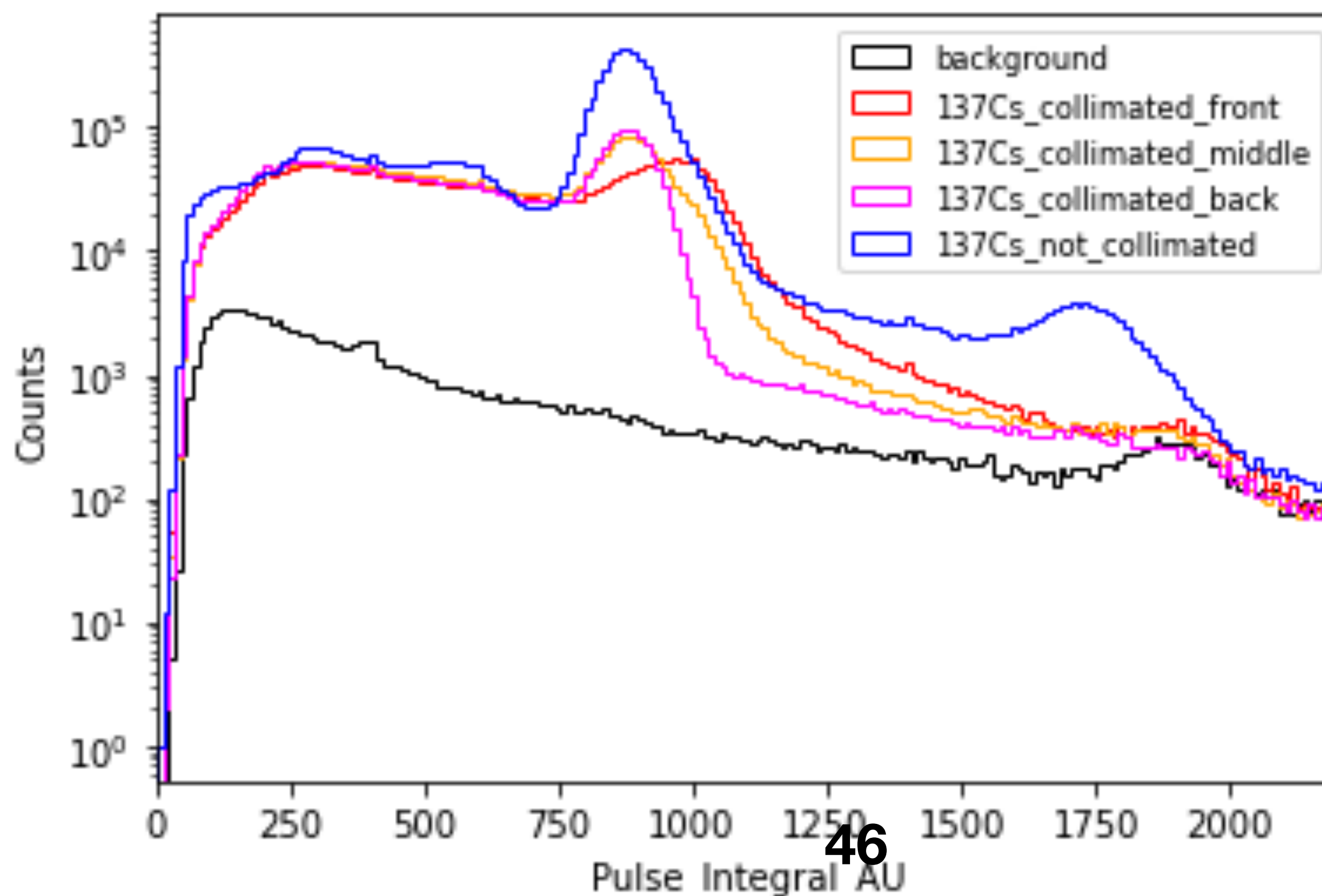

Teflon Vessel in the annulus - Gamma Compton coincidences

LSC_Energy_Deposition_Coincidence
/Volumes/KDK+_Arnaud/KDK+/teflon_vessel/annulus2/
es/KDK+_Arnaud/KDK+/teflon_vessel/annulus2/le_source_under/RAW/SDataR_le_source_under_coi
es/KDK+_Arnaud/KDK+/teflon_vessel/annulus2/le_source_above/RAW/SDataR_le_source_above_coi
bins=100

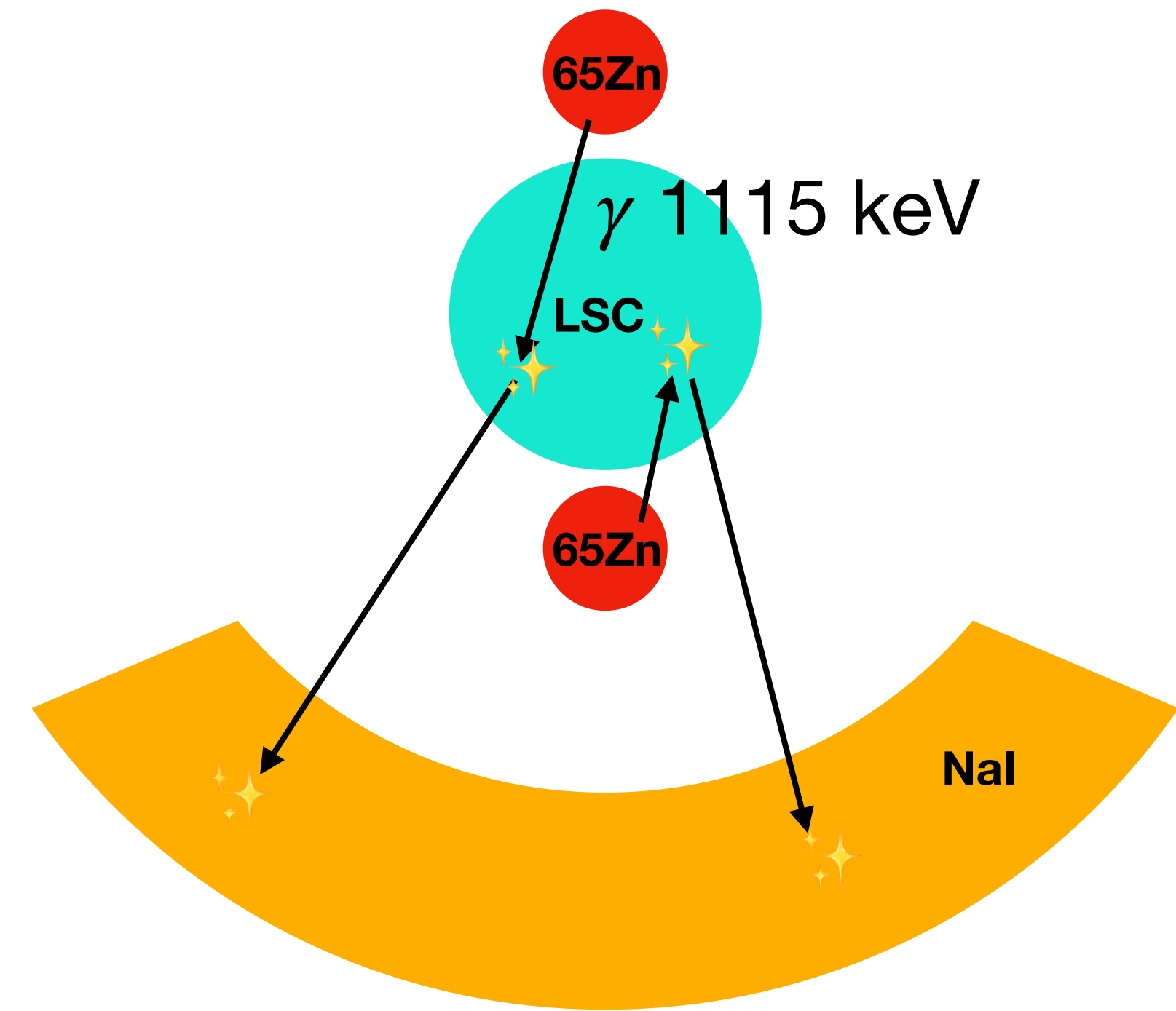
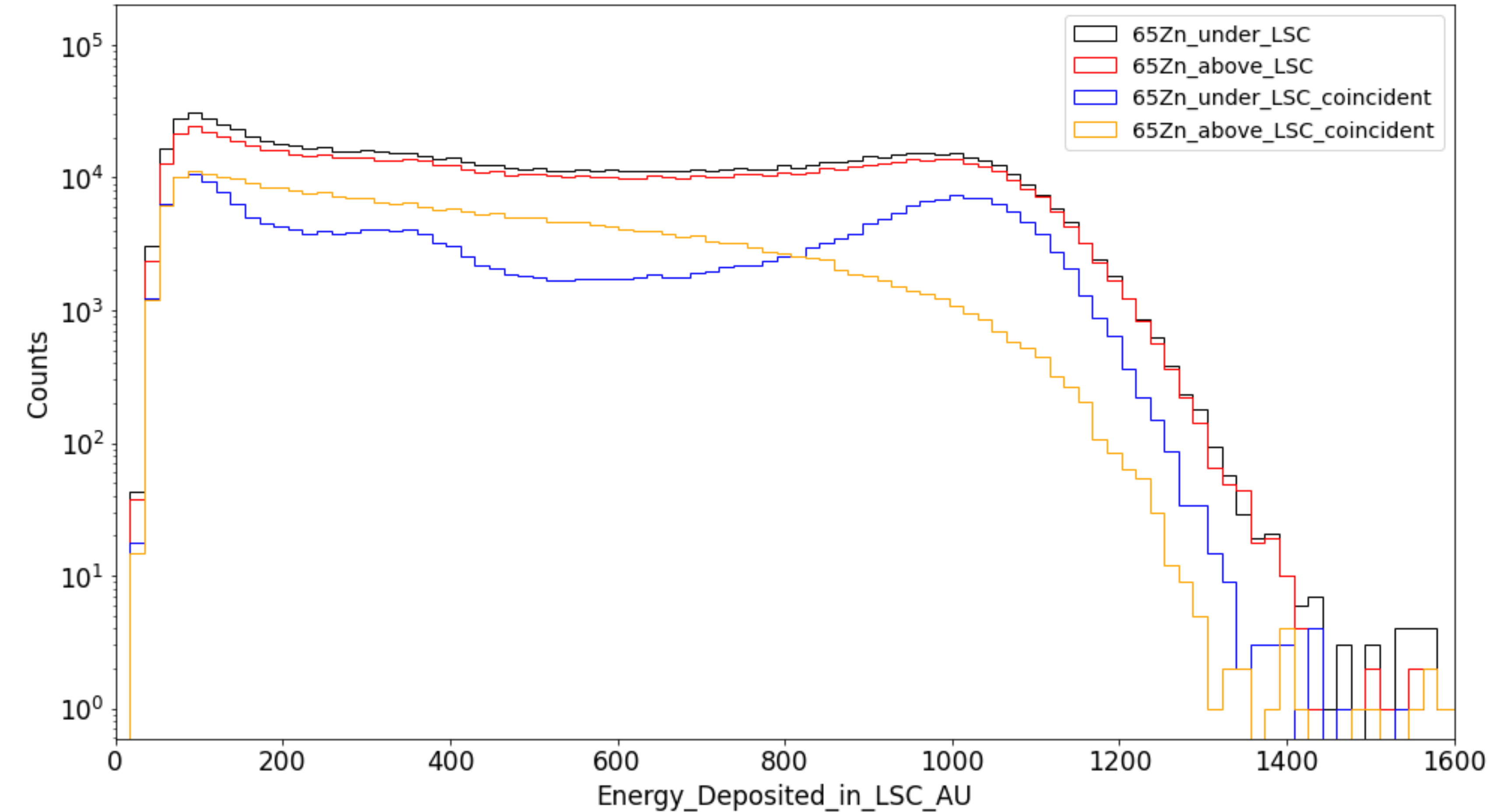

Teflon Vessel in the annulus - Gamma Compton coincidences

CoincidenceTime_NaI_annulus_Teflon_vessel_65Zn_above_triggering_parameter

/Volumes/KDK+_Arnaud/KDK+/teflon_vessel/annulus2/

& le_source_above/RAW/SDataR_le_source_above_coinSorted.csv

& cfd_source_above/RAW/SDataR_cfd_source_above_coinSorted.csv

& cfd_source_above_param_100p_200ns/RAW/SDataR_cfd_source_above_param_100p_200ns_coinSorted.csv

& cfd_source_above_param_100p_300ns/RAW/SDataR_cfd_source_above_param_100p_300ns_coinSorted.csv

& cfd_source_above_param_75p_200ns_1/RAW/SDataR_cfd_source_above_param_75p_200ns_1_coinSorted.csv

darkblue curve = 288864 events
darkred curve = 225910 events
darkgreen curve = 268306 events
darkmagenta curve = 276036 events
saddlebrown curve = 234093 events
bins=200

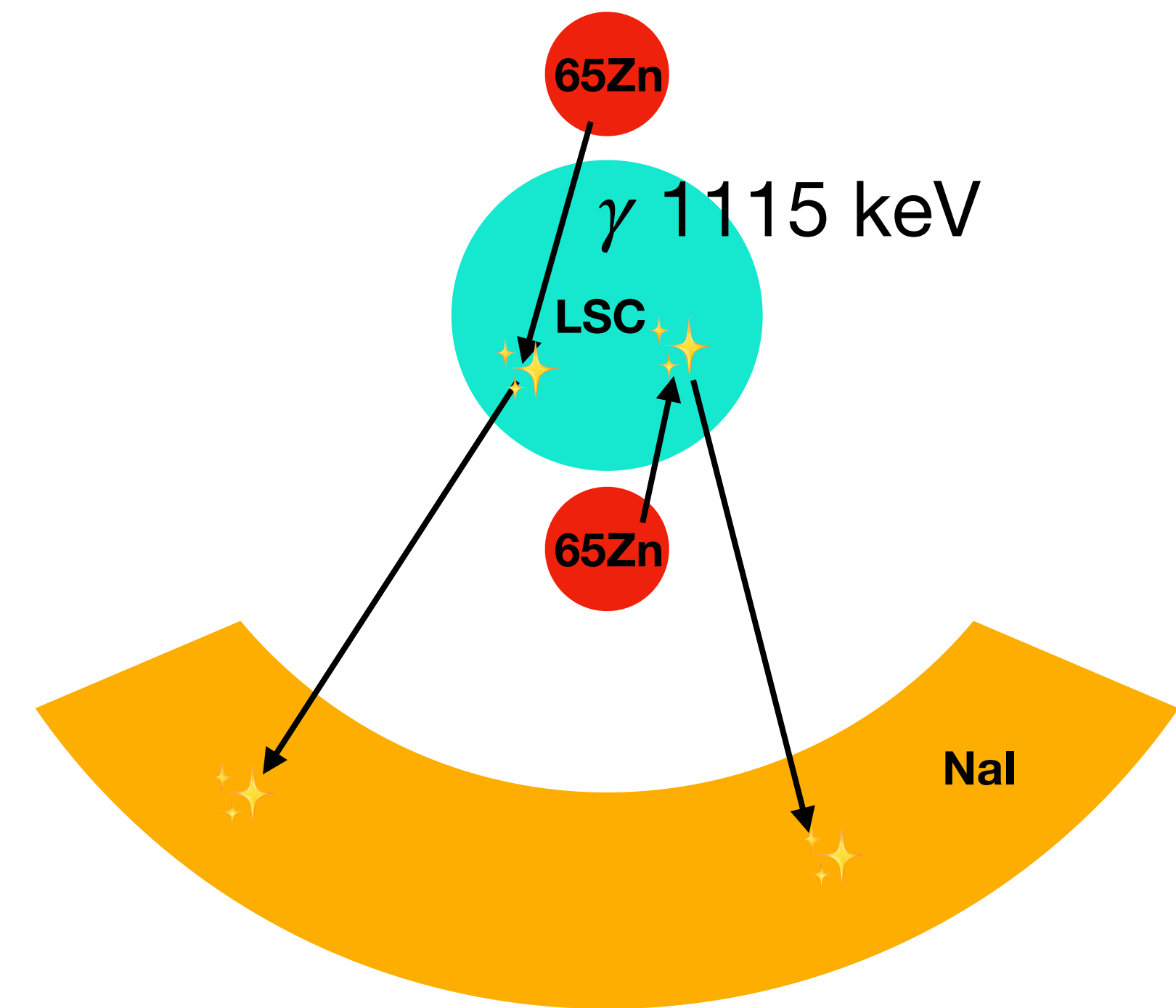
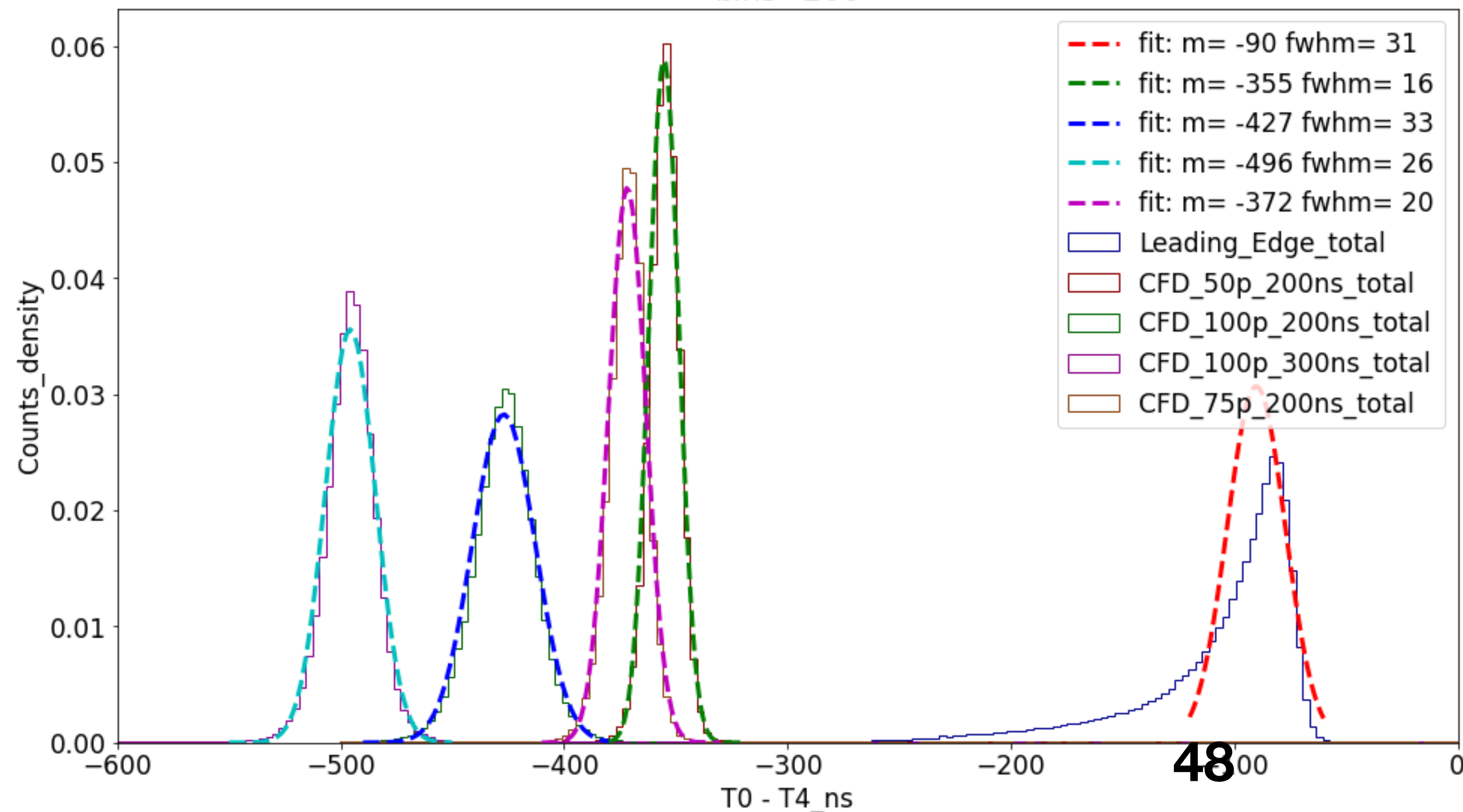

Teflon Vessel in the annulus - Gamma Compton coincidences

Nal_spectra_annulus_coincidence_Teflon_vessel_65Zn_above_triggering_parameter
/Volumes/KDK+_Arnaud/KDK+/teflon_vessel/annulus2/

& le_source_above/RAW/SDataR_le_source_above_coinSorted.csv

& cfd_source_above/RAW/SDataR_cfd_source_above_coinSorted.csv

& cfd_source_above_param_100p_200ns/RAW/SDataR_cfd_source_above_param_100p_200ns_coinSorted.csv

& cfd_source_above_param_100p_300ns/RAW/SDataR_cfd_source_above_param_100p_300ns_coinSorted.csv

& cfd_source_above_param_75p_200ns_1/RAW/SDataR_cfd_source_above_param_75p_200ns_1_coinSorted.csv

bins=200

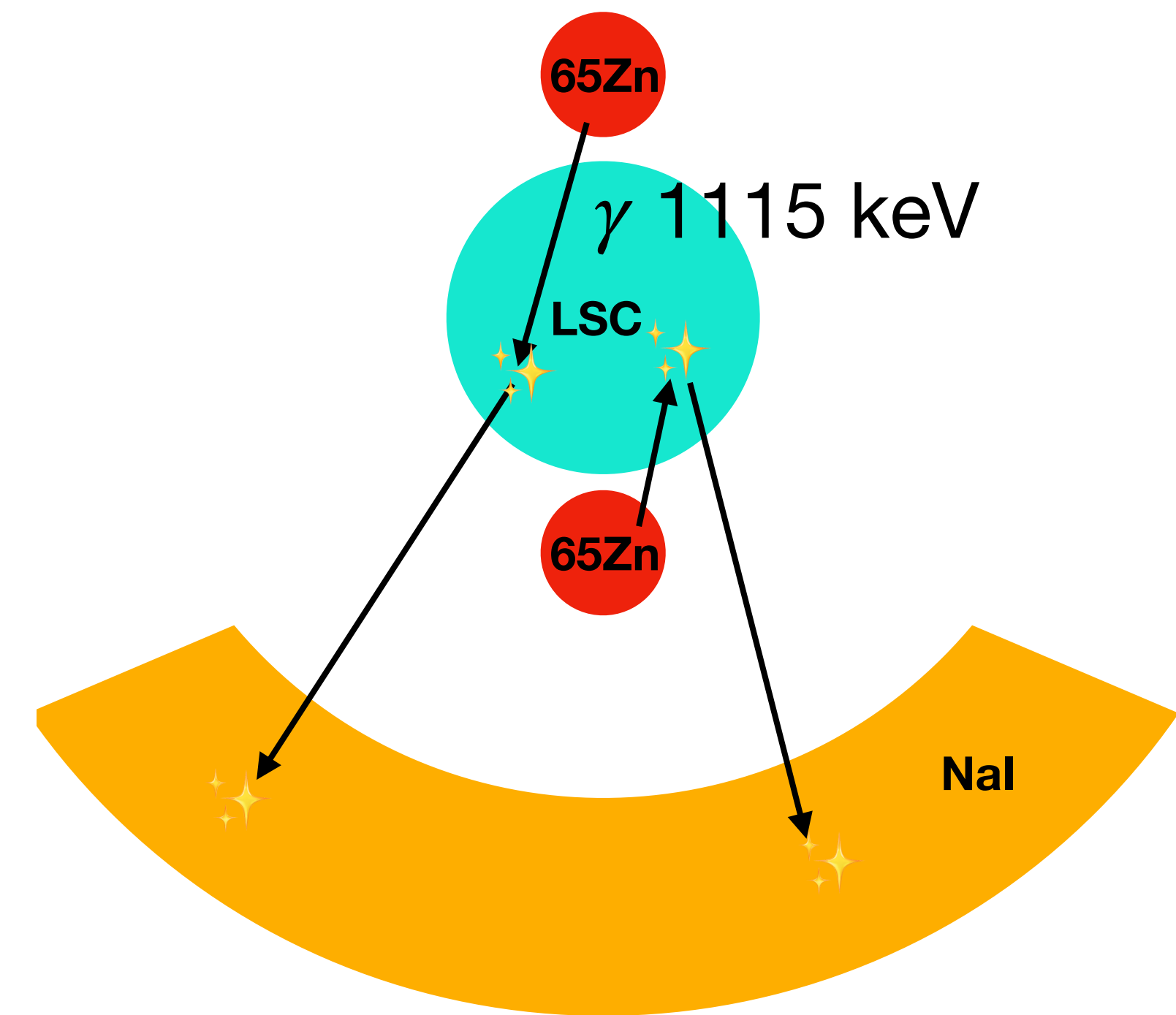
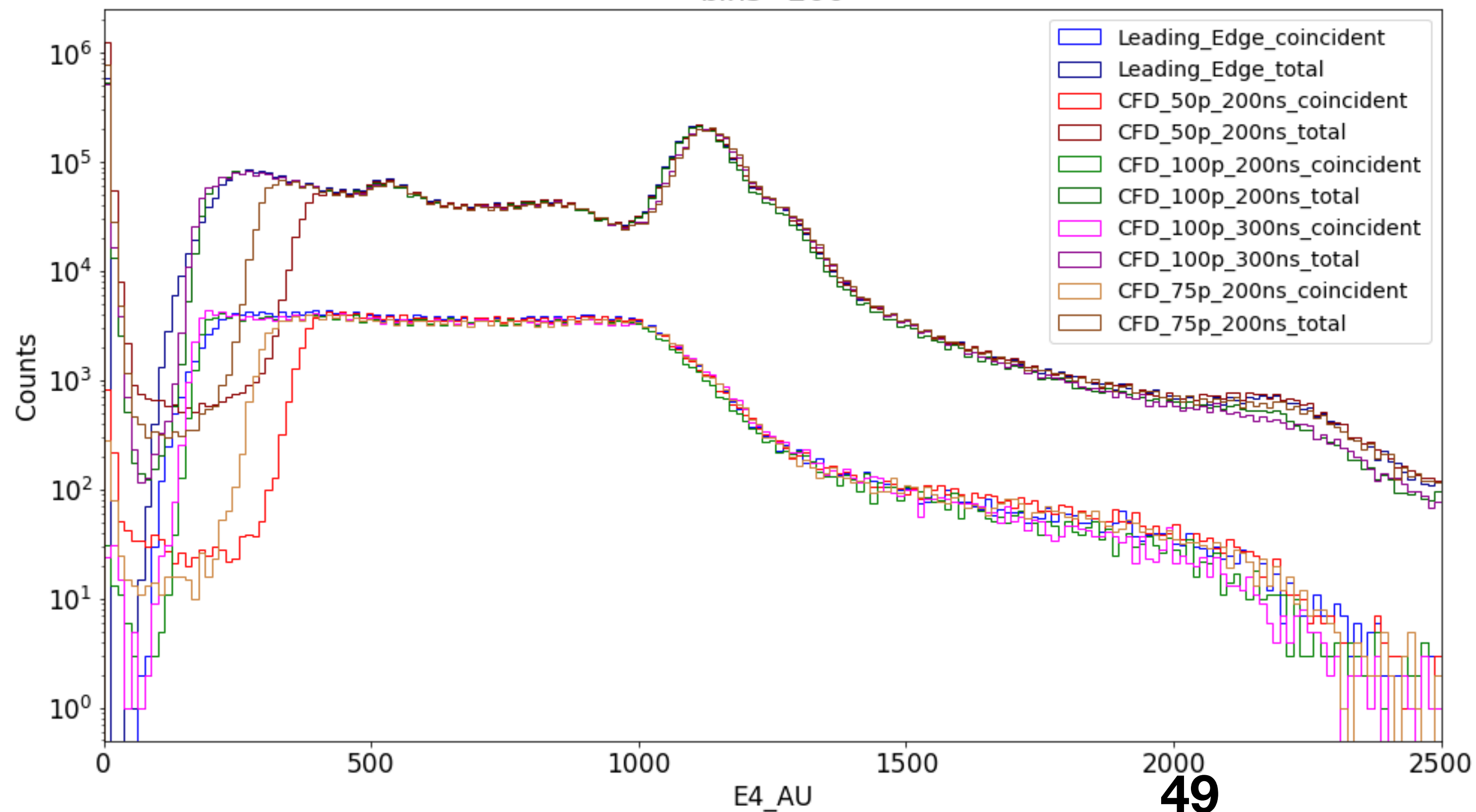

Time resolution and coincidence window

Teflon_vessel_65Zn_in_annulus
/Volumes/KDK+_Arnaud/KDK+/teflon_vessel/annulus2/
& cfd_source_above/RAW/SDataR_cfd_source_above_coinSorted.csv

red curve = 225910 events
orange curve = 225910 events
bins=200

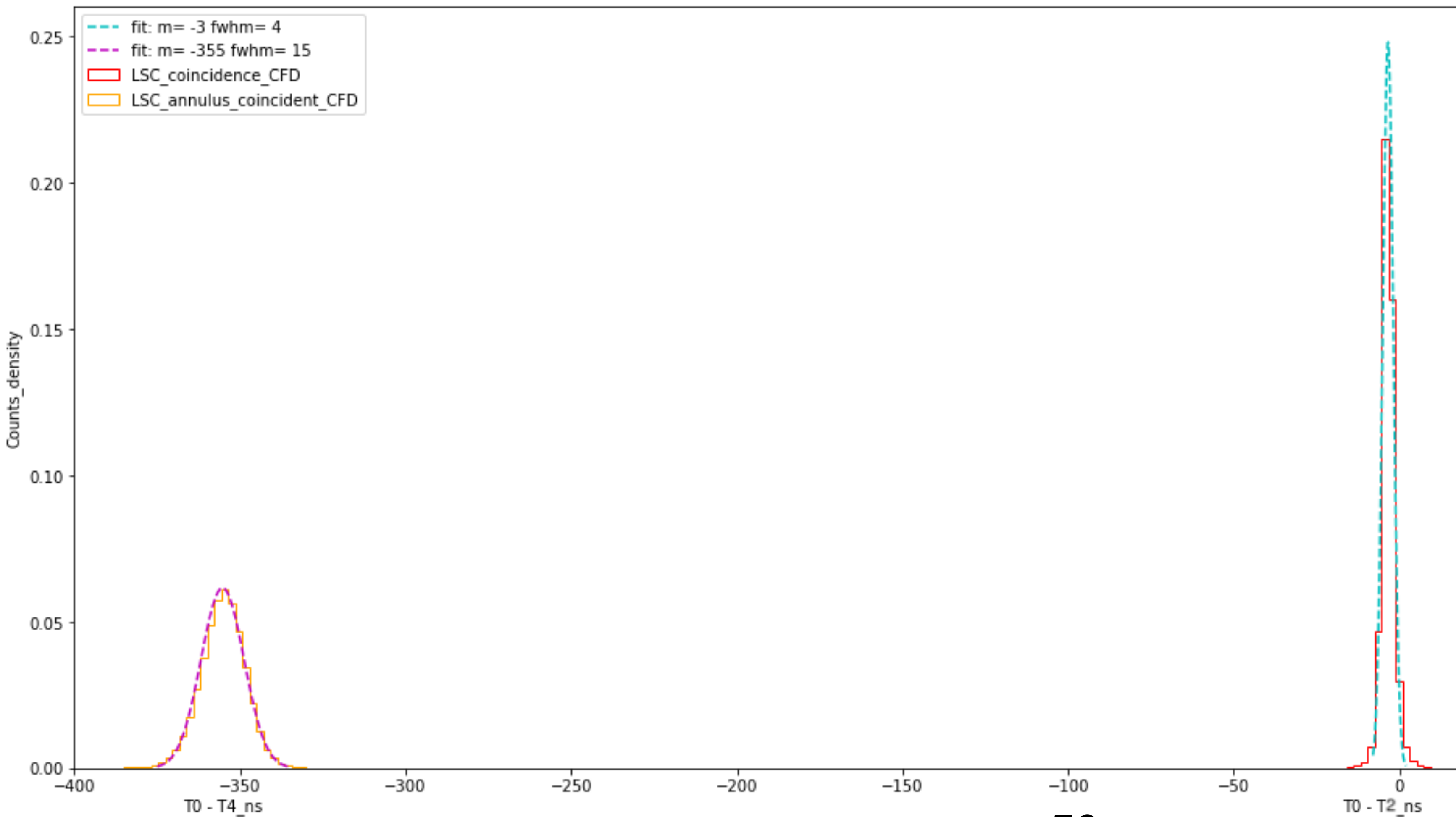

50

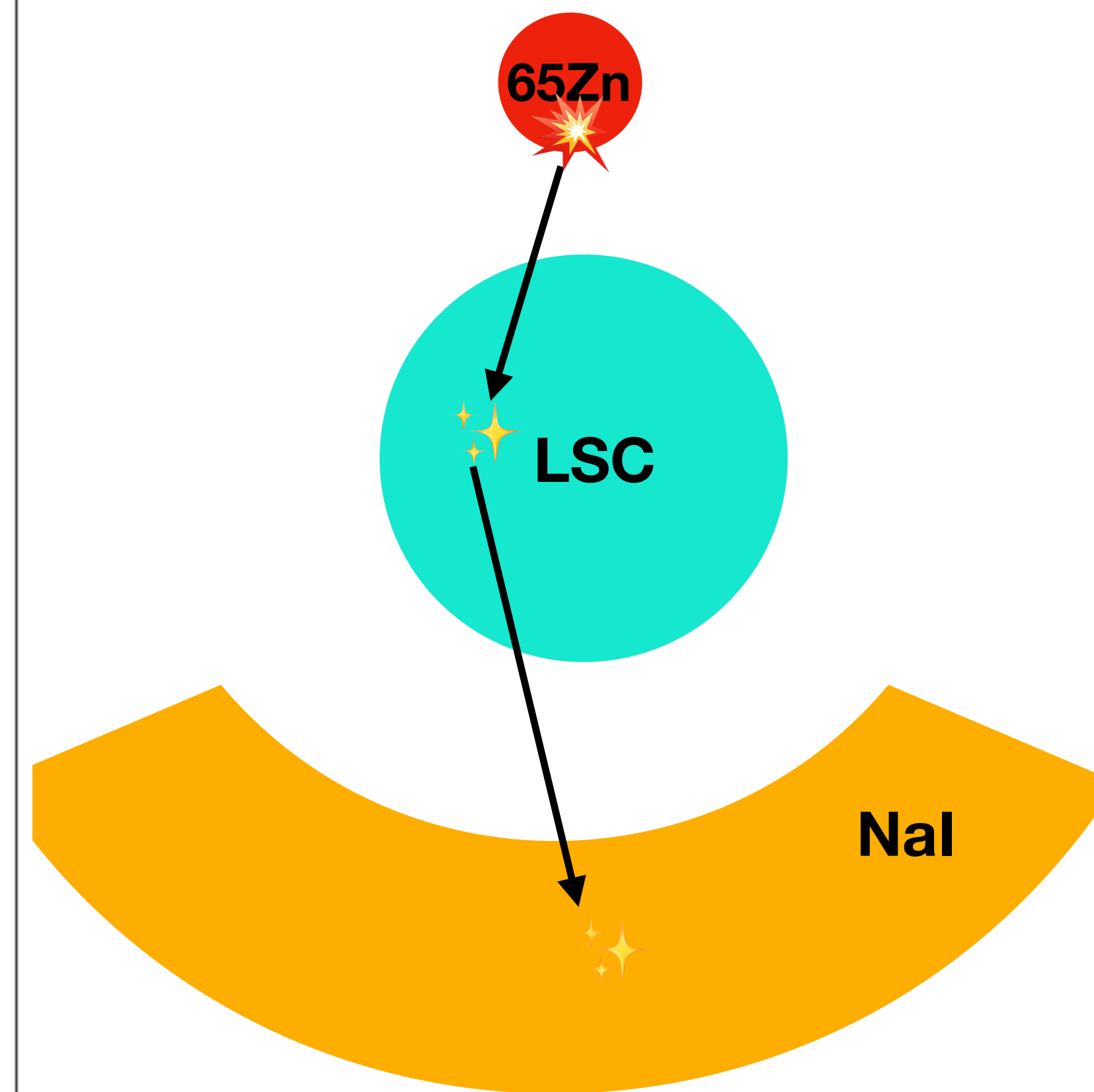

Triple coincidence efficiency

- Sodium very close chemically to potassium
 - ✓ Dissolve itself in the liquid scintillator the same way
- When a 1275 keV gamma is detected: 90.3% of the time, a beta particle is emitted and should be detected with two 511 keV back-to-back γ s
- Determine experimentally the efficiency

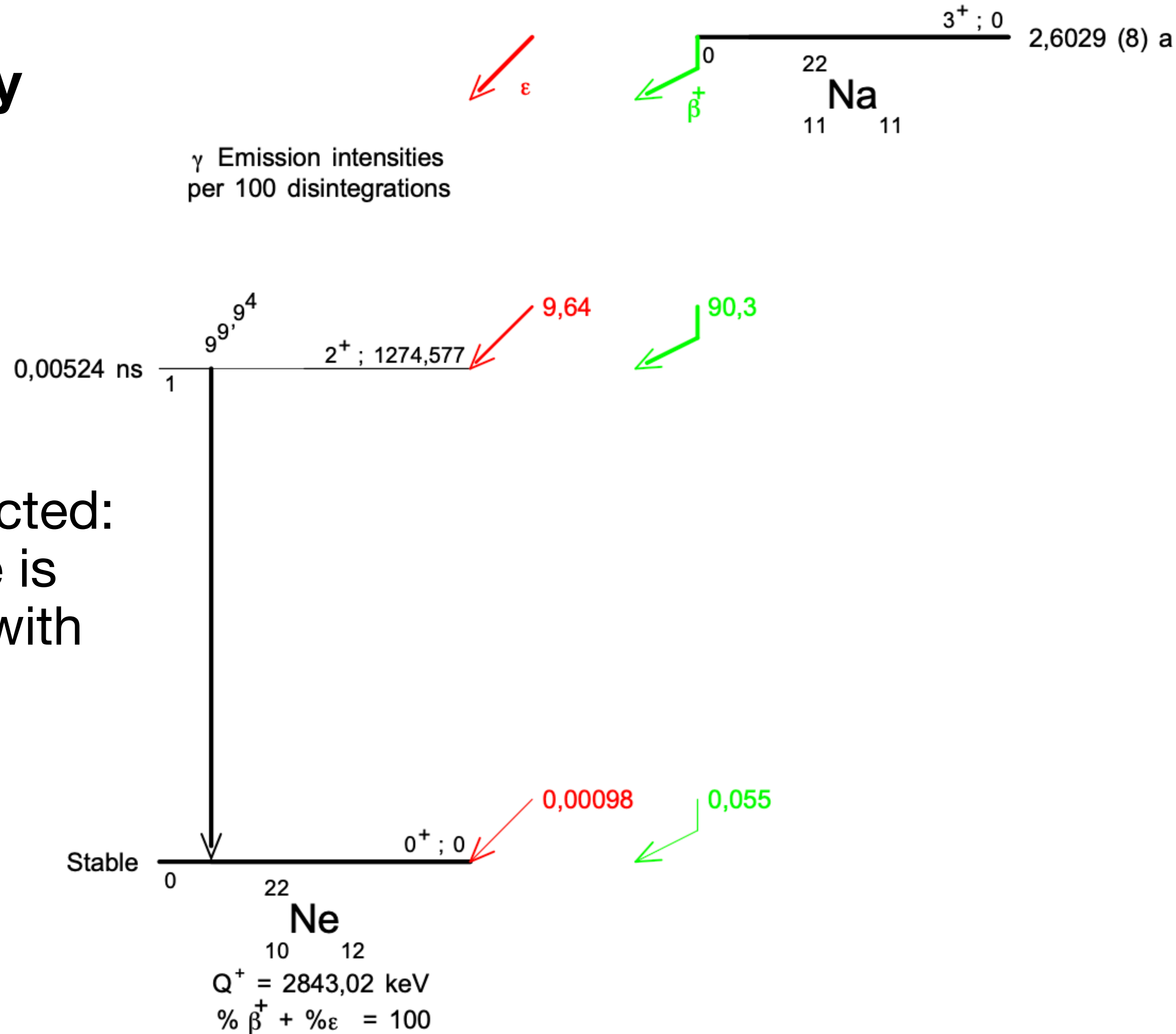

Annulus Efficiency - 2 crystals

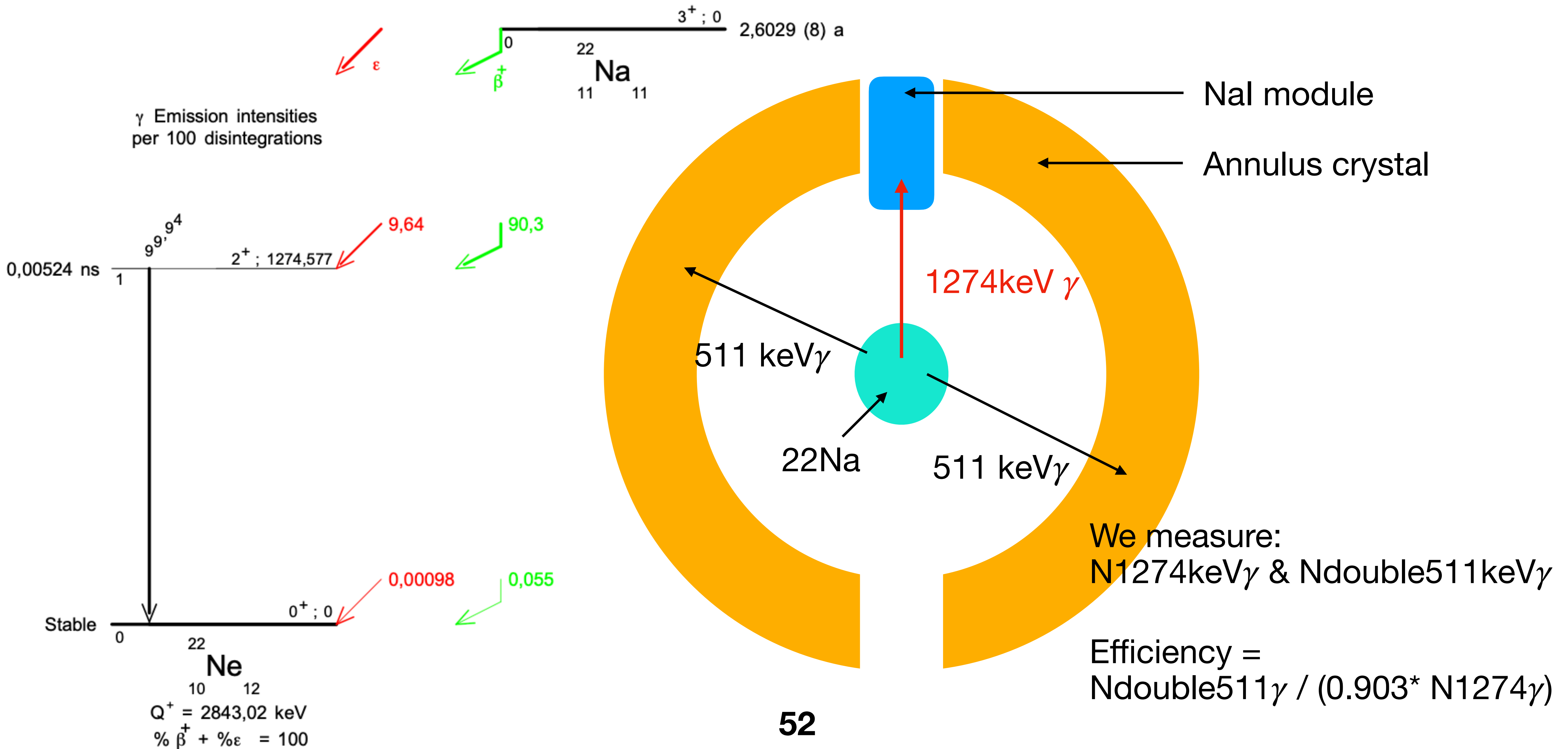

Teflon Vessel design

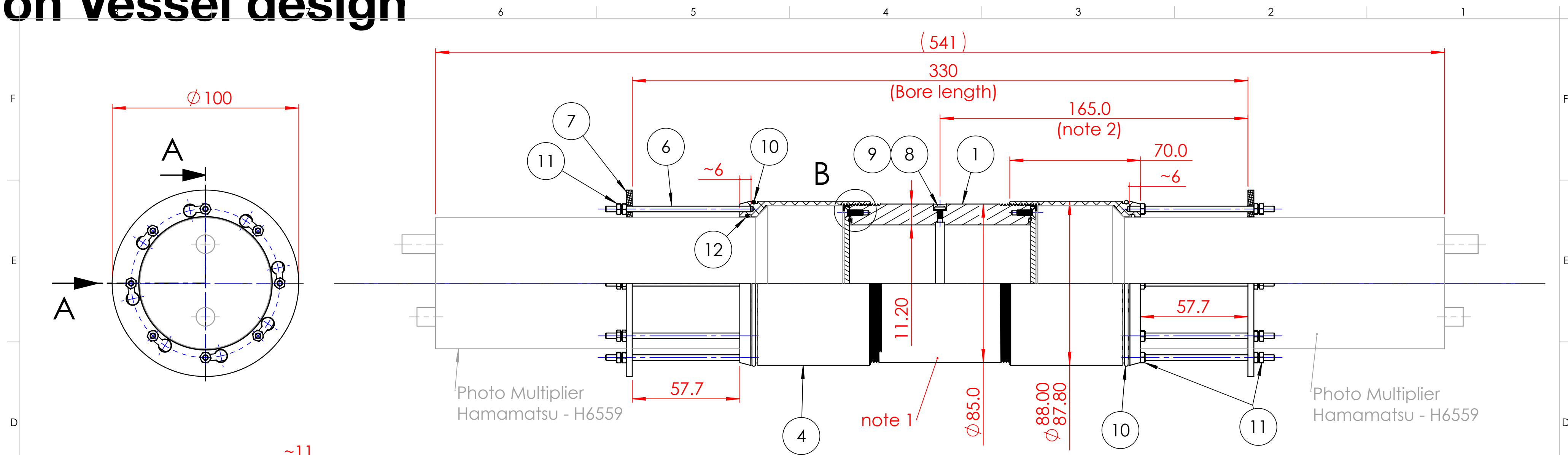

SECTION A-A
SCALE 1 : 2

DETAIL B
SCALE 3 : 1

- Notes:
- Vessel (part 1) will be wrapped with reflective sheets. Location of the filling hole should be marked on the reflective cover.
 - Adjust this dimension and lock the nuts before inserting the assembly into the bore to align the centerline of the vessel with that of the bore.

ITEM	QTY	PART NUMBER	DESCRIPTION	MATERIAL	RAW MATERIAL
1	1	P01	Teflon Vessel - 300ml	PTFE	McMaster - 8546K23 or similar
2	2	P02	Window - Thickness 7/64in	Clear Acrylic	McMaster - 4615T14 or similar
3	2	McMaster - 9464K381	Chemical-Resistant Viton® Fluoroelastomer O-Ring, 1/16in Fractional Width, Dash Number 038	Viton	
4	2	P03	Sleeve - OD 88 mm, Length 70mm	Delrin	McMaster - 8582K25 or similar
5	32	McMaster - 93840A120	Nylon Slotted Flat Head Screw, Thread M3 x 0.50mm, Total length 10mm	Nylon Plastic	
6	16	P05	Nylon threaded rod - Thread M3 x 0.5mm, Length 78mm	Nylon	Essentra components - 38M030050TR or similar
7	2	P04	Support disc - Thickness 1/8in	Aluminum 6061	McMaster - 89015K239 or similar
8	1	McMaster - 94701A058	Filling hole's PTFE Plastic Screw - Extreme-Temperature, Pan, Slotted, Thread M3 x 0.5mm, Thread length 5mm	PTFE Plastic	
9	1	P06	Custom-made filling hole's gasket, OD 6.5mm, Thickness 0.6mm (max. thickness 1.2mm)	Viton	McMaster - 86075K21 or similar
10	2	McMaster - 9262K715	Oil-Resistant Buna-N O-Ring, Width 2mm, ID 85mm	Buna-N Rubber	
11	40	McMaster - 93800A116	Nylon Hex Nut, Thread M3 x 0.5mm	Nylon 6/6 Plastic	
12	2	McMaster - 1295N274	Chemical-Resistant Viton® Fluoroelastomer O-Ring, Super-Resilient, 2 mm Wide, 70 mm ID	Viton® Fluoroelastomer Rubber	

53

RELEASED FOR INFORMATION		KDK+	
UNLESS OTHERWISE SPECIFIED DIMENSIONS ARE IN mm		Arthur B. McDonald Institute Queen's University, Physics Department	
DECIMALS X ± 0.5 X.X ± 0.1 X.XX ± 0.02	ANGLE ± 1° WELDMENTS ± 2	TITLE Vessel & PMs assembled	
ROUNDS AND FILLETS 0.5 mm SURFACE FINISH 3.2 µm		Part Number: A01-KDK+	
NAME A. Mir		DATE (YYYY-MM-DD) 2024-02-02	DWG NO. A01-A-KDK+-1
DRW.	CHK.	SUB.	APPR.
WEIGHT: 838.2 g		MATERIAL: -	
SHEET SIZE: ANSI B		SCALE: 1:5	SHEET 1 OF 1

Engineering student from Lyon, France



ÉCOLE
CENTRALE LYON



**Visiting research student
on KDK+ with
Philippe Di Stefano**



Queen's
UNIVERSITY