

CALOR 2024
Tsukuba

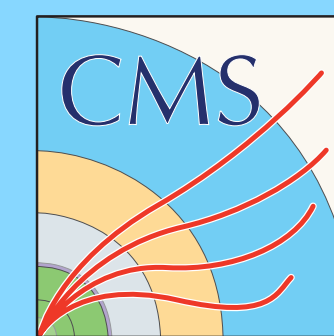
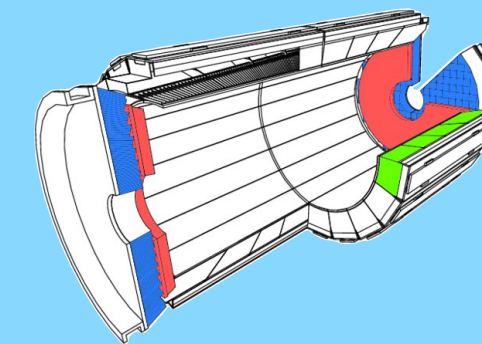

第20回 素粒子・原子核物理学 カロリメータ検出器国際会議
(つくば国際会議場, 2024年5月20日~24日)

Operating a PbWO₄ EM calorimeter in a harsh radiation environment

過酷な放射線環境でのタングステン酸鉛電磁熱量計の操作

Marta Tornago on behalf of the CMS Collaboration

CEA Paris-Saclay

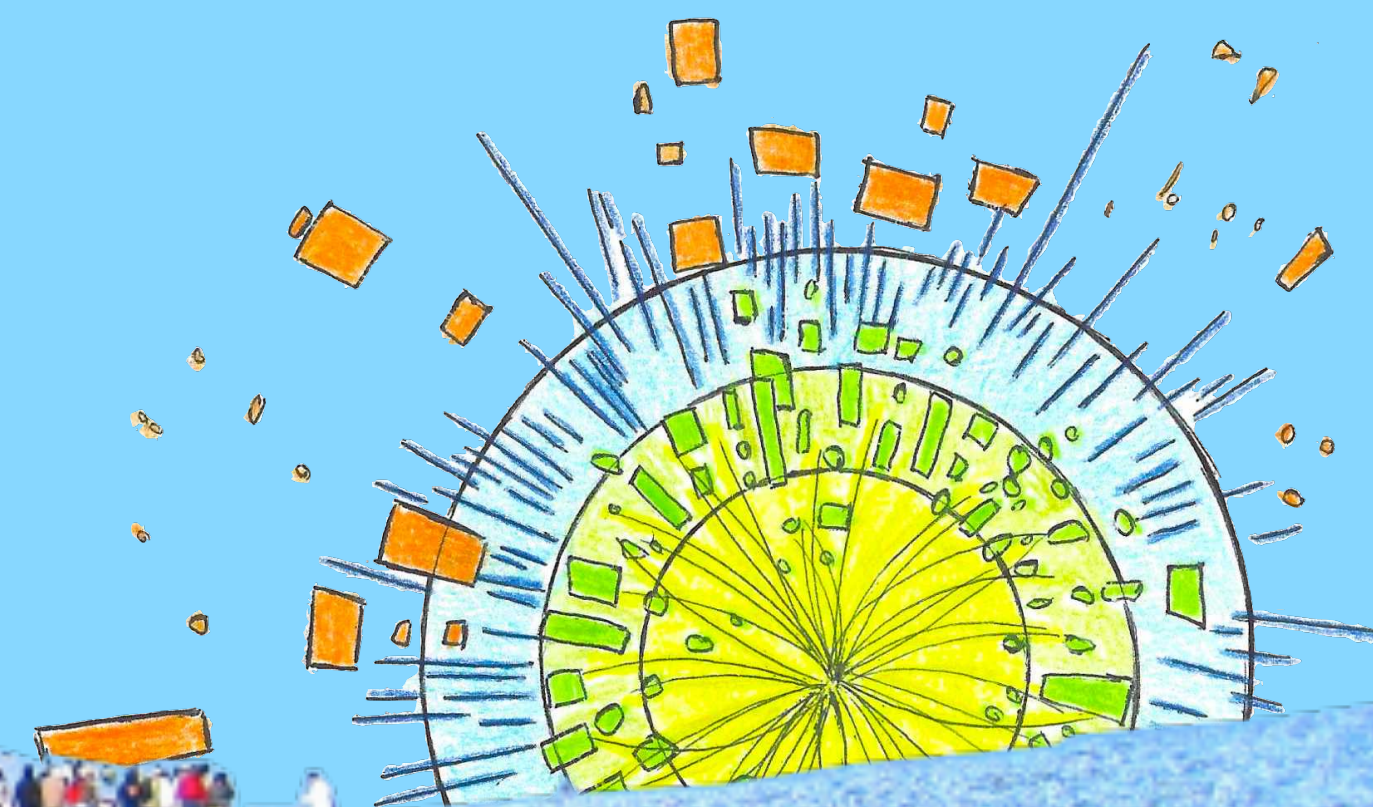

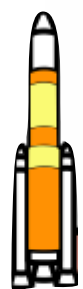

Operating the CMS electromagnetic calorimeter

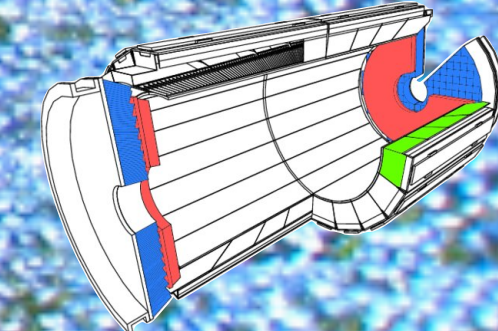

The **CMS Electromagnetic Calorimeter (ECAL)** is essential in the **CMS** physics program

- ✓ Precise measurements of **energy, position and time of arrival of photons and electrons**
- ✓ **Excellent energy resolution**, fundamental in the observation of $H \rightarrow \gamma\gamma$ and $Z \rightarrow 4l$

Operating a lead-tungstate scintillating calorimeter to high precision and in a harsh radiation environment requires **full control of the environmental conditions and a continuous correction of the crystal response changes**

- A **laser monitoring system** provides online correction for the **transparency changes** of each crystal
- Dedicated **techniques based on physics candles** developed to accurately **calibrate each of the 75848 ECAL channels**
 - **Energy inter-calibration**
 - **Time reconstruction and synchronisation**
 - **Detector alignment**
 - Continuous monitoring of **pedestals, pulse shapes, laser corrections, channel status and trigger conditions** to estimate the evolution of noise, transparency, active channels, and data taking conditions for a reliable event reconstruction

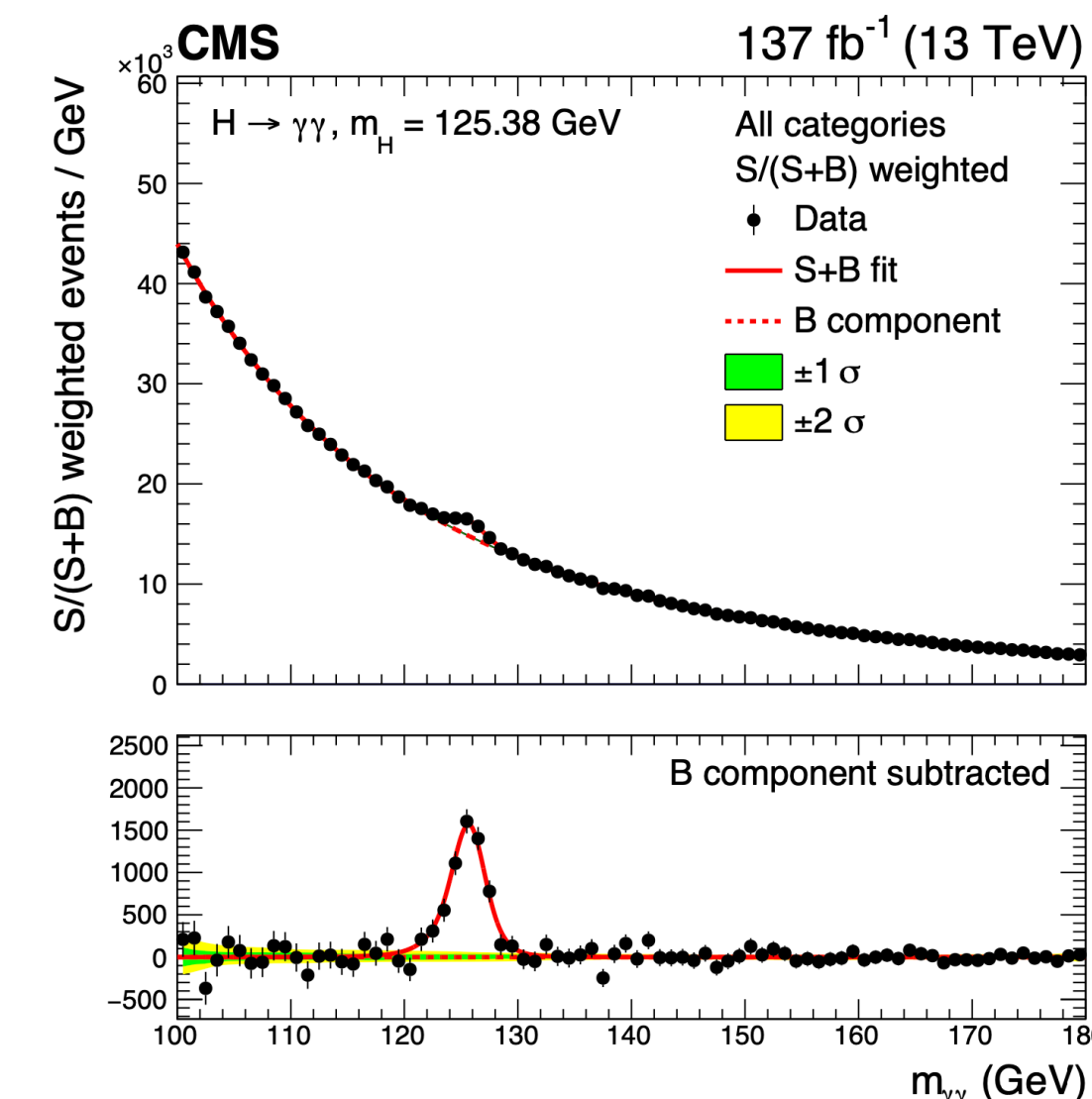

Plot from: [CMS-HIG-19-015](#)

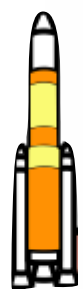

How to deal with LHC Run 3 in ECAL?

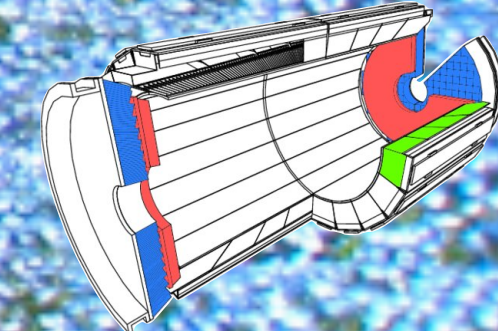

During Run 3, LHC experienced the **largest luminosity** so far

- Instantaneous luminosity increased from $2 \times 10^{34} \text{ cm}^{-2}\text{s}^{-1}$ to $2.6 \times 10^{34} \text{ cm}^{-2}\text{s}^{-1}$
- CMS observed a **mean pile up of 46 in 2022 and 52 in 2023** (with an average of 32 in Run 2)
- **Lumi-levelling at PU 60-65 foreseen in 2024 with a L1 trigger rate of 120 kHz** (100 kHz in Run 2, 112 kHz in 2023)

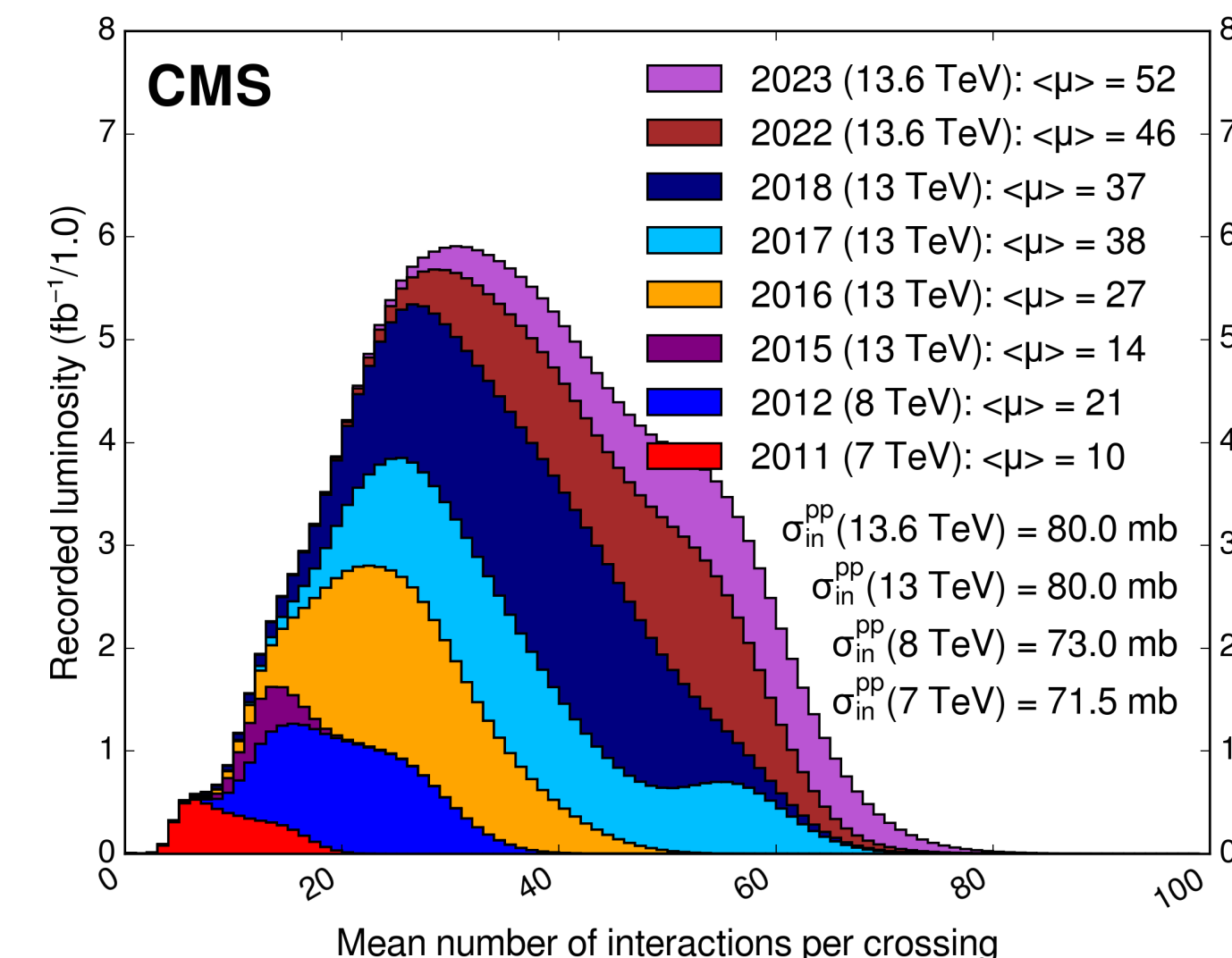

ECAL needs to adapt to the new Run 3 challenges

Plot from: [CMS Luminosity](#)

- **Software update for operations and improvement of automatic actions** to cope with high rate and pile up
- Large majority of ECAL calibrations proved to be solid in Run 2 environment → **make use of fully automated procedure**
- Development of **new algorithms to maintain excellent performance** with Run 3 conditions
 - Improved methods in ECAL Trigger: details in [J. Dervan's talk](#)
 - New timing reconstruction
 - Use of deep neural networks for clustering of energy depositions of electrons and photons
- **Upgrade of the laser monitoring system**

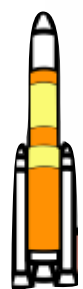

ECAL operations during Run 3

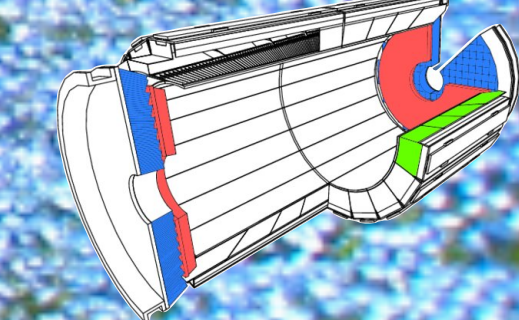

ECAL behaved well in both 2022 and 2023:

- CMS managed to collect the **96.3% of the total luminosity** delivered by LHC thanks to the subsystems efficiency
- **Improved downtime duration** for ECAL: 7h 23min in 2022-2023, 20h 25min in Run 2 (2016-2018), mainly due to Single Event Upset (SEU) and shifters' reaction time
 - ✓ **Improved Single Event Upset (SEU) recovery software** with automatic DAQ actions
→ recovery time reduced from ~30 s in Run 2 to 12 s in Run 3
 - ✓ **Improved shifters' instructions**
 - ✓ **Equipment protection review** with the implementation of a new set of automatic actions, alarms and notifications

Live channel status is stable in Run 3:

EB 98.78%

EE 98.11%

ES 98.42%

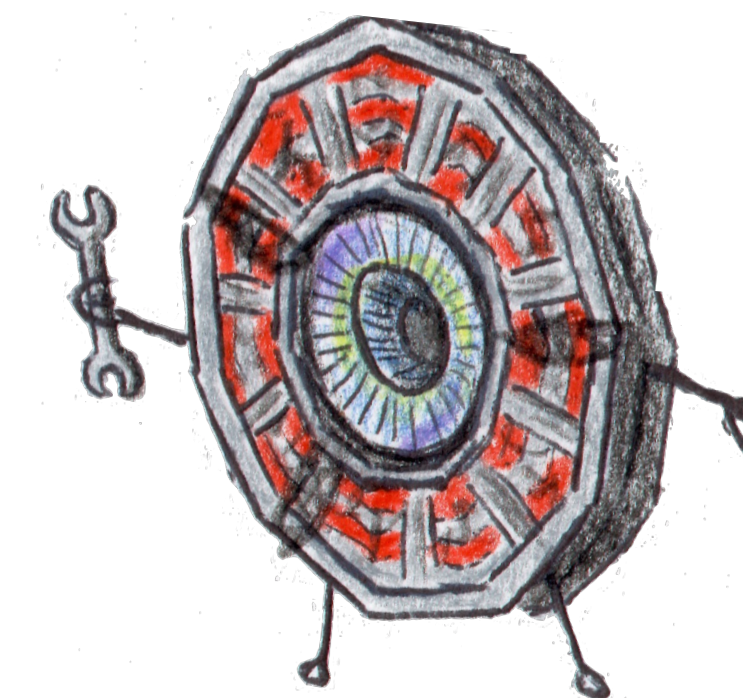

Challenges for ECAL in Run 3: **large event size and very high rate** (more than what ECAL was designed for)

→ thresholds have been adapted to avoid losing data

- **Heavy Ion in 2023: ECAL managed to cope with the large event size of ion collisions** keeping an excellent data quality thanks to optimised zero-suppression settings

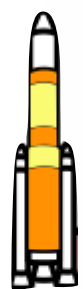

How to measure EM energy with high precision?

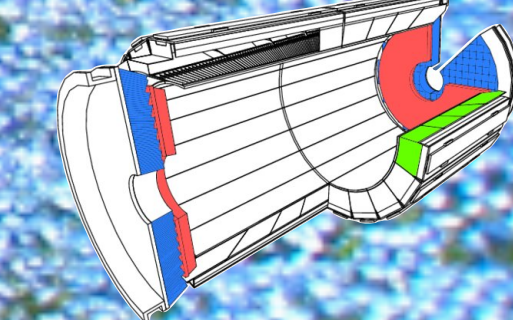

The energy E of an electromagnetic shower in the CMS ECAL is represented as the energy of a **SuperCluster**, the aggregation of clusters in EB and EE produced by showering in the tracker material

$$E_{e,\gamma} = GF_{e,\gamma} \sum_i S_i(t) C_i A_i$$

A_i pulse amplitude in ADC counts for crystal i

$G(\eta)$ absolute energy scale, ~ 40 (~ 60) MeV per ADC count in EB (EE) with no radiation damage

$S_i(t)$ response to scintillation light for crystal i , where $S(t)/S_0 = (R(t)/R_0)^\alpha$ with $R(t)$ response to laser light \rightarrow monitored with the **laser system**

C_i inter-calibration coefficient for crystal $i \rightarrow$ **physics candles** (Z, W, π^0) **used to calibrate all channels**

$F_{e,\gamma}$ energy correction including η and ϕ dependencies, material effects and differences for e, γ

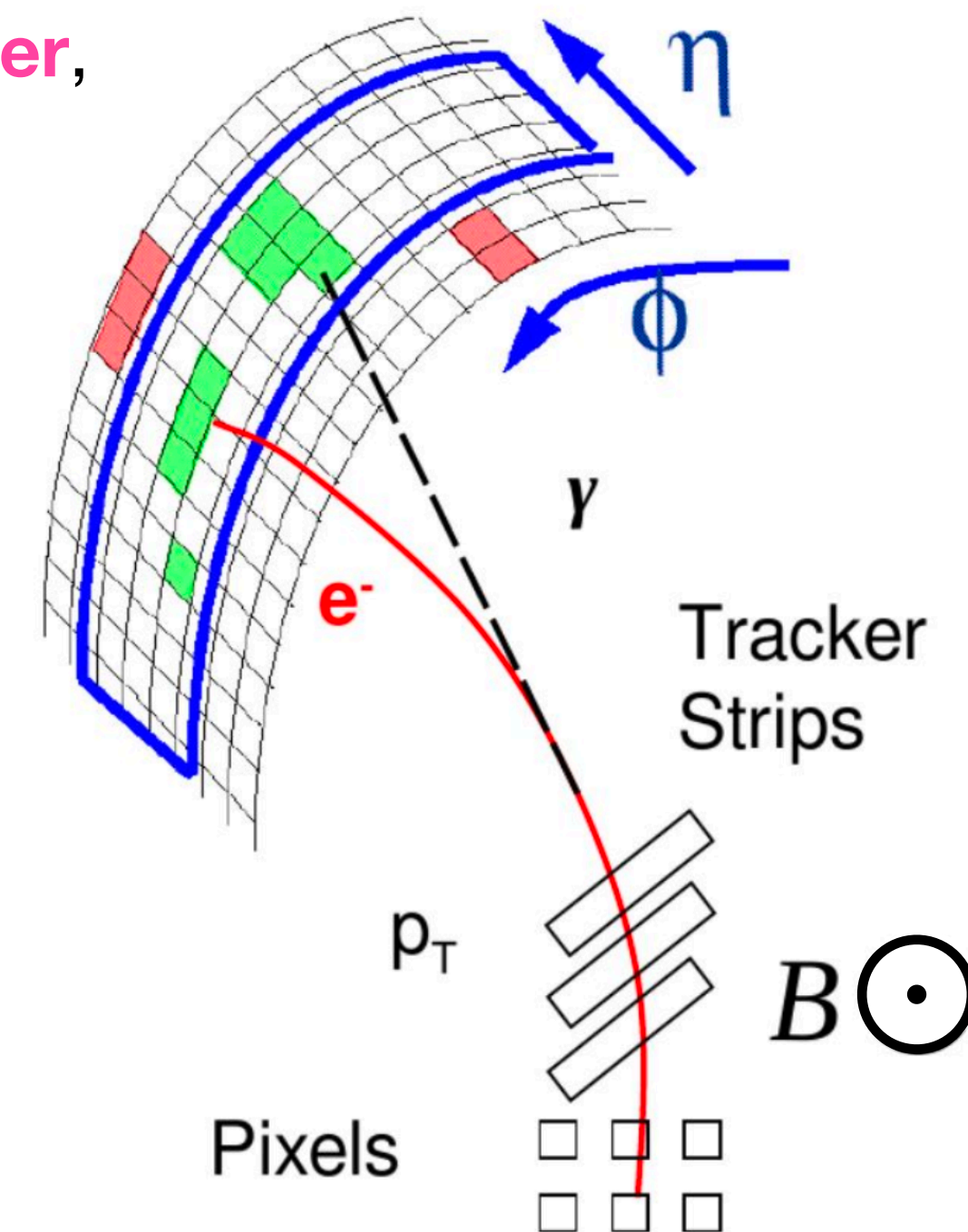

Strategy to guarantee the **best possible prompt energy calibration**:

- ▶ **Weekly update of pedestals, continuous update of laser corrections**
- ▶ **Automatic calibration workflows for several types of calibration**



Automation framework

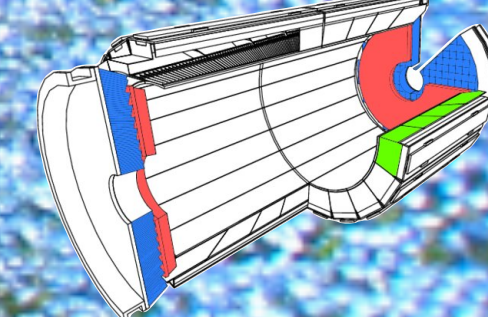

Processing overview																		
Run	Fill	DAQ endtime	GT	Rec. Lumi. (/pb)	Global status	trivial-ghc	alignment-reco	alignment-align	pulse-shapes	pulse-shapes-merg	pulse-shapes-merg	pulse-shapes-hltre	pulse-shapes-hltvz	timing-reco	phisym-reco	pi0-reco	pi0-mon	pi0-mon-cml
362760	8496	2022-11-28 06:02:18	124X_dataRun3_Prompt_v...	277	processing		done	new	done	done	done	done	done	done	done	done	done	done
362759	8496	2022-11-28 01:12:47	124X_dataRun3_Prompt_v...	2.62	processing		done	new	done	done	done	done	done	done	done	done	done	done
362758	8496	2022-11-28 01:06:31	124X_dataRun3_Prompt_v...	85.1	processing		done	new	done	done	done	done	done	done	done	done	done	done
362757	8496	2022-11-27 23:40:31	124X_dataRun3_Prompt_v...	22.6	processing		done	new	done	done	done	done	done	done	done	done	done	done
360508	8277	2022-10-17 09:19:29		0	done													

Automation framework conceived to optimise person-power
 Development allowed by the strength of ECAL calibration and reconstruction techniques

Core functionality commissioned between end 2021 and beginning 2022
 Workflow integration successfully performed during 2022 and 2023

The framework has worked very reliably during 2023 for ECAL to run calibration tasks requiring pre-determined input conditions and larger datasets
 Several workflows already in production: **alignment coefficients, pulse shape templates, timing calibrations** (for 2 algorithms), **laser harness corrections, energy scales, ϕ -symmetry reconstruction, π^0 and m_{ee} monitoring**

The framework already integrated workflows from more subsystems
 (tracker, pixel, muons - HCAL, DT and PPS already joined the project)

S	W	Name
⊘	⊘	[Calib]: ECAL alignment
⊘	⊘	[Calib]: eop
✓	⊘	[Calib]: Pulse shapes measurement
✓	⊘	[Calib]: timing
✓	⊘	[Mon]: laser-latency-live
✓	⊘	[Mon]: Zee
✓	⊘	[Reco]: AICaPhiSym
✓	⊘	[Reco]: cosmics-ghc
✓	⊘	[Reco]: ecalelf-ntuples
✓	⊘	[Reco]: pi0
✓	⊘	[RunCtrl]: fetch-runs
✓	⊘	[RunCtrl]: transfer-htcondor-logs
✓	⊘	[Tools]: deploy-ecal-env
✓	☁	[Tools]: EOS quota monitoring
✓	⊘	[Tools]: GRID proxy
✓	⊘	[Tools]: laser-latency-request

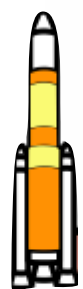

Automation framework: validation

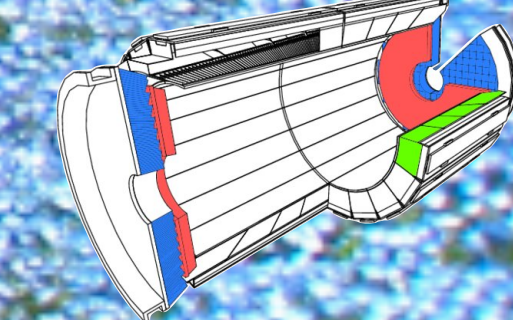

Example of physics validation from the automated framework

- **Time stability of the di-electron invariant mass** comparing data and simulation over 2022 and 2023 using $Z \rightarrow e^+e^-$
- The spread of the median ratio is at **0.1% level throughout 2022 and 2023**

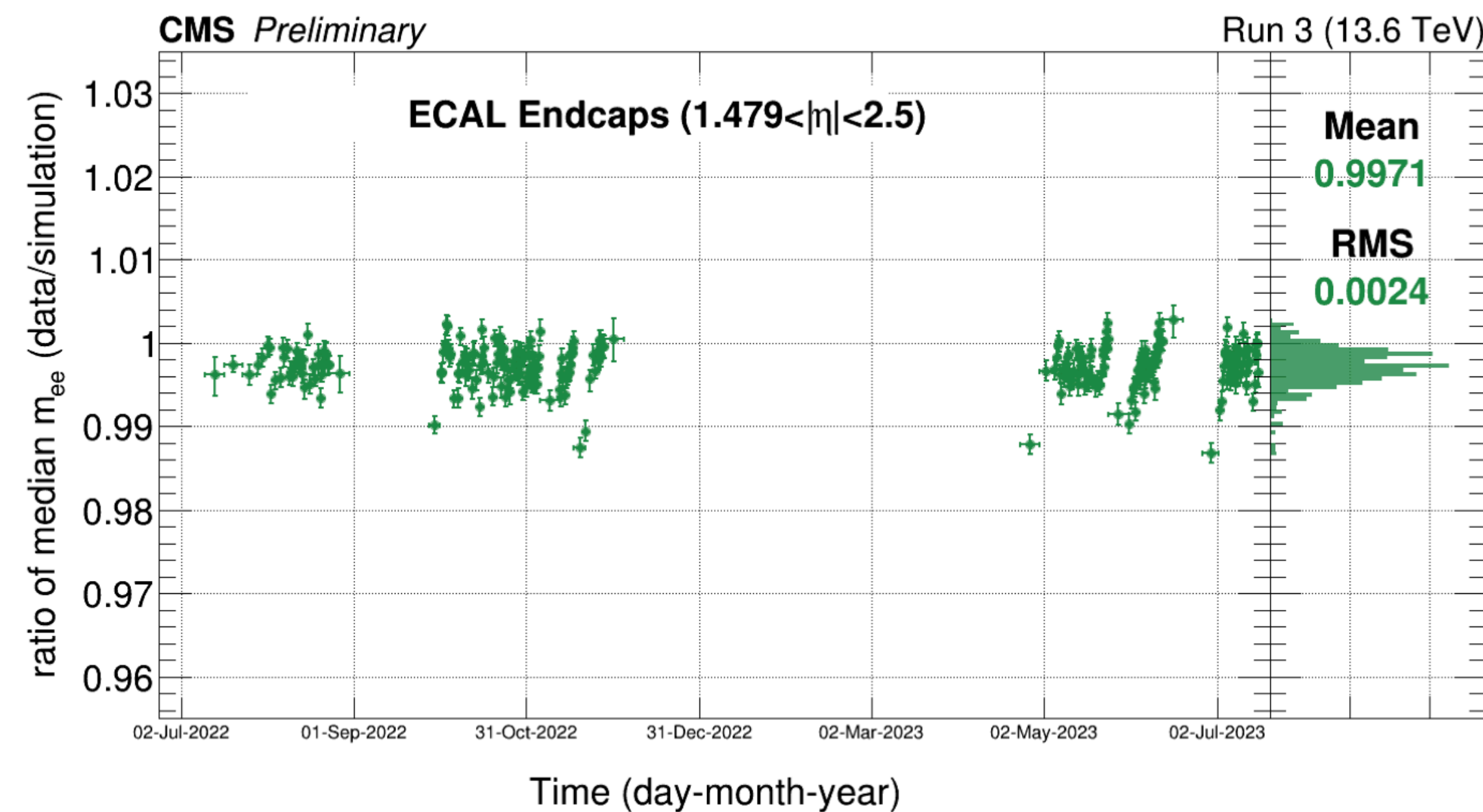
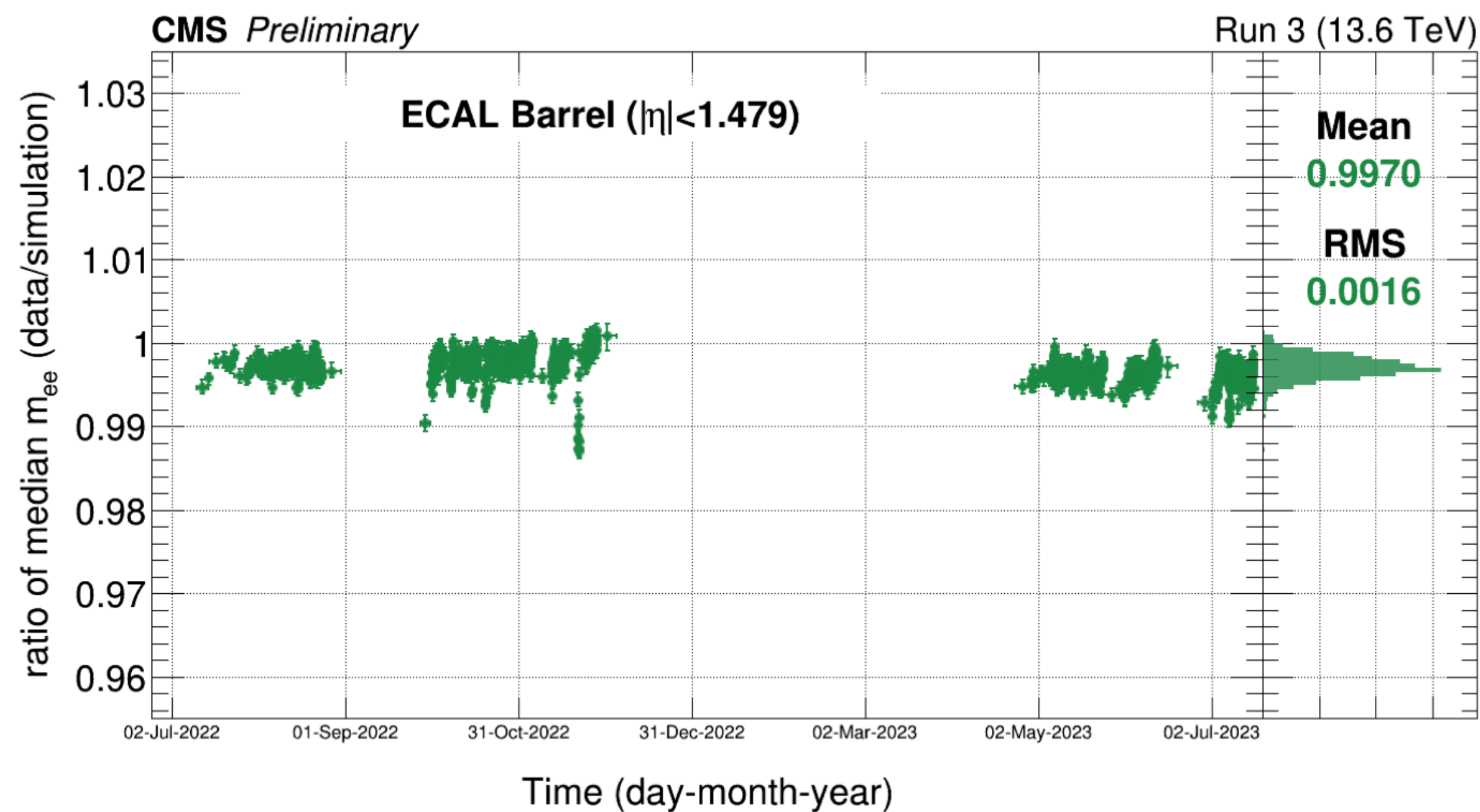

Plots from [CMS DP-2024/022](#)

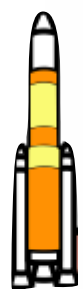

Automation framework: validation

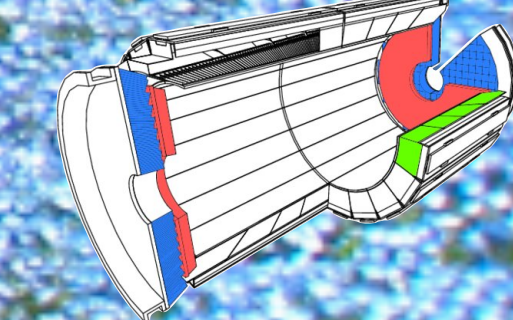

Example of plots to validate the automation framework

- **Time stability of the shower shape of electromagnetic deposits** over 2022 and 2023 using $Z \rightarrow e^+e^-$
- Shower shape represented by $R_9 = E_{seed}/E_{3 \times 3}$, dependent on energy intercalibration, noise and PU
 - R_9 allows to distinguish between high and low quality electrons and photons ($R_9^{Thr} = 0.965$)
- Shower shapes are **very stable in both 2022 and 2023**

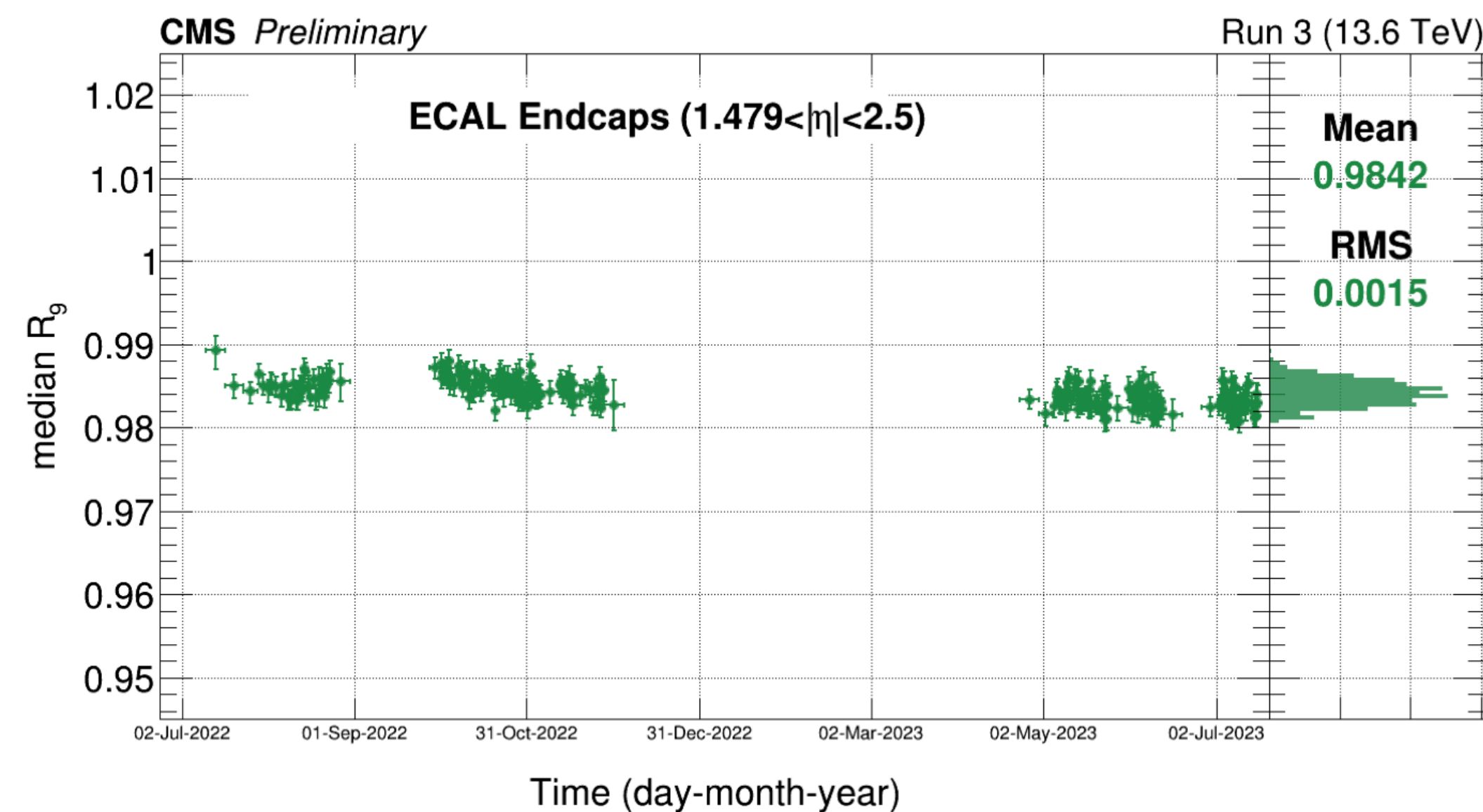
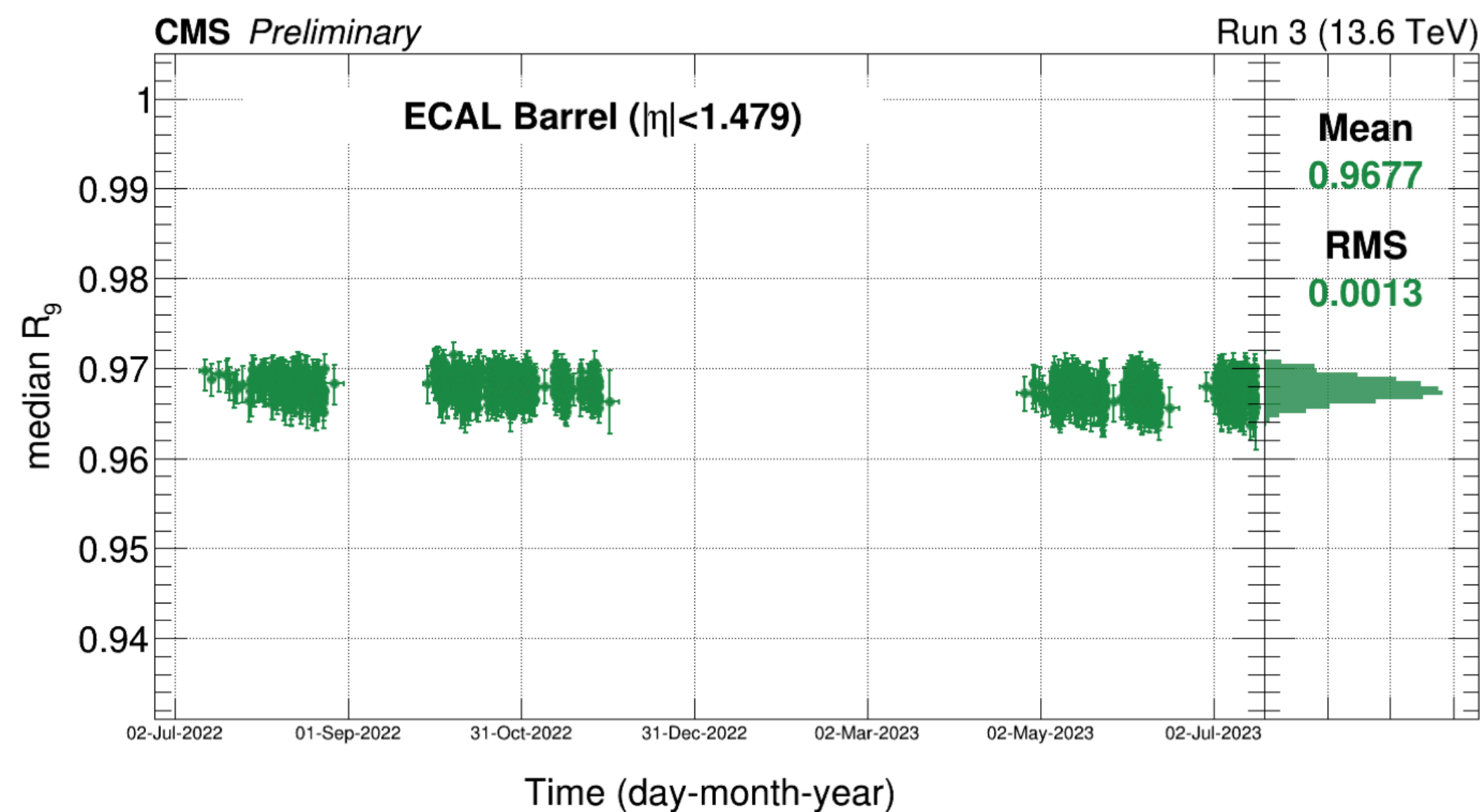

Plots from [CMS DP-2024/022](#)

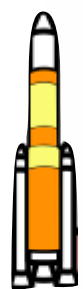

Energy intercalibration

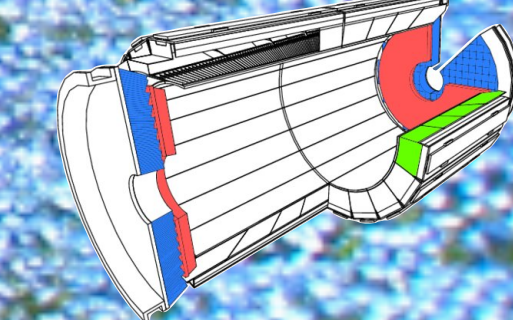

High statistics in $Z \rightarrow e^+e^-$ during Run 3 allows to **keep using Run 2 techniques for ECAL energy inter-calibration**

Channel inter-calibration computed for 2022 and 2023 with Z peak:

- **Stability over the whole 2022-2023 period** despite luminosity increase and detector ageing: no fundamental changes in the crystals and photo-readout

Intercalibrations with π^0 and W decays available for future improvements

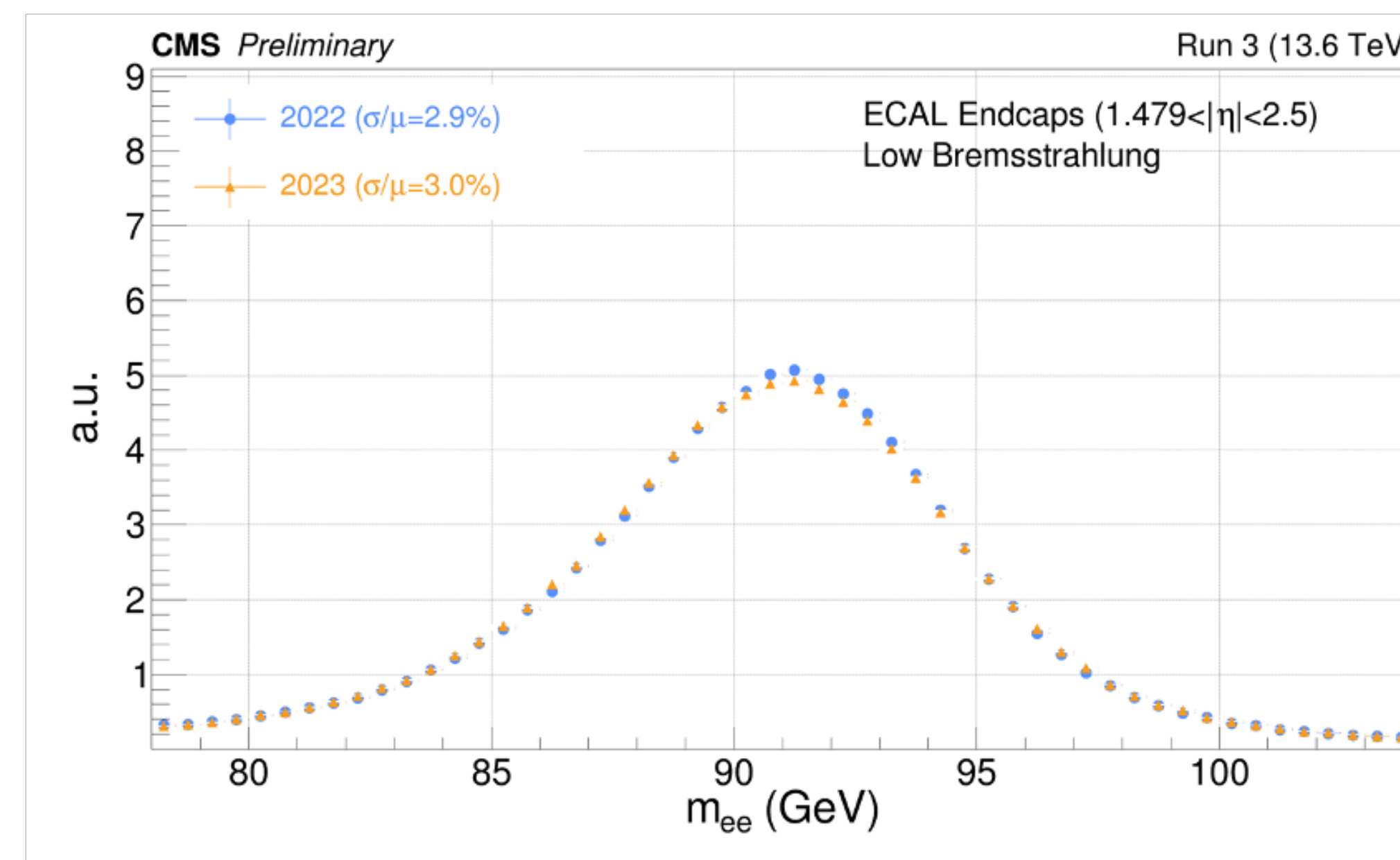
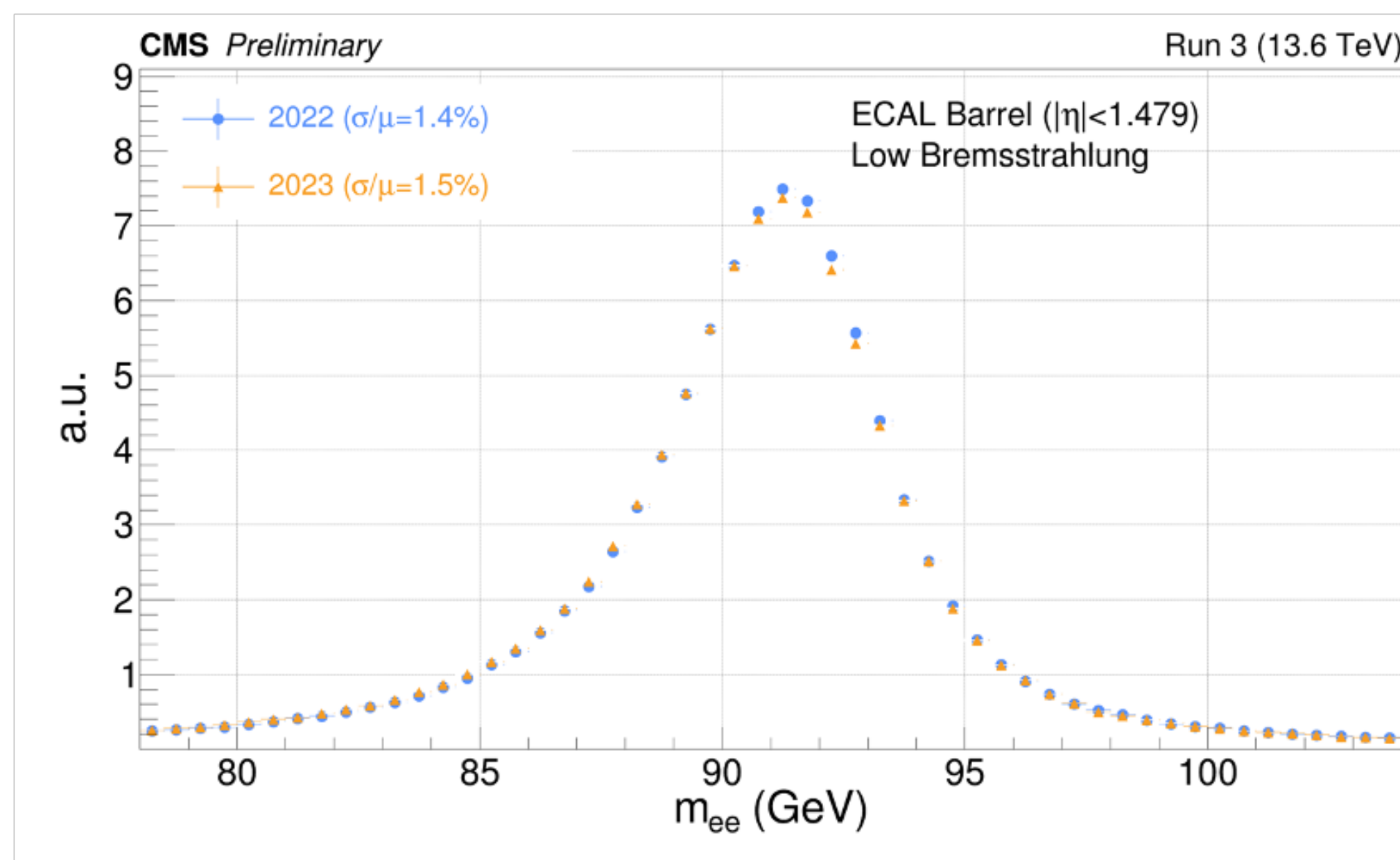

Plots from [CMS DP-2024/022](https://cds.cern.ch/record/2871111/files/CMS-DP-2024-022)



ECAL laser monitoring system

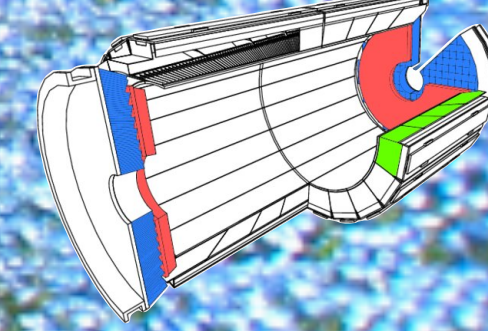

The **Laser Monitoring system** constantly monitors and allows to correct for changes in the crystals transparency to ensure an excellent energy resolution

Light from a **laser source** is sent to each crystal with a **multi-level system of optical fibres** and a **two-level distribution system** on detector

The same light is sent simultaneously to **reference PN diodes**, readout by an **electronic chain specifically designed** (FEM cards + MEM board)

Plot from [CMS DP-2024/022](#)

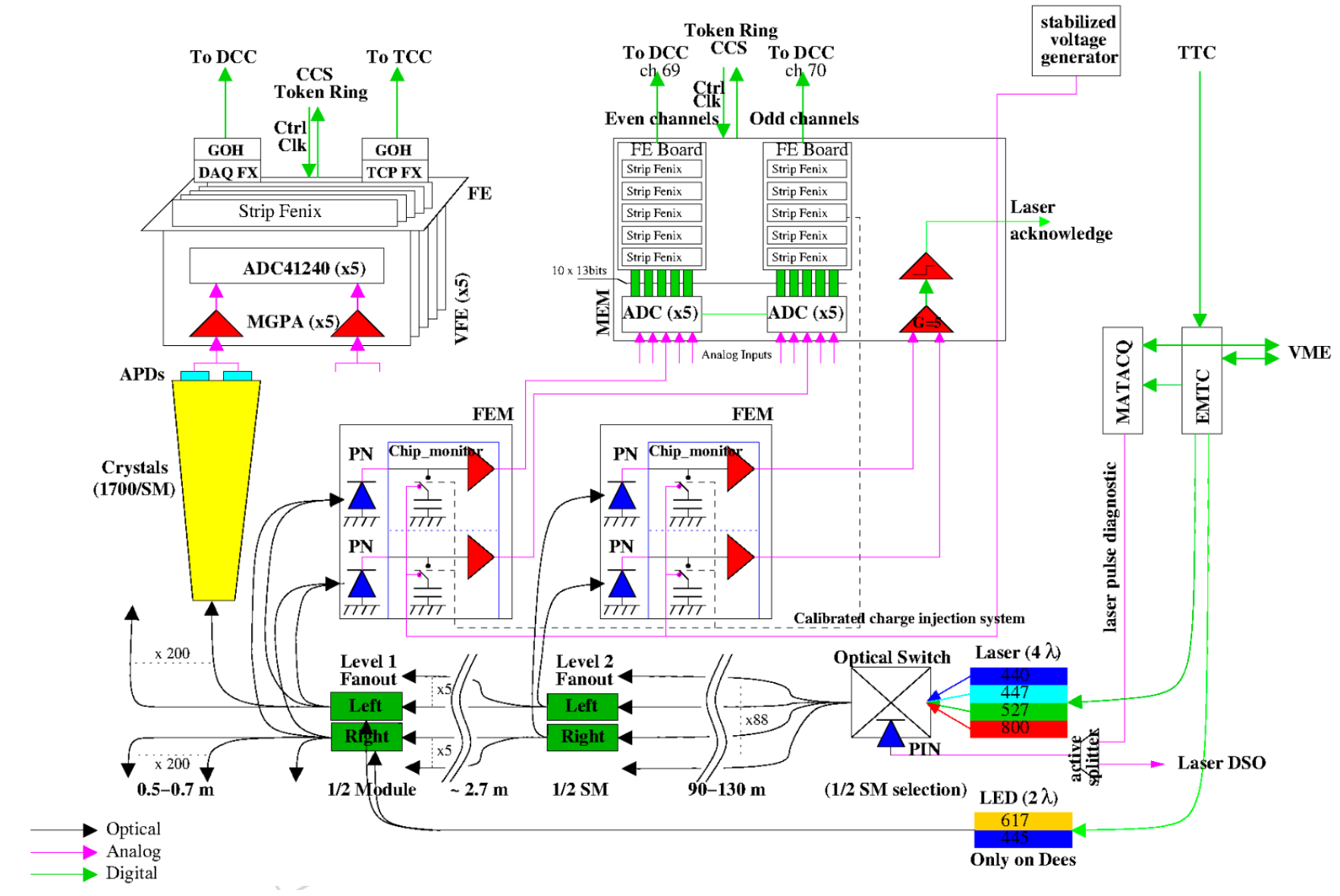
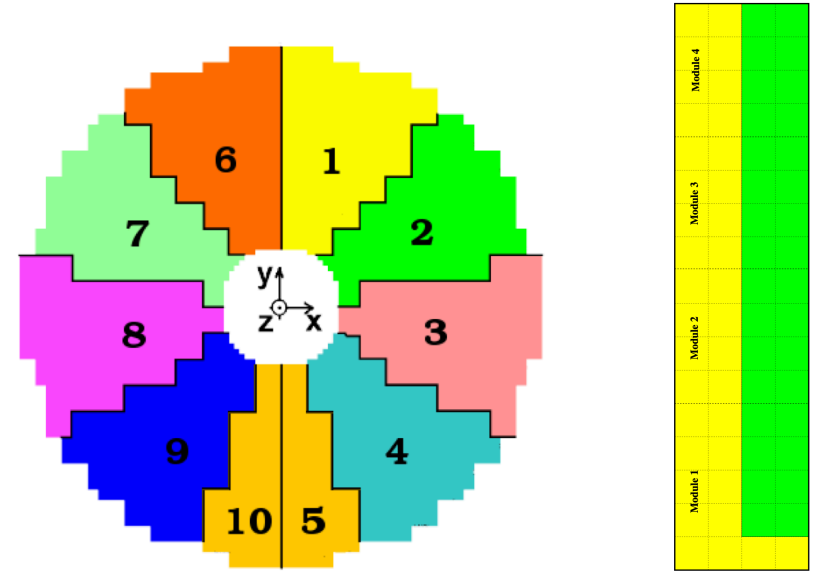
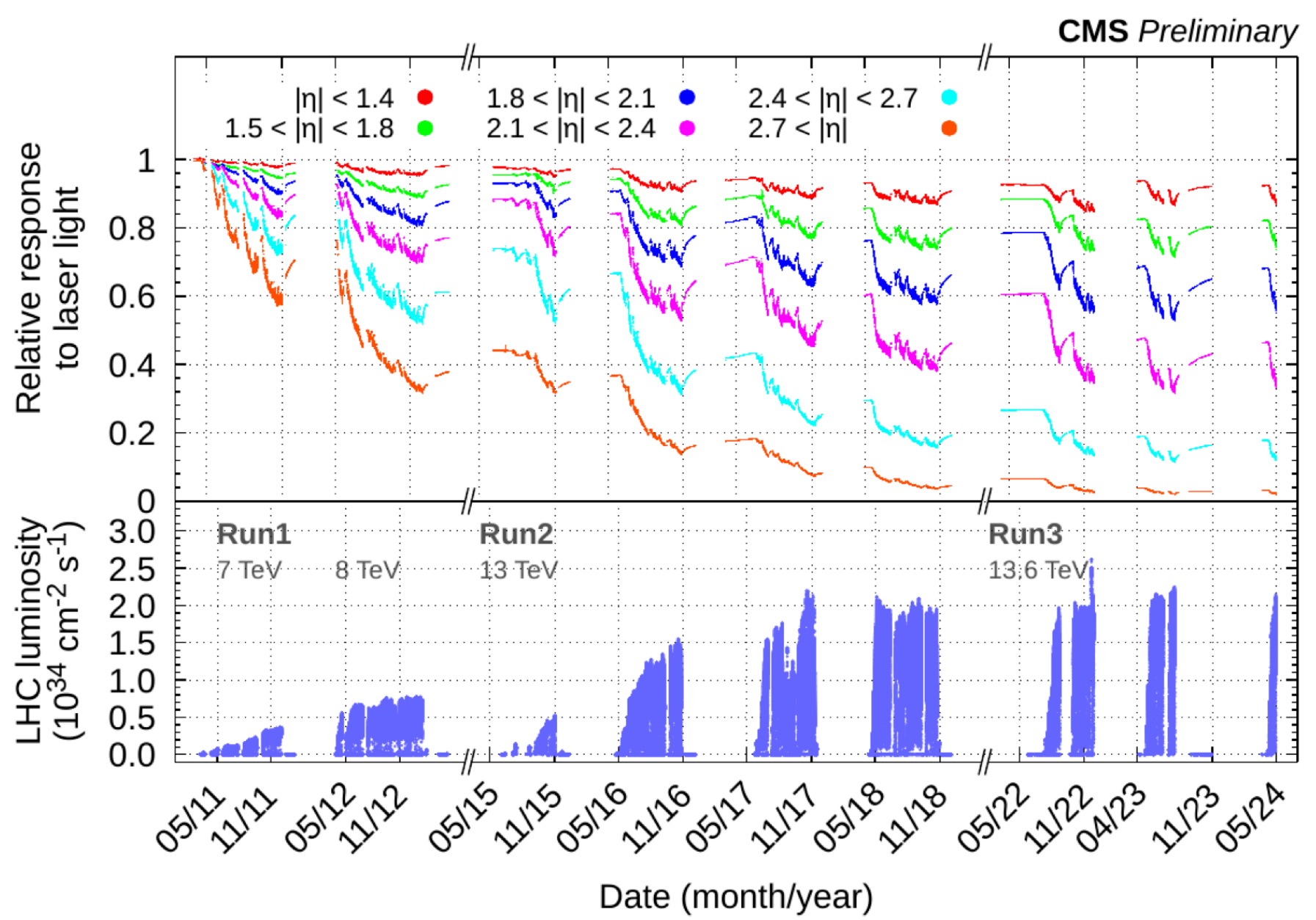

ECAL is divided in 88 laser monitoring regions, 2 in each EB SuperModule and 10 radial sectors in each Endcap

Two lasers (blue and green) **continuously sweep the 88 ECAL laser monitoring regions** and provide a measurement every ~40 minutes

The ratio between signals from crystals and from PN (APD/PN) **is used to apply quasi-real-time corrections** to the data, taking into account the actual transparency

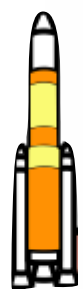

Laser room relocation

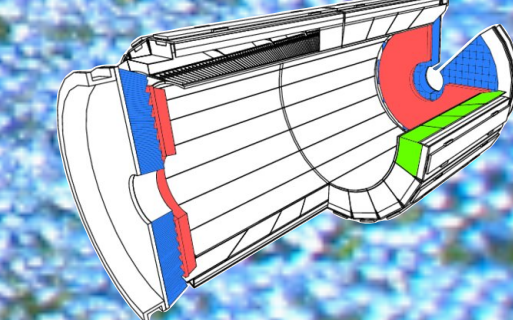

The laser room needed to be relocated from underground to surface to make space for the installation of the cooling system of the Endcap Timing Layer and the High Granularity Calorimeter, new subsystems that will instrument the CMS experiment during its Phase-2 at High-Luminosity LHC

- **Pilot run of the new laser room on surface performed in June 2023**
 - ✓ **Stability of laser pulse shapes has been verified**, negligible change in shape with the additional extra 150 m fibres
 - ✓ **Amplitude decreases by a factor ~2 in 100 m** (3 dB/100 m), compensated with increase of laser power
 - ✓ Verified that **the system with additional 150 m fibres in the laser path behaves as expected**
- The laboratory has been **completely relocated on surface in November 2023** (during the End-of-Year Technical Stop) and **successfully commissioned**

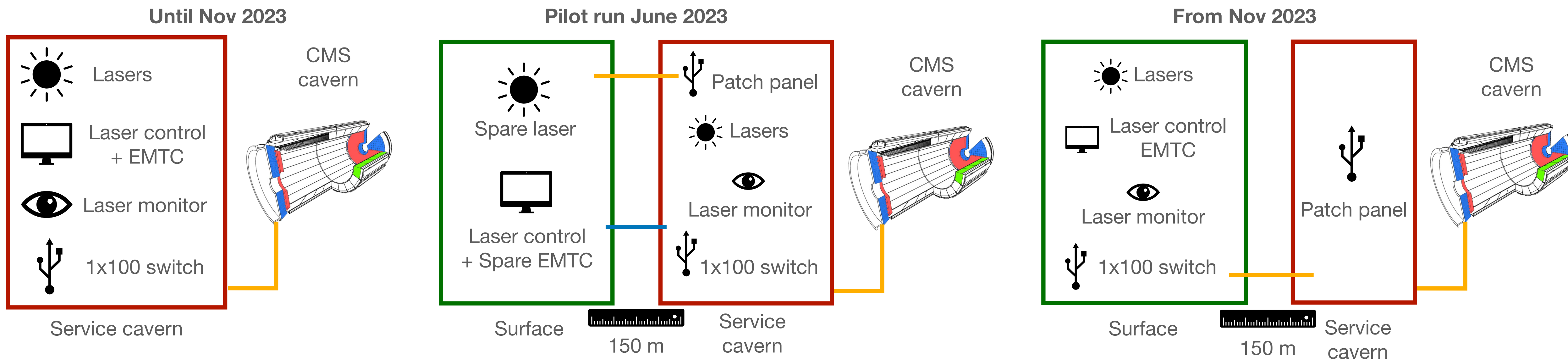

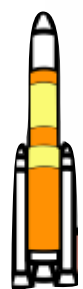

Laser room relocation

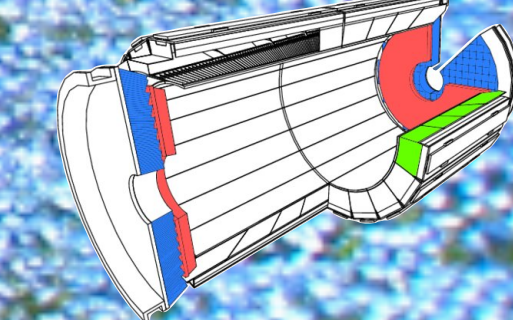

The laser room needed to be relocated from underground to surface to make space for the installation of the cooling system of the Endcap Timing Layer and the High Granularity Calorimeter, new subsystems that will instrument the CMS experiment during its Phase-2 at High-Luminosity LHC

- **Pilot run of the new laser room on surface performed in June 2023**
 - ✓ **Stability of laser pulse shapes has been verified**, negligible change in shape with the additional extra 150 m fibres
 - ✓ **Amplitude decreases by a factor ~2 in 100 m** (3 dB/100 m), compensated with increase of laser power
 - ✓ Verified that **the system with additional 150 m fibres in the laser path behaves as expected**
- The laboratory has been **completely relocated on surface in November 2023** (during the End-of-Year Technical Stop) and **successfully commissioned**
 - ➔ **The system is operational and ready for the High-Luminosity era**
- The new lab **complies with the requirements of a temperature stability of ± 0.3 °C and relative humidity < 40%**, to ensure the stability of the lasers (pulse and timing)

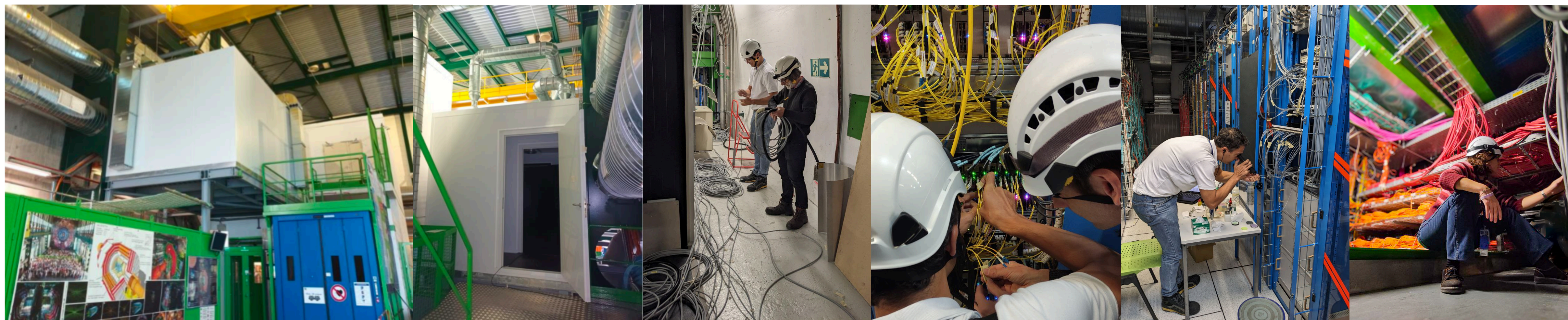

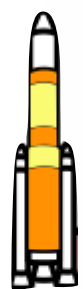

Laser precision after relocation: results

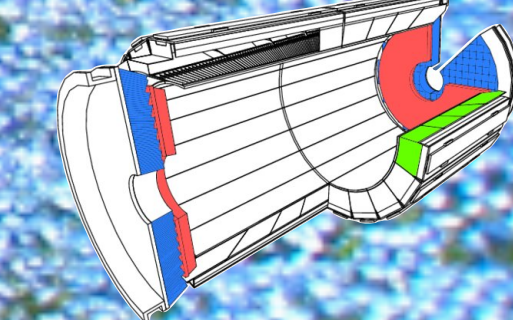

Verification of laser precision after the laser room relocation: results obtained with data from November commissioning
Precision for each crystal represented in 2D maps for ECAL barrel and endcaps

- Precision $< 6 \times 10^{-4}$ in the barrel
- Endcap precision reach 1×10^{-3} in inner regions due to radiation damage of the crystals, within requirements ($< 2 \times 10^{-3}$)
- Comparable with 2011 results considering signal-to-noise ratio reduction

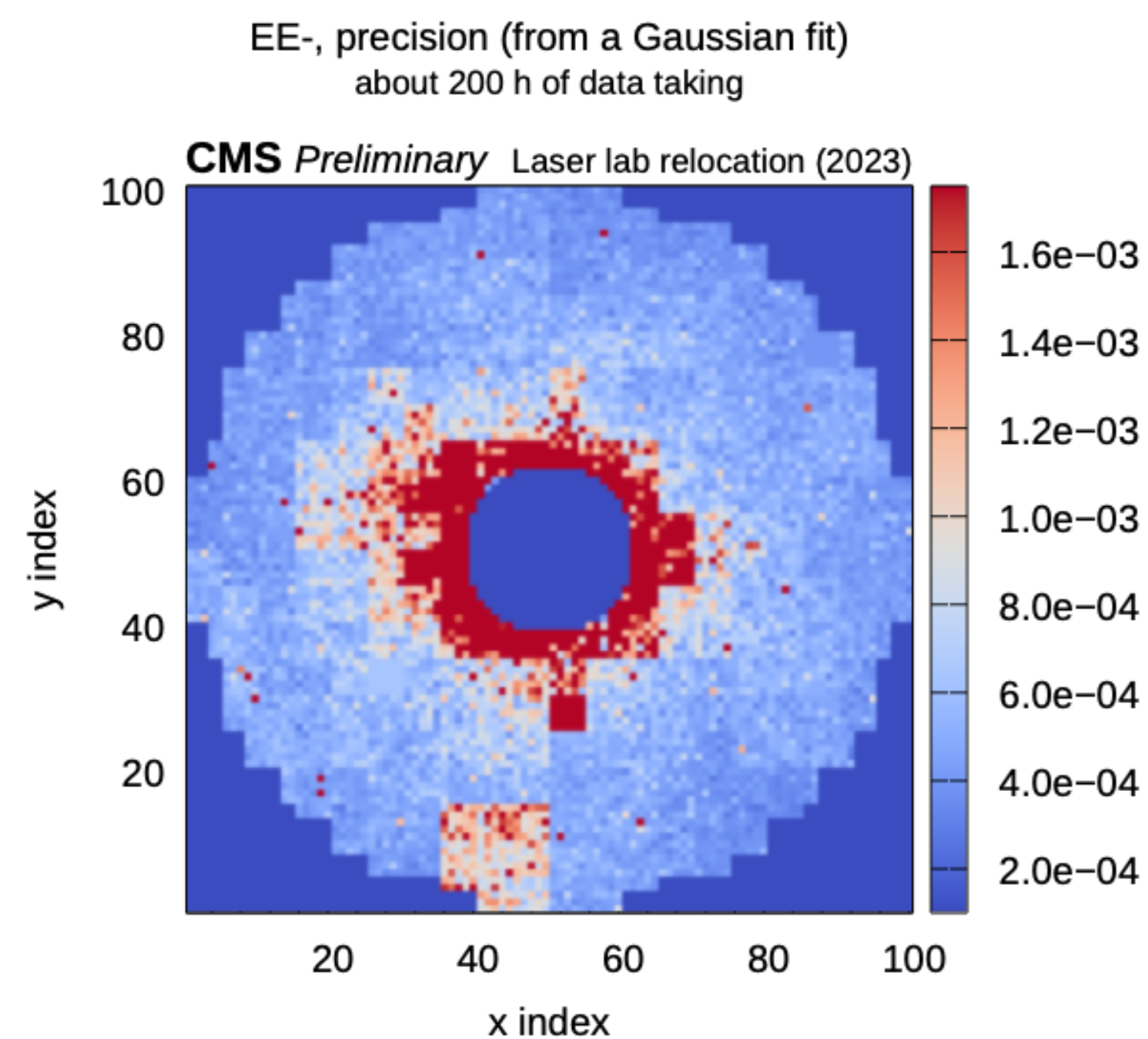
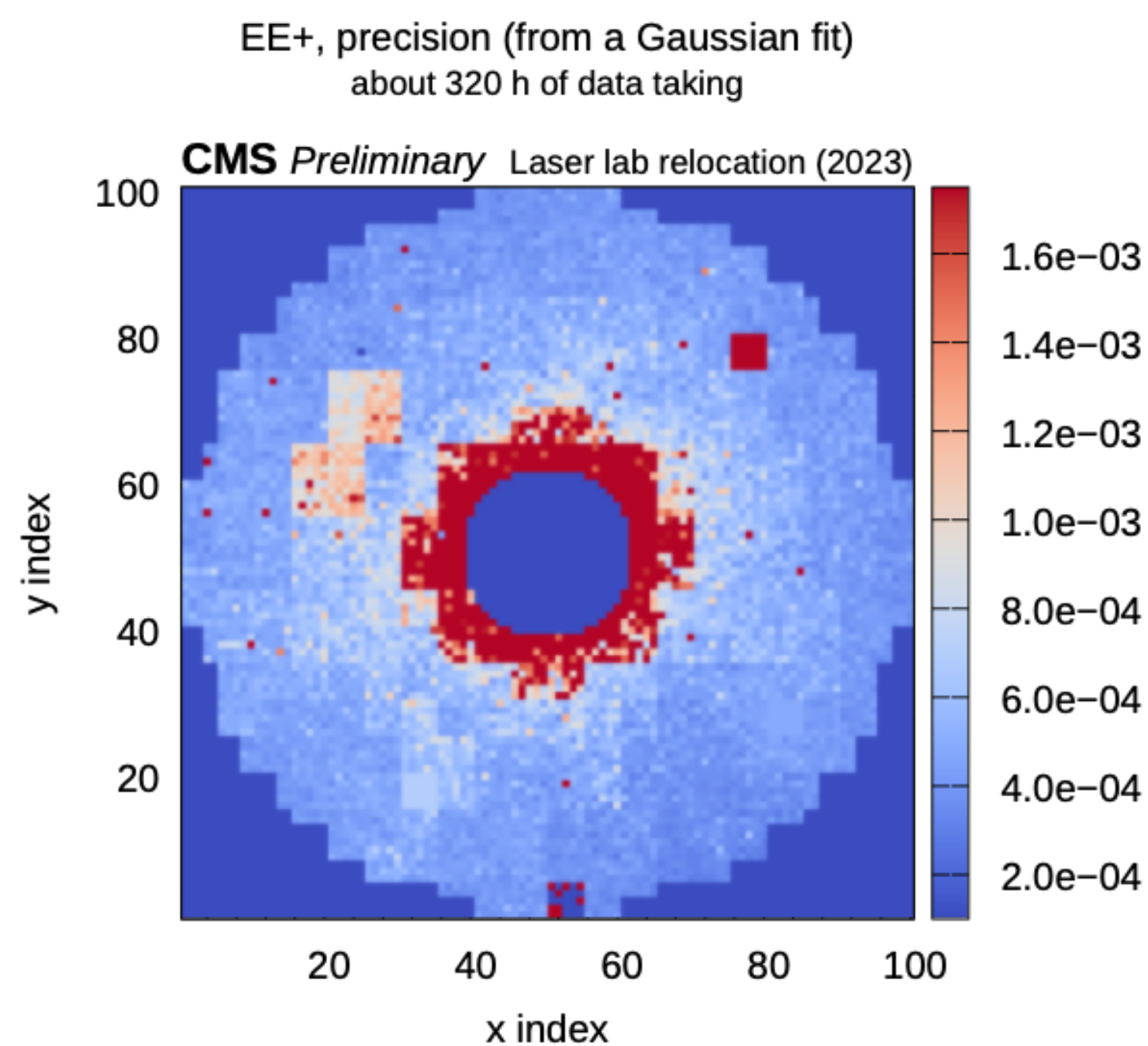
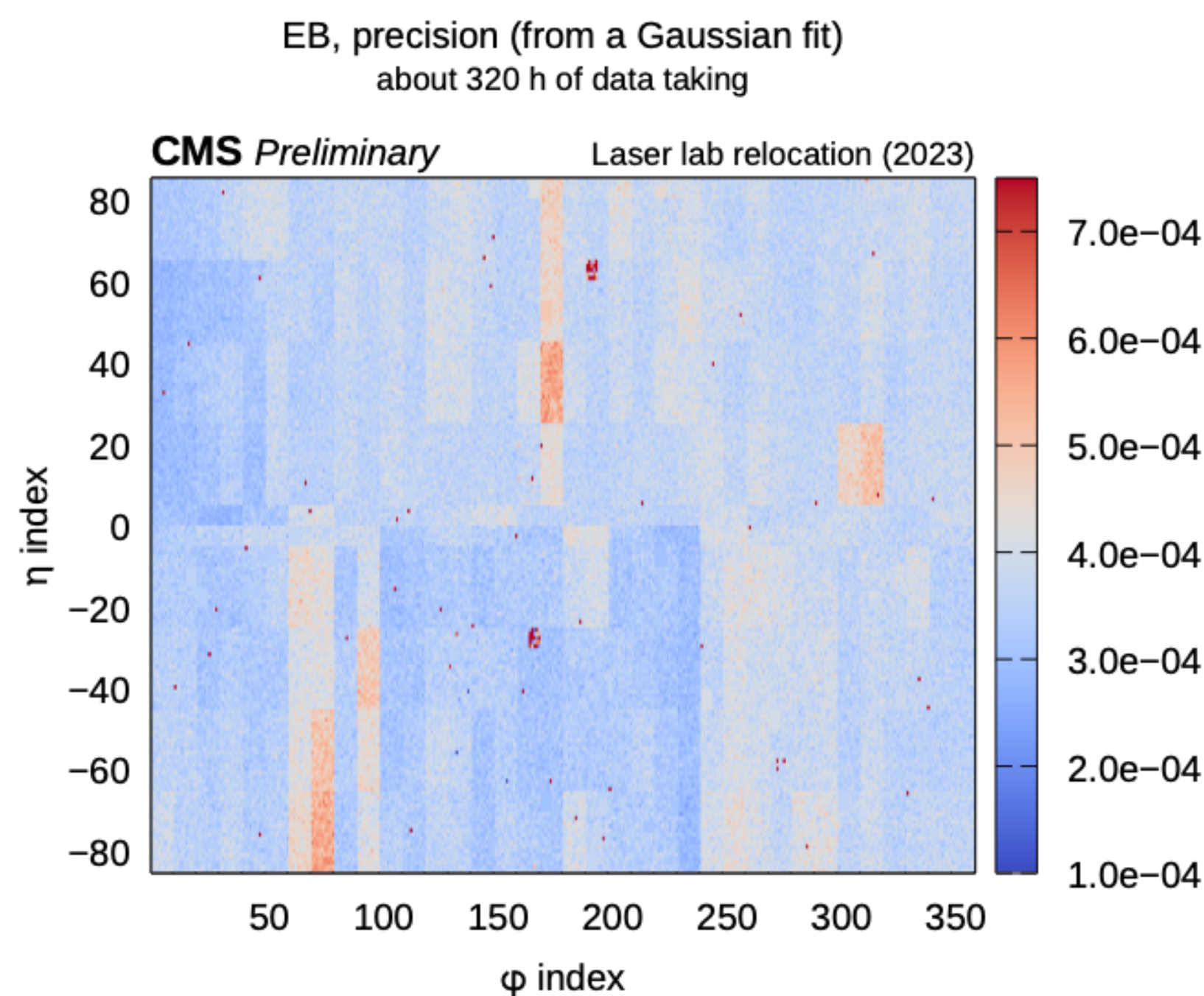

Plots from [CMS DP-2024/022](#)

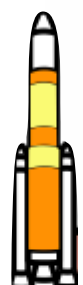

New green laser for ECAL endcaps

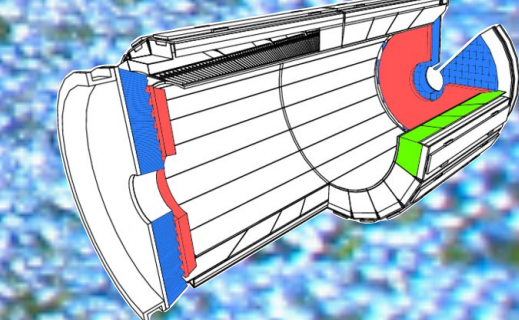

ECAL endcaps during Run 3 will suffer from high transparency loss due to unprecedented levels of radiation, especially in the regions at highest pseudorapidity and in the last years of data taking

The issue can be mitigated with an **upgrade of the laser sources**

Lasers used in the calibration sequence in Run 2:

- Blue diode pumped YVO4 laser, Photonics DP2-447 (+1 spare)
- Green laser DTL-419QT 527 nm

+ New green laser Photonics DP20-B527 for Run 3

Laser	DP2-447	DTL-419QT	DP20-B527
Wavelength	447	527	527
Pulse energy (mJ)	1	0.2	18
Pulse instability (RMS,%)	1	3	3
Pulse width (ns)	23	7	7
Pulse delay (μ s)	86 + 120	300 + 250 ns	600 + ~200 ns
Pulse jitter (ns)	~1	~1	~1

The new laser lab has been equipped in 2023 with a **new, more powerful green laser**

- Commissioning started in August 2023
- The new green laser has a large latency: its integration in the calibration sequence **needed the preparation of a new laser firmware + trigger configuration and the consequent adjustment of the laser delays**
- **New laser firmware and trigger configuration successfully tested** at the beginning of 2024 with all other subsystems
- **New green laser is now running in the calibration sequence in place of the legacy green laser**

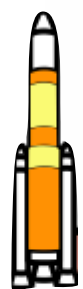

Not only energy: timing reconstruction

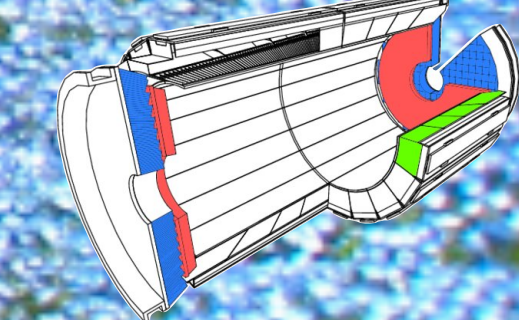

Ratio timing was the default reconstruction algorithm in Run 2 and in 2022-2023 prompt reco

- Time is estimated from the 10 sampled pulse amplitudes recorded at each bunch crossing (every 25 ns)
- The ratio of any two consecutive amplitudes $A(t)$ and $A(t+25 \text{ ns})$ determines the timing of a pulse measured in a crystal wrt the LHC clock

New ECAL Cross-Correlation time reconstruction algorithm developed and tested during Run2 to better cope with high pile up

- Associate a templated pulse shape with each out of time (OOT) amplitude
- Subtract these OOT pulses from the measured pulse to extract the in-time pulse
- Find the time that best matches the signal pulse to the templated pulse shape with a cross correlation fit

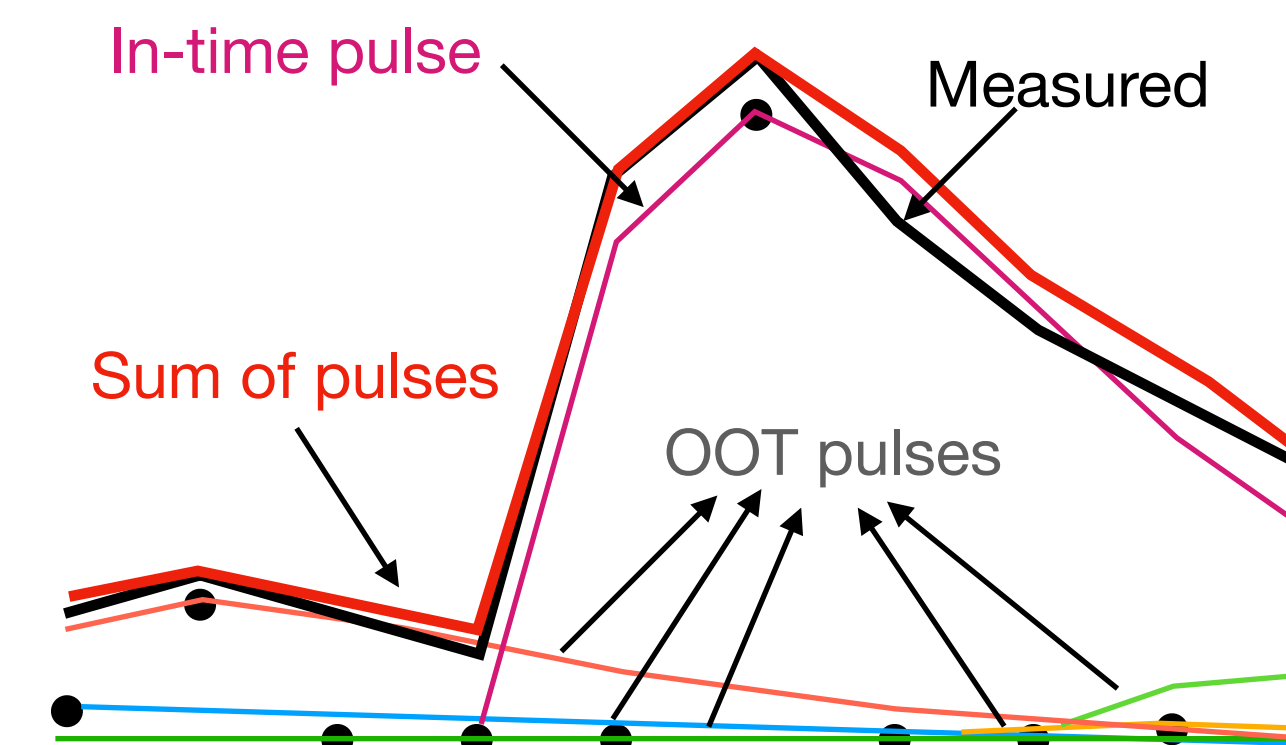

- ✓ Includes **rejection of non-scintillation signals and OOT pile-up awareness**
- ✓ **Cross-correlation is currently used in express and prompt reconstruction**, ratio timing is running at the HLT
- ✓ **Significant improvements in time resolution** with respect to default ratio algorithm observed both in Run2 and Run3
 - **Improvement of ~35 ps in $Z \rightarrow e^+e^-$** time resolution wrt ratio algorithm observed on Run 2 data
 - **Foreseen resolution for Run 3 ~100 ps** vs ~200 ps in Run 2
 - More on timing performance in [F. Orlandi's talk](#)

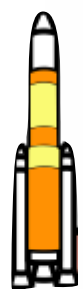

ECAL performance in Run 3: energy resolution

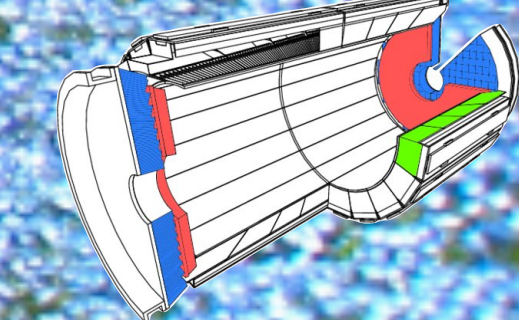

Relative electron energy resolution computed with $Z \rightarrow e^+e^-$ versus pseudorapidity

- **A stable ECAL energy resolution is observed in 2022 and 2023** despite the increased LHC luminosity and the detector ageing
 - **Performance with respect to Run 2:** slight loss due to increased pile up
 - Regression (to correct for losses in the detector and pile up) was not trained as well as Run2 one
 - more details on past performance in [F. Orlandi's talk](#)
 - Higher PF rechit thresholds, on electrons shower more than on photons
- Can be improved using **DeepNN SuperClustering**

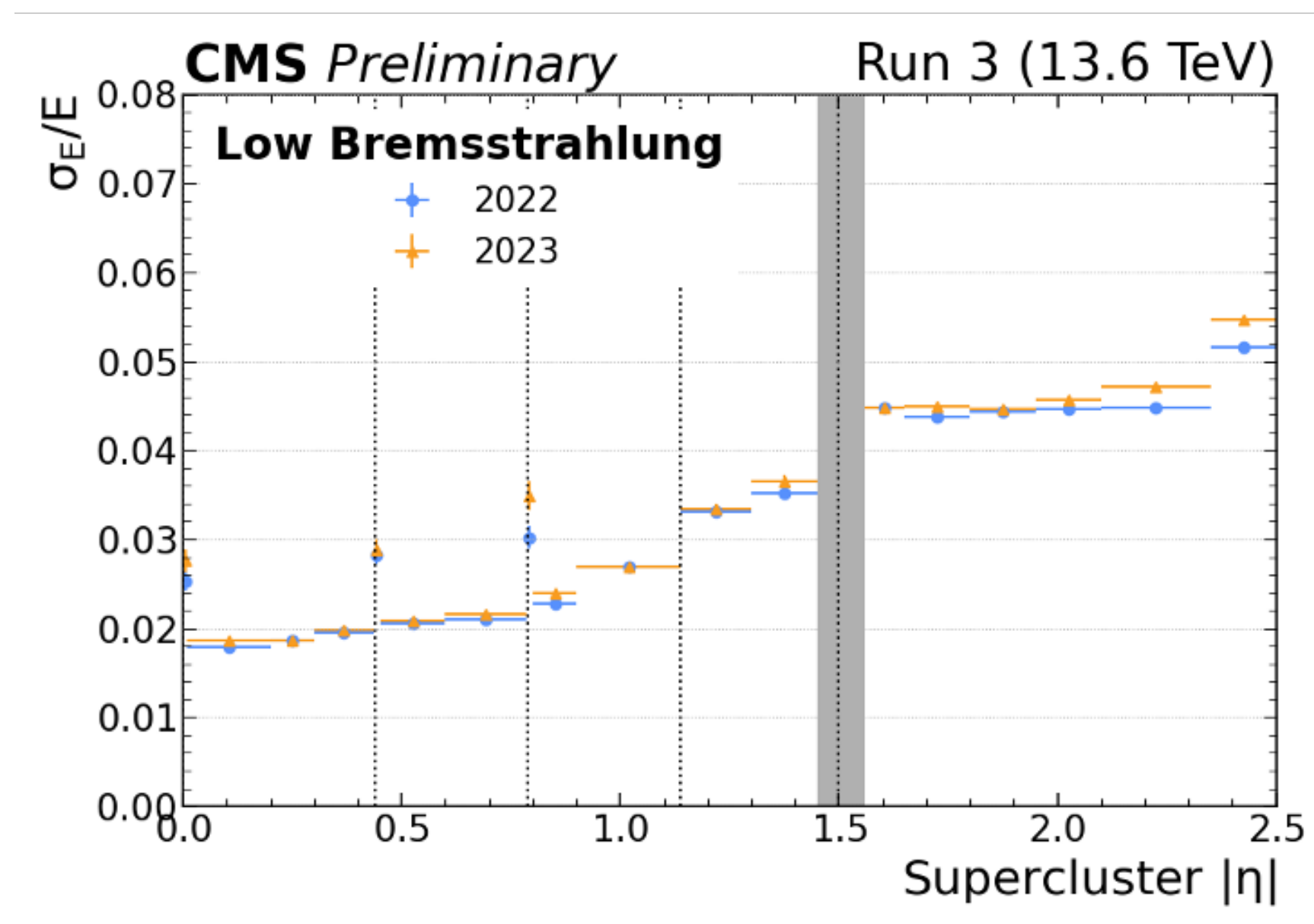
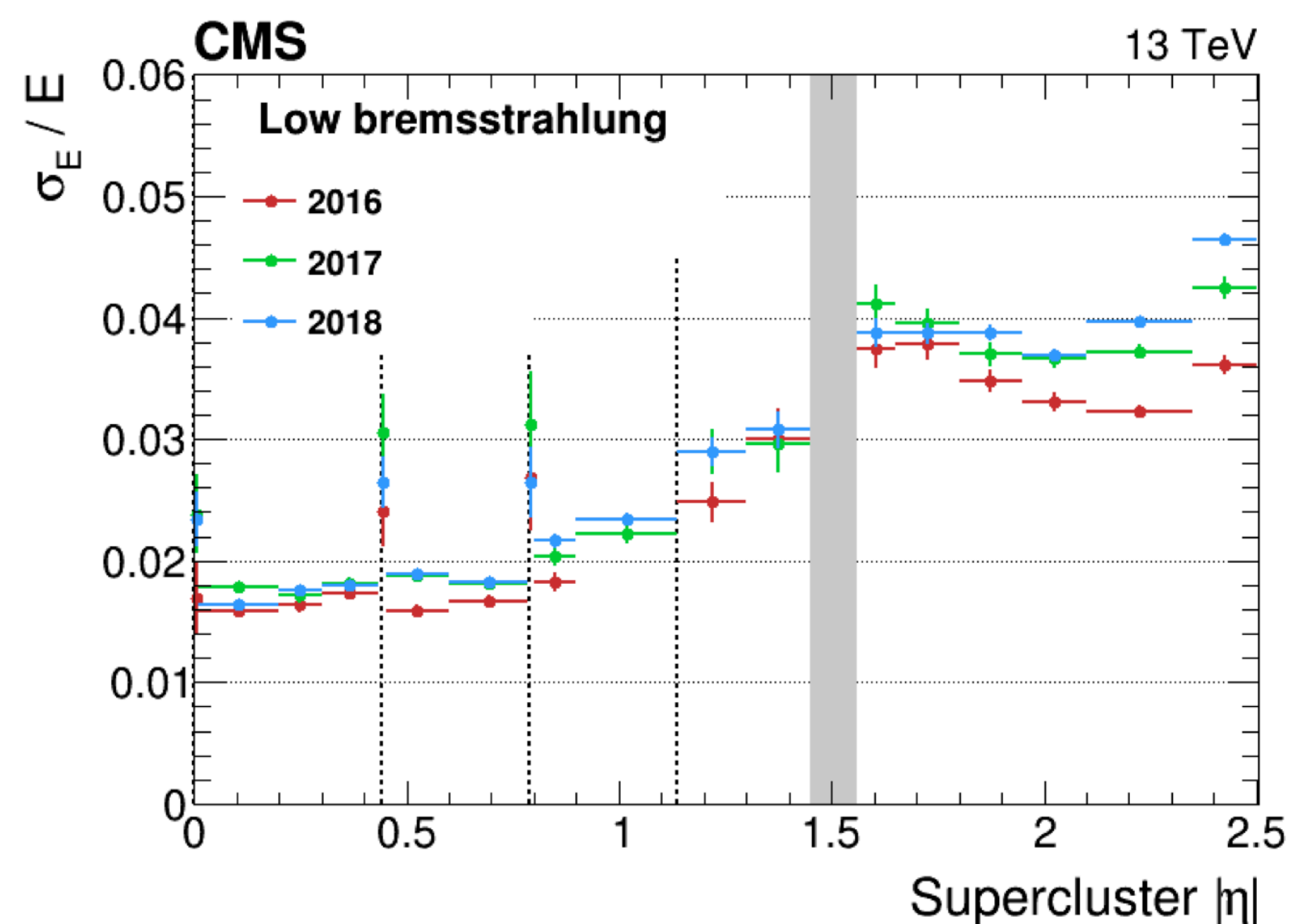

Plots from: [CMS-DP-2020-021](#), [CMS DP-2024/022](#)

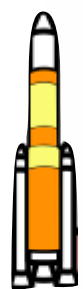

Deep NN SuperClustering

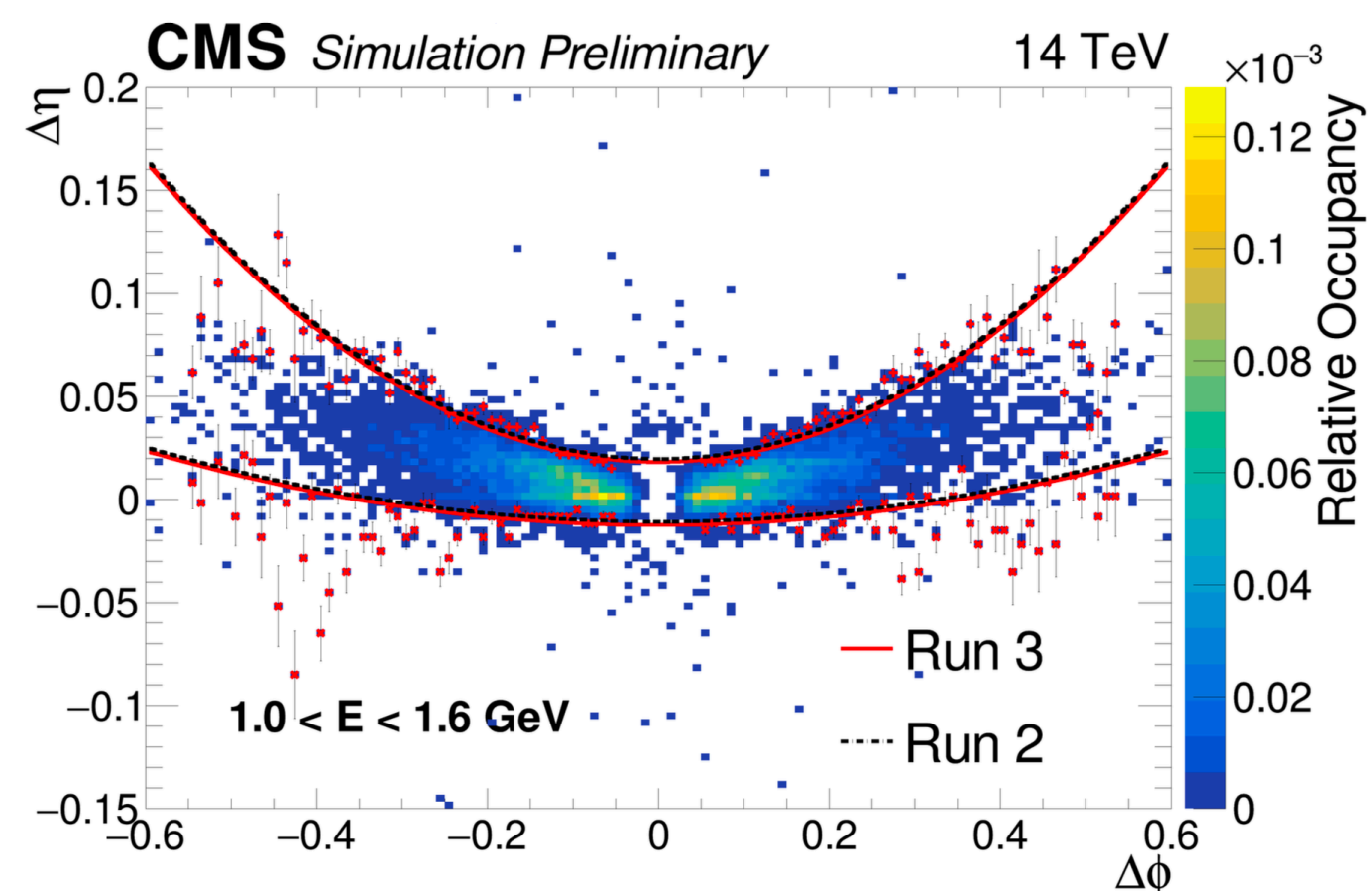
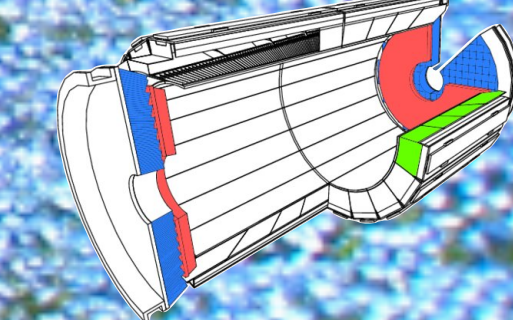

Mustache is the standard method for clustering of EM energy deposits in ECAL

- Clusters are formed by aggregating crystals within the expected topology of an EM shower
- Satellite clusters around the primary one are associated to the seed using **topological algorithms**

→ **Spurious energy from PU is not removed: performance degradation during Run 3**

Deep NN SuperClustering is a more sophisticated model based on **Neural Networks**

- Built with graph neural networks **exploiting both crystal-level and cluster-level information**
 - Clusters close to the highest energy one (seed) are grouped together and **analyzed by the ML model** to predict their association and reconstruct the SuperCluster
 - Can be used to **distinguish between jets and EM showers**
- **More resilient to noise and PU contamination**

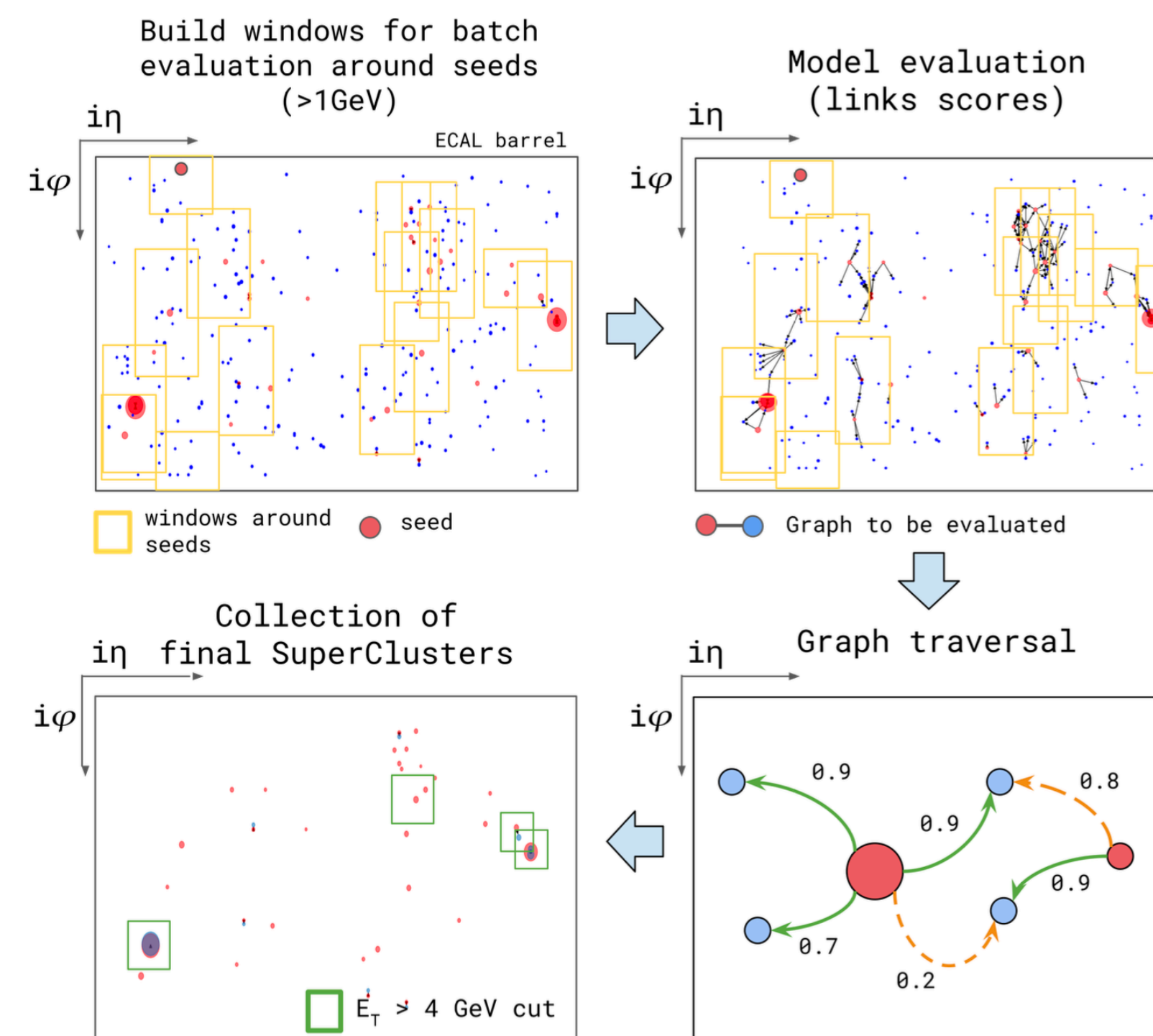



Deep NN SuperClustering

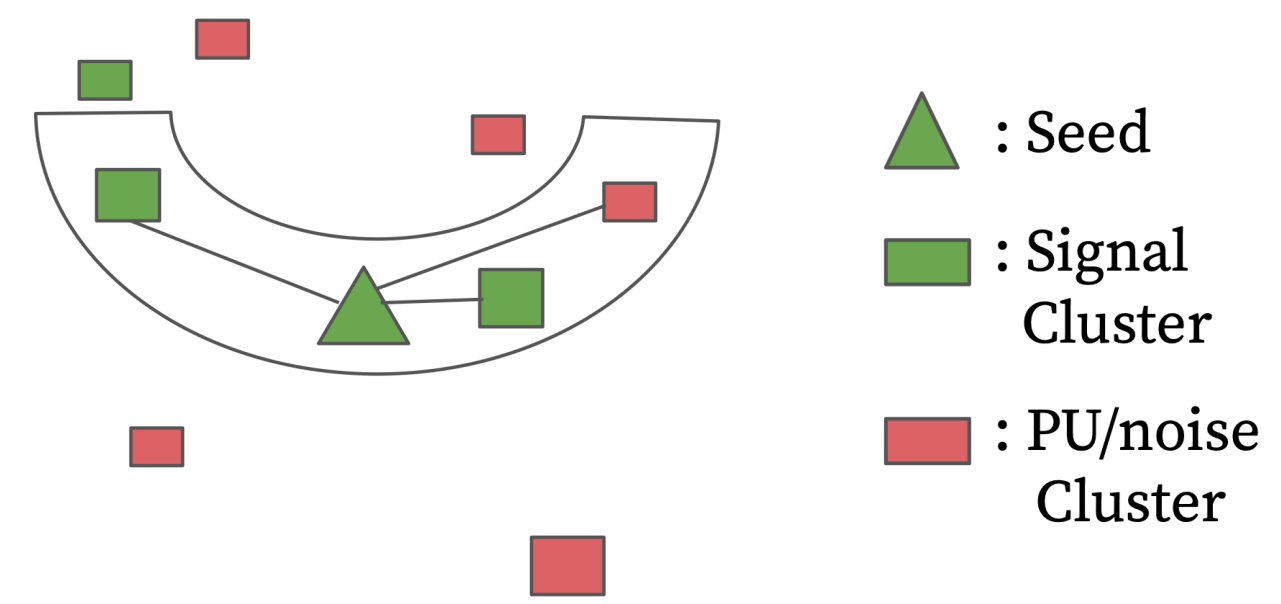
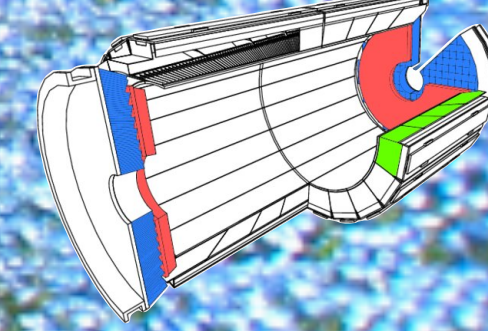

Ratio of DeepNNSC and Mustache resolutions

- ✓ **Improvement for high energy electrons**, especially at $1.0 < |\eta| < 1.5$, where more secondary deposits are produced due to the high material budget in front of ECAL
- ✓ **Significant improvement for photons**, which produce less secondary deposits
- ✓ Resolution is **independent on pile up**
- ✓ The improvement is still present **after applying a dedicated energy regression** to recover on average losses in the detector and pile up

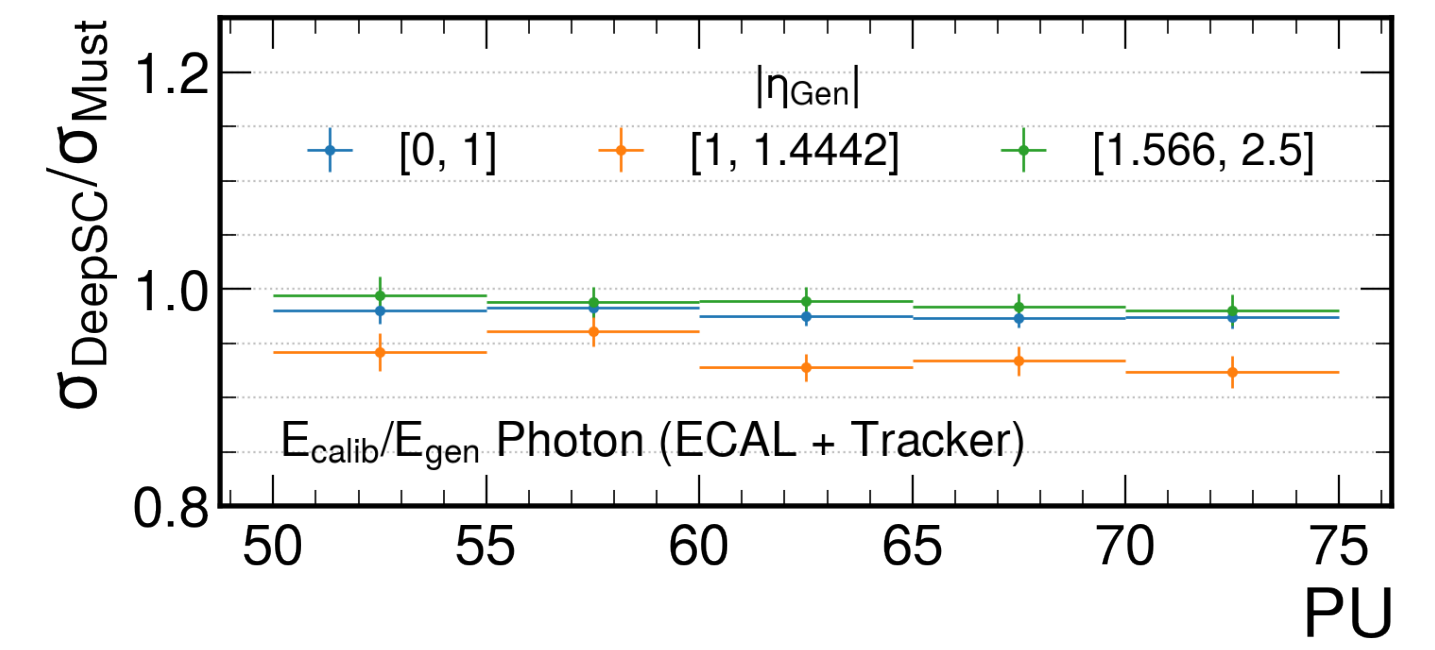
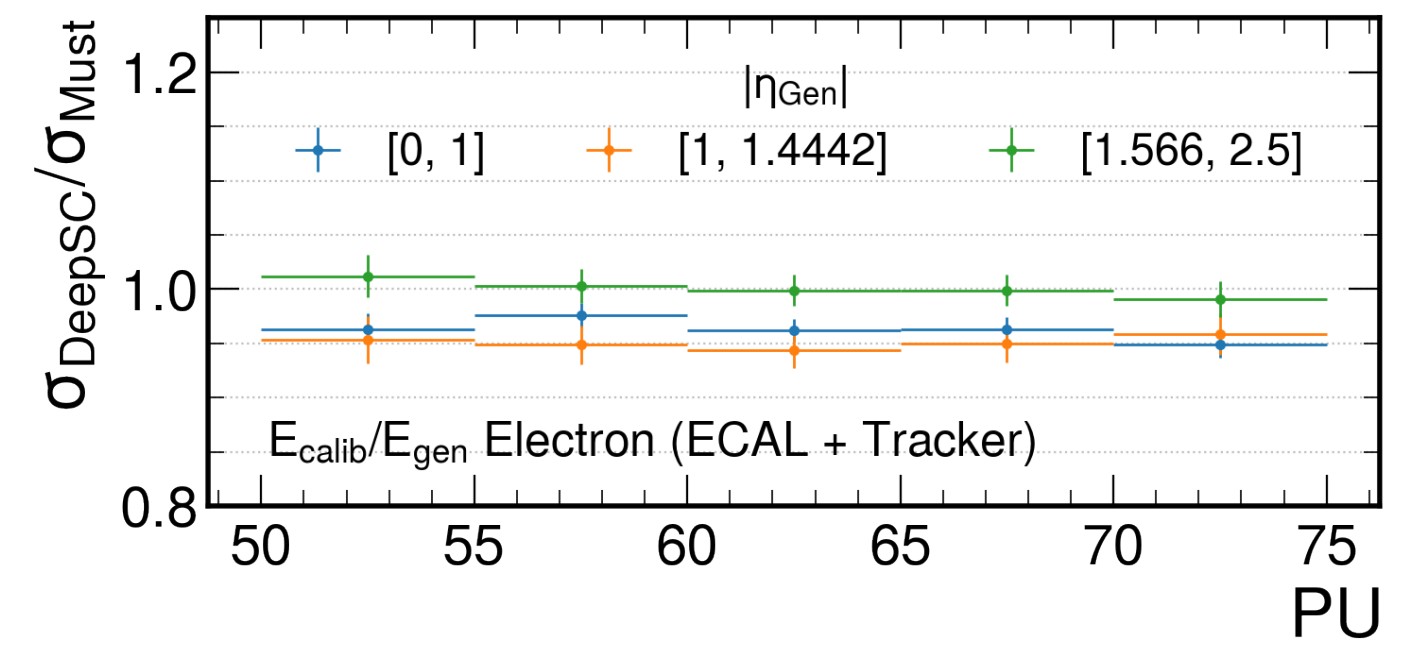
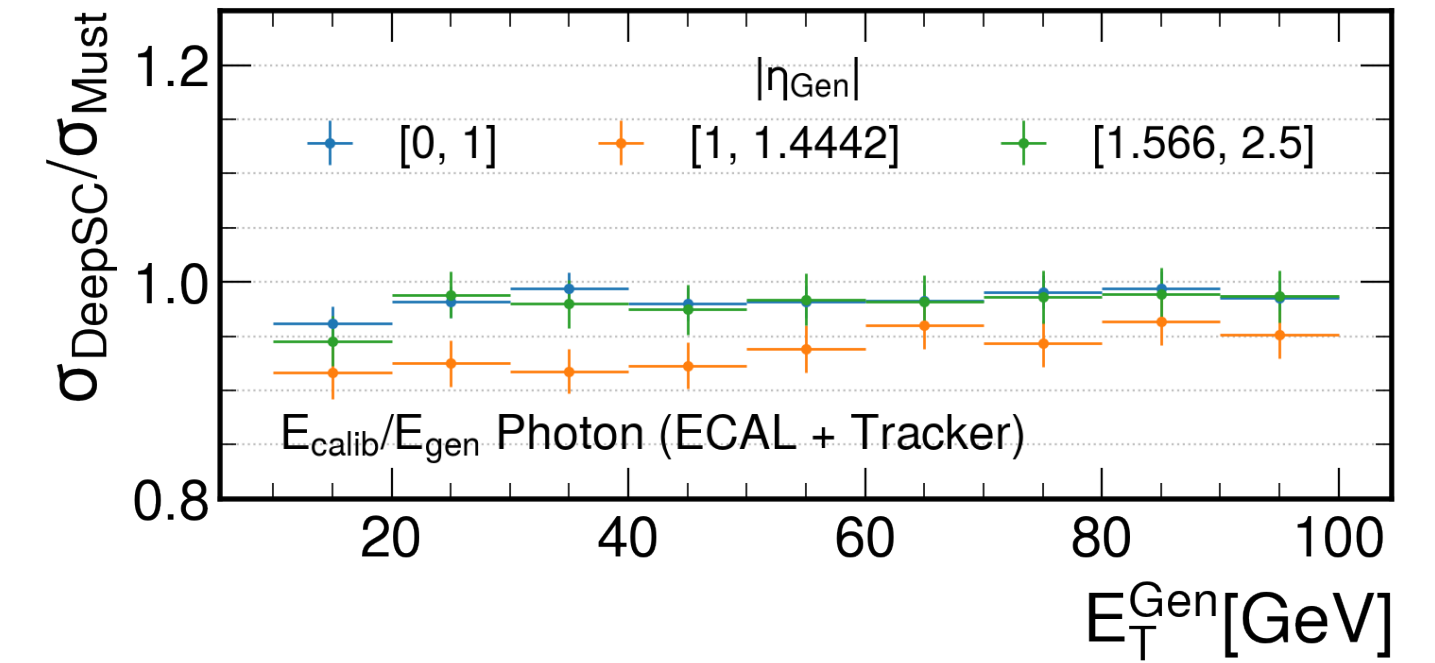
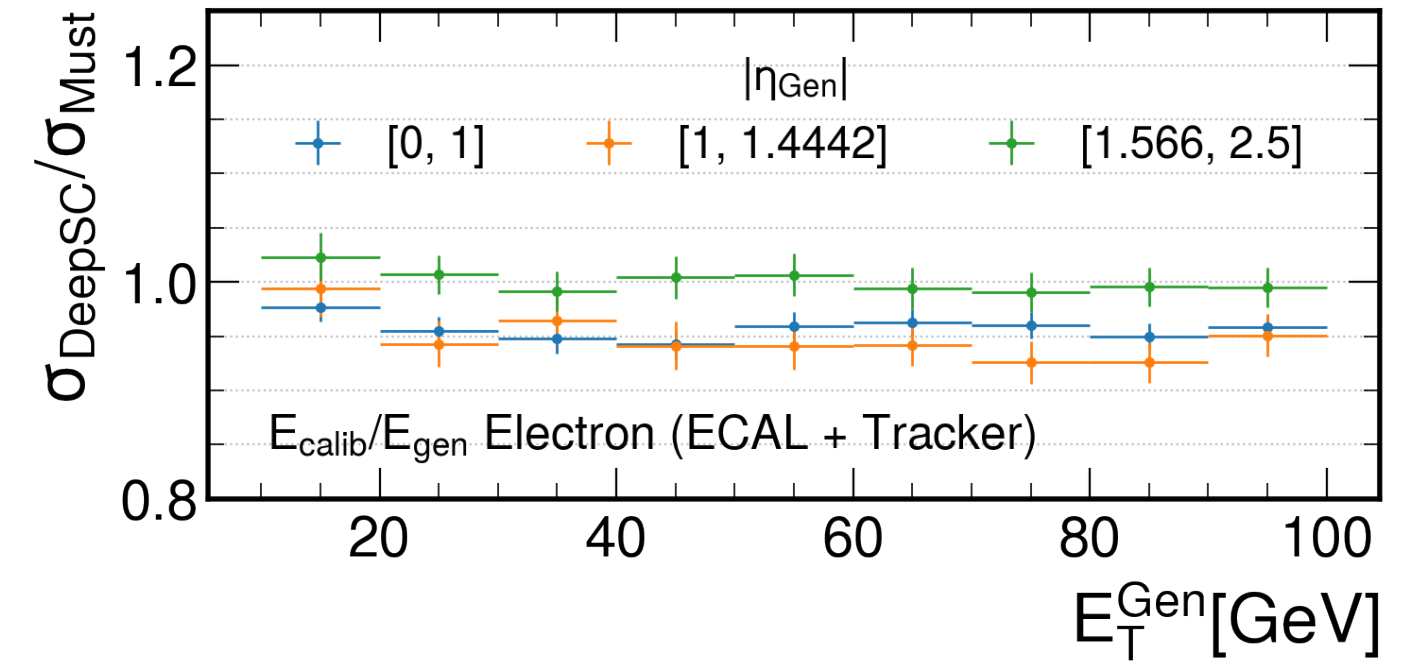
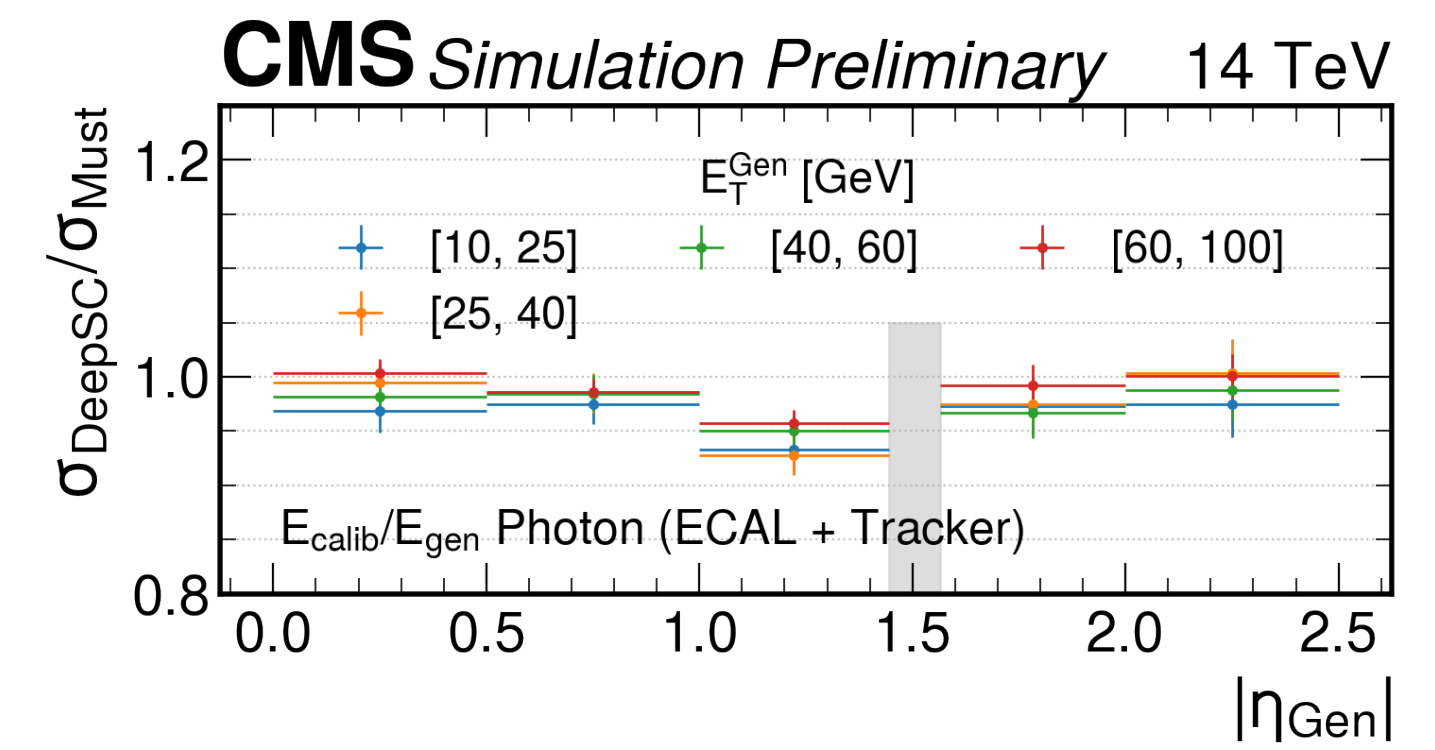
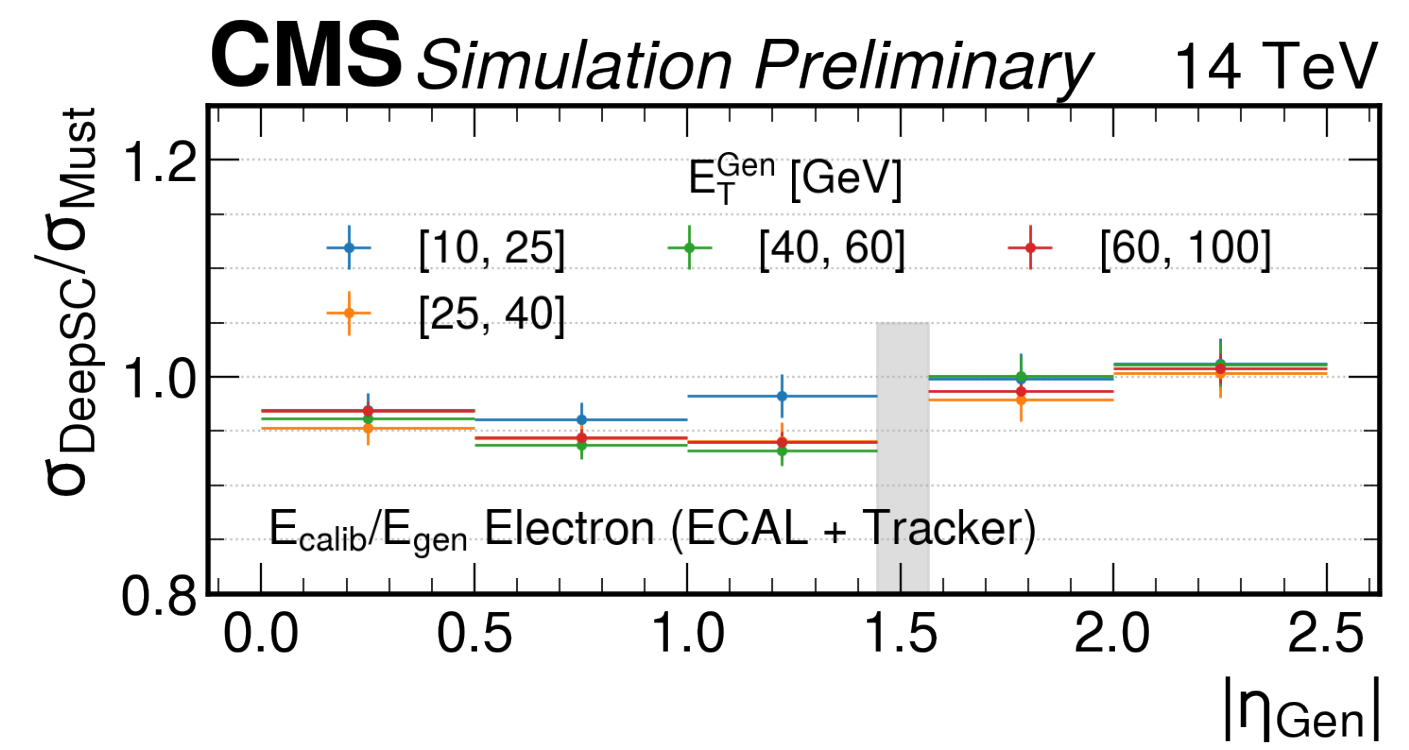

Plots from [CMS-DP-2022-032](#)

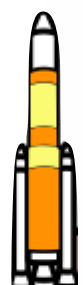

Conclusions

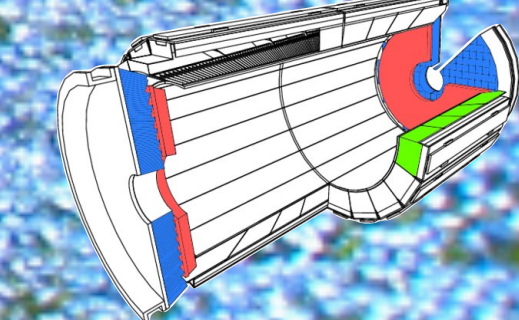

The **CMS Electromagnetic Calorimeter** (ECAL) is the largest electromagnetic calorimeter in high energy physics and is **essential in the CMS physics program** thanks to its excellent measurements of energy, position and time of arrival of photons and electrons

During Run 3, **LHC experienced the largest instantaneous luminosity up to now**, and CMS will experience a further increase of pile up and trigger rate this year

→ **need to maintain ECAL performance in a harsh environment despite detector ageing**

Applied strategy:

- Implementation of **new measures to improve operations efficiency** and face new challenges
- **Automation of solid Run 2 algorithms and calibrations**
- **Development of new tools** for reconstruction procedures suffering from degradation due to pile up
 - **DeepNN SuperClustering**, **Cross-Correlation time reconstruction**
- Improvement of laser monitoring system with a **new green laser** to face high radiation levels

→ **Run 2 performance can be maintained in 2022-2023 data**

Next steps for Run 3 performance and beyond:

- Keep on **automating ECAL calibrations**
- **Complete the development of new algorithms** to make them default
- **Upgrade of the laser monitoring system** for High Luminosity LHC
 - More on ECAL upgrades in [F. Orlandi's poster](#)

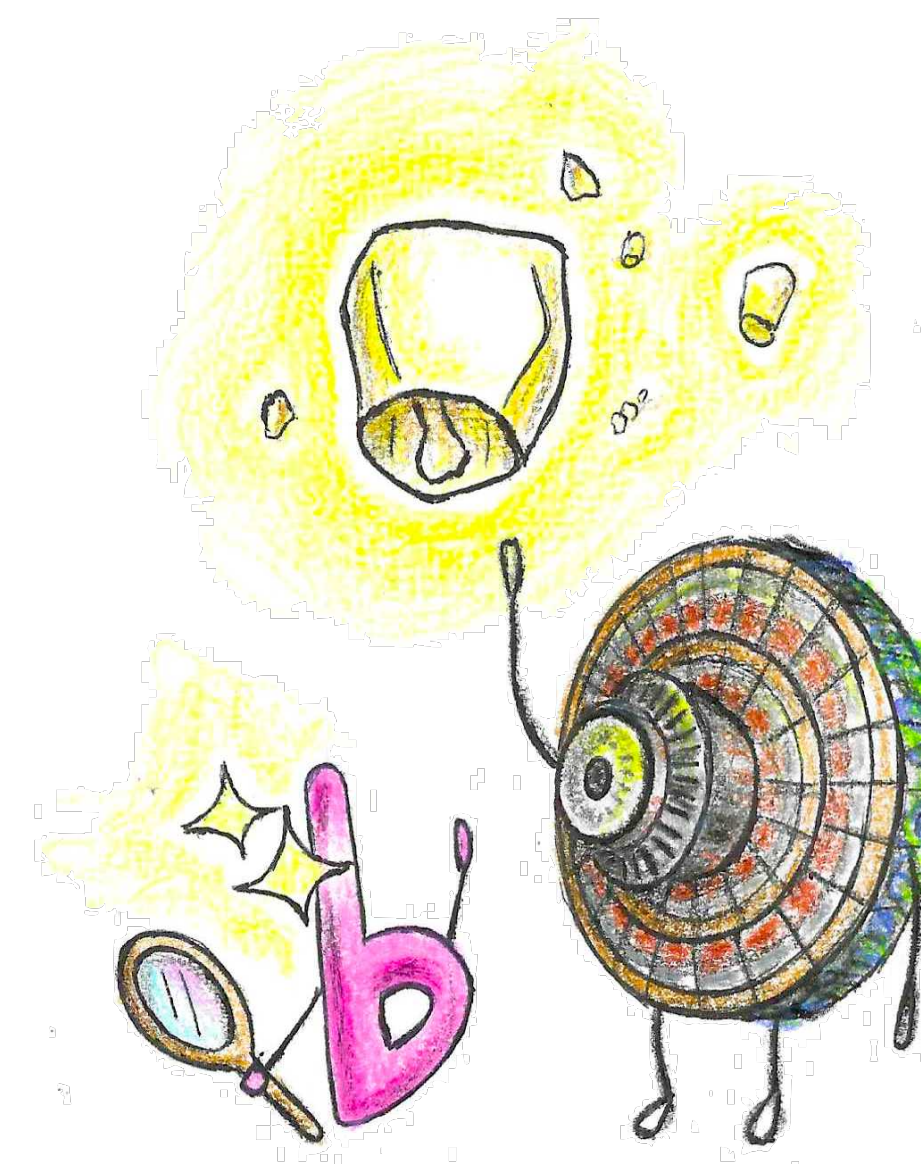

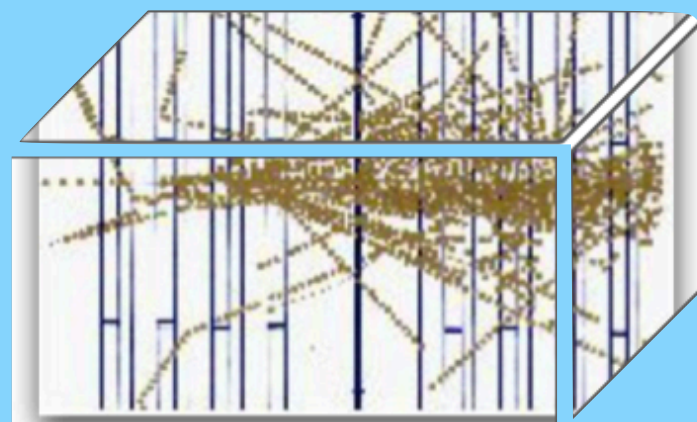

CALOR 2024

Tsukuba

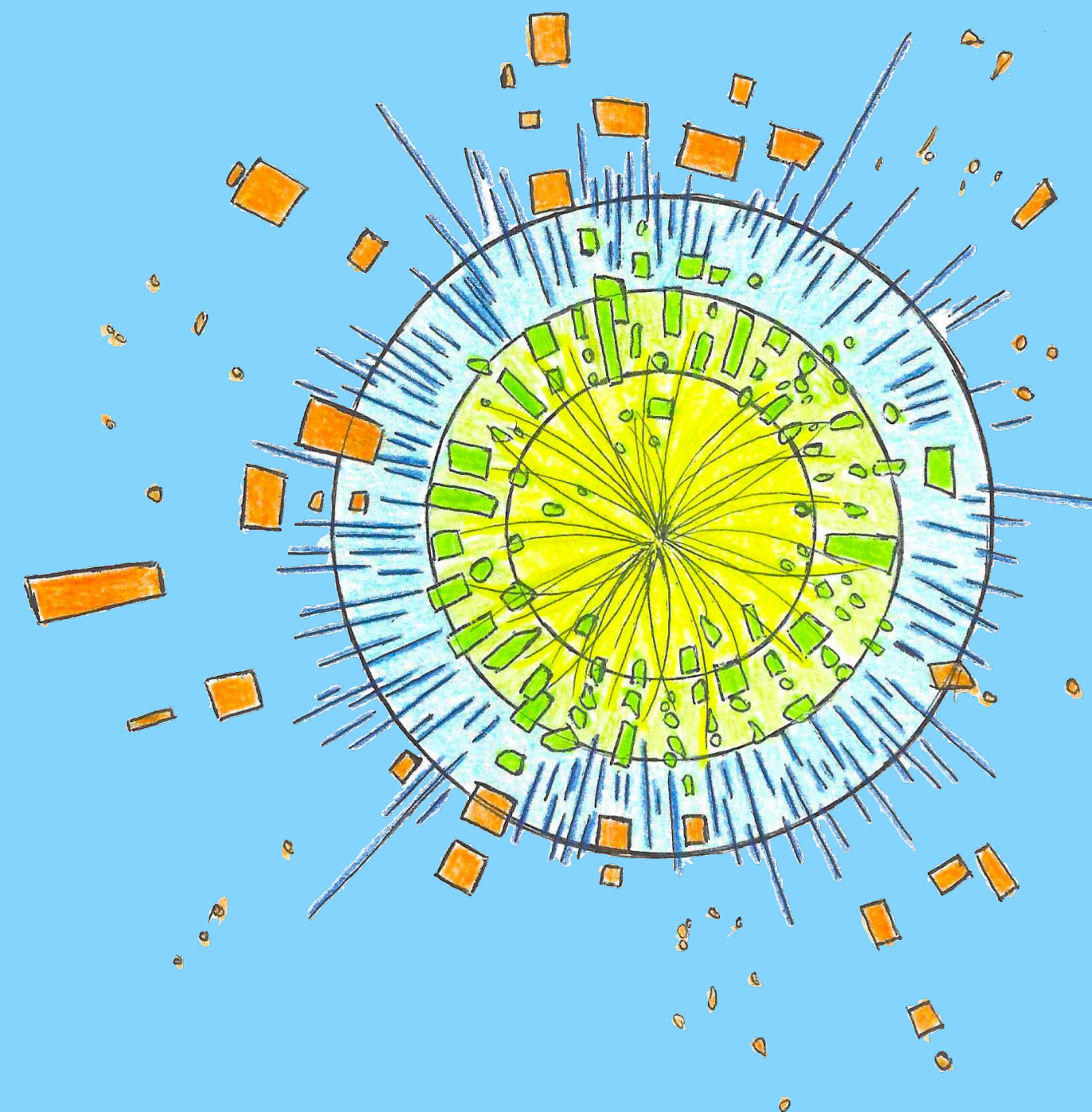

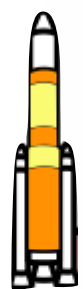

The CMS Electromagnetic Calorimeter

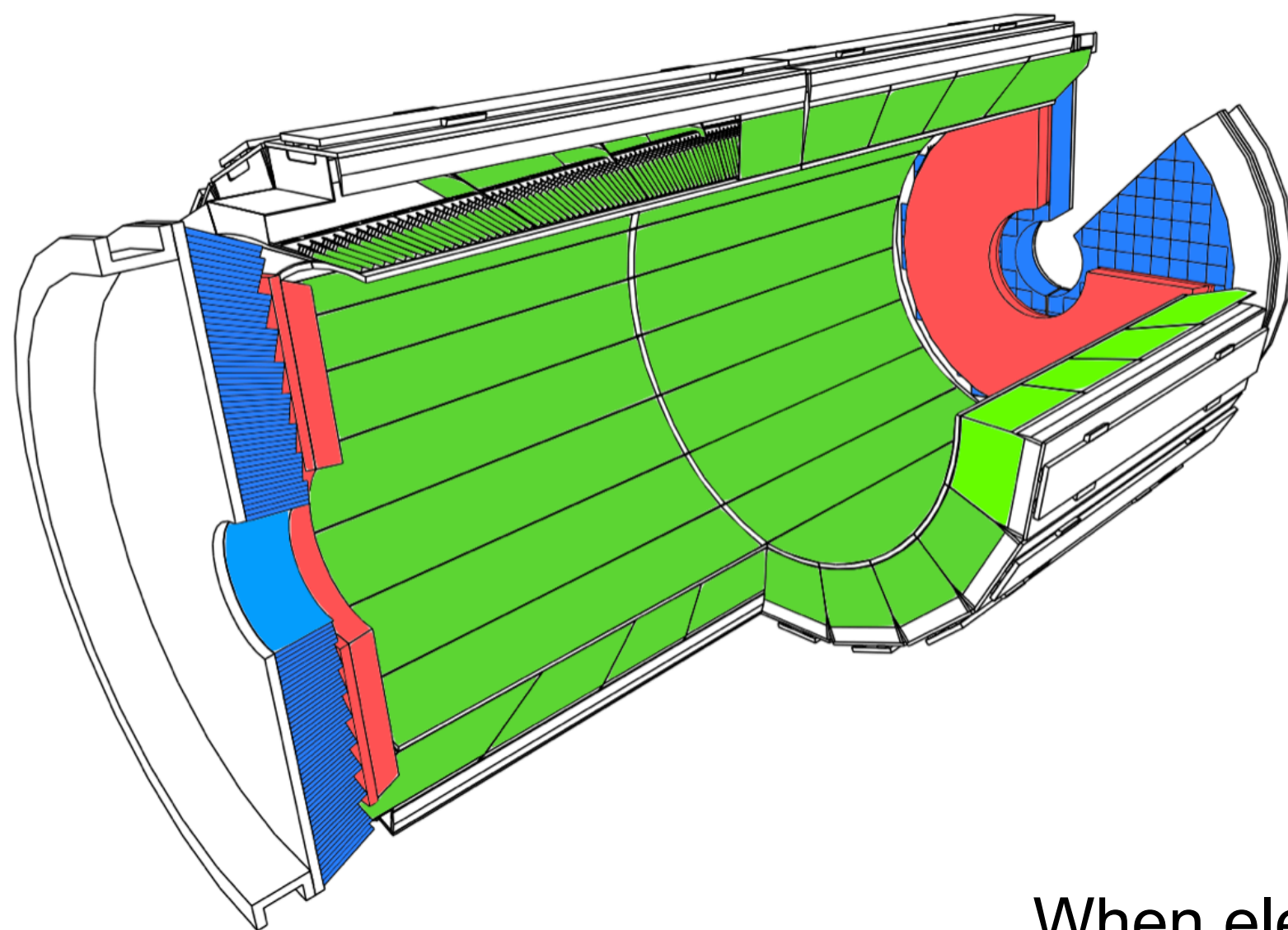
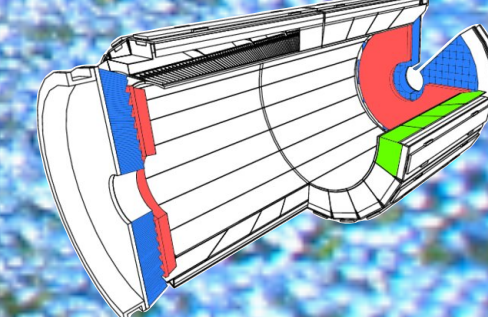

The **Electromagnetic Calorimeter** (ECAL) of CMS is the subdetector used to measure **electrons and photons energy, position and time of arrival**

ECAL is an homogeneous calorimeter installed in the **barrel** (EB) and the **endcap** (EE) regions of CMS made of 75848 **lead-tungstate crystals**

Crystals are readout by APDs in the barrel and by VPTs in the endcaps

It also includes the **preshower** (ES), a double-layer **lead/silicon strip detector** in front of ECAL endcaps used to distinguish photons from pion decays

When electrons and photons traverse ECAL crystals, they produce **scintillation light, proportional to their energy**

ECAL has a fundamental role in CMS physics program

Its **excellent energy resolution** was essential for the **Higgs discovery** in 2012 and the precise measurement of its properties in the diphoton decay channel

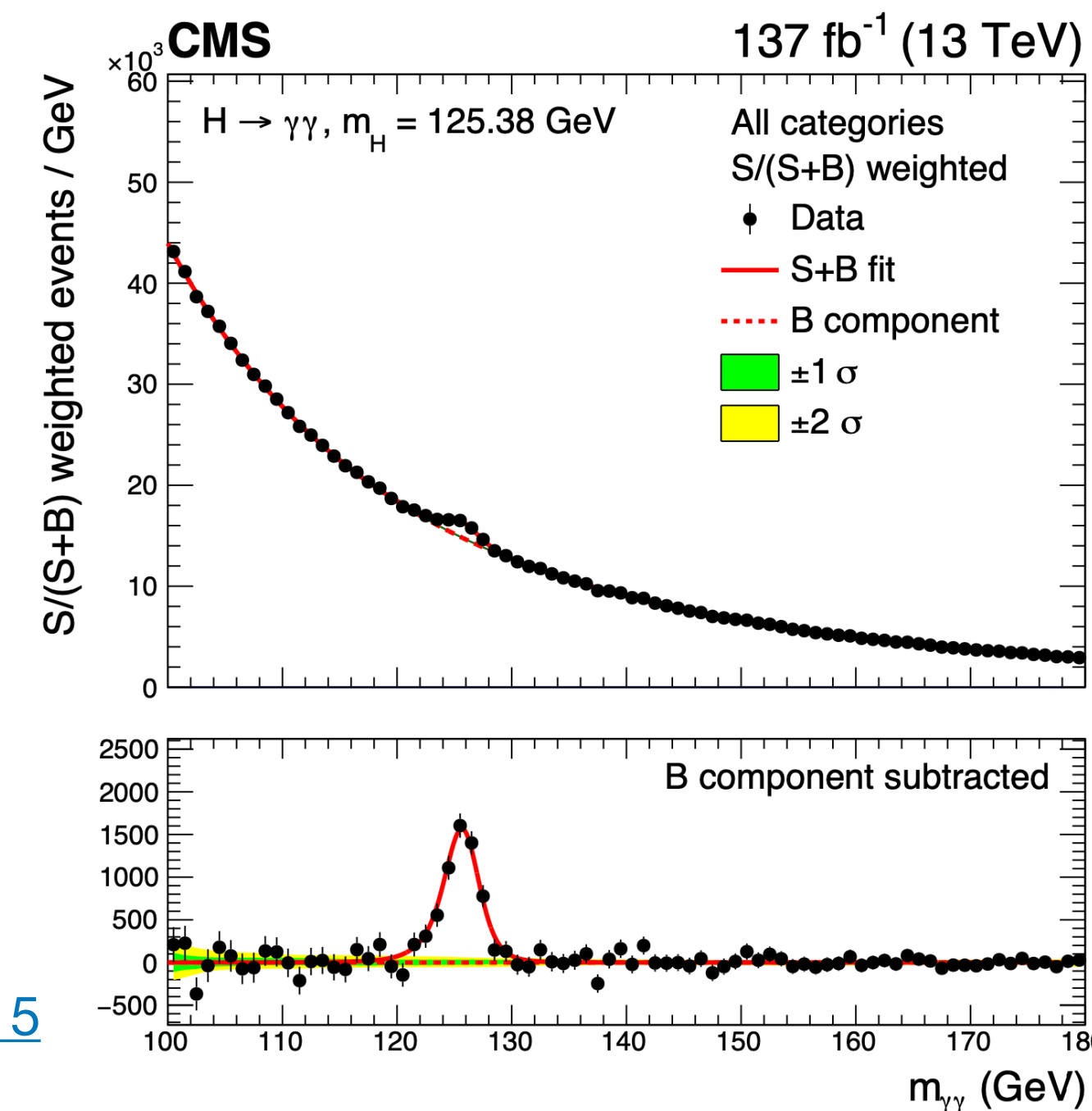
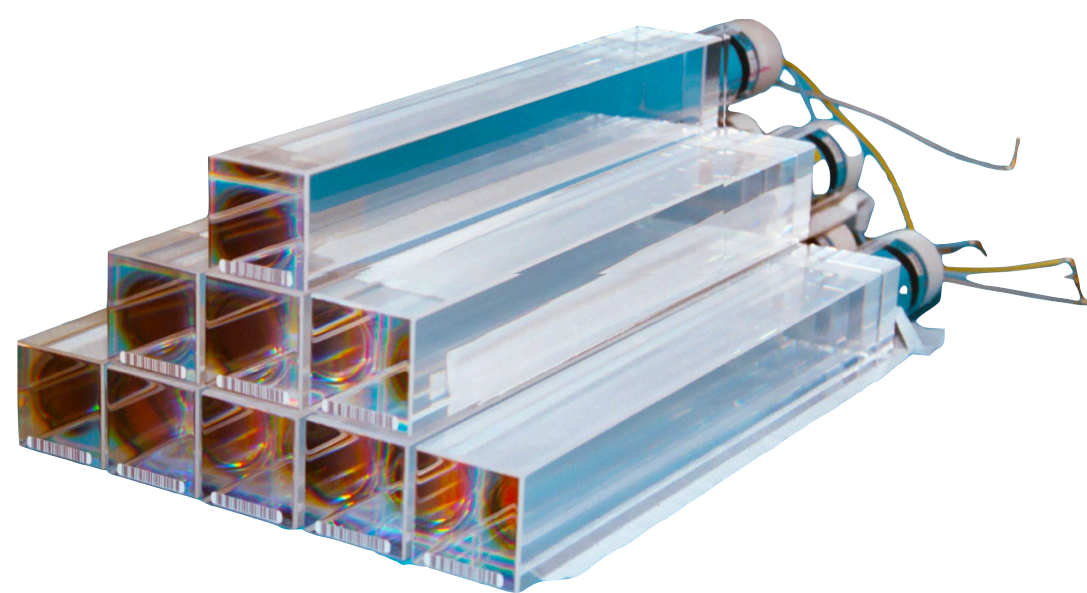

Plot from: [CMS-HIG-19-015](https://cds.cern.ch/record/2710157/files/CMS-HIG-19-015)

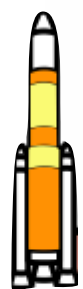

Energy intercalibration

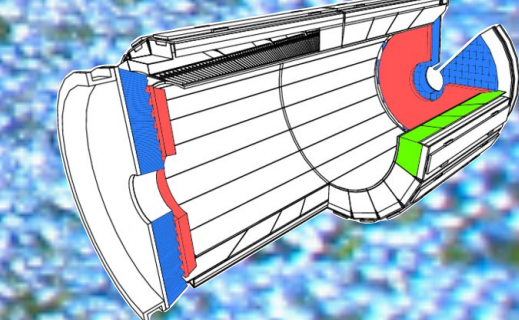

Energy scale corrections using physics are applied to transparency corrections obtained with the laser monitoring system, that might be affected by **damages or changes in the behaviour of reference PN diodes** over time

Corrections are computed with **E/p method**:

- Considering W, Z decaying in electrons
- E is ECAL SuperCluster energy and p the tracker momentum
- Using both template fit and median of E/p

Median of E/p seem more reliable than template fit

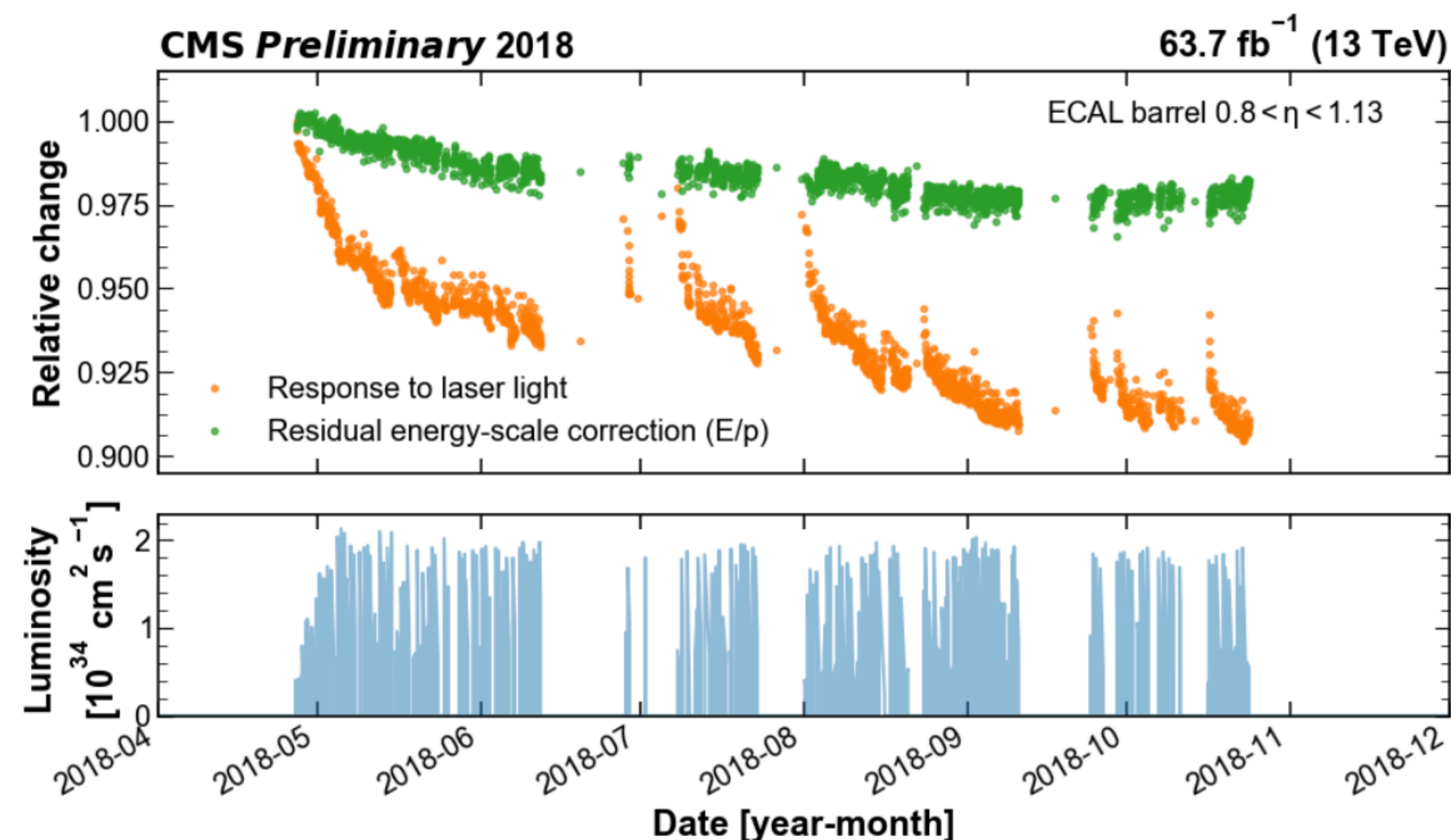

Plot from [CMS-DP-2019-030](#)

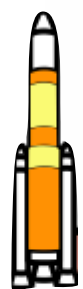

Energy intercalibration

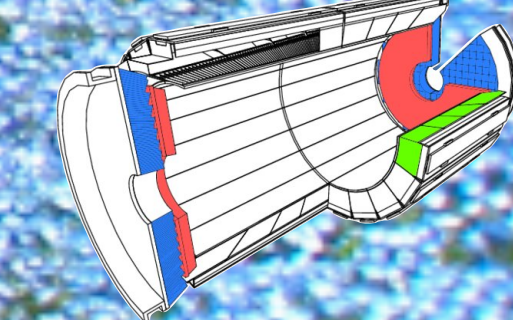

$\pi^0 \rightarrow \gamma\gamma$ intercalibration:

- Benefit from large datasets but suffer from uncertainty from low p_T photons
- Can achieve **compatible precision to Z peak calibration**
- **IC results in 2022 comparable with Run 2 results**

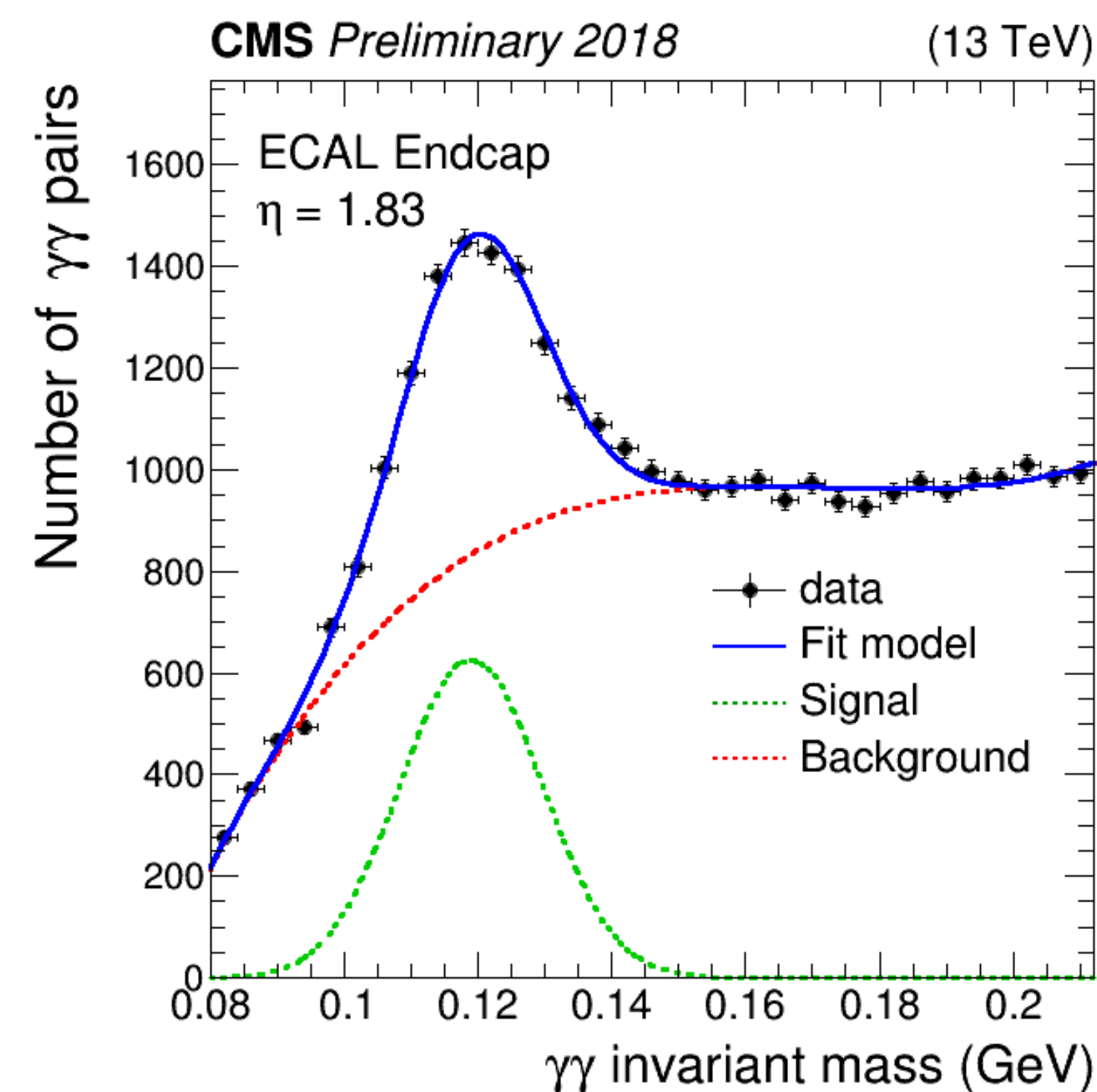
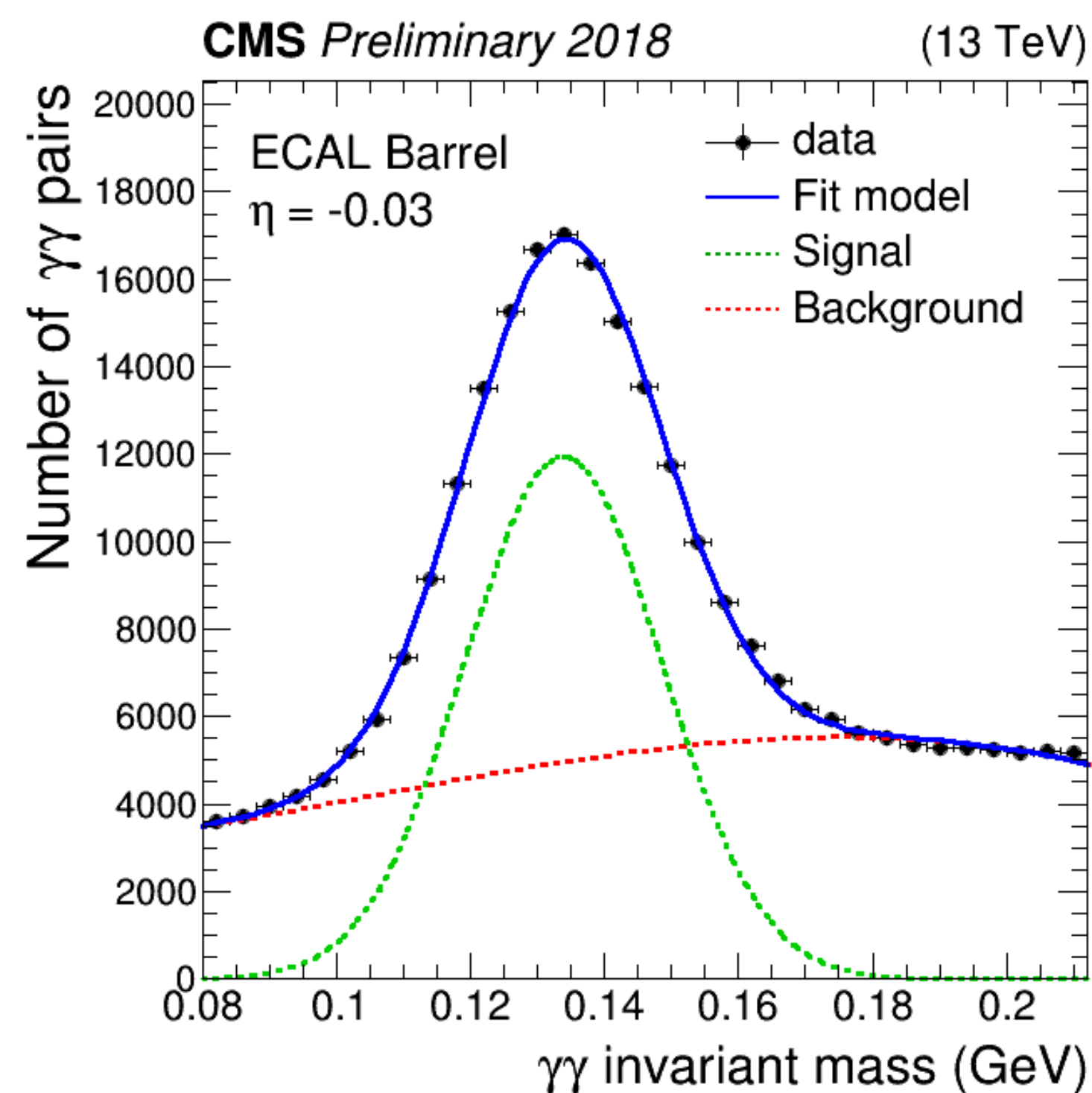

Plots from: [CMS-DP-2020-021](https://arxiv.org/abs/2002.021)



Energy resolution

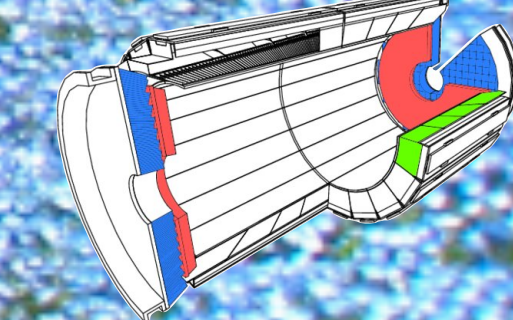

Good ECAL performance during Run 3 considering luminosity increase and detector ageing

- **Invariant mass distribution for $Z \rightarrow e^+e^-$** requiring two electrons in EB or EE
- Inclusive resolutions for all electrons are **< 2% in EB and ~ 3.2% in EE**
(Run 2: ~1.7%, 2.8%)
- Low Bremsstrahlung ($R_9 > 0.965$, unconverted electrons) resolutions are **~ 1.5% in EB and ~ 3% in EE**
(Run 2: ~1.3%, 2.4%)
- High Bremsstrahlung ($R_9 < 0.965$, electrons converted in the tracker) resolutions are **~ 2.4% in EB and ~3.6% in EE**
(Run 2: ~2%, 3.2%)

→ **Possibility to improve with the implementation of new algorithms** like DeepNN SuperClustering

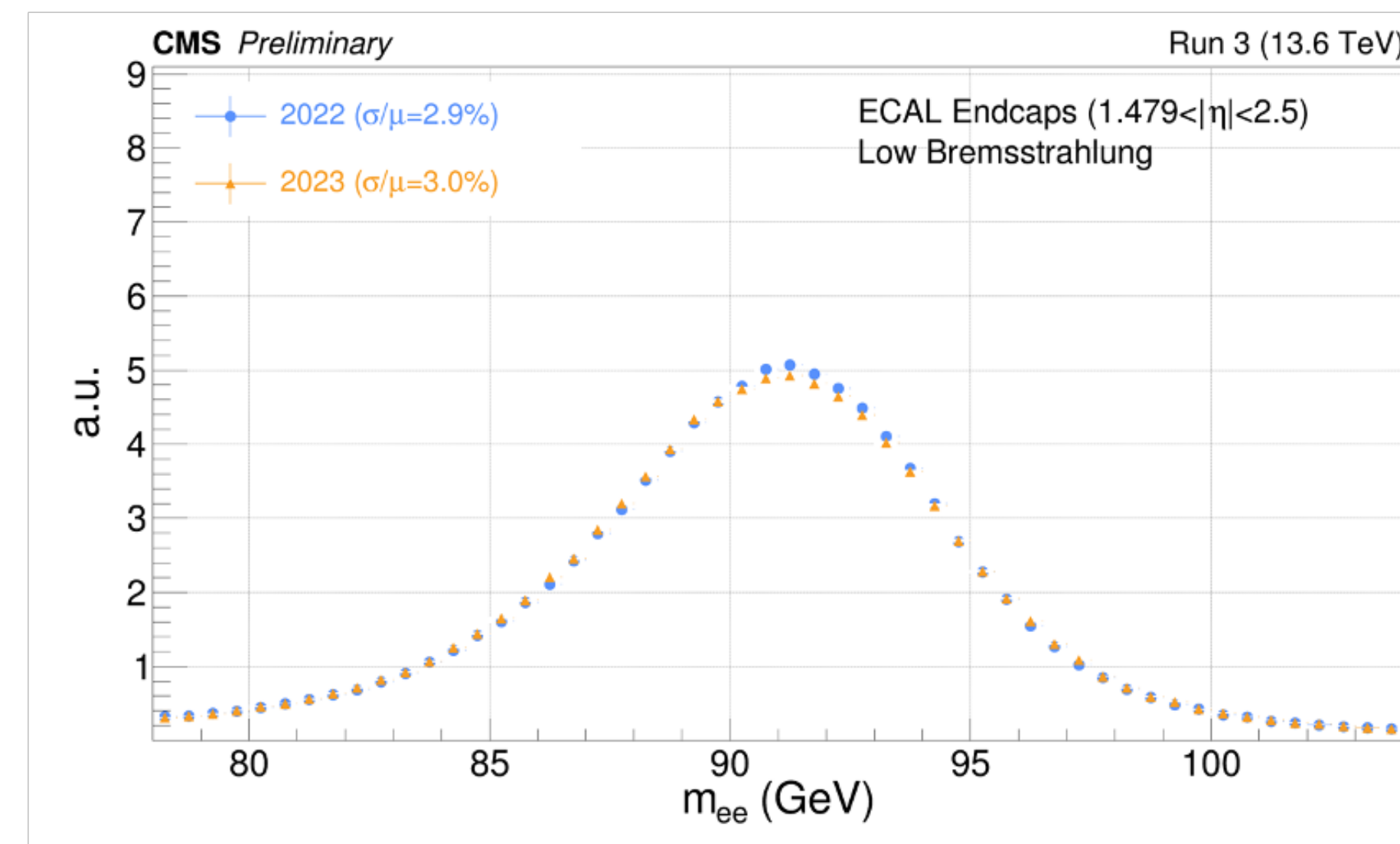
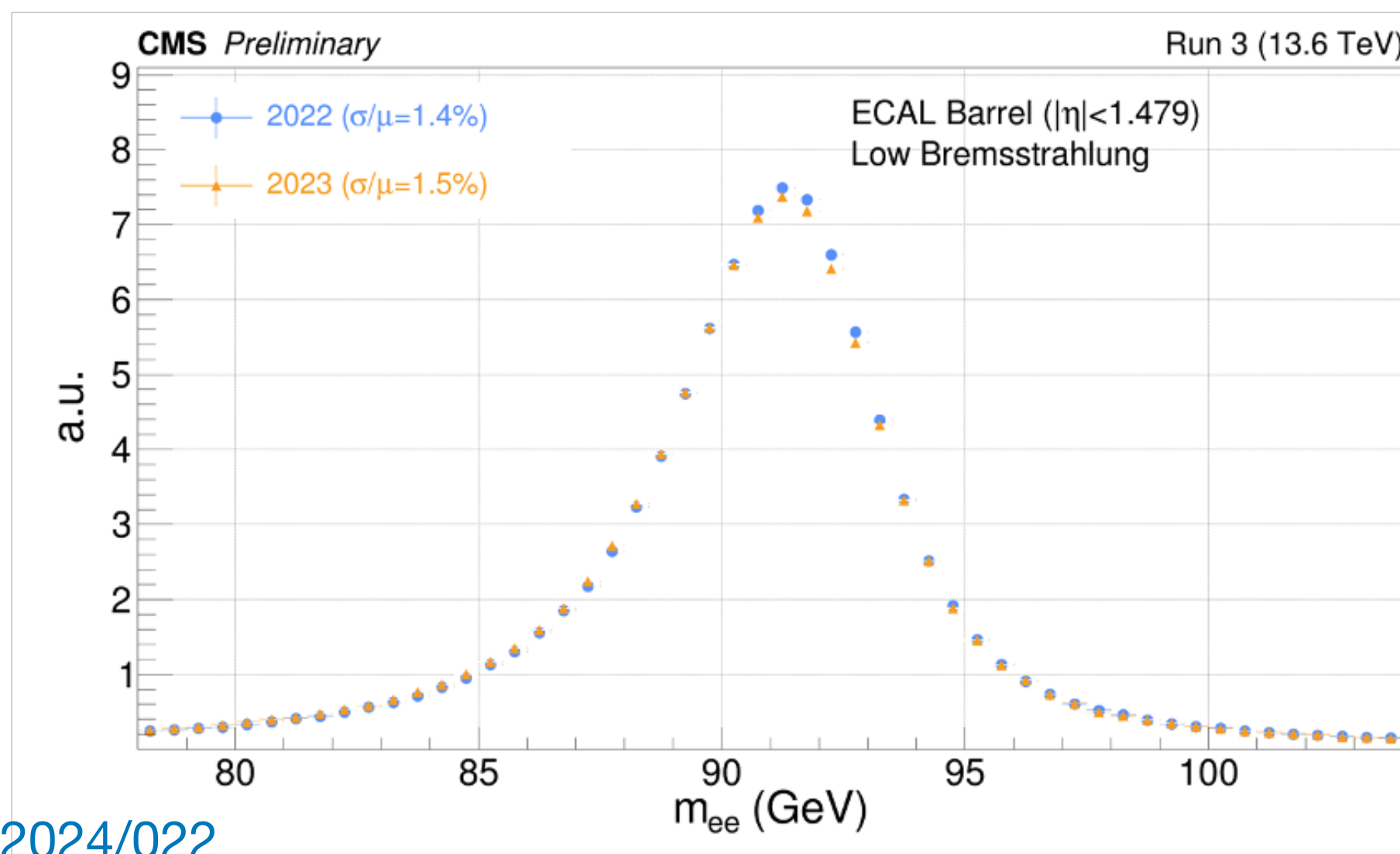

Plots from [CMS DP-2024/022](https://cds.cern.ch/record/2871111/files/CMS-DP-2024-022)



Energy resolution

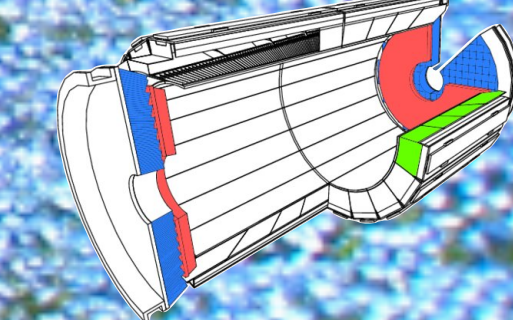

Good ECAL performance during Run 3:

- **Relative electron energy resolution** computed with $Z \rightarrow e^+e^-$ versus pseudorapidity
- Relative resolution extracted from an unbinned likelihood fit to $Z \rightarrow e^+e^-$ events using a convolution of a Breit-Wigner with a gaussian as signal model
- **A stable ECAL energy resolution is observed in 2022 and 2023** despite the increased LHC luminosity and the detector ageing

→ Possibility to improve with the implementation of new algorithms like DeepNN SuperClustering

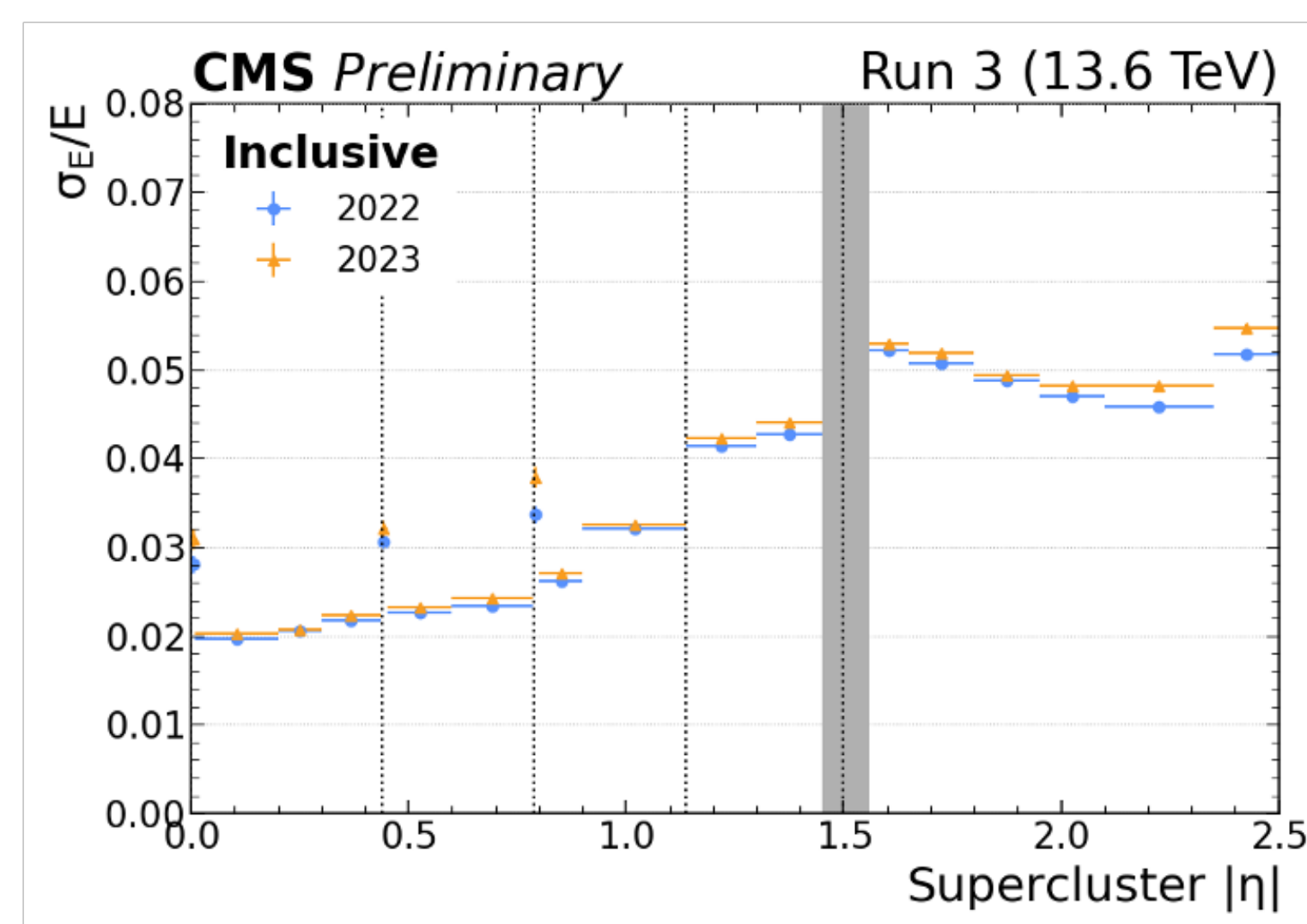
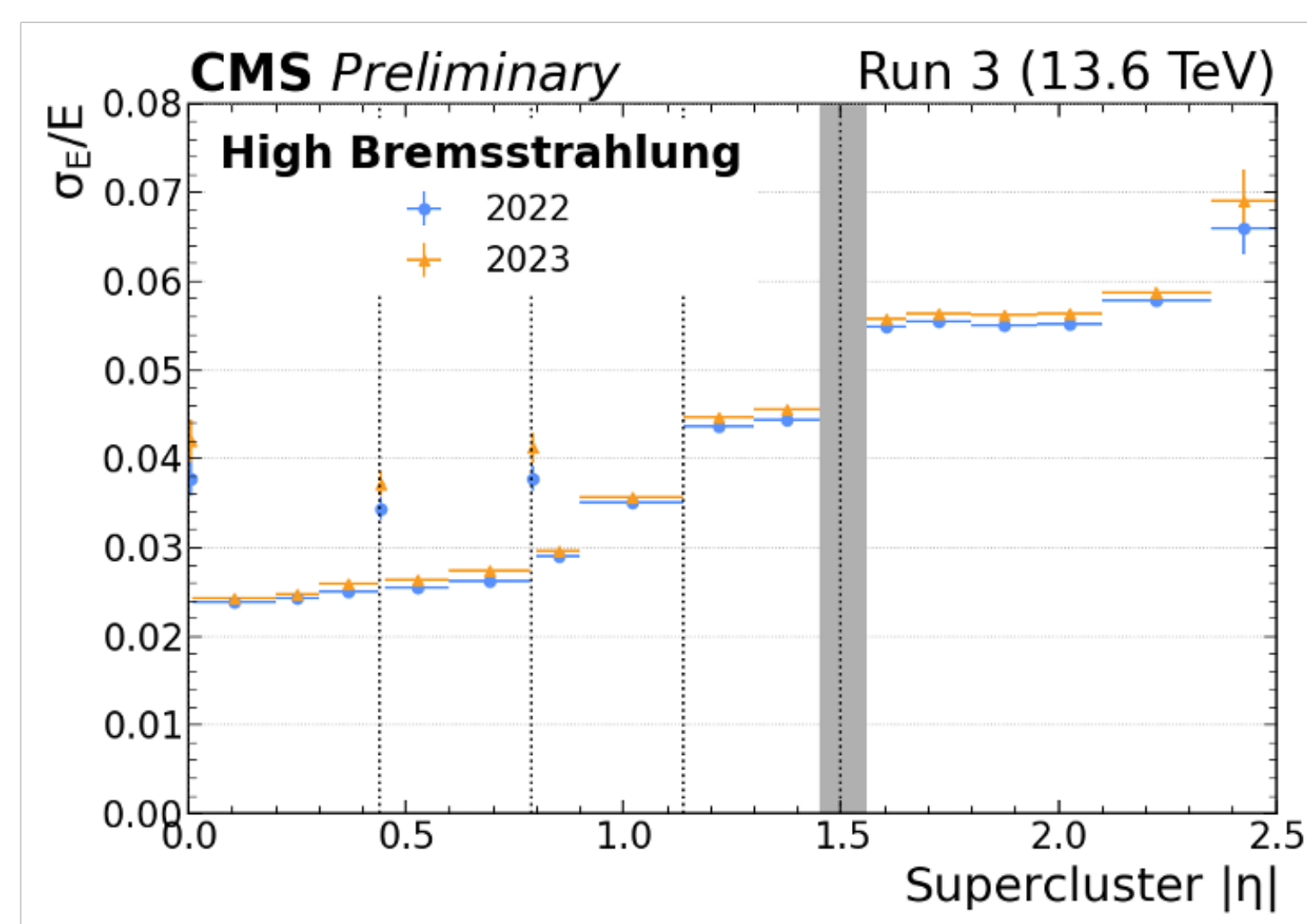
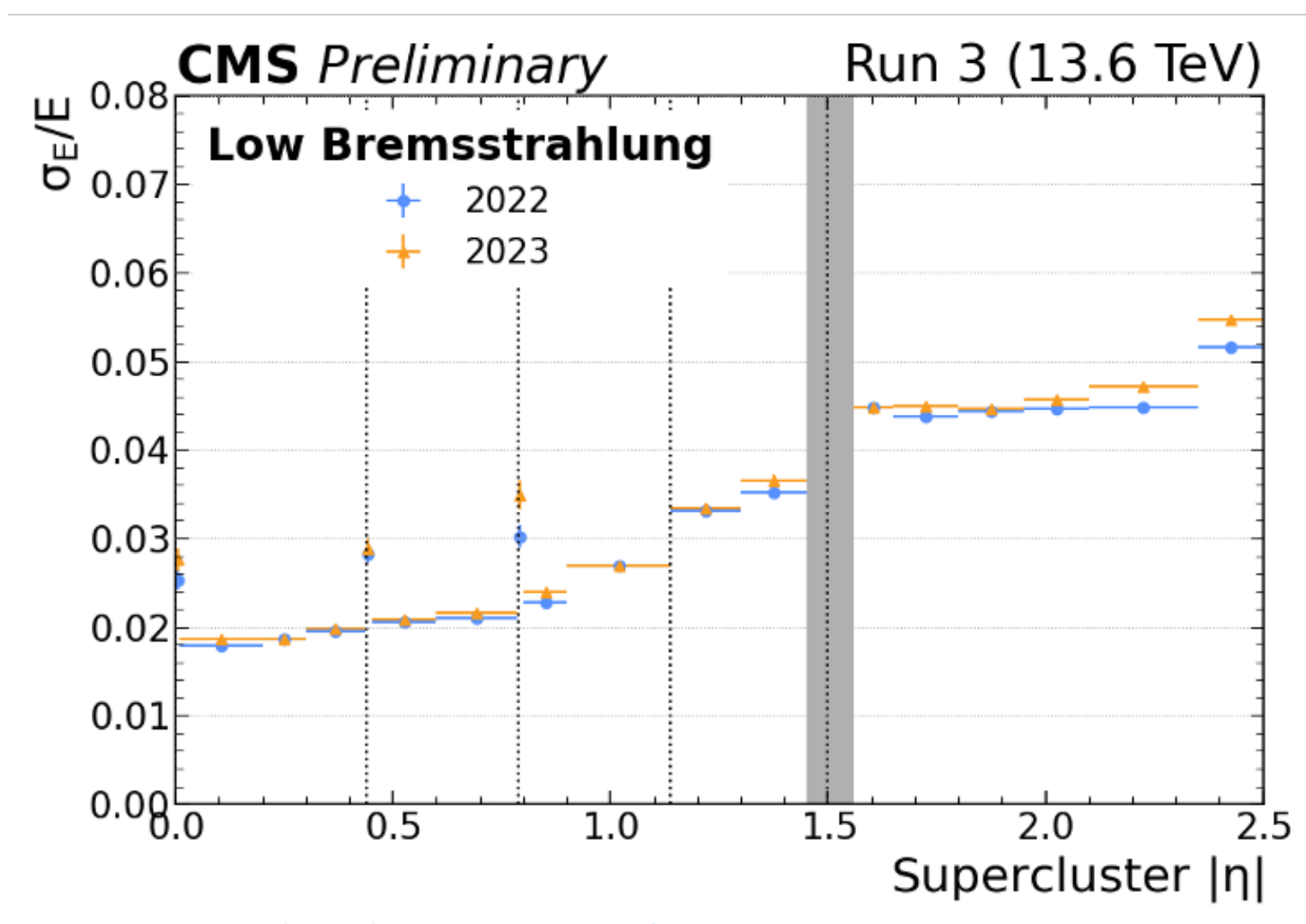

Plots from [CMS DP-2024/022](https://cds.cern.ch/record/2874047/files/CMS-DP-2024-022)

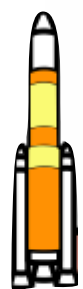

Laser precision after relocation: method

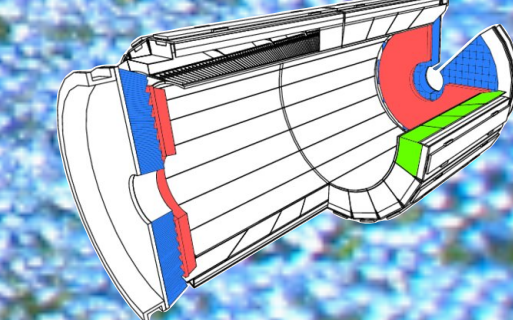

Results on laser precision produced analysing data from all runs of the November commissioning

- Computation of **APD/PN for each crystal as a function of time**
- Computation of the distance d of the point p_n from the line interpolating points p_{n-1} and p_{n+1}
- Computation performed every three points to avoid mutual correlation
- The **sigma of the distance d distribution represents the precision of the laser monitoring system**

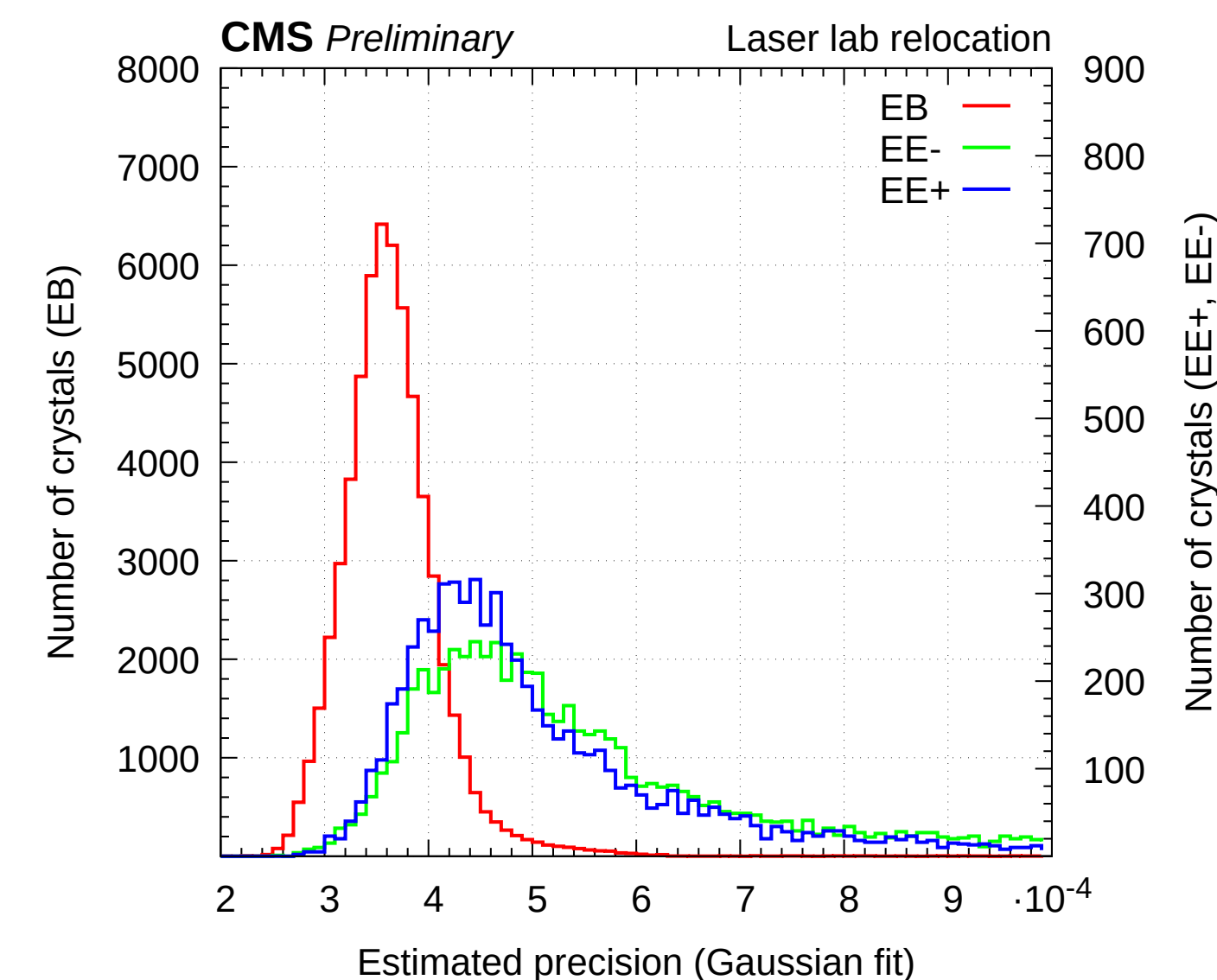
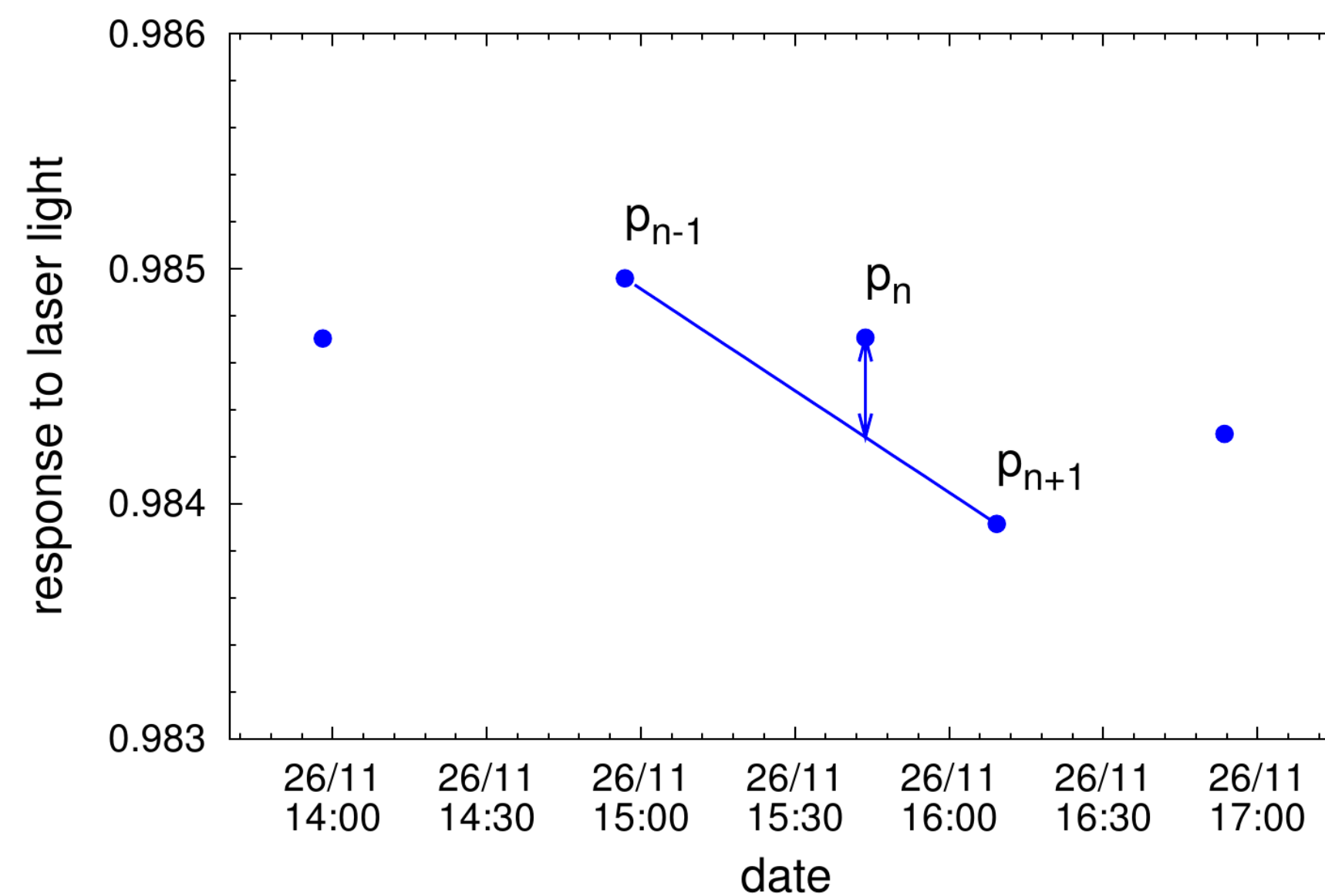
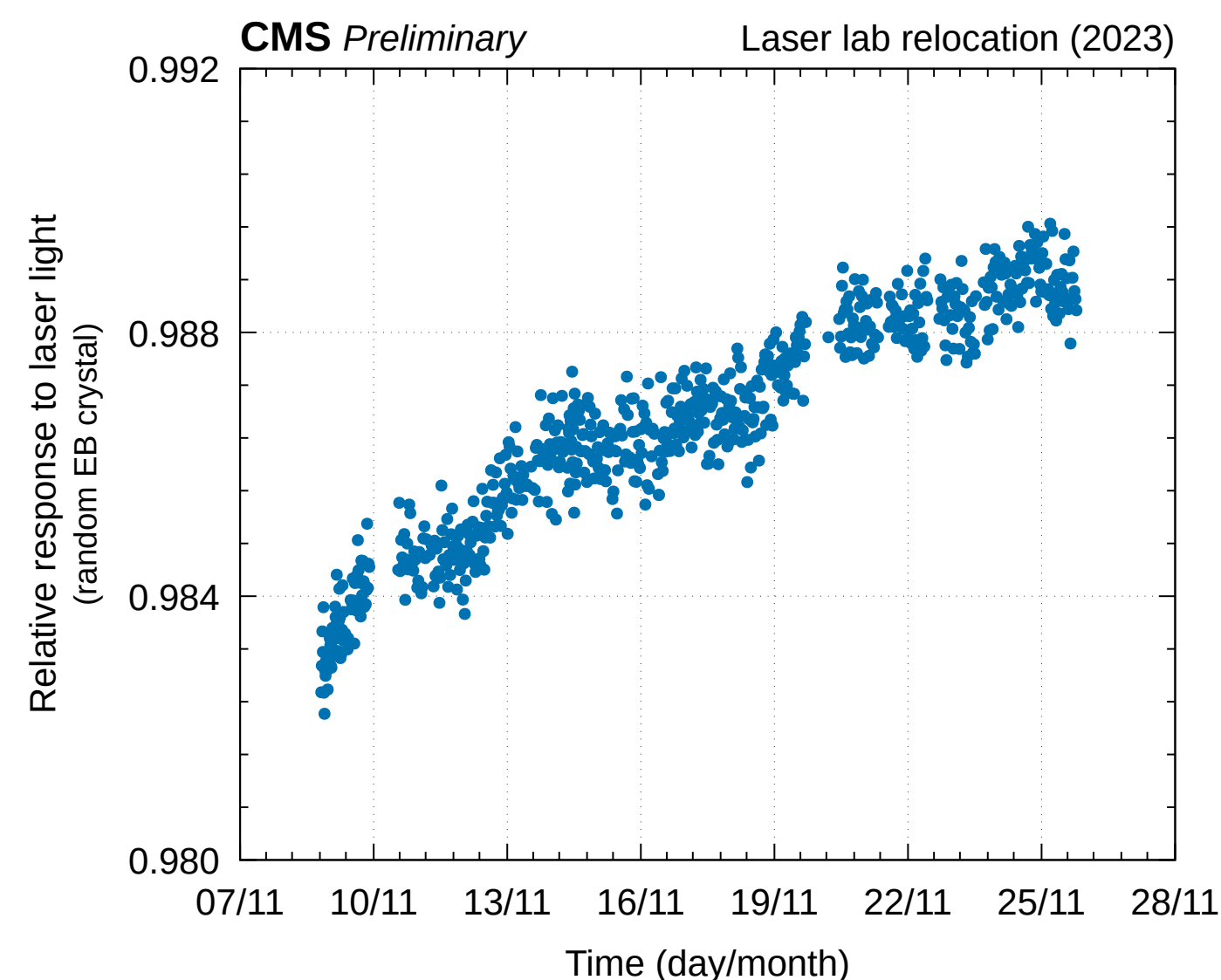

Plots from: [CMS-DP-2012-008](#), [CMS DP-2024/022](#)

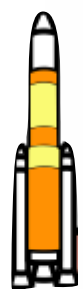

Laser precision after relocation: results

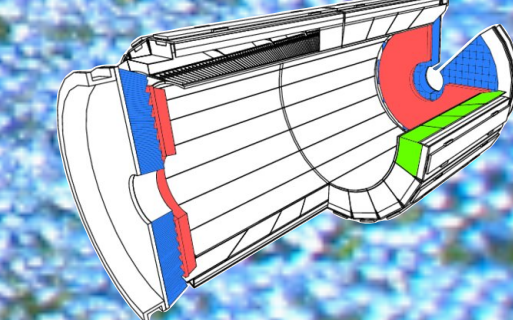

Mean value of laser precision slightly shifted for **ECAL barrel**, but the **sigma is unchanged wrt 2011**
Broader distributions for endcaps due to larger variation of transparency loss within the partition

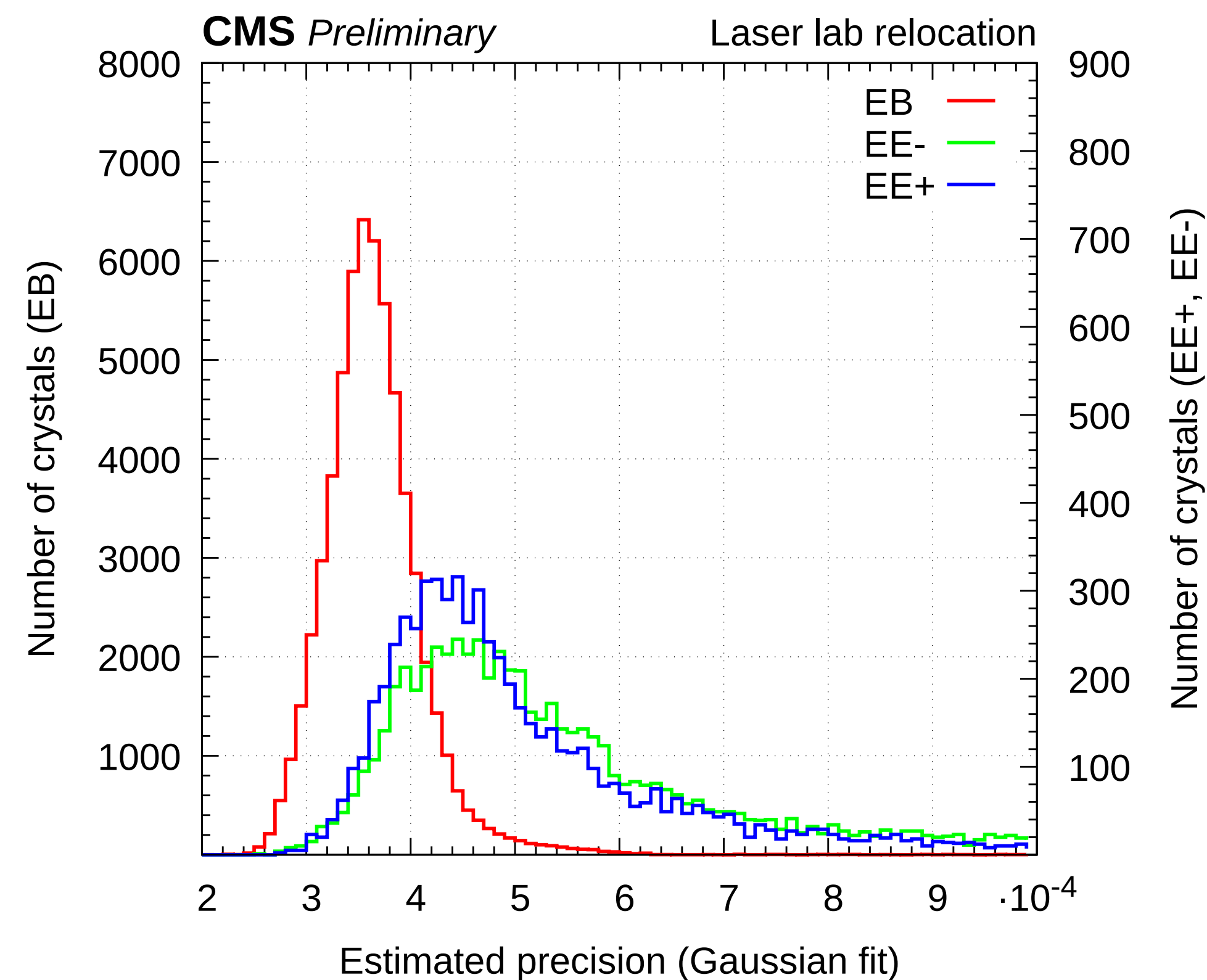
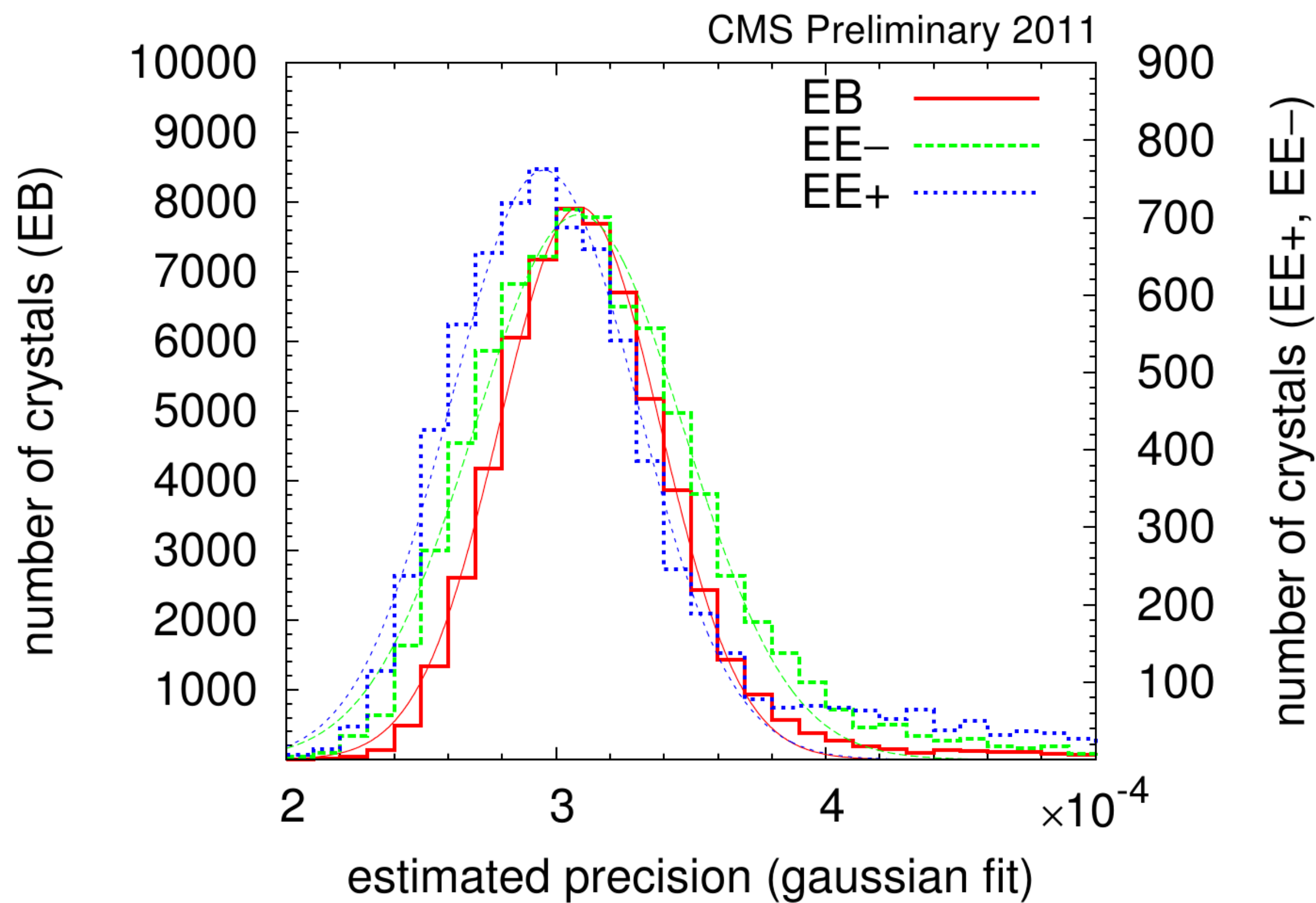

Plots from: [CMS-DP-2012-008](#), [CMS DP-2024/022](#)

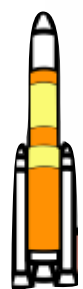

Timing intercalibration

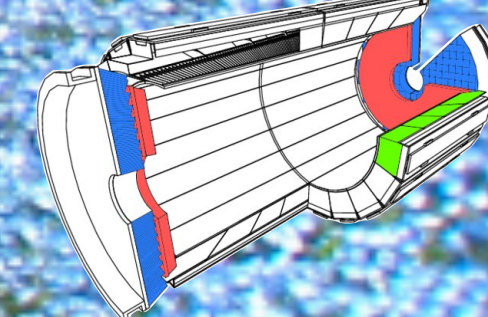

Pulse shapes change due to irradiation producing a negative shift of the timing during collisions $O(-0.1 \text{ ns/fb}^{-1})$ and positive drifts during recovery

Shifts are applied based on the average time of the selected hits

Last pulse shapes derived after LHC stop to take into account crystals recovery

Timing calibration is **particularly relevant for Long-Lived Particles studies**, as LLP are characterized by a delayed signature



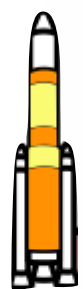

Laser monitoring upgrade

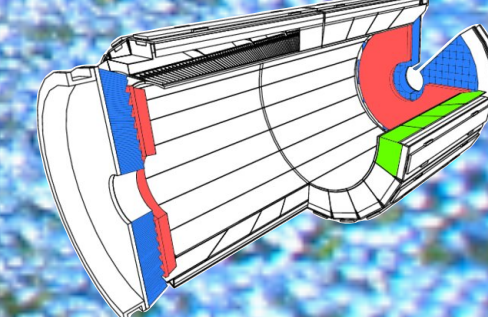

The new laser room will be kept unchanged for the High-Luminosity LHC era

A new electronic chain has been designed for the ECAL laser monitoring system to make it compatible with the new trigger and data acquisition (DAQ) system for CMS at High Luminosity LHC:

- The number of PN diodes will be doubled
- PN diodes will be read out with newly designed FEM cards and MEM boards
- A new laser monitoring board will be used to interface with CMS trigger and DAQ
 - More on ECAL upgrades in [F. Orlandi's poster](#)

