

Future Circular Collider

—Physics Case—

Corfu Workshop on Future Accelerators, May 19, 2024

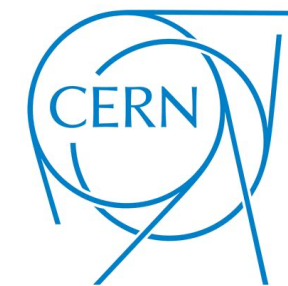
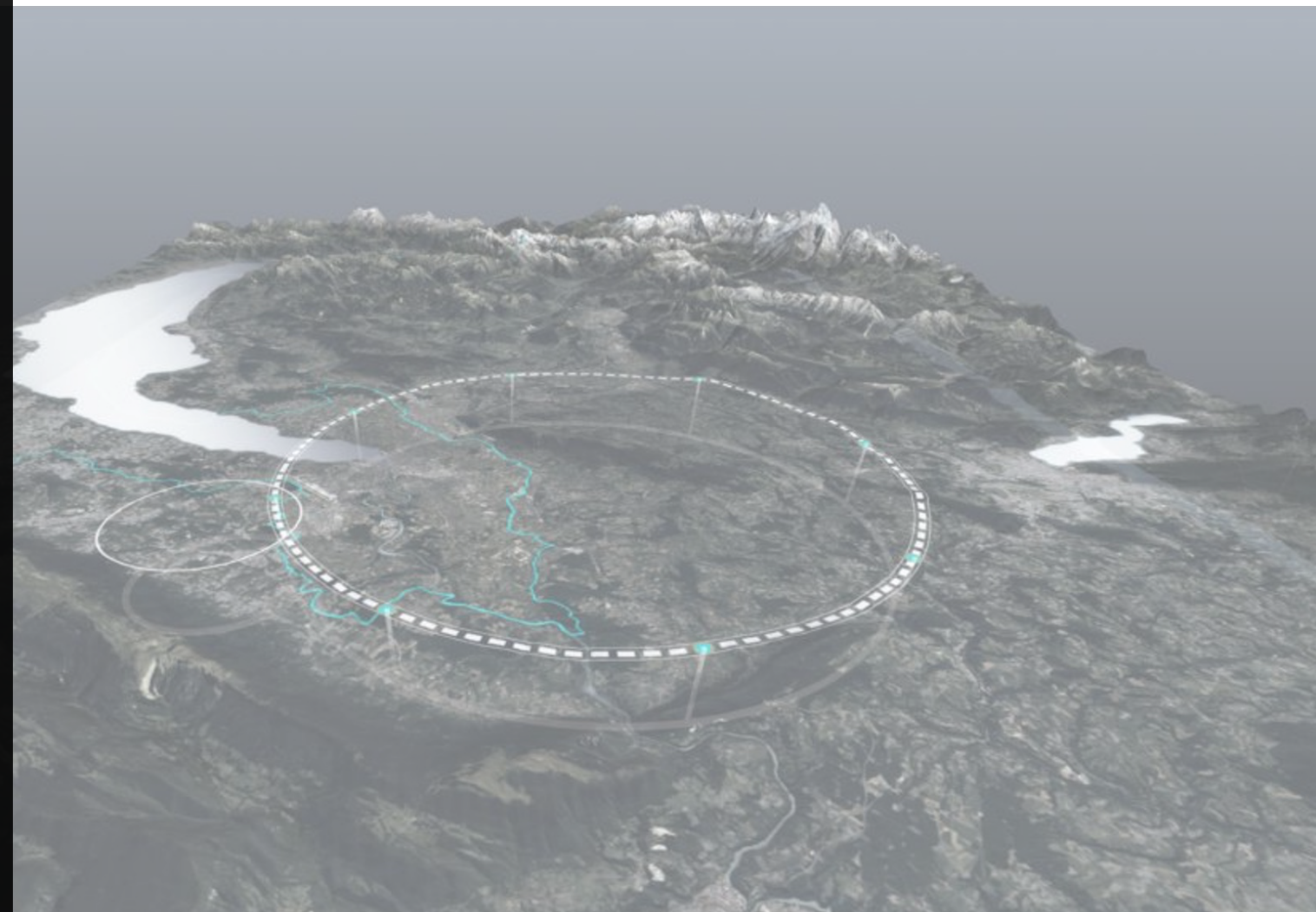

Christophe Grojean

DESY (Hamburg)



Humboldt University (Berlin)

CERN

(christophe.grojean@desy.de)

— on behalf of the FCC team —

Future Circular Collider

- A versatile particle collider housed in a 91km underground ring
- Implemented in several stages:
 - an e^+e^- “Higgs/EW/Flavour/top/QCD” factory running at 90-365 GeV  **FCC-ee**
 - followed by a high-energy pp collider reaching 100 TeV  **FCC-hh**

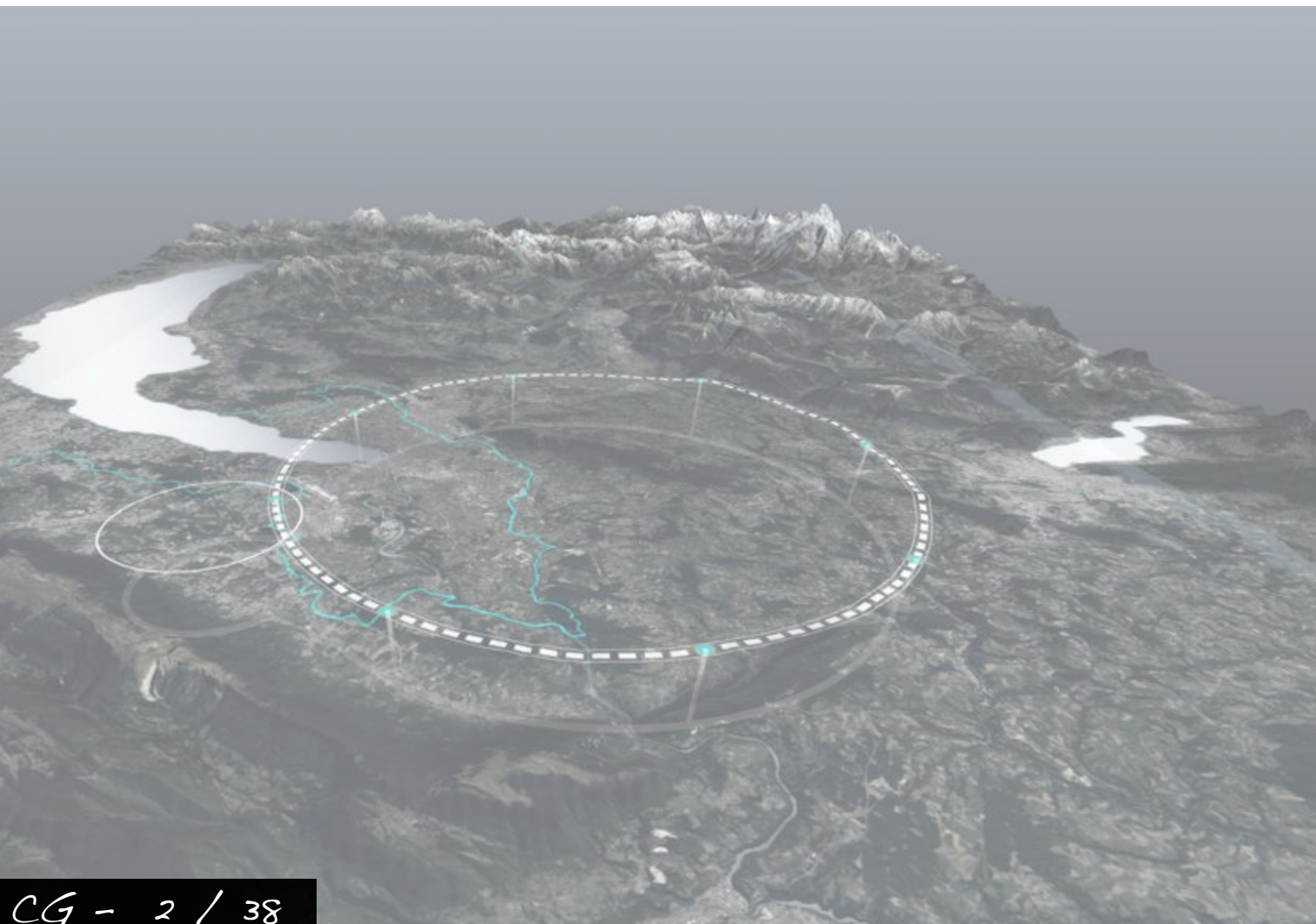

Outline

1. Why do we need a new collider?
2. FCC feasibility study
3. FCC-ee: overview of physics programme
4. FCC-ee/hh as a Higgs/electroweak factory
5. FCC-ee as a flavour factory
6. FCC-hh: the broadest exploration potential at high-energy
7. FCC-ee↔FCC-hh: complementarity and synergy
8. Conclusion

1.
Why do we need a new collider?

The LHC Legacy (so far).

- ▶ **Standard Model (SM) confirmed to high accuracy up to energies of several TeV**
(thanks to a firm control of exp. & th. syst. uncertainties, the LHC became a precision machine)
- ▶ **Higgs boson discovered** at the mass predicted* by LEP precision EW measurements

*within the Standard Model

- ▶ **Absence of new physics**

TeV-scale Naturalness might not explain DM/baryogenesis

Traditional New Physics models are under siege

New approaches: relaxion, Nnaturalness, clockwork...

Cosmology might settle the vacuum of the SM

We need a broad, versatile and ambitious programme that

1. sharpens our knowledge of already discovered physics
 2. pushes the frontiers of the unknown at high and low scales
- together FCC-ee & FCC-hh combine these 2 aspects —

more **PRECISION** and more **ENERGY**, for more **SENSITIVITY** to New Physics

Precision as a discovery tool.

Many historical examples

- ▶ Uranus anomalous trajectory \rightarrow Neptune
- ▶ Mercury perihelion \rightarrow General Relativity
- ▶ Z/W interactions to quarks and leptons \rightarrow Higgs boson
- ▶ ...

Sometimes, these discoveries were expected based on theoretical arguments
(e.g. Rayleigh-Jeans UV catastrophe for QM, unitarity breakdown for the Higgs)
but precision gave valuable additional clues.

In any case, experimentalists shouldn't lean too heavily on theorist priors/prejudices
(remember discovery of CP violation).

At times when we don't have a precise theoretical guidance, we need powerful experimental tools to make progress.

The FCC project offers unprecedented opportunities on many different fronts.
No LHC/SSC-like **no-lose theorem** but a **promise** of making significant
steps forward in our understanding of the fundamental laws of Nature.

The Higgs requires more precision.

“The Higgs isn’t everything; it’s the only thing!”*

The scalar discovery in 2012 has been an important milestone for HEP.

Many of us are still excited about it. Others should be too.

Higgs = **new forces** of different nature than the interactions known so far

- No underlying local symmetry.
- No quantised charges.
- Deeply connected to the space-time vacuum structure.

— The discovery of the Higgs opens new deep questions —

- What is the origin of the Higgs boson?
- Is it elementary and isolated, or does it emerge from a deeper underlying dynamics?
- Which role did the Higgs play during the big bang, and how did it influence the evolution of the Universe?
- Does the Higgs boson play a role in explaining other fundamental open questions in particle physics which the SM cannot address (flavour, DM, baryogenesis, inflation...)

The Higgs requires more precision.

(HL)-LHC will make remarkable progress.
But it won't be enough.
A new collider is needed!

The knowledge of the values of the **Higgs couplings** is essential to understand the deep structure of matter/Universe:

$m_W, m_Z \leftrightarrow$ Higgs couplings
↑
lifetime of stars
(why $t_{\text{Sun}} \sim t_{\text{life evolution}}$?)

$m_e, m_u, m_d \leftrightarrow$ Higgs couplings
↙ ↘
size of atoms nuclei stability

EWSB @ $t \sim 10^{-10}\text{s} \leftrightarrow$ Higgs self-coupling(s)
? Higgs(es) potential

matter/anti-matter \leftrightarrow CPV in Higgs sector
?

2. FCC feasibility study

The launch of the feasibility study.



“An **electron-positron** Higgs factory is the highest-priority next collider. For the longer term, the European particle physics community has the ambition to operate a **proton-proton** collider at the highest achievable energy.”

— CERN council approved the Strategy and CERN management implemented it —
FCC Feasibility Study (FS) started in 2021 and will be completed in 2025.

Mid-term review in 2023.

FCC feasibility mid-term report.

- **703 pages:** 7 chapters (cost and financial feasibility is a separate document) + refs.

- Placement scenario (75 pages)
- Civil engineering (50 pages)
- Implementation with the host states (45 pages)
- Technical infrastructure (110 pages)
- FCC-ee collider design and performance (170 pages)
- FCC-hh accelerator (60 pages)
- (Cost and financial feasibility)
- Physics and experiments (110 pages)
- References (70 pages)

- **Executive summary:** 44 pages

- Reviewed by

- Scientific Advisory Committee and Cost Review Panel on Oct. 16-18
- Scientific Policy Committee and Financial Committee on Nov. 21-22
- CERN Council Feb. 2

Future Circular Collider Midterm Report

February 2024

528 authors
16 editors

Edited by:

B. Auchmann, W. Bartmann, M. Benedikt, J.P. Burnet, P. Craievich,
M. Giovannozzi, C. Grojean, J. Gutleber, K. Hanke, P. Janot, M. Mangano,
J. Osborne, J. Poole, T. Raubenheimer, T. Watson, F. Zimmermann



This project has received funding under the European Union's
Horizon 2020 research and innovation programme under grant
agreement No 951754.

This document has been produced by the organisations participating in the
FCC feasibility study. The studies and technical concepts presented here
do not represent an agreement or commitment of any of CERN's Member
States or of the European Union for the construction and operation of an
extension to CERN's existing research infrastructures.

The midterm report of the FCC Feasibility Study reflects work in progress
and should therefore not be propagated to people who do not have direct
access to this document.

**confidential documents
(work in progress)
available
to CERN personnel**

<https://doi.org/10.17181/zh1gz-52t41>

Physics, Experiments, Detectors.

- FCC Feasibility Study PED deliverables for mid-term review

8. Physics & Experiments	C. Grojean, P. Janot, M. Mangano	8.1 Overview	} deliverables explicitly requested from SPC & Council
		8.2. Documentation of the specificities of the FCC-ee and FCC-hh physics cases.	
		8.3 Strategic plans for the improved theoretical calculations.	
		8.4 FCC-ee Detector Requirements.	

- Content of the mid-term PED chapter (60 pages were expected → 110 pages delivered)

1 Overview	3	4 Detector requirements	54
1.1 FCC-ee: A great Higgs factory, and so much more	4	4.1 Introduction	54
1.2 FCC-hh: The energy-frontier collider with the broadest exploration potential	13	4.2 Machine-detector interface	55
2 Specificities of the FCC physics case	15	4.3 The current detector concepts	56
2.1 Characterisation of the Higgs boson: role of EW measurements and of FCC-hh	16	4.4 Measurement of the tracks of charged particles	58
2.2 Discovery landscape	24	4.5 Requirements on the vertex detector	64
2.3 Flavour advancement	34	4.6 Requirements on charged hadron particle identification	73
2.4 FCC-hh specificities compared to lepton colliders	36	4.7 Requirements on electromagnetic calorimetry	78
3 Theoretical calculations	42	4.8 Requirements on the hadronic calorimeter	88
3.1 Electroweak corrections	44	4.9 Requirements on the muon detector	93
3.2 QCD precision calculations	46	4.10 Precise timing measurements	93
3.3 Monte Carlo event generators	50	5 Outlook and further steps	96
3.4 Organization and support of future activities to improve theoretical precision	53	5.1 Software and Computing	98
		5.2 Physics Performance	99
		5.3 Detector Concepts	101
		5.4 Centre-of-mass energy calibration, polarisation, monochromatisation (EPOL)	103
		5.5 Machine-Detector Interface (MDI)	104
		5.6 Physics Programme	105
		5.7 FCC-hh	106

Physics, Experiments, Detectors.

- FCC Feasibility Study PED deliverables for mid-term review

8. Physics & Experiments	C. Grojean, P. Janot, M. Mangano	8.1 Overview	deliverables explicitly requested from SPC & Council
		8.2. Documentation of the specificities of the FCC-ee and FCC-hh physics cases.	
		8.3 Strategic plans for the improved theoretical calculations.	
		8.4 FCC-ee Detector Requirements.	

- Content of the mid-term PED chapter (00 pages delivered)

1 Overview	54
1.1 FCC-ee	54
1.2 FCC-hh	55
2 Specificities	56
2.1 FCC-ee	58
2.2 FCC-hh	64
2.3 FCC-ee/hh	73
2.4 FCC-ee/hh as a Higgs/electroweak factory	78
3 Theoretical potential	88
3.1 FCC-ee: much more than a Higgs factory:	93
• precision for discovery	93
• tera-Z direct discovery potential	96
3.2 FCC-ee/hh as a Higgs/electroweak factory	98
3.3 FCC-ee as a flavour factory	99
3.4 FCC-hh: the broadest exploration potential at high-energy	101
4 FCC-ee ↔ FCC-hh: complementarity and synergy	103
5 Machine-Detector Interface (MDI)	104
5.5 Machine-Detector Interface (MDI)	104
5.6 Physics Programme	105
5.7 FCC-hh	106

— Main physics topics covered/discussed in the report —

1. FCC-ee: much more than a Higgs factory:
 - precision for discovery
 - tera-Z direct discovery potential
2. FCC-ee/hh as a Higgs/electroweak factory
3. FCC-ee as a flavour factory
4. FCC-hh: the broadest exploration potential at high-energy
5. FCC-ee ↔ FCC-hh: complementarity and synergy

Feedback.

Andy **Parker** (SAC chair), Norbert **Holtkamp** (CRP chair), Hugh **Montgomery** (SPC chair), Laurent **Salzarulo** (FC chair), Eliezer **Rabinovici** (Council president)

“many thanks for the work done, congratulations for the results, impressive quality of the study...”

“Financial Committee underlines the need to make the project attractive from the physics viewpoint and takes the view that it would be unfortunate to sacrifice the attractiveness of the physics for the sake of reducing costs.”



“Si j’ai voulu venir là aujourd’hui c’est pour témoigner ma confiance aux équipes et notre volonté, notre ambition de conserver la première place dans ce domaine.”
[“My visit here bears witness to my trust in CERN personnel and France’s will and ambition to keep the leadership in this domain.”]

E. Macron, CERN 16.11.2023

US Statement of Intent



Deirdre Mulligan

Fabiola Gianotti

“Should the CERN Member States determine the FCC-ee is likely to be CERN’s next world-leading research facility following the high-luminosity Large Hadron Collider, the United States intends to collaborate on its construction and physics exploitation, subject to appropriate domestic approvals.”

White House, April 26, 2024

The way forward.

t ↗

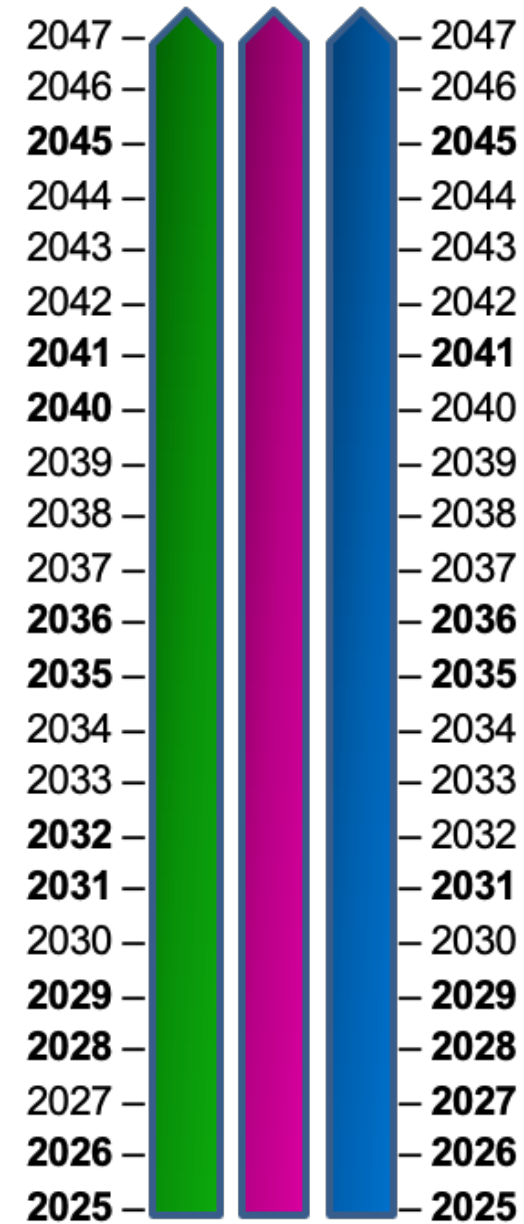

We are only 20 years away from the first collisions!

The way forward.

P. Janot
 (officially endorsed by
 F. Gianotti@P5-BNL)

FCC-ee physics run

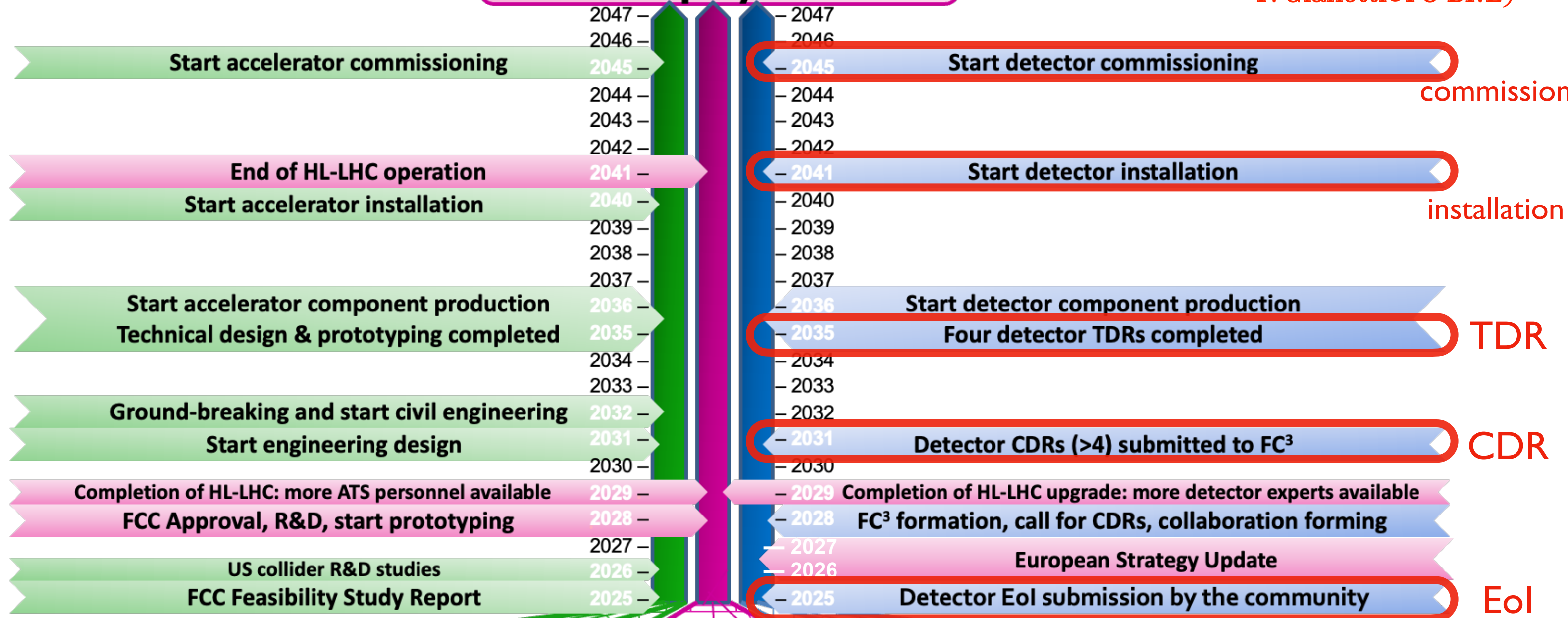

FCC-ee Accelerator

Key dates

FCC-ee Detectors

The way forward.

P. Janot
(officially endorsed by
F. Gianotti@P5-BNL)

FCC-ee physics run

— *Things are now moving faster than planned!* —

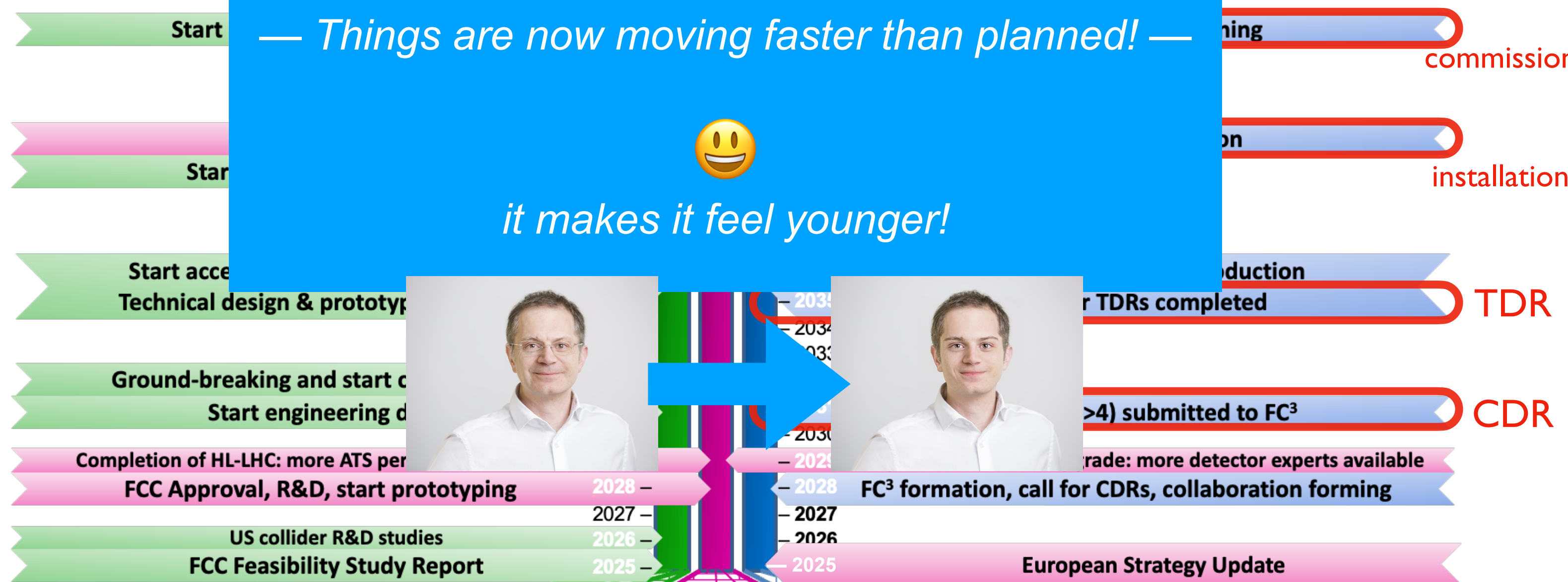
it makes it feel younger!



FCC-ee Accelerator

Key dates

FCC-ee Detectors

How to contribute?



FCC Feasibility Study

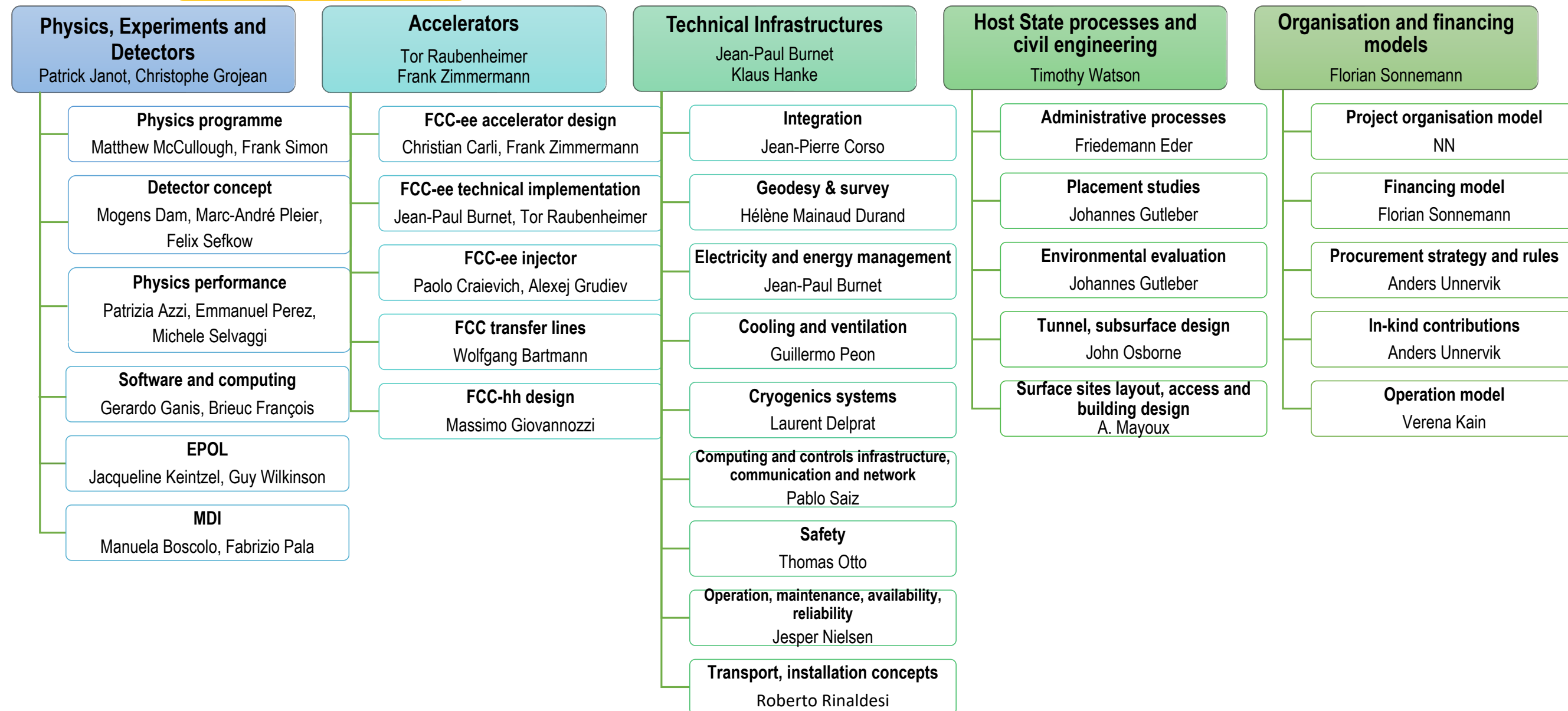
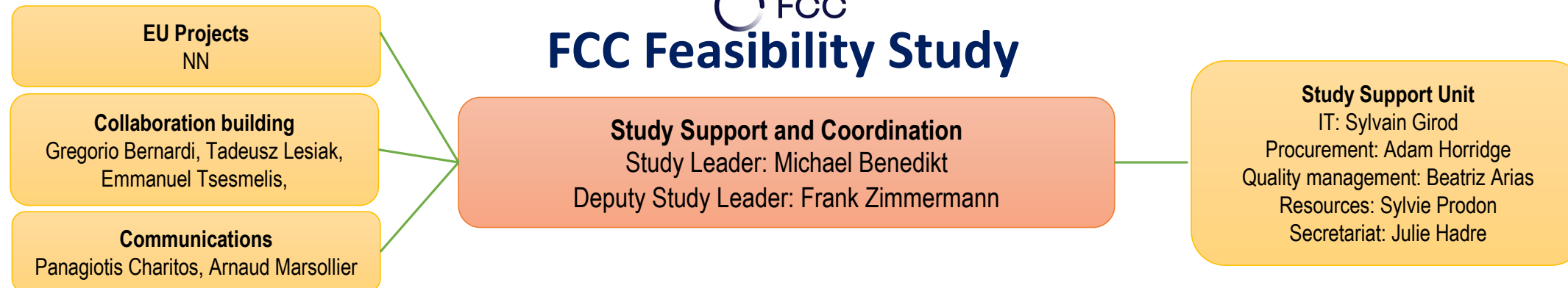

3. FCC-ee: overview of physics programme

FCC-ee Run Plan.

LEP1 data accumulated in **every 2 mn.** Exciting & diverse programme with different priorities every few years.
 (order of the different stages still subject to discussion/optimisation)

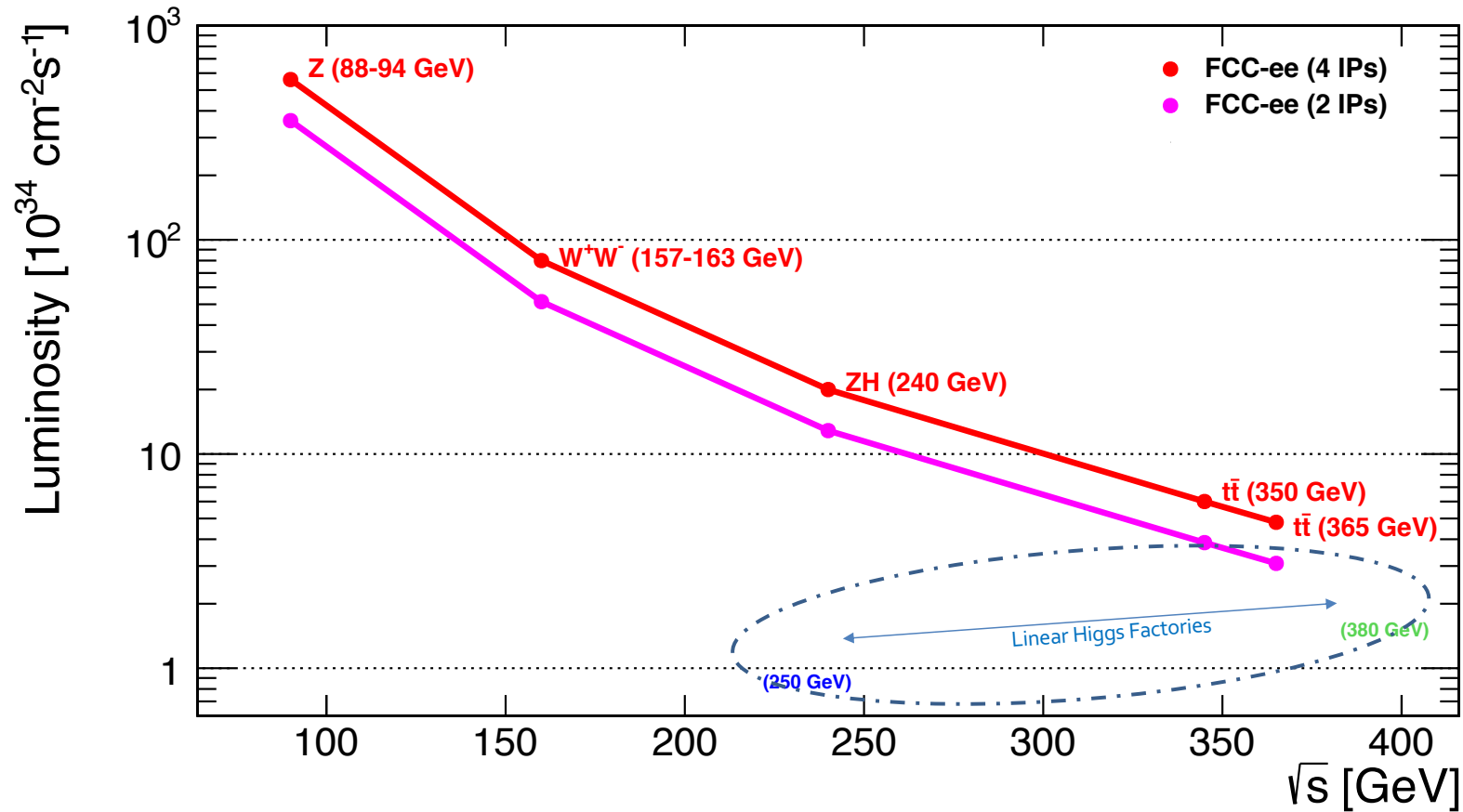

— Superb statistics achieved in only 15 years —

**in each detector:
 10⁵ Z/sec, 10⁴ W/hour,
 1500 Higgs/day, 1500 top/day**

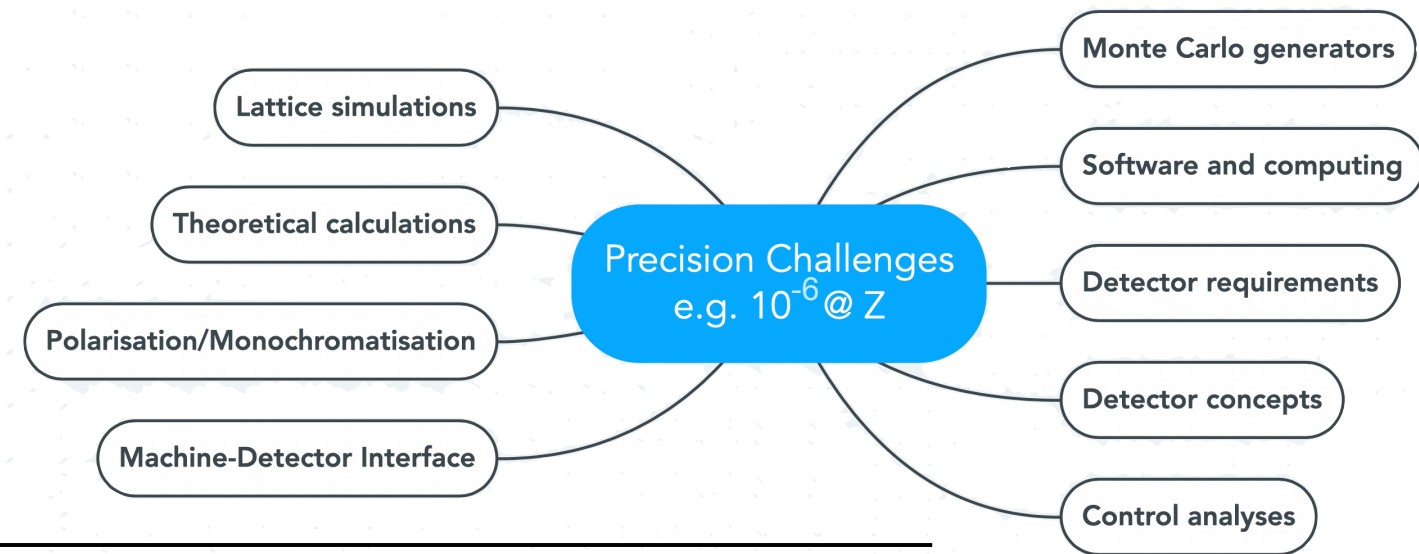

Working point	Z, years 1-2	Z, later	WW, years 1-2	WW, later	ZH	tt
\sqrt{s} (GeV)	88, 91, 94		157, 163		240	340–350 365
Lumi/IP ($10^{34} \text{ cm}^{-2} \text{ s}^{-1}$)	70	140	10	20	5.0	0.75 1.20
Lumi/year (ab^{-1})	34	68	4.8	9.6	2.4	0.36 0.58
Run time (year)	2	2	2	–	3	1 4
Number of events	6×10^{12} Z		2.4×10^8 WW		1.45×10^6 ZH + 45k WW \rightarrow H	1.9×10^6 tt +330k ZH +80k WW \rightarrow H

FCC-ee Physics Programme.

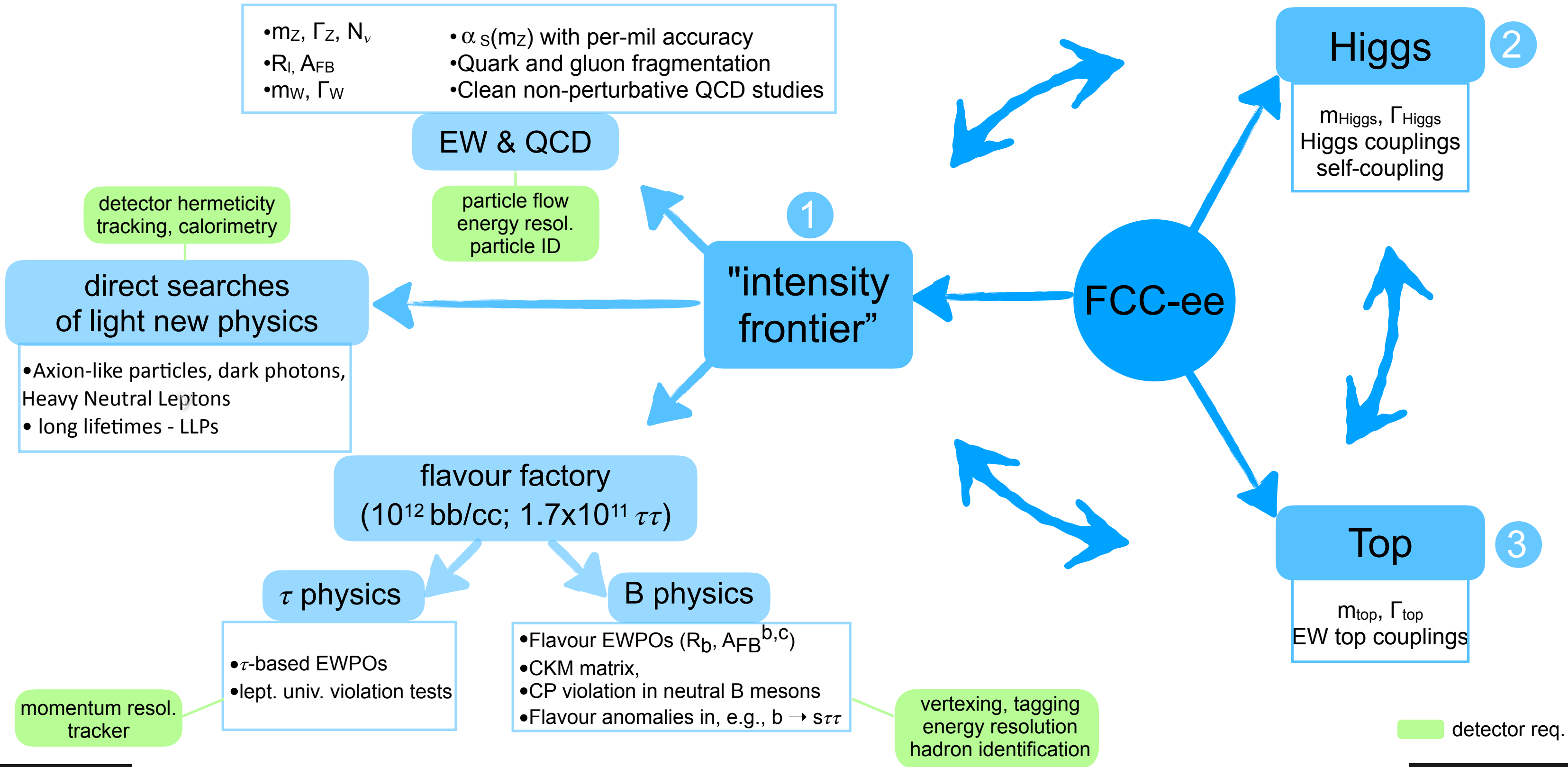

FCC-ee Physics Programme.

- m_Z, Γ_Z, N_ν
- R_l, A_{FB}
- m_W, Γ_W
- $\alpha_s(m_Z)$ with per-mil accuracy
- Quark and gluon fragmentation
- Clean non-perturbative QCD studies

EW & QCD

Higgs

2

- $m_{Higgs}, \Gamma_{Higgs}$
- Higgs couplings
- self-coupling

baseline FCC-ee detector performance

track momentum	$\frac{\sigma_p}{p} = 0.02 \cdot 10^{-3} \cdot p_T(\text{GeV}) \oplus 1 \cdot 10^{-3}$
track impact parameter	$\sigma_{d_0} = \frac{15 \mu\text{m}}{\sin^{3/2} \theta} \oplus 5 \mu\text{m}$
electromagnetic energy	$\frac{\sigma_{E_\gamma}}{E_\gamma} = \frac{15\%}{E_\gamma} \oplus 1\%$
electromagnetic energy xy position	$\sigma_{\gamma,xy} = \frac{6 \text{ mm}}{E(\text{GeV})} \oplus 2 \text{ mm}$

detector hermetic tracking, calorimetry

direct search of light new physics

- Axion-like particles, dark Heavy Neutral Leptons
- long lifetimes - LLPs

momentum resolution tracker

τ physics

- τ -based EWPOs
- lept. univ. violation tests

B physics

- Flavour EWPOs ($R_b, A_{FB}^{b,c}$)
- CKM matrix
- CP violation in neutral B mesons
- Flavour anomalies in, e.g., $b \rightarrow s \tau \tau$

vertexing, tagging energy resolution hadron identification

Top

3

- m_{top}, Γ_{top}
- EW top couplings

detector req.

Collider Programme (and beyond).

— CDR baseline runs (2IPs)
 — Additional opportunities

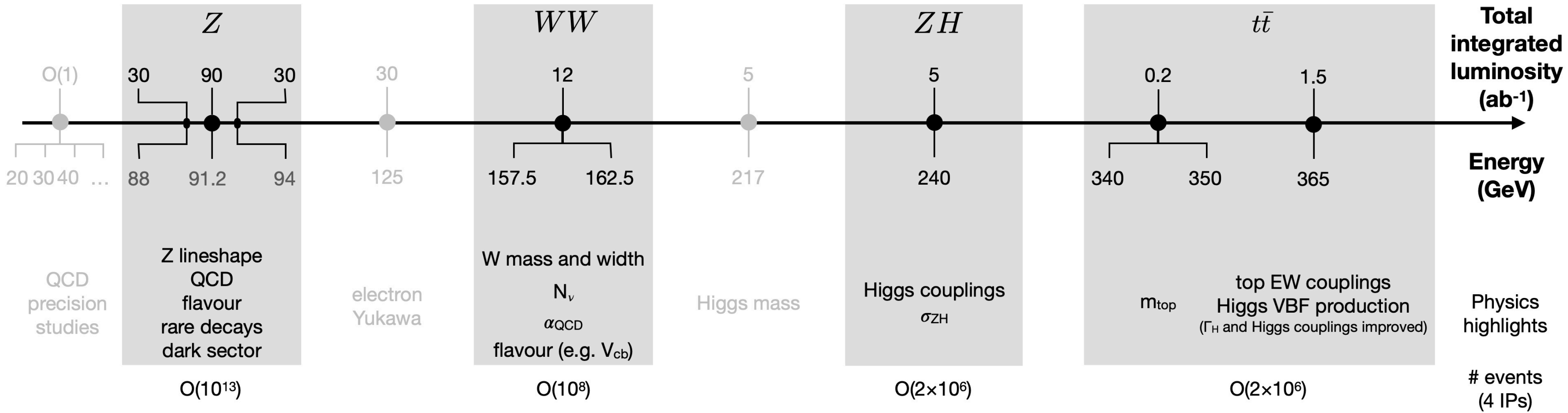

- **Opportunities** beyond the baseline plan (\sqrt{s} below Z, 125GeV, 217GeV; larger integrated lumi...)
- **Opportunities** to exploit FCC facility differently (to be studied more carefully):
 - using the electrons from the injectors for beam-dump experiments,
 - extracting electron beams from the booster,
 - reusing the synchrotron radiation photons.

FCC-ee: Explore & Discover.

PED @ CERN-SPC 2022

- **EXPLORE INDIRECTLY** the 10-100 TeV energy scale with precision measurements
 - From the correlated properties of the Z , b, c, τ , W, Higgs, and top particles
 - ▶ Up to 20-50-fold improved precision on ALL electroweak observables (EWPO)
 - m_Z , m_W , m_{top} , Γ_Z , $\sin^2 \theta_W^{\text{eff}}$, R_b , $\alpha_{\text{QED}}(m_Z)$, $\alpha_s(m_Z, m_W, m_t)$, top EW couplings ...
 - ▶ Up to 10 × more precise and model-independent Higgs couplings (width, mass) measurements
 - Access the Higgs potential and infer the vacuum structure of the Universe
 - Reveals the dynamics of the EW phase transition and infer the fate of the EW vacuum
- **DISCOVER** that the Standard Model does not fit
 - New Physics! → Pattern of deviations may point to the source.
- **DISCOVER** a violation of flavour conservation / universality
 - $Z \rightarrow \tau \mu$ in 5×10^{12} Z decays; $\tau \rightarrow \mu \nu / e \nu$ in 2×10^{11} τ decays; $B^0 \rightarrow K^{*0} \tau^+ \tau^-$ or $B_S \rightarrow \tau^+ \tau^-$ in 10^{12} bb evts
- **DISCOVER** dark matter, e.g., as invisible decays of Higgs or Z
- **DISCOVER DIRECTLY** elusive (aka feebly-coupled) particles
 - in the 5-100 GeV mass range, such as right-handed neutrinos, dark photons, light Higgs-like scalars, dilaton, ALPs, relaxions...

See Bonus Slides
for examples and plots

FCC-ee: Explore & Discover.

- **ALPs@ colliders**

e.g. $e^+e^- \rightarrow \gamma a$

$e^+e^- \rightarrow ha$

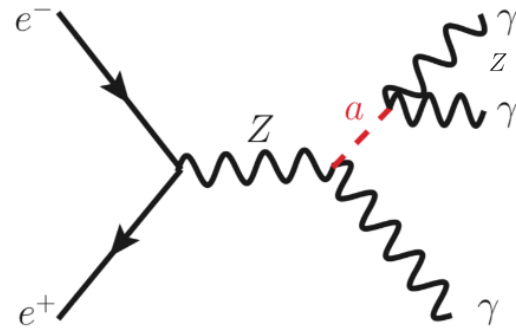

Knapen, Thamm arXiv:2108.08949

Astro/Cosmo → long-lived ALPs
colliders → short-lived ALPs MeV+

ALP coupling to photons

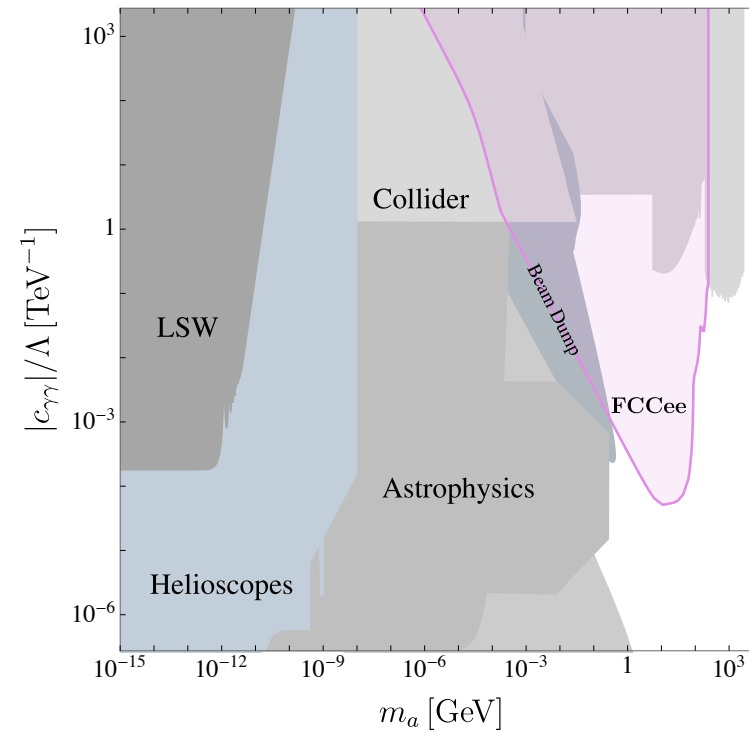

ALP coupling to electrons

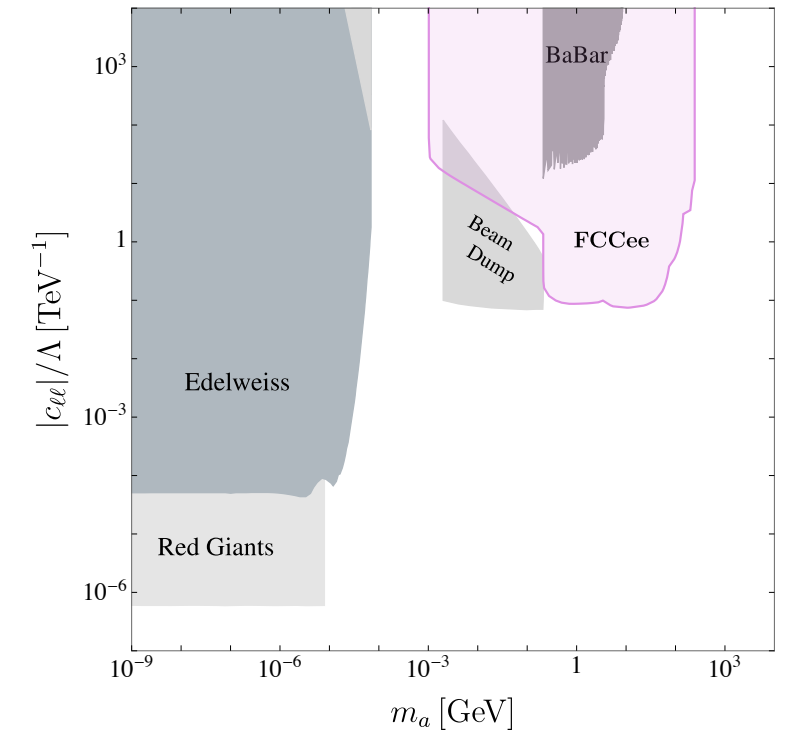

- **Search for ν_{RH} .**

Direct observation
in Z decays
from LH-RH mixing

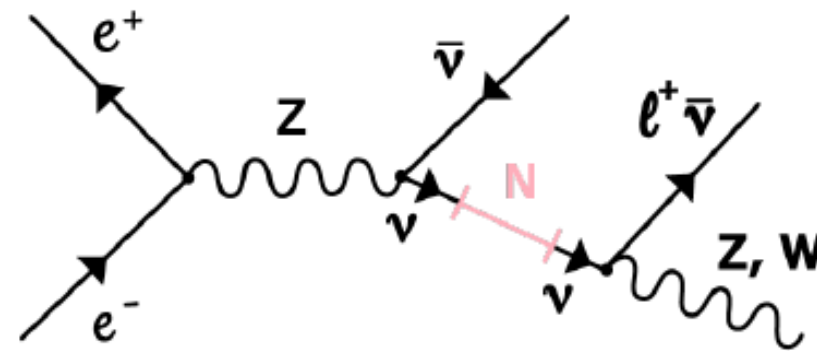

mixing active-sterile neutrinos

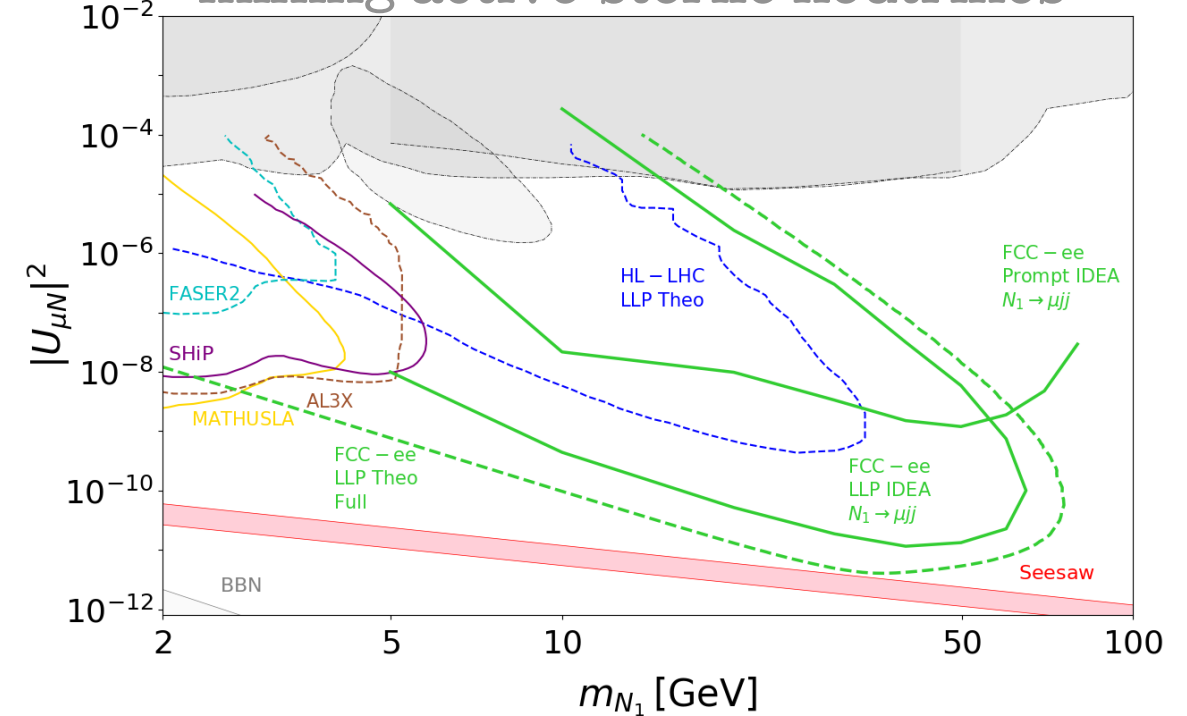

Fig. from mid-term report

May 19, 2024

4.
FCC-ee/hh as a Higgs/electroweak factory

Higgs @ FCC-ee.

Central goal of FCC-ee: model-independent measurement of Higgs width and couplings with (<) % precision. Achieved through operation at two energy points.

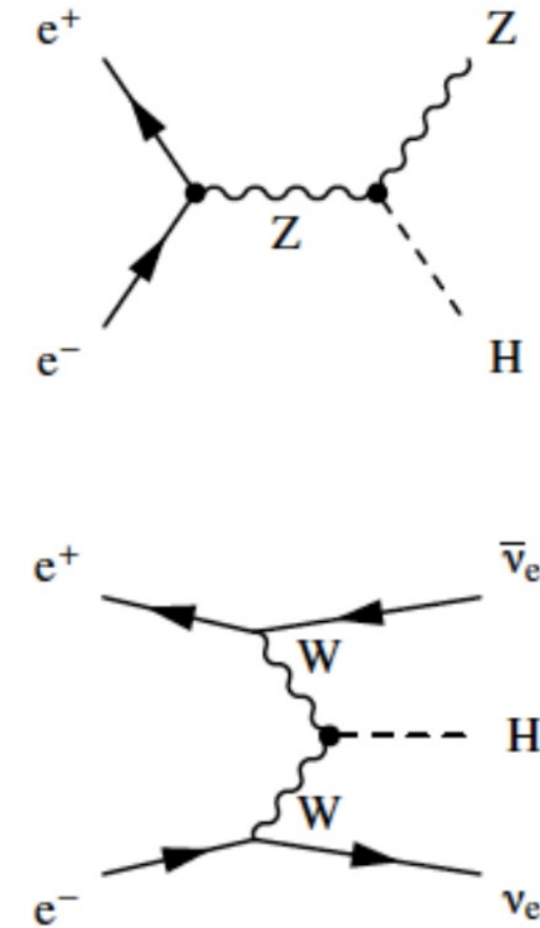
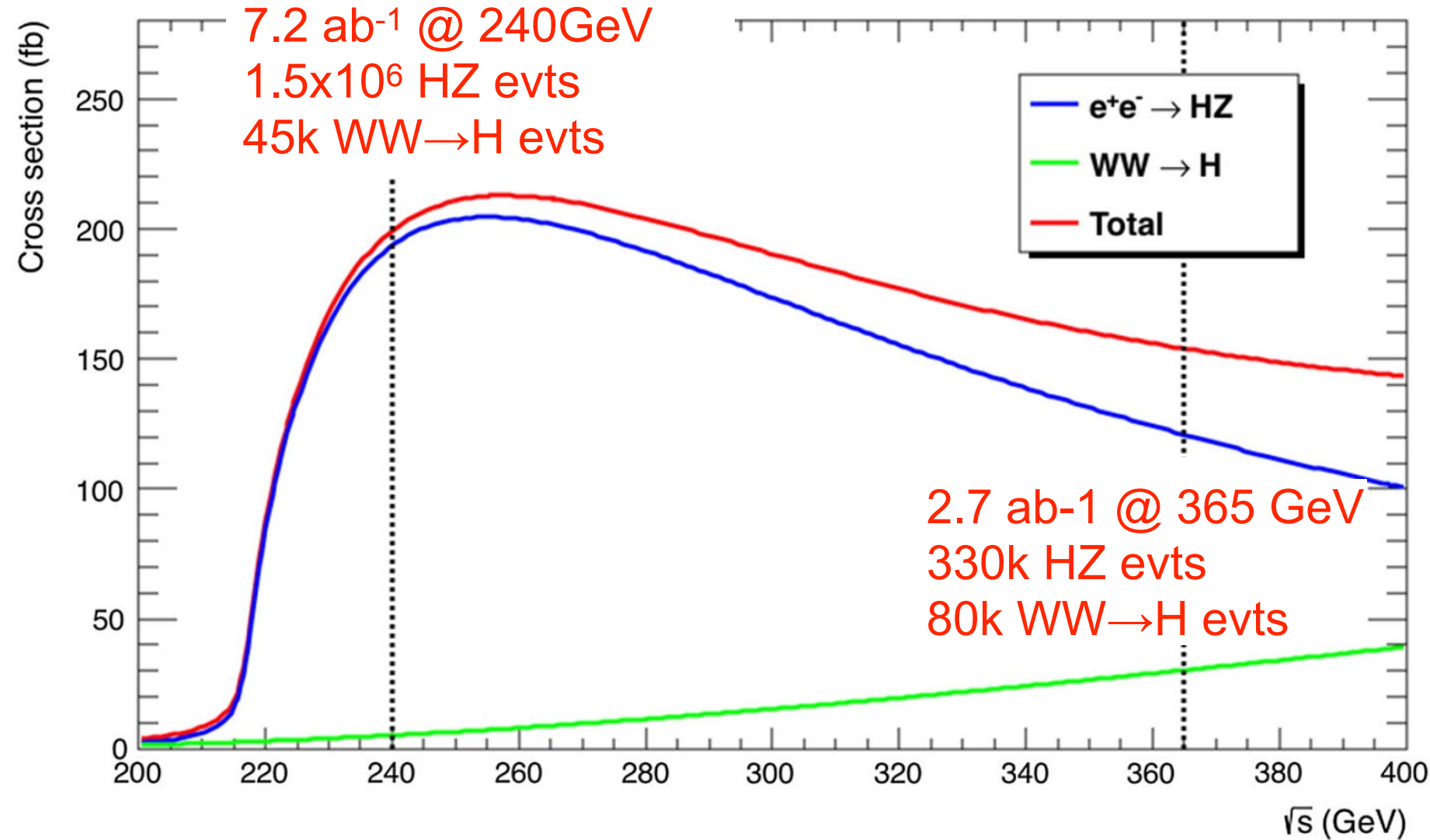

Sensitivity to both processes very helpful in improving precision on couplings.

Complementarity with 365GeV on top of 240GeV
 improvement factor: ∞/3/2/1.5/1.2 on $\kappa_\lambda/\kappa_W/\kappa_b/\kappa_g, \kappa_c/\kappa_\gamma$ (plot in bonus)

Higgs @ FCC-ee.

- Absolute normalisation of couplings (by recoil method)
- Measurement of width (from $ZH \rightarrow ZZZ^*$ and $WW \rightarrow H$)
- $\delta\Gamma_H \sim 1\%$, $\delta m_H \sim 3 \text{ MeV}$ (resp. 25%, 30 MeV @ HL-LHC)
- Model-independent coupling determination and improvement factor up to 10 compared to LHC
- (Indirect) sensitivity to new physics up to 70 TeV (for maximally strongly coupled models)
($\delta\kappa_X = v^2/f^2$ & $m_{\text{NP}} = g_{\text{NP}} f$)
- Unique access to electron Yukawa

— Higgs programme needs Z-pole —

Higgs coupling sensitivity

Coupling	HL-LHC	FCC-ee (240–365 GeV)
		2 IPs / 4 IPs
κ_W [%]	1.5*	0.43 / 0.33
κ_Z [%]	1.3*	0.17 / 0.14
κ_g [%]	2*	0.90 / 0.77
κ_γ [%]	1.6*	1.3 / 1.2
$\kappa_{Z\gamma}$ [%]	10*	10 / 10
κ_c [%]	—	1.3 / 1.1
κ_t [%]	3.2*	3.1 / 3.1
κ_b [%]	2.5*	0.64 / 0.56
κ_μ [%]	4.4*	3.9 / 3.7
κ_τ [%]	1.6*	0.66 / 0.55
$\text{BR}_{\text{inv}} (< \%, 95\% \text{ CL})$	1.9*	0.20 / 0.15
$\text{BR}_{\text{unt}} (< \%, 95\% \text{ CL})$	4*	1.0 / 0.88

current EW measurements

Z-pole run

- Higgs
- aTGC
- EW

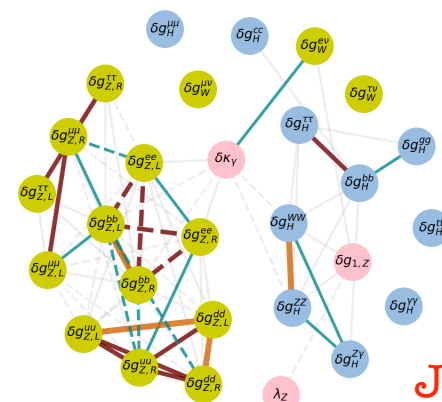
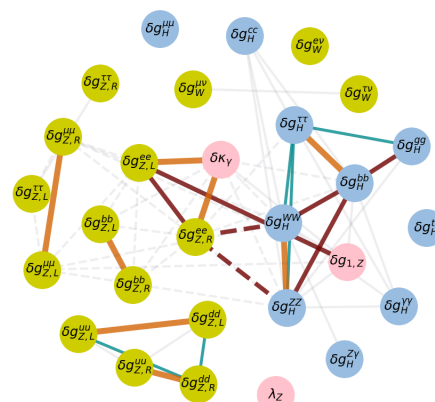
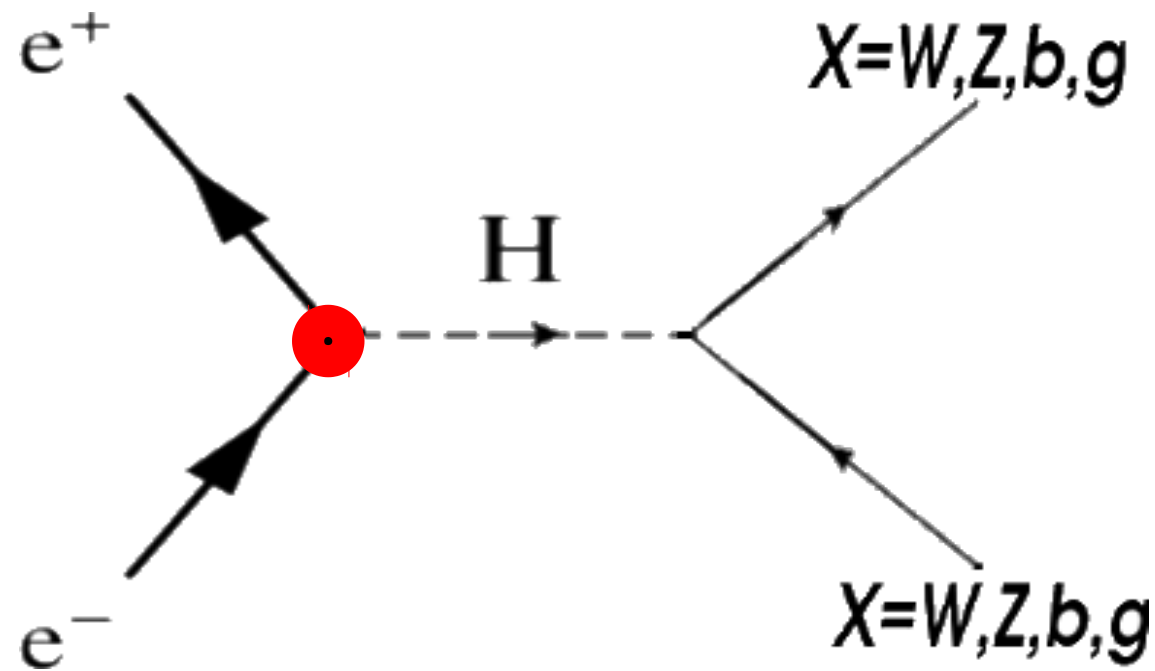

Table from mid-term report

$$\kappa_X = \frac{g_{hXX}}{g_{hXX}^{\text{SM}}}$$

The stuff we are made of: Y_e .

The high luminosity, the precise control of the beam \sqrt{s} , the clean reconstruction of final states make it possible to observe:



Jadach+, arXiv: 1509.02406

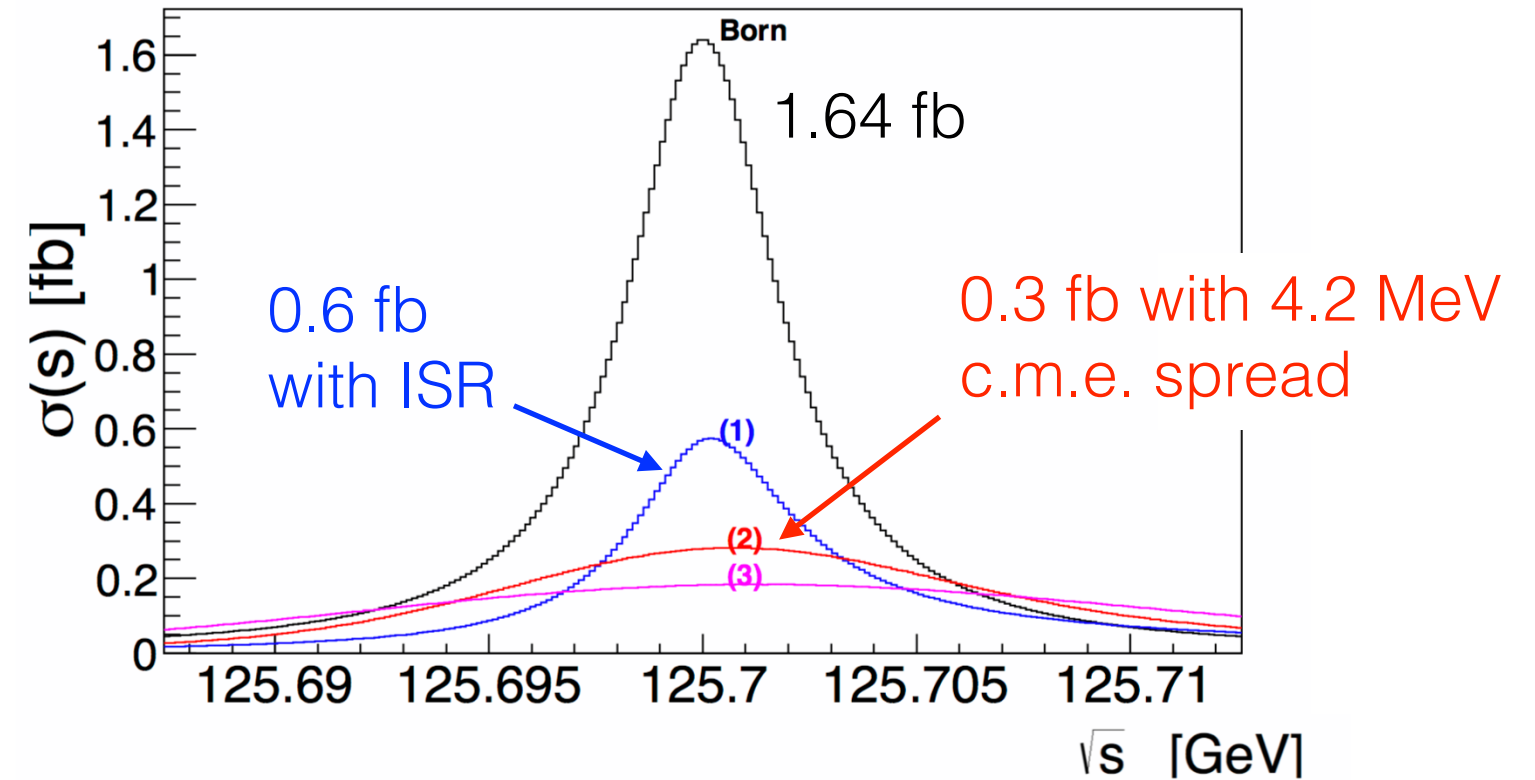

$$\sigma(e^+e^- \rightarrow H) = 1.64 \text{ fb}$$

$$\sigma_{\text{spread+ISR}}(e^+e^- \rightarrow H) = 0.17 \times \sigma(e^+e^- \rightarrow H) = 290 \text{ ab}$$

FCC-ee is in the unique position to establish that the Higgs is responsible for the mass of the stable elementary particles ordinary matter is made of.

The stuff we are made of: Y_e .

The high luminosity, the precise control of the beam \sqrt{s} , the clean reconstruction of final states make it possible to observe:

- ◆ $20 \text{ ab}^{-1} / \text{year}$ at $\sqrt{s} = 125 \text{ GeV}$ (not in baseline FCC-ee)
- ◆ Monochromatization $\sigma_{\sqrt{s}} \sim 1-2 \times \Gamma_H \sim 6 \text{ to } 10 \text{ MeV}$

● Resonant $ee \rightarrow H$ production

Upper Limits / Precision on κ_e

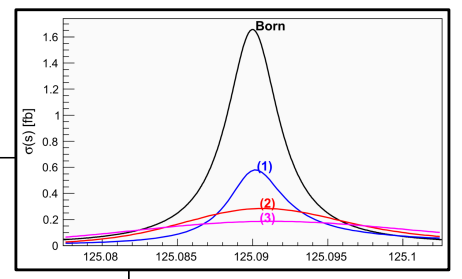
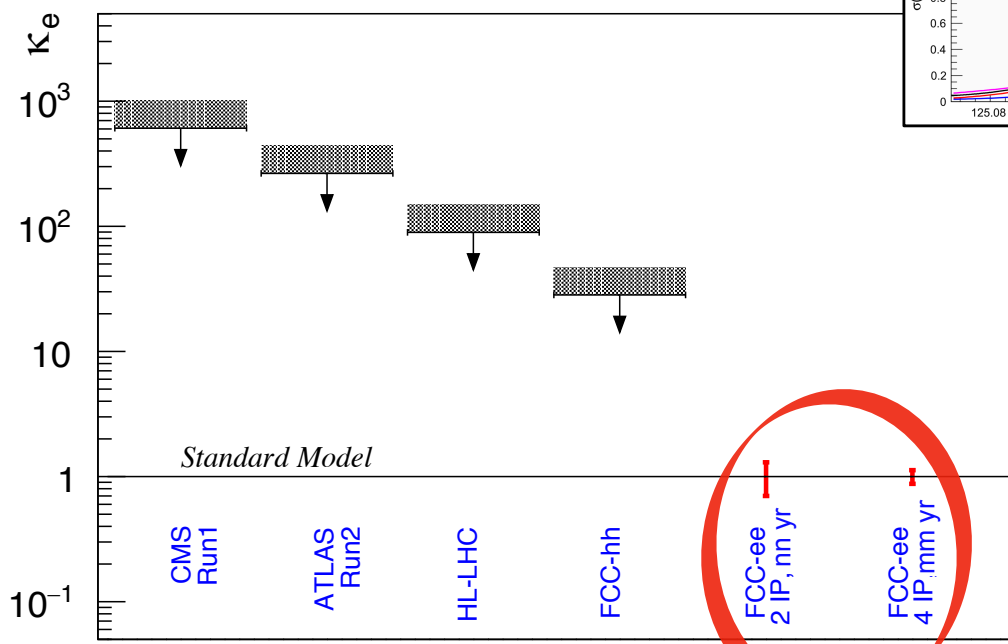

Monochromatisation

Monochromatization: **UNDER STUDY**
 taking advantage of the separate e^+ and e^- rings, one can distribute in opposite way high and low energies in the beam (in x, z time)

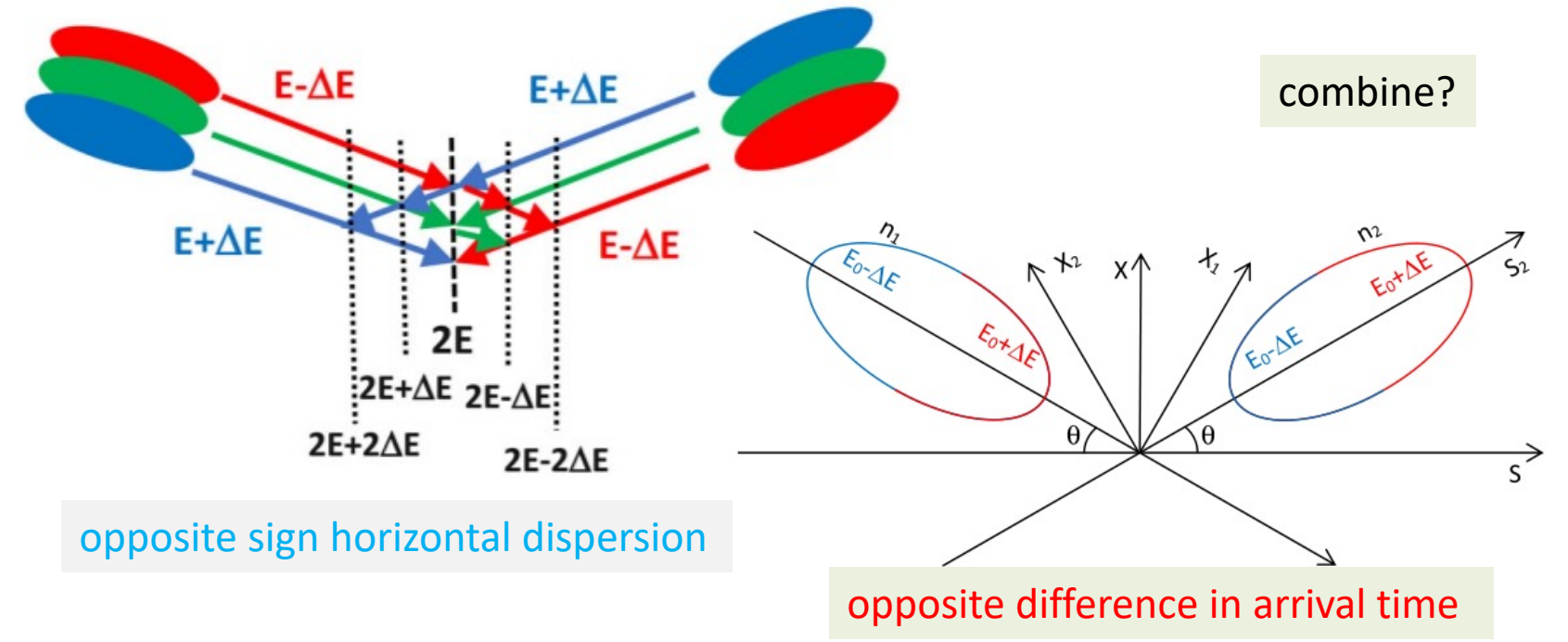

The stuff we are made of: Y_e .

The high luminosity, the precise control of the beam \sqrt{s} , the clean reconstruction of final states make it possible to observe:

- ◆ $20 \text{ ab}^{-1} / \text{year}$ at $\sqrt{s} = 125 \text{ GeV}$ (not in baseline FCC-ee)
- ◆ Monochromatization $\sigma_{\sqrt{s}} \sim 1-2 \times \Gamma_H \sim 6 \text{ to } 10 \text{ MeV}$
 - Resonant $ee \rightarrow H$ production

Upper Limits / Precision on κ_e

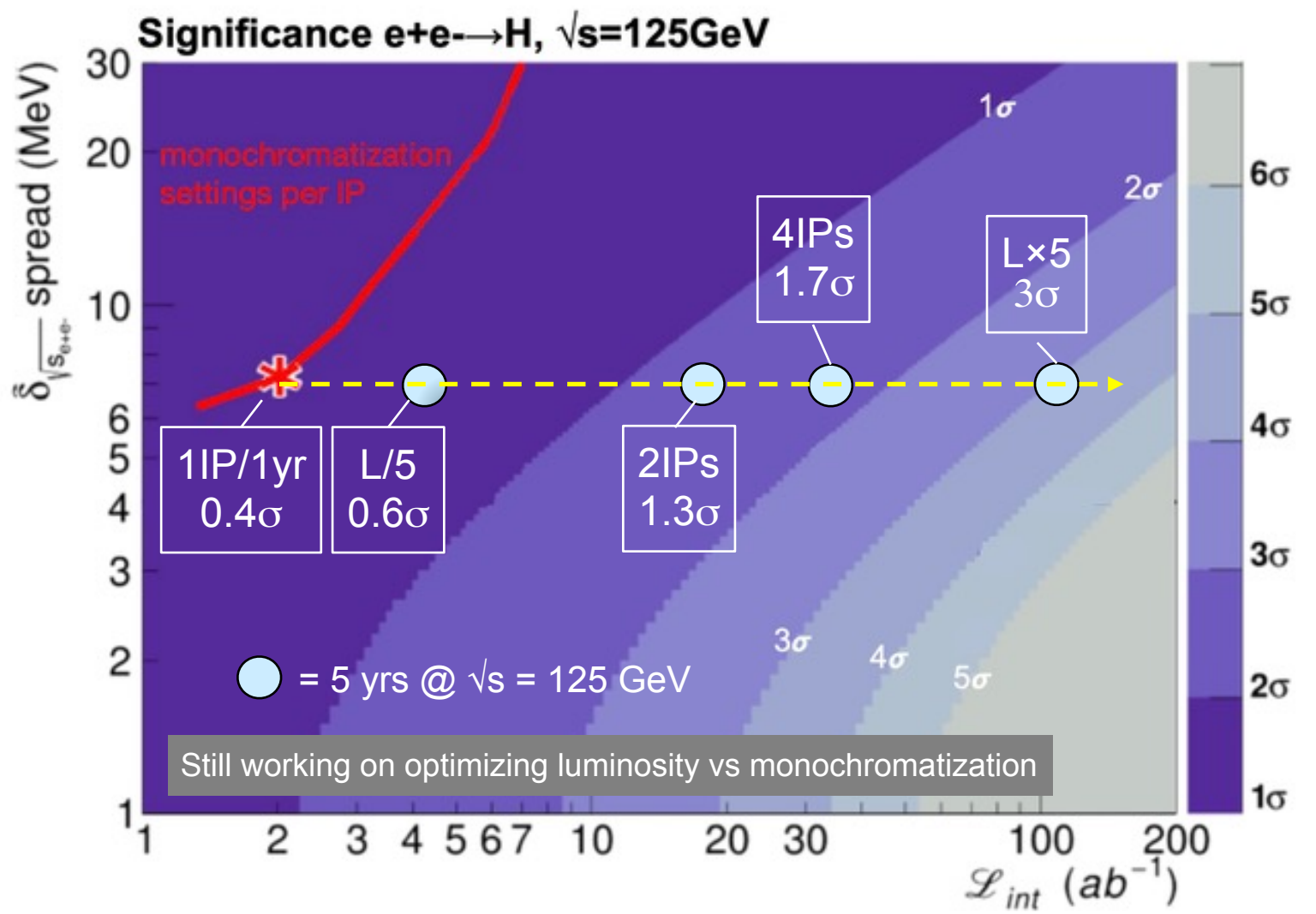
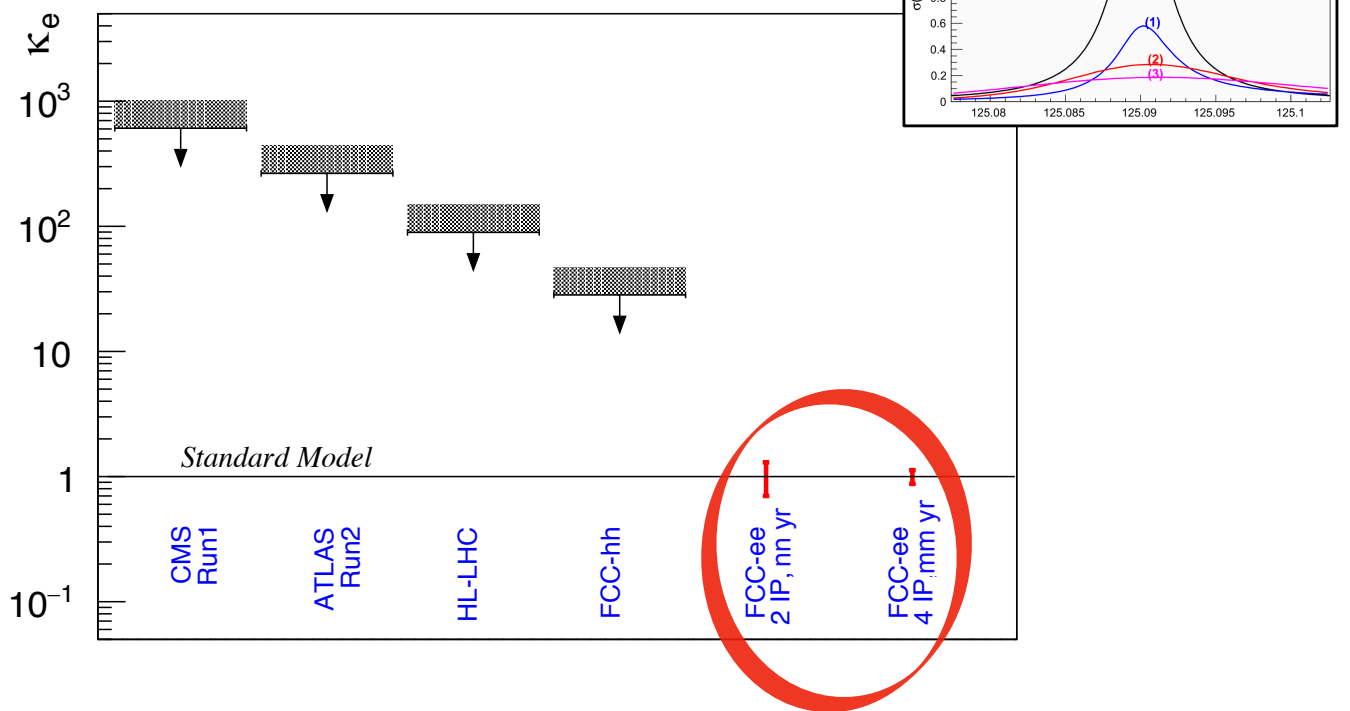

Higgs @ FCC-hh.

	ggH (N ³ LO)	VBF (N ² LO)	WH (N ² LO)	ZH (N ² LO)	t \bar{t} H (N ² LO)	HH (NLO)
N100	24×10^9	2.1×10^9	4.6×10^8	3.3×10^8	9.6×10^8	3.6×10^7
N100/N14	180	170	100	110	530	390

(N100 = $\sigma_{100 \text{ TeV}} \times 30 \text{ ab}^{-1}$ & N14 = $\sigma_{14 \text{ TeV}} \times 3 \text{ ab}^{-1}$)

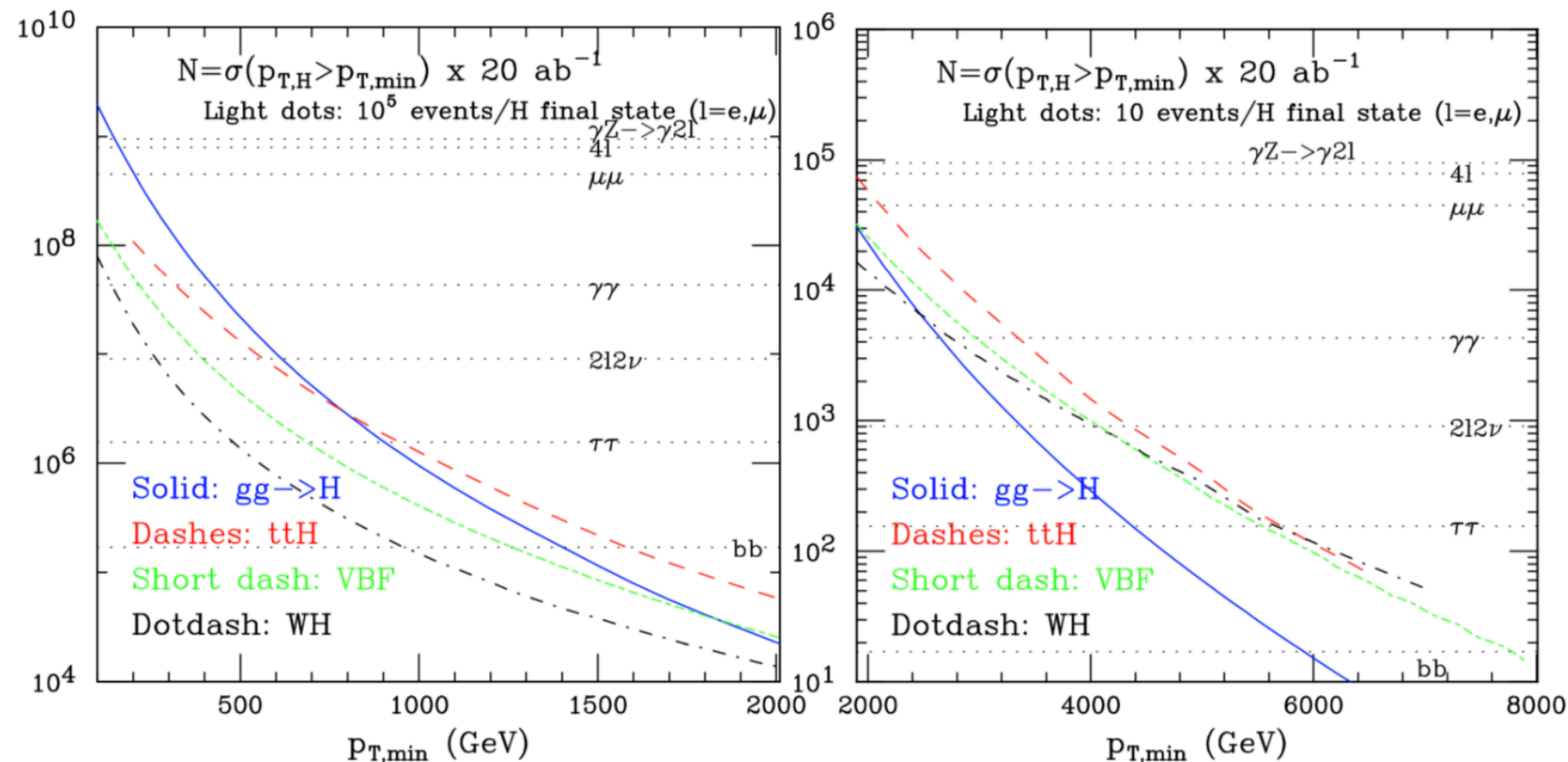

- Large rate ($> 10^{10}$ H, $> 10^7$ HH)
 - unique sensitivity to rare decays
 - few % sensitivity to self-coupling
- Explore extreme phase space:
 - e.g. 10^6 H w/ $p_T > 1$ TeV
 - clean samples with high S/B
 - small systematics

Tera-Z EW precision measurements.

► The target is to reduce syst. uncertainties to the level of stat. uncertainties.
(exploit the large samples and innovative control analyses)

► Exquisite \sqrt{s} precision (100keV@Z, 300keV@WW) reduces beam uncertainties (EPOL)

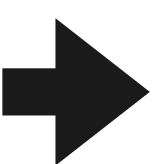

~50 times better precision than LEP/LSD on EW precision observables

(stat. improvement alone is a factor 300-2'000 so innovative analyses can bring syst. down too)

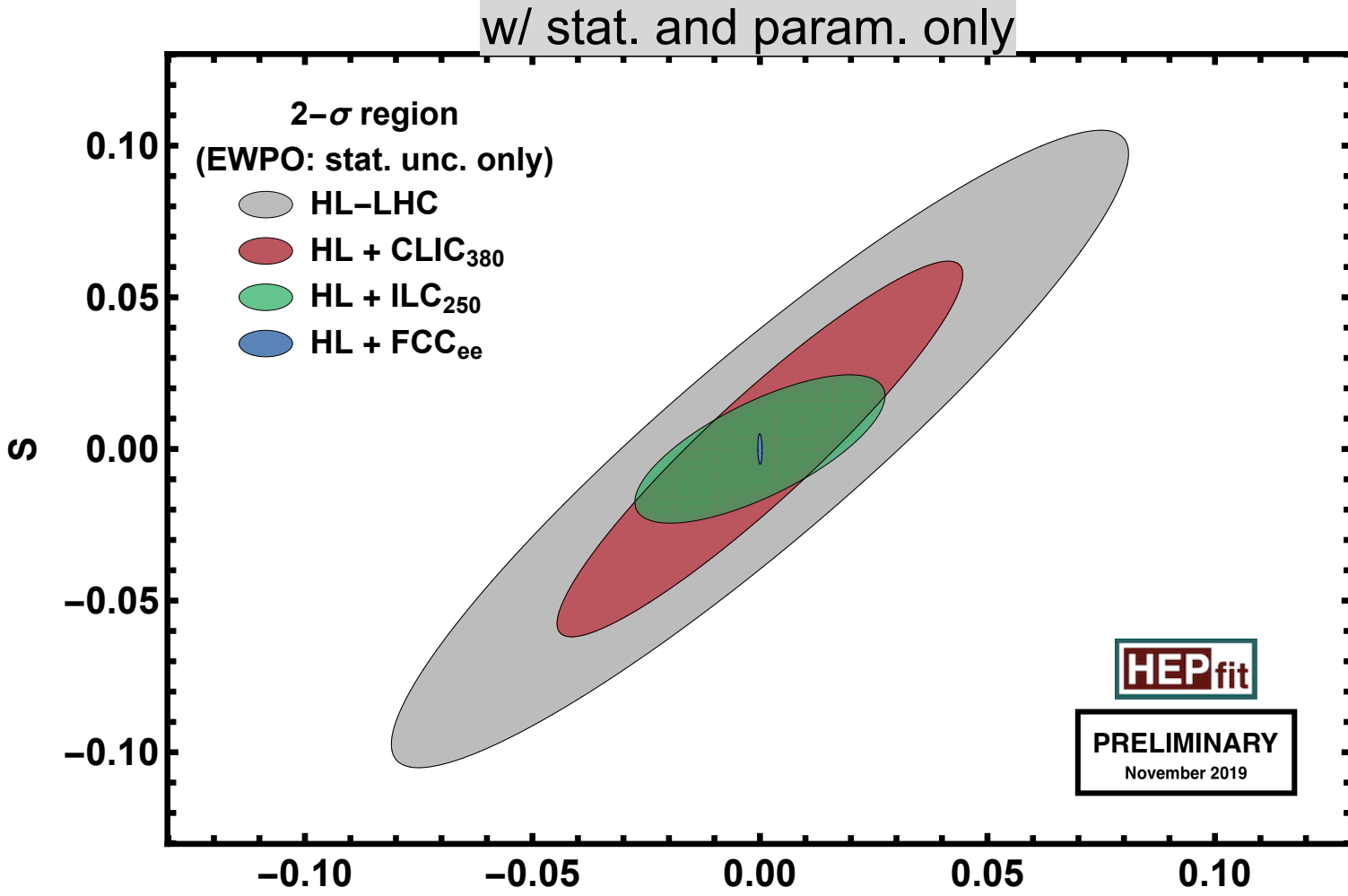

Indirect sensitivity
to 70TeV-scale sector
connected to EW/Higgs

(For the impact of the theory uncertainties on the EW fit, see bonus slides)

Tera-Z EW precision measurements.

- ▶ The target is to reduce syst. uncertainties to the level of stat. uncertainties.
(exploit the large samples and innovative control analyses)

- ▶ Exquisite \sqrt{s} precision (100keV@Z, 300keV@WW) reduces beam uncertainties (EPOL)

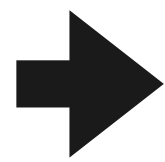

~50 times better precision than LEP/LSD on EW precision observables

(stat. improvement alone is a factor 300-2'000 so innovative analyses can bring syst. down too)

Need TH results to fully exploit Tera-Z

Table from mid-term report

Quantity	Current precision	FCC-ee stat. (syst.) precision	Required theory input	Available calc. in 2019	Needed theory improvement [†]
m_Z	2.1 MeV	0.004 (0.1) MeV	non-resonant	NLO,	NNLO for
Γ_Z	2.3 MeV	0.004 (0.025) MeV	$e^+e^- \rightarrow f\bar{f}$,	ISR logarithms	$e^+e^- \rightarrow f\bar{f}$
$\sin^2 \theta_{\text{eff}}^\ell$	1.6×10^{-4}	$2(2.4) \times 10^{-6}$	initial-state radiation (ISR)	up to 6th order	
m_W	12 MeV	0.25 (0.3) MeV	lineshape of $e^+e^- \rightarrow WW$ near threshold	NLO ($ee \rightarrow 4f$ or EFT framework)	NNLO for $ee \rightarrow WW$, $W \rightarrow f\bar{f}$ in EFT setup
HZZ coupling	—	0.2%	cross-sect. for $e^+e^- \rightarrow ZH$	NLO + NNLO QCD	NNLO electroweak
m_{top}	100 MeV	17 MeV	threshold scan $e^+e^- \rightarrow t\bar{t}$	N ³ LO QCD, NNLO EW, resummations up to NNLL	Matching fixed orders with resummations, merging with MC, α_s (input)

Indirect sensitivity to 70TeV-scale sector connected to EW/Higgs

[†]The listed needed theory calculations constitute a minimum baseline; additional partial higher-order contributions may also be required.

New Physics Reach @ Z-pole.

There are 48 different types of particles that can have tree-level linear interactions to SM.

de Blas, Criado, Perez-Victoria, Santiago, arXiv: 1711.10391

Name	\mathcal{S}	\mathcal{S}_1	\mathcal{S}_2	φ	Ξ	Ξ_1	Θ_1	Θ_3
Irrep	$(1, 1)_0$	$(1, 1)_1$	$(1, 1)_2$	$(1, 2)_{\frac{1}{2}}$	$(1, 3)_0$	$(1, 3)_1$	$(1, 4)_{\frac{1}{2}}$	$(1, 4)_{\frac{3}{2}}$

Name	ω_1	ω_2	ω_4	Π_1	Π_7	ζ
Irrep	$(3, 1)_{-\frac{1}{3}}$	$(3, 1)_{\frac{2}{3}}$	$(3, 1)_{-\frac{4}{3}}$	$(3, 2)_{\frac{1}{6}}$	$(3, 2)_{\frac{7}{6}}$	$(3, 3)_{-\frac{1}{3}}$

Name	Ω_1	Ω_2	Ω_4	Υ	Φ
Irrep	$(6, 1)_{\frac{1}{3}}$	$(6, 1)_{-\frac{2}{3}}$	$(6, 1)_{\frac{4}{3}}$	$(6, 3)_{\frac{1}{3}}$	$(8, 2)_{\frac{1}{2}}$

Scalars

Name	N	E	Δ_1	Δ_3	Σ	Σ_1
Irrep	$(1, 1)_0$	$(1, 1)_{-1}$	$(1, 2)_{-\frac{1}{2}}$	$(1, 2)_{-\frac{3}{2}}$	$(1, 3)_0$	$(1, 3)_{-1}$

Name	U	D	Q_1	Q_5	Q_7	T_1	T_2
Irrep	$(3, 1)_{\frac{2}{3}}$	$(3, 1)_{-\frac{1}{3}}$	$(3, 2)_{\frac{1}{6}}$	$(3, 2)_{-\frac{5}{6}}$	$(3, 2)_{\frac{7}{6}}$	$(3, 3)_{-\frac{1}{3}}$	$(3, 3)_{\frac{2}{3}}$

Fermions

Name	\mathcal{B}	\mathcal{B}_1	\mathcal{W}	\mathcal{W}_1	\mathcal{G}	\mathcal{G}_1	\mathcal{H}	\mathcal{L}_1
Irrep	$(1, 1)_0$	$(1, 1)_1$	$(1, 3)_0$	$(1, 3)_1$	$(8, 1)_0$	$(8, 1)_1$	$(8, 3)_0$	$(1, 2)_{\frac{1}{2}}$

Name	\mathcal{L}_3	\mathcal{U}_2	\mathcal{U}_5	\mathcal{Q}_1	\mathcal{Q}_5	\mathcal{X}	\mathcal{Y}_1	\mathcal{Y}_5
Irrep	$(1, 2)_{-\frac{3}{2}}$	$(3, 1)_{\frac{2}{3}}$	$(3, 1)_{\frac{5}{3}}$	$(3, 2)_{\frac{1}{6}}$	$(3, 2)_{-\frac{5}{6}}$	$(3, 3)_{\frac{2}{3}}$	$(\bar{6}, 2)_{\frac{1}{6}}$	$(\bar{6}, 2)_{-\frac{5}{6}}$

Vectors

They are not all affecting EW observables at tree-level.

New Physics Reach @ Z-pole.

There are 48 different types of particles that can have tree-level linear interactions to SM.

They are not all affecting EW observables at tree-level.
However, all, but a few, have leading log. running into EW observables.

Allwicher, McCullough, Renner, in progress

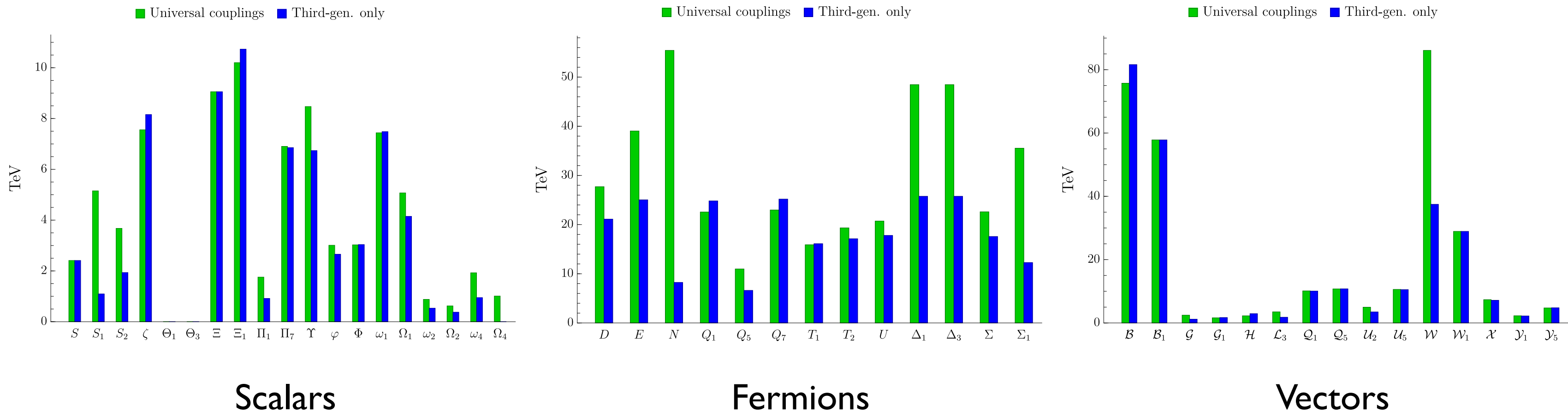

Tree-level matching and running from 1 TeV to Z mass.
W- and Z-pole observables only (no Higgs, no LEP-2 like observables)

5.
FCC-ee as a flavour factory

Flavour potential.

At present (Z/h/NewPhysics) FCNCs mostly constrained by low energy observables.
 The large statistics of FCC will open on-shell opportunities.

Particle production (10^9)	B^0 / \bar{B}^0	B^+ / B^-	B_s^0 / \bar{B}_s^0	$\Lambda_b / \bar{\Lambda}_b$	$c\bar{c}$	τ^- / τ^+
Belle II	27.5	27.5	n/a	n/a	65	45
FCC- ee	300	300	80	80	600	150

FCC- ee
 =
 10 x Belle II

Decay mode/Experiment	Belle II (50/ab)	LHCb Run I	LHCb Upgr. (50/fb)	FCC- ee
EW/H penguins				
$B^0 \rightarrow K^*(892)e^+e^-$	~ 2000	~ 150	~ 5000	~ 200000
$\mathcal{B}(B^0 \rightarrow K^*(892)\tau^+\tau^-)$	~ 10	–	–	~ 1000
$B_s \rightarrow \mu^+\mu^-$	n/a	~ 15	~ 500	~ 800
$B^0 \rightarrow \mu^+\mu^-$	~ 5	–	~ 50	~ 100
$\mathcal{B}(B_s \rightarrow \tau^+\tau^-)$				
Leptonic decays				
$B^+ \rightarrow \mu^+\nu_{mu}$	5%	–	–	3%
$B^+ \rightarrow \tau^+\nu_{tau}$	7%	–	–	2%
$B_c^+ \rightarrow \tau^+\nu_{tau}$	n/a	–	–	5%
CP / hadronic decays				
$B^0 \rightarrow J/\Psi K_S (\sigma_{\sin(2\phi_d)})$	$\sim 2 \cdot 10^6 (0.008)$	41500 (0.04)	$\sim 0.8 \cdot 10^6 (0.01)$	$\sim 35 \cdot 10^6 (0.006)$
$B_s \rightarrow D_s^\pm K^\mp$	n/a	6000	~ 200000	$\sim 30 \cdot 10^6$
$B_s(B^0) \rightarrow J/\Psi\phi (\sigma_{\phi_s} \text{ rad})$	n/a	96000 (0.049)	$\sim 2 \cdot 10^6 (0.008)$	$16 \cdot 10^6 (0.003)$

See S. Monteil, Flavour@FCC'22

out of reach
 at LHCb/Belle

boosted b's/ τ 's
 at FCC- ee
 Makes possible
 a topological rec.
 of the decays
 w/ miss. energy

Flavour potential.

At present (Z/h/NewPhysics) FCNCs mostly constrained by low energy observables.
 The large statistics of FCC will open on-shell opportunities.

See S. Monteil, Flavour@FCC'22

Particle production	(10^9)	B^0 / \bar{B}^0	B^+ / B^-	B_s^0 / \bar{B}_s^0	$\Lambda_b / \bar{\Lambda}_b$	$c\bar{c}$	τ^- / τ^+	
Decay							45	
EW/H							150	
$B^0 \rightarrow \mu^+ \mu^-$								
$\mathcal{B}(B^0 \rightarrow \mu^+ \mu^-)$								
$B_s \rightarrow \mu^+ \mu^-$								
$B^0 \rightarrow \mu^+ \mu^-$								
$\mathcal{B}(B_s \rightarrow \mu^+ \mu^-)$								
Lepton								
$B^+ \rightarrow \mu^+ \nu_\tau$								
$B^+ \rightarrow \tau^+ \nu_\tau$								
$\mathcal{B}(B_c^+ \rightarrow \tau^+ \nu_\tau)$		n/a	-	-	-	5%		
CP / hadronic decays								
$B^0 \rightarrow J/\Psi K_S (\sigma_{\sin(2\phi_d)})$	$\sim 2 \cdot 10^6$	(0.008)	41500	(0.04)	$\sim 0.8 \cdot 10^6$	(0.01)	$\sim 35 \cdot 10^6$	(0.006)
$B_s \rightarrow D_s^\pm K^\mp$	n/a		6000		~ 200000		$\sim 30 \cdot 10^6$	
$B_s(B^0) \rightarrow J/\Psi \phi (\sigma_{\phi_s} \text{ rad})$	n/a		96000	(0.049)	$\sim 2 \cdot 10^6$	(0.008)	$16 \cdot 10^6$	(0.003)

Attribute	$\Upsilon(4S)$	pp	Z^0
All hadron species		✓	✓
High boost		✓	✓
Enormous production cross-section		✓	
Negligible trigger losses	✓		✓
Low backgrounds	✓		✓
Initial energy constraint	✓		(✓)

FCC-ee
 =
 10 x Belle II

out of reach
 at LHCb/Belle

boosted b's/ τ 's
 at FCC-ee

Makes possible
 a topological rec.
 of the decays
 w/ miss. energy

Flavour defines shared (vertexing, tracking, calorimetry) and specific (hadronic PID) detector requirements.

FCC-ee flavour opportunities.

- **CKM element V_{cb}** (critical for normalising the Unitarity Triangle) from WW decays
- **Tau physics** ($>10^{11}$ pairs of tau's produced in Z decays)
 - test of lepton flavour universality: G_F from tau decays @ 10 ppm @ FCC-ee (0.5 ppm from muon decays)
 - lepton flavour violation:
 - $\tau \rightarrow \mu \gamma$: 4×10^{-8} @ Belle2021 $\rightarrow 10^{-9}$ @ FCC-ee
 - $\tau \rightarrow 3\mu$: 2×10^{-8} @ Belle $\rightarrow 3 \times 10^{-10}$ @ BelleII $\rightarrow 10^{-11}$ @ FCC-ee
 - tau lifetime uncertainty:
 - 2000 ppm \rightarrow 10 ppm
 - tau mass uncertainty:
 - 70 ppm \rightarrow 14 ppm
- **Semi-leptonic mixing asymmetries a_{sl}^s and a_{sl}^d**
- ...

6.

FCC-hh: the broadest exploration potential at high-energy

Resonance production.

Protons are made of 5 quarks, gluons, photons, W/Z

FCC-hh effectively collides 196 different initial states = perfect exploratory machine

resonances produced

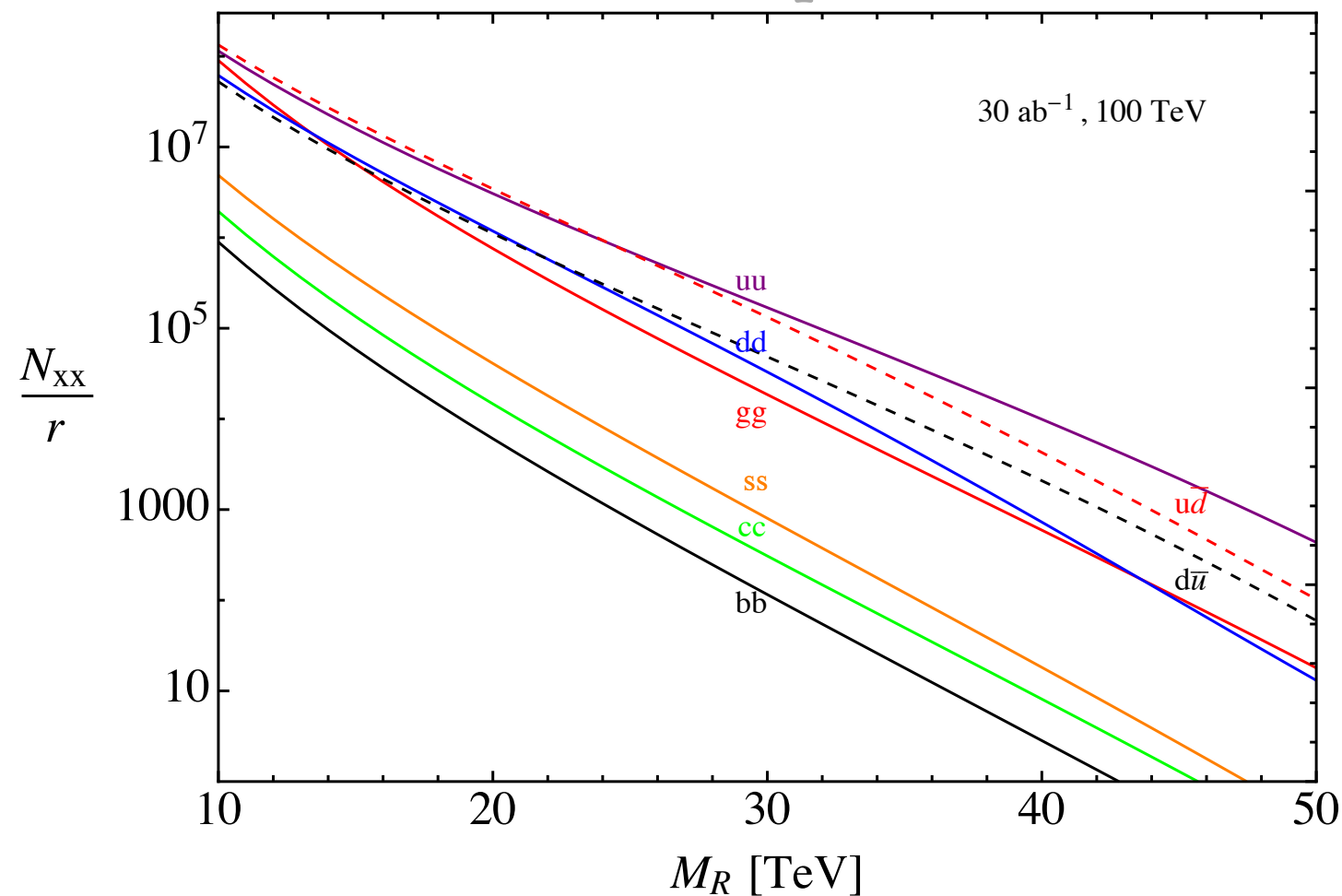

Plot from mid-term report

FCC-hh mass reach

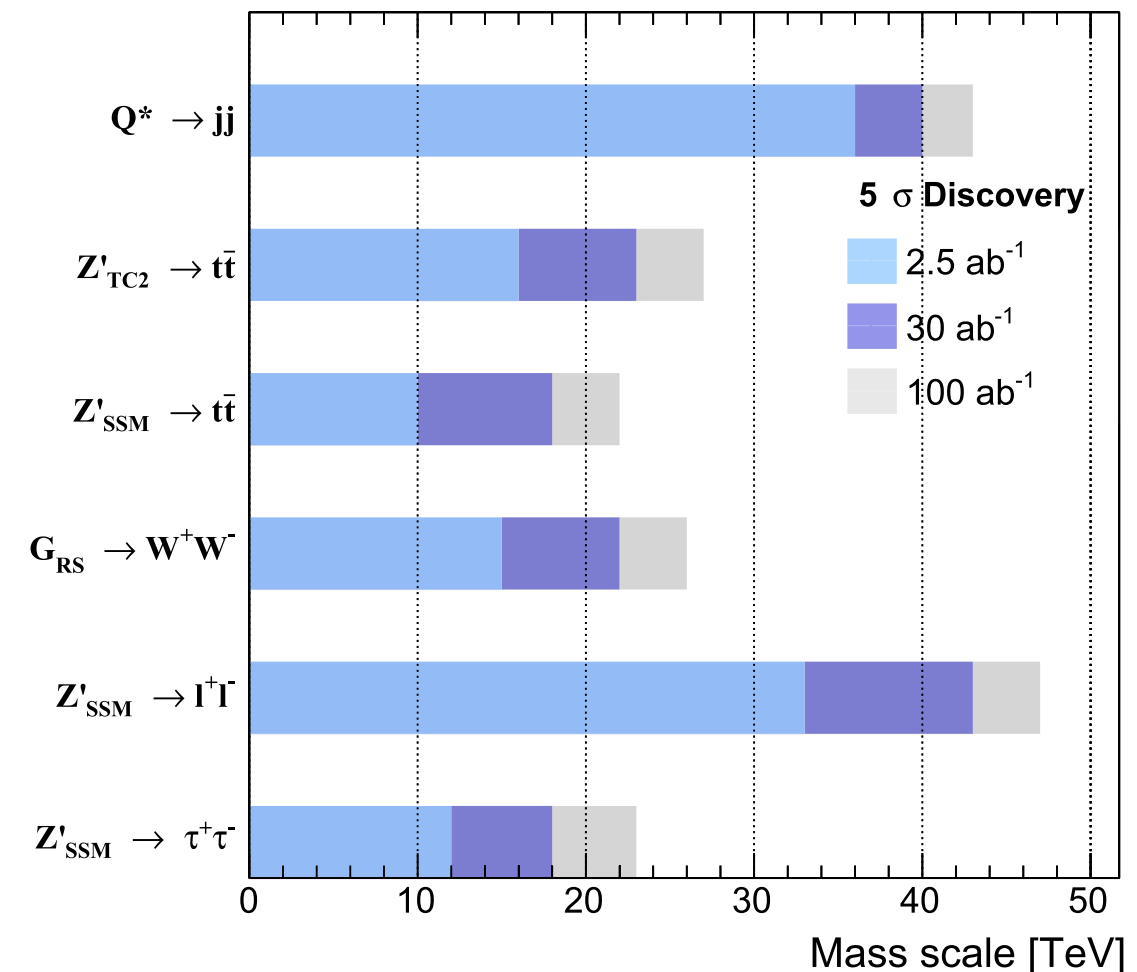

Plot from FCC CDR

FCC-hh allows the direct exploration of new physics at energy scales up to 40 TeV, including any physics that may be indirectly indicated by precision Higgs and EW measurements at FCC-ee.

Pushing limits of SUSY.

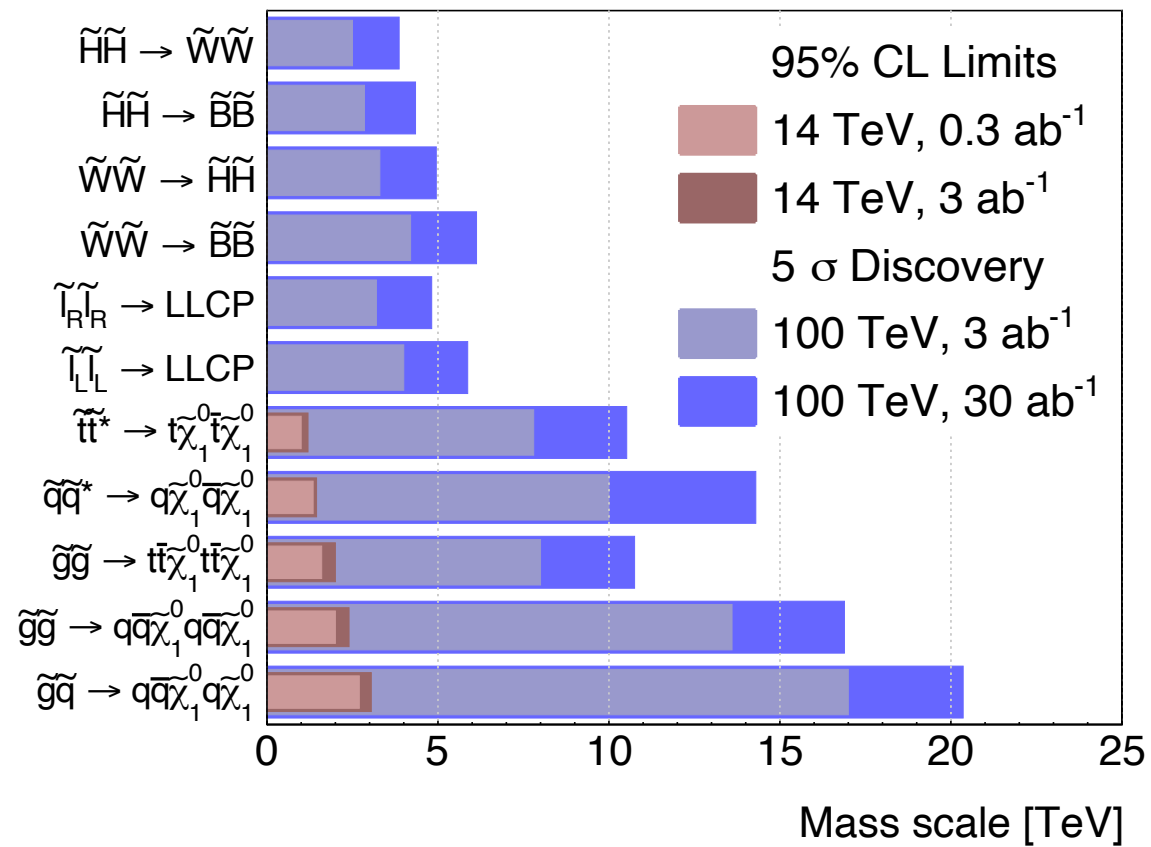

Plot from [arXiv:1606.00947](https://arxiv.org/abs/1606.00947)

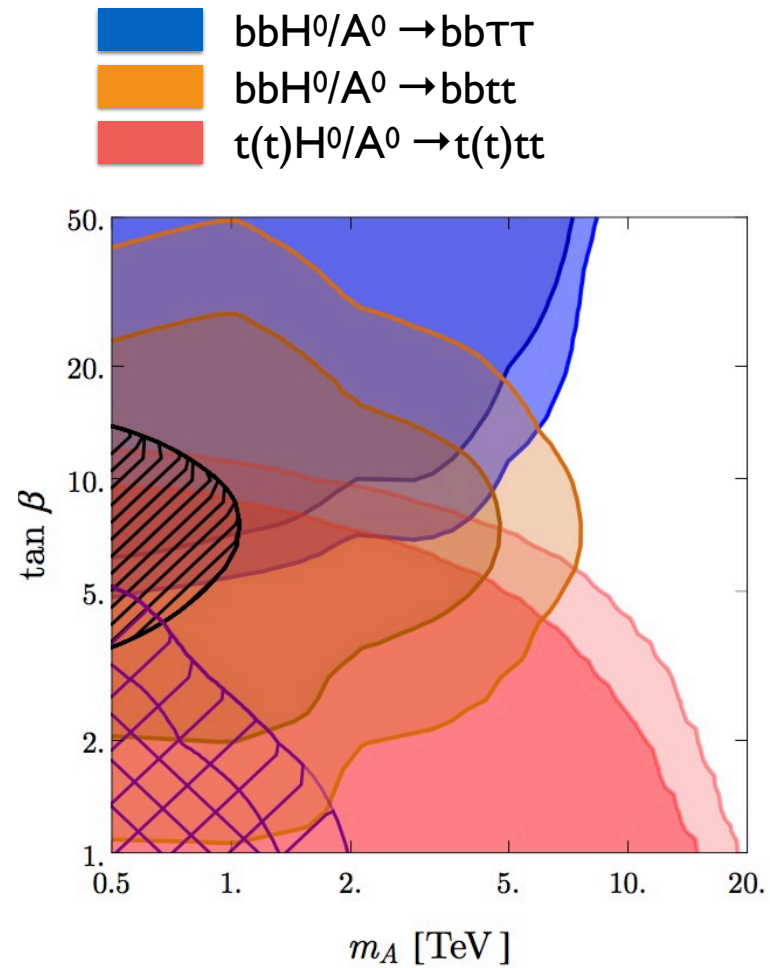

Plot from [arXiv:1605.08744](https://arxiv.org/abs/1605.08744) and [arXiv:1504.07617](https://arxiv.org/abs/1504.07617)

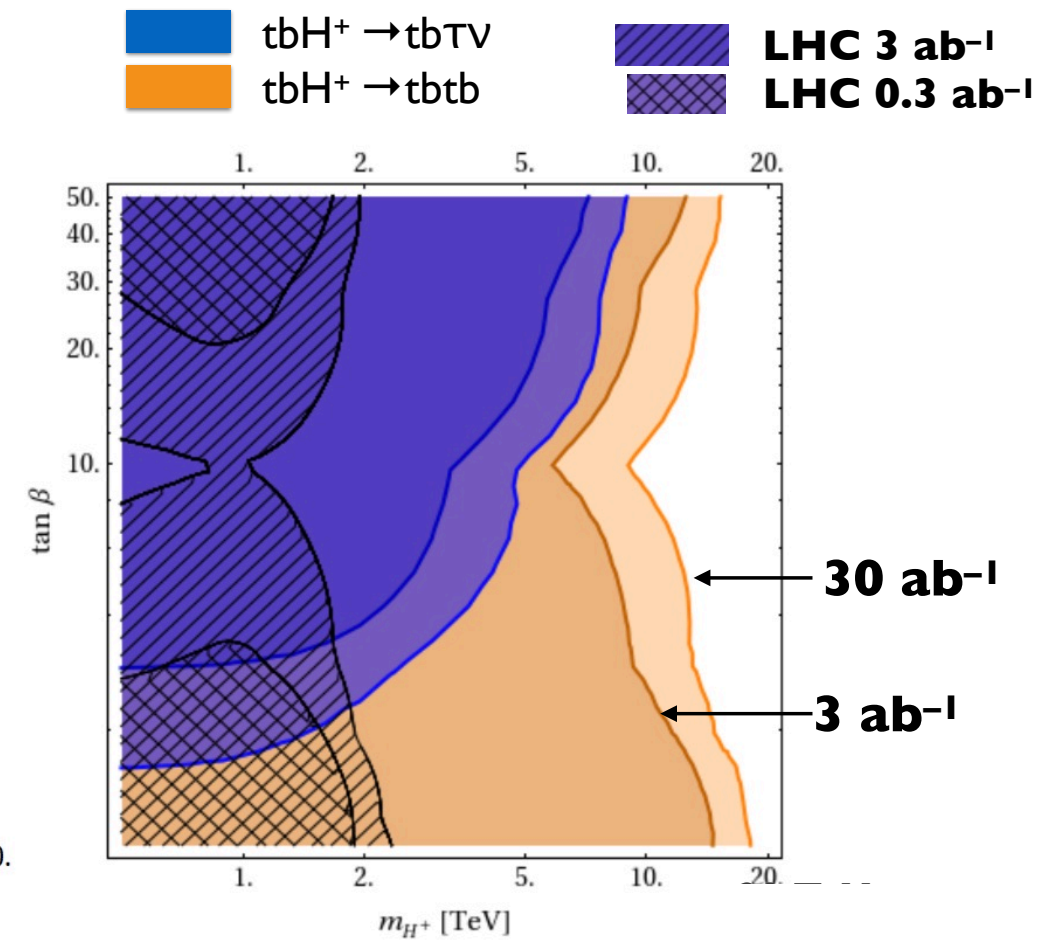

Factor 10 increase on the HL-LHC limits.

15-20TeV squarks/gluinos
 require kinematic threshold 30-40TeV:
 FCC-hh is more than a $\sqrt{s} \sim 10\text{TeV}$ factory

7.
Examples of
complementarity & synergy FCC-ee ↔ FCC-hh

Synergy $ee \leftrightarrow hh$.

1 FCC-hh without ee could bound BR_{inv} but it could say nothing about $BR_{untagged}$ (FCC- ee needed for absolute normalisation of Higgs couplings)

FCC-hh is determining top Yukawa through ratio $t\bar{t}h/t\bar{t}Z$

So the extraction of top Yukawa heavily relies on the knowledge of $t\bar{t}Z$ from FCC- ee

K_t (%)

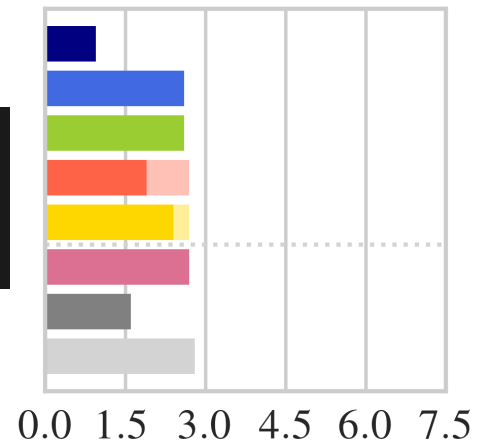

Mangano+ '15

	$\sigma(t\bar{t}H)$ [pb]	$\sigma(t\bar{t}Z)$ [pb]	$\frac{\sigma(t\bar{t}H)}{\sigma(t\bar{t}Z)}$
13 TeV	$0.475^{+5.79\%+3.33\%}_{-9.04\%-3.08\%}$	$0.785^{+9.81\%+3.27\%}_{-11.2\%-3.12\%}$	$0.606^{+2.45\%+0.525\%}_{-3.66\%-0.319\%}$
100 TeV	$33.9^{+7.06\%+2.17\%}_{-8.29\%-2.18\%}$	$57.9^{+8.93\%+2.24\%}_{-9.46\%-2.43\%}$	$0.585^{+1.29\%+0.314\%}_{-2.02\%-0.147\%}$

(uncertainty drops in ratio)

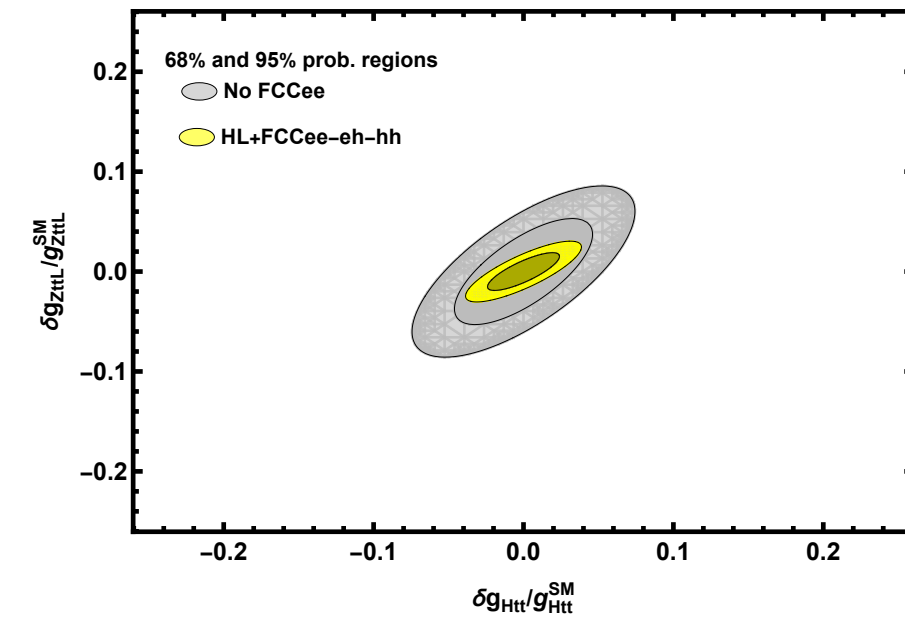

3 Subsequently, the 1% sensitivity on $t\bar{t}h$ is essential to determine h^3 at O(5%) at FCC-hh

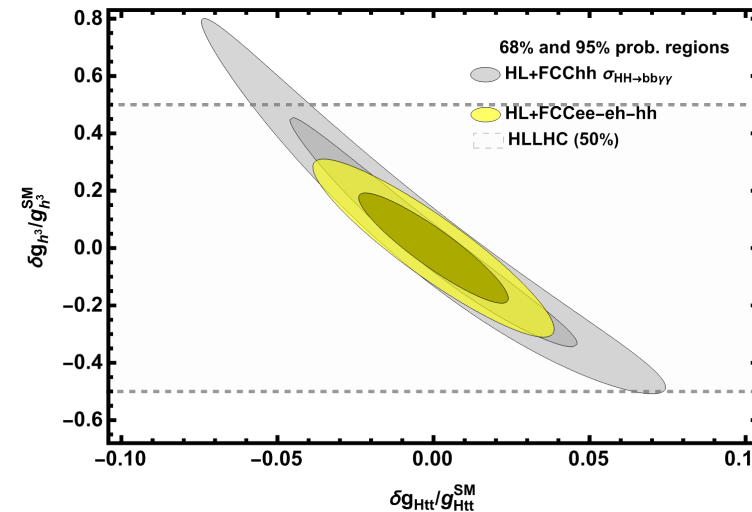

Plots from mid-term report

FCC-hh tunnel is great for FCC-ee.

- **80-100 km is needed to accelerate pp up to 100 TeV**
- **80-100 km is also exactly what is needed**
 - to get enough luminosity (5 times more than in 27 km) to maybe get sensitivity to the Higgs self coupling, the electron Yukawa coupling, or sterile neutrinos,
 - to make TeraZ a useful flavour factory,
 - for transverse polarisation to be available all the way to the WW threshold (allowing a precise W mass measurement)
 - for the top threshold to be reached and exceeded.

Conclusions & Outlook

A circular “**Higgs factory**” like FCC-ee has a rich potential:

- * Search directly *&* indirectly for New Physics
- * Establish new organising principles of Nature (LEP→ gauge symmetries, FCC→??)

And FCC-ee is an essential part of an integrated programme to probe the energy frontier.

The FCC project perfectly fits the **needs of HEP after LHC**:

- * guaranteed deliverables & broad exploration potential *

**We have profound questions and we need to create opportunities to answer them.
FCC will for sure contribute.**

Colliders are the most powerful microscopes we have to study Nature at the smallest scales and also from the early moments of the Universe. They'll keep providing a quantitative understanding to progress forward.

Acknowledgement.

This project is supported from the European Union's Horizon 2020 research and innovation programme under grant agreement No 951754.



BONUS

Some work ahead of us.

- Development of a common software and the estimate of the computing needs
- Evaluation of the physics performance and requirements for detectors
- Conceptualisation of detectors capable of delivering these requirements
- Mitigation of the interaction region constraints on detectors and vice versa
- Design of methods and tools for centre-of-mass energy calibration, beam polarisation, and monochromatization
- Understanding and optimisation of the physics program
- Exploration of the physics opportunities
- Development of the theoretical tools and observables needed to meet the measurement targets

FCC feasibility study

Objectives of FCC feasibility study.

- Demonstration of the geological, technical, environmental and administrative feasibility of the tunnel and surface areas and optimisation of placement and layout of the ring and related infrastructure.
- Pursuit, together with the Host States, of the preparatory administrative processes required for a potential project approval to identify and remove any showstopper.
- Optimisation of the design of the colliders and their injector chains, supported by R&D to develop the needed key technologies.
- Elaboration of a sustainable operational model for the colliders and experiments in terms of human and financial resource needs, as well as environmental aspects and energy efficiency.
- Development of a consolidated cost estimate, as well as the funding and organisational models needed to enable the project's technical design completion, implementation and operation.
- Identification of substantial resources from outside CERN's budget for the implementation of the first stage of a possible future project (tunnel and FCC-ee).
- Consolidation of the physics case and detector concepts for both colliders.

Optimized placement and layout.

M. Benedikt @ CERN 13.02.24

Layout chosen out of ~ 100 initial variants, based on **geology** and **surface constraints** (land availability, access to roads, etc.), **environment**, (protected zones), **infrastructure** (water, electricity, transport), **machine performance** etc.

“Avoid-reduce-compensate” principle of EU and French regulations

Overall lowest-risk baseline: 90.7 km ring, 8 surface points.
Whole project now adapted to this placement

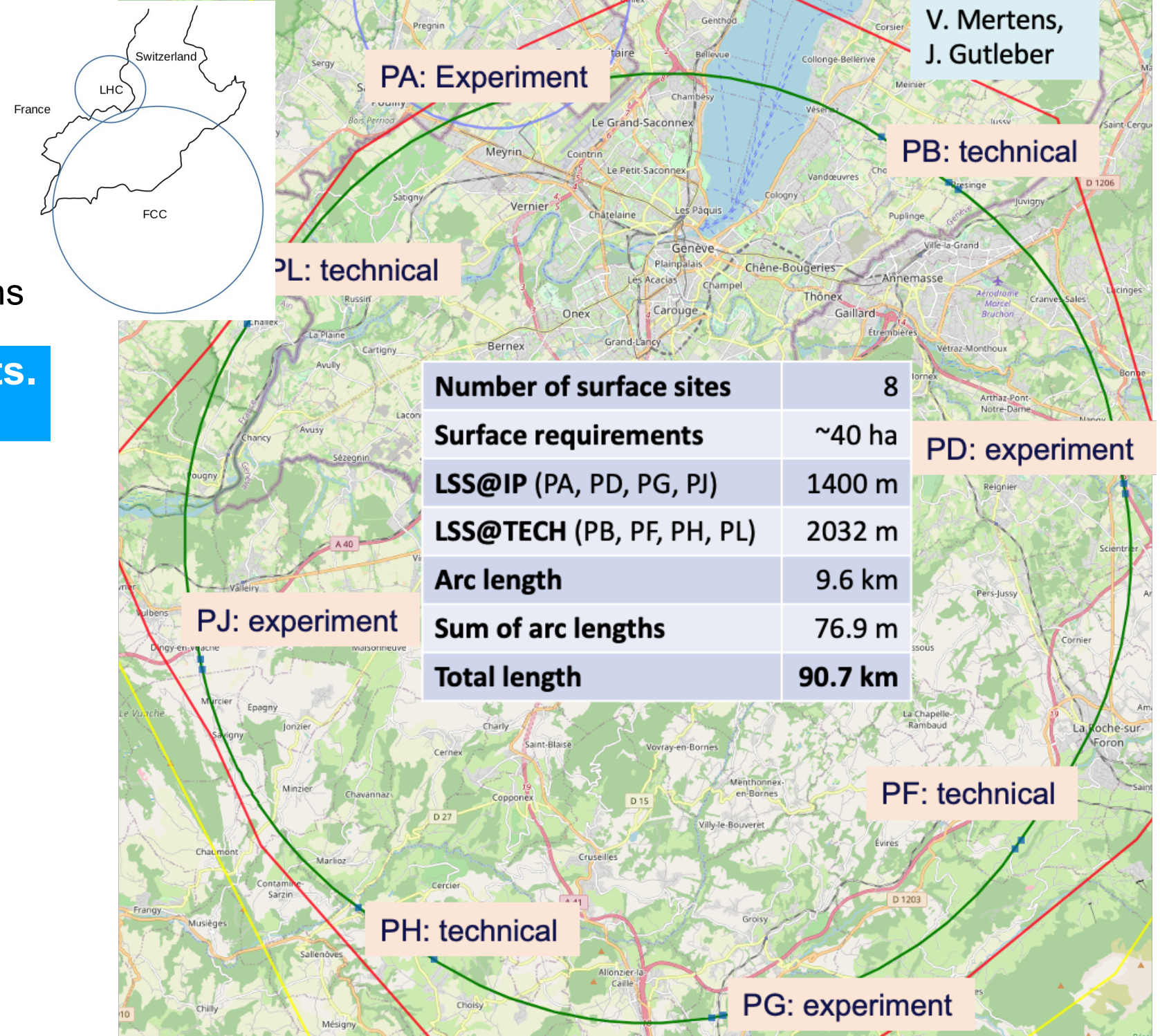
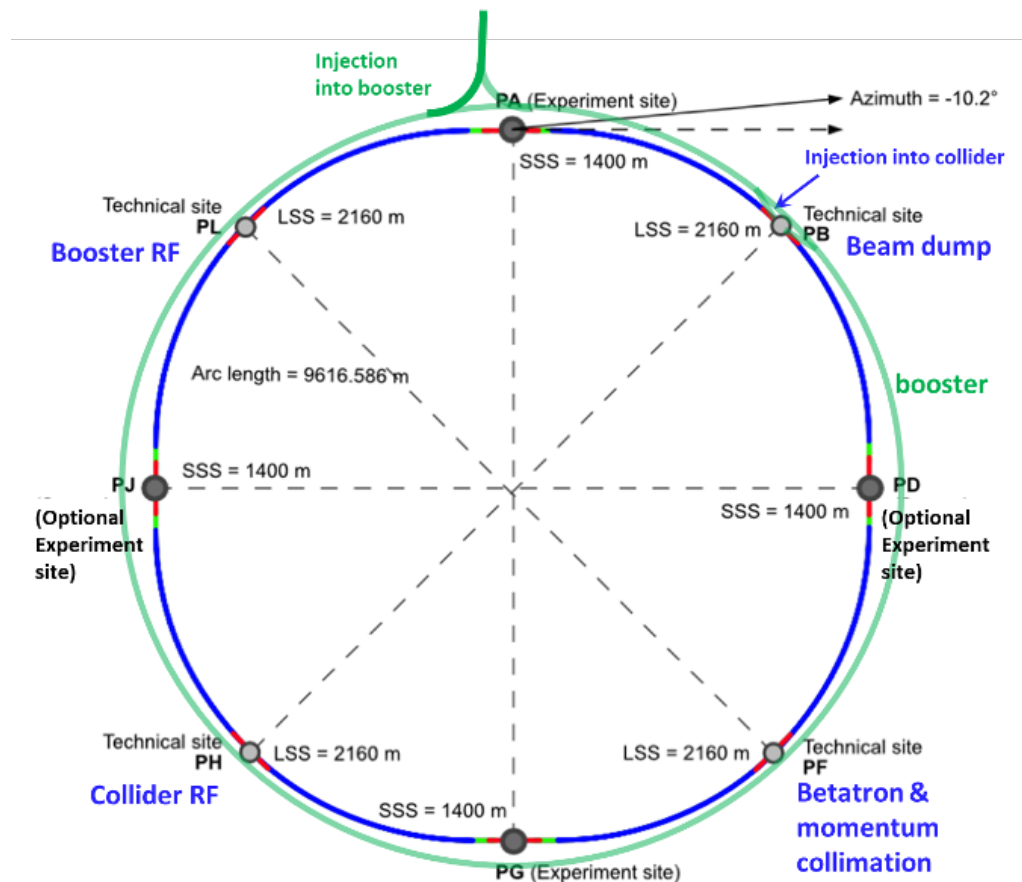

V. Mertens,
J. Gutleber

Optimized placement and layout.

M. Benedikt @ CERN 13.02.24

Layout chosen out of ~ 100 initial variants, based on **geology** and **surface constraints** (land availability, access to roads, etc.), **environment**, (protected zones), **infrastructure** (water, electricity, transport), **machine performance** etc.

“Avoid-reduce-compensate” principle of EU and French regulations

Overall lowest-risk baseline: 90.7 km ring, 8 surface points.
Whole project now adapted to this placement

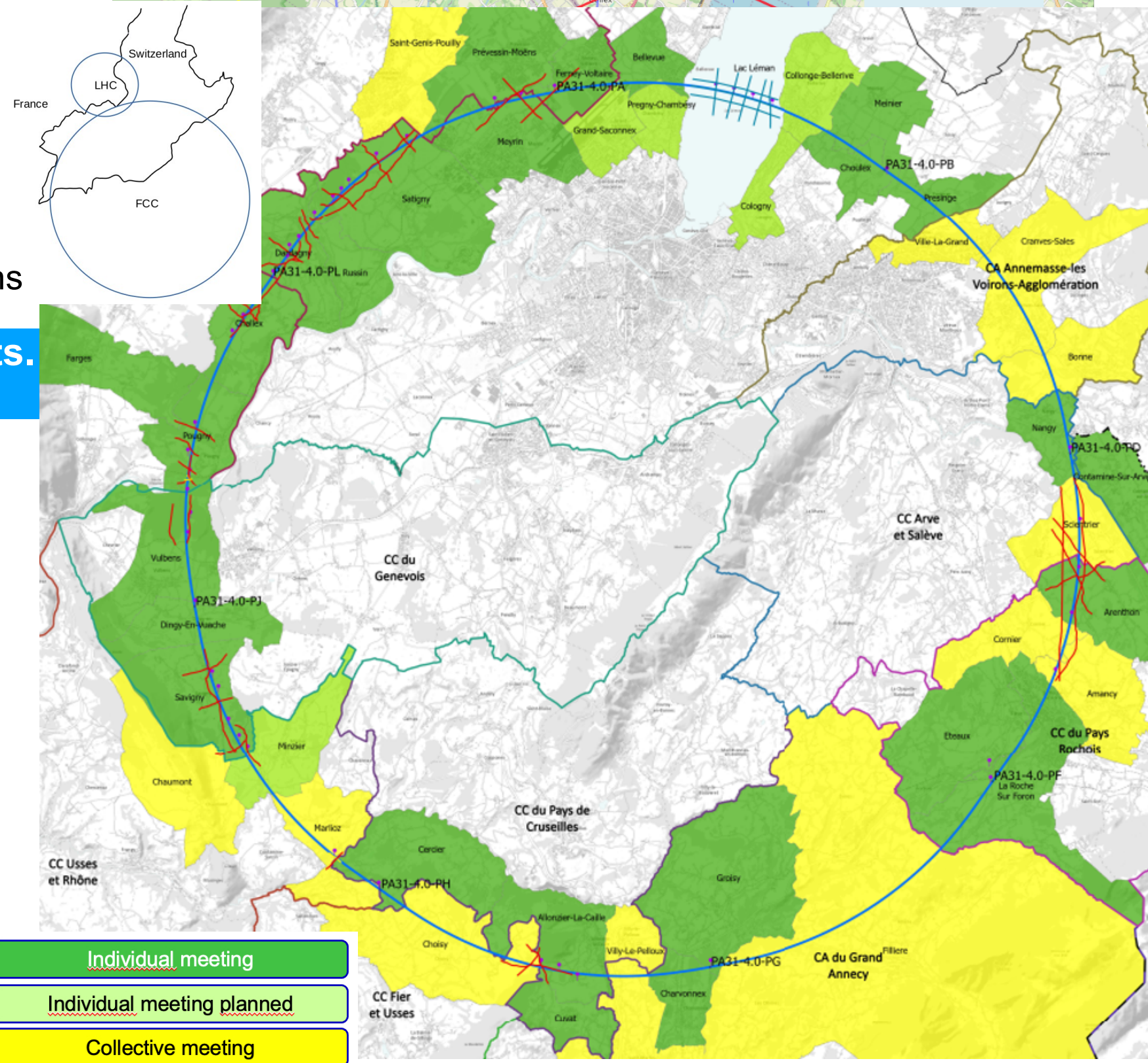
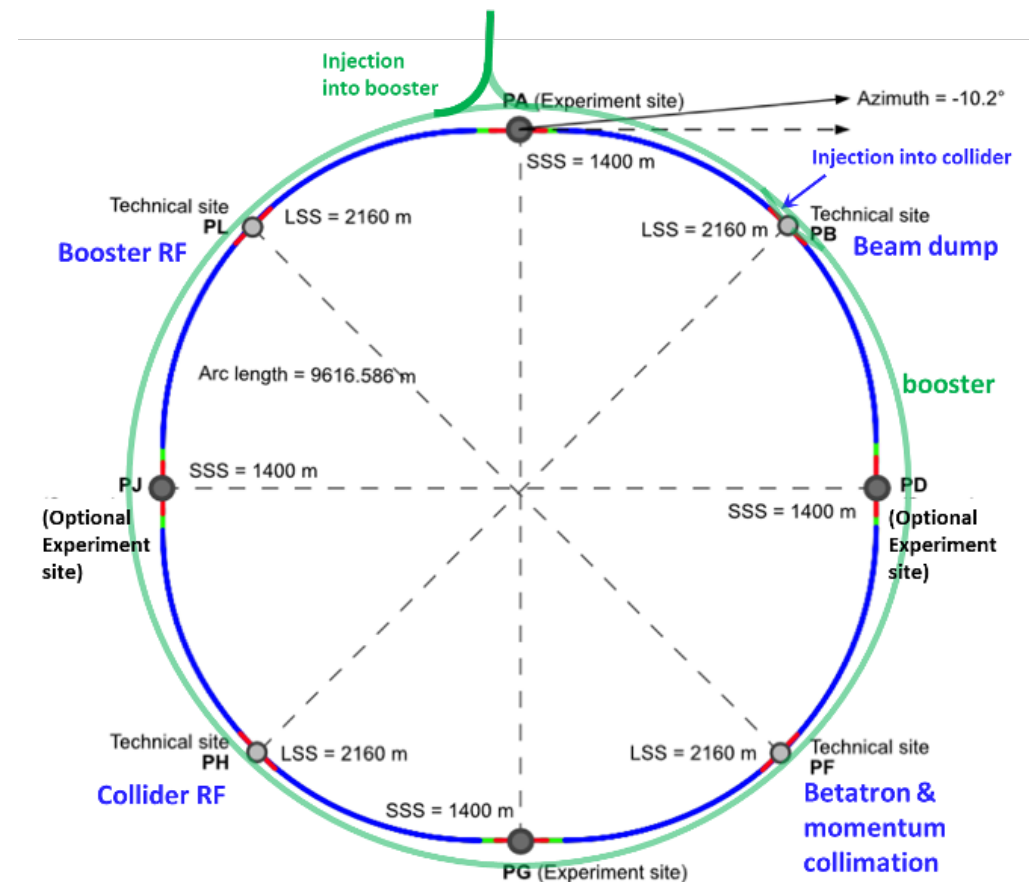

Optimized placement and layout.

M. Benedikt @ CERN 13.02.24

Layout chosen out of ~ 100 initial variants, based on **geology** and **surface constraints** (land availability, access to roads, etc.), **environment**, (protected zones), **infrastructure** (water, electricity, transport), **machine performance** etc.

“Avoid-reduce-compensate” principle of EU and French regulations

Overall lowest-risk baseline: 90.7 km ring, 8 surface points.
Whole project now adapted to this placement

- **Site investigations in areas with uncertain geological conditions:**

- ▶ Optimisation of localisation of drilling locations ongoing with site visits since end 2022.
- ▶ Alignment with FR and CH on the process for obtaining autorisation procedures. Ongoing for start of drillings in Q2/2024

- **Contracts Status:**

- ▶ Contract for engineering services and role of Engineer during works, active since July 2022
- ▶ Site investigations tendering ongoing towards contract placement in December 2023 and mobilization from January 2024

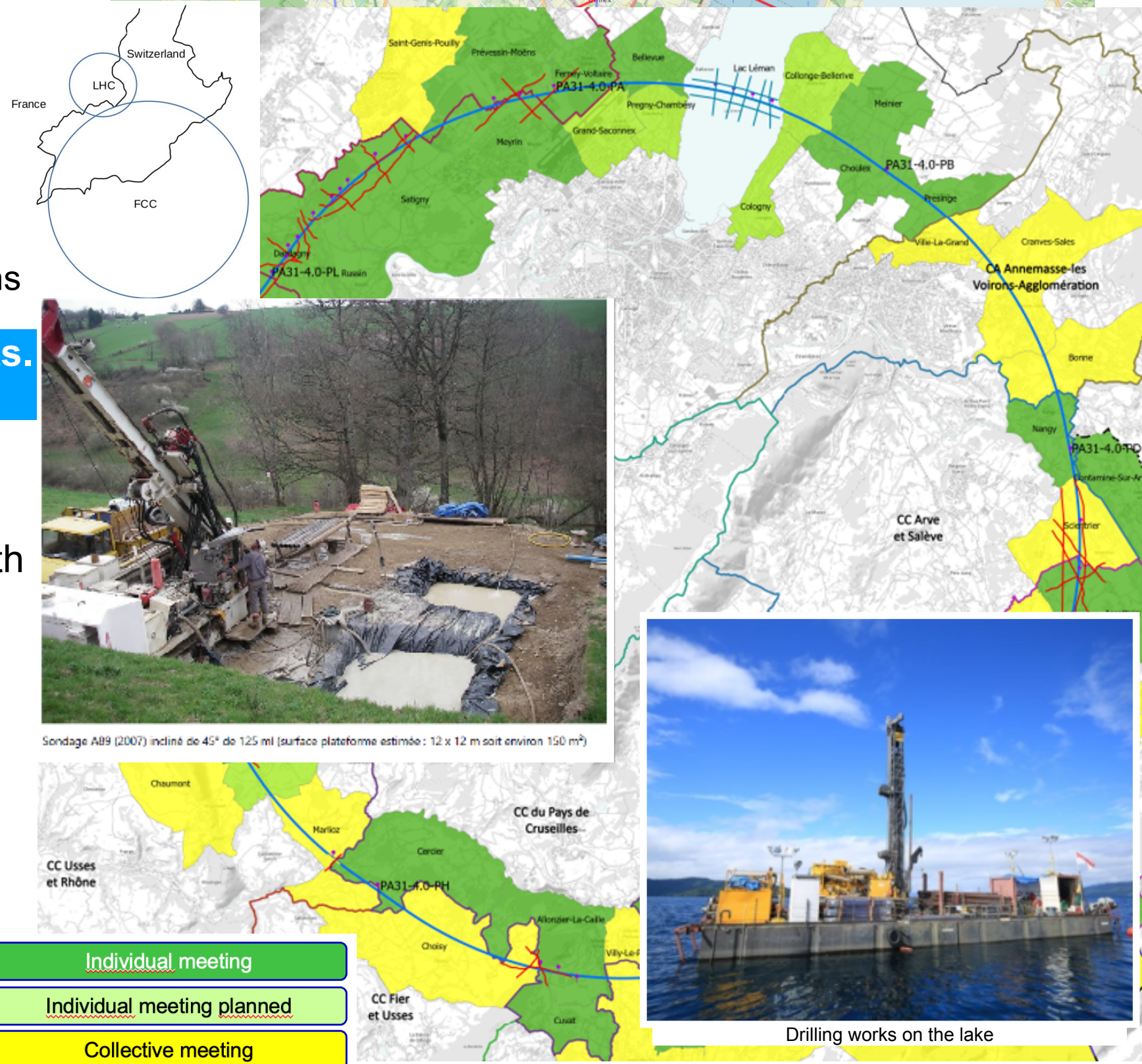

Environmental considerations.

M. Benedikt @ CERN 13.02.24

- **Excavated material** from FCC subsurface infrastructures: 6.5 Mm³ in situ, 8.4 Mm³ excavated
- **Priority : reuse, minimize disposal**
- 2021-2022: International competition “**Mining the Future**”, launched with the support of the EU Horizon 2020 grant, to find innovative and realistic ideas for the reuse of molasse (96% of excavated materials)
- 2023: “**OpenSky Laboratory**” project: Objective - Develop and test an innovative process to transform sterile “molasse” into fertile soil for agricultural use and afforestation. launched in Jan. 2024: 5500m² near LHC P5 in Cessy (FR). Trial with 5 000t of excavated local molasse → convert it to arable soil (agricultural/forestry)
- **Heat:**
 - heating for local houses
 - cheese factories in Jura and Haute-Savoie expressed special interest

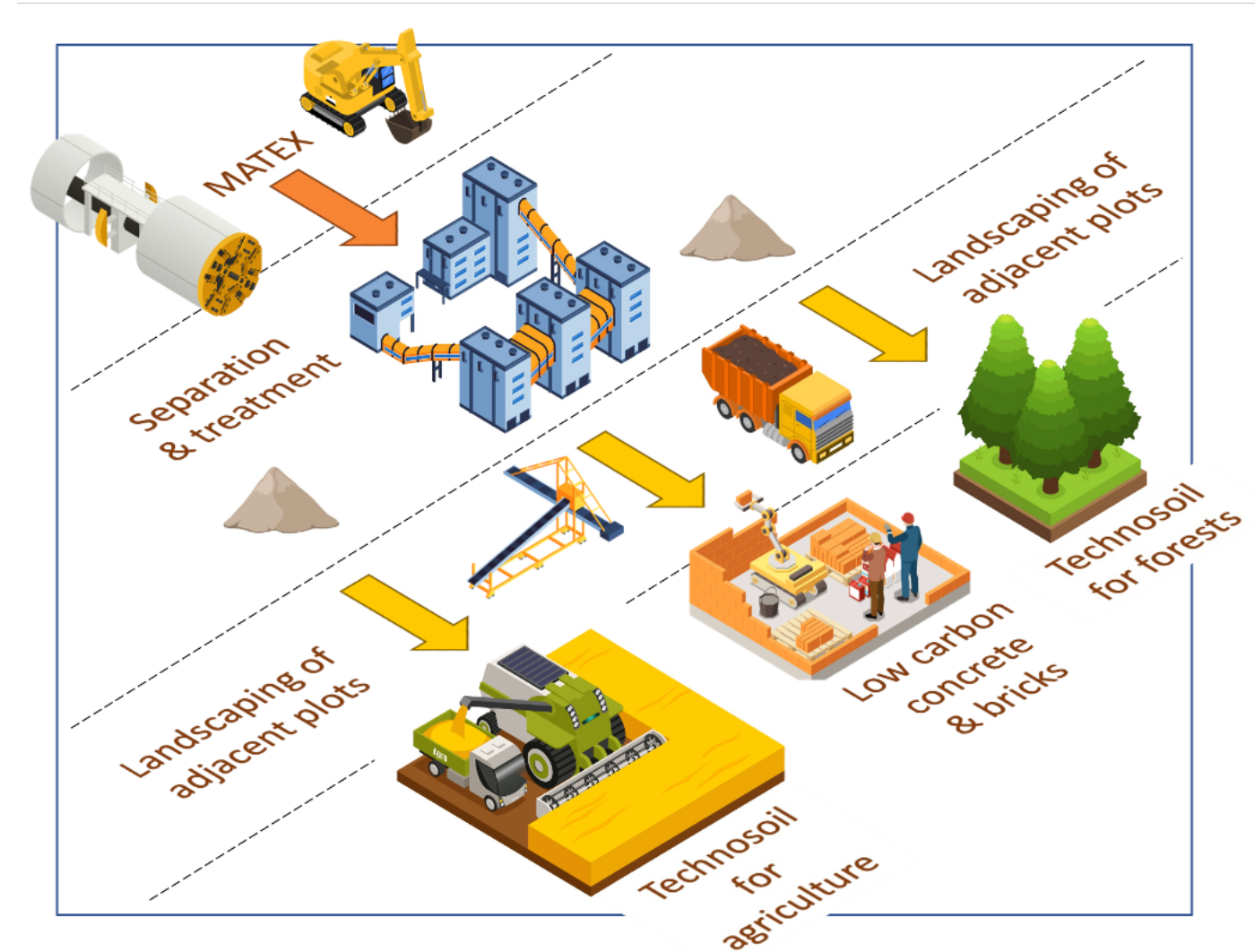

Accelerated soil transformation with funghi

Connections with local infrastructure.

M. Benedikt @ CERN 13.02.24

- **Road accesses** developed for all 8 surface sites
 - ▶ Four possible highway connections defined
 - ▶ Less than 4 km new departmental roads required

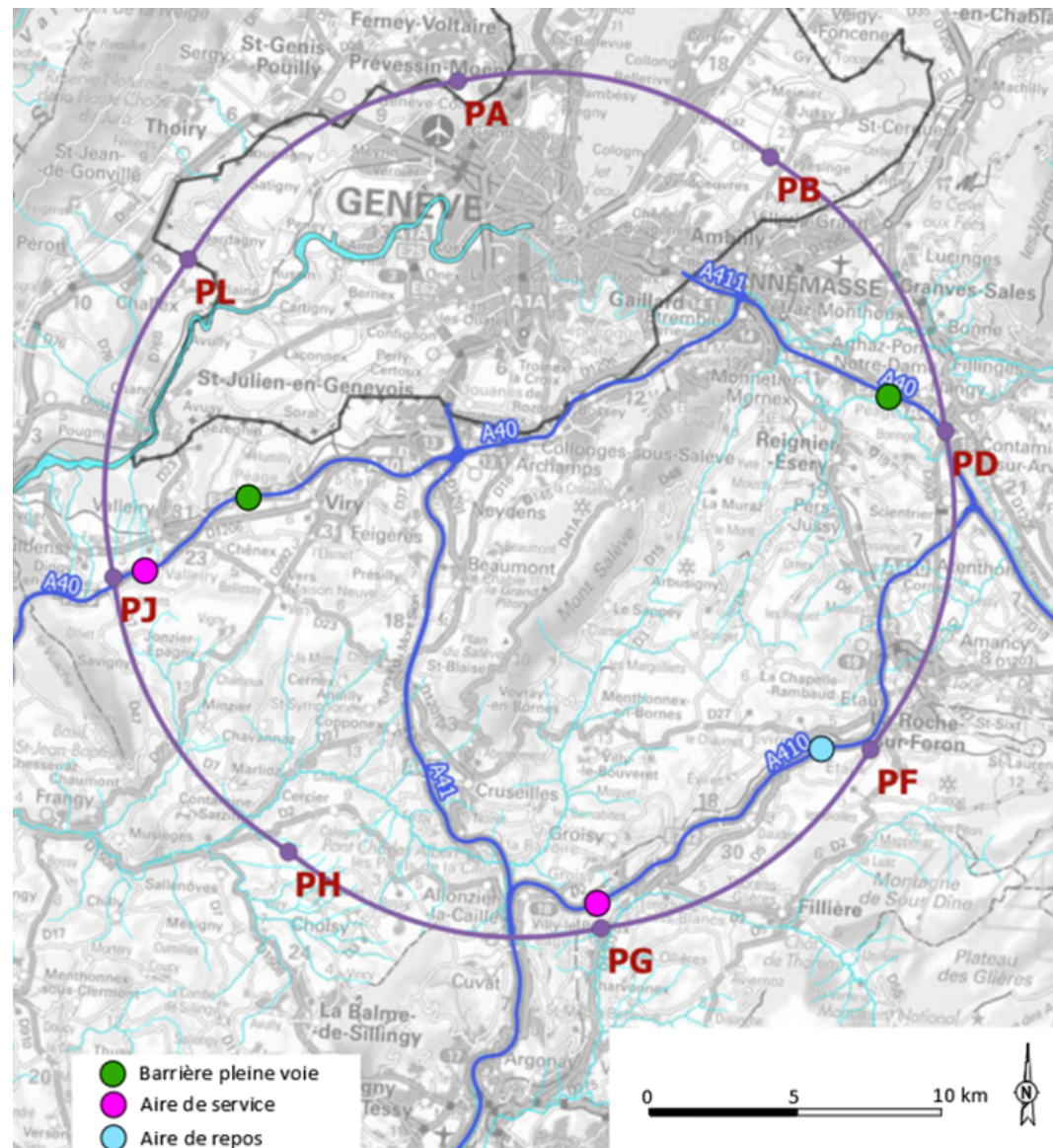

- **Connections to electrical grid**

- ▶ Electrical connection concept studied by RTE (French electrical grid operator) → requested loads have no significant impact on grid

- ▶ Powering concept and power rating of the three sub-stations compatible with FCC-hh

- ▶ R&D efforts aiming at further reduction of the energy consumption of FCC-ee and FCC-hh

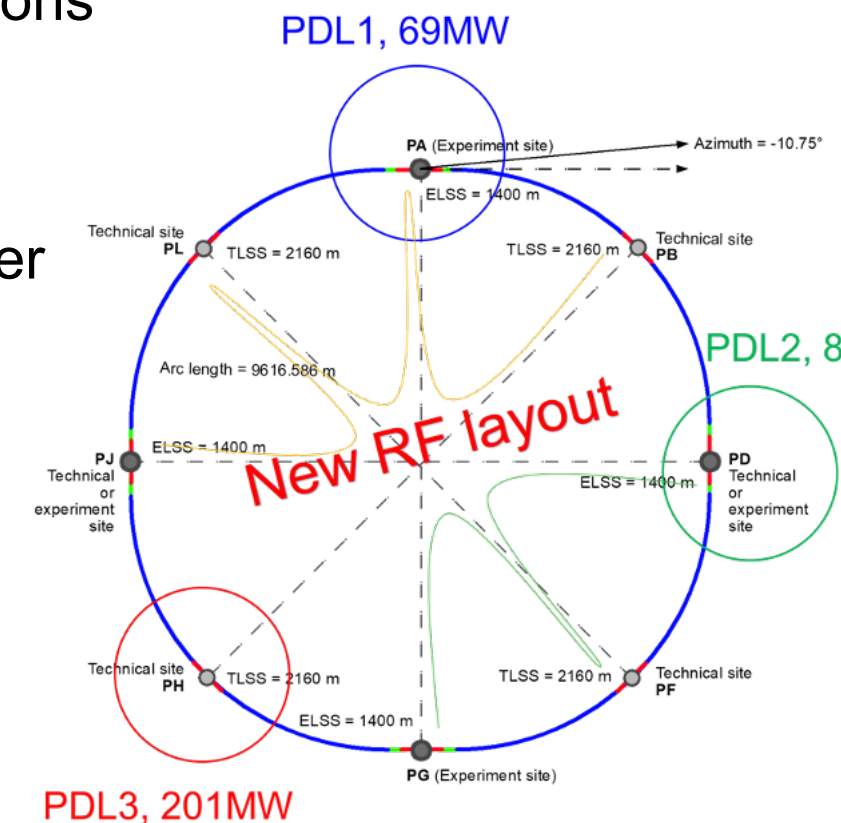

Civil engineering

T. Watson @ Anecy FCC Physics '24

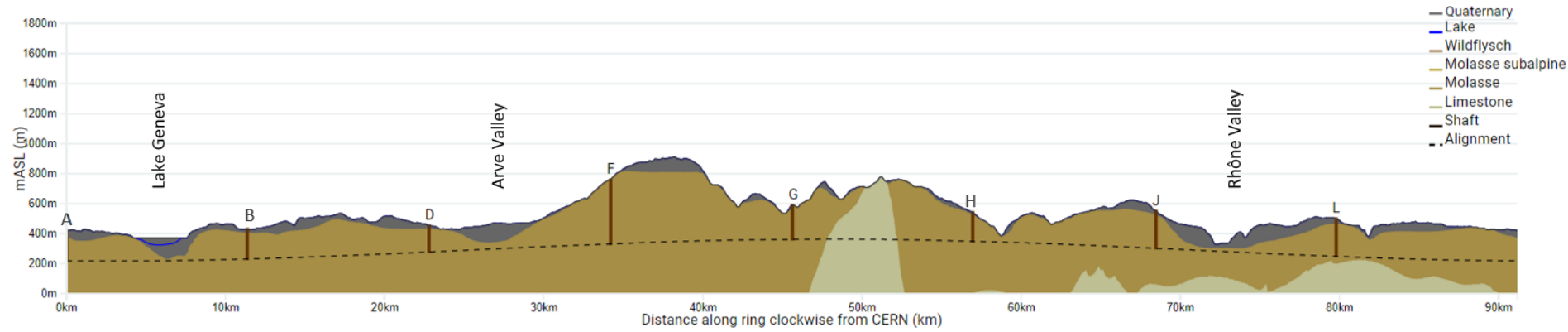

Shaft depths:

A: 201 m B: 201 m D: 181 m F: 400 m G: 226 m H: 235 m J: 253 m L: 250 m



Tunnel Boring Machine (TBM)

- Tunnel Boring Machines are designed to work almost continuously 24/7 other than periodic maintenance. Rate of 18m/day in the Molasse. 21-27 months to complete one sector → 8 years with two TBMs .
- 13 shafts
- 2/2 large/small caverns

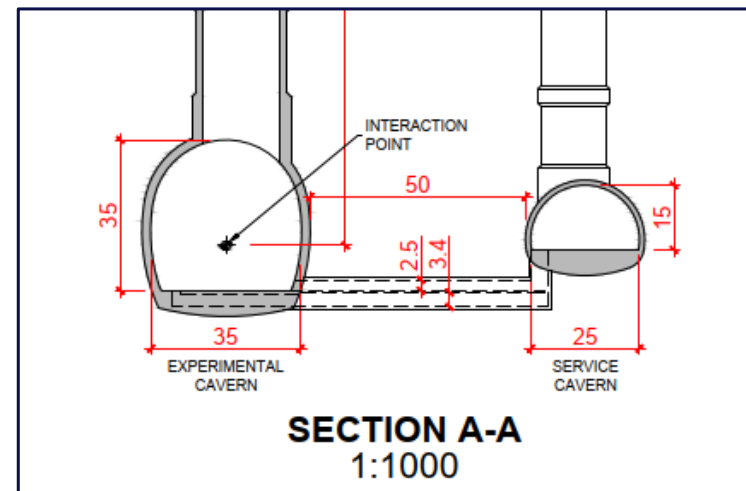

large cavern complex

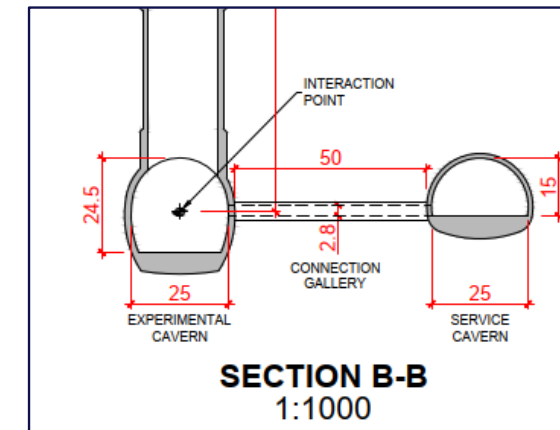

small cavern complex

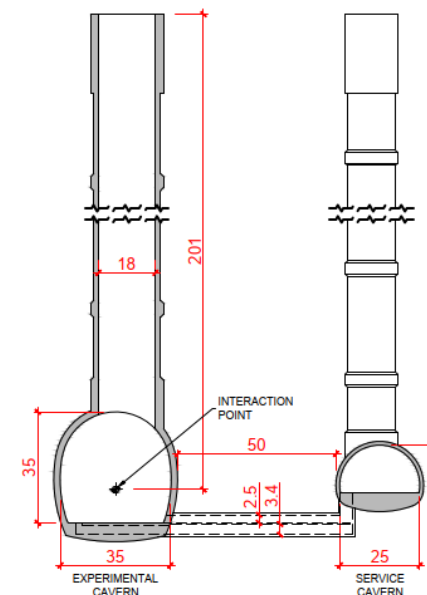

shaft @ exp. site

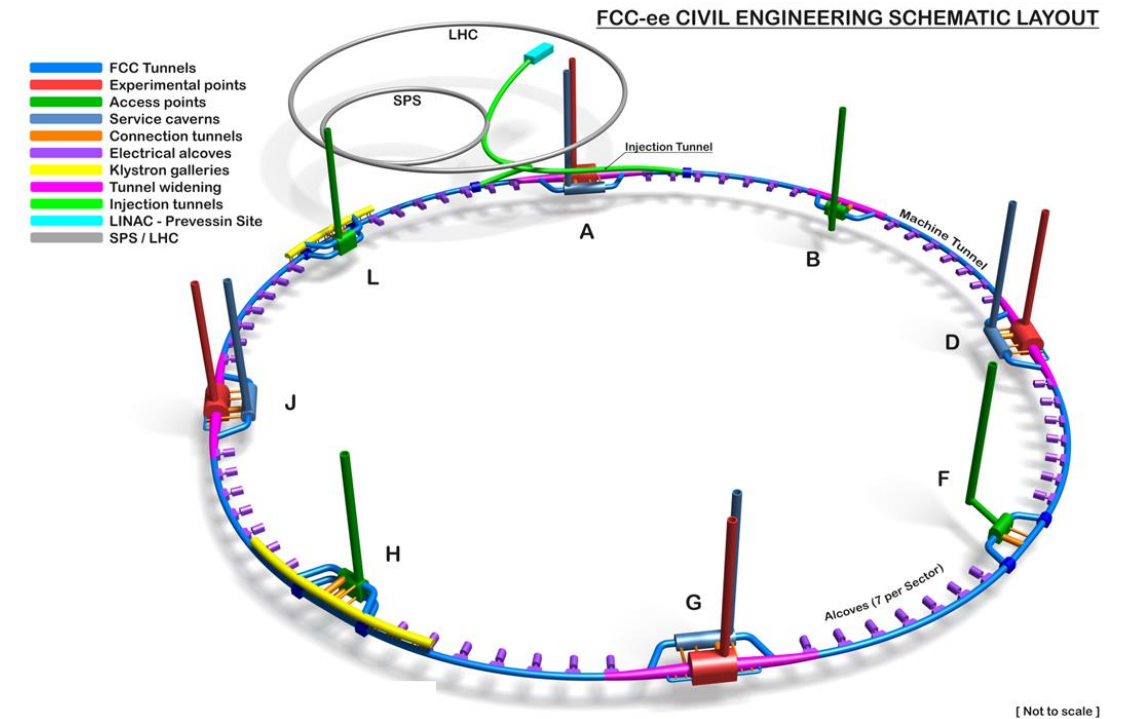

[Not to scale]

Civil engineering

T. Watson @ Anecy FCC Physics '24

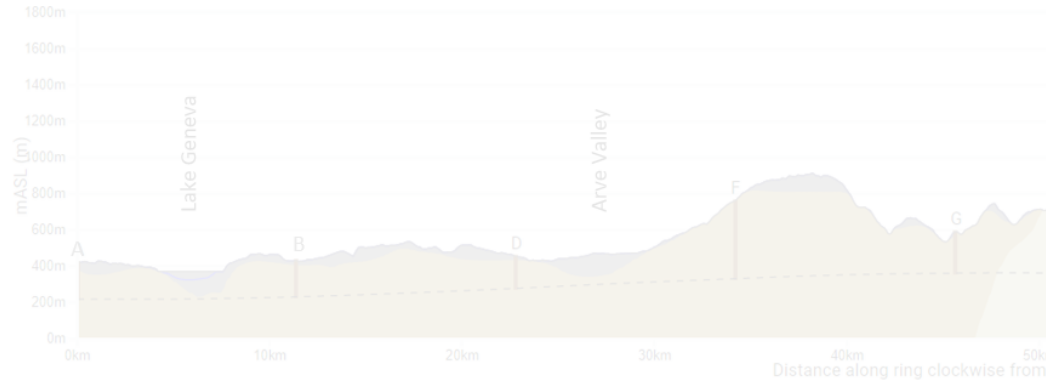

Shaft depths:

A: 201 m B: 201 m D: 181 m F: 400 m G: 226 m

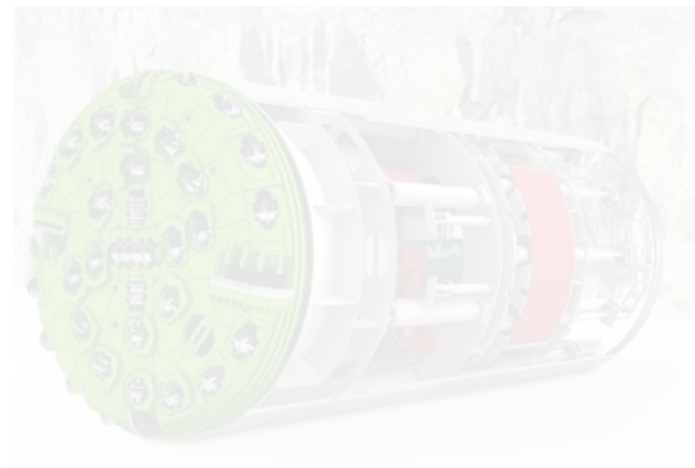

Tunnel Boring Machine (TBM)

- Tunnel other the months
- 13 shaft
- 2/2 larg

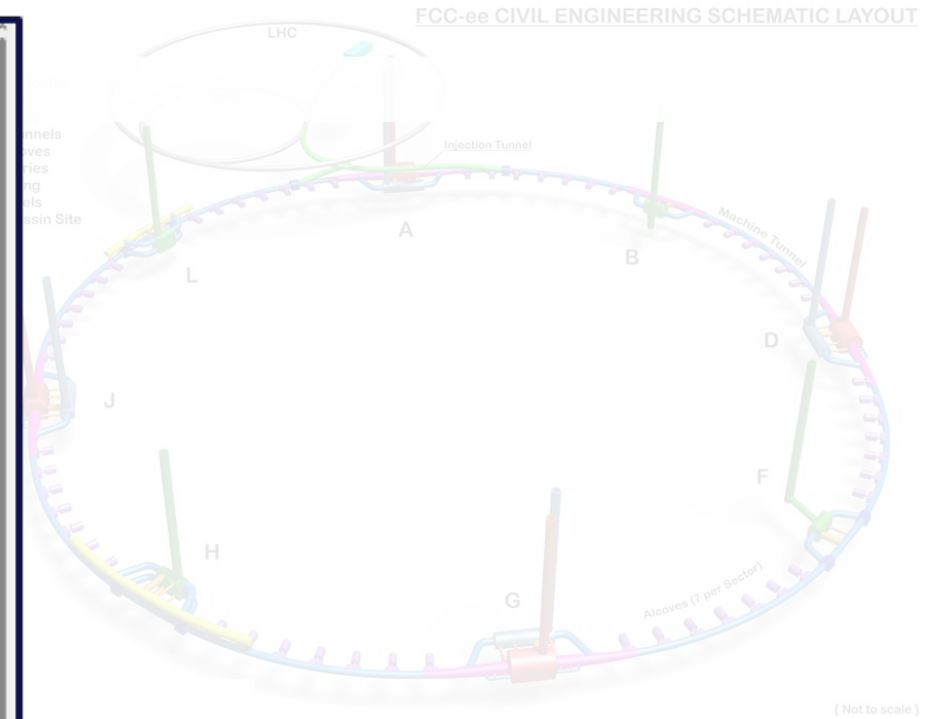
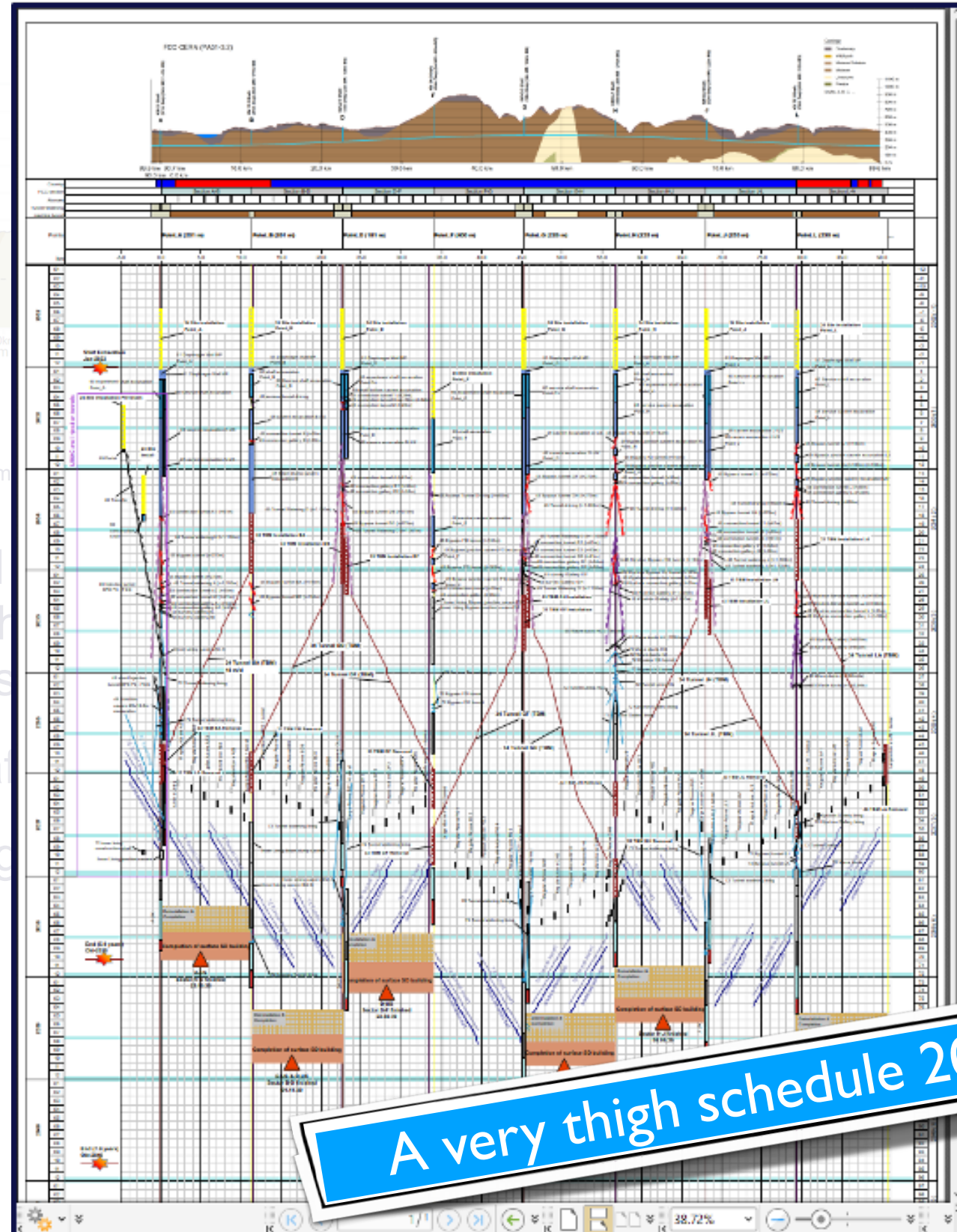

...t continuously 24/7
the Molasse. 21-27
BMs .

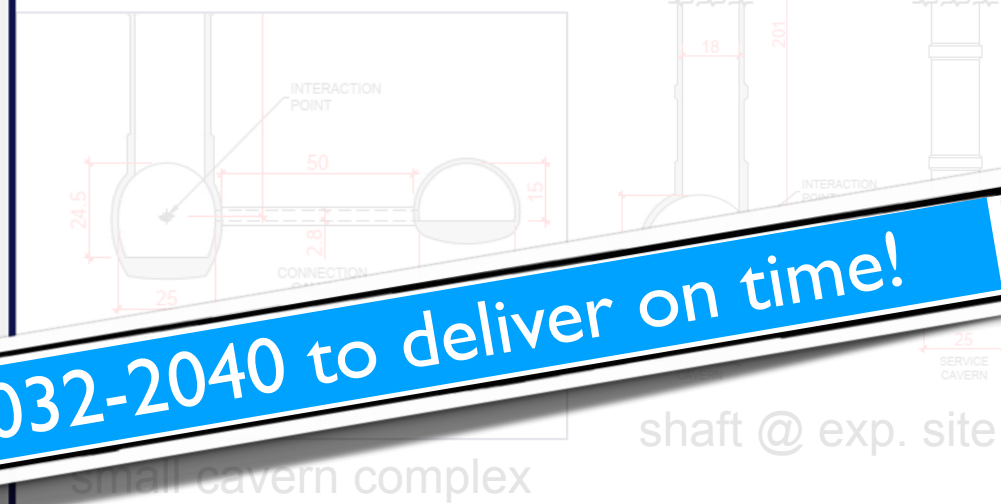

A very thigh schedule 2032-2040 to deliver on time!

Higgs and EW measurements

Experimental Inputs.

A circular ee Higgs factory starts as a Z/EW factory (**TeraZ**)

A linear ee Higgs factory operating above Z-pole can also preform EW measurements via **Z-radiative** return

A linear ee Higgs factory could also operate on the Z-pole though at lower lumi (**GigaZ**)

	Higgs	aTGC	EWPO	Top EW
FCC-ee	Yes (μ, σ_{ZH}) (Complete with HL-LHC)	Yes (aTGC dom.) <i>Warning</i>	Yes	Yes (365 GeV, Ztt)
ILC	Yes (μ, σ_{ZH}) (Complete with HL-LHC)	Yes (HE limit) <i>Warning</i>	LEP/SLD (Z-pole) + HL-LHC + W (ILC)	Yes (500 GeV, Ztt)
CEPC	Yes (μ, σ_{ZH}) (Complete with HL-LHC)	Yes (aTGC dom) <i>Warning</i>	Yes	No
CLIC	Yes (μ, σ_{ZH})	Yes (Full EFT parameterization)	LEP/SLD (Z-pole) + HL-LHC + W (CLIC)	Yes
HE-LHC	Extrapolated from HL-LHC	N/A → LEP2	LEP/SLD + HL-LHC ($M_W, \sin^2\theta_w$)	-
FCC-hh	Yes ($\mu, BR_i/BR_j$) Used in combination with FCCee/eh	From FCC-ee	From FCC-ee	-
LHeC	Yes (μ)	N/A → LEP2	LEP/SLD + HL-LHC ($M_W, \sin^2\theta_w$)	-
FCC-eh	Yes (μ) Used in combination with FCCee/hh	From FCC-ee	From FCC-ee + Zuu, Zdd	-

Observable	present value	±	error	FCC-ee Stat.	FCC-ee Syst.	Comment and leading error
m_Z (keV)	91186700	±	2200	4	100	From Z line shape scan Beam energy calibration
Γ_Z (keV)	2495200	±	2300	4	25	From Z line shape scan Beam energy calibration
$\sin^2 \theta_W^{\text{eff}} (\times 10^6)$	231480	±	160	2	2.4	From $A_{\text{FB}}^{\mu\mu}$ at Z peak Beam energy calibration
$1/\alpha_{\text{QED}}(m_Z^2)(\times 10^3)$	128952	±	14	3	small	From $A_{\text{FB}}^{\mu\mu}$ off peak QED&EW errors dominate
$R_\ell^Z (\times 10^3)$	20767	±	25	0.06	0.2-1	Ratio of hadrons to leptons Acceptance for leptons
$\alpha_s(m_Z^2) (\times 10^4)$	1196	±	30	0.1	0.4-1.6	From R_ℓ^Z
$\sigma_{\text{had}}^0 (\times 10^3)$ (nb)	41541	±	37	0.1	4	Peak hadronic cross-section Luminosity measurement
$N_\nu (\times 10^3)$	2996	±	7	0.005	1	Z peak cross-sections Luminosity measurement
$R_b (\times 10^6)$	216290	±	660	0.3	< 60	Ratio of $b\bar{b}$ to hadrons Stat. extrapol. from SLD
$A_{\text{FB},0}^b (\times 10^4)$	992	±	16	0.02	1-3	b-quark asymmetry at Z pole From jet charge
$A_{\text{FB}}^{\text{pol},\tau} (\times 10^4)$	1498	±	49	0.15	< 2	τ polarization asymmetry τ decay physics
τ lifetime (fs)	290.3	±	0.5	0.001	0.04	Radial alignment
τ mass (MeV)	1776.86	±	0.12	0.004	0.04	Momentum scale
τ leptonic ($\mu\nu_\mu\nu_\tau$) B.R. (%)	17.38	±	0.04	0.0001	0.003	e/μ /hadron separation
m_W (MeV)	80350	±	15	0.25	0.3	From WW threshold scan Beam energy calibration
Γ_W (MeV)	2085	±	42	1.2	0.3	From WW threshold scan Beam energy calibration
$\alpha_s(m_W^2)(\times 10^4)$	1010	±	270	3	small	From R_ℓ^W
$N_\nu (\times 10^3)$	2920	±	50	0.8	small	Ratio of invis. to leptonic in radiative Z returns
m_{top} (MeV)	172740	±	500	17	small	From $t\bar{t}$ threshold scan QCD errors dominate
Γ_{top} (MeV)	1410	±	190	45	small	From $t\bar{t}$ threshold scan QCD errors dominate
$\lambda_{\text{top}}/\lambda_{\text{top}}^{\text{SM}}$	1.2	±	0.3	0.10	small	From $t\bar{t}$ threshold scan QCD errors dominate
ttZ couplings		±	30%	0.5 – 1.5 %	small	From $\sqrt{s} = 365$ GeV run

EW Precision Measurements at FCC-ee

Experimental (statistical and systematic) precision of a selection of measurements accessible at FCC-ee, compared with the present world-average precision. FCC-ee syst. scaled down from LEP estimates. Room for improvement with dedicated studies. Note that syst. go down also with stat. (e.g. beam energy determination from $ee \rightarrow Z/\gamma$ thus goes down with luminosity).

Table from mid-term report

Improvements of EW measurements

Exquisite measurements of m_Z (100 keV), Γ_Z (25 keV), m_W (<500 keV), $\alpha_{\text{QED}}(m_Z)$ ($3 \cdot 10^{-5}$) (all unique to FCC-ee)

w/. stat.+ param. + th-exp syst.

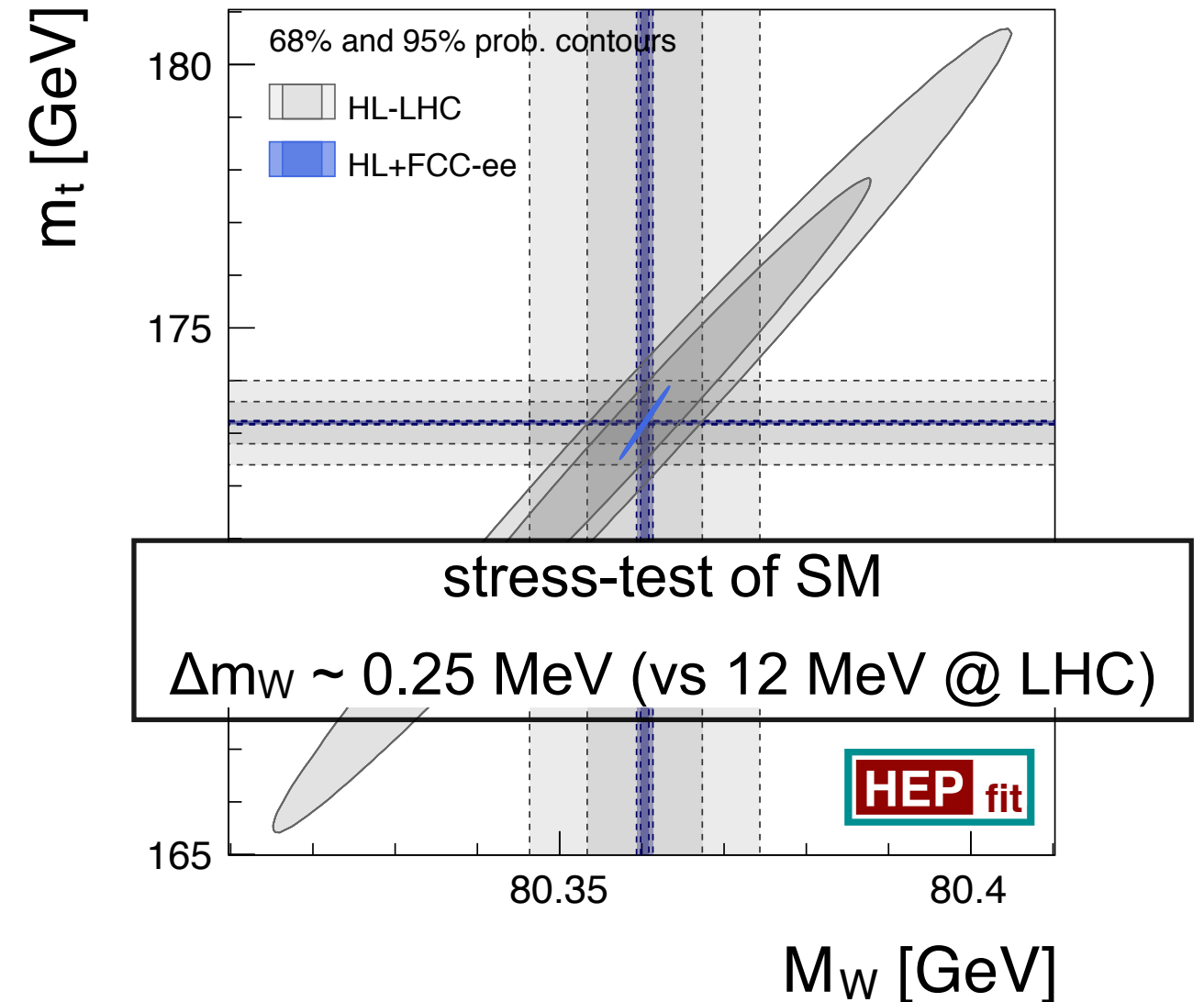
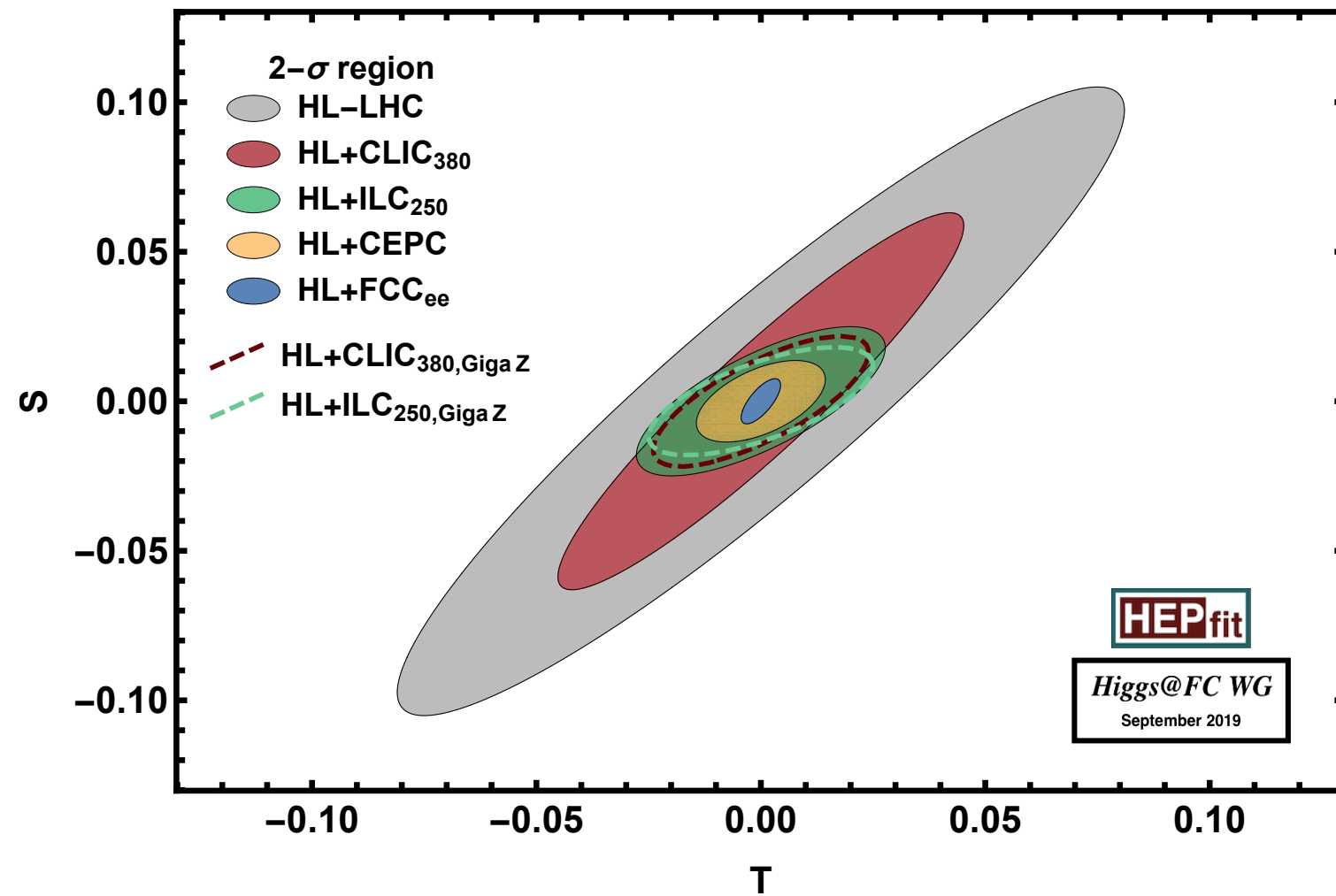

The importance of improved EW measurements is threefold:

- 1) improve mass reach in indirect search for NP ($S \sim 10^{-2} \rightarrow M \sim 70$ TeV)
- 2) reduced parametric uncertainties for other measurements
- 3) reduced degeneracies in a global fit for Higgs couplings

Improvements of EW measurements

Exquisite measurements of m_Z (100 keV), Γ_Z (25 keV), m_W (<500 keV), $\alpha_{\text{QED}}(m_Z)$ ($3 \cdot 10^{-5}$) (all unique to FCC-ee)

w/ stat. and param. only

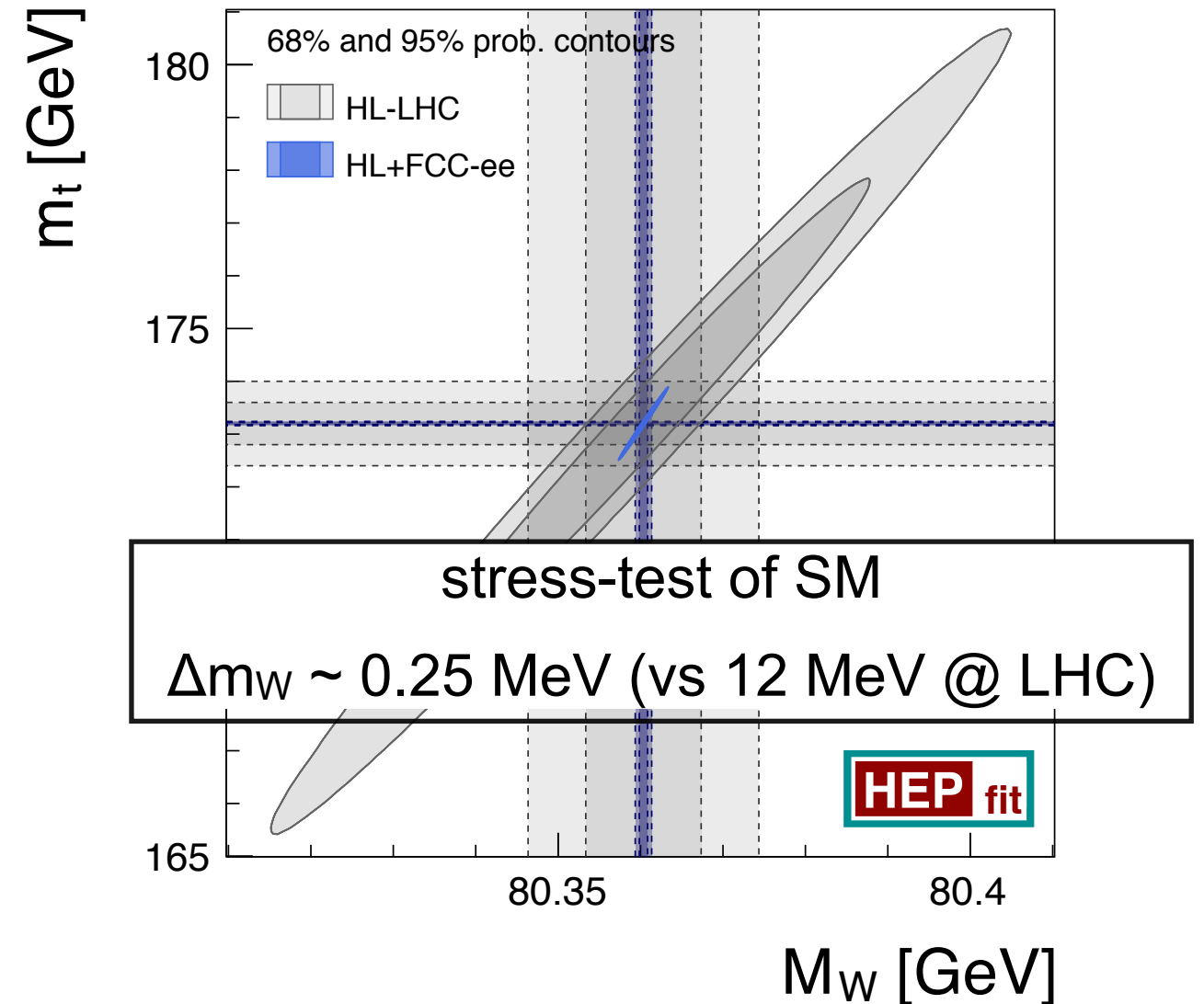
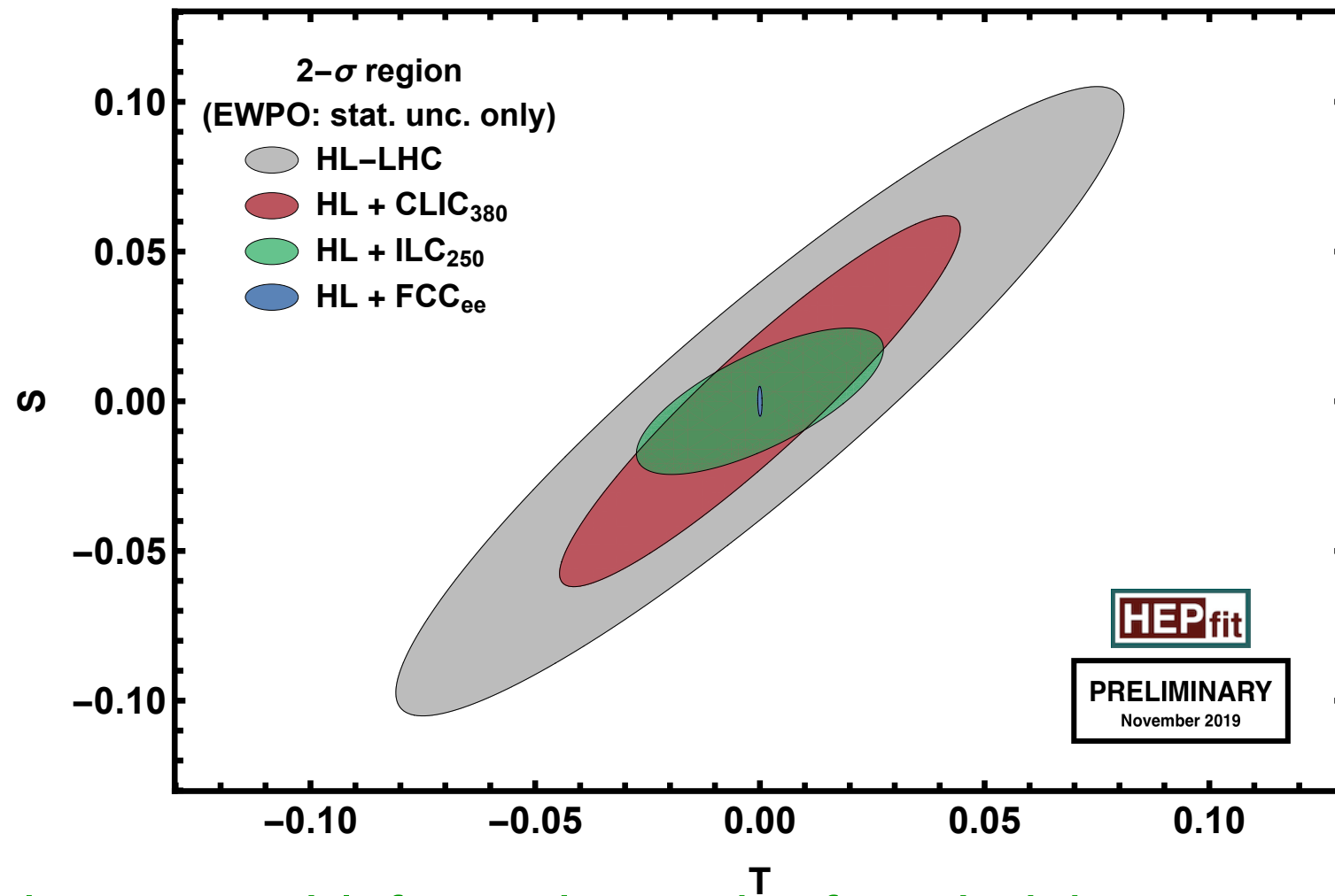

The importance of improved EW measurements is threefold:

- 1) improve mass reach in indirect search for NP ($S \sim 10^{-2} \rightarrow M \sim 70$ TeV)
- 2) reduced parametric uncertainties for other measurements
- 3) reduced degeneracies in a global fit for Higgs couplings

Systematics vs. Statistics.

PED @ CERN-SPC '2022

- We often hear that more Z pole statistics is useless, because they are systematics-limited
 - ◆ This is a passive attitude, which leads to pessimistic expectations and wrong conclusions/planning
 - Experience shows that a careful experimental systematic analysis boils down to a statistical problem
 - If well prepared, theory will go as far as deemed useful : this preparation starts today (and needs SUPPORT)
 - We are working in the spirit of matching systematic errors to expected statistics for all precision measurements

- ◆ Take the Z lineshape



$\alpha_{\text{QED}}(m_Z)$: Stat. 3×10^{-5}
Obtained at FCC-ee from off-peak asymmetries (87.9 & 94.3 GeV): for the first time, it is a direct measurement of this quantity (game changer)

- Enters as a limiting parametric uncertainties in the new physics interpretation many past and future measurements.
- Is statistics limited and will directly benefit from more luminosity
- No useful impact on $\alpha_{\text{QED}}(m_Z)$ with five times less luminosity

$\sin^2\theta_W^{\text{eff}}$ and Γ_Z (also m_W vs m_Z) : Stat. 2×10^{-6} and 4 keV
Error dominated by point-to-point energy uncertainties.
Based on in-situ comparisons between \sqrt{s} (e.g. with muon pairs), with measurements made every few minutes (100's times per day)
Boils down to

- statistics (the more data the better, scales down as $1/\sqrt{L}$)
- detector systematics (uncorrelated between experiments, scales down a $1/\sqrt{N_{\text{experiments}}}$)

- ◆ Most of the work is (will be) on systematics
 - But huge statistics will turn into better precision
→ A real chance for discovery

Z (and W) mass: Stat. 4 keV (250 keV)
Error dominated by \sqrt{s} determination with resonant depolarization.
As more understanding is gained, progress are made at a constant pace, and this error approaches regularly the statistical limit

Impact of TH uncertainties.

J. de Blas, FCC CDR overview '19

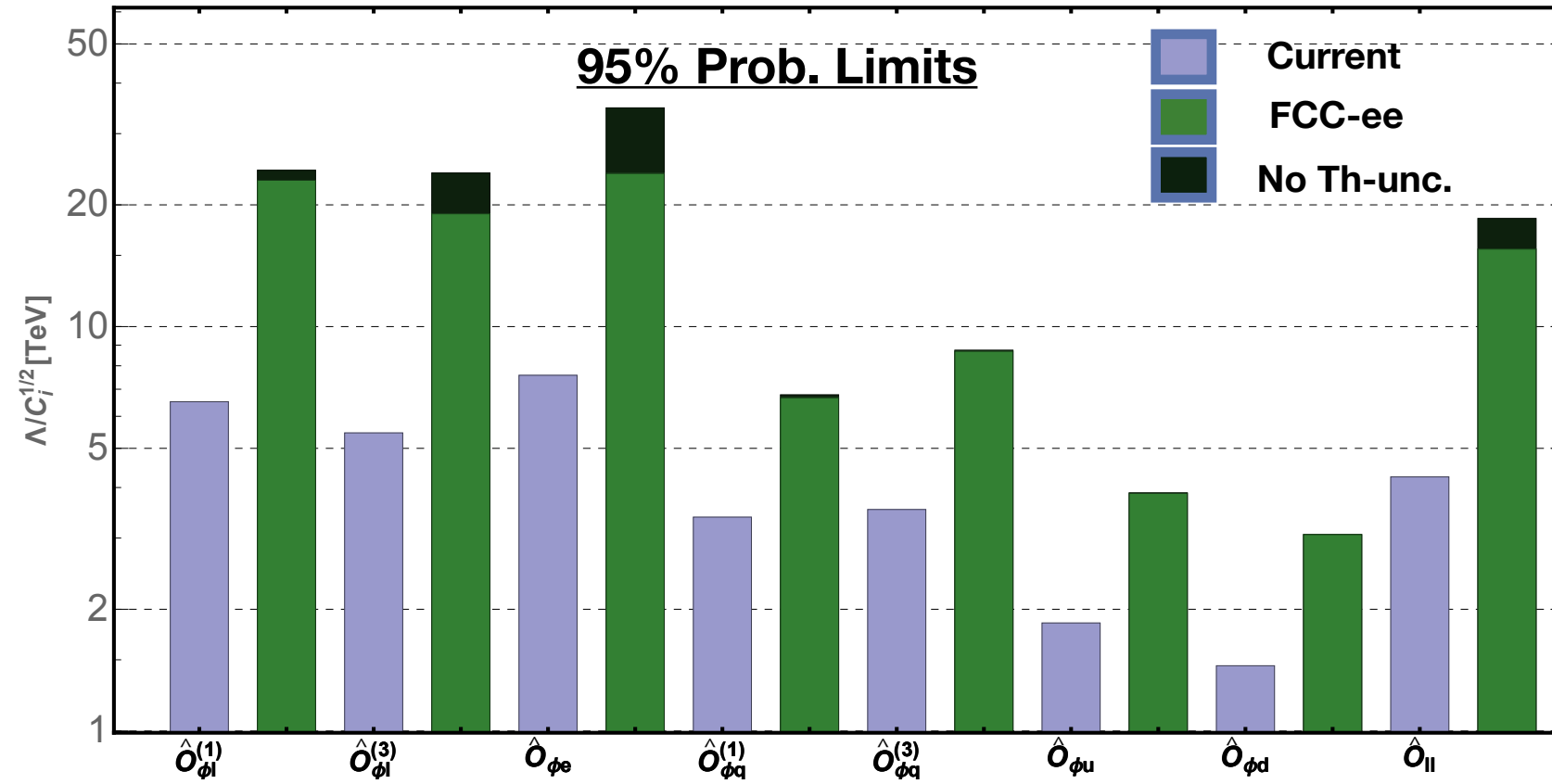

	Current		FCCee		
	Exp.	SM	Exp.	SM (par.)	SM (th.)
δM_W [MeV]	± 15	± 8	± 1	$\pm 0.6/\pm 1$	± 1
$\delta \Gamma_Z$ [MeV]	± 2.3	± 0.73	± 0.1	± 0.1	± 0.2
$\delta \mathcal{A}_\ell$ [$\times 10^{-5}$]	± 210	± 93	± 2.1	$\pm 8/\pm 14$	± 11.8
δR_b^0 [$\times 10^{-5}$]	± 66	± 3	± 6	± 0.3	± 5

Some EW measurements @ Tera

measure $\sigma(e^+e^- \rightarrow \mu^+\mu^-)$ and $A_{FB}^{\mu\mu}$ at (a) judicious \sqrt{s}

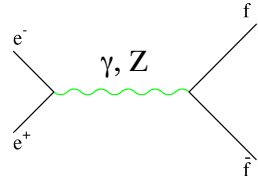

The γ exchange term is proportional to $\alpha_{QED}^2(\sqrt{s})$
 The Z exchange term is proportional to G_F^2 , hence independent of α_{QED}
 The γZ interference is proportional to $\alpha_{QED}(\sqrt{s}) \times G_F$

strongly depends on \sqrt{s}
direct measurement of $\alpha_{QED}(s)$ at $\sqrt{s} \neq m_Z$
 measure $\sin^2\theta_W$ to high precision

Excellent experimental control of off-peak di-muon asymmetry motivates campaign to collect 50-80 ab^{-1} off peak to gain highest sensitivity to Z- γ interference

$$A_{FB}^{\mu\mu}(s) \simeq \frac{3}{4} \mathcal{A}_e \mathcal{A}_\mu \times \left[1 + \frac{8\pi\sqrt{2}\alpha_{QED}(s)}{m_Z^2 G_F (1 - 4\sin^2\theta_W^{eff})^2} \frac{s - m_Z^2}{2s} \right]$$

Allows for clean determination of $\alpha_{QED}(m_Z^2)$, which is a *critical* input for m_W closure tests (see later).

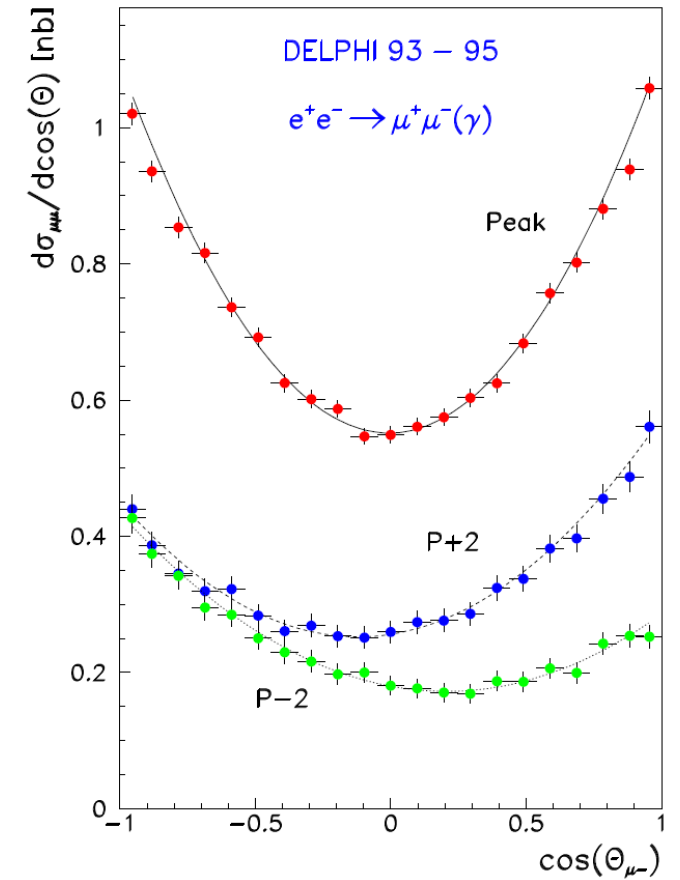

relative α_{QED} uncertainty with 80 ab^{-1}

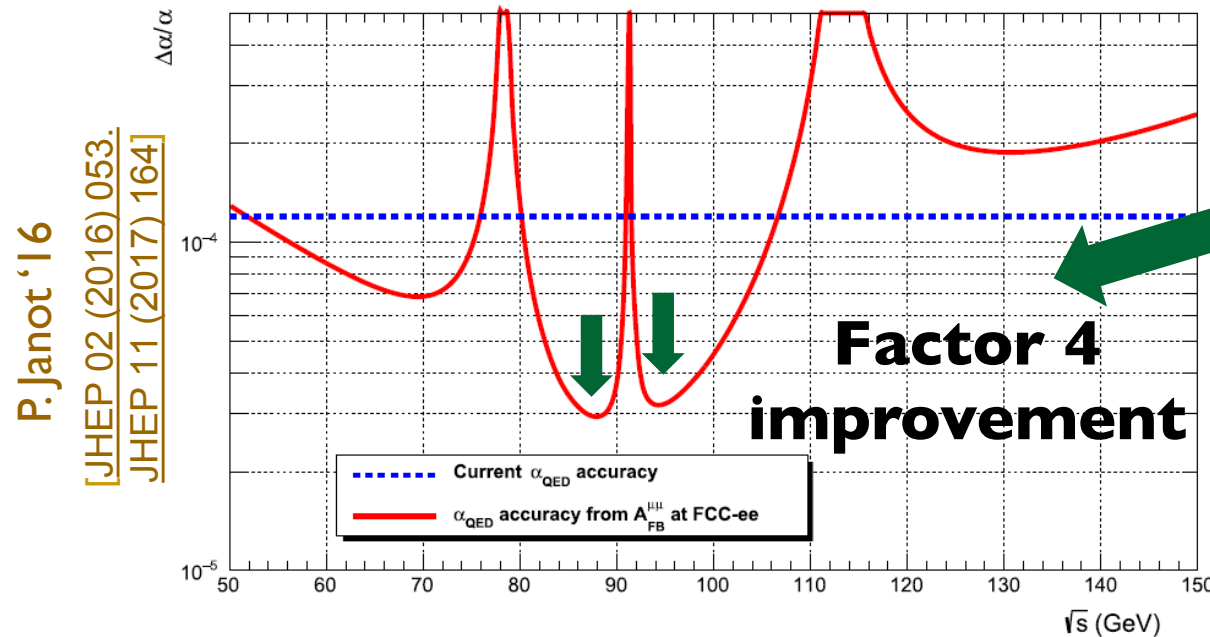

This dependence, & location of half-integer spin tunes, guides the choice of off-peak energies: 87.8 & 93.9 GeV.

- Measure $\alpha_{QED}(m_Z^2)$ to 3×10^{-5} rel. precision (currently 1.1×10^{-4})
- Stat. dominated; syst. uncertainties $< 10^{-5}$ (dominated by \sqrt{s} calib)
- Theoretical uncertainties $\sim 10^{-4}$, higher order calcs needed

P. Janot '16

[JHEP 02 (2016) 053,
 JHEP 11 (2017) 164]

M_w.

- Two independent W mass and width measurements @ FCCee :
 - The m_W and Γ_W determinations from the WW threshold cross section lineshape, with 12/ab at $E_{CM} \simeq 157.5-162.5$ GeV** $\Delta m_W=0.4$ MeV $\Delta \Gamma_W=1$ MeV
 - Other measurements of m_W and Γ_W from the decay products kinematics at $E_{CM} \simeq 162.5-240-365$ GeV** $\Delta m_W, \Delta \Gamma_W= 2-5$ MeV ?

Scans of possible $E_1 E_2$ data taking energies and luminosity fractions f (at the E_2 point)

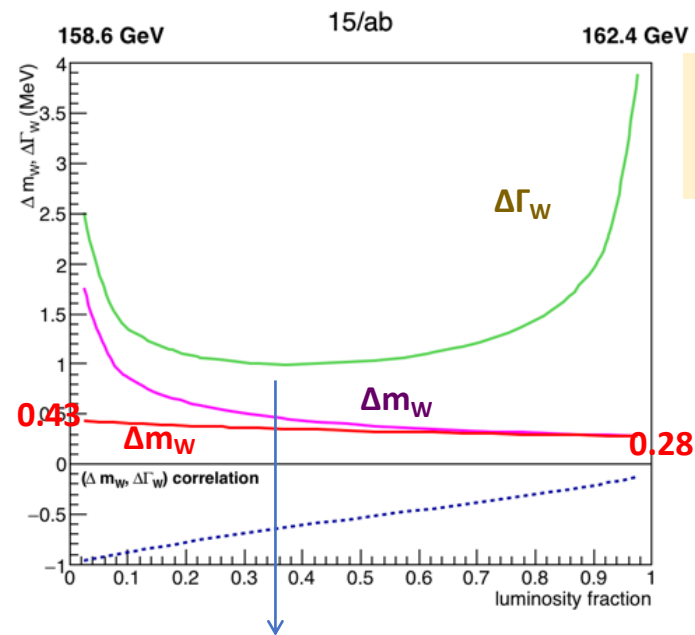

A - minimum of $\Delta \Gamma_W=0.91$ MeV with $\Delta m_W=0.55$ MeV
 taking data at $E_1=156.6$ GeV $E_2=162.4$ GeV $f=0.25$
 yields $\Delta m_W=0.47$ MeV (as single par)

B- minimum of $\Delta m_W=0.28$ MeV $\Delta \Gamma_W=3.3$ MeV with
 $E_1=155.5$ GeV $E_2=162.4$ GeV $f=0.95$
 yields $\Delta m_W=0.28$ MeV (as single par)

C- minimum of $\Delta \Gamma_W=0.96$ MeV + $\Delta m_W=0.41$ MeV with
 $E_1=157.5$ GeV $E_2=162.4$ GeV $f=0.45$
 yields and $\Delta m_W=0.37$ MeV (as single par)

$\Delta m_W=0.45$ MeV, $\Delta \Gamma_W=1$ MeV ($r=-0.6$)
 $\Delta m_W=0.35$ MeV

$\Delta m_W, \Delta \Gamma_W$: error on W mass and width from fitting both
 Δm_W : error on W mass from fitting only m_W

Sensitivity on EW couplings.

J. De Blas, G. Durieux, C. Grojean, J. Gu, A. Paul 1907.04311

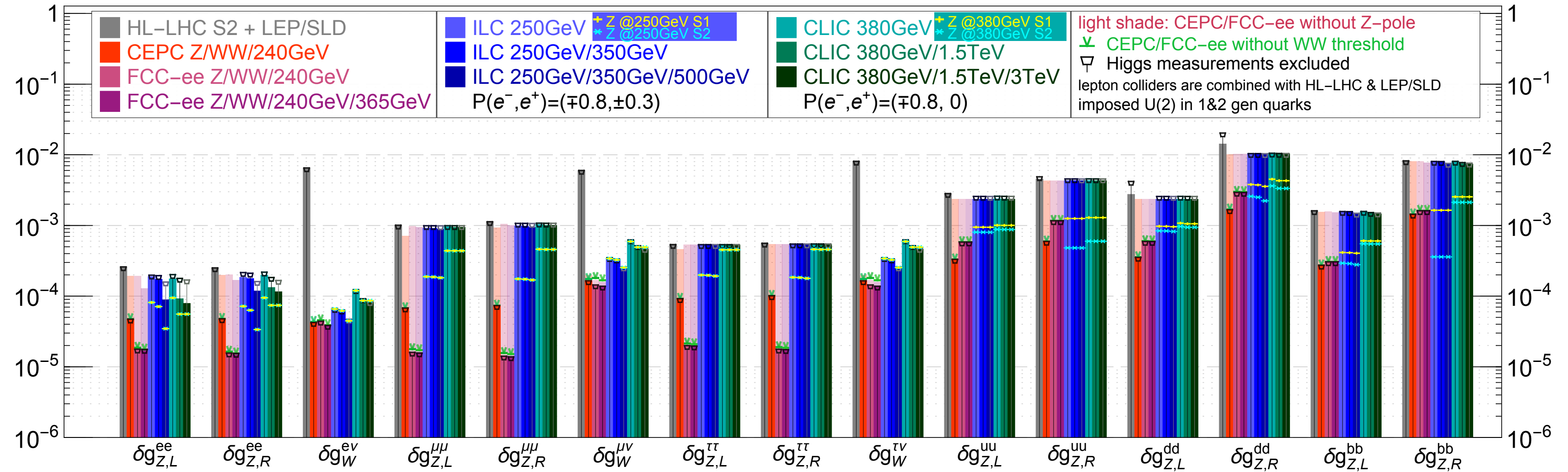

Sensitivity on EW couplings.

J. De Blas, G. Durieux, C. Grojean, J. Gu, A. Paul 1907.04311

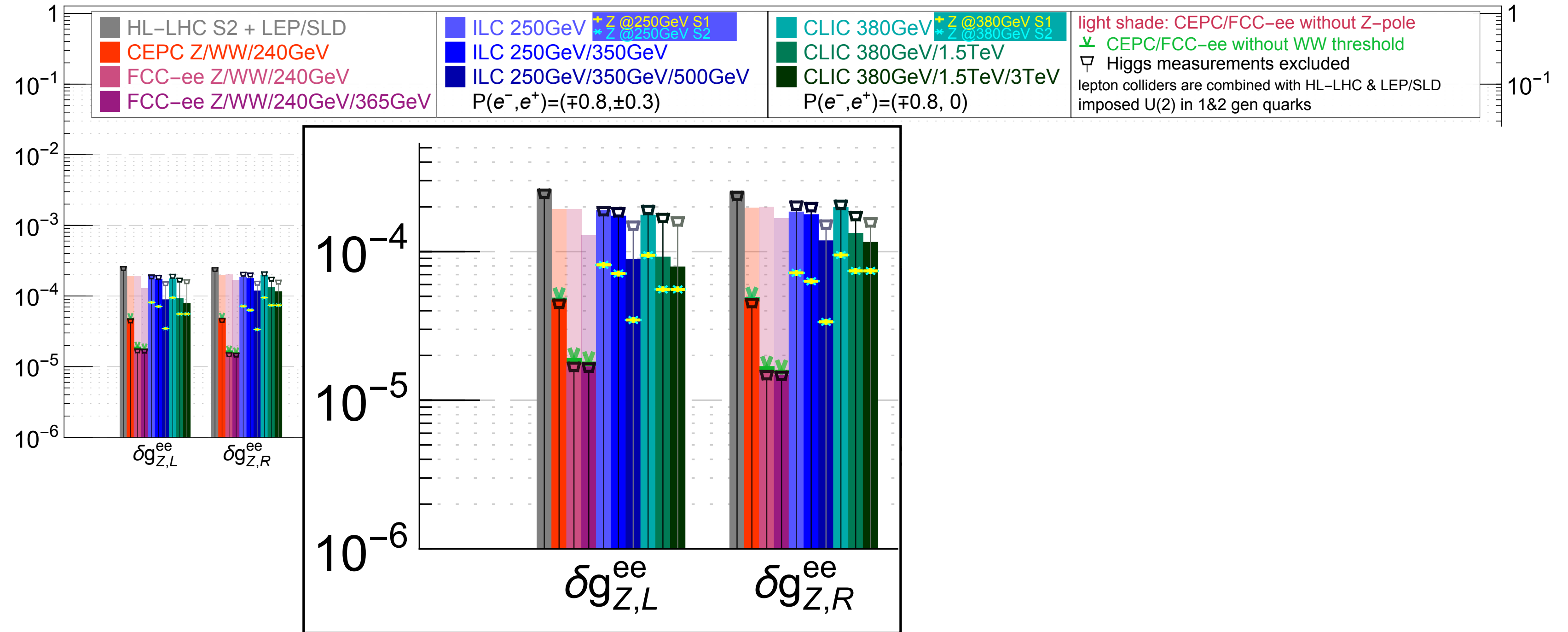

Sensitivity on EW couplings.

J. De Blas, G. Durieux, C. Grojean, J. Gu, A. Paul 1907.04311

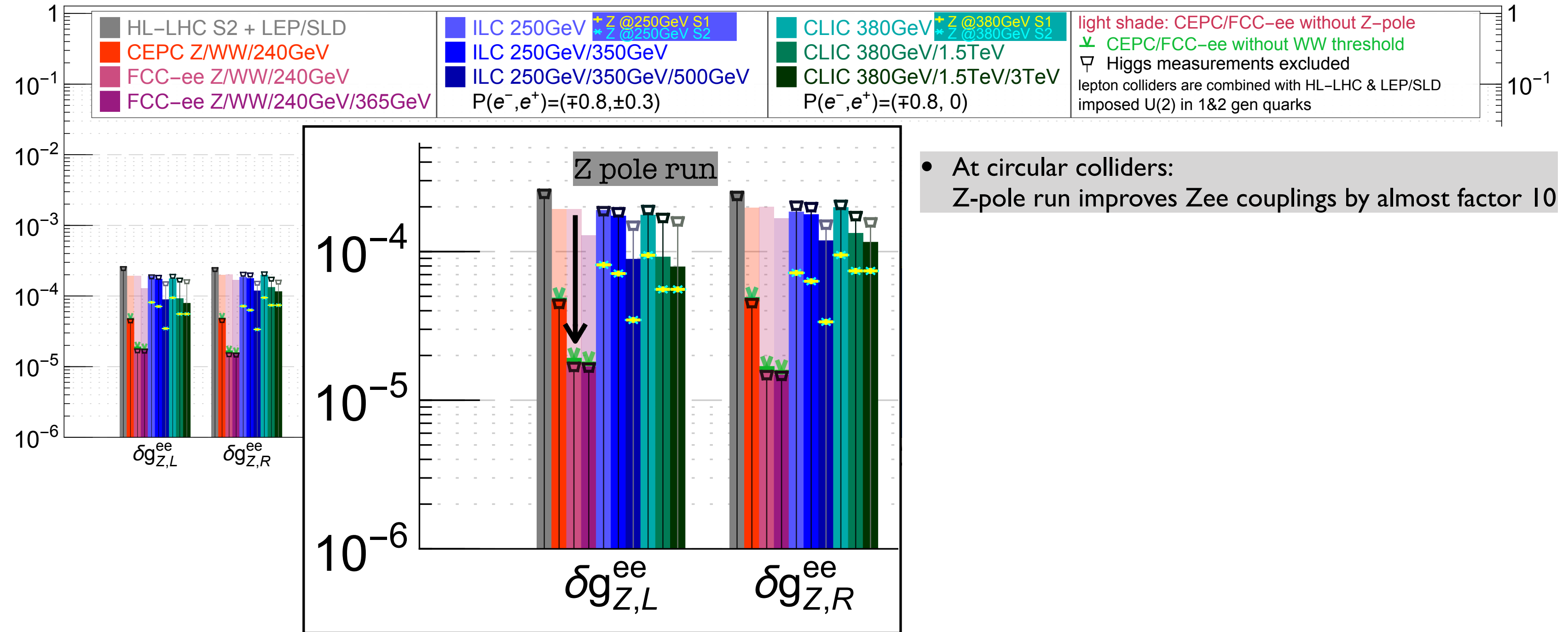

Sensitivity on EW couplings.

J. De Blas, G. Durieux, C. Grojean, J. Gu, A. Paul 1907.04311

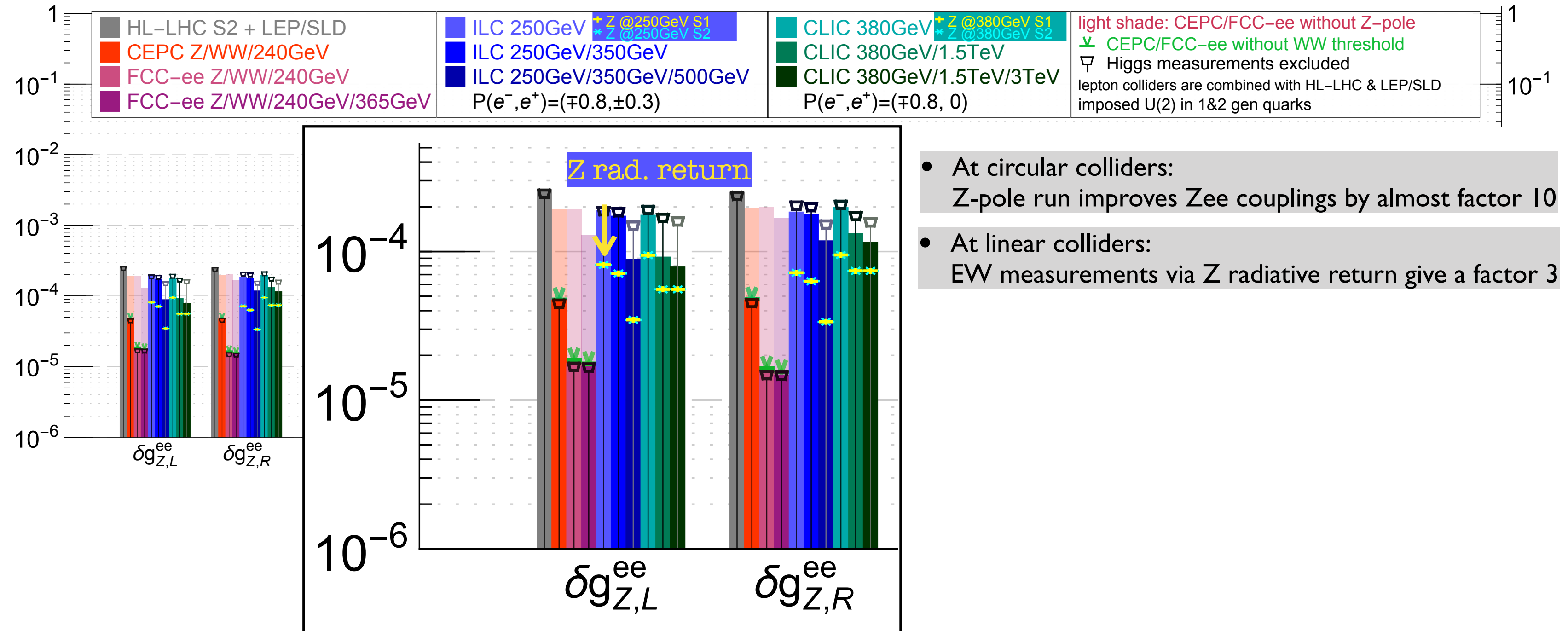

Sensitivity on EW couplings.

J. De Blas, G. Durieux, C. Grojean, J. Gu, A. Paul 1907.04311

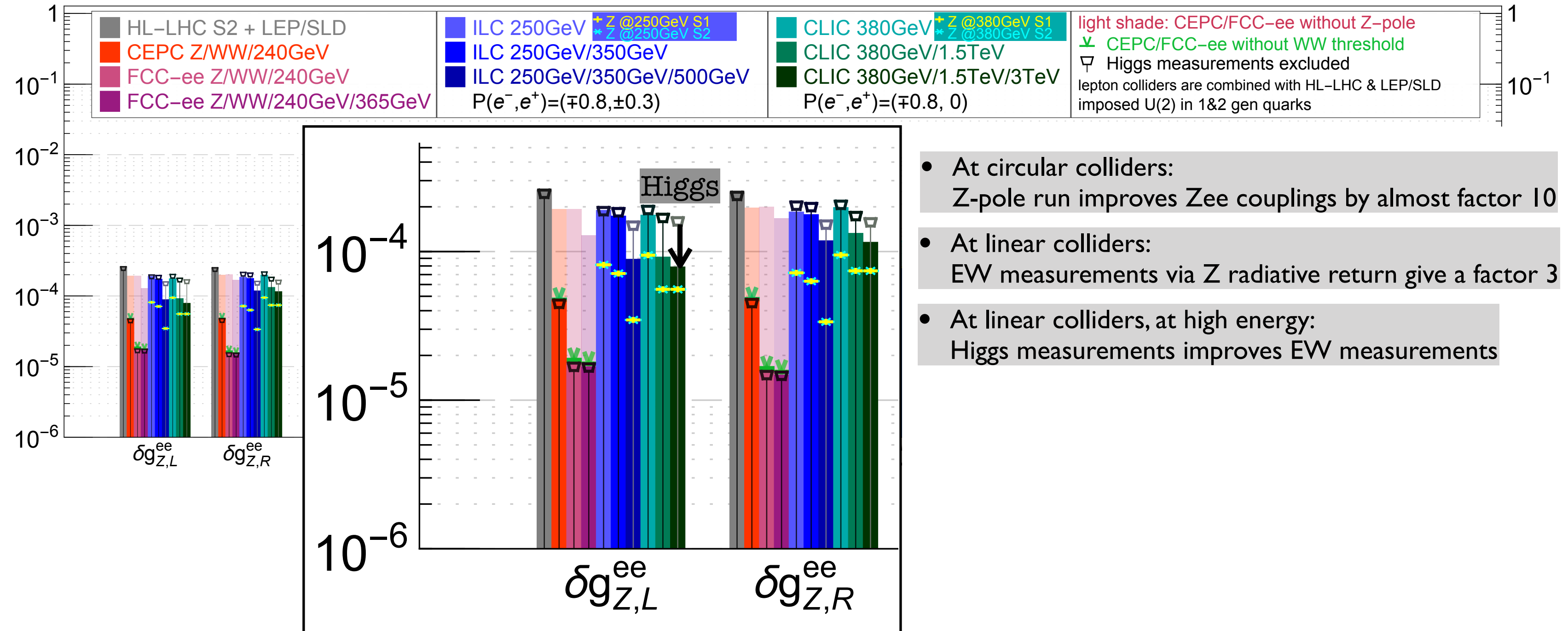

- At circular colliders:
Z-pole run improves Zee couplings by almost factor 10
- At linear colliders:
EW measurements via Z radiative return give a factor 3
- At linear colliders, at high energy:
Higgs measurements improves EW measurements

Sensitivity on EW couplings.

J. De Blas, G. Durieux, C. Grojean, J. Gu, A. Paul 1907.04311

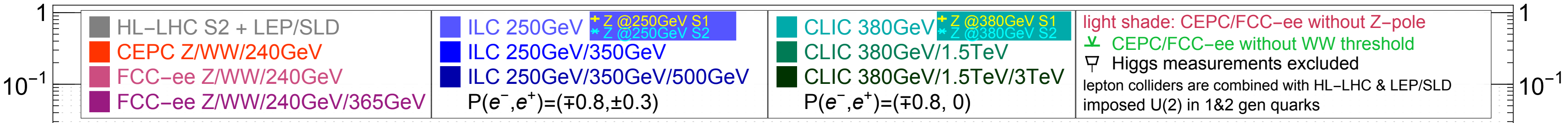

- At linear colliders, at high energy: EW measurements via Z-radiative return has a large impact on $Zq\bar{q}$ couplings
- Improvements depend a lot on hypothesis on systematic uncertainties
 - Yellow: LEP/SLD systematics / 2
 - Blue: small EXP and TH systematics

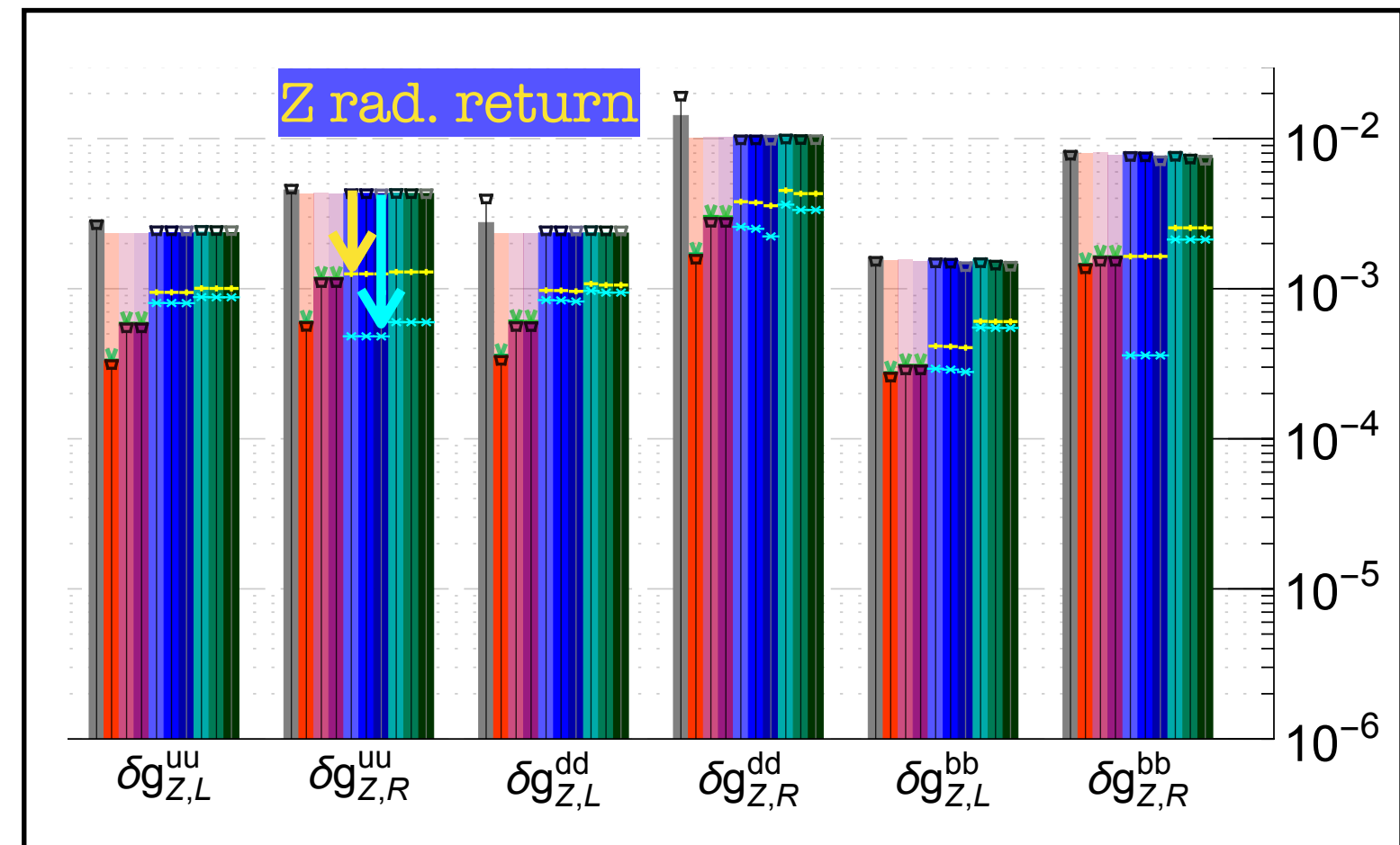

Why Z-pole for Higgs?

J. De Blas et al. 1907.04311

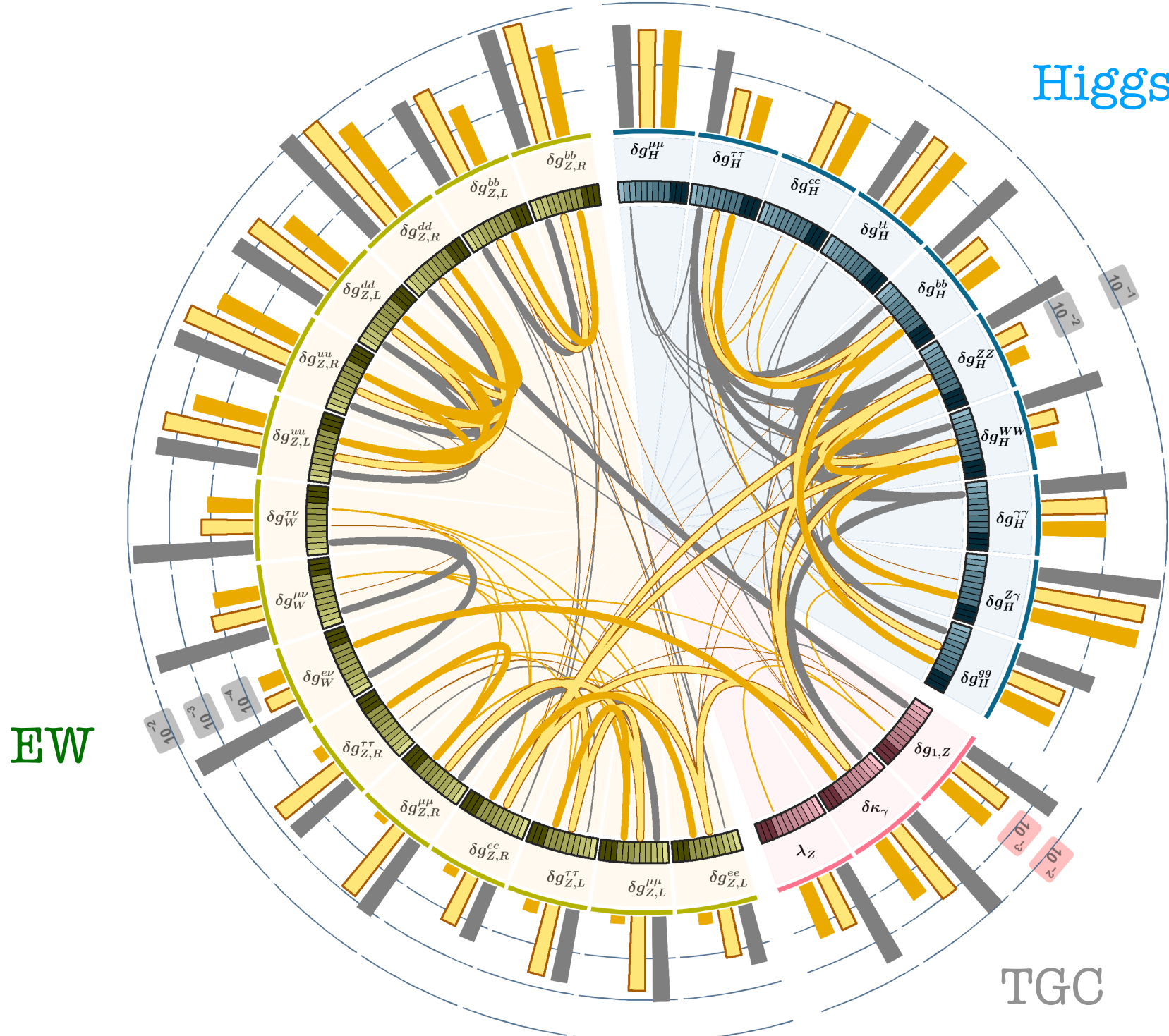

EW

Higgs

TGC

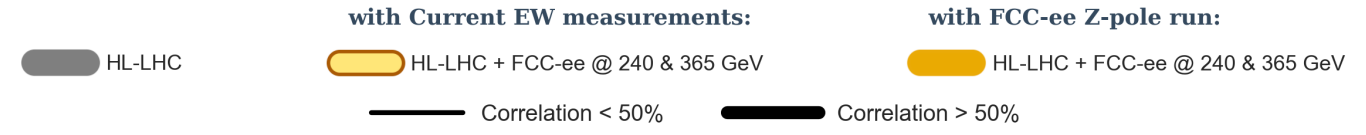

Why Z-pole for Higgs?

J. De Blas et al. 1907.04311

With Z-pole measurements, Higgs coupling determination improves by up to 50%

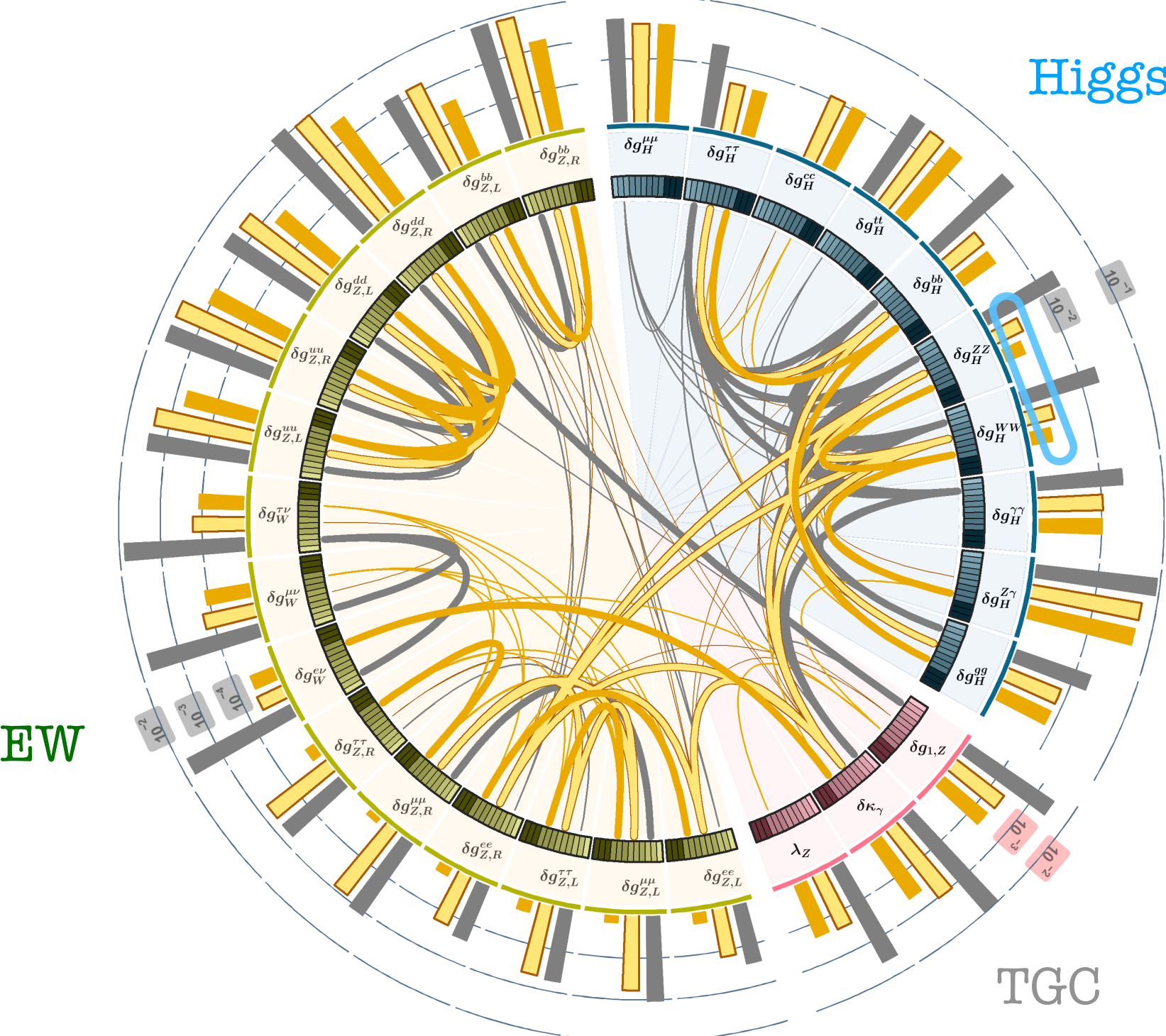

EW

Higgs

TGC

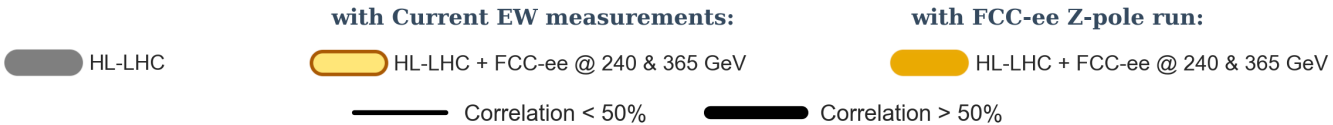

Why Z-pole for Higgs?

J. De Blas et al. 1907.04311

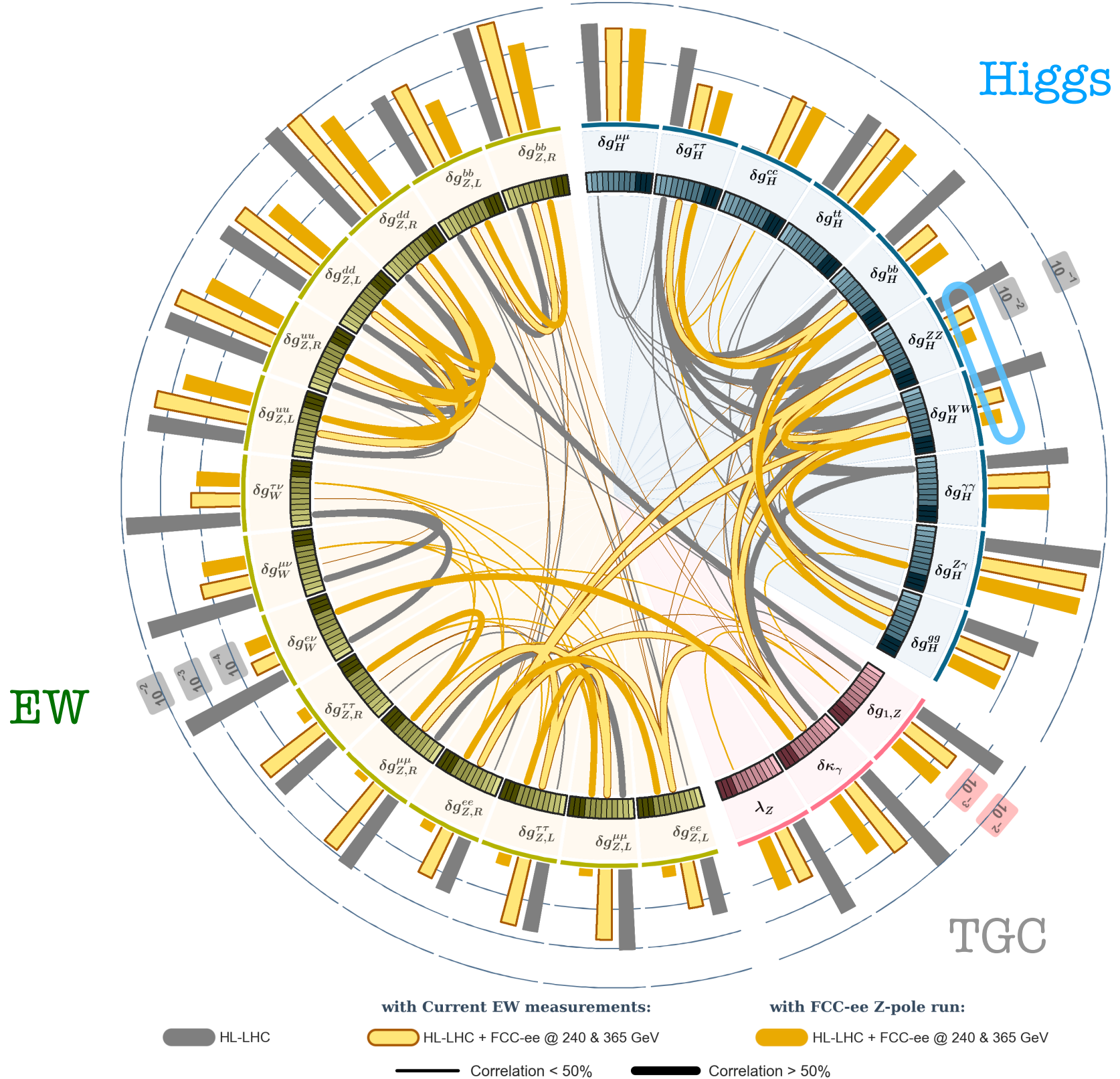

With Z-pole measurements, Higgs coupling determination improves by up to 50%

Z-pole run at circular colliders decorrelates EW and Higgs sectors from each other

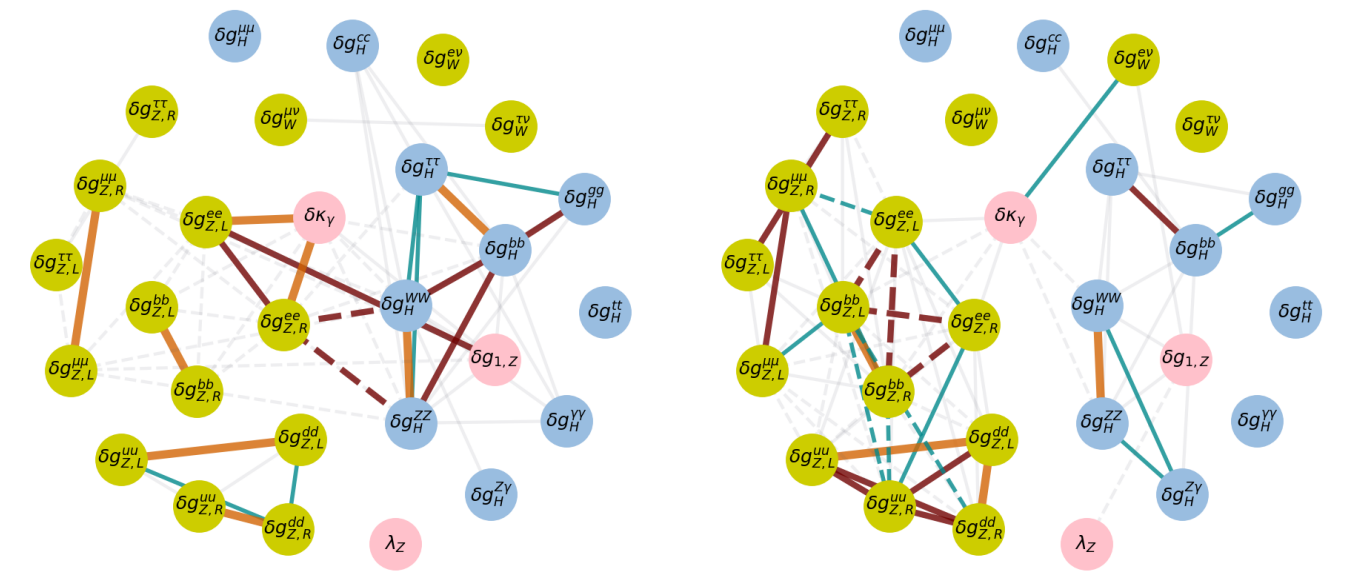

w/o Z-pole run

● Higgs
● aTGC
● EW

w/ Z-pole run

Impact of Z-pole on Higgs.

J. De Blas et al. 1907.04311

Comparing 3 EW scenarios: LEP/SLD, actual EW measurements, perfect EW measurements

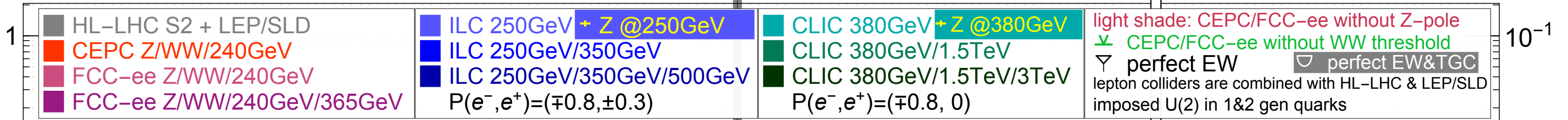

Higgs couplings

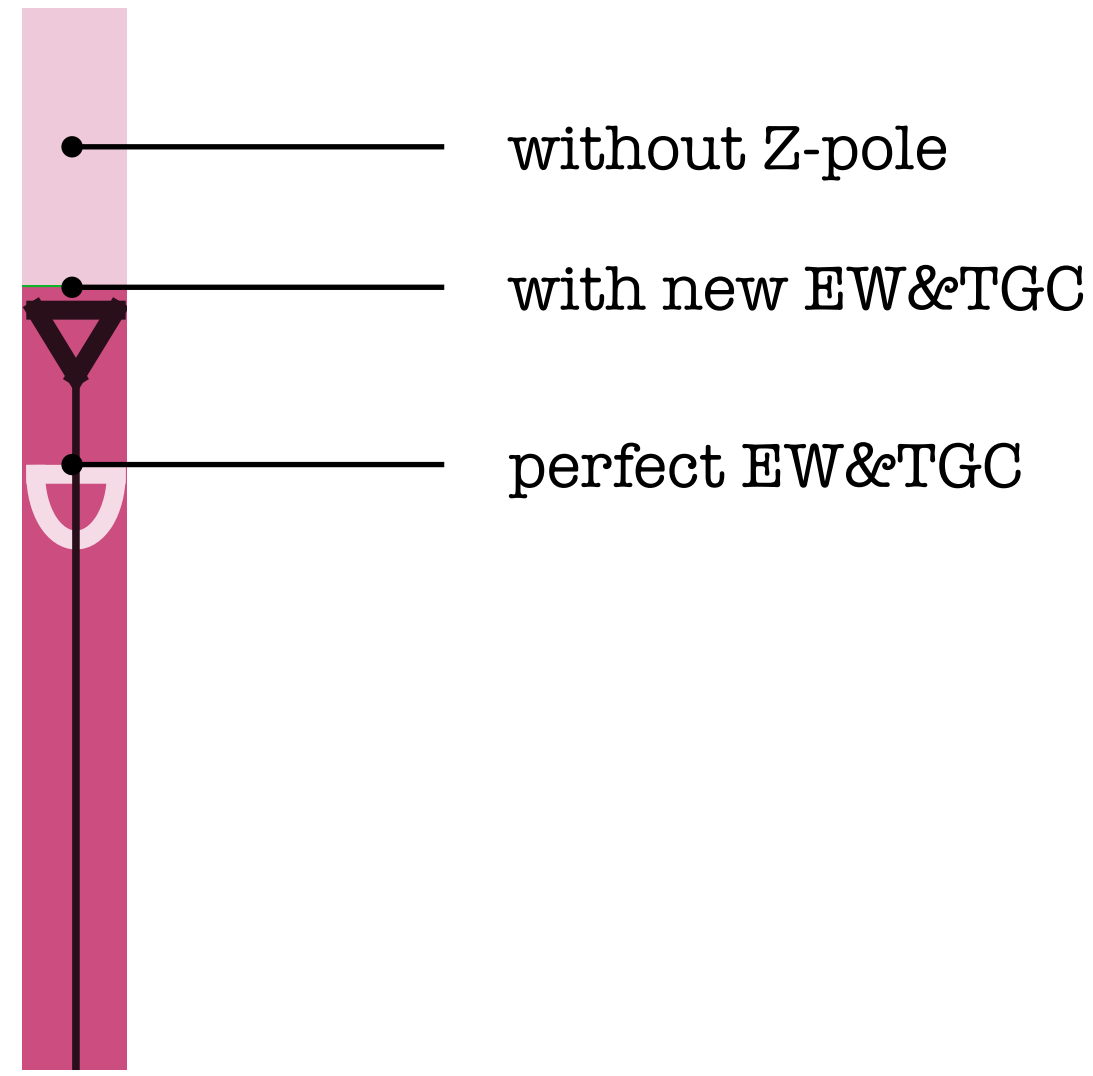

FCC-ee Z/WW/240GeV

Impact of Z-pole on Higgs.

J. De Blas et al. 1907.04311

Comparing 3 EW scenarios: LEP/SLD, actual EW measurements, perfect EW measurements

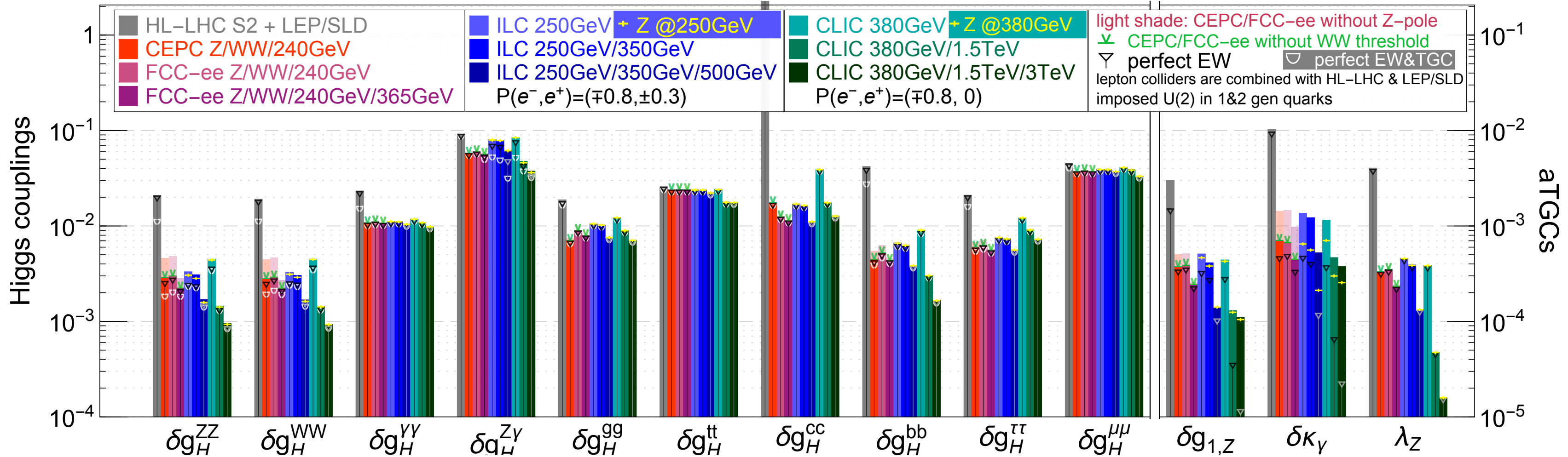

Impact of Z-pole on Higgs.

J. De Blas et al. 1907.04311

Comparing 3 EW scenarios: LEP/SLD, actual EW measurements, perfect EW measurements

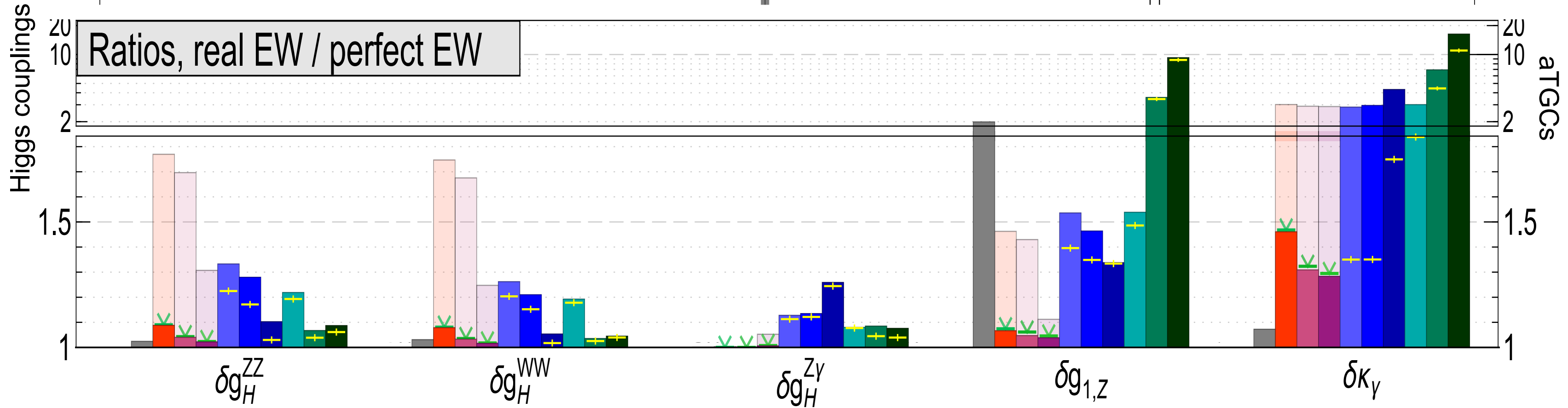
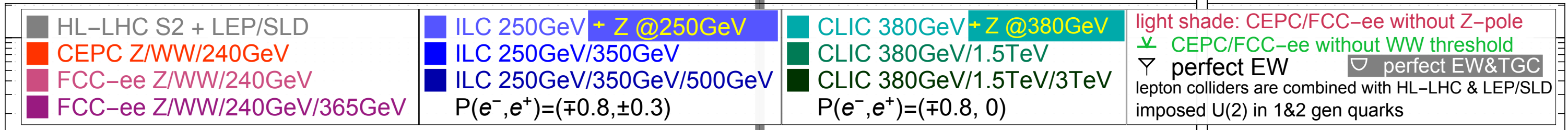

Impact of Z-pole on Higgs.

J. De Blas et al. 1907.04311

Comparing 3 EW scenarios: LEP/SLD, actual EW measurements, perfect EW measurements

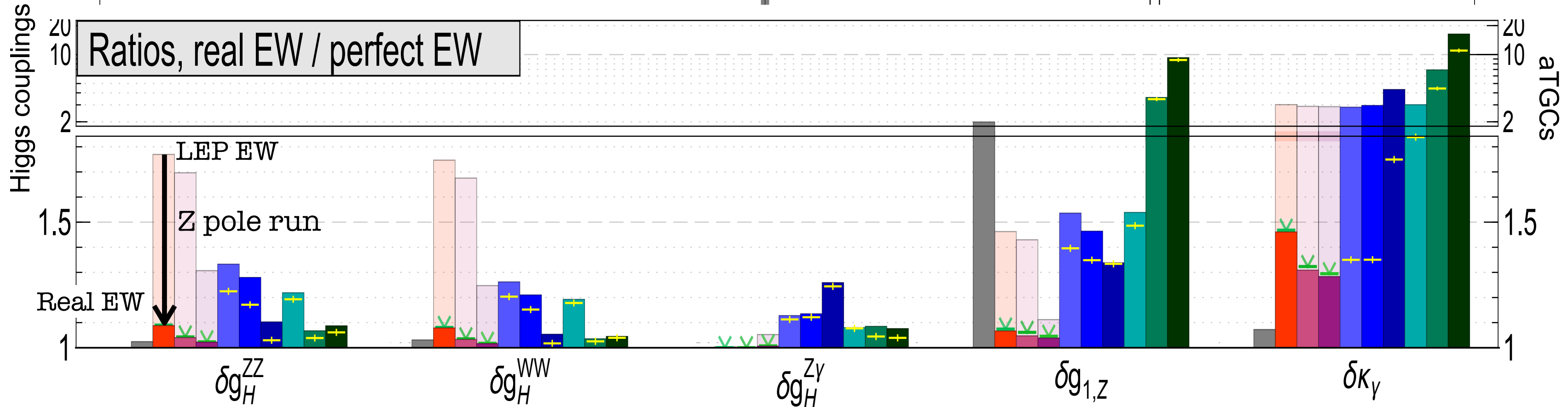
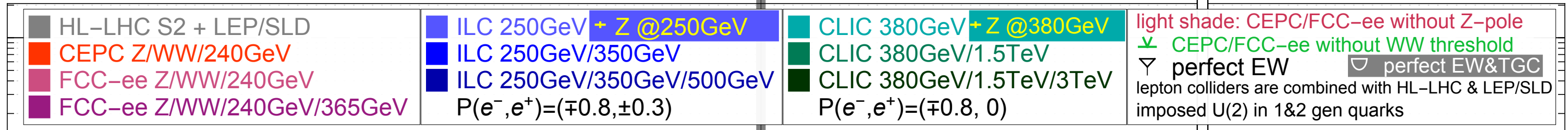

- FCC-ee and CEPC benefit a lot (>50% on HVV) from Z-pole run
- FCC-ee and CEPC EW measurements are almost perfect for what concerns Higgs physics (<10%).

Impact of Z-pole on Higgs.

J. De Blas et al. 1907.04311

Comparing 3 EW scenarios: LEP/SLD, actual EW measurements, perfect EW measurements

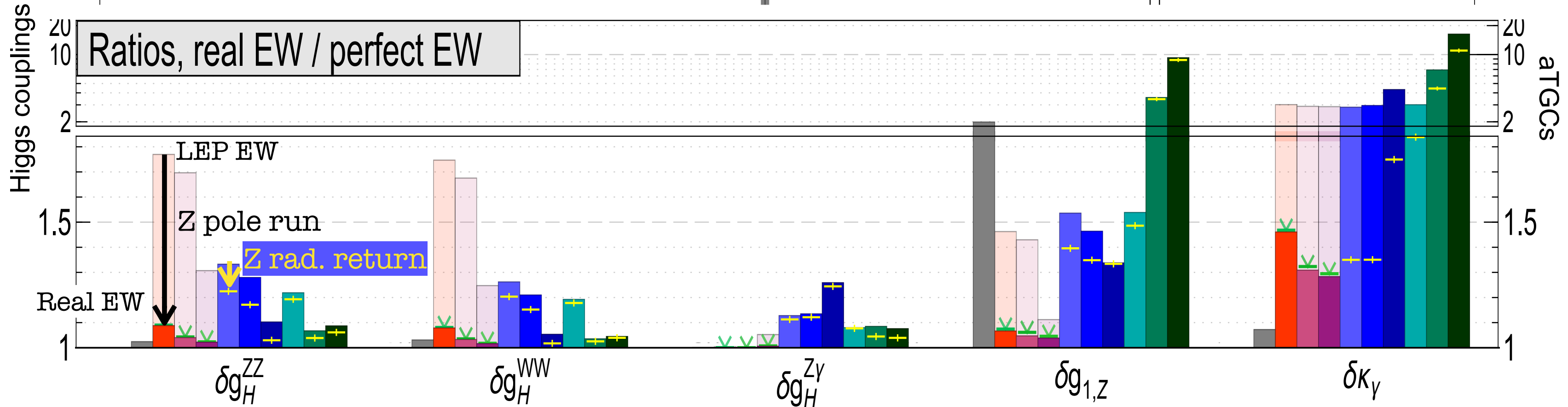
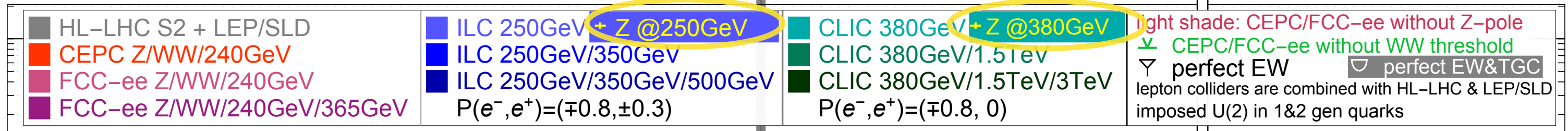

- FCC-ee and CEPC benefit a lot (>50% on HVV) from Z-pole run
- FCC-ee and CEPC EW measurements are almost perfect for what concerns Higgs physics (<10%).
- LEP EW measurements are a limiting factor (~30%) to Higgs precision at ILC, especially for the first runs
But EW measurements at high energy (via Z-radiative return) help mitigating this issue

Impact of Z-pole on Higgs.

J. De Blas et al. 1907.04311

Comparing 3 EW scenarios: LEP/SLD, actual EW measurements, perfect EW measurements

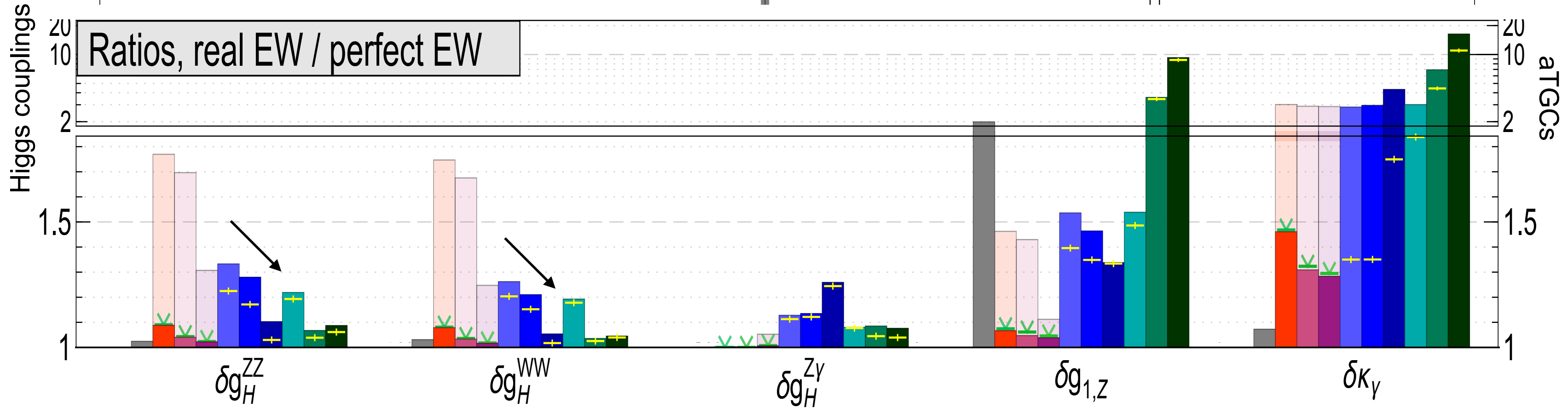
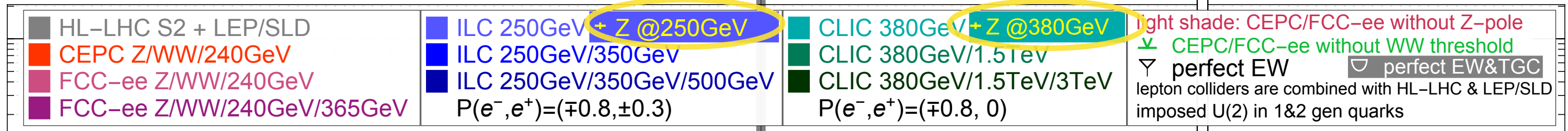

• Higher energy runs reduce the EW contamination in Higgs coupling extraction

Complementarity 240↔365 GeV.

ECFA Higgs study group '19

Scenario BR_{inv} BR_{unt} include HL-LHC
 kappa-2 measured measured no

hadron collider cannot measure width
 need an assumption to close the fit
 e.g. $\kappa_V < 1$

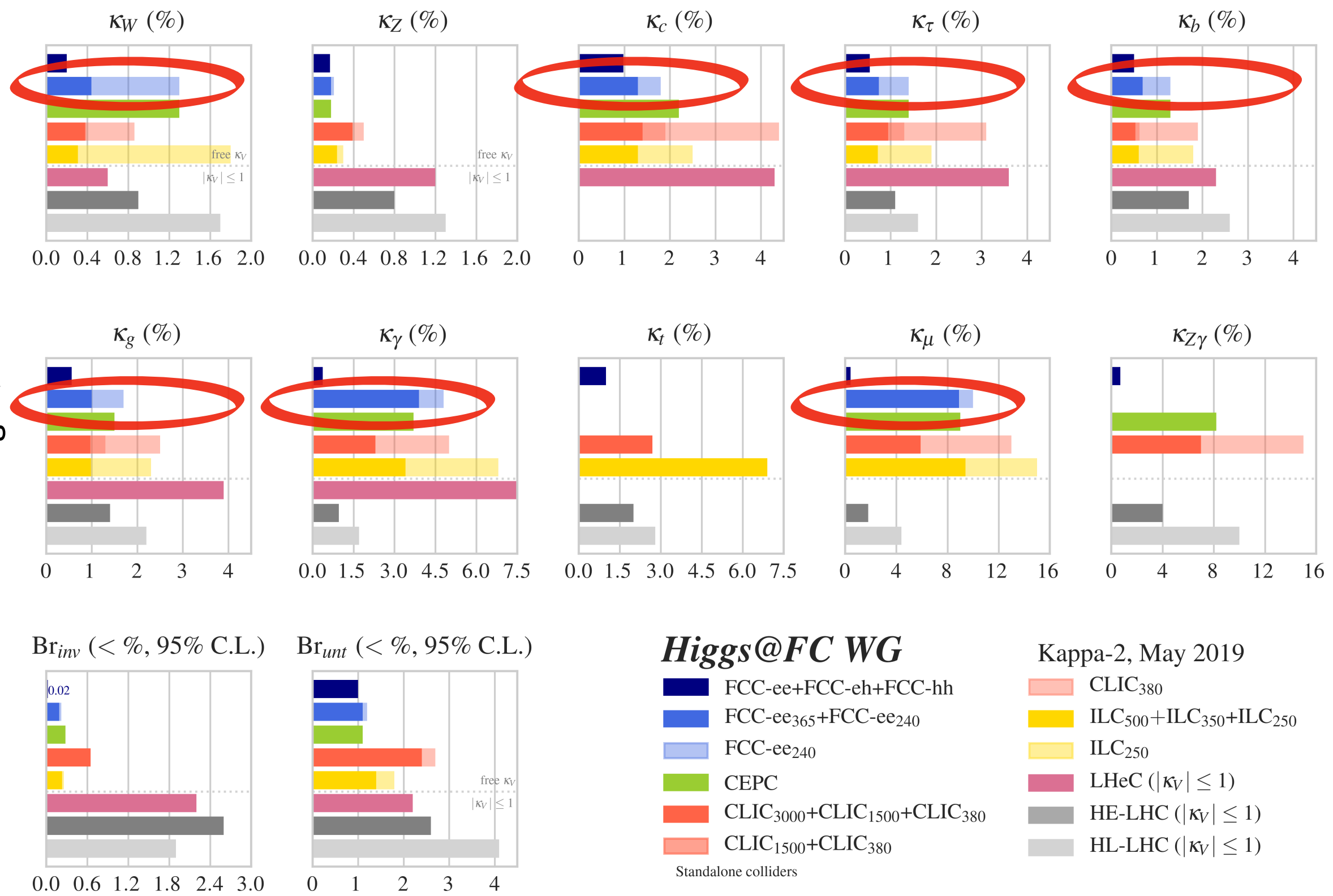

Complementarity FCC-ee ↔ HL-LHC.

ECFA Higgs study group '19

Scenario	BR_{inv}	BR_{unt}	include HL-LHC
kappa-2	measured	measured	no

hadron collider cannot measure width
need an assumption to close the fit
e.g. $\kappa_V < 1$

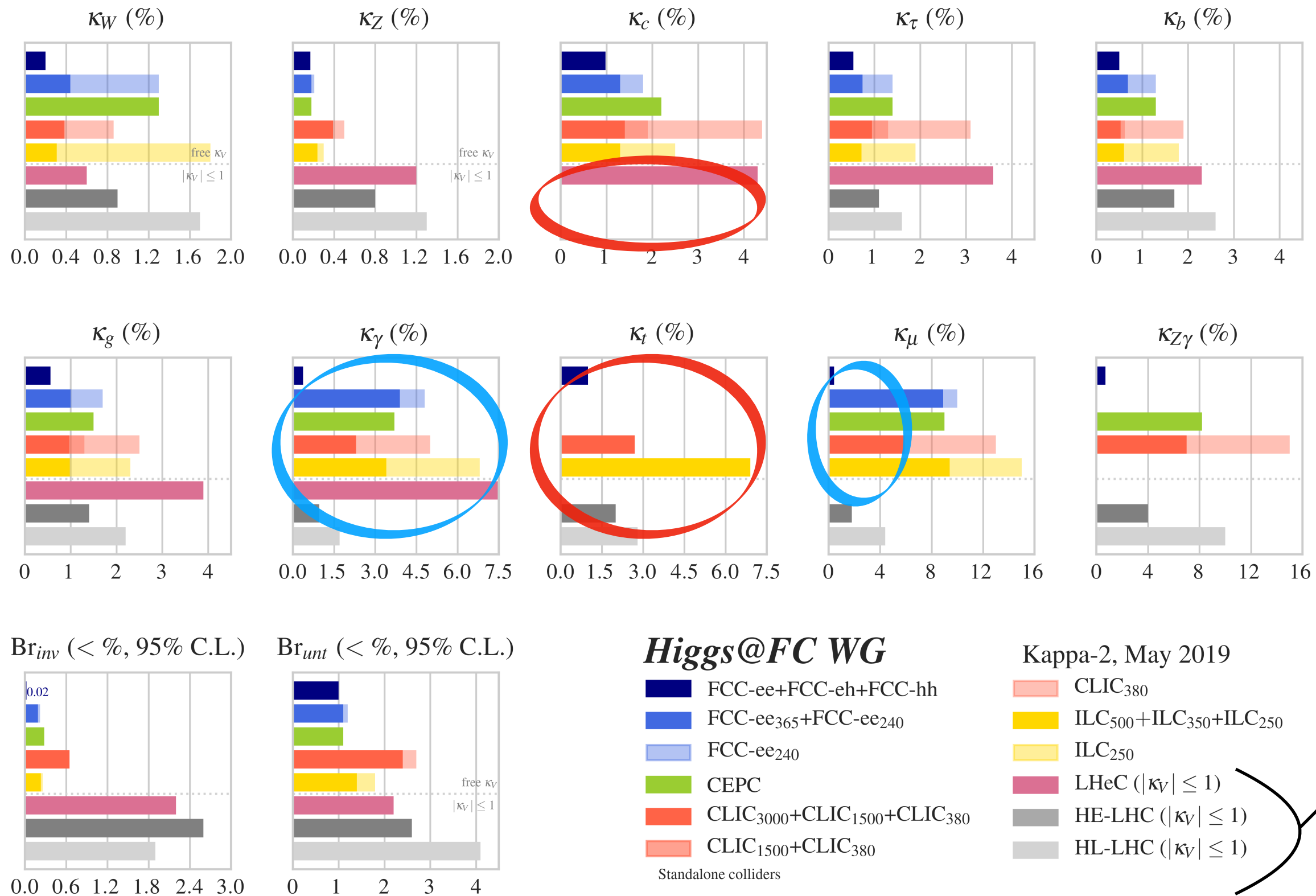

assumption
needed for the fit
to close at hadron
machines

Complementarity FCC-ee ↔ HL-LHC.

ECFA Higgs study group '19

Scenario	BR_{inv}	BR_{unt}	include HL-LHC
kappa-2	measured	measured	no

hadron collider cannot measure width
need an assumption to close the fit
e.g. $\kappa_V < 1$

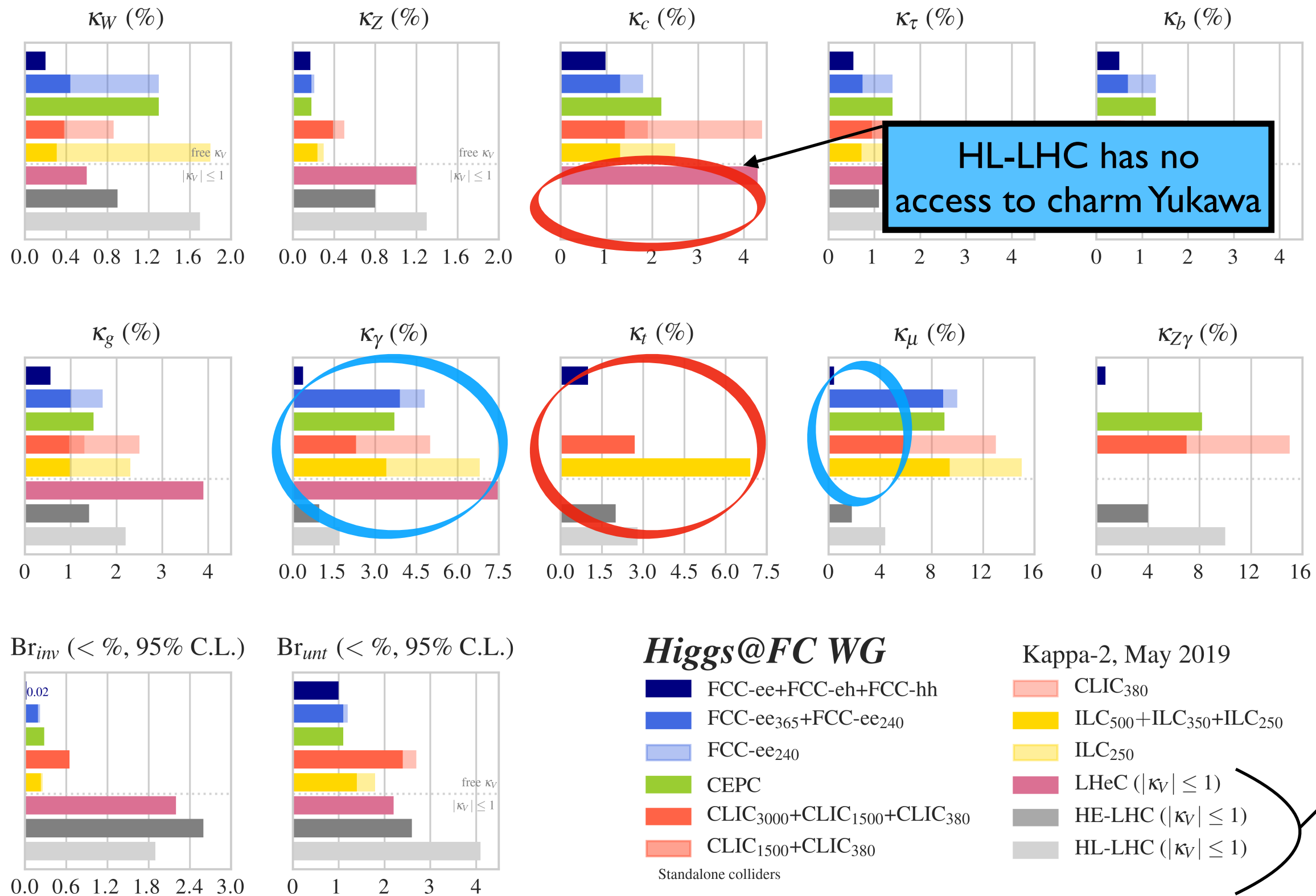

HL-LHC has no access to charm Yukawa

assumption needed for the fit to close at hadron machines

Complementarity FCC-ee ↔ HL-LHC.

ECFA Higgs study group '19

Scenario	BR_{inv}	BR_{unt}	include HL-LHC
kappa-2	measured	measured	no

hadron collider cannot measure width
need an assumption to close the fit
e.g. $\kappa_V < 1$

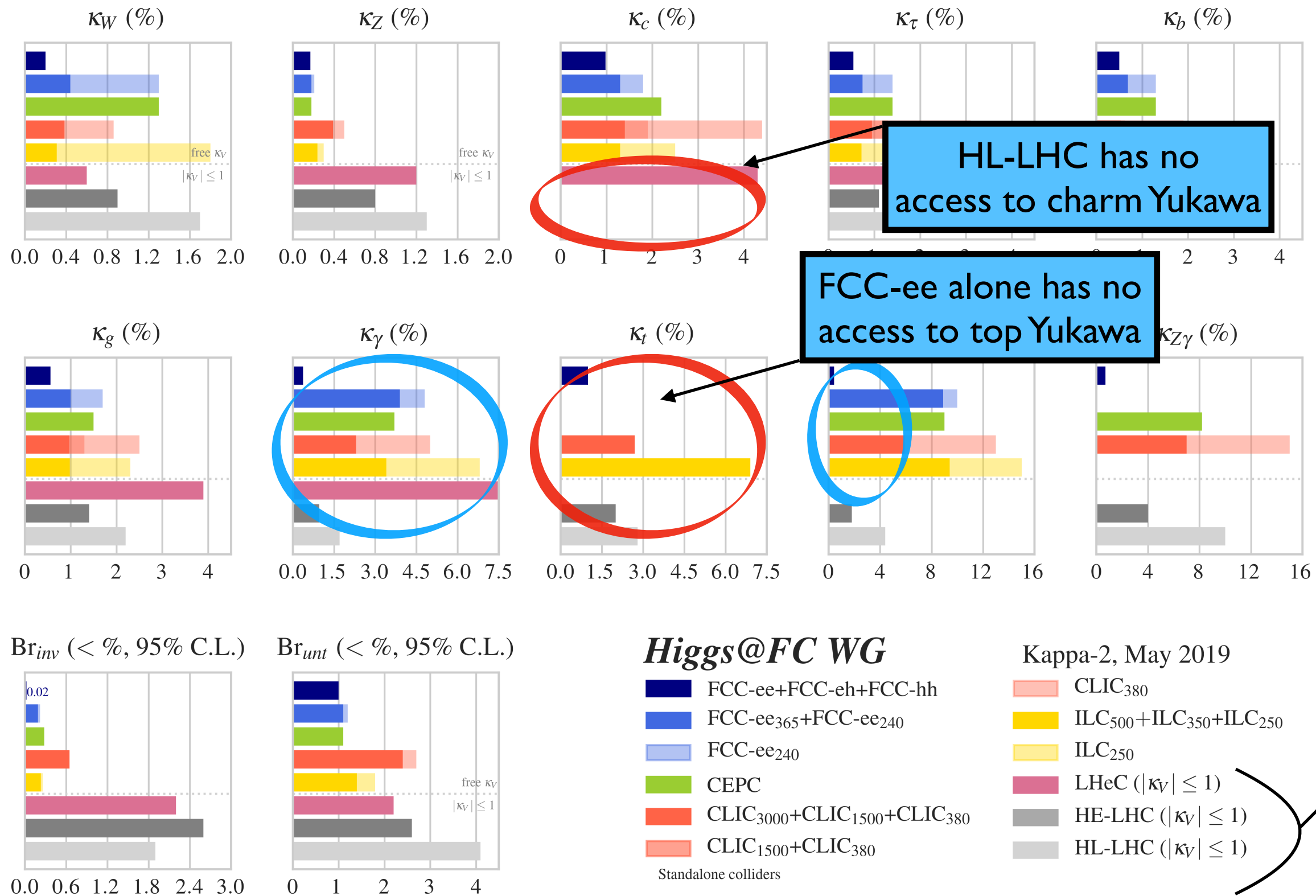

assumption
needed for the fit
to close at hadron
machines

Complementarity FCC-ee ↔ HL-LHC.

ECFA Higgs study group '19

Scenario	BR_{inv}	BR_{unt}	include HL-LHC
kappa-2	measured	measured	no

hadron collider cannot measure width
need an assumption to close the fit
e.g. $\kappa_V < 1$

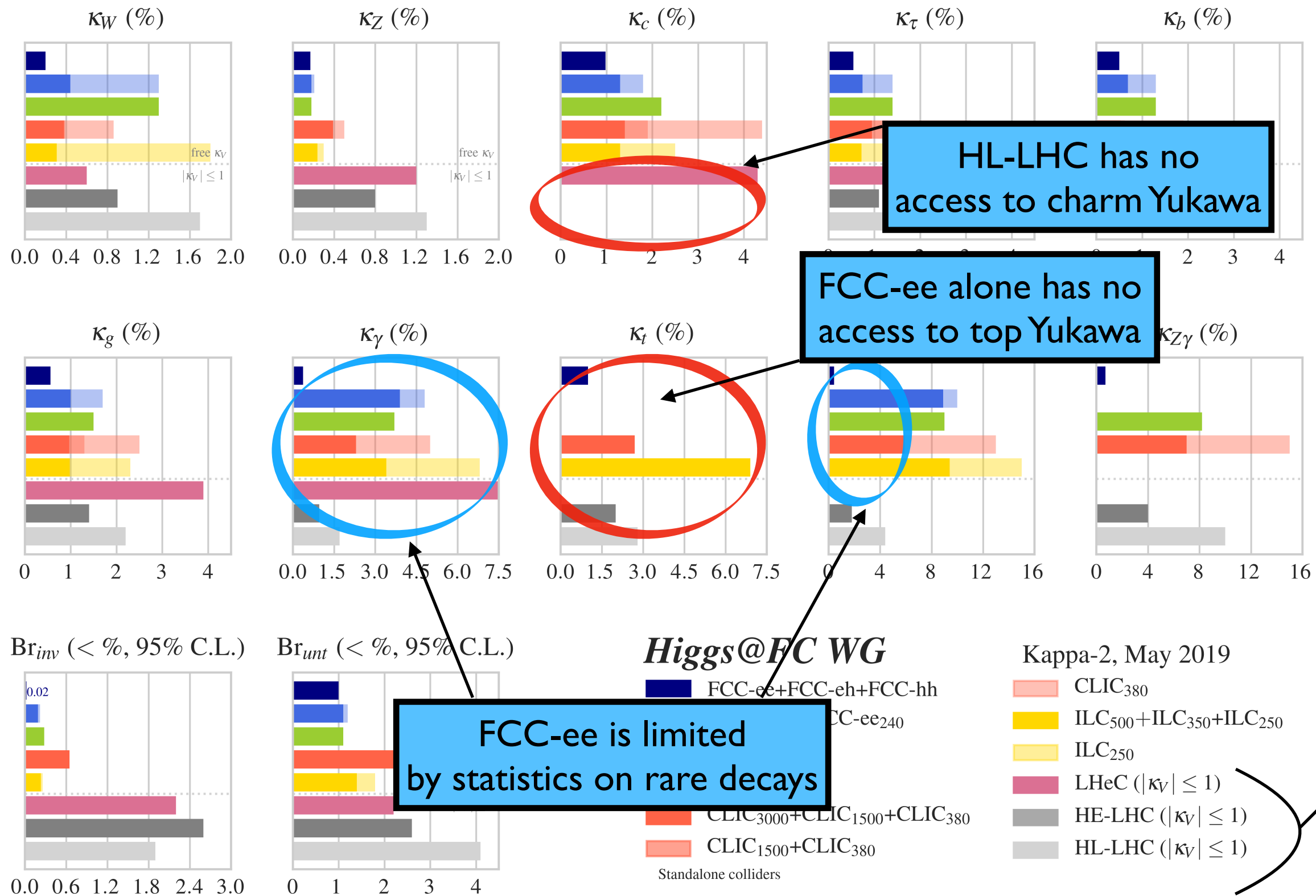

HL-LHC has no access to charm Yukawa

FCC-ee alone has no access to top Yukawa

FCC-ee is limited by statistics on rare decays

assumption needed for the fit to close at hadron machines

Complementarity FCC-ee ↔ HL-LHC.

ECFA Higgs study group '19

Scenario	include HL-LHC
kappa-3	yes
BR_{inv}	measured
BR_{unt}	measured

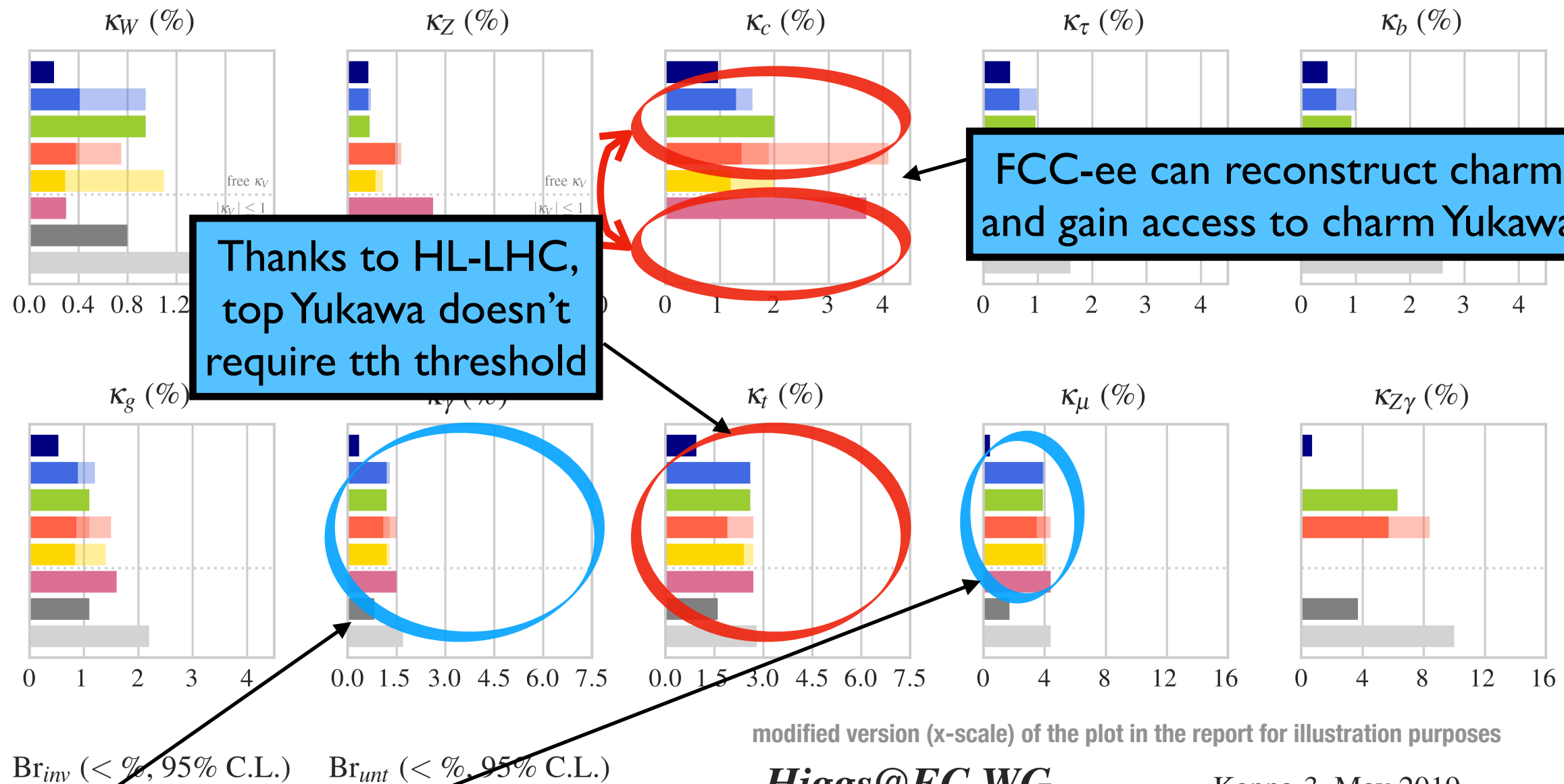

Thanks to HL-LHC, top Yukawa doesn't require tth threshold

FCC-ee can reconstruct charm and gain access to charm Yukawa

LHC brings statistics
FCC-ee adds a bit of sensitivity

Important synergy HL-LHC — low energy lepton colliders

1. Top/Charm Yukawa
2. Statistically limited channels: $\gamma\gamma$, $\mu\mu$

Impact of Diboson Systematics.

J. De Blas, G. Durieux, C. Grojean, J. Gu, A. Paul 1907.04311

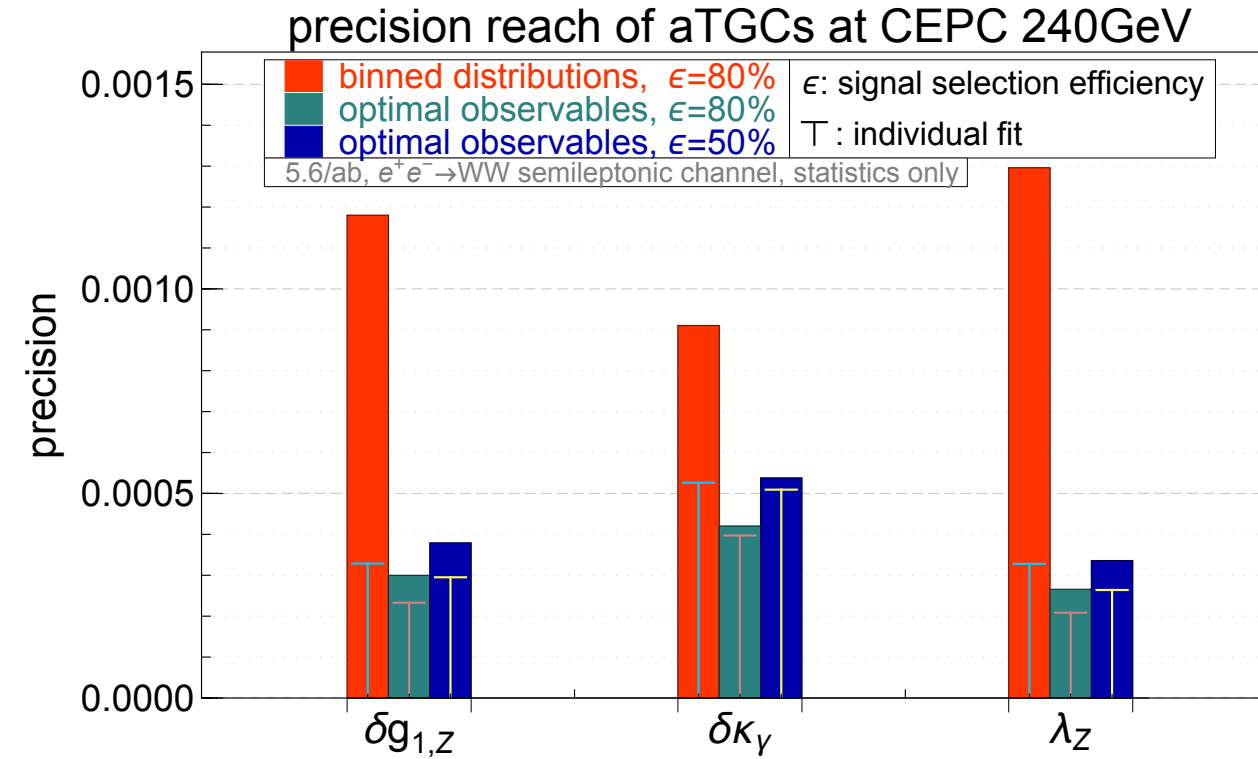

precision reach with different assumptions on $e^+e^- \rightarrow WW$ measurements

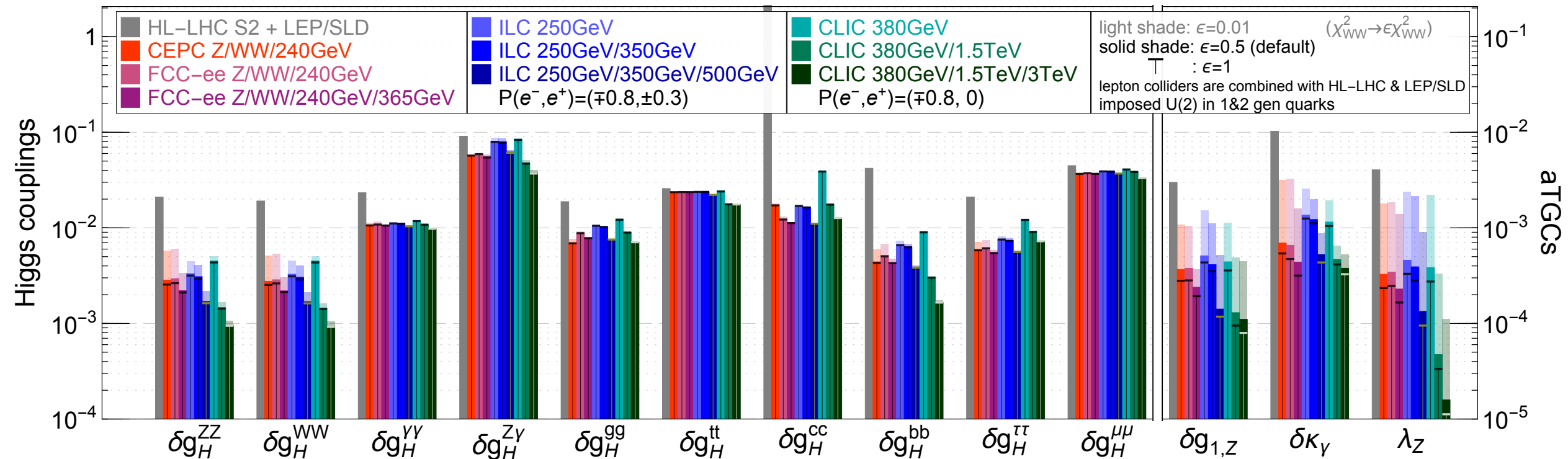

Higgs self-coupling.

Higgs self-couplings is very interesting for a multitude of reasons
(vacuum stability, hierarchy, baryogenesis, GW, EFT probe...).

How much can it deviate from SM given the tight constraints on other Higgs couplings?
Do you need to reach HH production threshold to constrain h^3 coupling?

ECFA Higgs study group '19

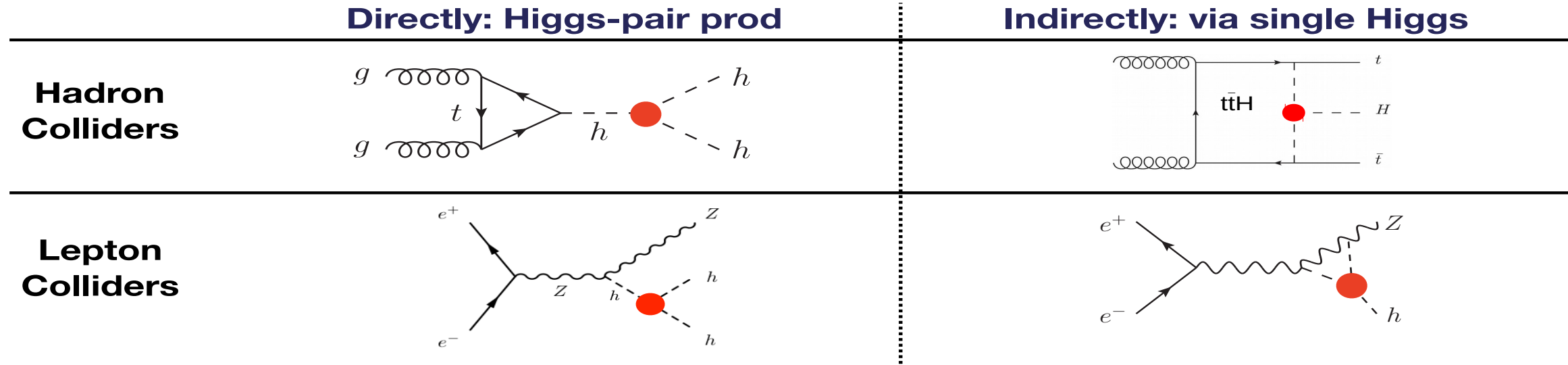

	di-Higgs	single-H
exclusive	<p>1. di-H, excl.</p> <ul style="list-style-type: none"> • Use of $\sigma(HH)$ • only deformation of $\kappa\lambda$ 	<p>3. single-H, excl.</p> <ul style="list-style-type: none"> • single Higgs processes at higher order • only deformation of $\kappa\lambda$
global	<p>2. di-H, glob.</p> <ul style="list-style-type: none"> • Use of $\sigma(HH)$ • deformation of $\kappa\lambda$ + of the single-H couplings (a) do not consider the effects at higher order of $\kappa\lambda$ to single H production and decays (b) these higher order effects are included 	<p>4. single-H, glob.</p> <ul style="list-style-type: none"> • single Higgs processes at higher order • deformation of $\kappa\lambda$ + of the single Higgs couplings

Large self-coupling scenarios.

Generically: $\left| \frac{\delta_{h^3}}{\delta_{\text{single } h}} \right| \sim O(1)$ (composite Higgs/susy)

Particular exceptions: Higgs DM-portal models or custodial EW quadruplet

DiVita et al.: 1704.01953

Falkowski, Rattazzi: 1902.05936

Durieux, McCullough, Salvioni: 2209.00666

h^3 generically is not a tool to discover BSM but exceptions exist.

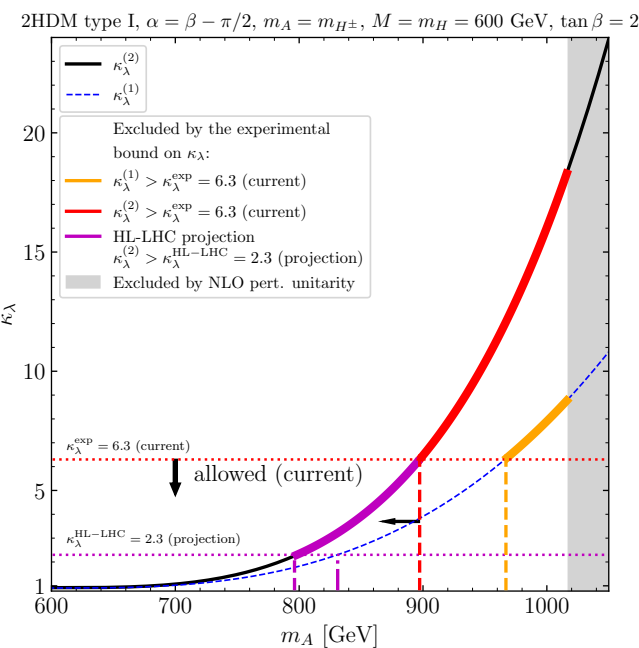
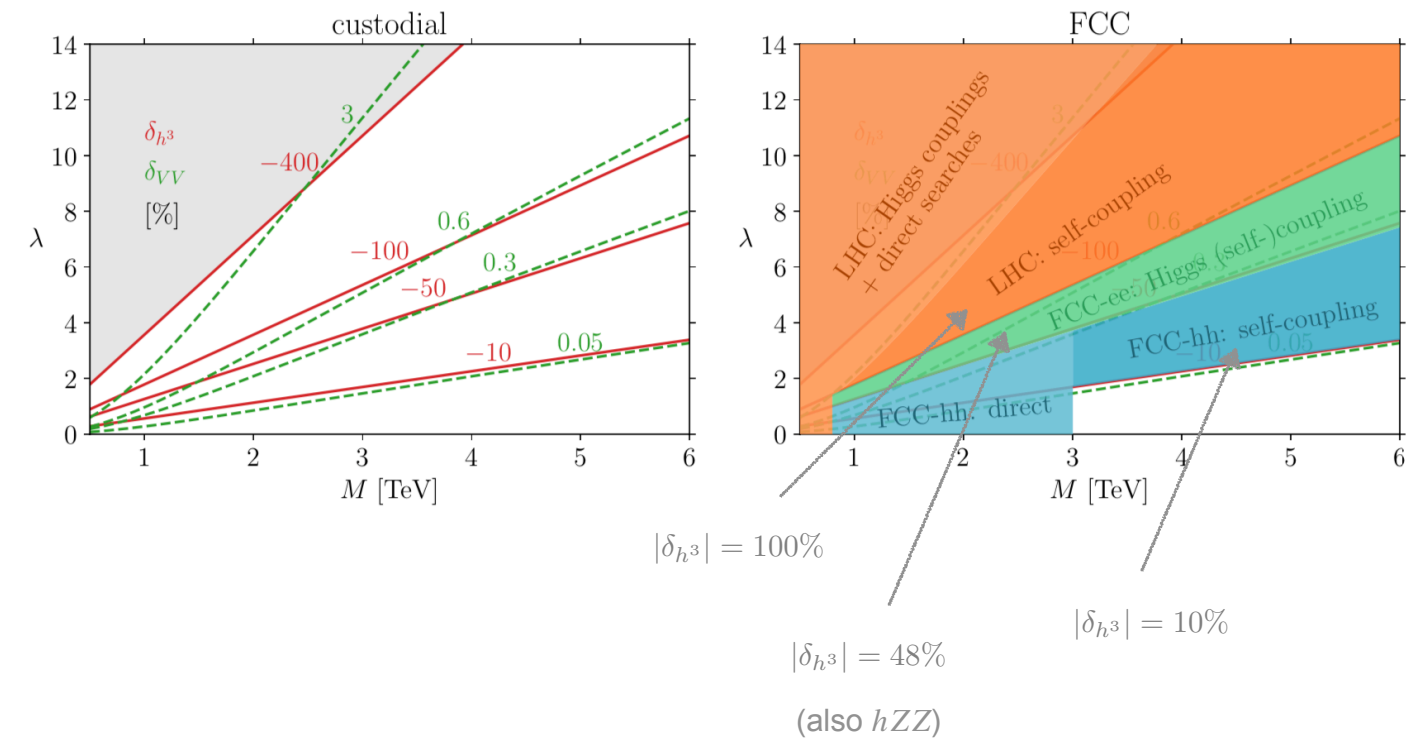

Other exceptions: non-decoupled/fine-tuned spectra

Bahl, Braathen, Weiglein: 2202.03453

Large self-coupling scenarios.

It is true that we haven't "measured" the Higgs potential but there are only peculiar physics scenarios that produce large deviations in the shape of the potential without leaving imprints elsewhere.

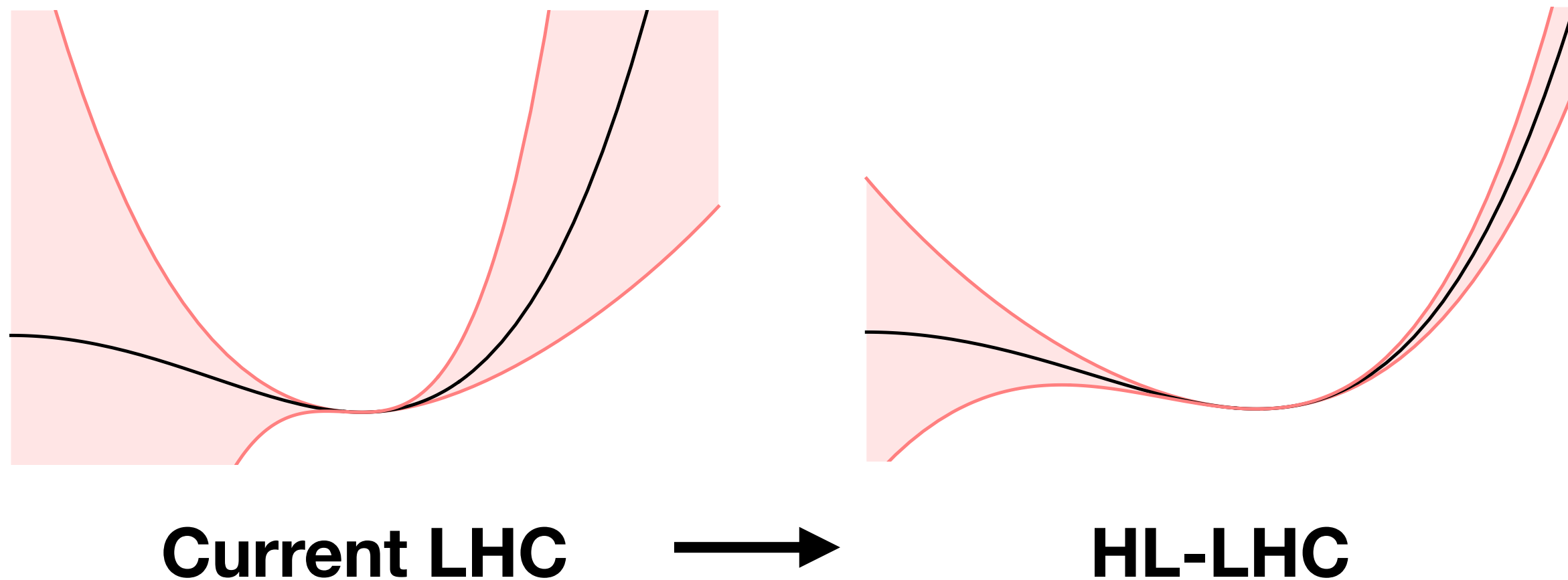

R. Petrossian-Byrne/N. Craig @ LCWS'23

Important to understand which dynamics is really probed when embarking into challenging measurements. Actually, double Higgs production is also interesting to probe new physics in its tail rather than near threshold (where the sensitivity to Higgs self-coupling comes from).

Higgs self-coupling.

ECFA Higgs study group '19

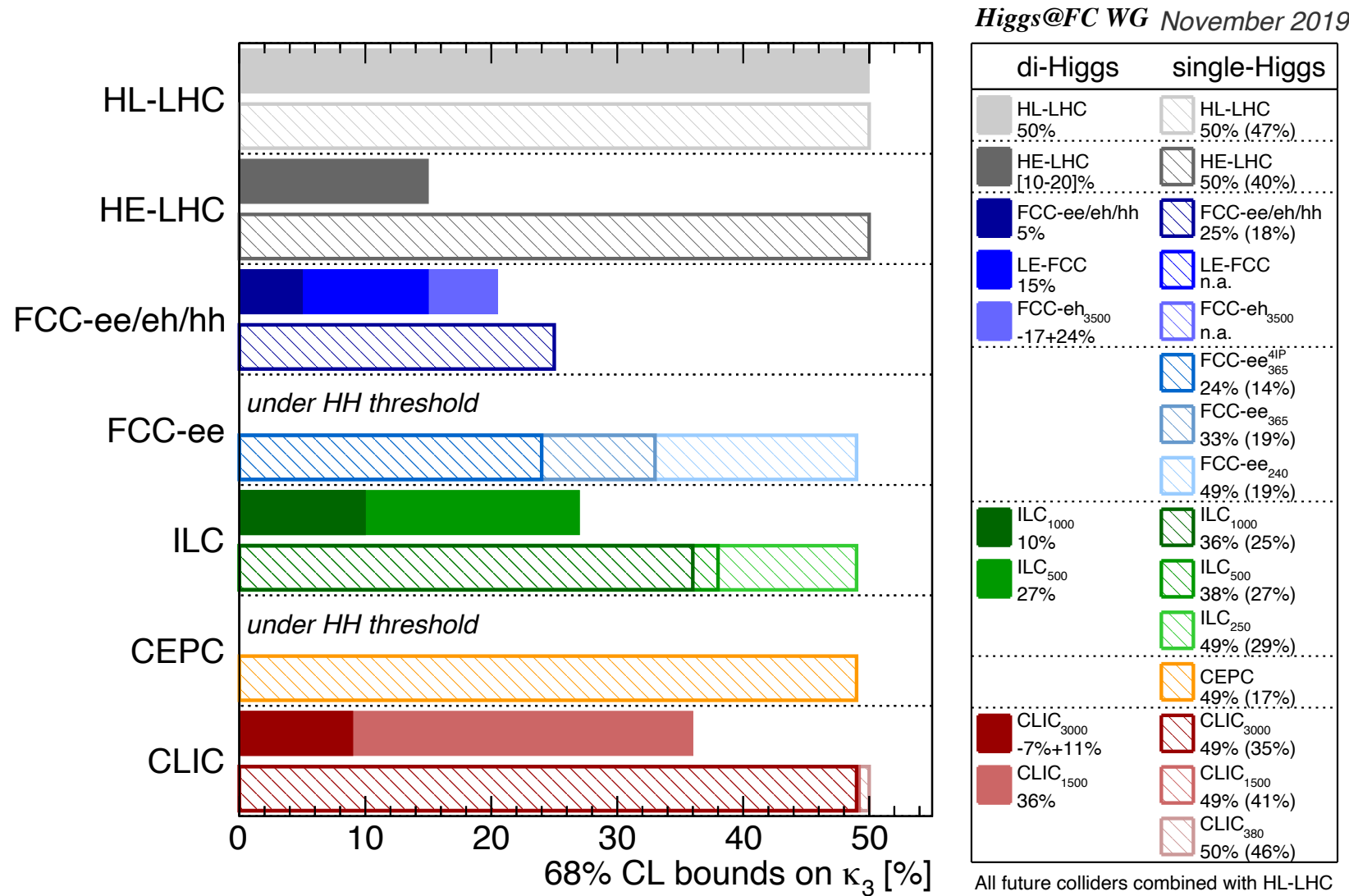

1

Don't need to reach HH threshold to have access to h^3 .
Z-pole run is very important if the HH threshold cannot be reached

2

The determination of h^3 at FCC-hh relies on HH channel, for which FCC-ee is of little direct help. But the extraction of h^3 requires precise knowledge of y_t .
 $1\% y_t \leftrightarrow 5\% h^3$
Precision measurement of y_t needs ee

50% sensitivity: establish that $h^3 \neq 0$ at 95%CL
20% sensitivity: 5σ discovery of the SM h^3 coupling
5% sensitivity: getting sensitive to quantum corrections to Higgs potential

Discovery potential beyond LHC

Discovery Potential Beyond LHC.

Precisely measured EW and Higgs observables are sensitive to heavy New Physics
 Examples of improved sensitivity wrt direct reach @ HL-LHC: SUSY

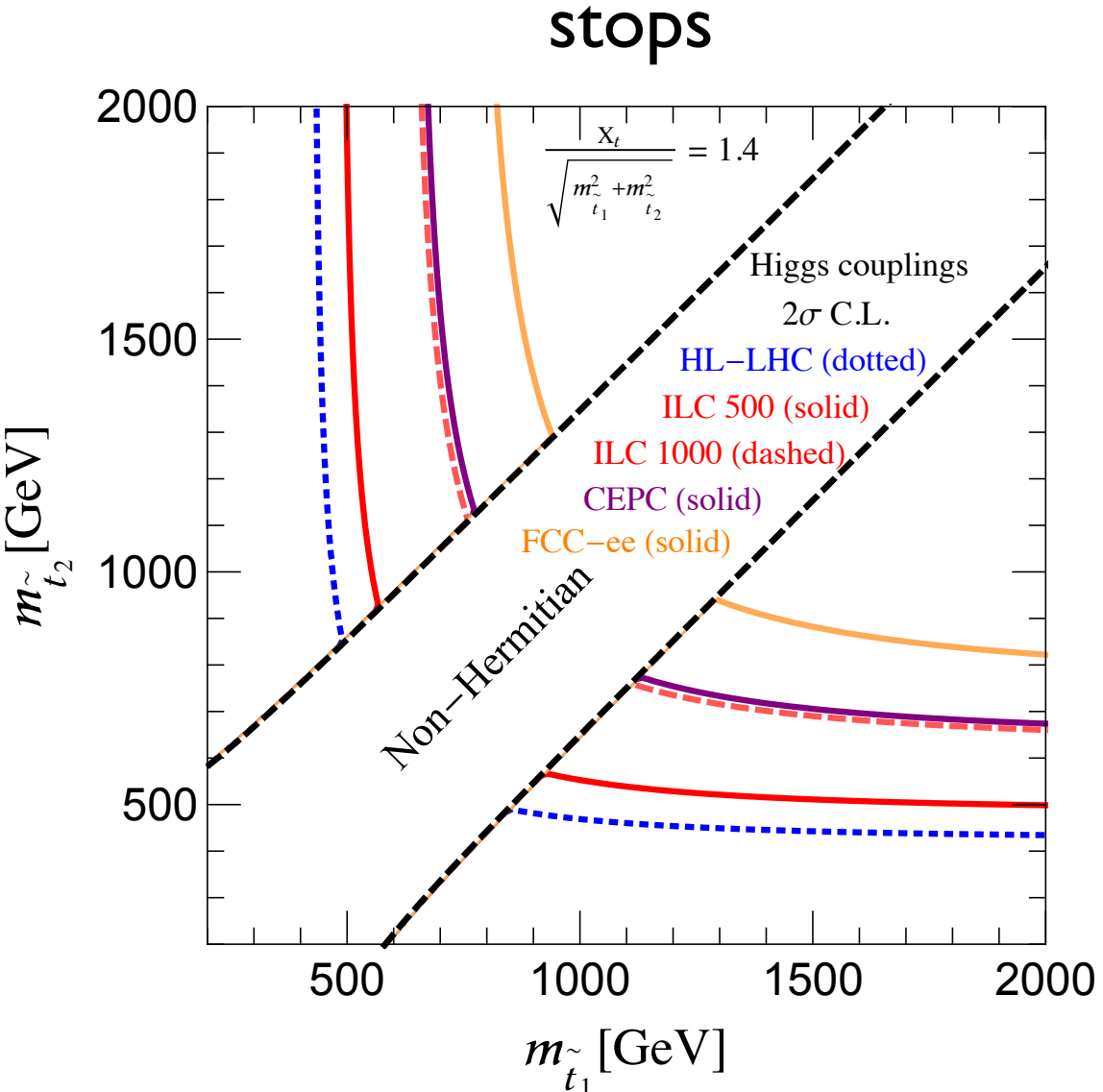

Fan, Reece, Wang '14

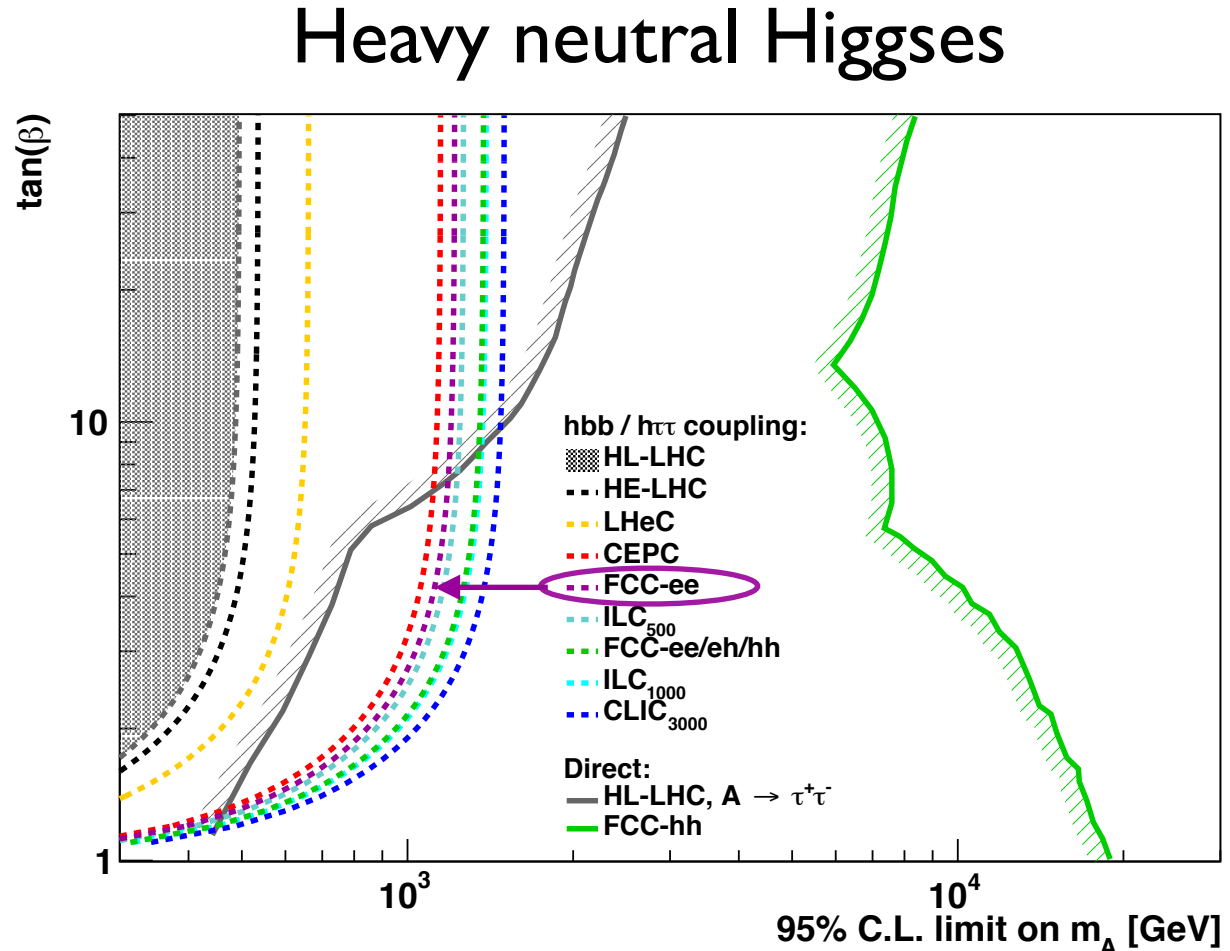

ESU Physics BB '19

Discovery Potential Beyond LHC.

Precisely measured EW and Higgs observables are sensitive to heavy New Physics
 Examples of improved sensitivity wrt direct reach @ HL-LHC: Composite Higgs

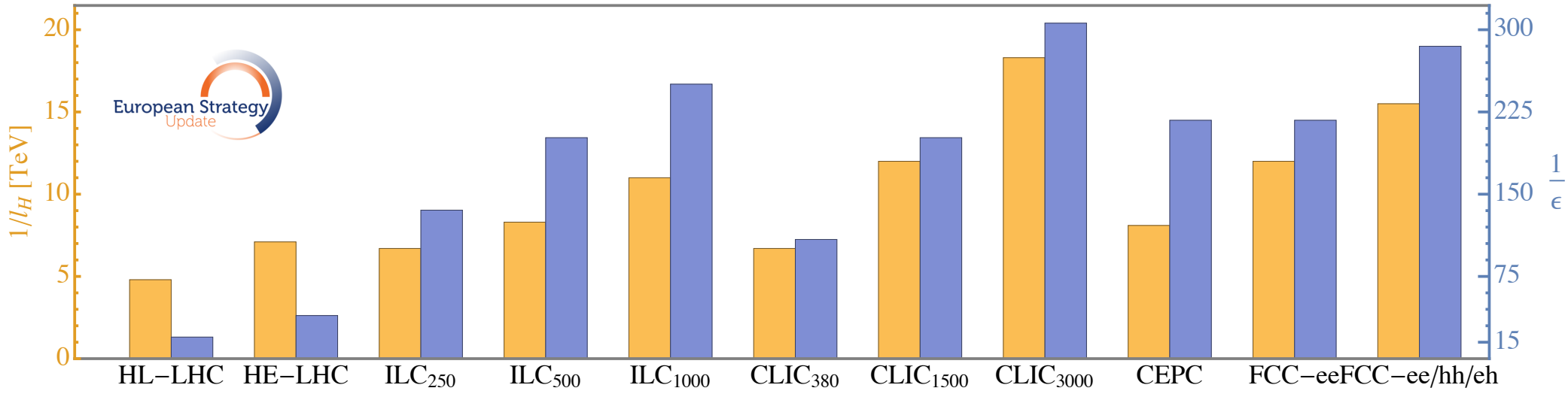
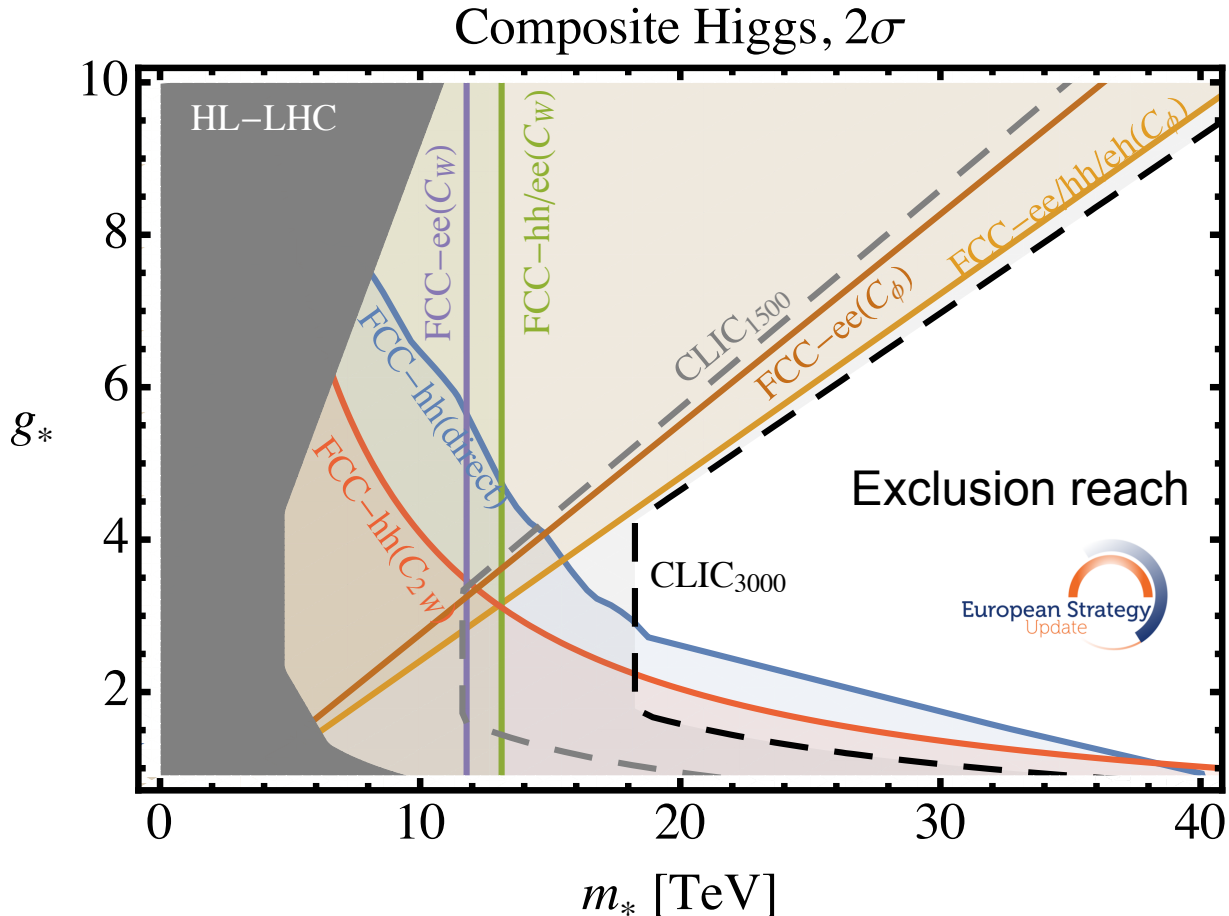

Fig. 8.5: Exclusion reach of different colliders on the inverse Higgs length $1/l_H = m_*$ (orange bars, left axis) and the tuning parameter $1/\epsilon$ (blue bars, right axis), obtained by choosing the weakest bound valid for any value of the coupling constant g_* .

Direct Searches for Elusive New Physics

- **LLP searches with displaced vertices**

e.g. in twin Higgs models glueballs that mix with the Higgs and decay back to b-quarks

Craig et al, arXiv:1501.05310

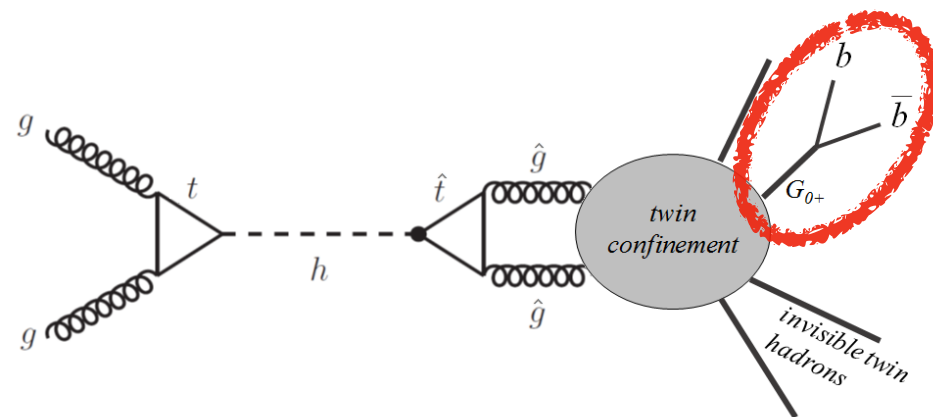

- **Rare decays**

Gori et al arXiv:2005.05170

e.g. ALP mixing w/ SM mesons:

$$K_L \rightarrow \pi^0 a \rightarrow \pi^0 \gamma \gamma \text{ (KOTO)}$$

$$K^+ \rightarrow \pi^+ a \rightarrow \pi^+ \gamma \gamma \text{ (NA62)}$$

$$\mathcal{L} = \frac{\alpha_s}{8\pi F_a} a G_{\mu\nu} \tilde{G}^{\mu\nu}$$

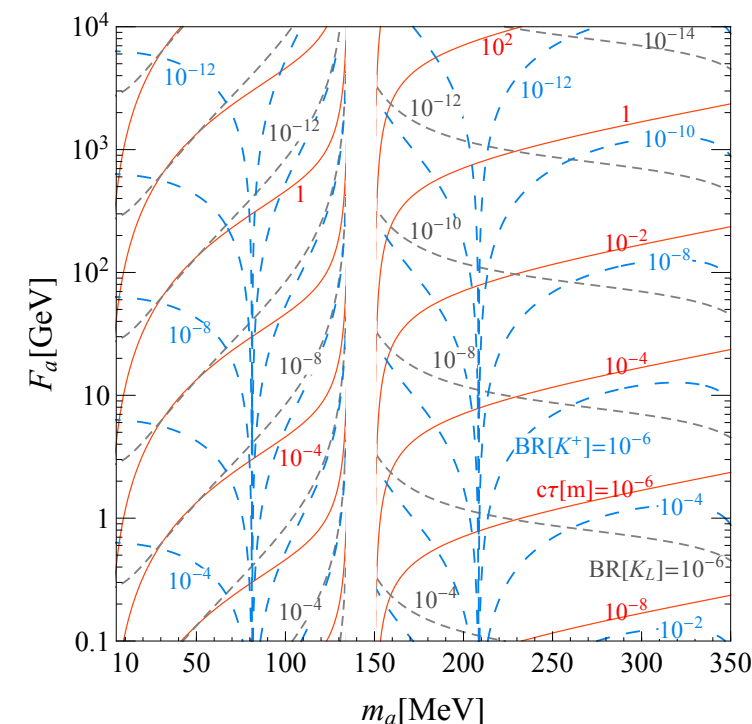

- **ALPs@ colliders**

e.g. $e^+e^- \rightarrow \gamma a$

$e^+e^- \rightarrow ha$

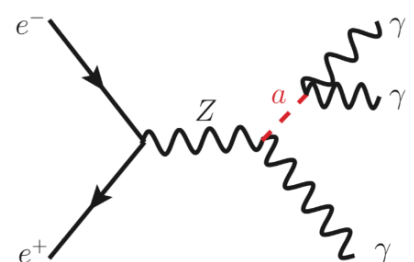

Knapen, Thamm arXiv:2108.08949

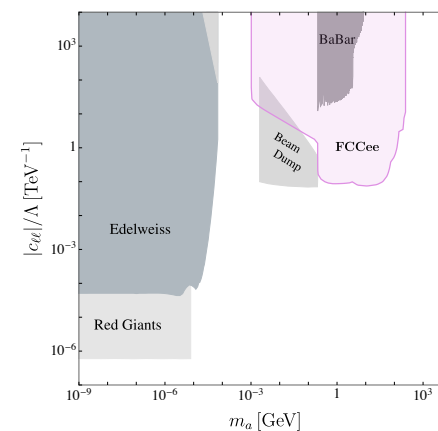
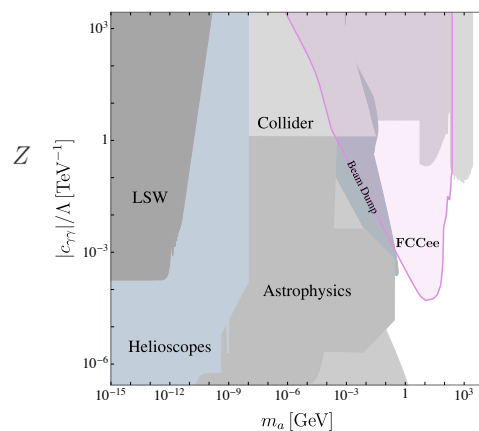

Astro/Cosmo → long-lived ALPs
colliders → short-lived ALPs MeV+

Search for ν_{RH} .

Direct observation
in Z decays
from LH-RH mixing

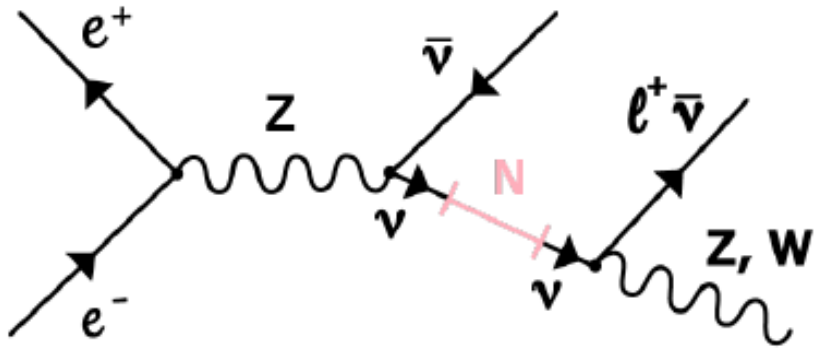

Important to understand

1. how neutrinos acquired mass
2. if lepton number is conserved
3. if leptogenesis is realised

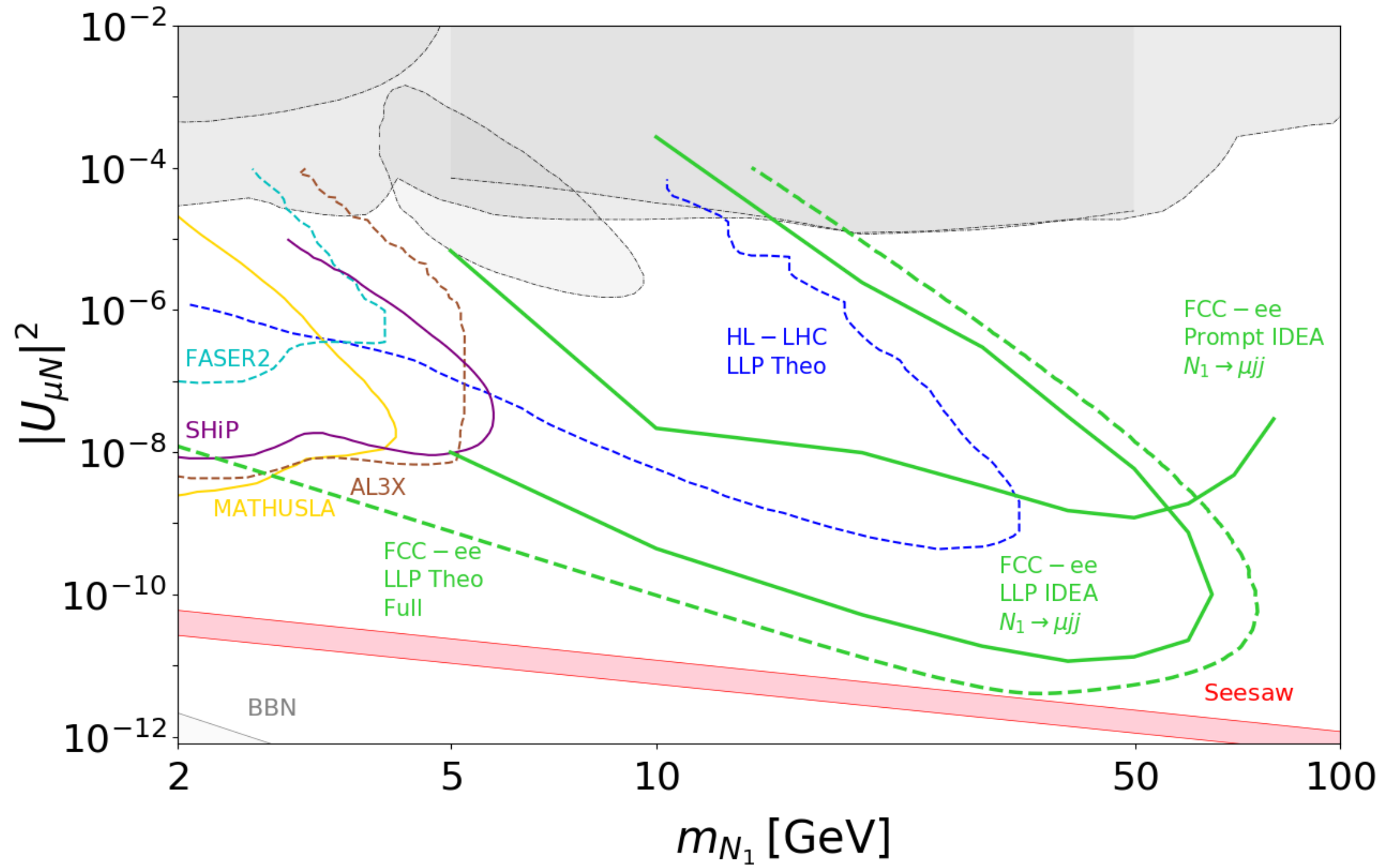
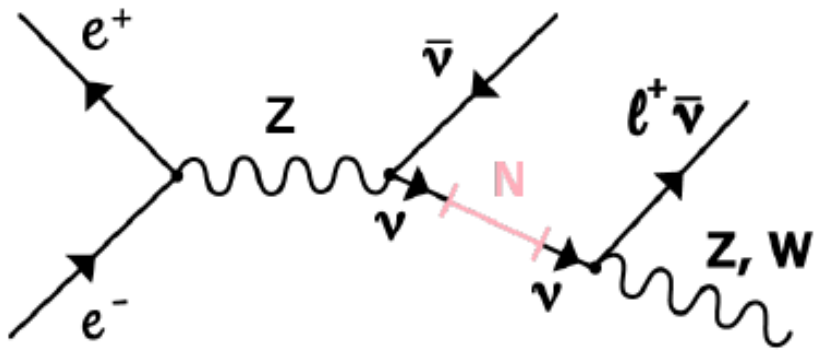

Fig. from mid-term report

Search for ν_{RH} .

Direct observation
in Z decays
from LH-RH mixing



Important to understand

1. how neutrinos acquired mass
2. if lepton number is conserved
3. if leptogenesis is realised

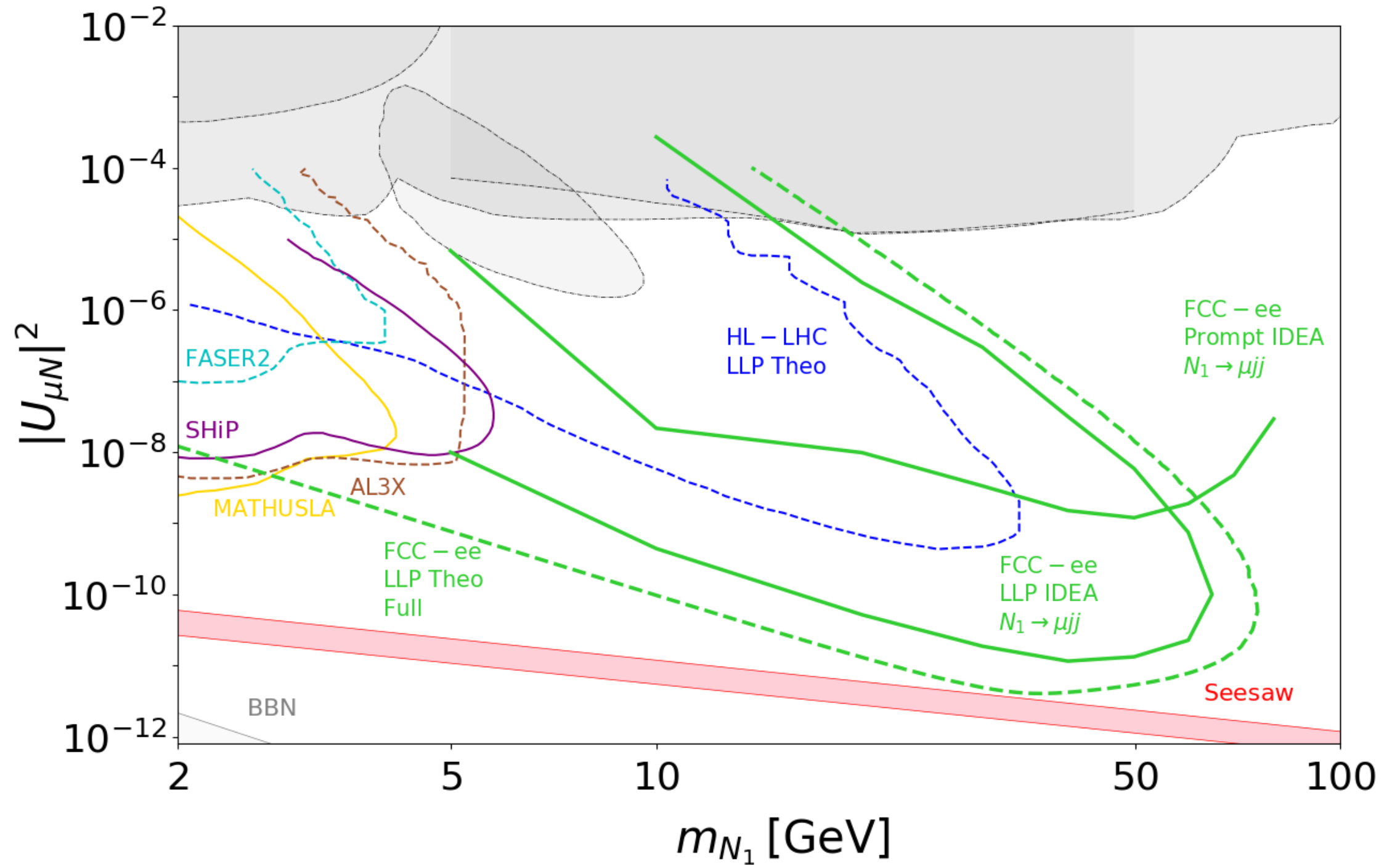
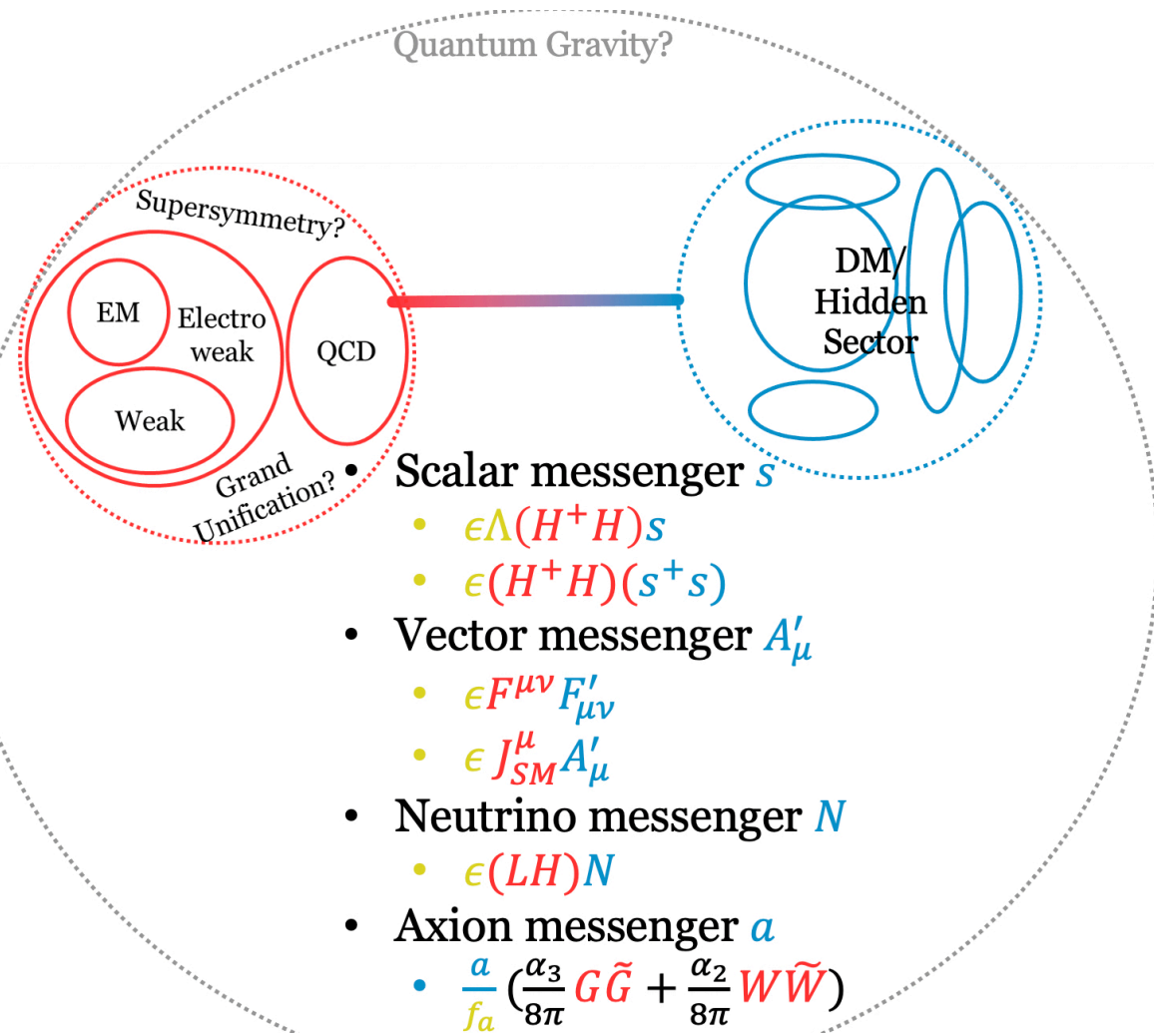

Fig. from mid-term report

Exotics/Long Lived Particles.

Z. Liu @ CEPC 2020

The Higgs could be a good portal to Dark Sector
— rich exotic signatures —



- Scalar messenger s
 - $\epsilon \Lambda (H^+ H) s$
 - $\epsilon (H^+ H) (s^+ s)$
- Vector messenger A'_μ
 - $\epsilon F^{\mu\nu} F'_{\mu\nu}$
 - $\epsilon J_{SM}^\mu A'_\mu$
- Neutrino messenger N
 - $\epsilon (LH) N$
- Axion messenger a
 - $\frac{a}{f_a} \left(\frac{\alpha_3}{8\pi} G\tilde{G} + \frac{\alpha_2}{8\pi} W\tilde{W} \right)$

Decay Topologies	Decay mode \mathcal{F}_i	Decay Topologies	Decay mode \mathcal{F}_i
$h \rightarrow 2$	$h \rightarrow \cancel{E}_T$	$h \rightarrow 2 \rightarrow 4$	$h \rightarrow (b\bar{b})(b\bar{b})$
$h \rightarrow 2 \rightarrow 3$	$h \rightarrow \gamma + \cancel{E}_T$		$h \rightarrow (b\bar{b})(\tau^+\tau^-)$
	$h \rightarrow (b\bar{b}) + \cancel{E}_T$		$h \rightarrow (b\bar{b})(\mu^+\mu^-)$
	$h \rightarrow (jj) + \cancel{E}_T$		$h \rightarrow (\tau^+\tau^-)(\tau^+\tau^-)$
	$h \rightarrow (\tau^+\tau^-) + \cancel{E}_T$		$h \rightarrow (\tau^+\tau^-)(\mu^+\mu^-)$
	$h \rightarrow (\gamma\gamma) + \cancel{E}_T$		$h \rightarrow (jj)(jj)$
	$h \rightarrow (\ell^+\ell^-) + \cancel{E}_T$		$h \rightarrow (jj)(\gamma\gamma)$
			$h \rightarrow (jj)(\mu^+\mu^-)$
$h \rightarrow 2 \rightarrow 3 \rightarrow 4$	$h \rightarrow (b\bar{b}) + \cancel{E}_T$		$h \rightarrow (\ell^+\ell^-)(\ell^+\ell^-)$
	$h \rightarrow (jj) + \cancel{E}_T$		$h \rightarrow (\ell^+\ell^-)(\mu^+\mu^-)$
	$h \rightarrow (\tau^+\tau^-) + \cancel{E}_T$		$h \rightarrow (\mu^+\mu^-)(\mu^+\mu^-)$
	$h \rightarrow (\gamma\gamma) + \cancel{E}_T$		$h \rightarrow (\gamma\gamma)(\gamma\gamma)$
	$h \rightarrow (\ell^+\ell^-) + \cancel{E}_T$		$h \rightarrow \gamma\gamma + \cancel{E}_T$
	$h \rightarrow (\mu^+\mu^-) + \cancel{E}_T$		$h \rightarrow (\ell^+\ell^-)(\ell^+\ell^-) + \cancel{E}_T$
$h \rightarrow 2 \rightarrow (1+3)$	$h \rightarrow b\bar{b} + \cancel{E}_T$	$h \rightarrow 2 \rightarrow 4 \rightarrow 6$	$h \rightarrow (\ell^+\ell^-) + \cancel{E}_T + X$
	$h \rightarrow jj + \cancel{E}_T$		$h \rightarrow \ell^+\ell^-\ell^+\ell^- + \cancel{E}_T$
	$h \rightarrow \tau^+\tau^- + \cancel{E}_T$		$h \rightarrow \ell^+\ell^- + \cancel{E}_T + X$
	$h \rightarrow \gamma\gamma + \cancel{E}_T$	$h \rightarrow 2 \rightarrow 6$	
	$h \rightarrow \ell^+\ell^- + \cancel{E}_T$		

LHC's strength
Hard at LHC due to missing energy
Hard at LHC due to hadronic background
Lepton colliders' strength

Exotics/Long Lived Particles.

Z. Liu @ CEPC 2020

The Higgs could be a good portal to Dark Sector
— rich exotic signatures —

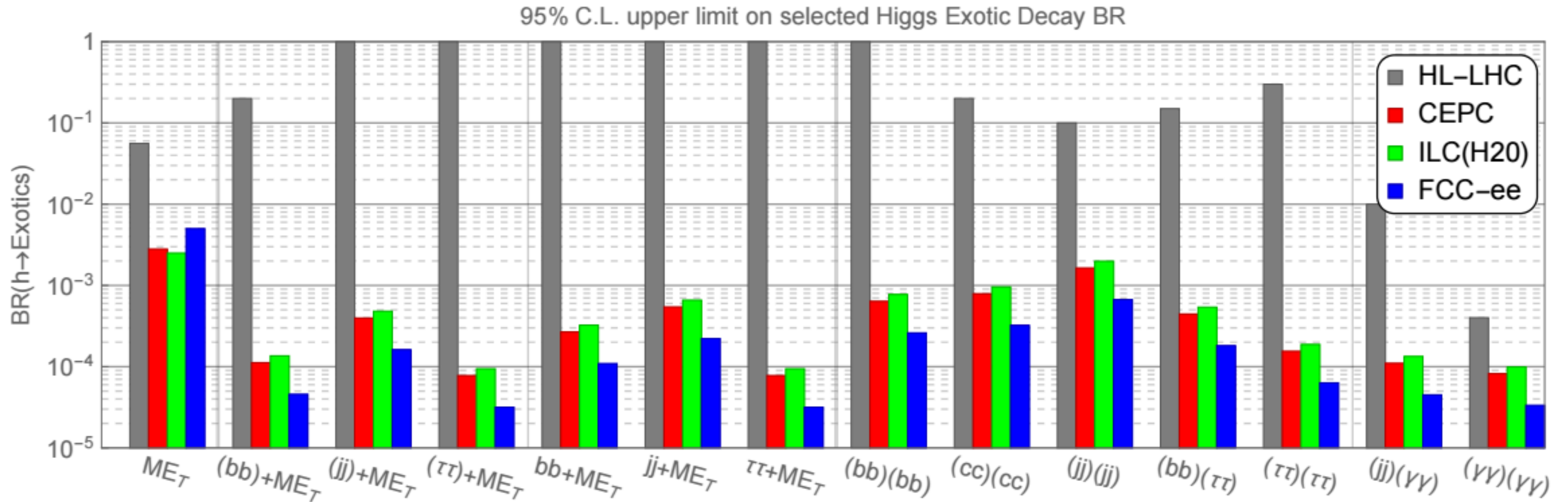

How to improve?

> Dedicated detectors, see e.g. talk by [R. Gonzalez Suarez @ FCC week 2021](#)

Cost of Operation

Energy and carbon footprint.

FCC-ee total instantaneous power demand at each centre-of-mass energies

J.-P. Burnet, FCC Week'22

		Z	W	H	TT	
Beam energy (GeV)		45.6	80	120	182.5	
Magnet current		25%	44%	66%	100%	
Power ratio		6%	19%	43%	100%	
PRF EL (MW)	Storage	146	146	146	146	← Ongoing R&D
PRFb EL (MW)	Booster	2	2	2	2	
Pcryo (MW)	all	1,3	12,6	15,8	47,5	← Ongoing R&D
Pcv (MW)	all	33	34	36	40.2	
PEL magnets (MW)	Stroage	6	17	39	89	↓ Potential energy savings
PEL magnets (MW)	Booster	1	3	5	11	
Experiments (MW)	Pt A & G	8	8	8	8	
Data centers (MW)	Pt A & G	4	4	4	4	
General services (MW)		36	36	36	36	
Power during beam operation (MW)		237	262	291	384	

◆ At 240 GeV, the instantaneous power of FCC-ee amounts to 291 MW

● As a comparison, $P(\text{ILC}_{250})=140$ MW, $P(\text{CLIC}_{380})=110$ MW : less power hungry than FCC-ee?

➔ Not clear: both produce (2 to 4 times) less Higgs than FCC-ee_{240} , with (3 to 6 times) longer running time

Energy and carbon footprint.

- **Our first responsibility (as particle physicists) is to do the maximum of science**
 - ◆ **With the minimal energy consumption and the minimal environmental impact for our planet**
 - Should become one of our top-level decision criteria for design, choice and optimization of a collider
- **All Higgs factories have a “similar” physics outcome (ESU’20 and Snowmass’21)**
 - ◆ **Natural question: what is their energy consumption or carbon footprint for the same physics outcome?**
 - Circular colliders have a much larger instantaneous luminosity and operate several detectors
 - FCC-ee is at CERN, where electricity is already almost carbon-free (and will be even more so in 2048)

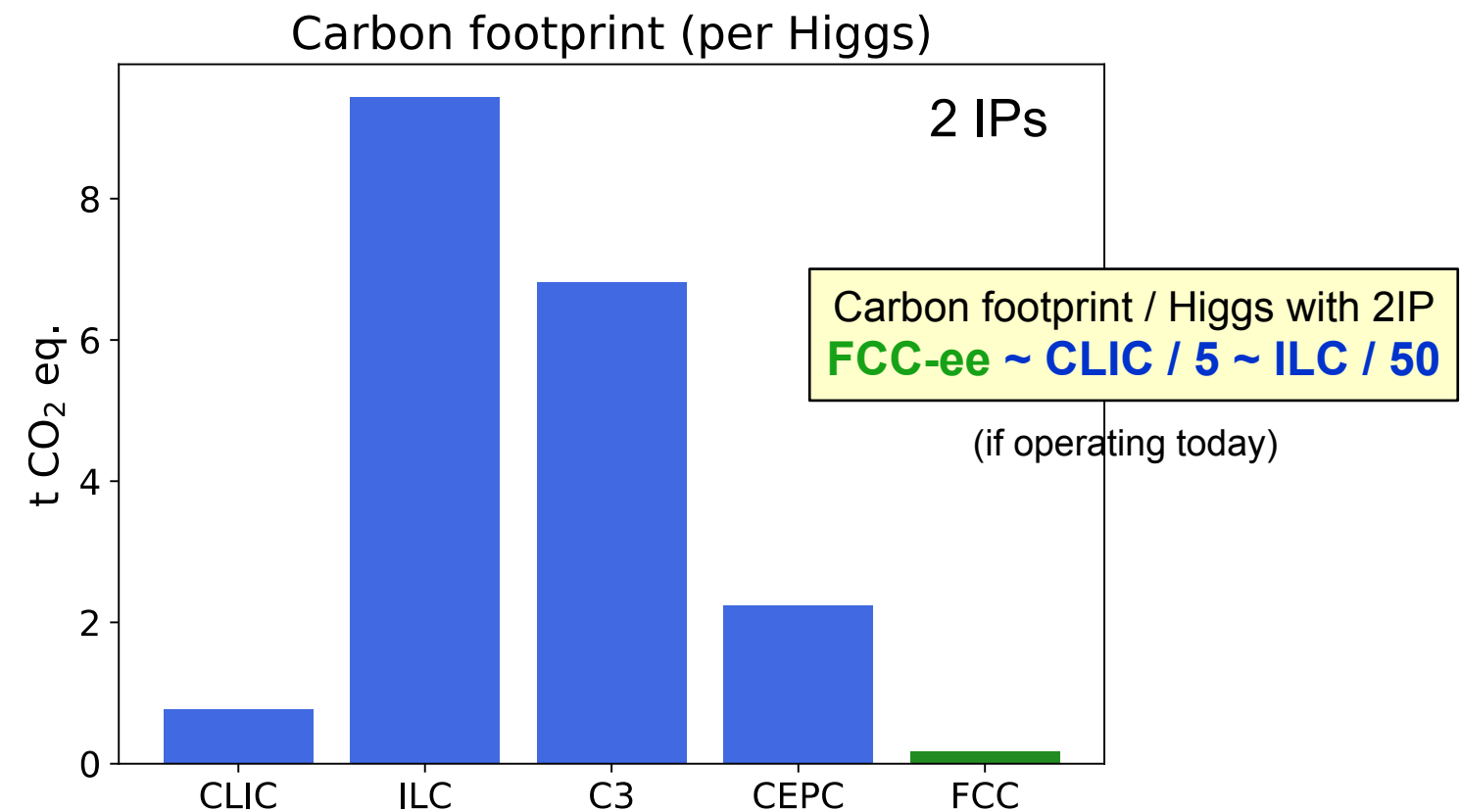
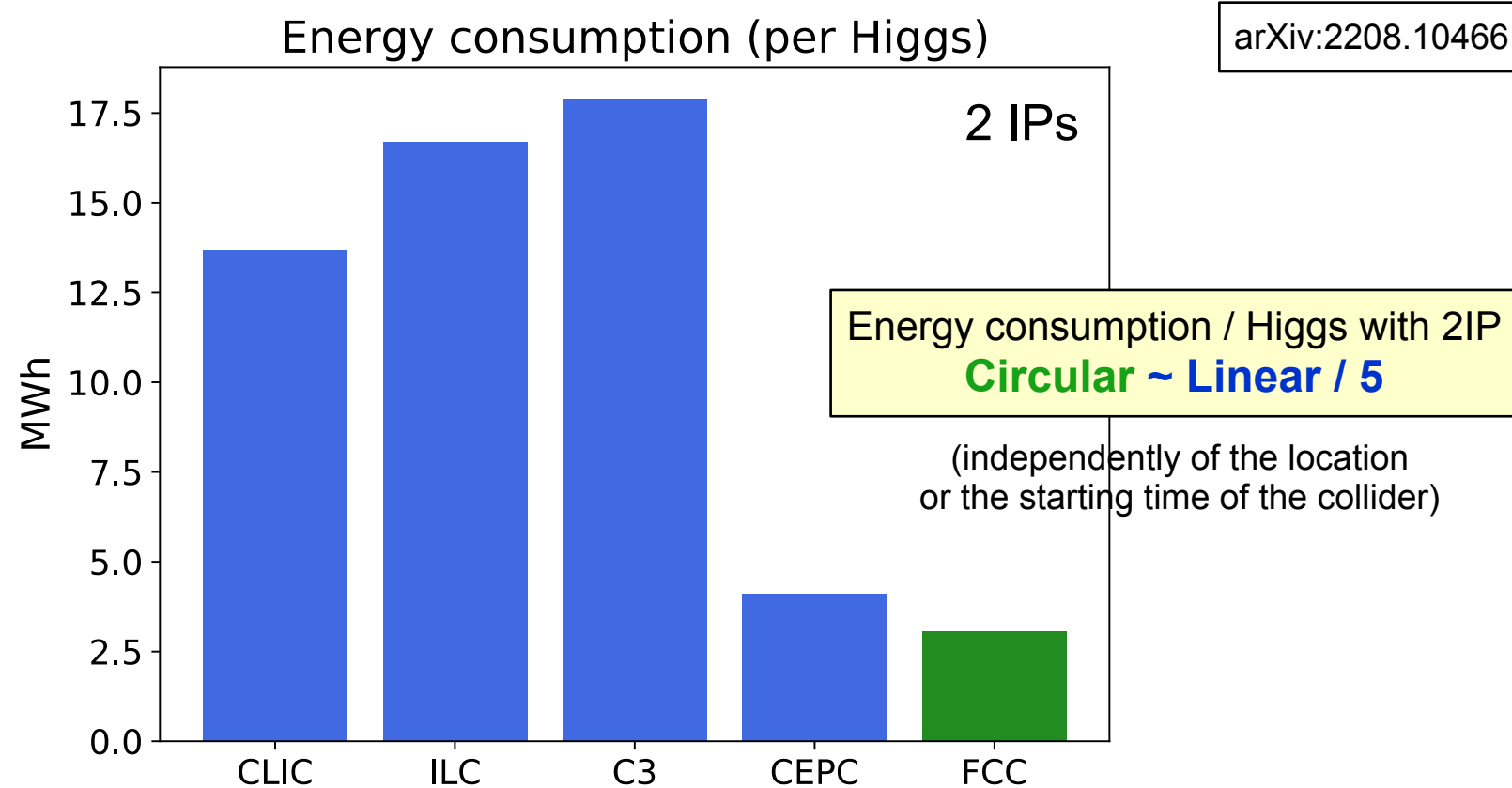

Cost of Operation.

The total electrical energy consumption over the fourteen years of the FCC-ee research programme is estimated to be around 27 TWh [58], corresponding to an average electricity consumption of 1.9 TWh/year over the entire operation programme, to be compared with the 1.2 TWh/year consumed by CERN today and the expected 1.4 TWh/year for HL-LHC⁹. At the CERN electricity prices from 2014/15, the electricity cost for FCC-ee collider operation would be about 85 MEuro per year. In the HZ running mode, about one million Higgs bosons are expected to be produced in three years, which sets the price of each FCC-ee Higgs boson at 255 Euros. A similar exercise can be done for the first stage of CLIC, expected to consume 0.8 TWh/year over 8 years at 380 GeV to produce about 150,000 Higgs bosons, which sets the price of a CLIC Higgs boson at about 2000 Euros. Finally, with the official ILC operation cost in Japan of 330 MEuro per year [10], its 11.5 to 18.5 years of operation (Section 5), and the 500,000 Higgs bosons produced in total, the price of an ILC Higgs boson is between 7,000 and 12,000 Euros, i.e., between 30 and 50 times more expensive than at FCC-ee. These operation costs are summarized in Table 8.

Table 8: Operation costs of low-energy Higgs factories, expressed in Euros per Higgs boson.

Collider	ILC ₂₅₀	CLIC ₃₈₀	FCC-ee ₂₄₀
Cost (Euros/Higgs)	7,000 to 12,000	2,000	255