



Timing RPCs: 25 years

P. Fonte

Department of Radiation Oncology, Yonsei Cancer Center, Heavy Ion Therapy Research Institute, Yonsei University College of Medicine, Seoul, Republic of Korea

Coimbra Institute of Engineering, Polytechnic University of Coimbra, Portugal

LIP - Laboratory of Instrumentation and Experimental Particle Physics, Coimbra, Portugal

Outlook

The early (good old) days

tRPCs in the world

tRPC physics: what is done and what remains to be done

ALICE TOF requirements

Requirements (ALICE TDP CERN/LHCC/95-71):

~150 m² area

granularity (determined by occupancy) ~9 cm² (160000 channels)

system time resolution <= 100 ps

Existing (and discarded by 1998) technologies

Plastic scintillators + PMs

NA49 TOF @ SPS

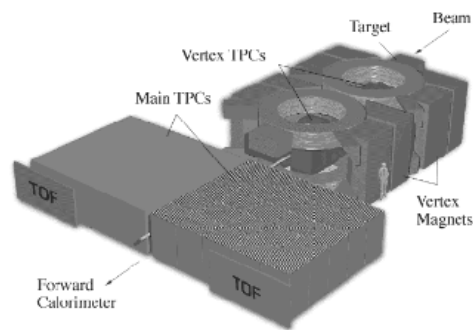

- 4 m²
- 1800 channels
- readout: TDCs + ADCs
- 60 ps resolution

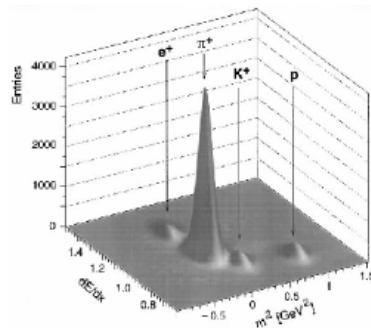
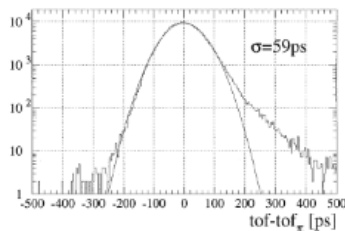

The Pestov spark counter

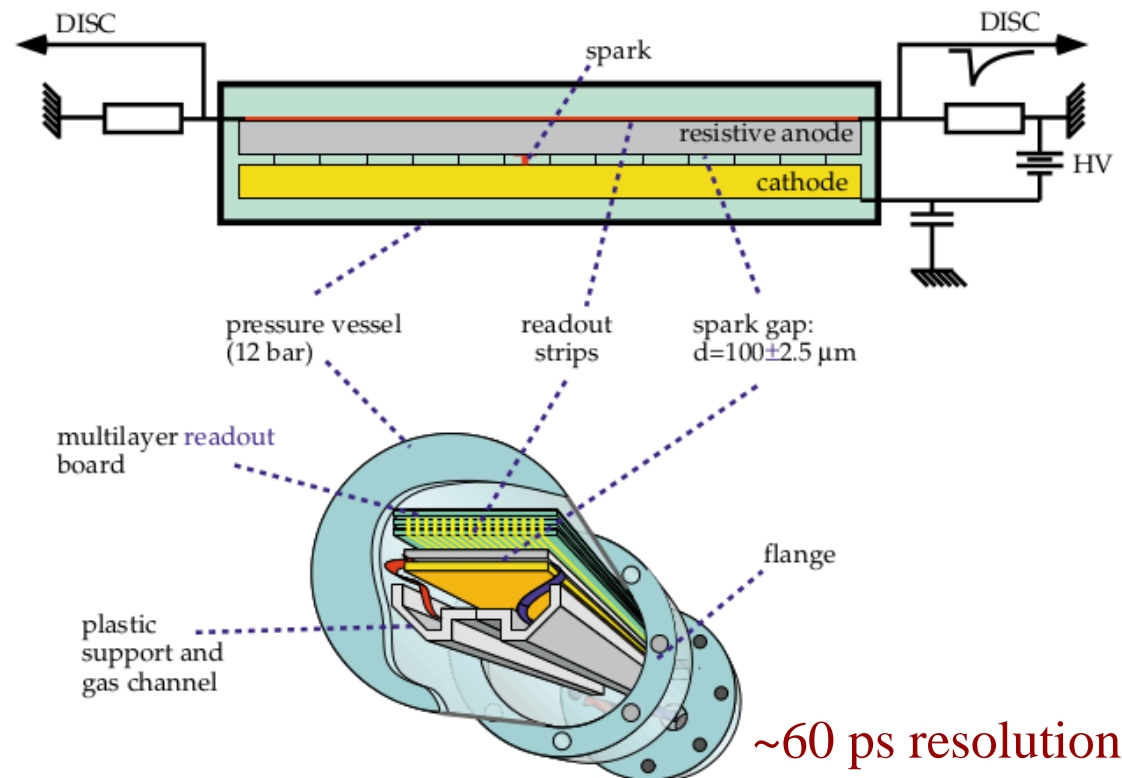

~60 ps resolution

Didn't require fast amplifiers

ALICE TOF candidate technologies (autumn 1998 – spring 1999)

- Parallel Plate Chamber (PPC)
Being studied for calorimetry since the early 1990s' mainly by the ITEP group. This was the baseline solution and had been under development for a long time (see V.A.Akimov et al., Instrum. and Exp. Tech. 45:4 (2002) 493)
Time resolution ~200 ps (already a big step forward). Prone to sparking...
- Melamine or glass multigap RPC (MRPC)
Based on the muon trigger RPCs that were being studied by the LAA group for ATLAS/CMS since 1996.
- Metal-glass symmetric multigap RPC
Proposed by the Coimbra group. Inspired by the Pestov spark counter and by both detectors mentioned above.

There were two beamtimes: autumn 1998 and spring 1999.

The spring 1999 beamtime was supposed to demonstrate the “1m²” prototype as the final step for the elaboration of the TOF TDR, which was due in July 1999.

The ALICE TOF R&D effort was coordinated by François Piuz and Wolfgang Klempt.

Double PPC

Autumn 1998

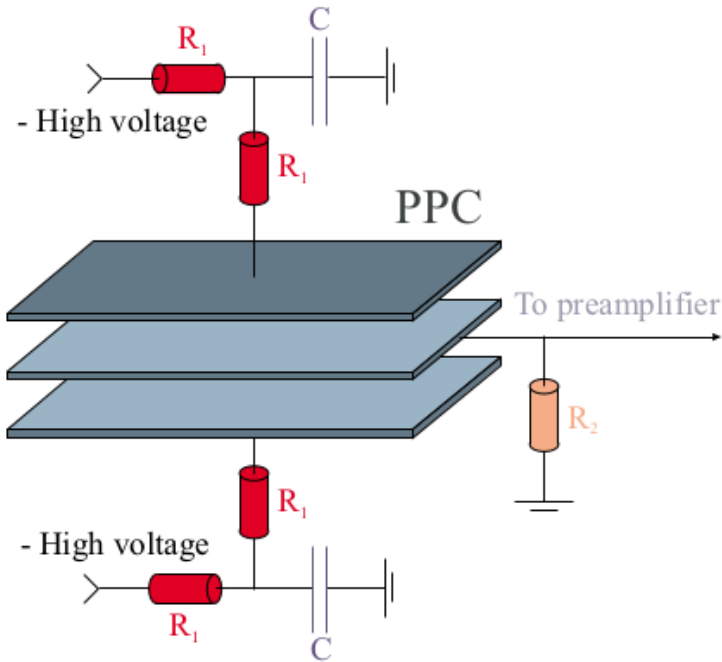

Spring 1999

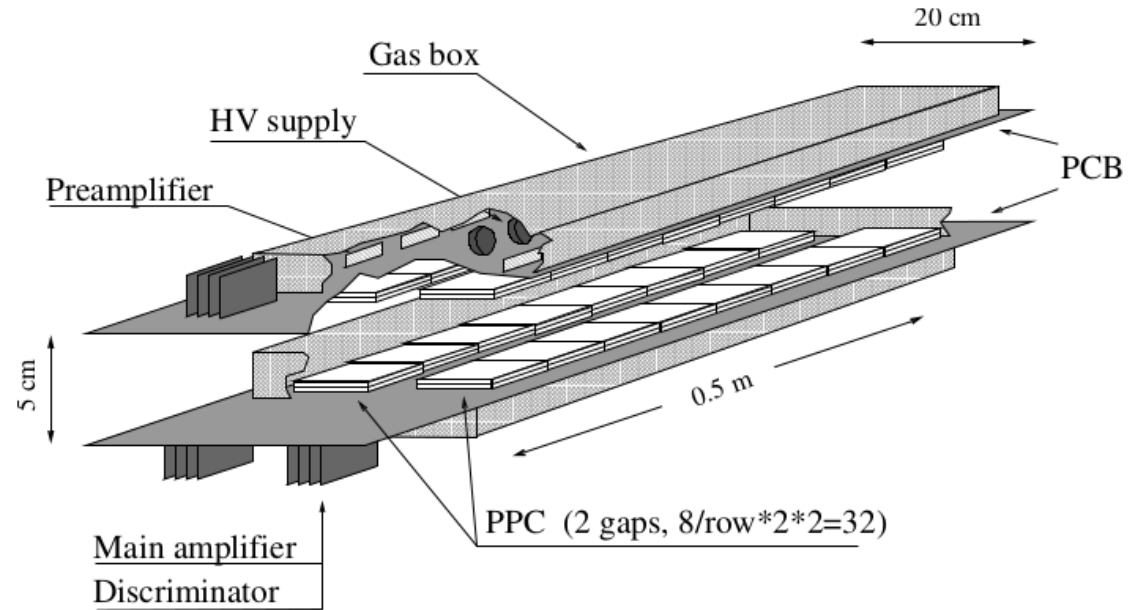
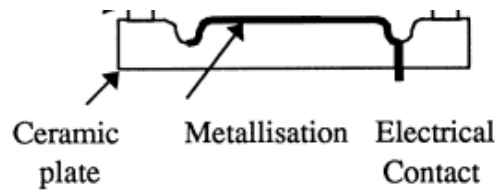

Figure 2.21: 32-channel TOF module.

Chromium-coated ceramic plates

32 channels prototype



Melamine/glass MRPC

Autumn 1998

Spring 1999

(a) 5 gaps of 340 μm MRPC

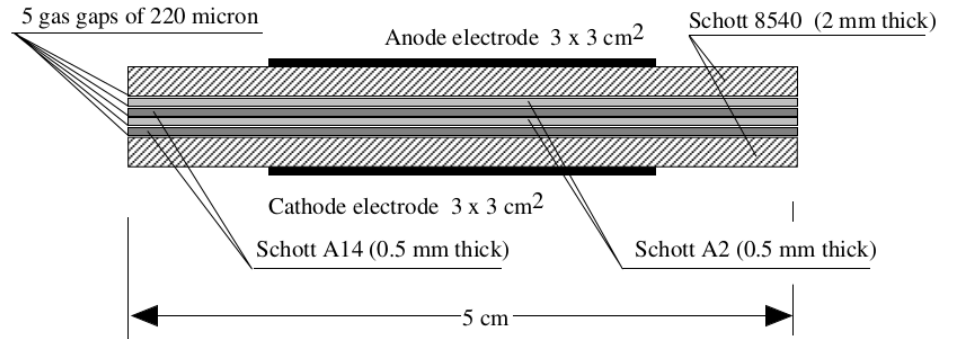
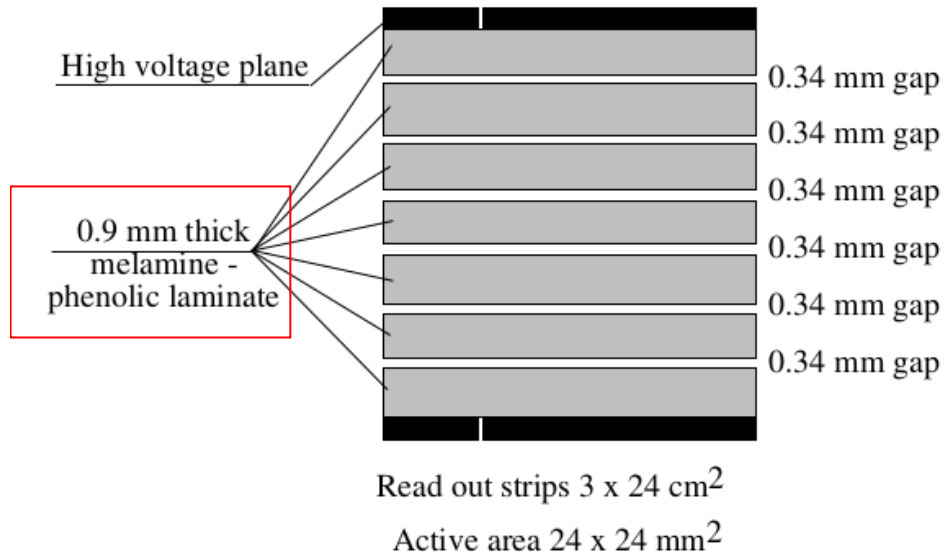

Single-channel glass MRPC

Metal-glass symmetric MRPC

Autumn 1998

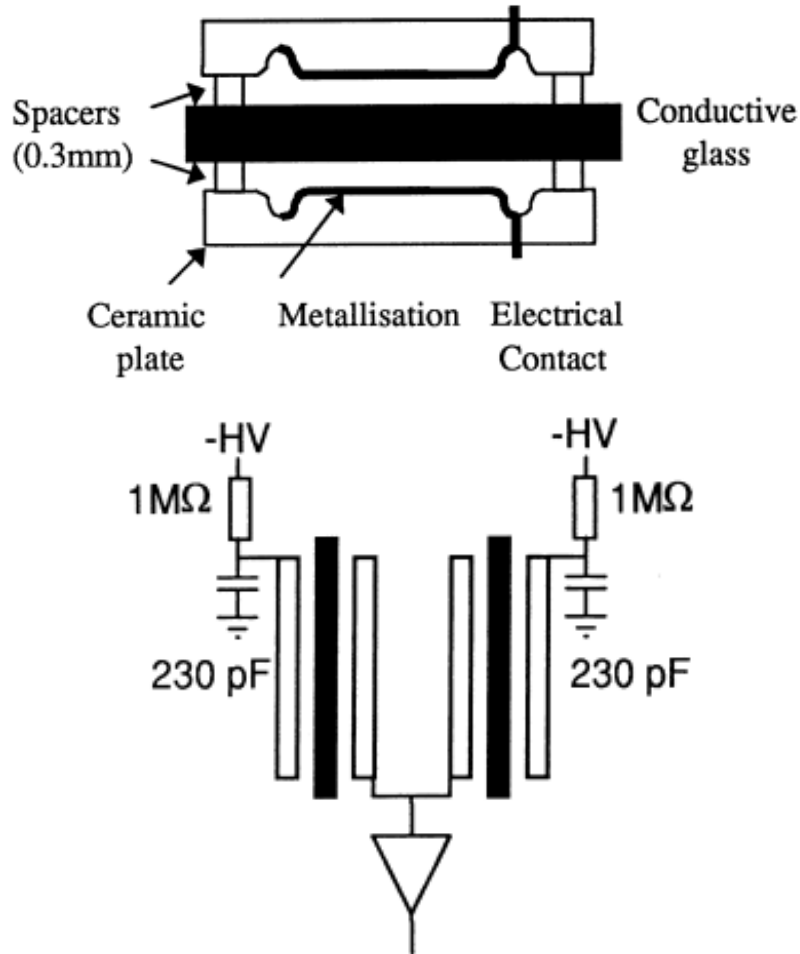

The metal plates were borrowed from the ceramic PPCs.

Spring 1999



32 channels prototype

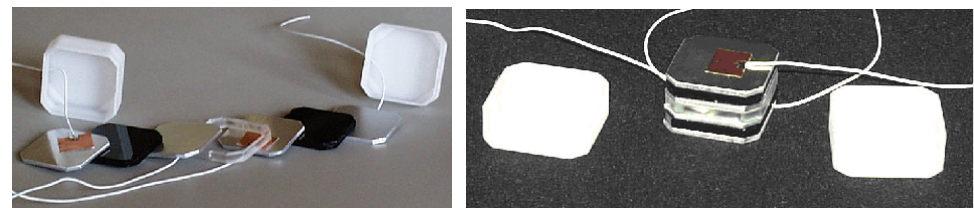
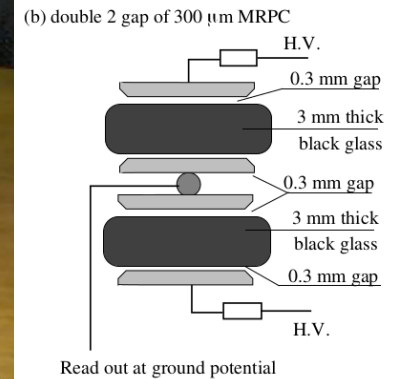

Designed to allow to place shielding between the cells to minimize crosstalk.

New dedicated electronics was produced.

A CERN/Coimbra/ITEP collaboration

Results of the autumn 1998 beamtime

Nuclear Instruments and Methods in Physics Research A 443 (2000) 201–204

Letter to the Editor

A new high-resolution TOF technology

P. Fonte^{a,b,*,1}, A. Smirnitski^c, M.C.S. Williams^{a,d}

^aCERN, EP Division, 1211 Geneva 23, Switzerland

^bLIP-Coimbra, Coimbra, Portugal

^cITEP, Moscow, Russia

^dINFN Bologna, Bologna, Italy

Received 24 March 1999; received in revised form 27 August 1999; accepted 2 September 1999

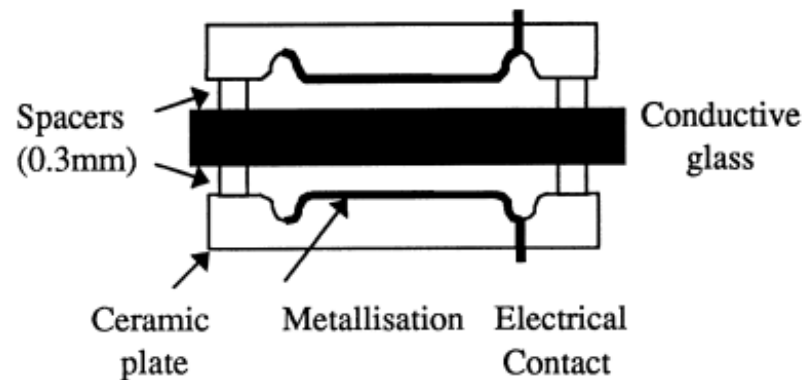

The following colleagues, from our home institutes, contributed to this work: A. Akindinov, E. Cerron-Zeballos, R. Ferreira-Marques, V. Golovine, D. Hatzifotiadou, J. Lamas-Valverde, A. Martemianov, V. Petrov, F. Piuz, A. Policarpo, K. Voloshin.

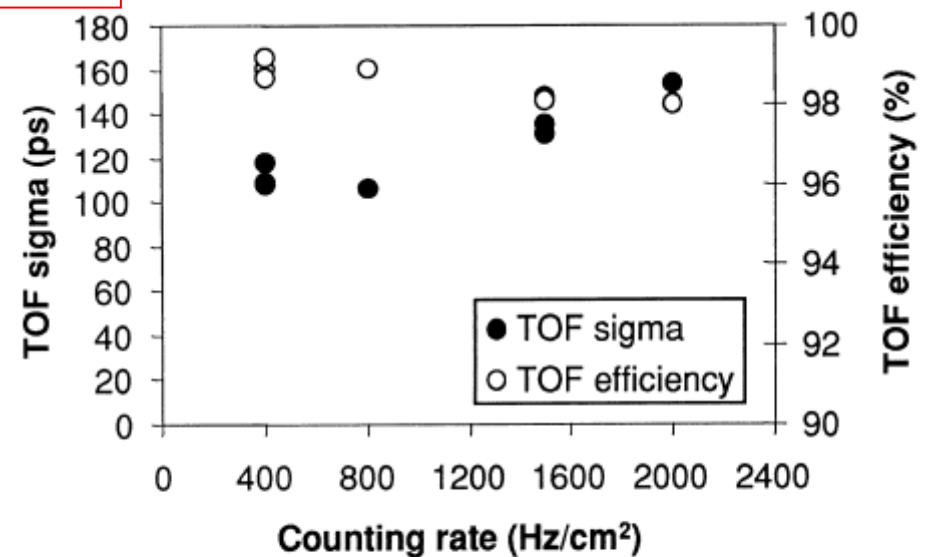

Fig. 5. Timing resolution and efficiency as a function of the counting rate per unit area. For counting rates below 800 Hz/cm² a resolution better than 120 ps sigma was achieved with efficiency above 98%.

Results of the spring 1999 beamtime

EUROPEAN LABORATORY FOR PARTICLE PHYSICS (CERN)

CERN-EP 99-166
28 October 1999

A four-gap glass-RPC time-of-flight array with 90 ps time resolution

A. Akindinov¹, P. Fonte^{2,3,*}, F. Formenti², V. Golovine¹, W. Klempt², A. Kluge²,
A. Martemiyarov¹, P. Martinengo², J. Pinhão³, A. Smirnitski¹,
M. Spiegel^{2,‡}, P. Szymanski^{2,4}, J. Zalipska^{2,5}

¹*ITEP, Moscow, Russian Federation*, ²*CERN, Geneva, Switzerland*, ³*LIP, Coimbra, Portugal*,
⁴*Inst. for Nuclear Studies, Warsaw, Poland*, ⁵*Univ. of Warsaw, Warsaw, Poland*

* *On leave of absence from ISEC, Coimbra, Portugal*

‡ *corresponding author, Marko.Spiegel@cern.ch*

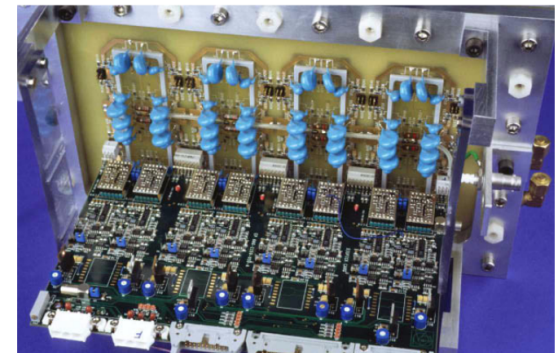
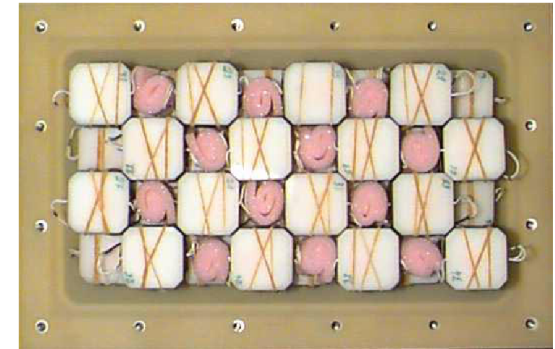
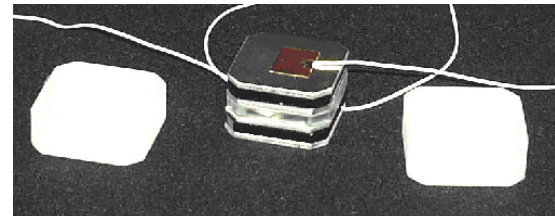
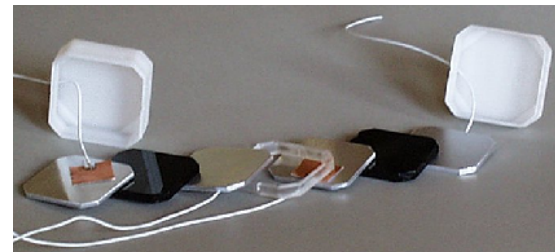
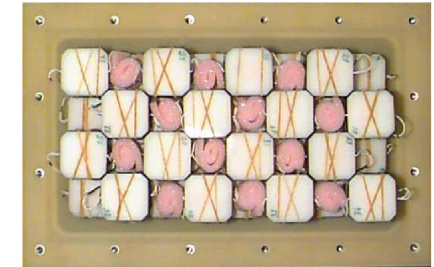
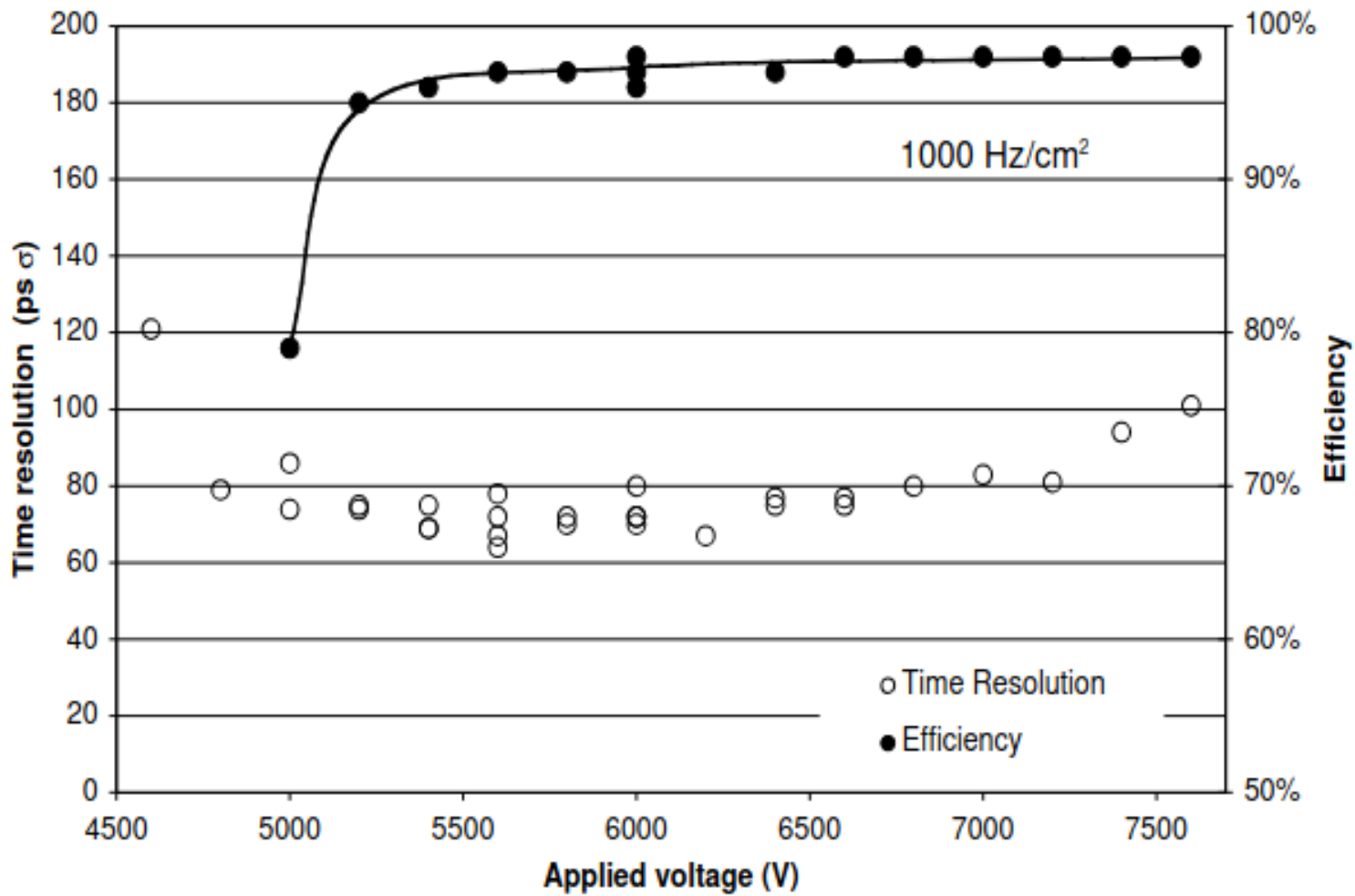

Figure 5: One eight-channel prototype readout card mounted on the prototype. The card carries amplifiers made with discrete components, discrimination logics and voltage regulation.



Results of the spring 1999 beamtime



Results of the spring 1999 beamtime

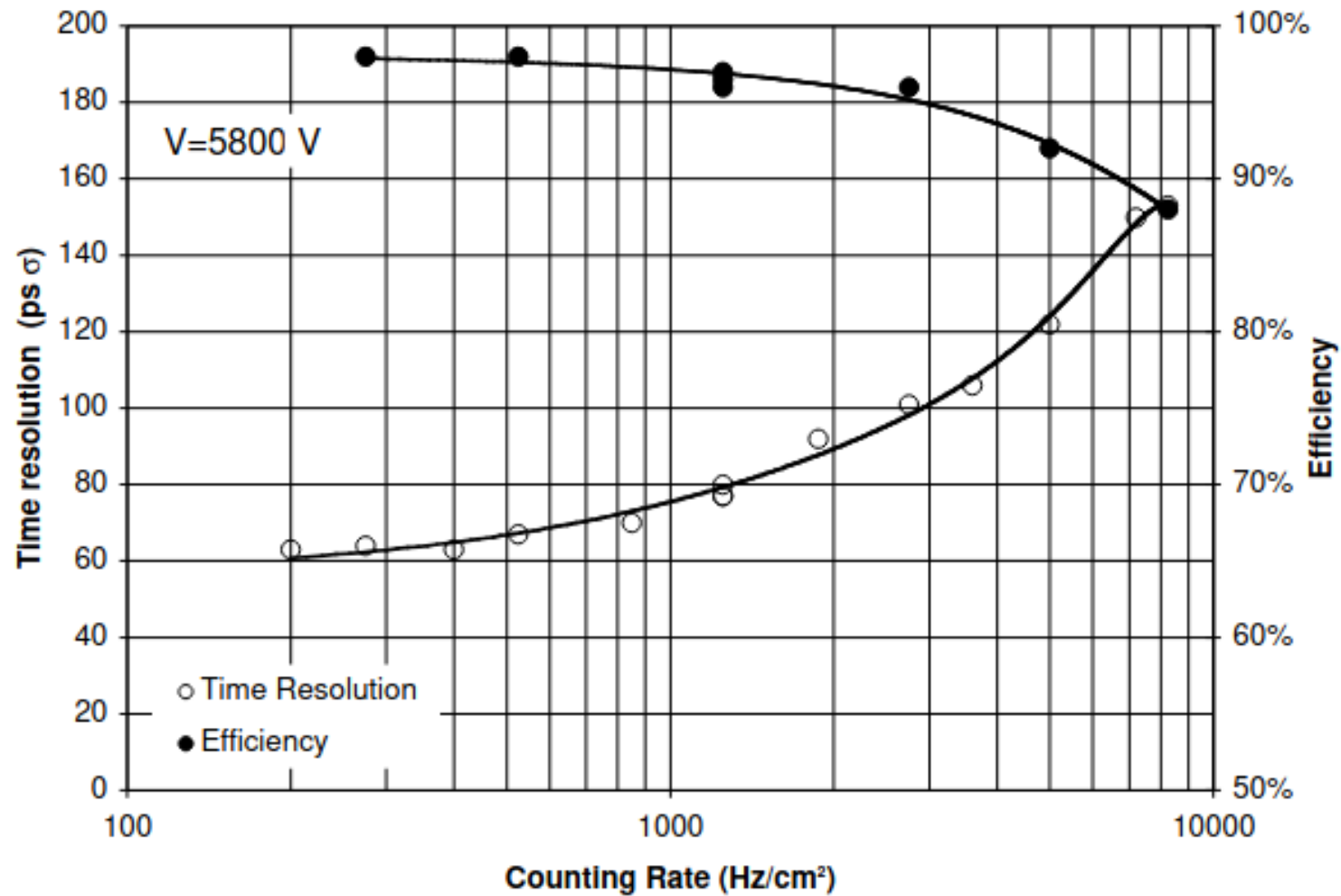

Results of the spring 1999 beamtime

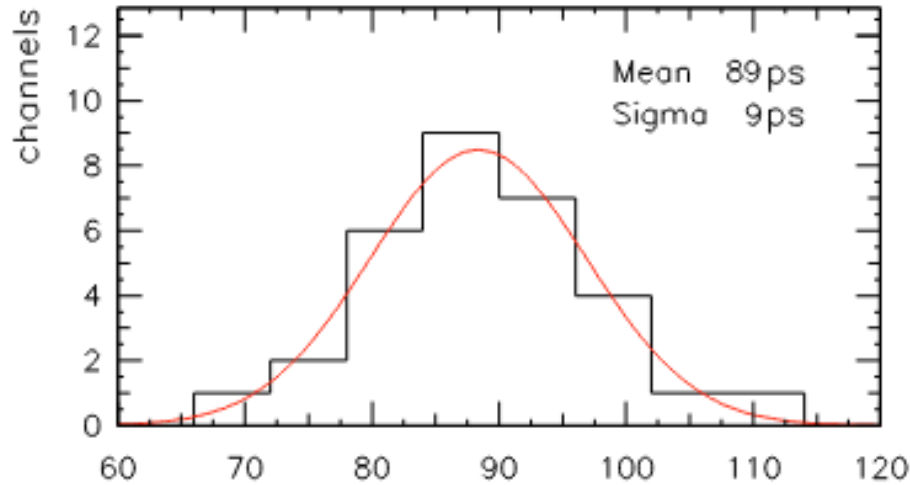
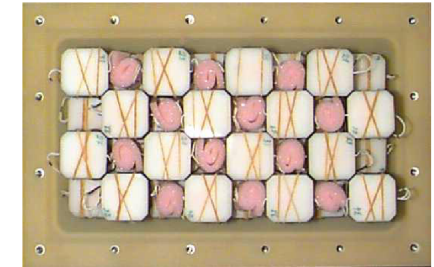

A surprising but resounding success!

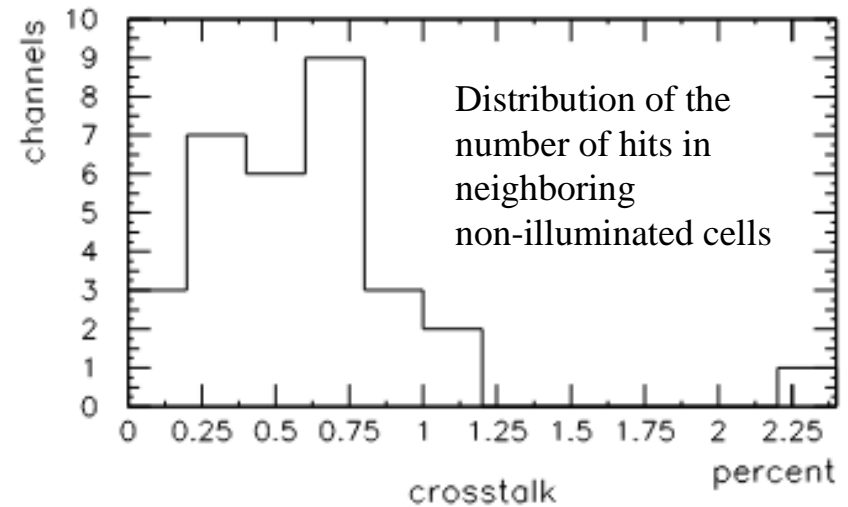
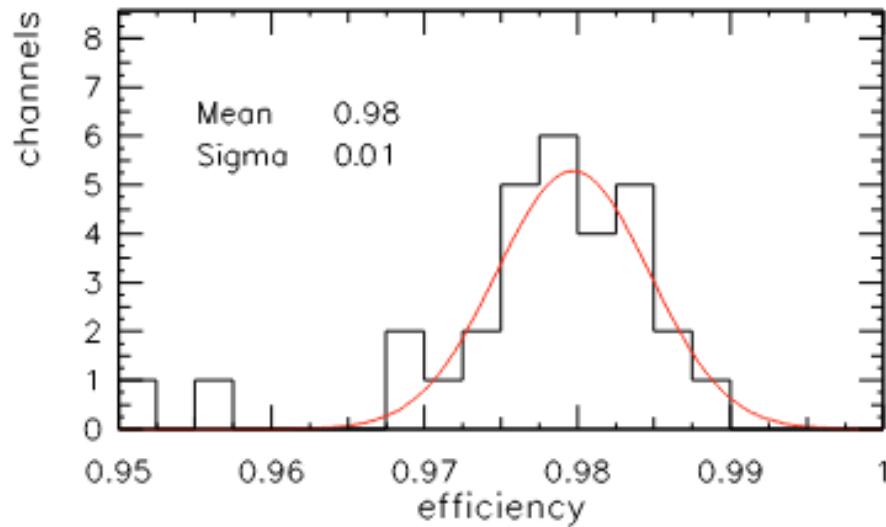

Results of the spring 1999 beamtime

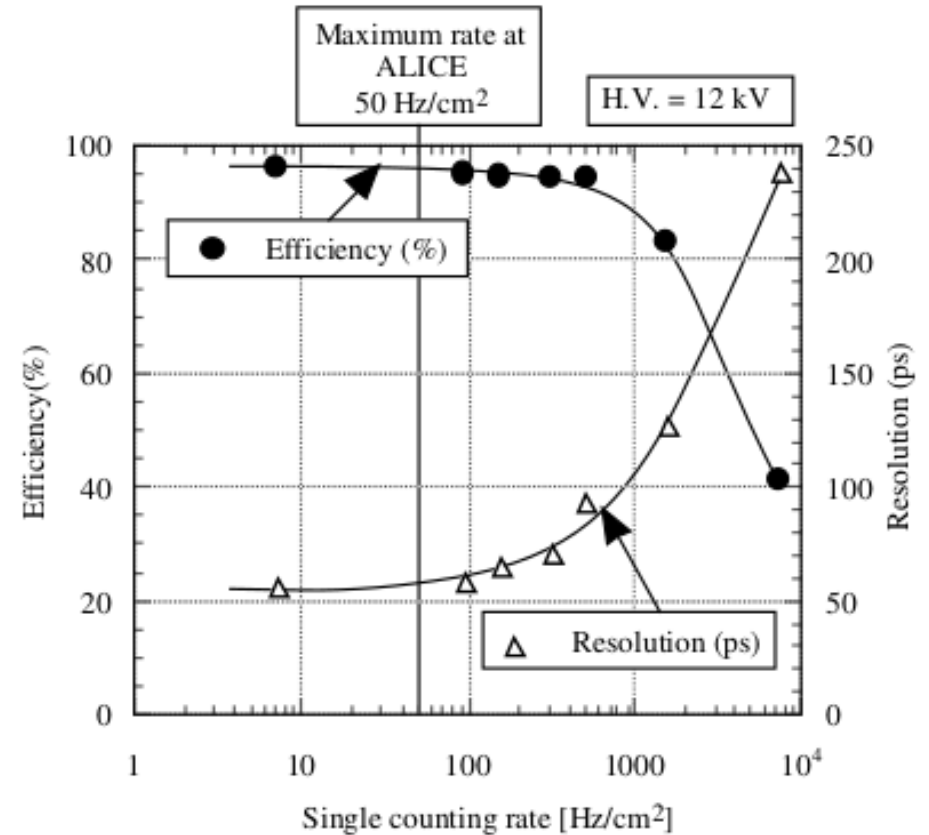
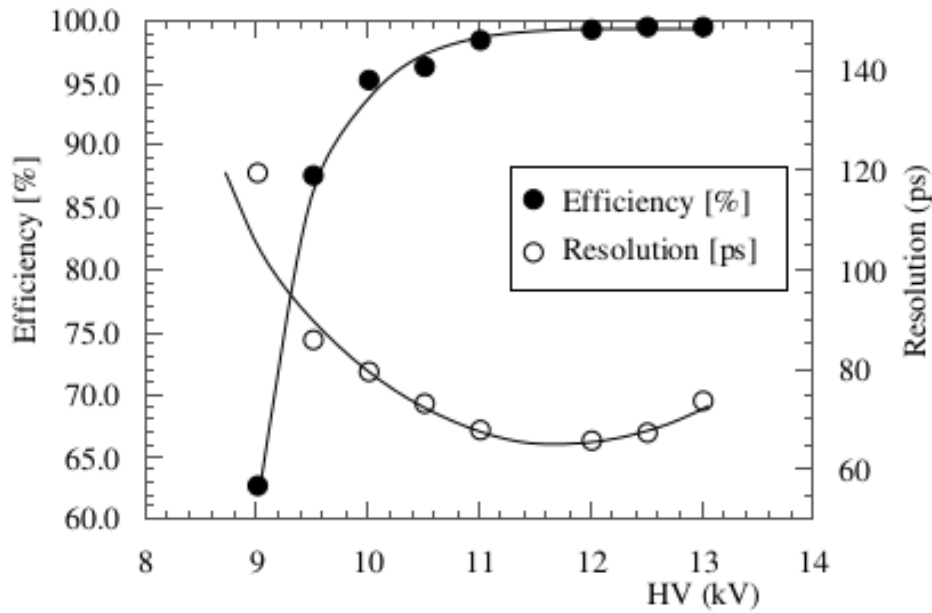
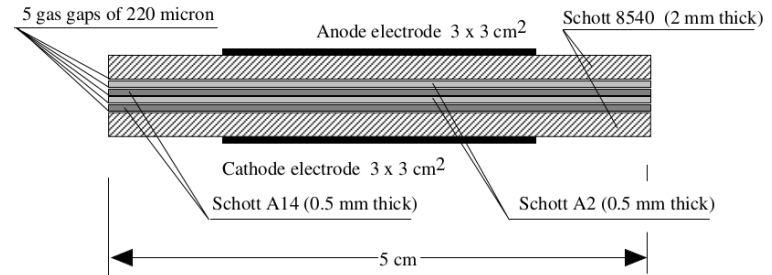
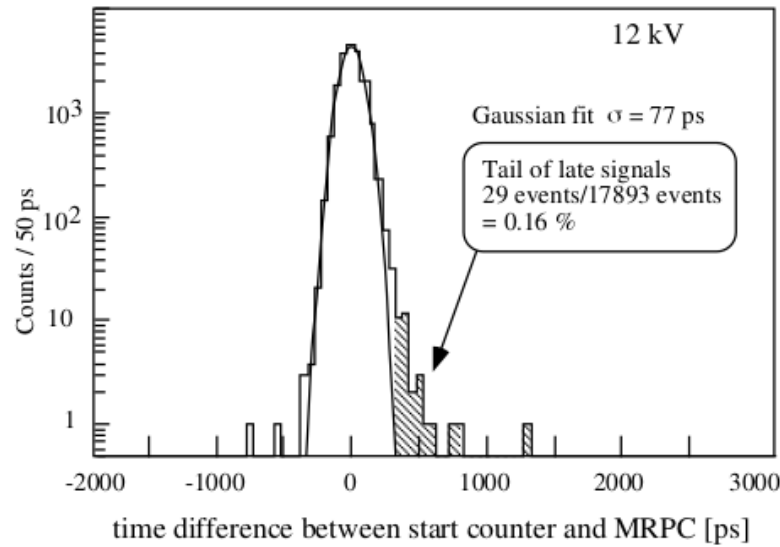

Results of the spring 1999 beamtime

*a**b**c*

Figure 2.21: 32-channel TOF module.

Figure 2.23: TOF module test results (10 PPCs shown):

a — TOF resolutions;

b — efficiency plateau widths;

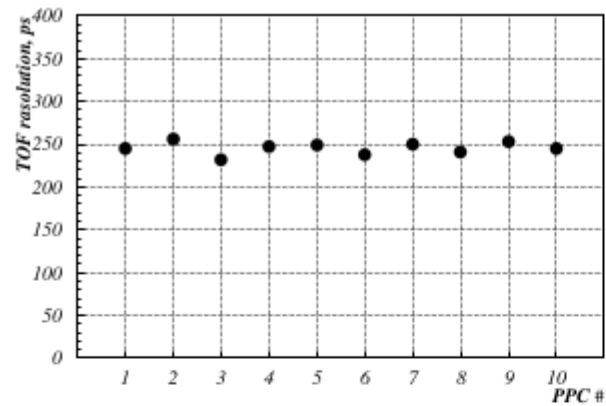
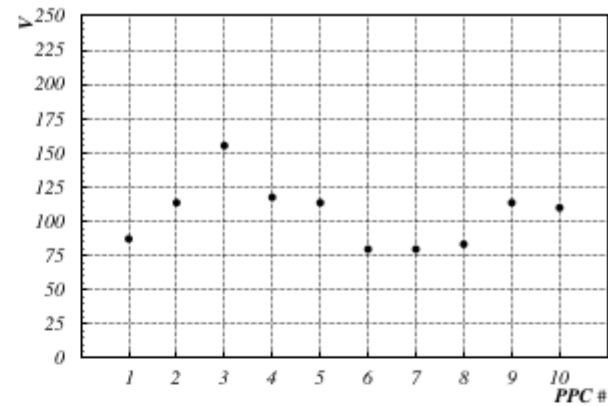
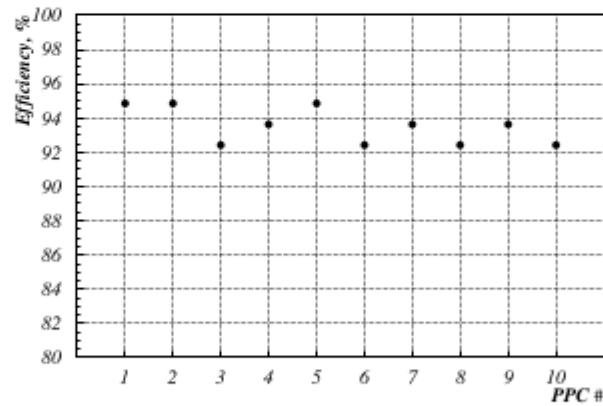
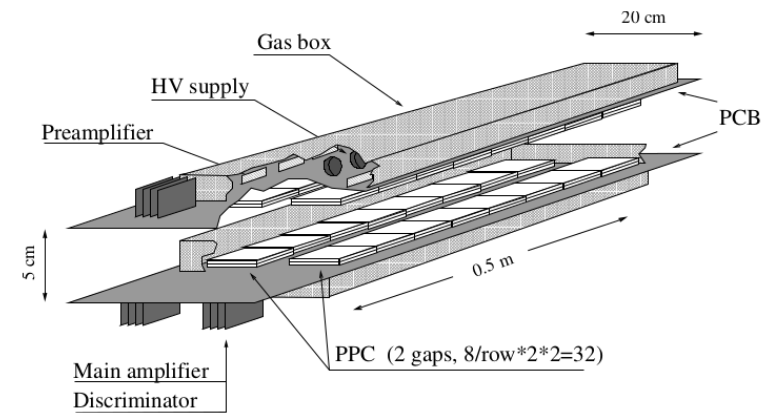
c — efficiencies in the plateau centres.

Results of the spring 1999 beamtime

Nuclear Instruments and Methods in Physics Research A 449 (2000) 295–301

High-resolution RPCs for large TOF systems

P. Fonte^{a,b,*}, R. Ferreira Marques^{b,c}, J. Pinhão^b, N. Carolino^b, A. Policarpo^{b,c}

^aCERN, European Laboratory for Particle Physics, CH-1211 Geneve 23, Switzerland

^bLIP, Laboratório de Instrumentação e Física Experimental de Partículas, 3004-516 Coimbra, Portugal

^cDepartamento de Física da Universidade de Coimbra, 3004-516 Coimbra, Portugal

Received 31 August 1999; accepted 17 December 1999

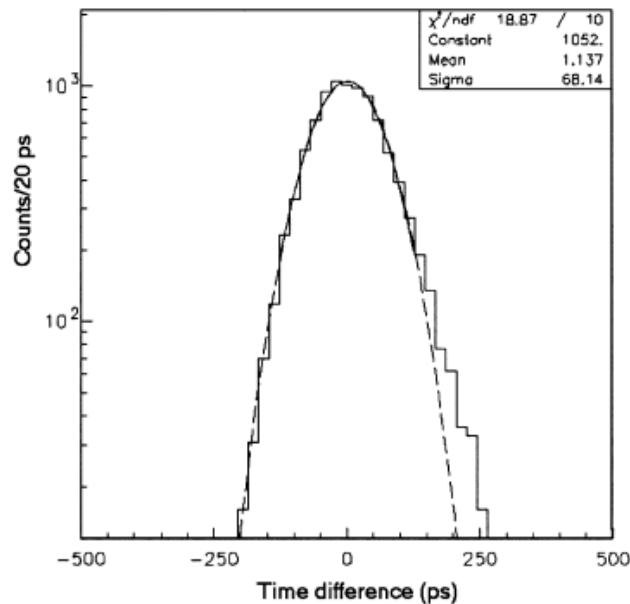
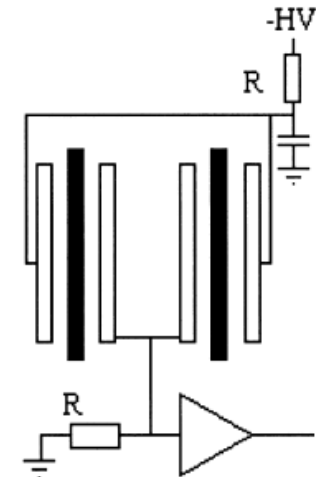
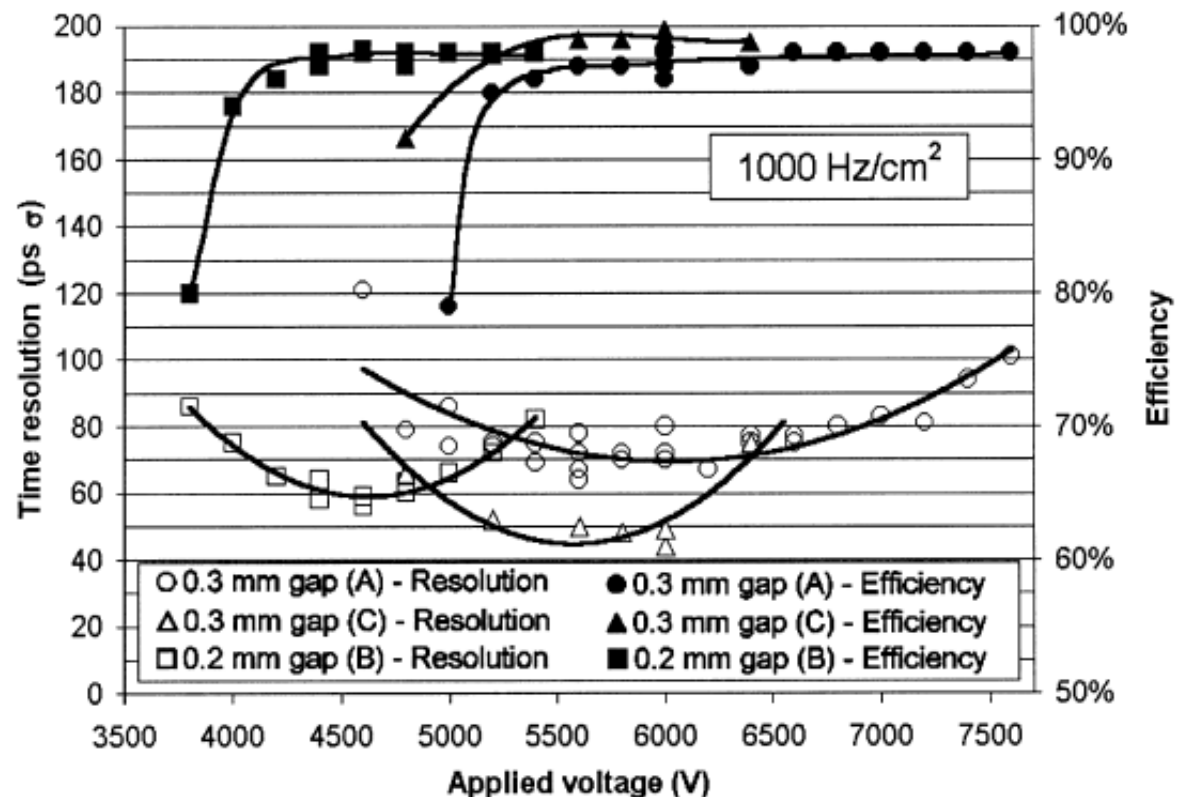

Fig. 6. Distribution of the time difference between chamber C and the T1 counter, showing a width of 68 ps σ . After quadratic subtraction of the estimated resolution of the T1 counter one gets a resolution of $\sqrt{68^2 - 49^2} = 47$ ps σ for the RPC. The counting rate during the spill was 500 Hz/cm² and the applied voltage 5800 V.



Results of the spring 1999 beamtime

(study of single gaps)

P.Fonte

Recent developments in very high time resolution RPCs

CERN 1999

RECENT DEVELOPMENTS IN VERY HIGH TIME RESOLUTION RPCs

Event by event ratio of fast/total charge (fast charge= electron component)

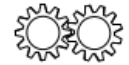

P. Fonte
CERN-EP
and
LIP-Coimbra, Portugal

EP Detector Seminar
CERN 27/9/99

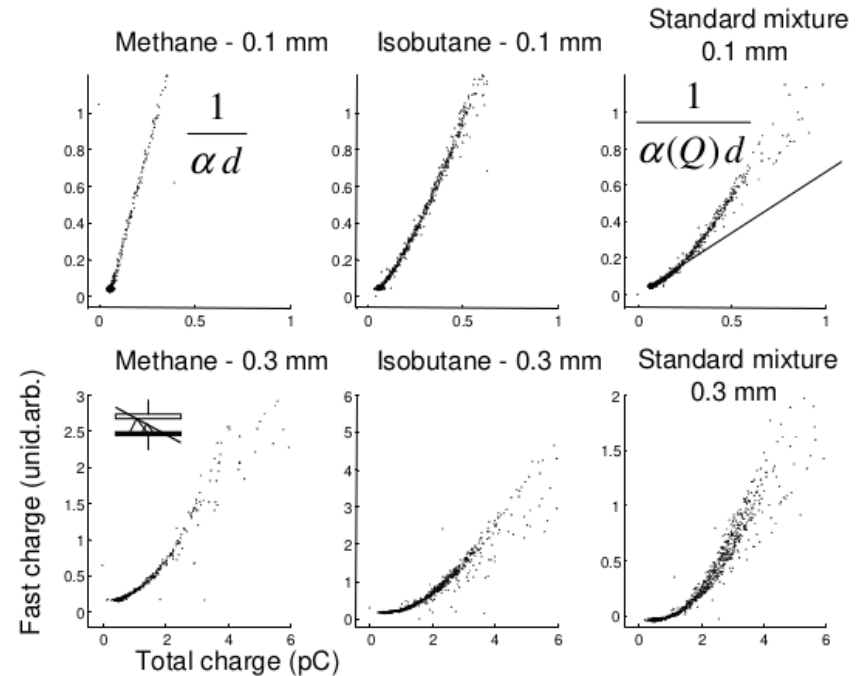

Fast charge vs. Total charge

- Electronic charge/total charge should be a constant $[1/(\alpha d)]$ but for most mixtures (except methane in a 0.1 mm gap) there is a strong non-linearity \Rightarrow space-charge effect.

Later published as

P. Fonte, V. Peskov. NIM A 477 (2002) 17

ALICE TOF 2x8 pads MRPC prototype

Strip design of MRPC tested in November 1999

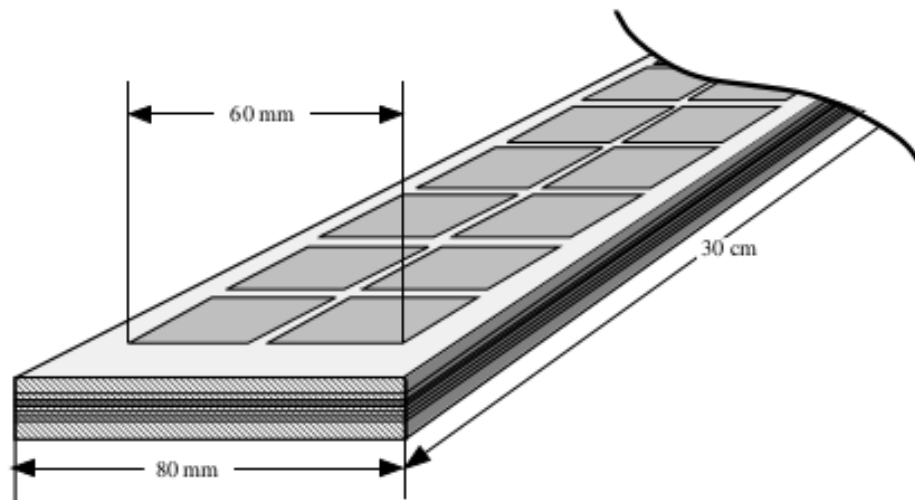

Figure 2.48: Artist's view of strip detector used in the November 1999 test beam.

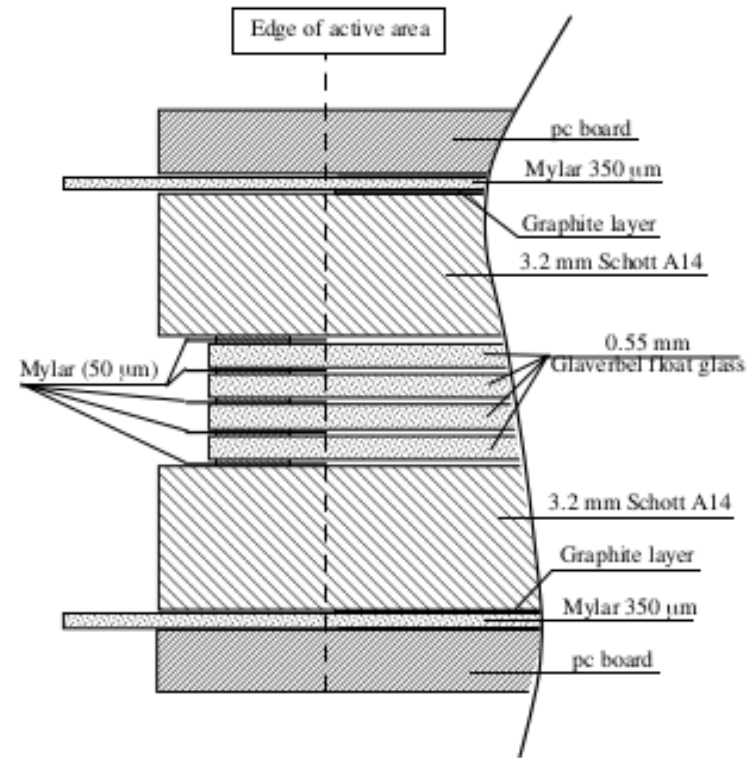

Figure 2.49: Cross section of the strip detector used in the November 1999 test beam.

8x2 cell strip detector 12.5 kV

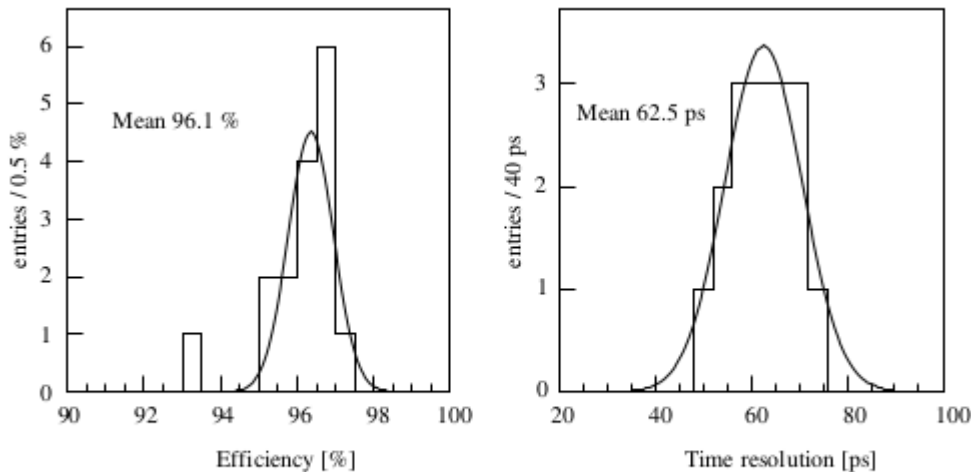

Figure 2.52: Efficiency and resolution of the 16 cells of the strip chamber.

Crosstalk not measured
Final ALICE TOF design was symmetric double-stack

The HARP experiment

The first experiment to use timing RPCs.

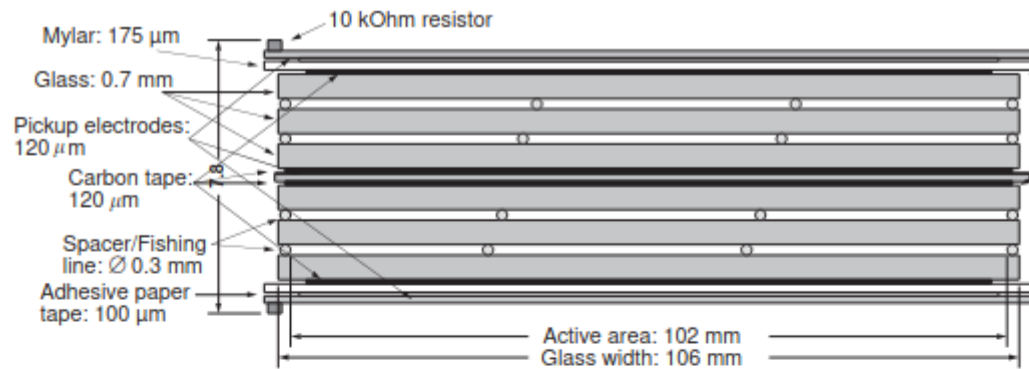

Fig. 3. Cross-section through the glass stack.

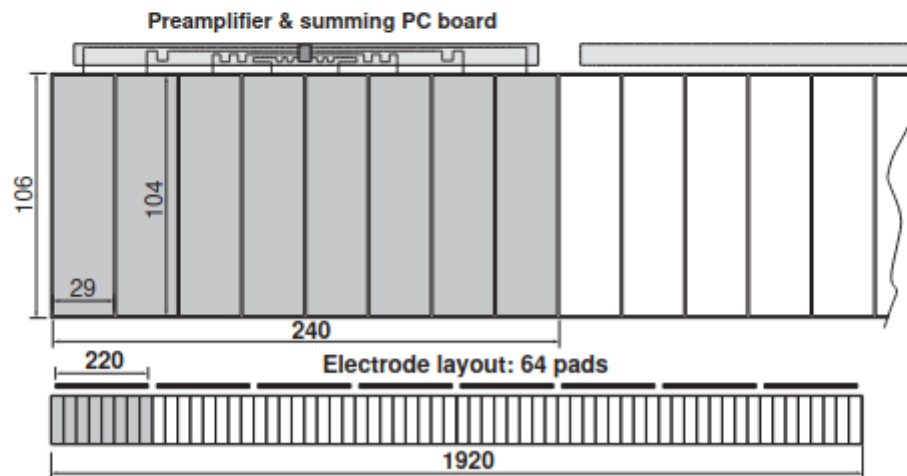

Fig. 4. Layout of the readout electrodes; eight pads are connected to the same preamplifier

Symmetric double-gap MRPCs

4 × 0.3 mm gaps

All electrodes glass

368 pads of 29×106 mm² = 30.7 cm²
readout on one side only

Total area ~6 m²

Built in 5 months from December 2000!

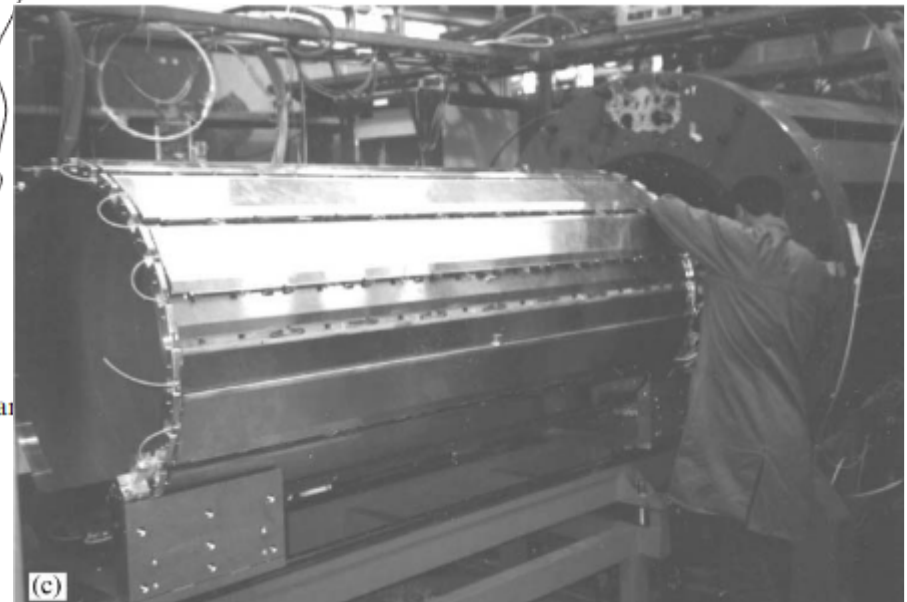

The HARP experiment

The first experiment to use timing RPCs.

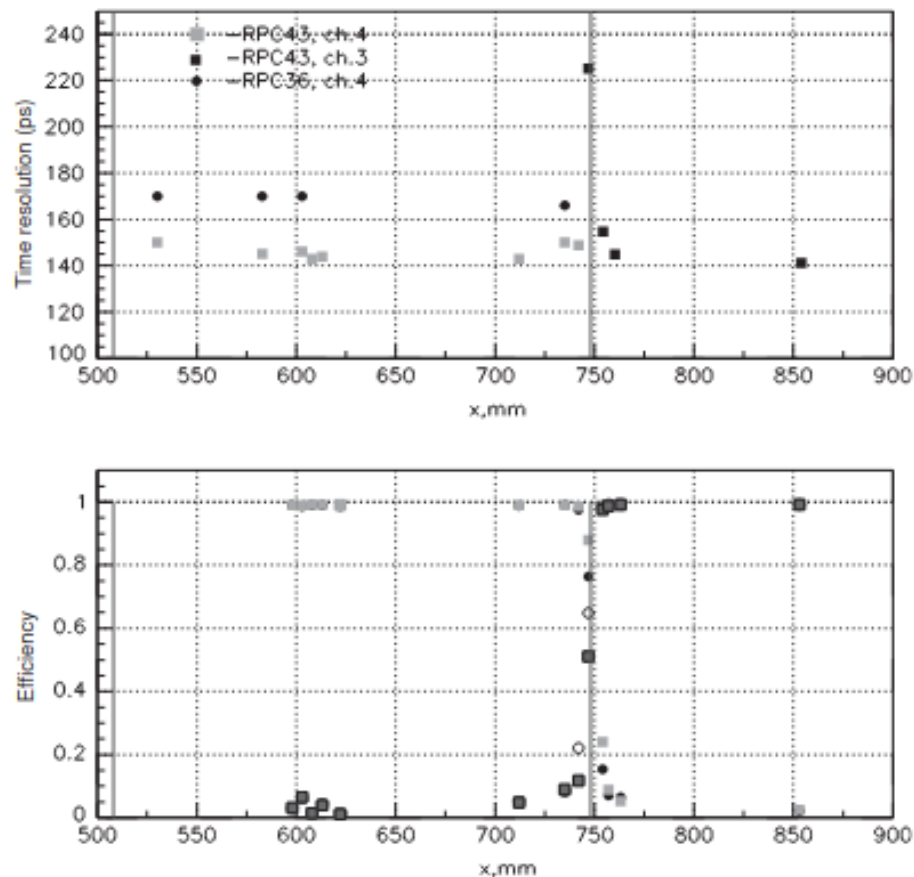

Fig. 7. Time resolution and efficiency as function of the impact point of the beam. The x direction is along the RPC, one readout channel covers 240 mm; the boundary between the pads read out by two different preamplifiers is at $x = 750$ mm.

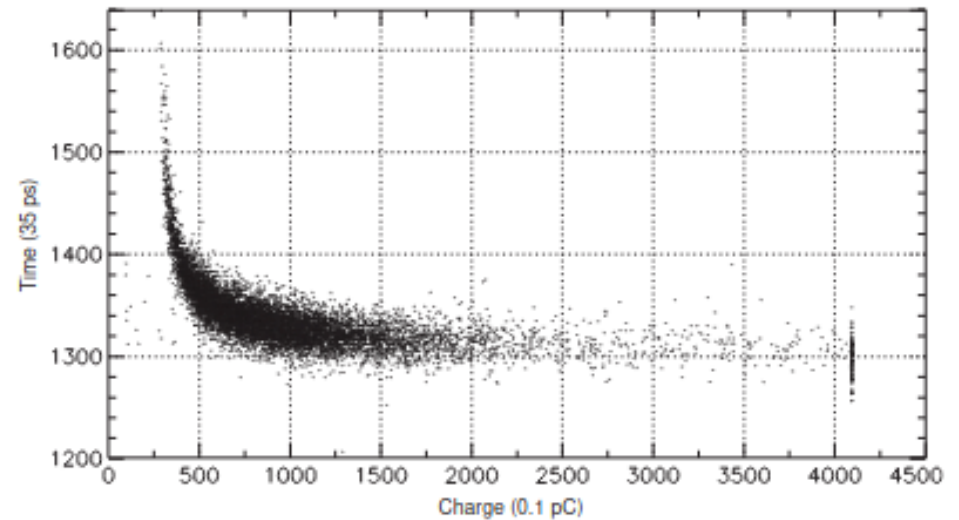

Fig. 8. Time-charge relation for an RPC exposed to a -8 GeV/ c beam.

Resolution 140 to 170 ps.

Later there was some controversy about the performance of the detector in the experiment.

Extension to large area/channel (inspired by the needs of the HARP experiment)

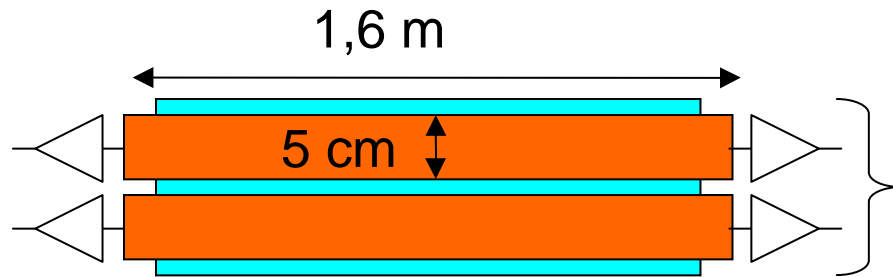

Active area = $10 \text{ cm} \times 160 \text{ cm} = 0.16 \text{ m}^2$
($400 \text{ cm}^2/\text{electronic channel}$)

Pestov-style readout (both ends)

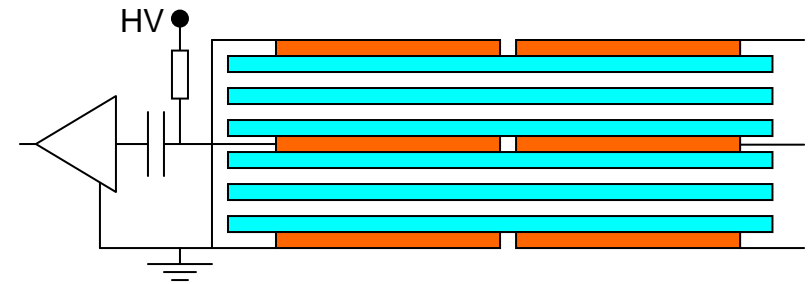

Top view

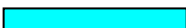

-  Ordinary 3 mm "window glass"
-  Copperstrips



A.Blanco et al., arXiv:physics/0103086 (26 March, 2001)

A.Blanco et al., NIM A 485 (2002) 328

Extension to large area/channel (inspired by the needs of the HARP experiment)

Efficiency and time resolution

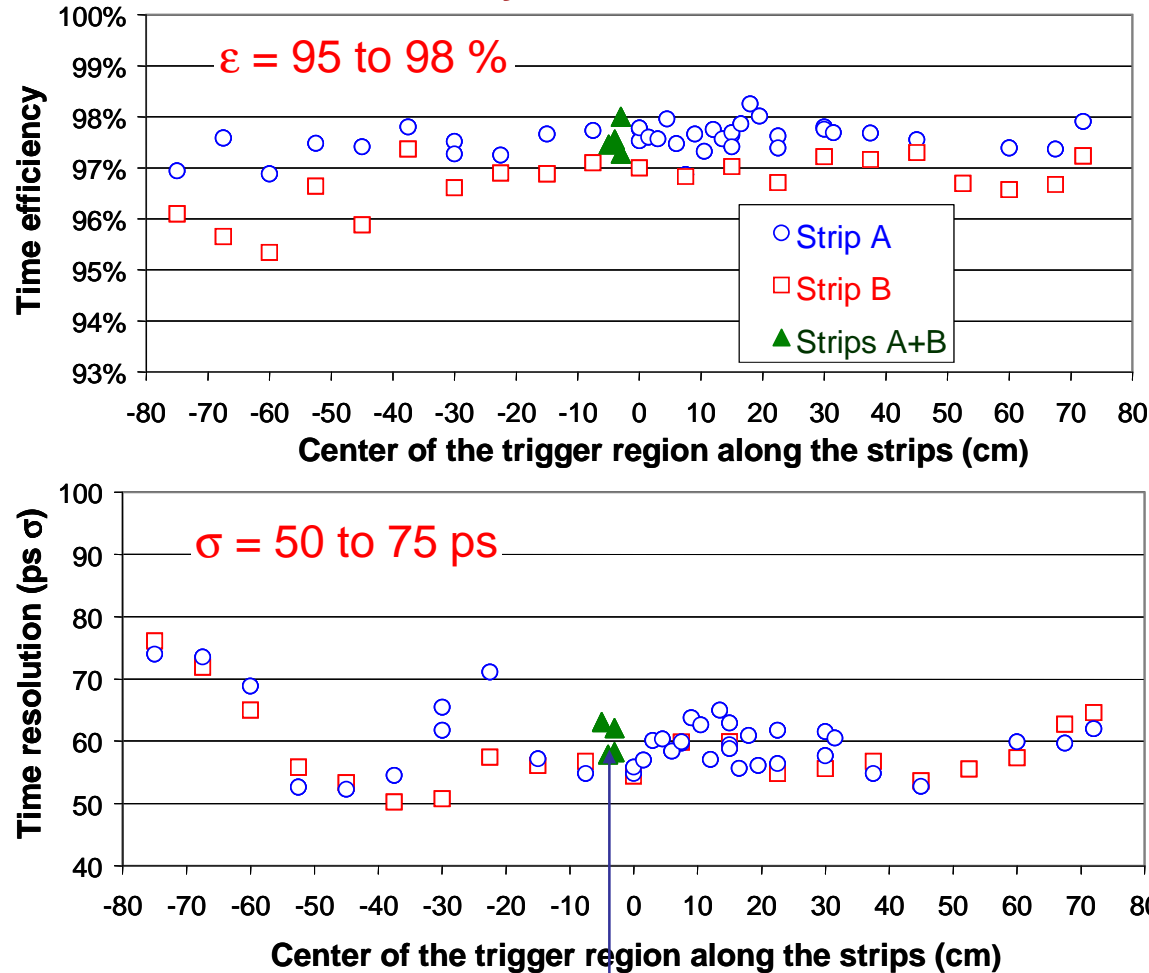

Longitudinal resolution

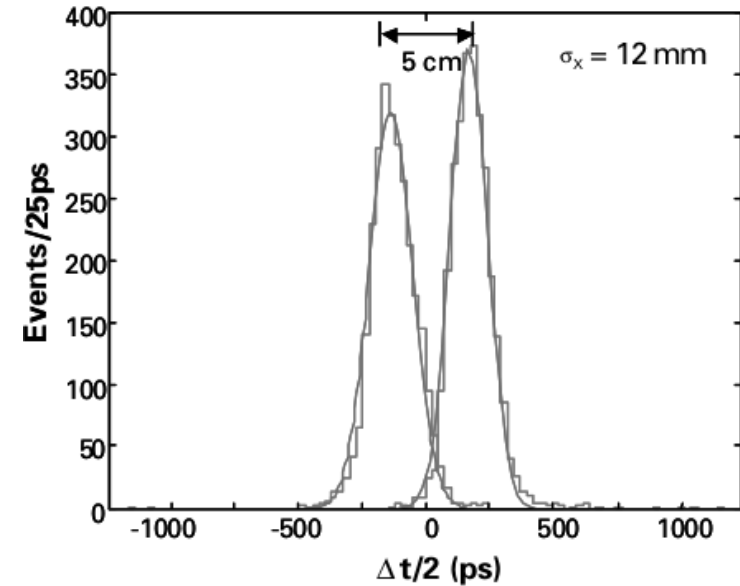

Long strips are not to be seen as capacitors but as (multiconductor) transmission lines

No degradation when the area/channel was doubled (800 cm²/channel)

A.Blanco et al., arXiv:physics/0103086 (26 March, 2001)

A.Blanco et al., NIM A 485 (2002) 328

The FOPI experiment

The FOPI experiment (GSI) had been already for several years pursuing the Pestov spark counter technology, but quickly adopted the tRPC approach owing to its enormous practical advantages over the very technically challenging Pestov counters.

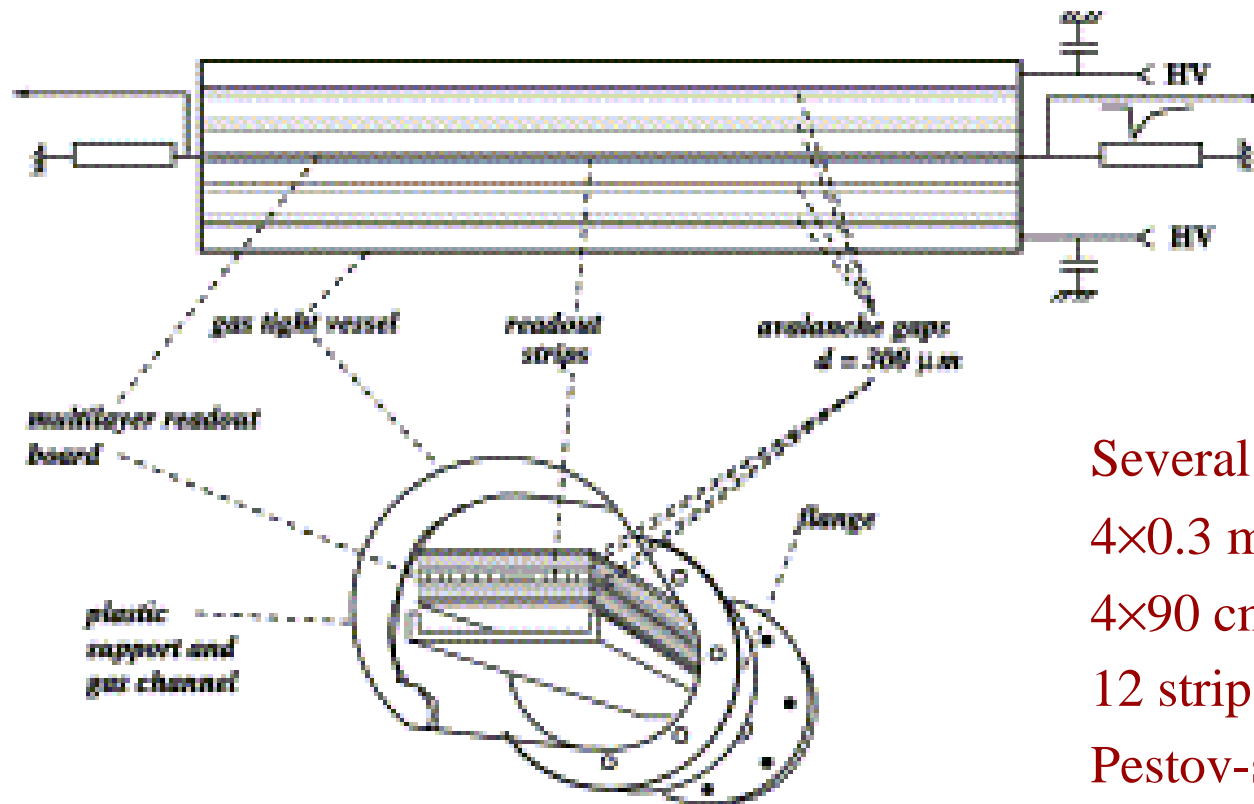

Several kinds of glass electrodes
 4×0.3 mm gaps
 4×90 cm² active area
 12 strips
 Pestov-style readout

Final resolution 70 to 80 ps
 Limited multihit capability

Use of tRPCs in physics experiments

Experiment/detector	Host institute/country	area (m ²)	Channels	First publication on full detector			Status	Notes
				year	Ref			
HARP TOFW	CERN	6	368	2004	10.1016/j.nima.2004.04.250	Terminated		
FOPI TOF Barrel	GSI Germany	6	4800	2007	10.1016/j.nima.2011.02.076	Terminated		
PHENIX TOF-West	BNL USA	8	1024	2008	10.1088/0954-3899/35/10/104002	Active		
HADES inner TOF	GSI Germany	8	2232	2009	10.1016/j.nima.2008.12.090	Active		
ALICE TOF	CERN	150	153000	2010	10.1016/j.nima.2010.01.004	Active		
STAR TOF	BNL USA	64	23040	2012	10.1016/j.nima.2010.07.086	Active		
STAR MTD	BNL USA	107	2928	2014	10.1016/j.nima.2014.05.075	Active		
BESIII endcap TOF	BEPCII PRC	1.3	1728	2016	10.1088/1748-0221/11/07/C07005	Active		
BGOegg-RPC	SPring8 Japan	6.4	256	2016	10.1088/1748-0221/11/11/C11037	Active		
EEE	Italy	230	8640	2018	10.1088/1748-0221/13/08/P08026	Active		
HADES forward TOF	GSI Germany	2	256	2023	10.1016/j.nima.2023.168182	Active		
R ³ B	GSI Germany	2	82	2023	10.1016/j.nima.2023.168445	Active		
BM@N TOF400+700	JINR Russian Fed.	>5	>3136		https://bmj.jinr.ru/detector/project/BMN_project.pdf	Projected		
CBM TOF	GSI Germany	120	106608		GSI-2015-01999	Projected	Large rate range Up to 50 kHz/cm ²	
CEE eTOF	HIRFL PRC	8	1536		10.1088/1748-0221/15/08/C08022	Projected		
CEE iTOF	HIRFL PRC	?	?		10.1016/j.nima.2023.168455	Projected	20 ps	
MARQ TOF	J-PARK Japan	?	?		This conference	Projected		
MARQ TOF-tracker	J-PARK Japan	10	?		10.1016/j.nima.2023.168581	Projected	< 1 mm position resolution	
MPD TOF	JINR Russian Fed.	?	?		10.1016/j.nuclphysa.2018.10.082	Projected		
SHiP Timing Detector	CERN	50	1689		CERN-SPSC-2019-049	Projected	Not baseline technology	
SoLID	Jlab USA	10	?		SoLID Updated Preliminary Conceptual Design Report	Projected	20 ps	
STAR eTOF	BNL USA	7	5184		10.48550/arXiv.2308.16556	Projected		

Except for HARP, in all cases the time resolution is typically between 50 and 100 ps σ

Clearly the future directions are:

- large count rate density
- super resolution ~ 20 ps
- simultaneous accurate position resolution (TOF-tracker)

(please suggest corrections/additions to this list for the paper)

Overview of detector structures - chambers

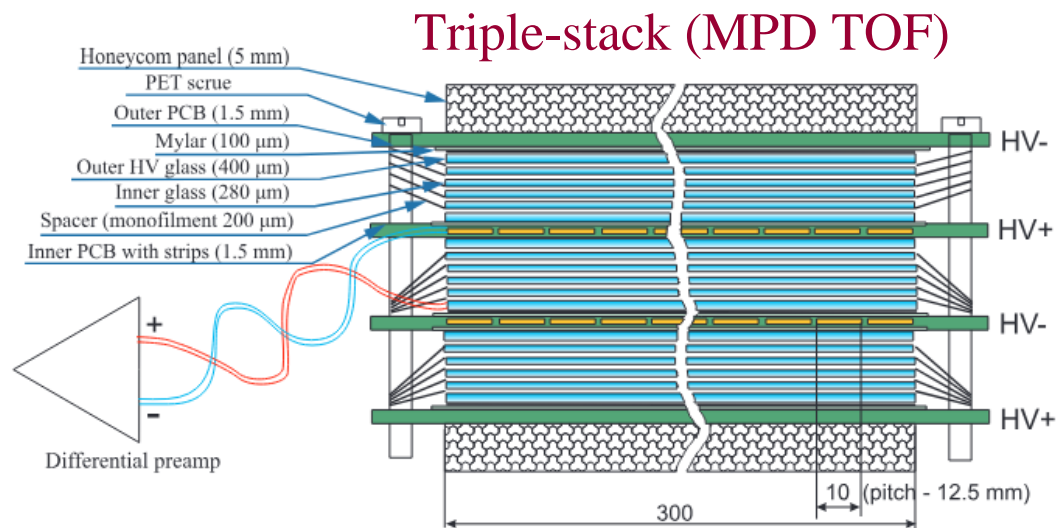
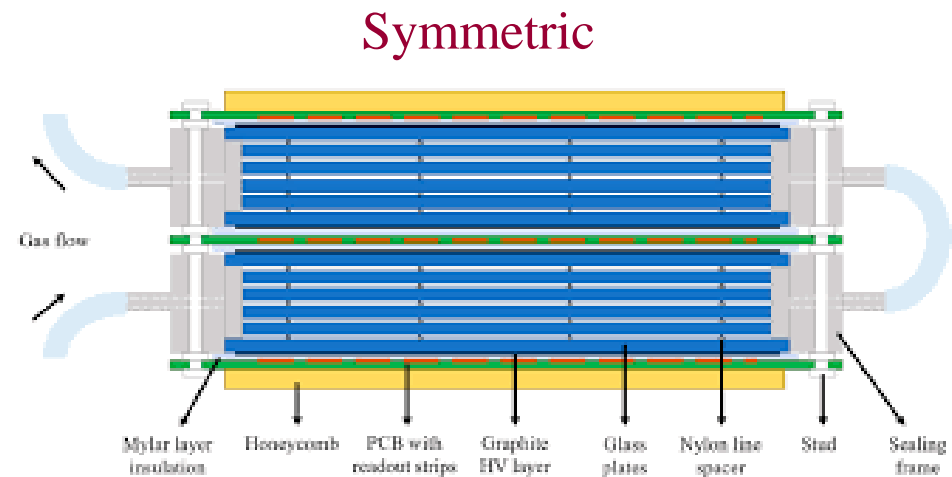
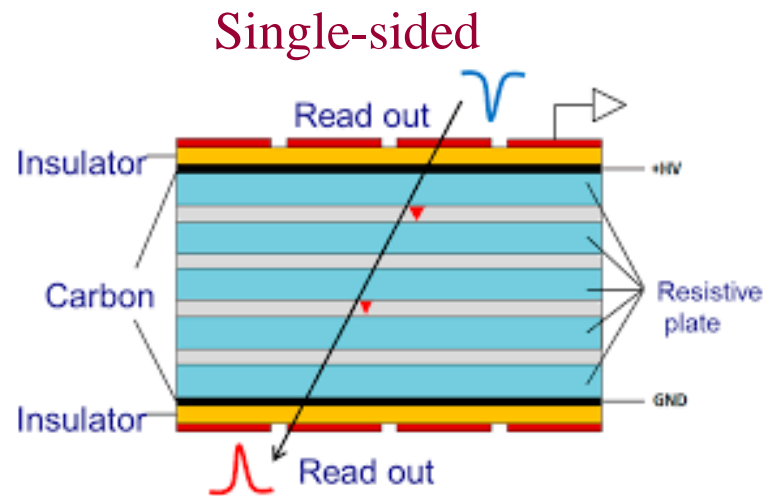

Typically 4 to 12 gaps with width in the range 0.2 to 0.3 mm.

Overview of detector structures - readout

Multistrip (most – OK for low occupancy)

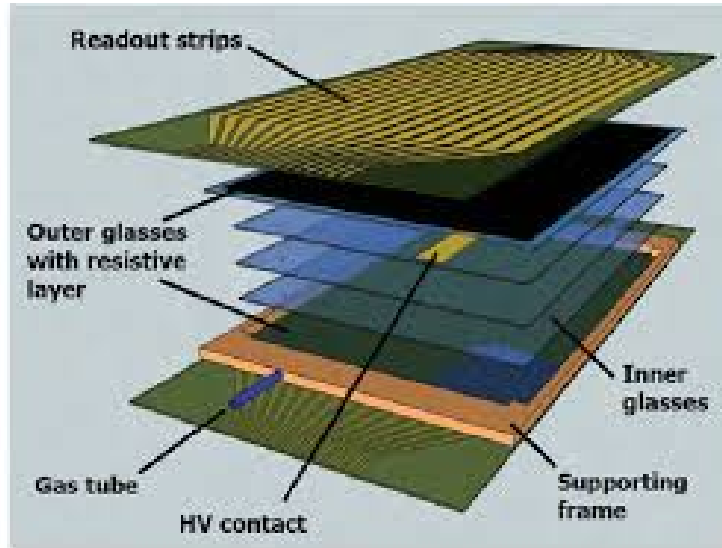

2×n pads (ALICE)

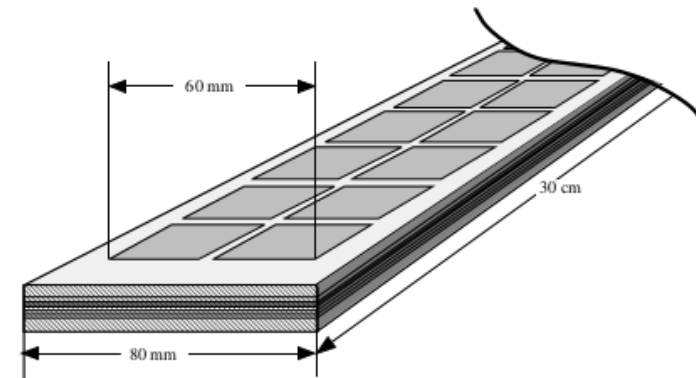

TOF-tracker (X+Y thin strips)

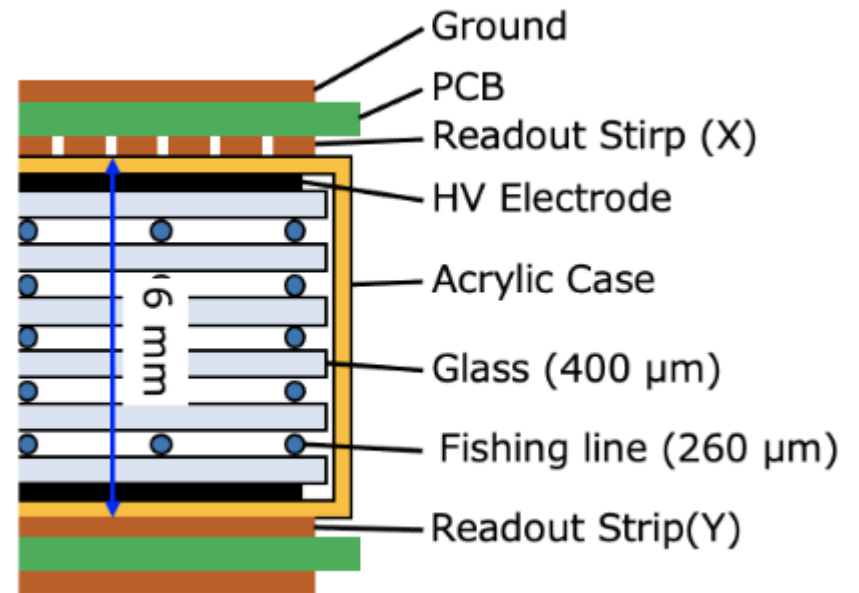

Single shielded strips (HADES)

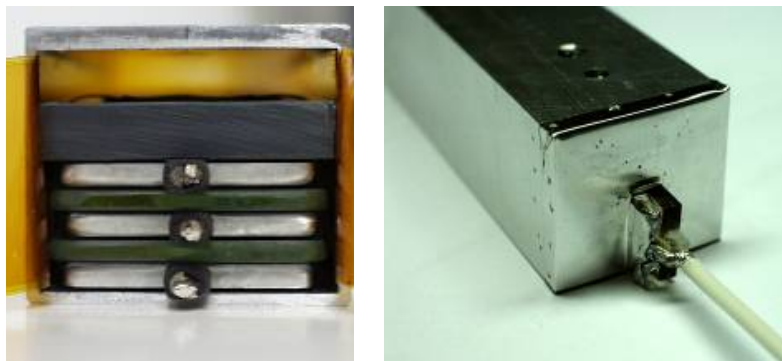

Strips tend to be <4 cm wide.
No strong length limitation (transmission lines).

MARQ but also useful for
muon tomography, RPC-PET, etc.

tRPC physics - efficiency

An efficiency of 75% has been measured on single 0.3 mm gaps. How to understand this?

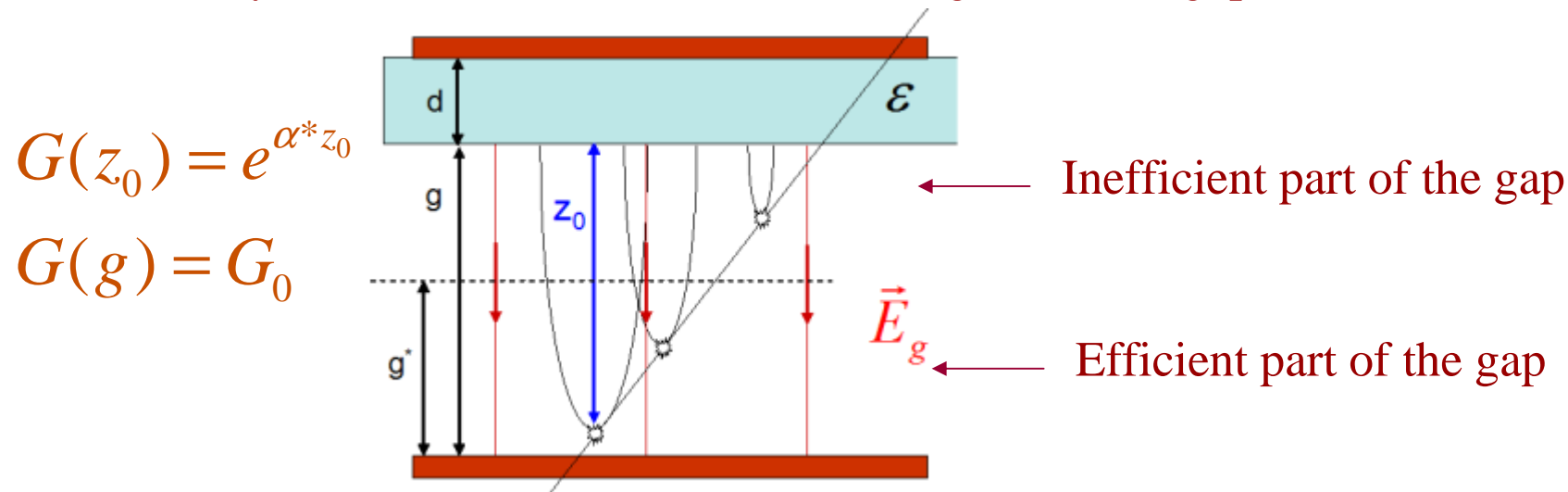

The probability that no charge is created on the efficient part of the gap is $P(0) = e^{-\lambda g^*} = 0.25$ where λ is the primary ionization density $\sim 9/\text{mm}$, so $g^* \approx 0.15$ mm: about half of the gap.

The problem is that for an electron to generate sufficient charge on half the gap ($z_0 = g - g^* \sim g/2$), let's say, modestly, $10^5 e^-$ ($16 \text{ fC} \Rightarrow \sim 0.25 \text{ mV}$ signal in 3 ns on 50Ω), then an electron released from the cathode would generate $(10^5)^2 = 10^{10}$ electrons!

Such avalanches were never seen. The famous Raether limit is 10^8 electrons and that's for wide $\sim \text{cm}$ gaps. For small gaps it will be less.

tRPC physics – space charge

As the avalanche grows the first Townsend coefficient gets smaller and this limits the final size of the larger avalanches.

There is rather direct evidence of this:

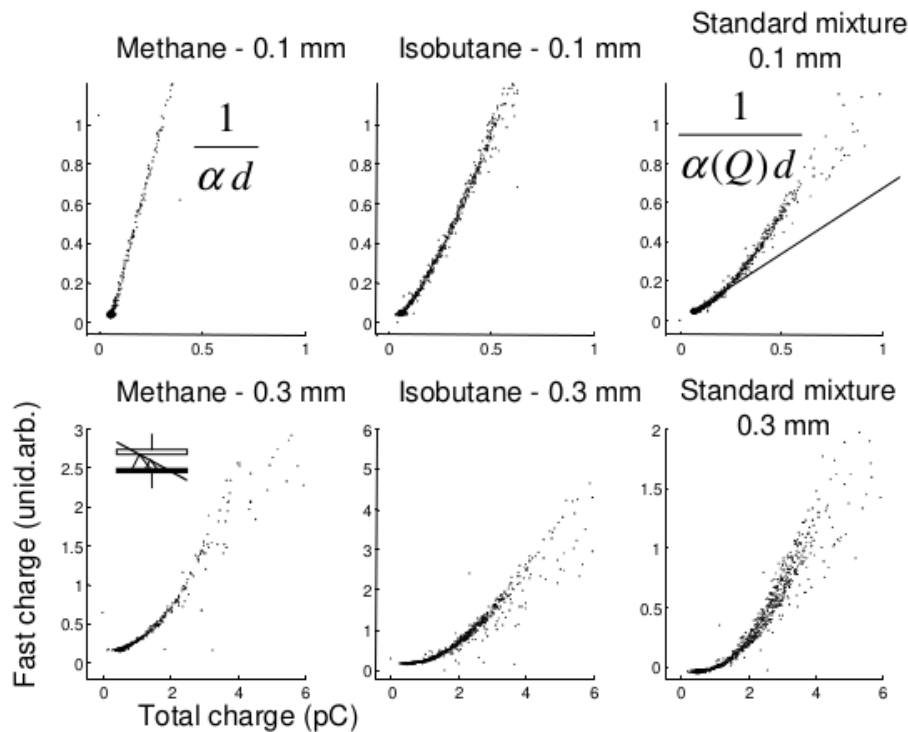

Fast charge vs. Total charge

Sometimes this same effect generates a streamer and that defines the gain limit of the (avalanche mode) RPC

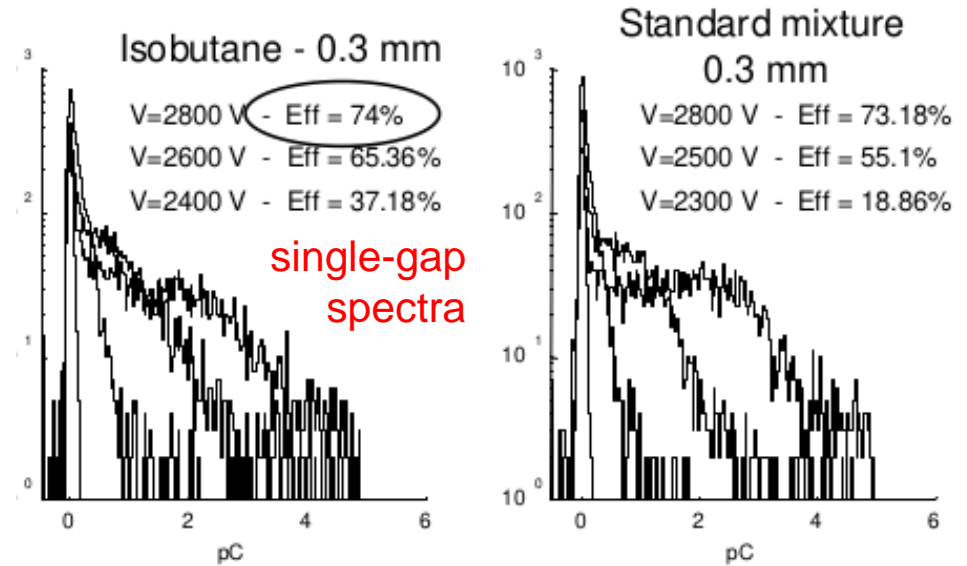

single-gap spectra

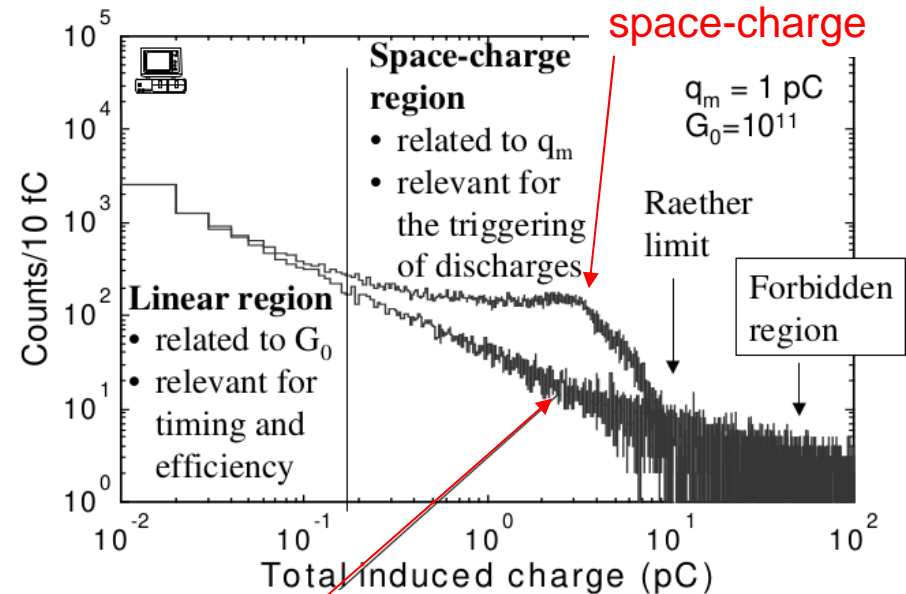

No space-charge

tRPC physics – timing (theory developed by several people over ~ a decade)

How can the excellent time resolution be understood on a gaseous detector where the transit time of the electrons across the gap is on the order of 3 ns? **1st order explanation: the time is determined already during the progression of the avalanches, so it doesn't depend on the position where they started.**

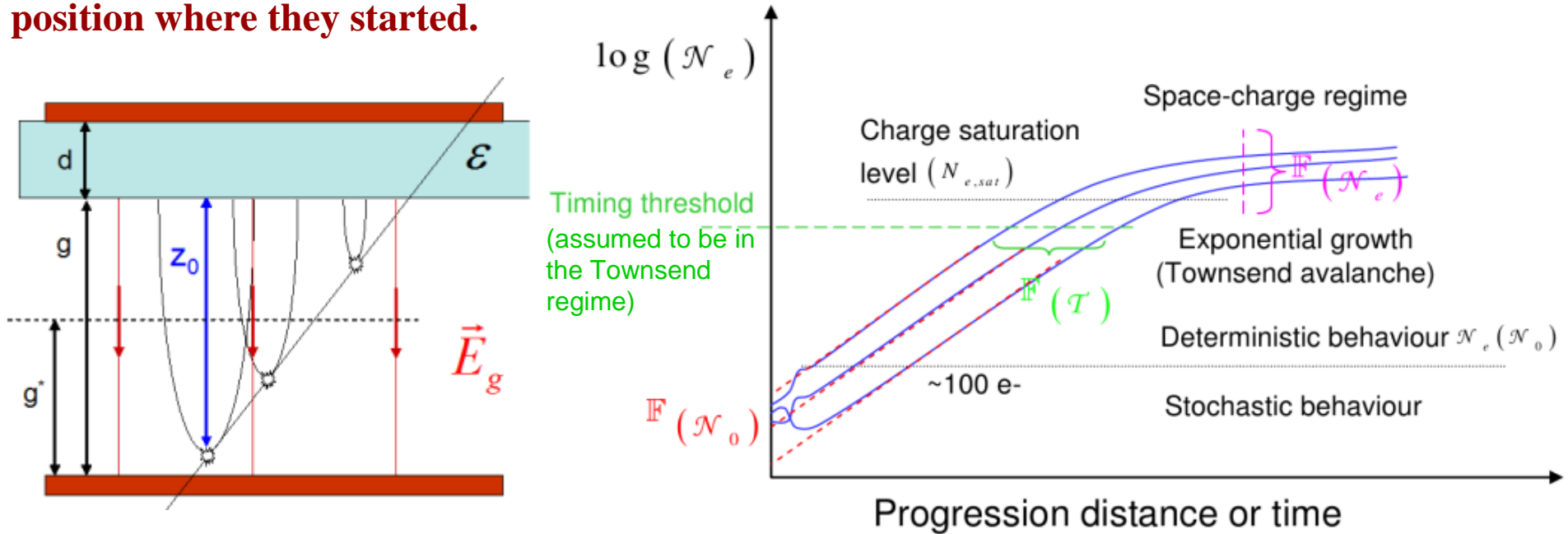

A variable number of primary electrons is created in each gap (Poisson distribution): primary statistics.

Each primary electron generates an avalanche whose charge is noisy in its preliminary stages (exponential distribution in the worst case): avalanche statistics

Avalanches started too close to the cathode don't grow enough to contribute to the current at the level of the timing threshold, so there is an effective gap width $g^*(\sim g/2)$.

Above $\sim 100 e^-$ each avalanche starts to behave deterministically.

All these effects can be summarized by extrapolating the deterministic part back to time 0 and growing deterministically from there (red dashed lines).

tRPC physics – timing (theory developed by several people over ~ a decade)

The consequences of these (rather straightforward) assumptions have been worked out analytically:

$$\mathbb{F}_{\mathcal{A}+\mathcal{D}}(ST) = \underset{\uparrow}{ue^{-u}} \frac{\sqrt{r\lambda g^*} I_1 \left(2\sqrt{r\lambda g^* u} \right)}{(e^{r\lambda g^*} - 1) \sqrt{u}}, \quad u = e^{\ln(r) + ST_{th} - ST}$$

Single-electron avalanche of fixed standard deviation = 1.28

α^* = effective ionization density in the avalanche

λ = primary ionization density

r = probability of multiplication vs. attachment.

$S = \alpha^* v_e$ is the ionization rate in the avalanche. This is the basic resolution-scaling parameter. Therefore the famous formula for the time resolution $\sigma = 1.28 / (\alpha^* v_e)$, corresponding to the single-electron limit.

A remarkable feature of this distribution is that its shape depends only on $r \lambda g^*$ = number of primary charges in the effective gap region that have not been captured by the electronegative gas (effective primary charge) \Rightarrow related to the intrinsic inefficiency of the detector.

I_1 is the modified Bessel function of first order.

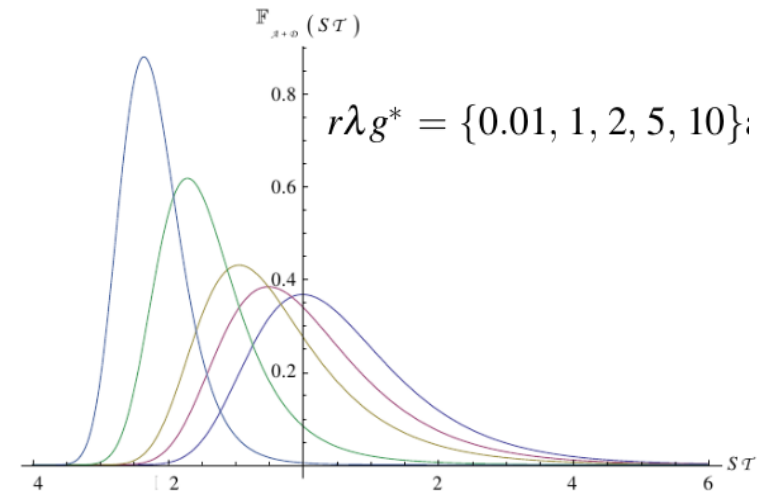

tRPC physics – timing (theory developed by several people over ~ a decade)

The variance of this distribution is also known analytically (in series form)

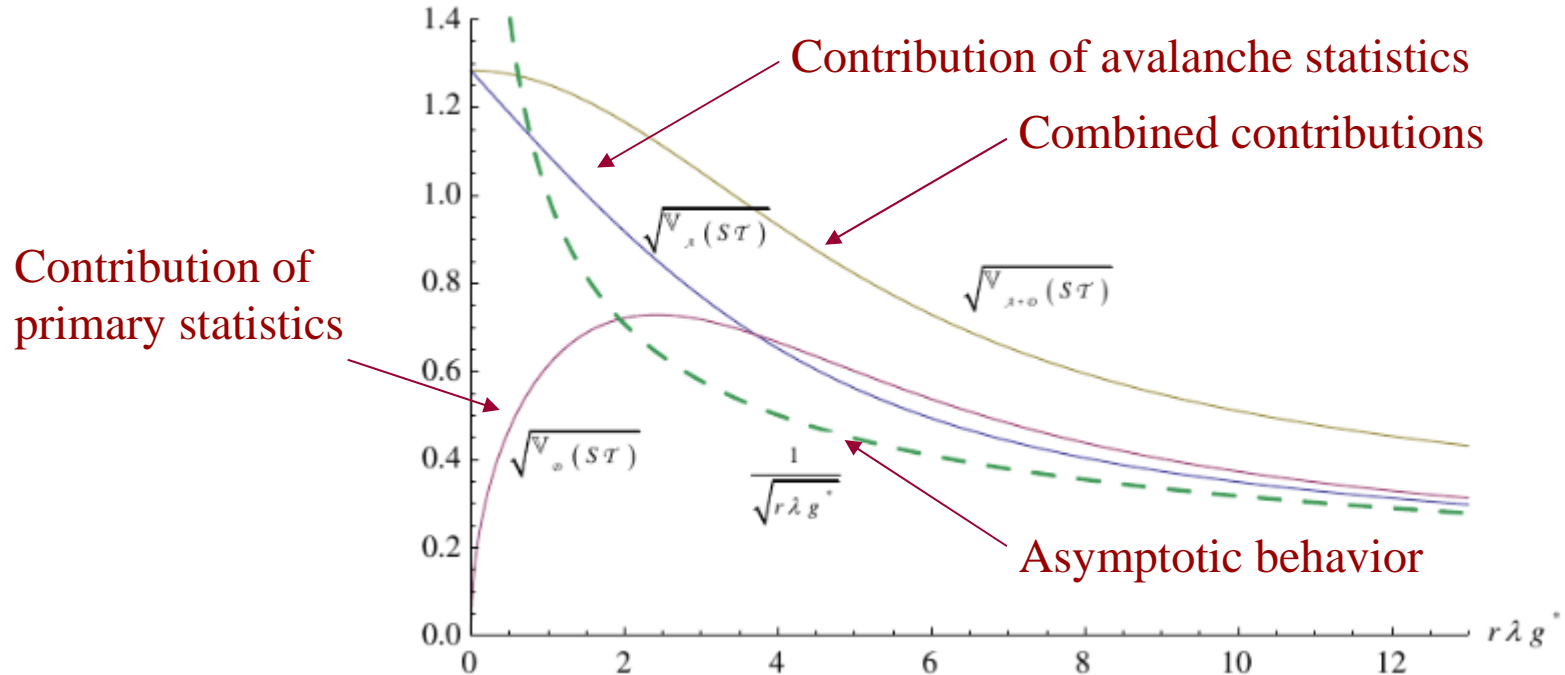

Therefore the asymptotic (large primary ionization) behavior is

$$\sigma_T \approx \sqrt{\frac{2}{r\lambda g^*} \frac{1}{\alpha^* v_e}} = \sqrt{\frac{2g}{r\lambda \underbrace{(g^*/g)}_{\sim 1/2}} \frac{1}{\underbrace{(\alpha^* g)}_{\text{limited by streamer onset}} v_e}}$$

(will increase for smaller gaps) (will decrease for smaller gaps)

But beware that this α^* is the one unaffected by space charge. It is much larger than what can be inferred from the observed charge.

In very thin gaps at some point electronics and mechanics will start to dominate.

In MRPC the currents induced from all N gaps add analogically, so this is equivalent to replacing $\lambda \rightarrow N \lambda$ and all the rest will be the same.

tRPC physics – what is more or less done

Many other aspects of tRPC physics have been worked out analytically and/or numerically in more or less detail over the last 25 years:

- Timing
- Progression of avalanches, space-charge regime and streamer onset
- Deterministic and stochastic voltage drops on the electrodes
- Shape of the charge distribution (in Townsend regime only)
- Signal induction in the presence of conductive materials
see W. Riegler and P. Windischhofer, NIM A 980 (2020) 164471
- Signal propagation in multi-conductor transmission lines

tRPC physics – what remains to be done

A comprehensive simulation of RPC behavior, benchmarked with reality. This is a long term objective of DRD1 WG4. Anyone interested to contribute is welcome.

All analytical models have been formulated in the Townsend regime...

There are 3 empirical analytical models of space charge. It has been shown that for the practical ranges of interest they are almost equivalent. But the comparison with reality or even numerical simulations hasn't been done.

The time resolution seems to be unaffected when the timing threshold lies in the space charge region. Both analytical and numerical models agree on this. Why?

The comparison between analytical predictions for time resolution and experiment is difficult owing to the large influence of technical factors, It lacks a fundamental measurement, free as possible of such complications.

Is the time-charge correction correcting something more than the amplifier rise time?

Analytical calculation of the charge distribution in the space-charge regime.

Some prediction, even approximate, of where the avalanche-streamer transition will occur. This is a practical limitation to α^* and therefore to the time resolution.

Clarification of the role of SF₆ in streamer suppression and of Ar in streamer enhancement.

Conclusion

Timing RPCs have been invented in the framework of the ALICE TOF R&D program in 1998/99 and opened a new era of large-area TOF systems for nuclear and HEP.

Have been or are being used in 10 physics experiments, with a total active area of 590 m² readout by almost 200000 channels. Typical time resolutions range from 50 to 100 ps.

Are being proposed for 7 future experiments, some with requirements beyond the current baseline technology:

- large count rate density (\sim tens of kHz/cm²)
- super time resolution (\sim 20 ps)
- simultaneous sub-millimetric position resolution (TOFtracker)

The advent of the SiPM has brought the scintillator technology back into the range of options. It remains to be seen a large area detector with resolution <100 ps, but it is the baseline technology for the SHiP TD (50 m²).

Considerable progress has been made on the understanding and modeling of tRPC physics, but a lot still remains to be done. The DRD1 Work Group 4 welcomes contributors on these matters.