

An introduction to Magnets for Accelerators

Attilio Milanese

Attilio.Milanese@cern.ch



John Adams Institute
Accelerator Course

18 Jan. 2024

This is an introduction to magnets as building blocks of synchrotrons / transfer lines

```
//  
// MADX Example 2: FODO cell with dipoles  
// Author: V. Ziemann, Uppsala University  
// Date: 060911  
  
TITLE, 'Example 2: FODO2.MADX';  
  
BEAM, PARTICLE=ELECTRON, PC=3.0;  
  
DEGREE:=PI/180.0;  
  
QF: QUADRUPOLE, L=0.5, K1=0.2;  
QD: QUADRUPOLE, L=1.0, K1=-0.2;  
B: SBEND, L=1.0, ANGLE=15.0*DEGREE;  
  
FODO: SEQUENCE, REFER=ENTRY, L=12.0;  
  QF1: QF, AT=0.0;  
  B1: B, AT=2.5;  
  QD1: QD, AT=5.5;  
  B2: B, AT=8.5;  
  QF2: QF, AT=11.5;  
ENDSEQUENCE;
```

2

This introduction is a first description of magnets commonly found in synchrotrons and transfer lines, aimed in particular at explaining the *magnetic elements* as used in lattice codes.

Taking for example that FODO sequence in MAD-X:

- * what is the field in the dipole? (is it *achievable*?)
- * what is the difference between an SBEND and an RBEND?
- * is the quadrupole length the actual physical length? from where to where?
- * could we use a higher k_1 (normal quadrupole coefficient) and a shorter length?

If you want to know more...

1. Special CAS edition on magnets, St. Pölten, Nov.-Dec. 2023
2. Special CAS edition on magnets, Bruges, Jun. 2009
3. N. Marks, Magnets for Accelerators, JAI (John Adams Institute) course, Jan. 2015
4. D. Tommasini, Practical Definitions & Formulae for Normal Conducting Magnets
5. Lectures about magnets in CERN Accelerator Schools
6. Superconducting magnets for particle accelerators in USPAS (U.S. Particle Accelerator Schools)
7. J. Tanabe, Iron Dominated Electromagnets
8. P. Campbell, Permanent Magnet Materials and their Application
9. K.-H. Mess, P. Schmüser, S. Wolff, Superconducting Accelerator Magnets
10. M. N. Wilson, Superconducting Magnets
11. A. Devred, Practical Low-Temperature Superconductors for Electromagnets
12. L. Rossi and E. Todesco, Electromagnetic design of superconducting dipoles based on sector coils

3

1. <https://indico.cern.ch/event/1227234/>
2. <https://cas.web.cern.ch/schools/bruges-2009> and <http://cdsweb.cern.ch/record/1158462>
3. indico.cern.ch/event/357378/session/2/#all
4. edms.cern.ch/document/1162401
5. cas.web.cern.ch/previous-schools
6. for example, indico.cern.ch/event/440690
7. ISBN 9789812563811
8. ISBN 9780521566889
9. ISBN 9789810227906
10. ISBN 978-0198548102
11. CERN-2004-006, cds.cern.ch/record/796105
12. cds.cern.ch/record/1076301

A heartfelt thank you to many colleagues – in particular those from which I borrowed much of the material for this short course.

According to history, the first electromagnet (not for an accelerator) was built in England in 1824 by William Sturgeon

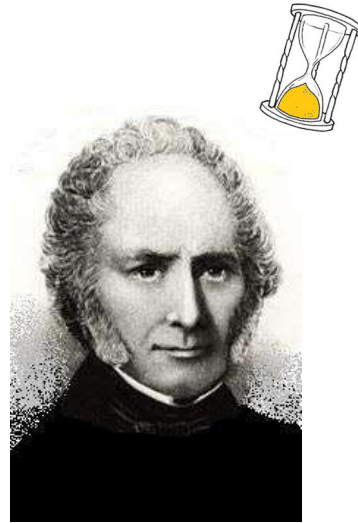
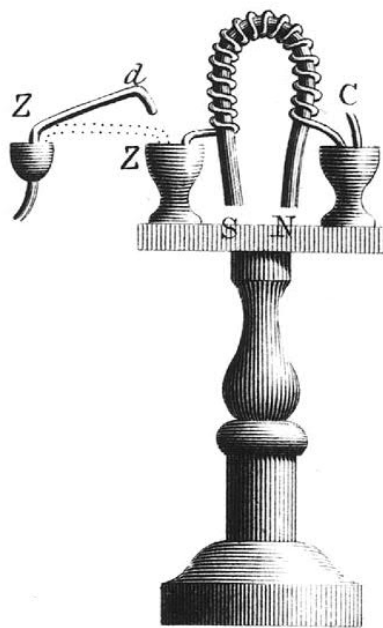

William Sturgeon

4

sources:

Wikipedia

<http://physics.kenyon.edu/EarlyApparatus/Electricity/Electromagnet/Electromagnet.html>

In 1820 Hans Christian Oersted discovered that a current-carrying wire set up a magnetic field.

In the same year, André-Marie Ampère discovered that a helix of wire acted like a permanent magnet, and Dominique François Jean Arago found that an iron or steel bar could be magnetized by putting it inside the helix of current-carrying wire.

In 1824 William Sturgeon found that leaving the iron inside the coil greatly increased the resulting magnetic field. Sturgeon also bent the iron core into a U-shape to bring the poles closer together, thus concentrating the magnetic field lines. The electromagnet was made of 18 turns of bare copper wire (insulated wire had not yet been invented), with mercury cups acting as switches. He displayed its power by lifting nine pounds (4.1 kg) with a seven ounce (200 g) piece of iron wrapped with wire through which a current from a single battery was sent.

The working principle is the same as this large magnet, of the 184'' (4.7 m) cyclotron at Berkeley (picture taken in 1942)

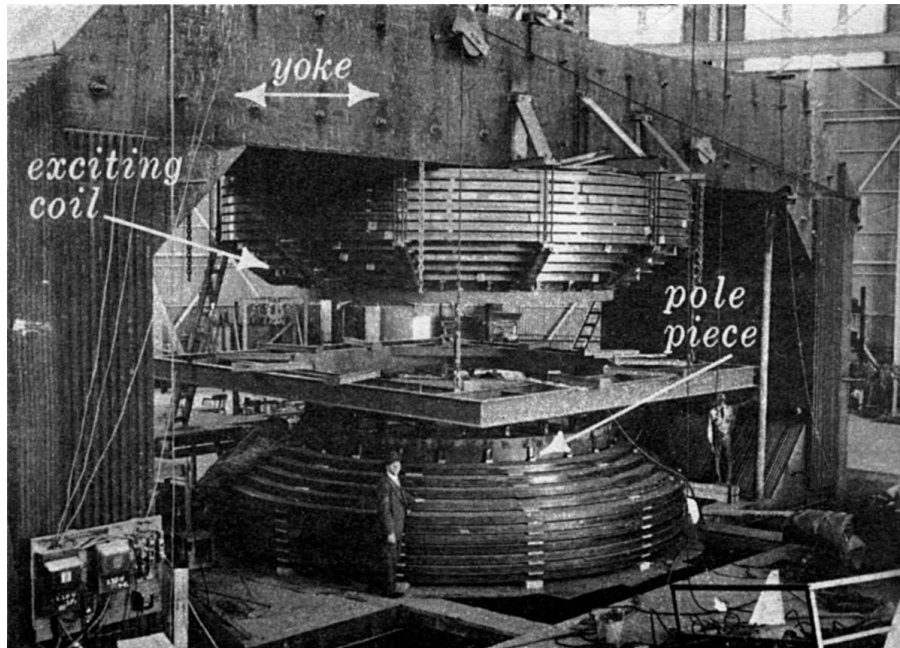

5

This cyclotron magnet was built with 4000 tons of iron and 300 tons of copper. The maximum field was 2.34 T, for a dissipated power of 2.5 MW. By the way, that should be the largest single-magnet (synchro)cyclotron ever built.

It was able to accelerate protons up to 730 MeV. The CERN synchrocyclotron made it up to (only) 600 MeV.

We will not look into this kind of accelerator magnets, sticking to the ones found in (strong focusing) synchrotrons and related transfer lines.

This short course is organized in several blocks

1. Introduction, jargon, general concepts and formulae
2. Resistive magnets
3. Superconducting magnets
4. Tutorial with FEMM

Magnets can be classified based on their geometry / what they do to the beam

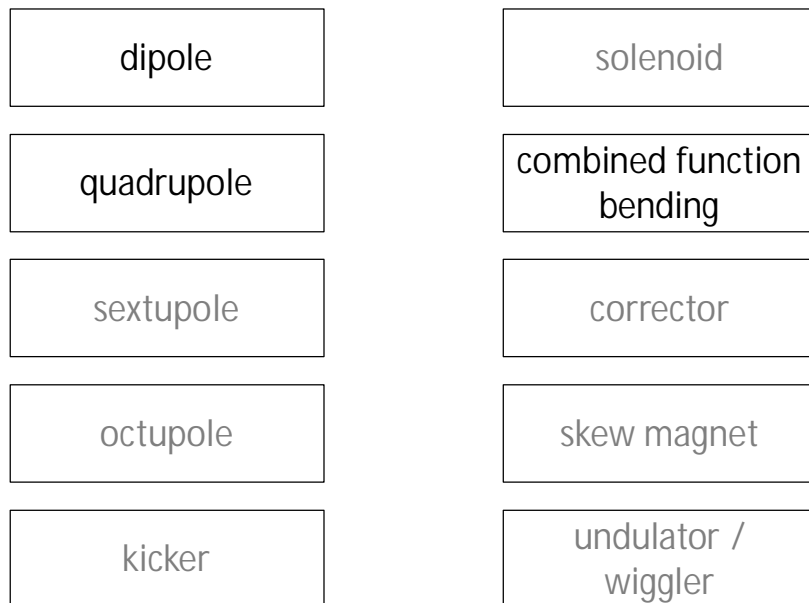

7

In brief:

- * dipoles bend the beam, in fact they are also called bending magnets
- * quadrupoles focus the beam (one transversal plane at the time)

These are usually the main magnets in synchrotrons and transfer lines; therefore, we will focus mainly on them.

A combined function bending magnet is a superposition of a dipole and a quadrupole: it bends and focuses the beam (in a plane) at the same time. They are less popular now with respect to the early days of synchrotrons; still, they are used in some modern machines, for ex. light sources.

This is a main dipole of the LHC at CERN: 8.3 T × 14.3 m

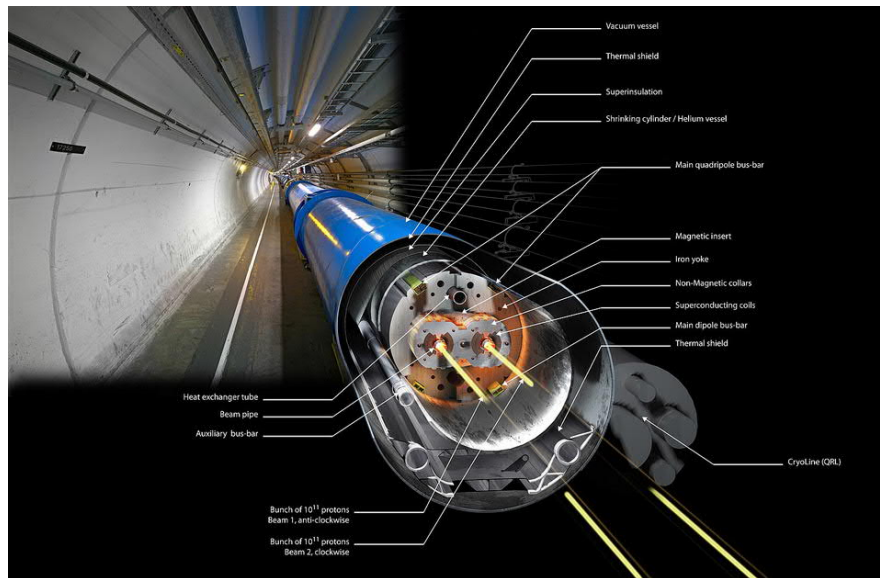

8

The LHC main dipoles (MB = Main Bending) are superconducting magnets, built in the 2000's.

The coils are wound using Nb-Ti cable and they are cooled by superfluid helium at 1.9 K.

At the nominal current of 11.8 kA, the dipole field is 8.3 T, in a 56 mm diameter circular aperture.

Each dipole bends the beam by $360 / 1232 = 0.29$ deg.

They are slowly ramped (about 20 min.) and then used in dc mode, as the LHC operates as a collider.

These magnets are the result of many years of R&D and they are very close to the maximum that can be achieved with Nb-Ti superconducting technology.

Note as of Jan. 2023: the LHC ran so far up to 6.8 TeV, corresponding to 8.06 T; 6 out of 8 sectors have already been "trained" – with quenches – up to 7 TeV.

These are main dipoles of the SPS at CERN: 2.0 T × 6.3 m



9

The SPS main dipoles are resistive magnets, with coils in copper. Demineralized water flows in the conductor to remove the Joule heating.

At the peak current of 5.8 kA, they provide a dipole field of 2.0 T in a rectangular aperture. Two types of magnets with a smaller (39 mm, MBA) and larger (52 mm, MBB) vertical aperture are used.

Each dipole bends the beam by $360 / 744 = 0.48$ deg.

They now work in cycled mode and they can be ramped in a few seconds.

In the 1970s, also a superconducting option was studied (but then abandoned) for the SPS.

The main SPS power converters can give a peak power of around 100 MW, which is drawn directly from the 400 kV lines. The average (rms) power depends on the duty cycle, though it is usually around 30 MW.

The photo was taken in 1974.

This is a cross section of a main quadrupole of the LHC at CERN: $223 \text{ T/m} \times 3.2 \text{ m}$

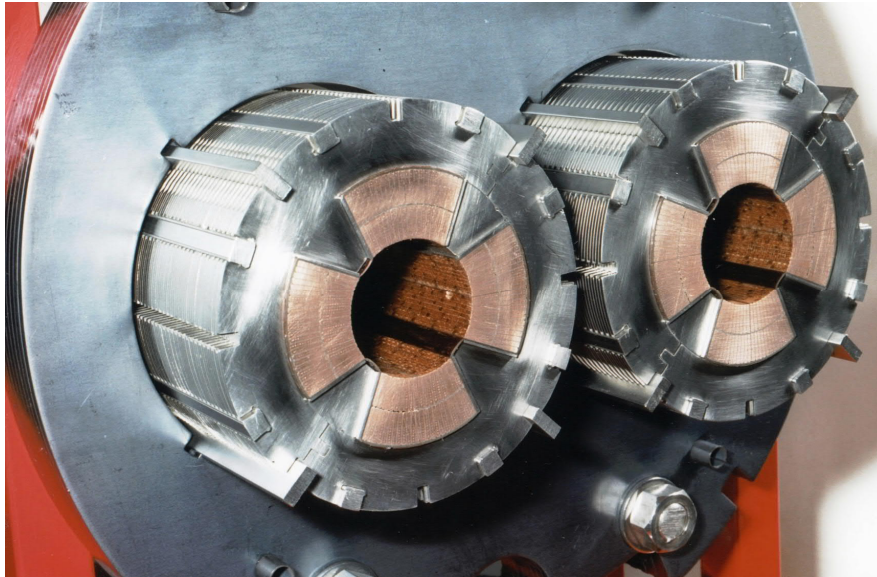

10

The LHC main quadrupoles (MQ) are superconducting magnets.

The coils are wound with Nb-Ti cable and they are cooled by superfluid helium at 1.9 K, like the LHC dipoles.

At the nominal current of 11.8 kA, they provide a gradient of 223 T/m. Considering their aperture of 56 mm diameter, this corresponds to a pole tip field of 6.2 T ($= 223 \times 0.028$). The peak field in the conductor is about 10% higher, at 6.8 T.

These are main quadrupoles of the SPS at CERN:
22 T/m \times 3.2 m



11

The SPS main quadrupoles are resistive magnets, with coils in copper.

Demineralized water flows in the conductor to remove the Joule heating, as for the SPS dipoles.

At the peak current of 2.1 kA, the gradient is 22 T/m in an 88 mm diameter circular aperture. The pole tip field is then 1.0 T ($= 22 \times 0.044$).

This is a combined function bending magnet of the ELETTRA light source

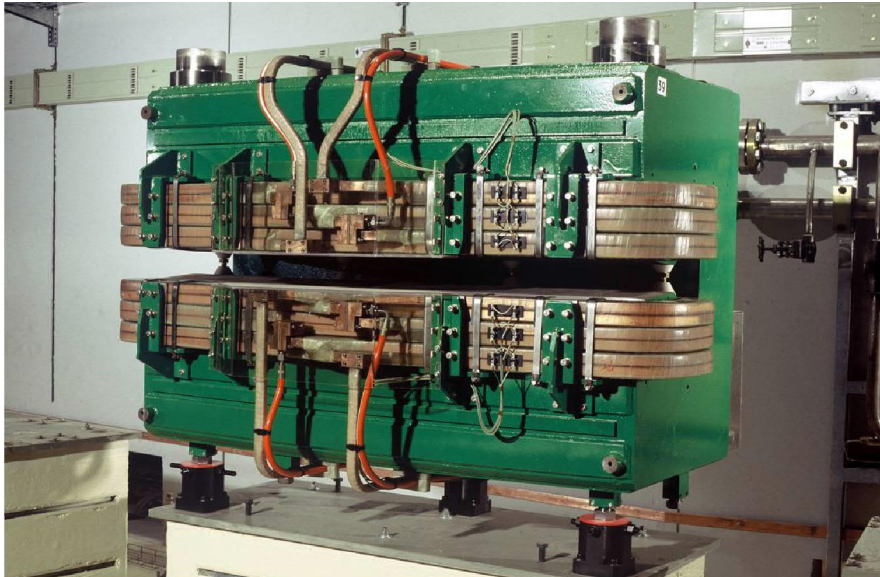

12

This is an example of a combined function (dipole + quadrupole) bending magnet, found for example in third generation synchrotron light sources. The technology is the same as that for the SPS dipoles shown before, just with a different design of the ferromagnetic yoke.

In ELETTRA, there are 24 such magnets. At the nominal current of 1420 A, the dipole field is 1.2 T, together with a quadrupole gradient of 2.9 T/m. The vertical central gap is 70 mm; the bending radius of the machine is 5.5 m.

These magnets were built in the 1990s.

These are sextupoles (with embedded correctors) of the main ring of the SESAME light source



13

This is an example of a common design found in synchrotron light sources, where the (short) sextupoles have additional windings so that they can be used also as corrector magnets.

In this case, the correctors are a horizontal / vertical dipole – providing up to 0.5 mrad kick at 2.5 GeV – and a skew quadrupole.

Magnets can be classified also differently, looking for example at their technology

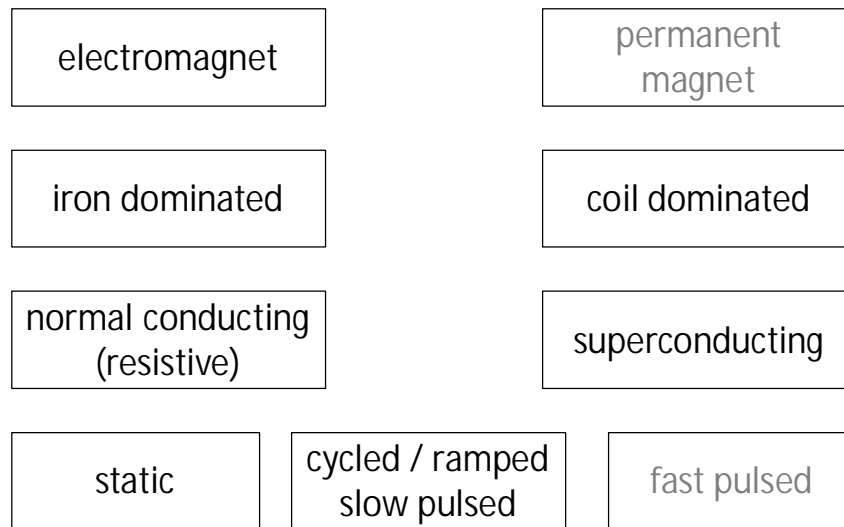

14

In electromagnets the field is produced by electrical currents going through the windings. In permanent magnets, on the other hand, the field is produced by hard magnetic material, such as NdFeB or SmCo.

Iron dominated magnets use a yoke (usually in electrical steel or iron) to guide, shape and reinforce the field; the position of the coil (or permanent magnet) is of minor importance for the strength and homogeneity of the field. Coil dominated magnets use the flux directly generated by the electric current flowing in the windings to shape the field; the position of the iron yoke (if any) is of minor importance for the strength and homogeneity of the field.

Normal conducting (or resistive) magnets have resistive coils, in copper or aluminum, and they are operated around room temperature. Joule heating has to be taken into consideration. Superconducting magnets have superconducting coils, with no Joule heating. The known technical superconductors need to be cooled at cryogenic temperatures to work.

The mode of operation can be static (dc, ex. main magnets in a collider or synchrotron light source), cycled / ramped / slow pulsed (ex. main magnets in a synchrotron for hadron therapy) or fast pulsed (ex. kickers).

In some cases, there might be some hybrids, such as an electromagnet with some permanent magnet.

We will not talk about permanent magnets and fast pulsed magnets.

Nomenclature

B	magnetic field B field magnetic flux density magnetic induction	T (Tesla)
H	H field magnetic field strength magnetic field	A/m (Ampere/m)
μ_0	vacuum permeability	$1.25663706212(19) \cdot 10^{-6}$ H/m $4\pi \cdot 10^{-7}$ H/m (Henry/m)
μ_r	relative permeability	dimensionless
μ	permeability, $\mu = \mu_0 \mu_r$	H/m

15

The jargon used in particle accelerator magnets is somewhat different from that used in classical electromagnetism.

B is usually referred to as the magnetic field and it is measured in Tesla [T], or Weber/m² [Wb/m²]. This is the field interacting with the beam through the Lorentz force.

H is mostly used when dealing with iron dominated magnets, in particular to compute the magnetomotive force, produced in a ferromagnetic material by the electrical current in the coils. H is measured in Ampere/m [A/m] and usually referred to simply as the H field, or as the magnetic field strength, although the latter can be misleading in this context.

Old units for B are Gauss [G] or kiloGauss [kG]: 10000 G = 1 T = 10 kG.

An old unit for H is Oersted (Oe): 1 Oe = 1000/(4 π) A/m

The vacuum permeability μ_0 , since the redefinition of SI units in 2019, is no longer a defined constant, but rather needs to be determined experimentally. [*Wikipedia dixit*]

The polarity comes from the direction of the flux lines, that go from a North to a South pole

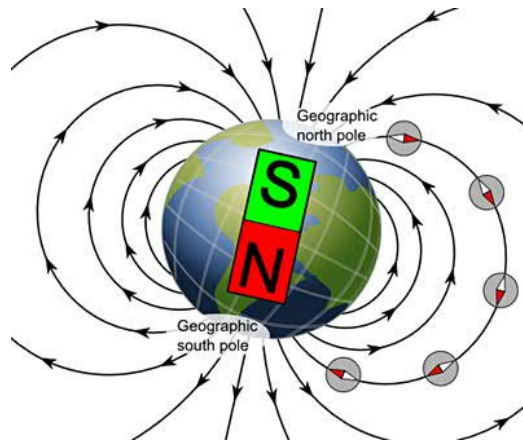

in Oxford, on 25/01/2017
 $|B| = 48728 \text{ nT} = 0.048728 \text{ mT} = 0.000048728 \text{ T}$

16

The Earth's magnetic field (for the moment) is oriented as in the figure, with the geographic North pole being a magnetic South pole, and vice versa.

The field at our latitudes is about 0.5 Gauss.

The value above was computed using the World Magnetic Model (WMM) and the latitude / longitude / elevation of Oxford. The date also matters, because the Earth's magnetic field changes in direction and amplitude with time.

You can check that out at

www.ngdc.noaa.gov/geomag/WMM

Magnetostatic fields are described by Maxwell's equations, coupled with a law describing the material

$$\operatorname{div} \vec{B} = 0$$

$$\oint_S \vec{B} \cdot d\vec{S} = 0$$

$$\operatorname{rot} \vec{H} = \vec{j}$$

$$\oint_C \vec{H} \cdot d\vec{l} = \int_S \vec{j} \cdot d\vec{S} = NI$$

$$\vec{B} = \mu_0 \mu_r \vec{H}$$

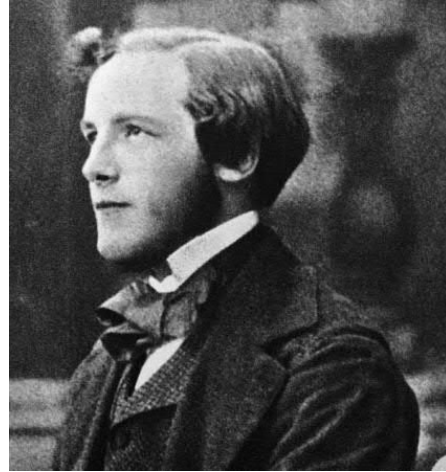

James Clerk Maxwell

17

(top formulae)

The B field is divergence free, or solenoidal. The total flux entering a bounded region equals the total flux exiting the same region (by Gauss theorem): there are neither sources nor wells.

(middle formulae)

The curl of the H field is generated by currents. Applying Stokes' theorem, the integral of H around a closed loop equals the total current passing through a surface that has that loop as a boundary. This is also known as Ampere's law.

(bottom formula)

B and H are related by the permeability μ . The relative permeability can be a function of the field level (ex. saturation) or even of the cycle leading to that H (ex. hysteresis).

All other expressions shown later (harmonic decompositions, Biot-Savart law) can be derived from these three equations. An exception is the Lorentz force.

The picture shows James Clerk Maxwell as a young man – he was around 30 when he first published these equations.

The Lorentz force is the link between electromagnetism and mechanics

$$\vec{F} = q[\vec{E} + (\vec{v} \times \vec{B})]$$

for charged beams

$$\vec{F} = I\vec{\ell} \times \vec{B}$$

for conductors

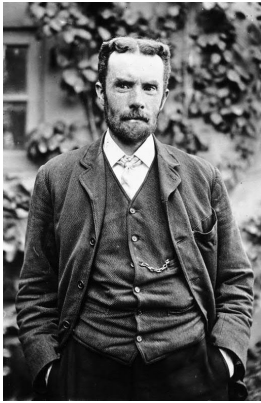

Oliver Heaviside



Hendrik Lorentz



Pierre-Simon, marquis de Laplace

18

The Lorentz force is the main link between electromagnetism and mechanics.

The force acting on a beam of charged particles exploits the magnetic field because of the (huge) leverage factor of the velocity, which is often close to the speed of light in our accelerators.

The expression on the right is the one used to get the force F on a conductor carrying a current I in a field B . Especially in superconducting magnets, these forces have to be properly considered at the design stage. For example, the LHC dipoles at nominal field see a horizontal force of approx. 350 tons per m length.

In French, “force de Laplace” is that acting on conductors.

From wiki: The first derivation of the Lorentz force is commonly attributed to Oliver Heaviside in 1889 (39 years old), although other historians suggest an earlier origin in an 1865 paper by James Clerk Maxwell. Hendrik Lorentz derived it a few years after Heaviside.

In synchrotrons / transfer lines magnets, the B field seen from the beam is often expressed as a series of multipoles

$$B_r = \sum_{n=1}^{\infty} \left(\frac{r}{R}\right)^{n-1} [B_n \sin(n\theta) + A_n \cos(n\theta)]$$

$$B_\theta = \sum_{n=1}^{\infty} \left(\frac{r}{R}\right)^{n-1} [B_n \cos(n\theta) - A_n \sin(n\theta)]$$

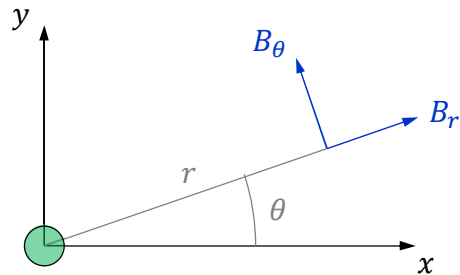

direction of the beam
(orthogonal to plane)

$$B_y(z) + iB_x(z) = \sum_{n=1}^{\infty} (B_n + iA_n) \left(\frac{z}{R}\right)^{n-1} \quad z = x + iy = re^{i\theta}$$

19

This 2D decomposition holds in a region of space:

- * without currents
- * without (hard or soft) magnetic materials (that is, basically, ferromagnetic material like iron and permanent magnets)
- * where the z component (3rd dimension, longitudinal) of B is constant

B (a 2D vector field) is then simply described by a series of scalar coefficients: B_1, A_1, B_2, A_2 , etc. These are the so-called (not-normalized) harmonics, or multipoles. They have units of Tesla. R is a reference radius.

The same decomposition can be used in 3D for integrated fields. Technically, this holds if at the beginning and end of the integration region $dB_z/dz = 0$, which is the case if B is integrated along a straight line all the way through a magnet.

The same decomposition can be expressed also in Cartesian coordinates (bottom equations), using complex variables. The use of complex numbers can be seen as a way of keeping the notation compact – or it can be given a deeper mathematical meaning (analytic function, Cauchy-Riemann conditions).

In some cases, instead of real B_n and A_n coefficients, complex terms of the form $C_n = B_n + iA_n$ are used, to then talk about magnitude and phase of the harmonics.

You can find derivations of the above in the references, for ex. [1].

Each multipole term corresponds to a field distribution; they can be added up (exploiting linear superposition)

B_1 : normal dipole

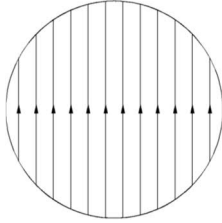

B_2 : normal quadrupole

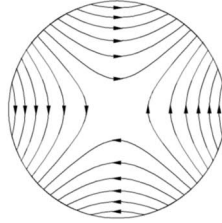

B_3 : normal sextupole

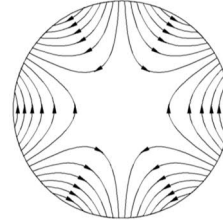

A_1 : skew dipole

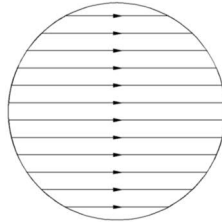

A_2 : skew quadrupole

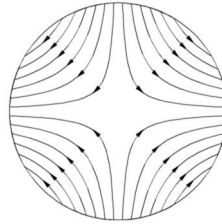

A_3 : skew sextupole

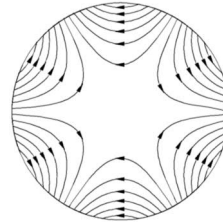

20

Each term – taken individually – has a sort of specific meaning, both to the magnet designer and to the beam physicist.

The *normal* family involves a field perpendicular to the $y = 0$ line, that is, vertical field in the horizontal (usually) plane. In the *skew* family, the field is tangential to the same $y = 0$ line, that is, we have horizontal field in the horizontal (usually) plane.

The skew types are obtained from the normal ones with a $360/(4n)$ deg rotation, ex. 90 deg for a dipole, 45 deg for a quadrupole, 30 deg for a sextupole.

We consider from now on only magnets in the normal family, not the skew ones, which are anyway just the same rotated.

The field profile in the horizontal plane follows a polynomial expansion

$$B_y(x) = \sum_{n=1}^{\infty} B_n \left(\frac{x}{R}\right)^{n-1} = B_1 + B_2 \frac{x}{R} + B_3 \frac{x^2}{R^2} + \dots$$

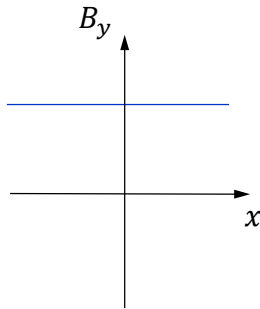

B_1 : dipole

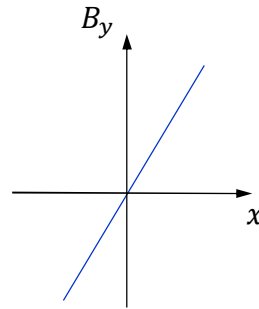

B_2 : quadrupole

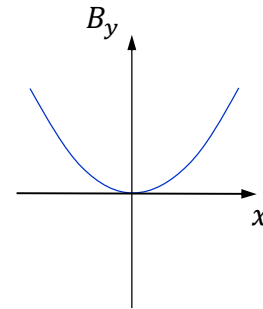

B_3 : sextupole

$$G = \frac{B_2}{R} = \frac{\partial B_y}{\partial x}$$

$$B'' = \frac{2B_3}{R^2}$$

The field expansion along x – that is, in the horizontal (usually) plane – is a polynomial in x/R , with the same coefficients B_n of the multipole expansion.

The dipole is the B_1 term, which provides a field constant in space.

The quadrupole is connected to the B_2 term. A quadrupole has a linear variation of B_y vs. x . In the center, there is no field. The gradient of a quadrupole is the slope of the B_y vs. x line and it is measured in T/m. It turns out that B_x is also linear vs. y – in the vertical plane – with the same gradient.

The B_3 term corresponds to a sextupole. Here the field dependency is quadratic in x . In the center, there is no field and no field gradient. A sextupole is usually characterized by the second derivative of B_y vs. x . The sextupole can be thought of as a quadrupole where the gradient (slope) changes linearly with the radial displacement x .

For the optics, usually the field or multipole component is given, together with the (magnetic) length: ex. from MAD-X

Dipole

bend angle a [rad] & length L [m]

k_0 [1/m] & length L [m]

$$k_0 = B / (B\rho)$$

obsolete

$$B = B_1$$



Quadrupole

quadrupole coefficient k_1 [1/m²] \times length L [m]

$$k_1 = (dB_y/dx) / (B\rho)$$

$$G = dB_y/dx = B_2/R$$

Sextupole

sextupole coefficient k_2 [1/m³] \times length L [m]

$$k_2 = (d^2B_y/dx^2) / (B\rho)$$

$$(d^2B_y/dx^2)/2! = B_3/R^2$$

22

In a lattice code, usually magnetic elements are described as a uniform dipole / quadrupole / sextupole (or other) field times a magnetic length. The product of the 2D field (or gradient) times the length is the integrated strength.

In many cases, quadrupoles, sextupoles and the alike can be considered as *thin lenses*, so basically only the integrated strengths matter.

MAD-X normalizes the coefficients dividing by the beam rigidity $B\rho$. The length definitions for an SBEND (sector bending magnet) and an RBEND (rectangular bending magnet) are different and they can be found in the MAD-X documentation.

For quadrupole, sextupole and higher order magnets, to avoid ambiguity it is good to quote the pole tip field, or the field at the reference radius. The pole tip field is

$$\text{quadrupole: } B_{\text{pole}} = G \cdot r = B_2 \cdot (r/R)$$

$$\text{sextupole: } B_{\text{pole}} = B_3 \cdot (r/R)^2$$

where r is the radius at the pole tip, and R the reference radius for the harmonics. In a dipole, $B_{\text{pole}} = B$, since the field is uniform.

Note: for MAD-X, B_0 is a dipole, B_1 is a quadrupole, B_2 is a sextupole, etc. while for (most) magnet people $n = 1$ is a dipole, $n = 2$ is a quadrupole, etc.

Here is how to compute magnetic quantities from MAD-X entries, and vice versa



```
BEAM, PARTICLE=ELECTRON,PC=3.0;  
DEGREE:=PI/180.0;  
QF: QUADRUPOLE,L=0.5,K1=0.2;  
QD: QUADRUPOLE,L=1.0,K1=-0.2;  
B: SBEND,L=1.0,ANGLE=15.0*DEGREE;
```

$$(B\rho) = 10^9/c*PC = 10^9/299792485*3.0 = 10.01 \text{ Tm}$$

dipole (SBEND)

$$B = |\text{ANGLE}|/L*(B\rho) = (15*\text{pi}/180)/1.0*10.01 = 2.62 \text{ T}$$

quadrupole

$$G = |K1|*(B\rho) = 0.2*10.01 = 2.00 \text{ T/m}$$

23

The BEAM command has several possible entries. In this case, PC is specified, which is the particle momentum times the speed of light, in GeV. The CHARGE is not specified, so the program assumes the default of 1 proton charge. Then the beam rigidity can be computed as

$$\text{BRHO} = \text{PC} / (|\text{CHARGE}| * c * 1.e-9)$$

For an SBEND, the declared length is the arc length of the reference orbit, so the dipole magnetic field is computed as shown; by the way, 2.62 T is rather an uncommon value for the field – too high for a usual resistive magnet, too low (that is, not worth) for a usual superconducting one.

For an RBEND, some trigonometry is needed as (normally) the length is taken along a straight line joining the entry and exit point, so in that case

$$B = 2/L*\sin(|\text{ANGLE}|/2)*(B\rho).$$

The gradient of a quadrupole *per se* does not mean much: what matters is gradient and aperture. In this case, for example, if we had a 100 mm bore diameter, then we would have 0.1 T (= 2.0*0.050) as B_{pole} . This is quite low also for resistive magnets, so maybe – from the magnet viewpoint – we could have the same integrated gradient with a shorter but stronger magnet.

The harmonic decomposition is used also to describe the field quality (or field homogeneity), that is, the deviations of the actual B with respect to the ideal one

(normal) dipole

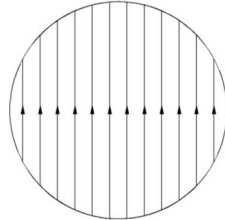

$$\vec{B}_{id}(x, y) = B_1 \vec{j}$$



$$B_y(z) + iB_x(z) = B_1 + \frac{B_1}{10000} \left[ia_1 + (b_2 + ia_2) \left(\frac{z}{R}\right) + (b_3 + ia_3) \left(\frac{z}{R}\right)^2 + (b_4 + ia_4) \left(\frac{z}{R}\right)^3 + \dots \right]$$

$$b_2 = 10000 \frac{B_2}{B_1} \quad b_3 = 10000 \frac{B_3}{B_1} \quad a_1 = 10000 \frac{A_1}{B_1} \quad a_2 = 10000 \frac{A_2}{B_1} \quad \dots$$

24

The simulated or measured field is often decomposed in multipole coefficients. This decomposition holds in 2D, or in 3D for the integrated field along the longitudinal direction, and it is valid up to a radius within which no current or magnetic material is present. R is a reference radius. This is often referred to as the good field region (GFR). A typical value for R is 2/3 of the physical aperture radius.

Taking for example a dipole, in the ideal case only one term – B_1 – is present in the series. In reality, all other terms are there, though most often only the lower order ones give a somehow significant contribution. We express these unwanted components (errors) normalized to the fundamental (or main) component, and multiplied by 10000. Usually the upper case B_n , A_n are used for the not normalized coefficients – measured in Tesla, according to our definition – while the lower case b_n , a_n are reserved for the normalized terms, which are expressed in units of 10^{-4} .

The b_n , a_n terms are typically a few units for well designed and well built dipoles and quadrupoles. Higher values often come for sextupoles and correctors, whose absolute strength is anyway much smaller than the bending and focusing magnets in the lattice.

Note: some terms can also come from a misalignment of the magnet, for example for a dipole a_1 (skew dipole, or horizontal dipole) is connected to a roll angle misalignment.

The same expression can be written for a quadrupole



(normal) quadrupole

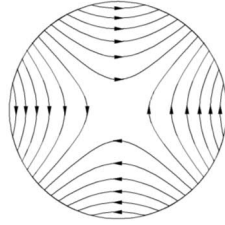

$$\vec{B}_{id}(x, y) = B_2 [x\vec{j} + y\vec{i}] \frac{1}{R}$$

$$B_y(z) + iB_x(z) =$$

$$= B_2 \frac{z}{R} + \frac{B_2}{10000} \left[ia_2 \left(\frac{z}{R} \right) + (b_3 + ia_3) \left(\frac{z}{R} \right)^2 + (b_4 + ia_4) \left(\frac{z}{R} \right)^3 + \dots \right]$$

$$b_3 = 10000 \frac{B_3}{B_2} \quad b_4 = 10000 \frac{B_4}{B_2} \quad a_2 = 10000 \frac{A_2}{B_2} \quad \dots$$

25

For a quadrupole, the relative multipole errors are a_2, b_3, a_3, b_4, a_4 , etc., and they are obtained by normalizing the upper case coefficients by B_2 .

Usually no dipole errors (b_1, a_1) are considered in a quadrupole, as these correspond to a transverse shift of the magnetic centre (axis, in 3D); in that case, the harmonic decomposition is re-expressed taking as the center of the circle the point where there is no field (no integrated field in 3D).

Note: also for a quadrupole, some multipole errors can come from a misalignment of the magnet, for example a roll angle gives rise to an a_2 (skew quadrupole) term.

The *allowed / not-allowed* harmonics refer to some terms that shall / shall not cancel out thanks to design symmetries

fully symmetric dipoles

allowed: $B_1, b_3, b_5, b_7, b_9, \text{etc.}$

not-allowed: all the others



half symmetric dipoles

allowed: $B_1, b_2, b_3, b_4, b_5, \text{etc.}$

not-allowed: all the others



fully symmetric quadrupoles

allowed: $B_2, b_6, b_{10}, b_{14}, b_{18}, \text{etc.}$

not-allowed: all the others

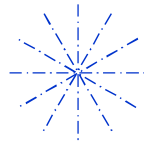
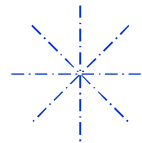

fully symmetric sextupoles

allowed: $B_3, b_9, b_{15}, b_{21}, \text{etc.}$

not-allowed: all the others

We like to divide the multipole errors in two families: allowed and not-allowed (or random).

The not-allowed (or random) terms are the ones that should not be there, thanks to symmetries in the design. They then arise due to asymmetries introduced during the fabrication.

The allowed multipoles are the ones that are allowed by the symmetries, that is, that are expected by design even if no asymmetries are introduced during the fabrication. Part of the magnetic design focuses to optimize the geometry to cancel out these terms.

The SPS (a hybrid between an H-shape and a window frame) main dipoles are fully symmetric dipoles. The HERA or Tevatron superconducting magnets are also fully symmetric.

Half symmetric dipoles are resistive magnets with a C-shape yoke, for ex. the ones of various light sources (ANKA, DIAMOND) or the LEP dipoles. The LHC main dipoles are also – technically speaking – in this family, since there is a double aperture breaking the full (left/right) symmetry, though the design of each aperture separately is fully symmetric.

The field quality is often also shown with a $\Delta B/B$ plot



$$\frac{\Delta B}{B} = \frac{B(x, y) - B_{id}(x, y)}{B_{id}(x, y)}$$

done on one component,
usually B_y for a dipole

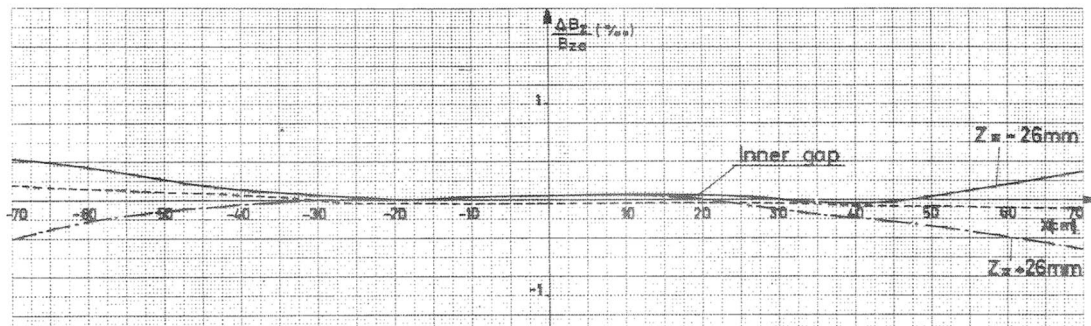

27

The field quality is also often expressed in terms of $\Delta B/B$, where ΔB is the difference between the actual field B and the ideal distribution B_{id} , normalized by the ideal distribution B_{id} . Since B is a vector field, this is often done either on one component (the main one) or on the modulus.

The plots on graph paper are measured field error curves (1970) inside the CERN PSB (PS Booster) prototype bending magnet inner gap. The abscissa is the radial position in the magnet aperture in mm. This specific magnet has a (wide) pole of 460 mm width, for 70 mm of vertical gap.

These $\Delta B/B$ plots are typically used for resistive dipoles, which often have much of a rectangular (i.e., not circular) aperture, so where using the standard harmonic decomposition is not convenient.

$\Delta B/B$ can (at least locally) be expressed from the harmonics:
this is the expansion for a dipole



$$B_{y,id}(x) = B_1$$

$$B_y(x) = B_1 + \frac{B_1}{10000} \left[b_2 \left(\frac{x}{R} \right) + b_3 \left(\frac{x}{R} \right)^2 + b_4 \left(\frac{x}{R} \right)^3 + \dots \right]$$

$$\frac{\Delta B}{B}(x) = \frac{1}{10000} \left[b_2 \left(\frac{x}{R} \right) + b_3 \left(\frac{x}{R} \right)^2 + b_4 \left(\frac{x}{R} \right)^3 + \dots \right]$$

28

The $\Delta B/B$ can be built up starting from the harmonics, at least in the region where the harmonics hold. Going the other way around – from $\Delta B/B$ to multipoles – is not (mathematically speaking) really possible, but it is also done anyway.

In the case of a dipole, we consider the vertical field along the midplane, that is, $B_y(x)$ along the $y = 0$ line. The $\Delta B/B$ plot is made up of several contributions coming from b_2 (quadrupole, linear), b_3 (sextupole, quadratic), b_4 (octupole, cubic) and so on.

Note 1: the harmonic expansion is valid only within a circle not containing current or magnetic material. For resistive dipoles – even with wide poles – the same polynomial expansion is used in practice with the coefficients of the powers in x/R still called “quadrupole”, “sextupole” and so on.

Note 2: deriving the multipoles from the $\Delta B/B$ is (mostly) done using some polynomial fitting, though the base functions are now not orthogonal...

1. Introduction, jargon, general concepts and formulae
2. Resistive magnets
3. Superconducting magnets
4. Tutorial with FEMM

Resistive magnets are in most cases “iron-dominated”: the BH response of the yoke material is important

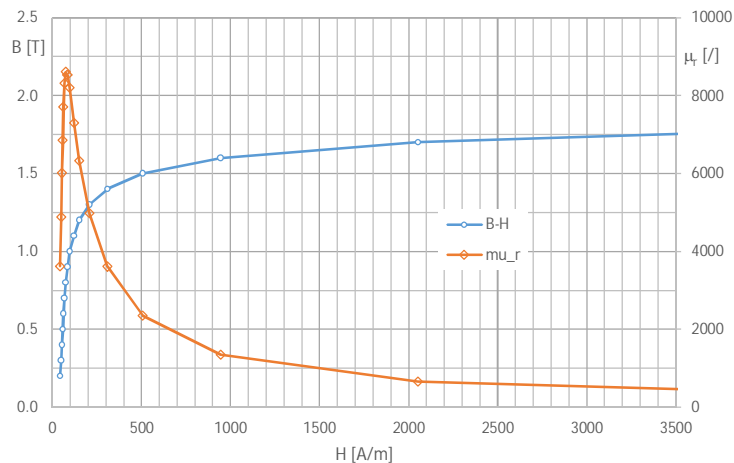

curves for typical M1200-100 A electrical steel

30

Iron greatly enhances the field in the aperture of a magnet up to about 2 T. It does so by collecting the flux lines – which tend to fill space with high relative magnetic permeability – and by adding its own magnetization to the field produced by the windings (or the permanent magnets).

Iron has a typical magnetic B-H characteristics. It is basically linear up to about 1.2-1.3 T – the actual knee depends on the grade of the material – to then saturate.

The same can be looked at in terms of relative permeability μ_r versus H, which has a peak of a few thousands to then decrease with the saturation.

At low field the permeability of the material is not well behaved: the iron has to be “woken up”. Then remanence effects due to hysteresis can be important.

In most cases, the material used in the yokes of resistive magnets is an electrical steel: Fe + a few % of other elements, mainly Si (up to about 3%), to increase the resistivity (and so decrease eddy currents) and to minimize the hysteresis cycle. These are called electrical steels, or Si steel. They are the same used for electrical machines like transformers, generators, motors, etc.

These are typical fields for resistive dipoles and quadrupoles, taken from machines at CERN

PS @ 26 GeV

combined function bending $B = 1.5 \text{ T}$

SPS @ 450 GeV

bending

$B = 2.0 \text{ T}$

quadrupole

$B_{\text{pole}} = 21.7 * 0.044 = 0.95 \text{ T}$

TI2 / TI8 (transfer lines SPS to LHC, @ 450 GeV)

bending

$B = 1.8 \text{ T}$

quadrupole

$B_{\text{pole}} = 53.5 * 0.016 = 0.86 \text{ T}$

31

The range of B fields covered by resistive magnets can be wide. Just to have some terms of comparison, here we take a look at the fields in the gap of dipoles and pole tip fields of quadrupoles for the largest CERN (resistive) synchrotrons and transfer lines.

The PS – CERN's oldest running machine – has combined function bending magnets with a central gap field of about 1.5 T. These magnets are C shaped.

The SPS – CERN's largest resistive synchrotron – has bending magnets which run up to 2.0 T and quadrupoles with pole tip fields up to about 1.0 T. Pushing the central field above that in a large resistive machine is not realistic, because of the large electric consumption.

For the long transfer lines from the SPS to the LHC (combined length of 5.6 km), the dipoles run at 1.8 T while the quadrupoles are designed for 0.9 T at the pole tip.

Note: the pole tip field of quadrupoles (and sextupoles, etc.) is smaller than what can be achieved in a dipole, as this kind of magnets “collect flux lines in the yoke”, that is, there is more field in the iron that you do not have in the useful (good field region) part of the air gap.

This is the (average) transfer function field B vs. current I for the SPS main dipoles

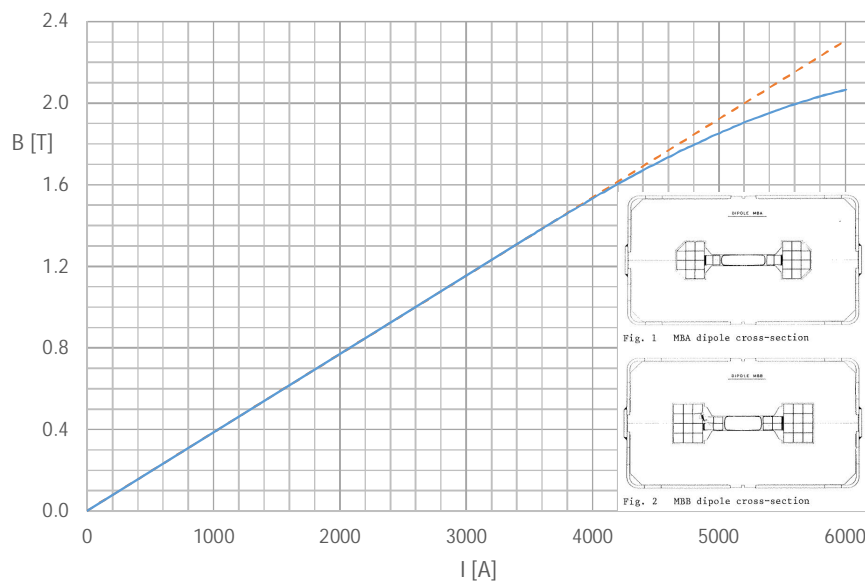

32

As an example of magnets working into saturation, we show the transfer function of the SPS main dipoles at CERN.

The plot is the actual calibration curve used by operation at CERN, which is the average of $384 + 360 = 744$ bending magnets, powered in series. The dashed line is an extrapolation of the initial linear part, that is, it represents the field if there were no saturation. At 6 kA the efficiency (the ratio of the two curves) is 89%.

When injecting beams into the LHC, the SPS works up to 450 GeV, with a field of 2.02 T.

If the magnet is not dc, then an rms power / current is taken, considering the duty cycle



$$P_{rms} = RI_{rms}^2 = \frac{1}{T} \int_0^T R[I(t)]^2 dt$$

for a pure sine wave $I_{rms} = \frac{I_{peak}}{\sqrt{2}}$

for a linear ramp from 0 $I_{rms} = \frac{I_{peak}}{\sqrt{3}}$

33

The subscript rms stands for root mean square. I_{rms} is the effective current, that is, the one which is equivalent w.r.t. the losses per Joule heating in a cycle.

If the magnet is operated in dc, then peak and rms values are the same thing.

The same concept is used routinely in electrical systems working in ac. Duty cycles of synchrotrons often involves linear ramps up / down, and possibly some flats for beam injection / extraction – rather than pure sinusoidal oscillations – so the corresponding rms values have to be computed case by case.

This is a cycle to 2.0 GeV of the PSB at CERN

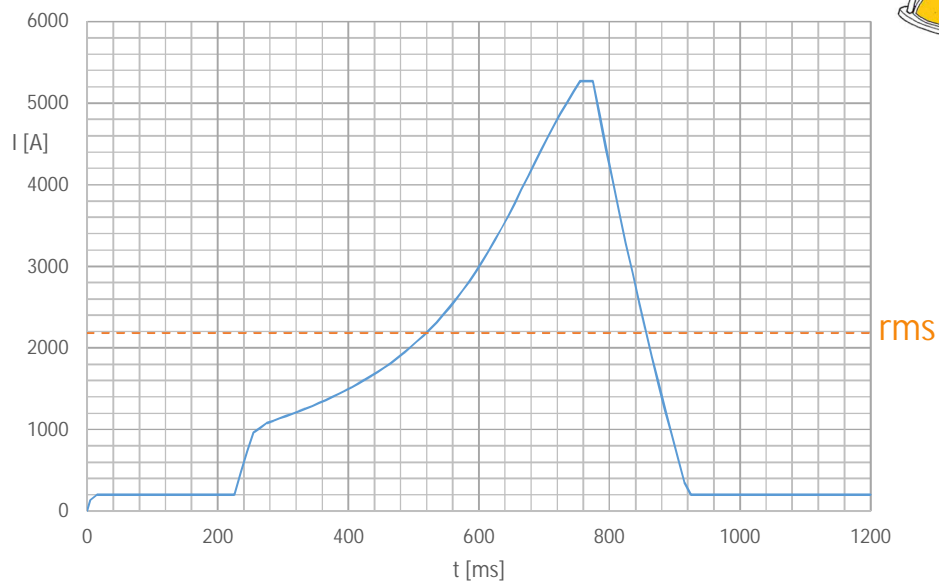

34

As an example of a computation of rms current, we show a typical cycle – current I vs. time t – of the main dipoles of the PS Booster at CERN. The machine till a few years ago accelerated beams up to 1.4 GeV, though it was recently pushed with an upgrade to 2.0 GeV. The peak current is 5.3 kA, but the rms current is (only) 2.2 kA.

The ramp up (with beam in) is much gentler than the ramp down (without beam).

For resistive coils, the material is most often copper, sometimes aluminum

	Cu	Al
raw metal price	≈ 8400 \$/ton	≈ 2300 \$/ton
electrical resistivity	$1.72 \cdot 10^{-8} \Omega/\text{m}$	$2.65 \cdot 10^{-8} \Omega/\text{m}$
density	8.9 kg/dm ³	2.7 kg/dm ³

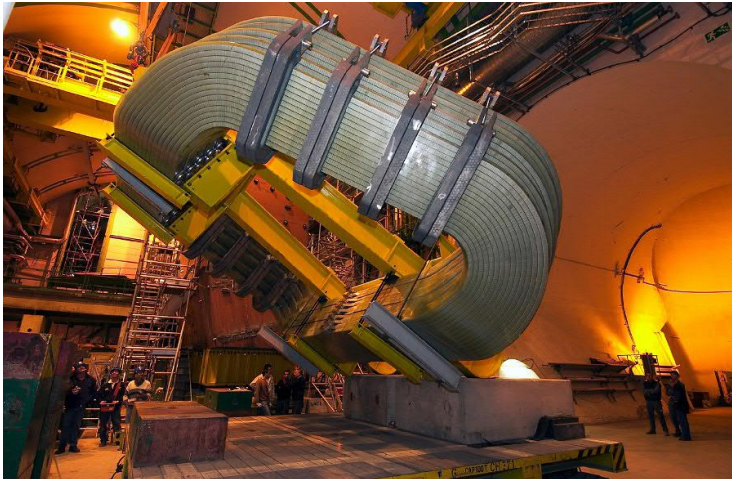

LHCb detector dipole Al coils
coil mass $2 \times 25 \text{ t}$
power $2 \times 2.1 \text{ MW}$

Usually resistive coils are either in copper or aluminum.

Copper is the most common choice nowadays for accelerator magnets, as it offers a lower resistivity. The SPS magnets at CERN have coils in copper. This was also the choice for all new resistive magnets at CERN in the last years.

Sometimes aluminum becomes interesting because it is lightweight and less expensive, also when additional material is added to keep the resistance (and power) of the coil low. The PS main units at CERN are in aluminum, which was chosen for economical reasons. Also the LEP main bending magnets – always at CERN – were powered with aluminum busbars. Aluminum is used routinely in electrical power transmission lines.

The resistances are given at 20 °C. Both Cu and Al become more resistive as the temperature increases, with about a 4‰ increase per degree.

The raw metal prices evolve continuously, the values are just to give an idea. [In 2019 they were 5000 and 1500 \$/ton for Cu and Al, respectively]

These are the most common types of resistive dipoles

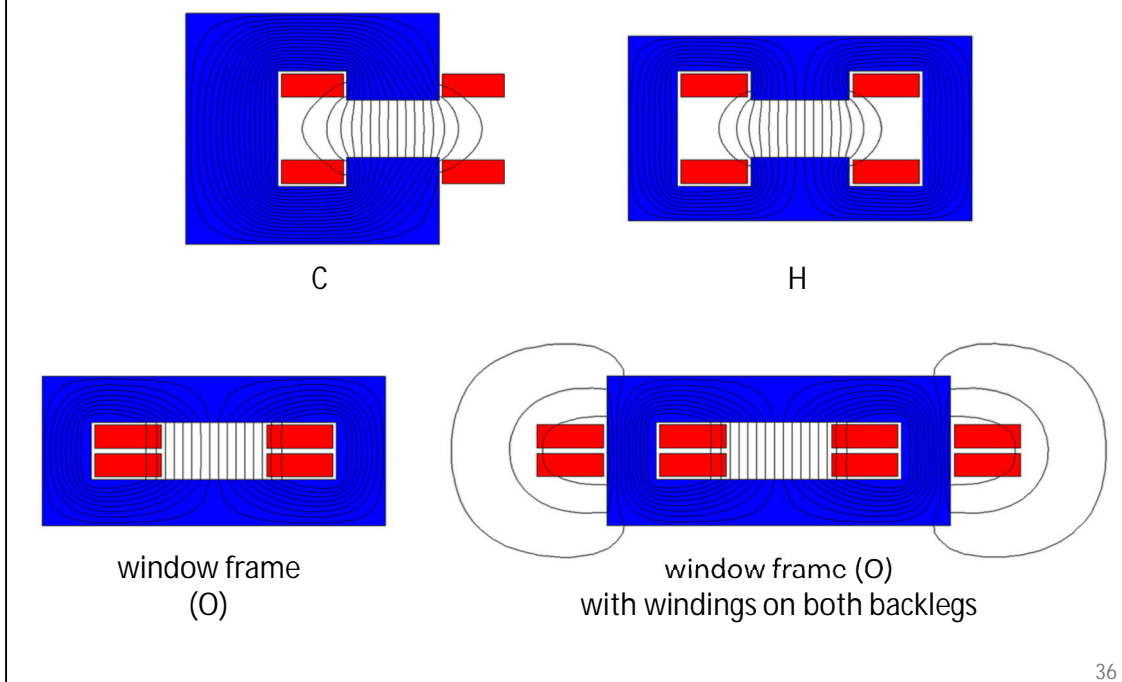

36

The C shape provides easy access to the gap for the vacuum chamber – for this it is often found in light sources – at the cost of a (slight) asymmetry, which introduces the even terms in the allowed multipoles, in particular the quadrupole (gradient).

The H shape is symmetric, at the cost of some access problems to the gap. For the same field, this is more compact and mechanically stable than a C. The coils can extend till the midplane – like in the SPS case, which is then a hybrid between an H and a window frame – though then they need to be bent up in the ends to clear the gap region. If the coil gets close to the aperture, then its position can have an impact on field quality, especially at higher fields.

The window frame geometry provides the best field quality, thanks to the extra wide pole; it has the same access problems of the H, plus there has to be enough room to dimension the coil properly. As for the other cases, the position of the windings can impact the field quality if the coil gets very close to the gap. This type is often used for correctors, where the field is low, with the coils wound on the return legs (figure on the bottom right). In this latter configuration, it is somehow inefficient in 2D – the outer conductors are useless to create field in the gap. In practice, this layout is still convenient for short magnets. The return current on the outside adds flux in the side legs of the magnets, so more material is needed if the working point becomes close to saturation – which is not an issue if the magnet works at low field, like a corrector.

The magnetic circuit is dimensioned so that the pole is wide enough for field quality, and there is enough room for the flux in the return legs

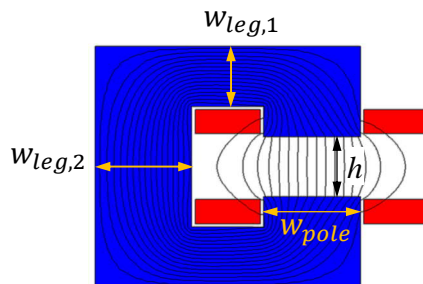

$$w_{pole} \cong w_{GFR} + 2.5h$$

$$B_{leg} \cong B_{gap} \frac{w_{pole} + 1.2h}{w_{leg}}$$

37

The magnetic circuit is designed in 2D as follows:

- * the pole is wide enough to provide the required field homogeneity in the good field region; its actual width depends if we have (or not) pole shims, if the magnet is saturated, if we want a field uniformity in the 10^{-2} , 10^{-3} or 10^{-4} level, etc., though the above formula provides a good first guess in many cases;

- * to dimension the return legs, we consider that the flux in the yoke includes the flux in the gap, but also some stray flux. The stray flux extends about one gap width on either side of the aperture. The width of the legs is chosen to limit the B in the yoke, usually below saturation, so to work in the high permeability regime of the material.

Note: the density of the flux lines in the figure is – well – the flux density, that is, the B field (Faraday); in this example, B is higher in the top / bottom legs than in the back one.

The Ampere-turns are a linear function of the gap and of the B field (at least up to saturation)

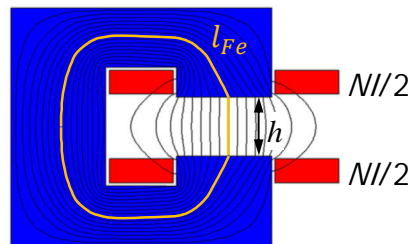

$$NI = \oint \vec{H} \cdot d\vec{l} = \frac{B_{Fe}}{\mu_0 \mu_r} \cdot l_{Fe} + \frac{B_{gap}}{\mu_0} \cdot h \cong \frac{B_{gap} h}{\mu_0}$$

$$NI = \frac{Bh}{\eta \mu_0} \quad \eta = \frac{1}{1 + \frac{1}{\mu_r} \frac{l_{Fe}}{h}}$$

38

The basic formula to compute the Ampere-turns needed for a given field and vertical gap can be derived from the circulation of H around a flux line (Ampere's law).

The term with B_{Fe} , l_{Fe} and μ_r is difficult to expand exactly – those can actually be interpreted as average ones along the integral – however it does not matter. In fact, B_{Fe} is similar to B_{gap} , while μ_r has a high value (thousands, unless the iron is heavily saturated) which makes that contribution small. For this reason, the simple formula on the bottom, with just B, can be used.

The concept of magnetic efficiency η can also be introduced. Typical values are above 95%.

The same can be solved using magnetic reluctances and Hopkinson's law, which is a parallel of Ohm's law



$$\mathcal{R} = \frac{NI}{\Phi}$$

$$R = \frac{V}{I}$$

$$\mathcal{R} = \frac{l}{\mu_0 \mu_r A}$$

$$R = \frac{l}{\sigma S}$$

$$\eta = \frac{1}{1 + \frac{\mathcal{R}_{Fe}}{\mathcal{R}_{gap}}}$$

39

There is a simple parallel between magnetic circuits and electrical ones:

- * voltage drop ---> magnetomotive force
- * resistance ---> reluctance
- * current ---> flux
- * Ohm's law ---> Hopkinson's law

NI – the Ampere-turns – is the magnetomotive force.

A and l are the cross section of the magnetic circuit and its length. In 2D, the area A is the width of the magnetic circuit * 1 m.

The B field (flux density) is then the flux Φ divided by the section A.

The Ampere-turns spent in the yoke are like the voltage drop spent in connection wires in an electric circuit.

For a C dipole, there are two main magnetic reluctances in series: the one for the air gap (usually predominant) and the one for the iron.

Example of computation of Ampere-turns and current

central field $B = 1.5 \text{ T}$

total gap 80 mm

$$NI = \frac{Bh}{\eta\mu_0}$$

$\eta \cong 0.97$

$$NI = (1.5 \cdot 0.080) / (0.97 \cdot 4 \cdot \pi \cdot 10^{-7}) = 98446 \text{ A total}$$

low inductance option

64 turns, $I \cong 98500/64 = 1540 \text{ A}$

$L = 62.9 \text{ mH}$, $R = 15.0 \text{ m}\Omega$

low current option

204 turns, $I \cong 98500/204 = 483 \text{ A}$

$L = 639 \text{ mH}$, $R = 160 \text{ m}\Omega$

40

These values are actually taken from existing magnets, designed in the 1970s at CERN: the so-called MCAs and MCBs. The yoke is identical in the two cases, just the coils are different, with a high current / low inductance and a low current / high inductance designs. The iron length is 2.5 m. As the magnetic energy ($1/2 \cdot L \cdot I^2$) is basically the same, the inductance scales with (number of turns)².

Having a small number of turns carrying a large current brings down the inductance. This can be convenient if the machine is ramped or pulsed, as the inductive voltage $L \cdot di/dt$ is the main voltage. On the other hand, high current means larger cables and connections.

The same Ampere-turns can be achieved with a higher number of turns carrying a smaller current each. In this case the inductance is high, which is not an issue if the magnet is almost dc. The size of the cables and of the connections is smaller if the current is smaller.

Best practice wants to design the coil considering also iterations of the parameters with the colleagues of power converters.

Besides the number of turns, the overall size of the coil depends on the current density, which drives the resistive power consumption (linearly)

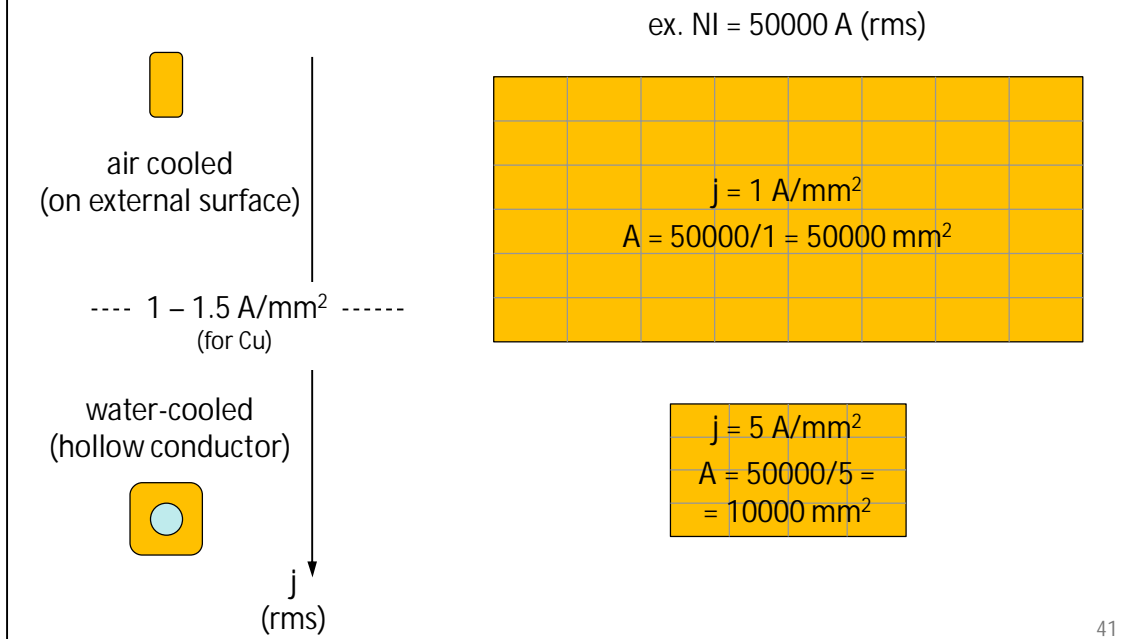

Given the Ampere-turns – which depend basically on the field strength B , the gap h and (to a lesser degree) the saturation level of the iron – the size of the coil depends on the current density j .

The dc resistive power dissipated in the windings scales linearly with j – at fixed field (that is, for the same Ampere-turns).

Below 1 – 1.5 A/mm² (rms) the coils are usually not directly cooled, that is, they are “air cooled” on the exterior by natural air convection. Above those current densities, direct water-cooling (with demineralized water circulating inside the conductor) is used. A typical value is now around 5 A/mm² (rms) for dipoles, usually higher for quadrupoles. For both air and water-cooled cases, for dc or slow magnets, what needs to be removed is the resistive electrical power, that is $R \cdot I^2$. For very fast magnets, there are also eddy currents inside the conductor, which are not treated here.

The choice of j depends on several factors. For large machines, we look for a balance between an overall optimum of capital + running cost: large coils = large capital cost = low running (electricity) cost, and vice versa.

In other cases and for single or few magnets that need to be very compact, the current density can be much higher, like tens of A/mm².

These are common formulae for the main electric parameters of a resistive dipole (1/2)



Ampere-turns (total) $NI = \frac{Bh}{\eta\mu_0}$

current $I = \frac{(NI)}{N}$

resistance (total) $R = \frac{\rho N L_{turn}}{A_{cond}}$

inductance $L \cong \eta\mu_0 N^2 A/h$

$$A \cong (w_{pole} + 1.2h)(l_{Fe} + h)$$

42

NI	[A]	total (not per pole) Ampere-turns
B	[T]	field in the aperture
h	[m]	full vertical gap
μ_0	[H/m]	vacuum permeability, $4\pi \cdot 10^{-7}$ H/m
η	[/]	magnetic efficiency, $\approx 0.95-0.98$ (depends on iron saturation)
I	[A]	current
N	[/]	total (not per pole) number of turns
R	[Ω]	resistance
L	[H]	inductance
ρ	[Ωm]	resistivity, $1.72 \cdot 10^{-8}$ Ωm for Cu, $2.65 \cdot 10^{-8}$ Ωm for Al, at 20 °C
L_{turn}	[m]	average length of a coil turn
A_{cond}	[m ²]	cross section of a single conductor (counting only the metal)
l_{Fe}	[m]	iron length, in 3D (longitudinal direction)
w_{pole}	[m]	pole width

The Ampere-turns NI are directly proportional to the field B and the vertical gap h. The formula holds in all cases, with the exception of the window frame layout with windings on both backlegs, where the Ampere-turns need to be doubled. The resistance depends on the resistivity ρ of the conductor and its cross section. The inductance depends quadratically on the number of turns; for the same gap, L is larger for a wider pole.

These are common formulae for the main electric parameters of a resistive dipole (2/2)



voltage $V = RI + L \frac{dI}{dt}$

resistive power (rms) $P_{rms} = RI_{rms}^2$
 $= \rho j_{rms}^2 V_{cond}$
 $= \frac{\rho L_{turn} B_{rms} h}{\eta \mu_0} j_{rms}$

magnetic stored energy $E_m = \frac{1}{2} LI^2$

43

V	[V]	voltage
dI/dt	[A/s]	current ramp rate
P _{rms}	[W]	resistive power (rms)
j _{rms}	[A/m ²]	current density (rms)
V _{cond}	[m ³]	volume of conductor
E _m	[J]	magnetic stored energy

The voltage has a resistive and an inductive part. In cycled magnets, often the inductive voltage is larger than the resistive one.

The resistive power is usually looked at in rms terms. The formula can be used also for the peak power, just with the peak current instead of the rms one. For a given coil size, the power scales linearly with the field B, the gap h and the current density j.

The magnetic stored energy could be computed also from the energy per unit volume ($B^2/(2\mu)$). Since the permeability is usually quite high in the yoke, the magnetic energy is basically all stored in the air volume.

In their more general form, these equations hold also for other magnets, not just dipoles.

The table describes the field quality – in terms of allowed multipoles – for the different layouts of these examples



	C-shaped	H-shaped	O-shaped
b_2	1.4	0	0
b_3	-88.2	-87.0	0.2
b_4	0.7	0	0
b_5	-31.6	-31.4	-0.1
b_6	0.1	0	0
b_7	-3.8	-3.8	-0.1
b_8	0.0	0	0
b_9	0.0	0.0	0.0

b_n multipoles in units of 10^{-4} at $R = 17$ mm
 $NI = 20$ kA, $h = 50$ mm, $w_{\text{pole}} = 80$ mm

44

The allowed harmonics for the C and H designs contains rather large sextupoles b_3 and decapoles b_5 . Solutions to improve field quality involve adding side shims (discussed later) or widening the pole. Still, the differences between the asymmetric C and the symmetric H layouts are rather small.

The window frame – as expected – is better, as the pole is indeed much wider.

Note 1: in these examples, w_{pole} does not follow the rule $w_{\text{pole}} \approx w_{\text{GFR}} + 2.5h$, as here it is rather $w_{\text{pole}} \approx w_{\text{GFR}} + h$; this is why the field quality is somehow poor, in the 10^{-2} region.

Note 2: entries with a “0” correspond to not allowed harmonics

Note 3: it is possible to take the center of the C (for the beam) not in the middle of the pole, but where the good field region is wider. The improvement is minor.

These are the most common types of resistive quadrupoles

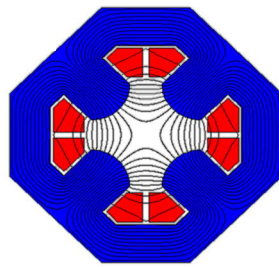

standard
quadrupole

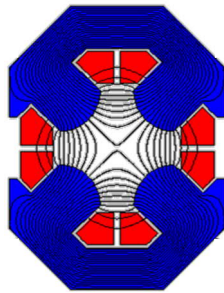
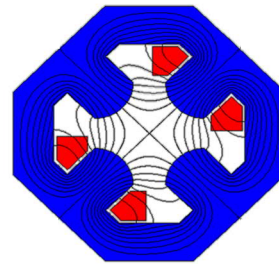

figure-of-8
(useful because
narrow)



quadrupole
with half the coils
(maybe not so common)

45

Resistive quadrupoles are most often of the standard type shown in the central top figure, with four symmetrical quadrants.

Sometimes figure-of-8 (referred to also as Collins) quadrupoles are used, with the magnetic circuit split in two halves. In this way, the magnets can be quite compact transversally, which might be needed in very crowded regions. For example, some quadrupoles in light sources are of this kind, to make room for outgoing photon beam lines. We also have a few of these at CERN, as first quadrupoles in an extraction line or after a switch dipole. This layout breaks the symmetry, somehow like the C-shape does in dipoles.

A quadrupole with only half the coils also works just fine for weak strengths, though it is seldom used to my knowledge.

Note: in the simulations, the same current density is applied to the various configurations, corresponding to a pole tip field (for the standard quadrupole in the top) of 0.8 T. This value starts to be on the high side for quadrupoles, as extra flux is then collected in the yoke from the pole sides. As a term of comparison, the SPS quadrupoles – which are quite “pushed” – have 1.0 T on the pole tip.

These are useful formulae for standard resistive quadrupoles



pole tip field $B_{pole} = Gr$

Ampere-turns (per pole) $NI = \frac{Gr^2}{2\eta\mu_0}$

current $I = \frac{(NI)}{N}$

resistance (total) $R = 4 \frac{\rho N L_{turn}}{A_{cond}}$

46

These formulae consider a standard quadrupole with 4 coils.

NI	[A]	Ampere-turns per pole
G	[T/m]	field gradient in the aperture
r	[m]	aperture radius
μ_0	[H/m]	vacuum permeability, $4\pi \cdot 10^{-7}$ H/m
η	[/]	magnetic efficiency, $\approx 0.95-0.98$ (depends on iron saturation)
I	[A]	current
N	[/]	number of turns per pole
R	[Ω]	total (not per coil) resistance
ρ	[Ωm]	resistivity, $1.72 \cdot 10^{-8}$ Ωm for Cu, $2.65 \cdot 10^{-8}$ Ωm for Al, at 20 °C
L_{turn}	[m]	average length of a coil turn
A_{cond}	[m ²]	cross section of a single conductor (counting only the metal)

The Ampere-turns NI depend now quadratically on the gap (r^2), not linearly as in the dipoles. The derivation is similar to that for the dipoles and it can be found in the references, ex. [4] and [6].

For the inductance, there is an approximate formula in [2]. For short magnets, 3D simulations or measurements are needed.

The resistive power can be computed from the current and the resistance, as for the dipoles.

These are useful formulae for the main cooling parameters of a water-cooled resistive magnet



cooling flow	$Q_{tot} \cong 14.3 \frac{P}{\Delta T}$	$Q_{tot} \cong N_{hydr} Q$
water velocity	$v = \frac{1000}{15\pi d^2} Q$	
Reynolds number	$Re \cong 1400dv$	
pressure drop	$\Delta p = 60L_{hydr} \frac{Q^{1.75}}{d^{4.75}}$	

47

The coolant is generally demineralized water.

Technical units are used in these formulae, taken from [2].

P	[kW]	power to be dissipated, that is, P_{rms} in most cases
ΔT	[°C]	water temperature increase between inlet and outlet typically up to 30 °C, in many cases lower
Q_{tot}	[l/min]	total (not per hydraulic circuit) flow rate
Q	[l/min]	flow rate per hydraulic circuit
N_{hydr}	[/]	number of hydraulic circuits in parallel
v	[m/s]	water velocity; for Cu conductor, typically < 3 m/s to avoid erosion problems, which could start already at 1.5 m/s
d	[mm]	diameter of the cooling duct
Re	[/]	Reynolds number, typically $2000 < Re < 10^5$, to have moderately turbulent flow
Δp	[bar]	pressure drop, typically around 10 bar
L_{hydr}	[m]	length of each hydraulic circuit in parallel this can be different from NL_{turn} , as there could be a difference between electrical and hydraulic circuits, with for example sub-coils all electrically in series, but hydraulically in parallel

The expressions are valid for water at around 40 °C. Other formulae are also used, see for ex. [4] and [6].

The *ideal* poles for dipole, quadrupole, sextupole, etc. are lines of constant scalar potential

dipole

$$\rho \sin(\theta) = \pm h/2 \quad y = \pm h/2 \quad \text{straight line}$$

quadrupole

$$\rho^2 \sin(2\theta) = \pm r^2 \quad 2xy = \pm r^2 \quad \text{hyperbola}$$

sextupole

$$\rho^3 \sin(3\theta) = \pm r^3 \quad 3x^2y - y^3 = \pm r^3$$

48

It can be shown – see for ex. [1] – that the ideal pole profiles are curves of constant scalar potential. This follows from the definition of the scalar potential itself (not covered here) and from the fact that the flux lines are perpendicular to the iron pole, if the iron permeability is infinite.

The expressions are quite neat in polar coordinates, though they become cumbersome – already for a sextupole – in Cartesian coordinates.

The ideal pole profile for a dipole is simply a straight line.

The ideal pole profile for a quadrupole is a hyperbola.

In my opinion, these formulae are more of academic interest, as anyway the pole is of finite width and its profile is optimized using some simulation tools. My personal preference is for simple profiles – i.e., profiles that can be described with line segments and circular arcs. This is often possible without any detrimental effect on field quality, especially when the pole is not very wide.

All these profiles can be derived also using conformal mapping. There is quite a bit of elegant complex mathematics in it, details can be found in some of the references.

As an example, this is the pole tip used in the SESAME quadrupoles vs. the theoretical hyperbola

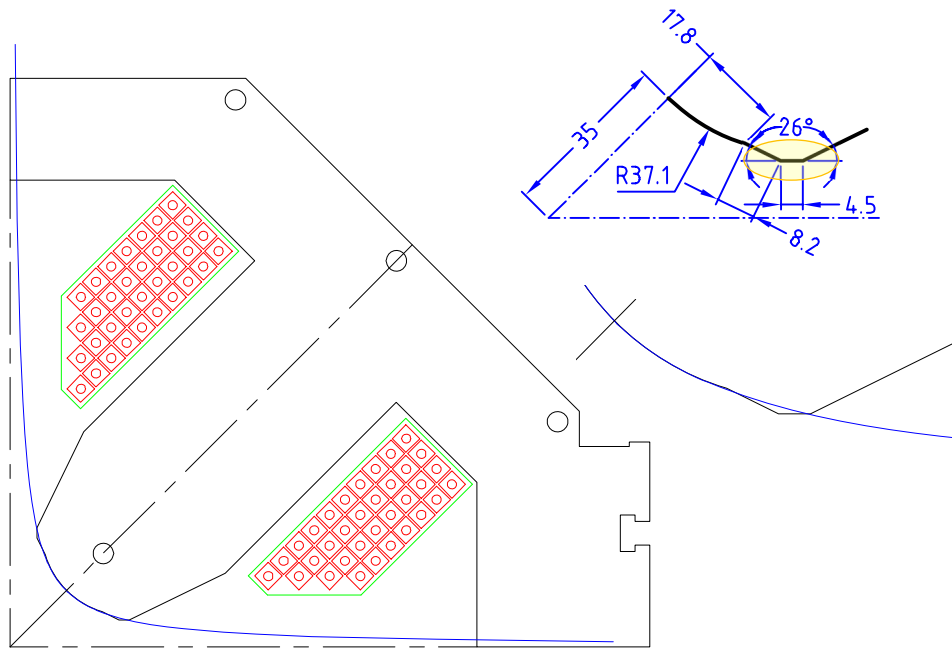

49

As an example of theoretical vs. real pole tip profile, we consider the quadrupoles for the SESAME light source.

The hyperbola extends till infinity, without space for the coils: this is not practical. The real pole shape is not far from the theoretical one, and then it is terminated with shims, which are used at the design stage to minimize the allowed harmonics, that is, to improve field quality. In a way, those shims bring in extra material, which is in a way substituting the one going all the way to infinity in the theoretical profiles.

In this specific case, the central part of the pole tip is not a hyperbola and the profile is described with lines and circular arcs – with no compromise on field quality. When designing the pole tip in 2D (with OPERA), the starting point for the radius of the central part of the pole was the curvature radius of the theoretical hyperbola – which turns out for a quadrupole to be simply equal to the aperture radius itself, 35 mm in this case.

This is the lamination of the LEP main bending magnets, with the pole shims well visible

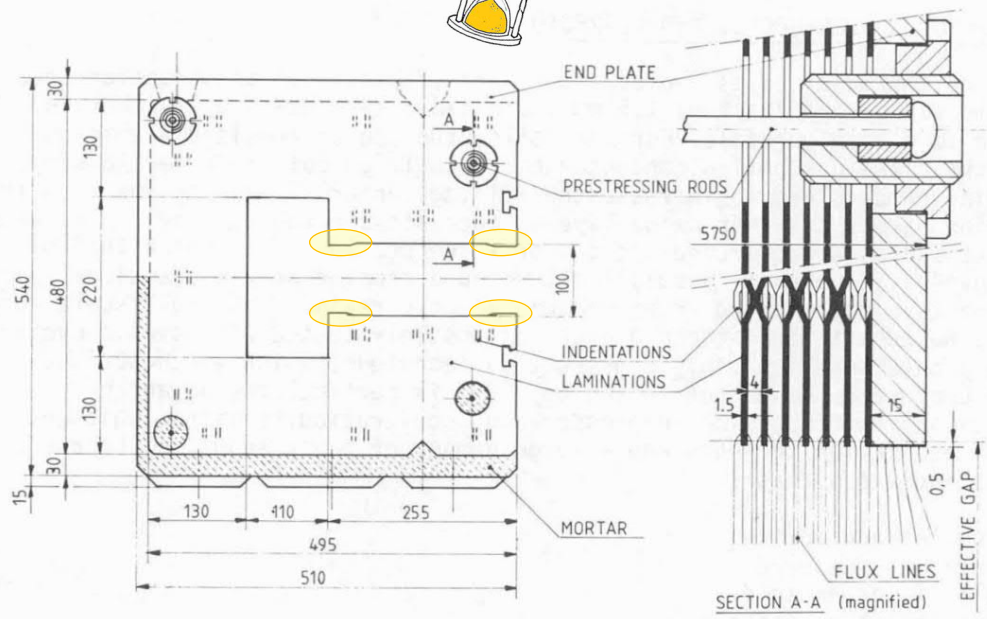

50

The ideal poles for a dipole are two infinite parallel lines. Wide poles indeed help for field quality – though they need to be terminated somewhere. At the extremes, shims are then introduced. For long magnets, their size and shape can be simulated in 2D to optimize the field quality. The real field quality will depend also on the mechanical tolerances and the possible asymmetry in the magnetic properties of the material.

Here the lamination for the LEP magnets is shown, where about $\frac{1}{4}$ of the pole width is actually used for shims.

These magnets were rather particular – see the right picture. The top field was only 110 mT, which allowed the yoke to be made in steel / concrete, with the steel being 30% in volume. This is referred to as dilution. We say that the stacking factor is 0.30. In the great majority of cases, the stacking factor is above 97%; the few % unoccupied by iron is taken up by insulation in within the laminations and voids.

In 3D, the longitudinal dimension of the magnet is described by a magnetic length

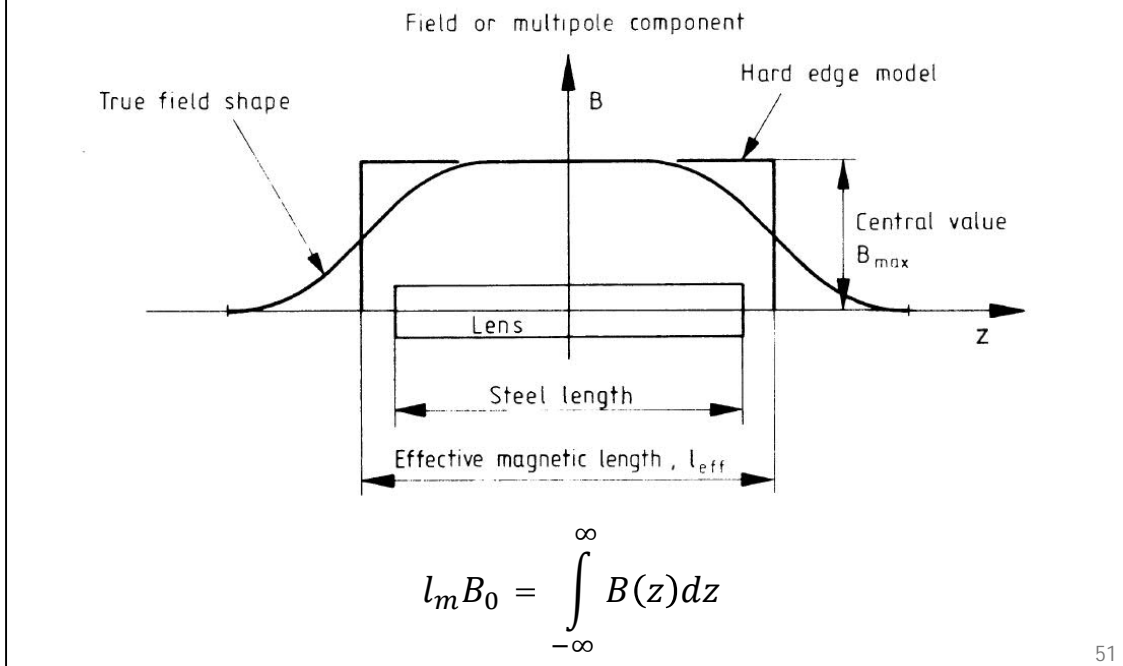

Looking along the longitudinal (z) direction, the field B is maximum at the center (z = 0) of the magnet, it is more or less constant till reaching the ends, where it rolls off to reach a 0 value outside. The magnetic length l_m is defined as that length which – multiplied by the central field value B_0 – provides the same integrated field.

The same holds substituting the field B with the gradient G, or with any multipole B_n, A_n . In this case, the integrals are carried out on the not-normalized (upper case) coefficients, and the normalized terms (lower case) are then obtained by dividing by the integral of the fundamental harmonic.

For long magnets – where the longitudinal dimension is much larger than the gap – the behavior is dominated by the (long) central part, so taking the values of 2D simulations and multiplying by a length yields good results. For short magnets, the behavior is intrinsically 3D.

The magnetic length can be estimated at first order with simple formulae

$$l_m > l_{Fe}$$



dipole

$$l_m \cong l_{Fe} + h$$

quadrupole

$$l_m \cong l_{Fe} + 0.80r$$

52

The magnetic length is larger than the iron length: there is some stray flux, that is, there is still some field left after the iron yoke terminates, since B rolls off in a continuous way.

The actual value of l_m depends mainly on the geometry of the pole ends – abrupt, with shims, with chamfers, with some rounded (Rogowski-like) profile – and on the iron saturation. The same magnet can actually have slightly different magnetic lengths when the excitation current – hence, the field level – is different. All these effects can be assessed precisely only by 3D simulations and measurements.

In most cases, though, it is possible to estimate at first order the length with the given simple formulae. In general, the higher the order of a magnet (quadrupole, sextupole, octupole, etc.), the less stray field is found on the axis at the ends, and the closer are the values of l_m and l_{Fe} .

Note: since in lattice codes l_m is used, crowded regions – with many nearby magnets – might have to be looked at in detail, to make sure there is enough physical space for the magnets and their coil ends. Moreover, there might be also some magnetic coupling between magnets which are installed very close to each other.

There are many different options to terminate the pole ends, depending on the type of magnet, its field level, etc.

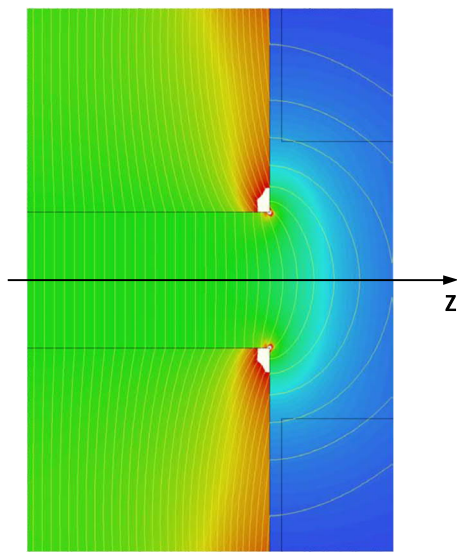

abrupt



DIAMOND dipole

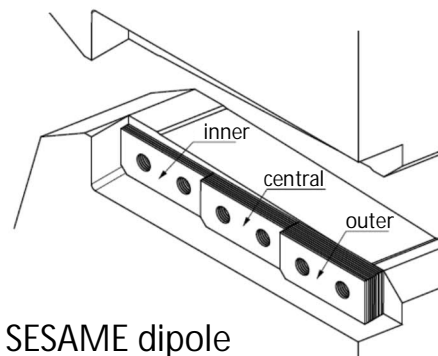

SESAME dipole

One option is to have square ends – the pole profile is simply extruded in 3D and then terminated abruptly (left figure). This introduces some field amplification in the end of the iron, that has to carry also the stray field that extends past I_{Fe} . This might lead to saturation and possibly non-linear behavior at different excitation currents.

Another possibility is to have end shims. These are also used to trim the actual iron length so to have a closer magnet-to-magnet reproducibility of the field integrals. The bottom right figure shows the design used for the SESAME combined function bending magnets, with three separate stacks to control integrated dipole, quadrupole and sextupole components separately (if needed).

Popular options are also 45 deg chamfers, which are often used for quadrupoles and sextupoles.

In some cases, a rounded Rogowski-like profile is used, to avoid flux concentration in the ends, like for the DIAMOND dipole shown in the top right figure.

In all cases, there is an impact on the magnetic length and on the integrated field quality; indeed, optimizing the termination of the poles is a main reason to set up 3D magnetic simulations.

Usually two dipole elements are found in lattice codes: the sector dipole (SBEND) and the parallel faces dipole (RBEND)

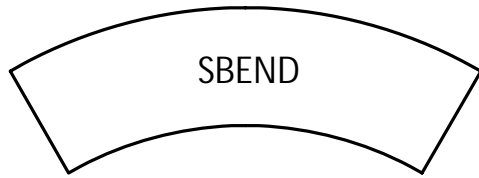

top views

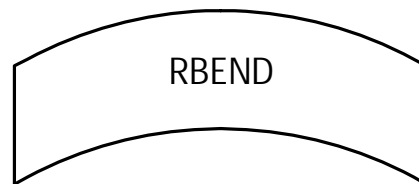

54

A sector dipole and a parallel faces (or rectangular) one both provide a region of space with constant field, though they have different focusing effects on the beam.

Other cases are possible, if the dipole ends are shaped with another angle with respect to the incoming / outgoing beam. This is not treated here.

Note: the curvature has no effect, it is just for saving material, otherwise the pole would have to be wider. In jargon, people talk about the *sagitta* of the beam going through a dipole and then evaluate whether to curve the magnet or not. The LHC dipoles are actually bent, by 9.1 mm. The SPS dipoles are not, that is, they are straight. In most light sources – where the bending radii are a few meters – the main dipoles are curved.

The two types of dipoles are slightly different in terms of focusing, for a geometric effect

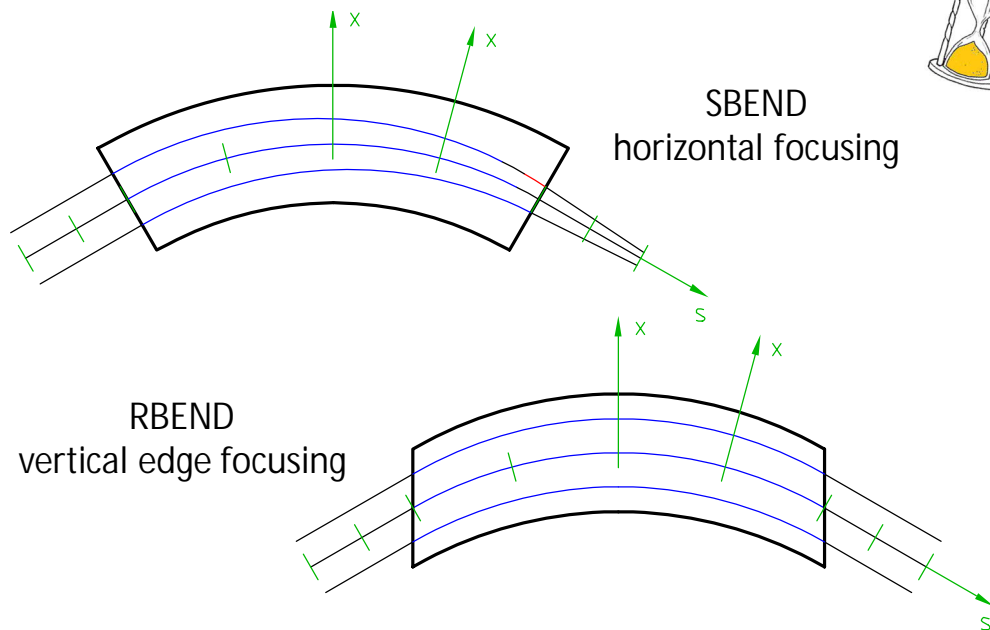

- and anything in between (playing with the edge angles) -

In a dipole, since the field is constant, particles are bent according to the same bending radius – given by the field and the beam rigidity.

In a sector dipole, there is a difference in how much space is travelled within the uniform field depending on the transverse position: a sector dipole focuses horizontally.

This effect is not there in parallel ended dipoles. However, these have an edge effect. Actually, the edges are defocusing, but the overall magnet has zero focusing horizontally. Still, it remains some vertical focusing at the edges. Most often, if the bending angle is not so high (at least up to 45 deg) parallel ended dipoles are more convenient to manufacture, as the yoke is built stacking up sheets of laminations (like a deck of cards) and the pole width is reduced because the sagitta of the beam does not need to be added.

These effects are handled differently in the various lattice codes, according to some assumptions on the field roll-off in the ends, that somehow gradually goes from a constant value (inside the dipole) to zero (outside). Some details about what MAD-X does are given in its documentation, in the section *Bending Magnet*.

1. Introduction, jargon, general concepts and formulae
2. Resistive magnets
3. Superconducting magnets (thanks to [Luca Bottura](#) for the material of many slides)
4. Tutorial with FEMM

This is a history chart of superconductors, starting with Hg all the way to HTS (High Temperature Superconductors)

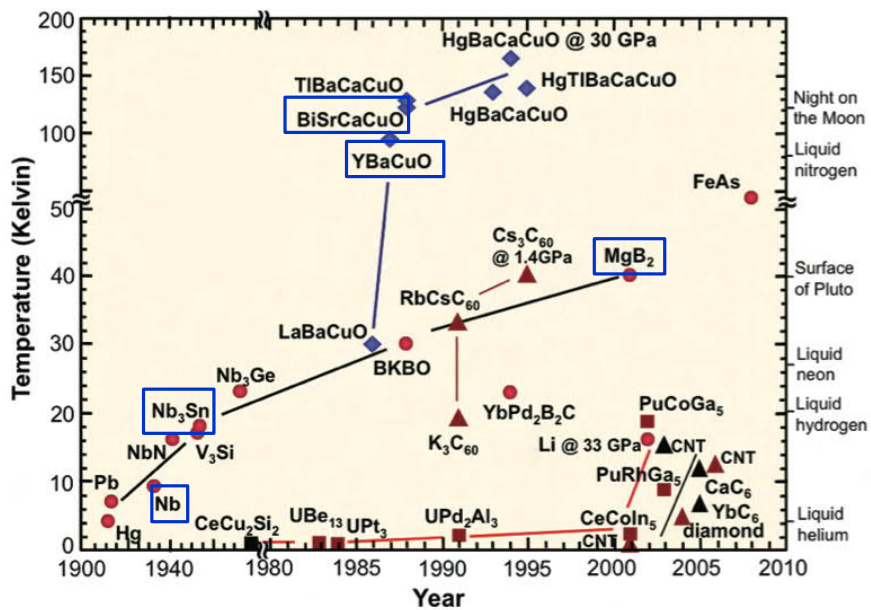

Superconductivity was discovered in the lab of Heike Kamerlingh-Onnes in Leiden (Netherlands) in 1911:

... mercury at 4.2 K has entered a new state, which, owing to its particular electrical properties, can be called the state of superconductivity ...

Since then, many superconducting material have been found, but only a few of them have some practical interest. The quest is (will ever be?) not over yet!

Note: the most used superconductor, Nb-Ti, is not shown on this plot... It was discovered in 1961 and it has a critical temperature of 9.2 K.

Superconductivity makes possible large accelerators with fields well above 2 T

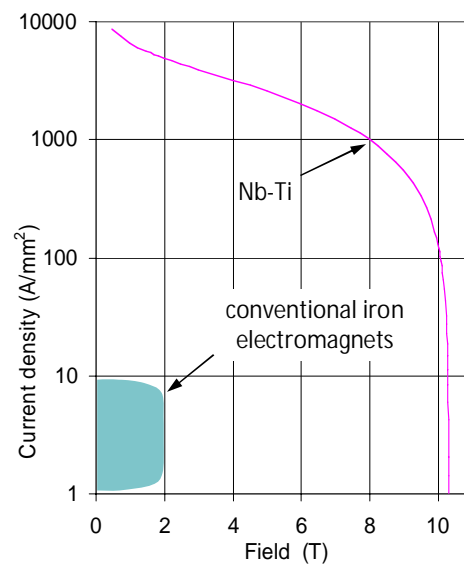

58

Superconductivity implies zero electrical resistance, so that there is no power dissipated as Joule heating (in dc). The drawback is that refrigeration power is needed, as known superconductors work at cryogenic temperatures.

The figure shows a typical example of how much current density j can be sustained by Nb-Ti, the most widespread technical superconductor at the moment, vs. the B field: this is the so-called critical curve. The current density j goes up by order of magnitudes with respect to normal conductors, and the wall of 2 T field is breached.

We often say that the Ampere-turns are then *cheap*: no power consumption, no need of large coils.

This is a summary of (somehow) practical superconductors

	LTS			HTS		
material	Nb-Ti	Nb ₃ Sn	MgB ₂	REBCO	BSCCO	Fe based
year of discovery	1961	1954	2001	1987	1988	2008
T _c [K]	9.2	18.2	39	≈93	95 / 108	up to 58
B _{c2} [T]	≈14.5	≈30	>30	120...250	≈200	>100

59

Nowadays, we have two families of superconductors.

LTS (low temperature superconductors)

* Nb-Ti is the workhorse material, not only for accelerator magnets. It is relatively easy to make into wires and cables ready for winding.

* Nb₃Sn also works around liquid helium temperatures. It can sustain higher field w.r.t. Nb-Ti, though it is brittle. It often requires a heat treatment at high temperature (of the order of 650 °C) after winding. It is being used for some magnets of the HL-LHC upgrade. This is also being used in parts of ITER.

* MgB₂ is a more recent material, with a higher critical temperature than the classical LTS. This has not been used for accelerator magnets (yet), though mostly for power transmission cables, including in the future for superconducting links for the HL-LHC upgrade.

HTS (high temperature superconductors)

These materials have much higher critical currents / temperatures / fields, but – due also to their cost – they have seen limited application so far. For example, a type of BSCCO is used in the LHC current leads, to carry the current from the copper (room temperature) side to the Nb-Ti (liquid helium temperature) part. These materials open up possibilities, on paper, to reach even higher fields; some prototype magnets are being built.

The field in the aperture of a superconducting dipole can be derived using Biot-Savart law (in 2D)

$$B_{\theta} = \frac{\mu_0 I}{2\pi\rho}$$

Biot-Savart law for an infinite wire

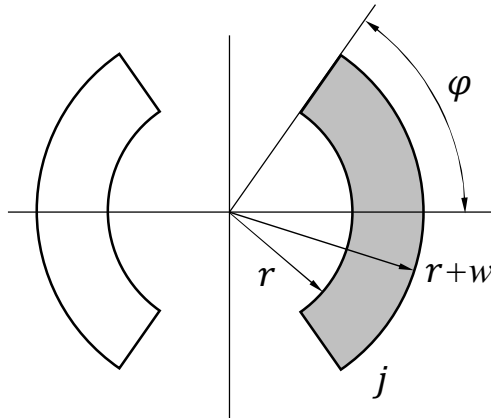

$$B = \frac{2\mu_0 \sin \varphi}{\pi} jw$$

for a sector coil

$$B = \frac{\sqrt{3}\mu_0}{\pi} jw$$

for a 60 deg sector coil

60

Since the iron plays a secondary role for the central B field, instead of reasoning in terms of magnetic reluctances and Hopkinson's law (as for resistive magnets), it is possible to integrate the field in 2D given by the coils directly with Biot-Savart law.

There are several coil layouts that can be used. Besides personal preferences of the designers, the choice depends mainly on magnetic efficiency (how much B can you get with a given amount of superconductor), field quality in the bore and mechanical considerations (for the forces when cooling down / powering the magnet).

Here we give the formula for sector dipoles, which are representative of coil dominated accelerator magnets built so far. The choice of the 60 deg angle (formula on the bottom) for the sector cancels out the first allowed harmonic, that is, b_3 .

The aperture radius r does not enter into the equation. Besides a geometric factor, the field is simply a product

$$B \propto jw$$

field \propto current density (overall) \times coil width.

This is how it would look like one aperture of the LHC dipoles at 8.3 T, with two different current densities (without iron)

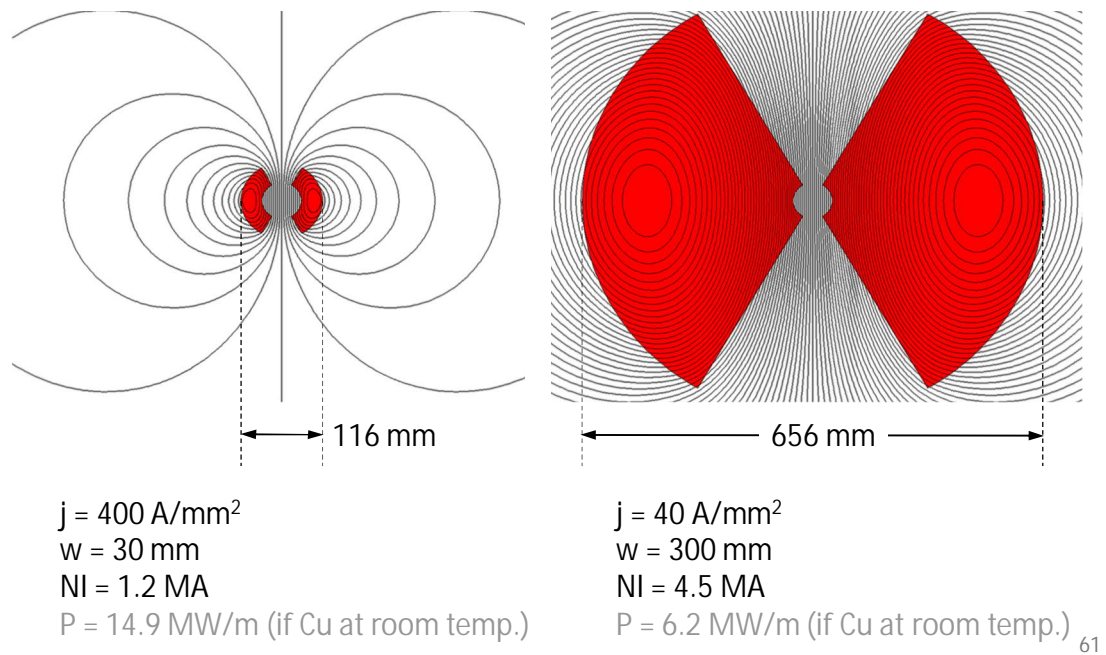

You can get 8.3 T with

$400 \text{ A/mm}^2 \times 30 \text{ mm}$ coil width (left figure, similar to LHC)

or

$40 \text{ A/mm}^2 \times 300 \text{ mm}$ coil width (right figure, very hypothetical).

Besides the Ampere-turns, the power dissipation – if the coil were in normal conducting Cu at room temperature – would be prohibitive, without counting the amount of conductor needed, and the large stray field on the outside, as much more flux is generated.

This is the actual coil of the LHC main dipoles (one aperture), showing the position of the superconducting cables

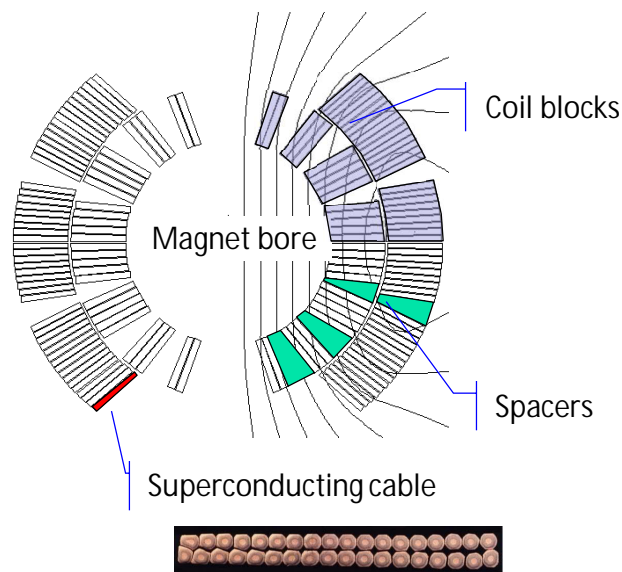

62

The sector layout in practice is modified to a configuration with several blocks, 6 per quadrant in the case of the LHC main dipole (in its final version). Each coil is wound with superconducting cable, that is usually slightly tapered (keystone angle) so to help follow the azimuthal angle as the turns pile up. Spacers (wedges) are inserted in between the blocks. The overall geometry is optimized to improve field quality and maximize magnetic efficiency, which in this case implies avoiding field concentration on the coil w.r.t. the bore.

In the LHC dipoles the inner and outer layer are electrically in series, though they are wound with a slightly different conductor (grading): the current density is higher in the outer layer, where the field is lower. This allows a more efficient electromagnetic design and saving of material.

Around the coils, iron is used to close the magnetic circuit

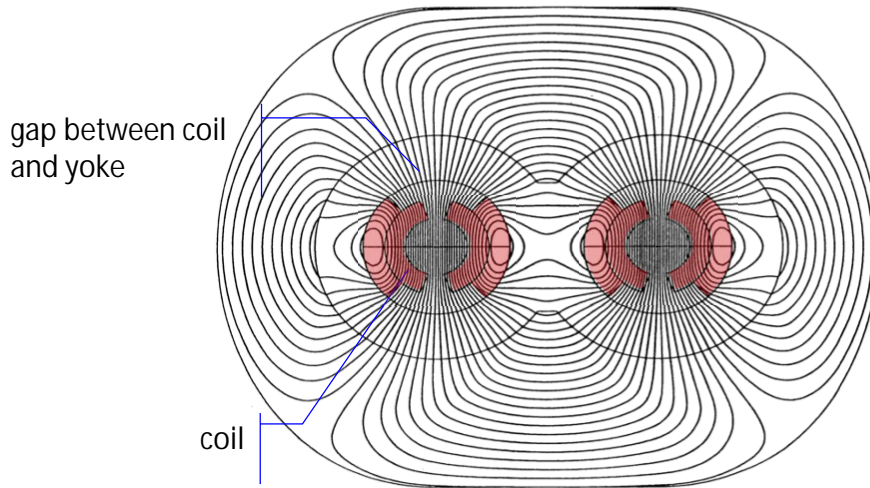

63

Also in this case the LHC dipole is taken as an example. The figure though is not the final design, it is in fact among the very first ones, dating back to 1987... more than 20 years before we had first beams in the machine!

The gap between the coil and the yoke is space reserved for collars, made in stainless steel (not magnetic) material. The collars are meant to counteract the Lorentz force on the coils when the magnet is powered.

The main function of the iron is to provide a return path for the flux, although it does also contribute to the field in the bore.

The allowable current density is high – though finite – and it depends on the temperature and the field

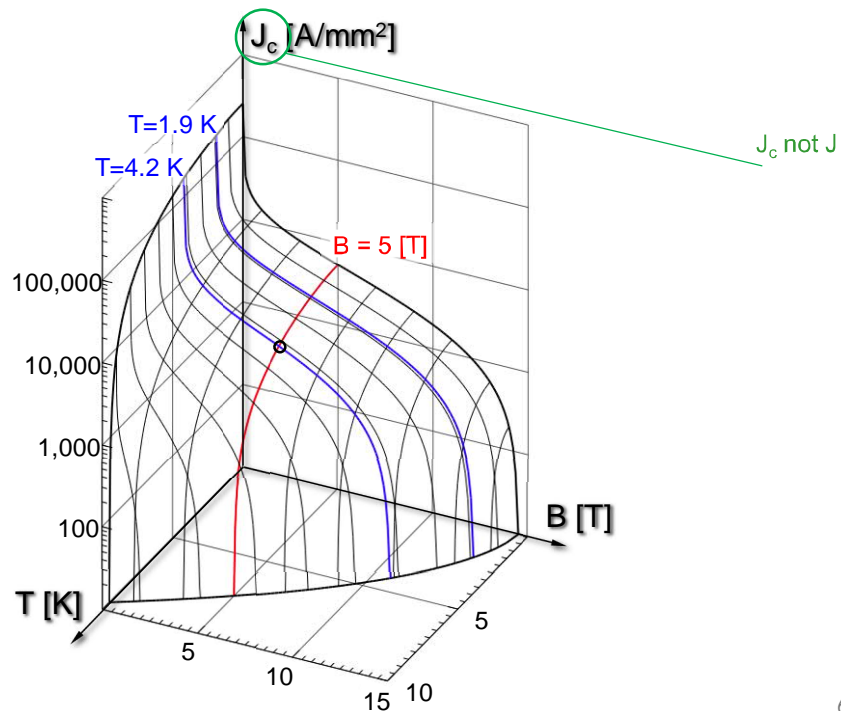

Superconductors carry a high current density, but they have an upper limit: this is described by the so-called critical surface. The 3D plot is the critical surface of an LHC Nb-Ti wire. Generally speaking, this depends on the temperature T and the field B , and it is monotonically decreasing for increasing T and B .

To give an order of magnitude, the critical density at 5 T, 4.2 K as shown on the graph is about 3000 A/mm².

Note: the plot describes the current density in the superconductor itself. The current density that we used before – for example 400 A/mm² – is more an engineering current density, or overall current density, that includes the stabilizer in the superconducting wire, the insulation, the voids (filled by helium), etc.

The maximum achievable field (on paper) depends on the amount of conductor and on the superconductor's critical line

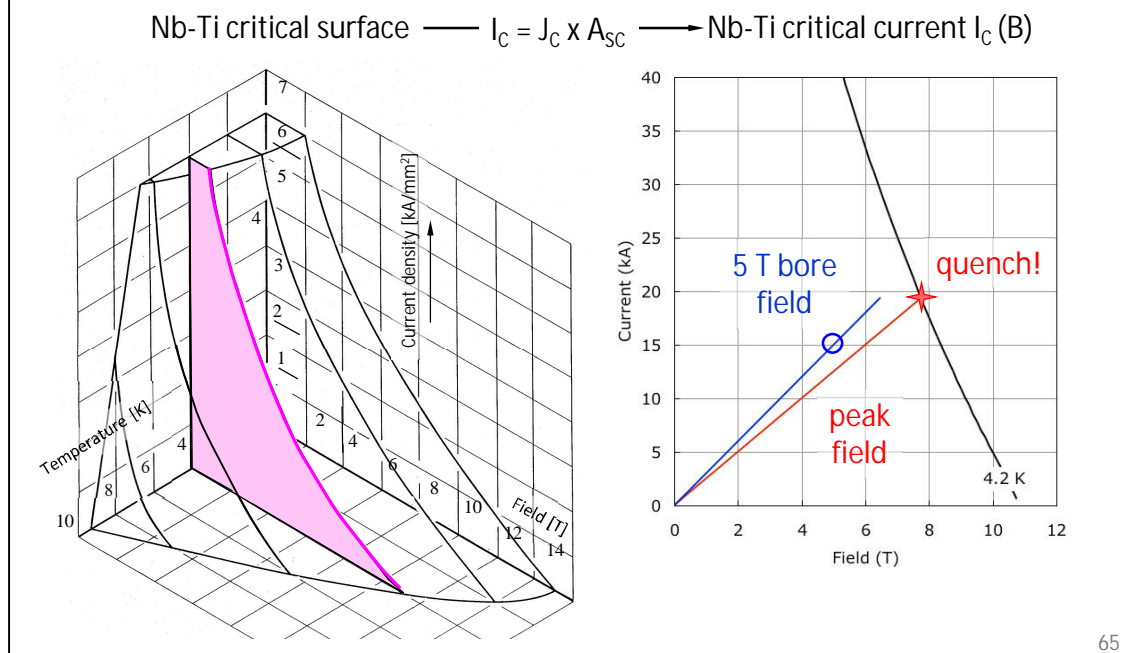

The critical surface of the superconductor (the 3D plot for Nb-Ti on the left) is reduced to 2D fixing the temperature, 4.2 K in this case (I_c plot on the right). For convenience, the current is given instead of the current density, just multiplying by the superconductor area A_{SC} .

On the magnet side, there are two curves, which are very close to straight lines: the peak field on the conductor, at different currents, and the bore field (in the aperture). The intersection of the peak field line with the critical curve gives the maximum (theoretical) field that can be reached by the magnet. In jargon, this is often referred to as the short sample limit. There we expect the magnet to become resistive, that is, to quench. In practice magnets are trained (training) to get close to that limit, with successive powering and quenches.

Note: short samples refer to the performance of the superconducting wire (or cable) measured, well, in *short samples*... Often when doing the design one accounts also for a few % allowance, as cabling degradation.

In practical operation, margins are needed with respect to this short sample limit

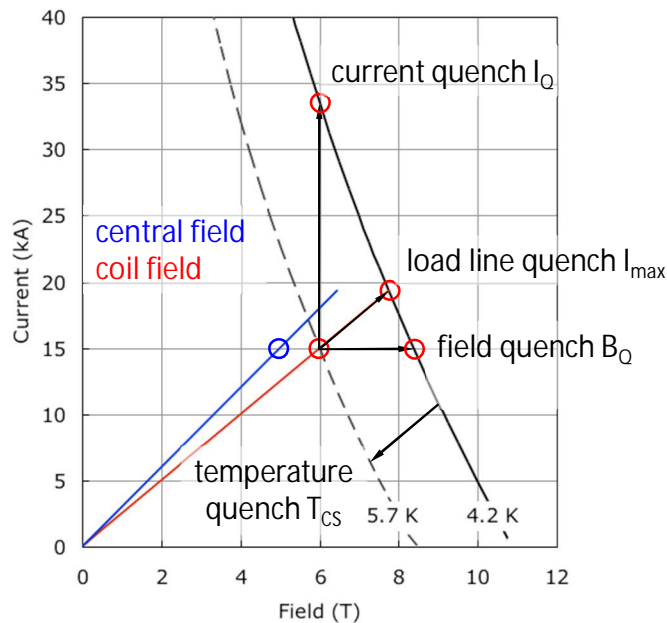

66

The margin needed depends – among other things – on the superconducting material, the design (for example, coils impregnated, typically in epoxy resin, or not), the operating temperature.

Margins are ratios between an operating point (temperature, field, current) and the limit on the critical surface of the superconductor. Typical values for Nb-Ti at its limits (LHC main magnets) for the various margins are:

- * margin along the load line $I_{op} / I_{max} \approx 85\%$
- * critical current margin $I_{op} / I_Q \approx 50\%$
- * critical field margin $B_{op} / B_Q \approx 75\%$
- * temperature margin $T_{CS} - T_{op} \approx 1...2\text{ K}$

The most used margin is probably the margin along the load line, which is typically just referred to as *margin*. Other definitions are possible (and meaningful), for example the enthalpy margin, which is the integral of the heat capacity from the operating temperature up to T_{CS} .

Note: the subscript CS refers to *current sharing* temperature, because superconductivity is lost and the current starts to be shared with the resistive matrix of the stabilizer.

This is the best (Apr. 2018) critical current for several superconductors

Applied Superconductivity Center at NHMFL

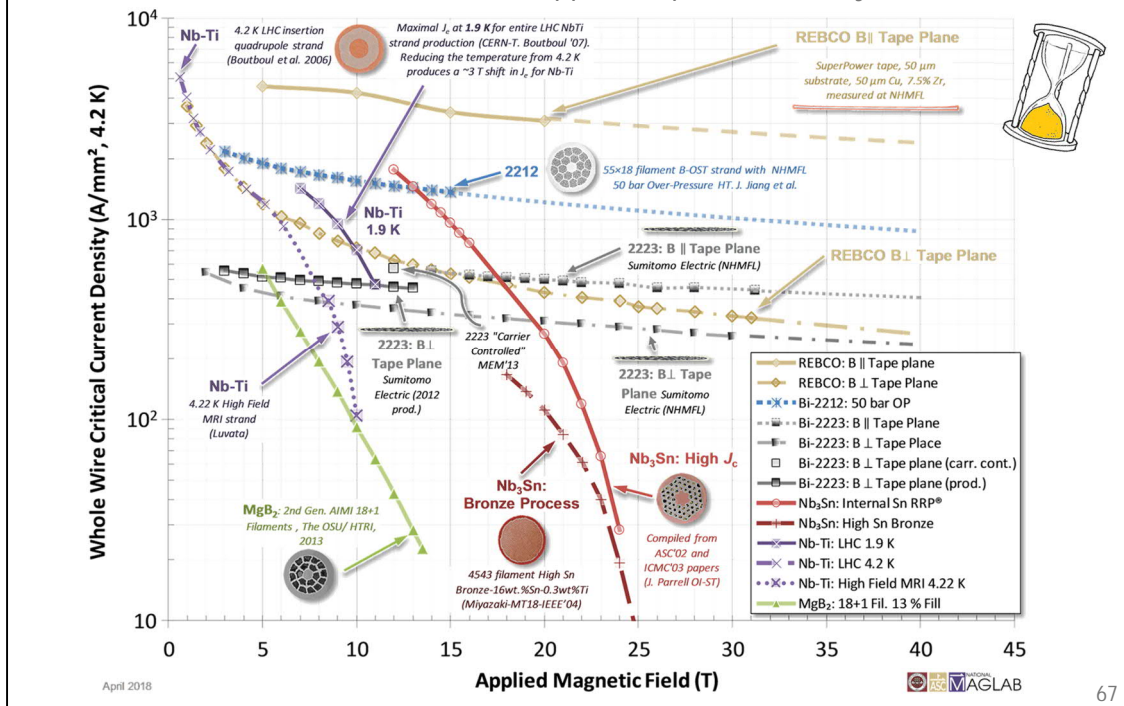

source:

<https://nationalmaglab.org/magnet-development/applied-superconductivity-center/plots>

Not only there is a range of superconducting materials, but also the technological route along which they are produced makes quite a difference in their performance. Some materials already show on a laboratory scale the possibility of further enhancing their critical current density, others (in particular, Nb-Ti) have already reached industrial maturity.

Nb-Ti provides useful current density till about 10 T: this is basically what set the limit for LHC.

Nb₃Sn can be pushed a little further. The records for prototype dipole magnets (not yet ready for an accelerator) today is around 16 T.

HTS open theoretically the way to even higher fields, entering a region where the mechanical aspects – the containment of Lorentz forces and their stress on the materials – will become even more critical.

The overall current density is lower than the current density on the superconductor

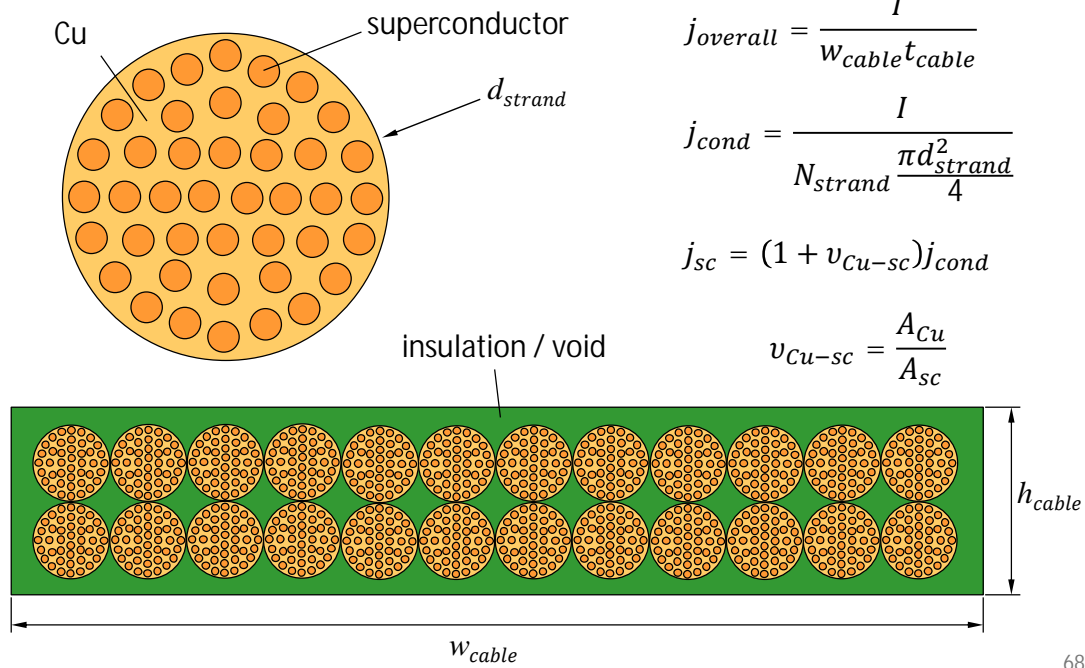

$$j_{overall} = \frac{I}{w_{cable} t_{cable}}$$

$$j_{cond} = \frac{I}{N_{strand} \frac{\pi d_{strand}^2}{4}}$$

$$j_{sc} = (1 + v_{Cu-sc}) j_{cond}$$

$$v_{Cu-sc} = \frac{A_{Cu}}{A_{sc}}$$

There are two current densities that matter the most:

- $j_{overall}$, which are the A/mm² overall, that is, dividing the Ampere-turns by the whole section of the coil, including insulation, voids, etc.
- j_{sc} , which are the A/mm² just in the superconducting filaments, which are only a part of the strands, since there is a stabilizing matrix (usually in copper): this is the one that is used in the critical current plot.

Sometimes the ratio v_{Cu-sc} is referred to as to copper over non-copper.

The forces can be very large, so the mechanical design is important



Nb-Ti LHC MB @ 8.3 T

$F_x \approx 350$ t per meter

precision of coil positioning: 20-50 μm

$F_z \approx 40$ t

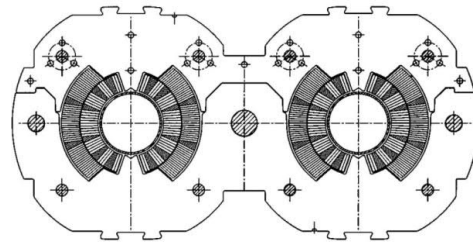

69

For superconducting magnets, the combination of high current density and high field results in very high electromagnetic forces.

As an example, the values for the LHC dipoles are reported. The axial force on the coil is comparable to the weight of the cold mass.

The deformations induced by these forces have to be controlled, as the position of the coil determines the field quality.

Moreover, a proper mechanical pre-stress is often used to minimize coil movements, which can trigger a quench, involving a longer training of the magnet to reach its design field.

The coil cross sections of several superconducting dipoles show a certain evolution; all were (are) based on Nb-Ti

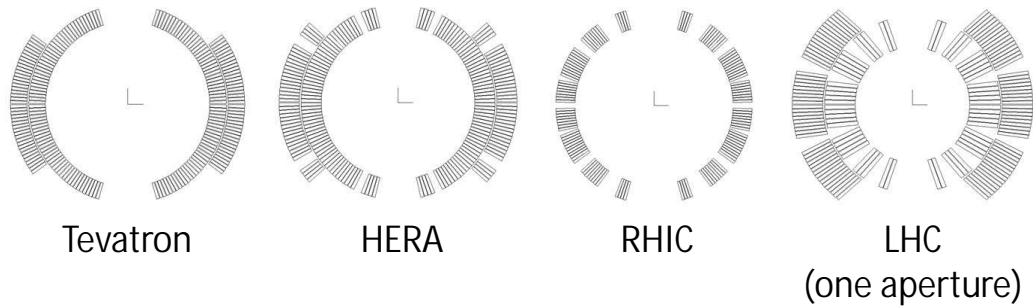

70

The cross sections (to scale) of four superconducting colliders show different design choices, such as single or double layers, wedges, coil blocks, in an effort to achieve high magnetic efficiency and field homogeneity.

All these designs are of the so-called cos-theta family. A cos-theta distribution of the current density with the azimuthal (theta) angle is known to yield a perfect dipolar field. These windings – which wrap around a cylindrical mandrel – are imagined to approximate this distribution, hence the name. An advantage with respect to other layouts is that they do not require an inner support structure, which reduces the available aperture.

Also the iron, the mechanical structure and the operating temperature can be quite diverse

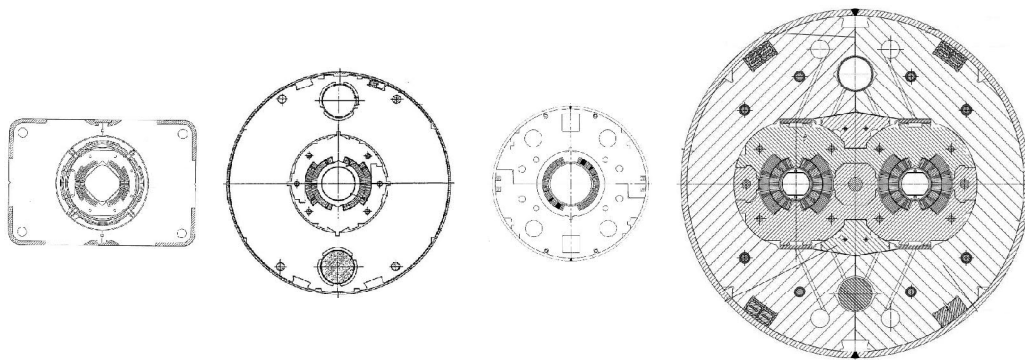

Tevatron	HERA	RHIC	LHC
76 mm bore	75 mm bore	80 mm bore	56 mm bore
B = 4.3 T	B = 5.0 T	B = 3.5 T	B = 8.3 T
T = 4.2 K	T = 4.5 K	T = 4.3-4.6 K	T = 1.9 K
first beam 1983	first beam 1991	first beam 2000	first beam 2008

All these machines are cooled with helium. LHC is the only one to work with superfluid helium. These extra 2 K mean a lot – the cryogenic system becomes at once more complex and less thermodynamically efficient – though the heat transfer between the bath and the coil is much improved. From a magnetic viewpoint, working at 1.9 K instead of 4.2 K shifts the critical current curve of Nb-Ti significantly.

LHC is the only twin bore layout among these four dipoles.

The Tevatron is the only one with a warm iron yoke, that is, the iron is not in liquid helium but it is rather at room temperature.

This is how they look in their machines



72

In most superconducting machines, not much can be seen of the magnets once installed if not their cryostats. An exception is the Tevatron, with its warm iron yokes.

There are also resistive magnets in the pictures:

- * at HERA, for the electron ring, below the proton machine (C dipoles);
- * at Tevatron, on top of the superconducting machine (H dipoles), for the main ring, which was a normal conducting synchrotron built before the superconducting one, for which it also was as an injector at the beginning, before the construction of a separate machine.

1. Introduction, jargon, general concepts and formulae
2. Resistive magnets
3. Superconducting magnets
4. Tutorial with FEMM

See Jérémie Bauche, this afternoon

There are different programs used for magnetic simulations



1. OPERA-2D and OPERA-3D, by Dassault Systèmes
2. ROXIE, by CERN
3. POISSON, by Los Alamos
4. FEMM
5. RADIA, by ESRF
6. ANSYS
7. Mermaid, by BINP
8. COMSOL

74

There are many magnetic simulation programs available. Back in the days, many individuals / institutes developed their own codes.

1. OPERA, <http://operafea.com>
This started in Rutherford Appleton Laboratory to then become one of the most used programs in this field, for both 2D and 3D.
2. ROXIE, <https://espace.cern.ch/roxie>
This started at CERN, especially for superconducting magnets.
3. POISSON, http://laacg.lanl.gov/laacg/services/download_sf.phtml
This is a historical code, still used for magnetostatic simulations in 2D, developed at Los Alamos. It is based on a finite difference – not finite element, like many of the others, approach. (free)
4. FEMM, www.femm.info
It is a user friendly 2D program. (free)
5. RADIA, developed at ESRF (free)
<http://www.esrf.eu/Accelerators/Groups/InsertionDevices/Software/Radia>
It has quite some users, as it handles also 3D. It has been used much for insertion devices (ex. undulators), but not only.
6. ANSYS, www.ansys.com
It is not particularly specialized for magnetic simulations.
7. Mermaid
It is a Russian code, developed at the Budker Institute of Nuclear Physics.
8. COMSOL
This is also a multi-physics environment.