

Shedding Light on Neutrinos through Electromagnetic Properties

Sudip Jana

Max-Planck-Institut für Kernphysik, Heidelberg



MAX-PLANCK-INSTITUT
FÜR KERNPHYSIK

*PPC 2024
IIT Hyderabad, India*

Oct 15, 2024



MAX-PLANCK-GESELLSCHAFT

Current knowledge of neutrino oscillations

1. Neutrinos in the Standard Model are **massless**.

$$L_i \rightarrow \begin{pmatrix} \nu_i \\ \ell_i \end{pmatrix} \quad m_\nu = 0$$

2. Neutrino flavor **oscillations** have been firmly established and it can happen only if neutrinos have **non-zero masses**.

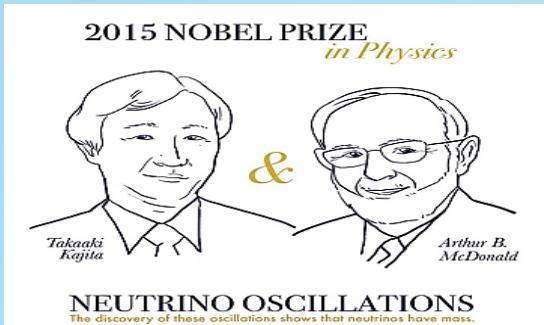

3. All three **mixing angles** and two **mass splitting** have been measured with few percent precision.

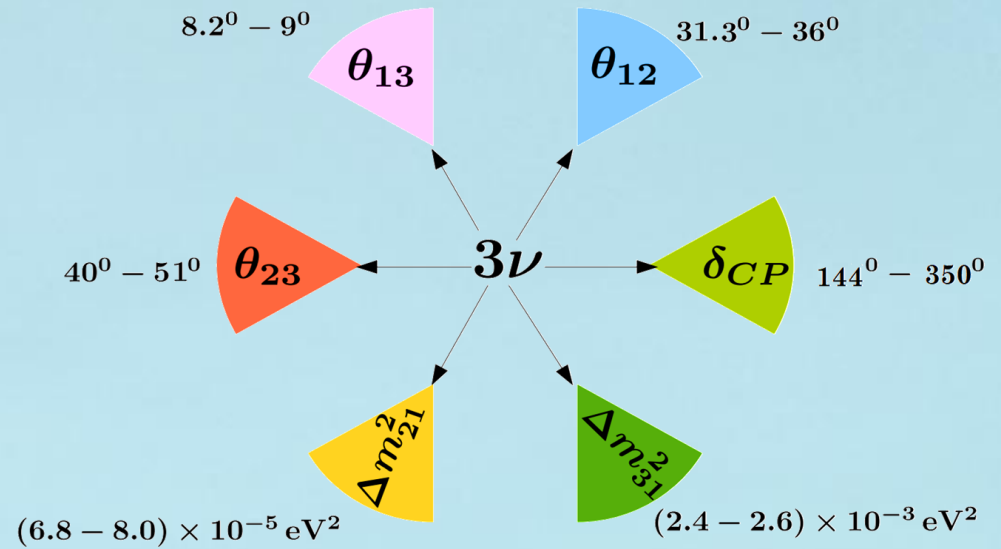

Sign is unknown

Esteban et al. (2020)
NuFIT 5.1 (2021)

Flavor eigenstate	PMNS matrix			Mass eigenstate
$\begin{pmatrix} \nu_e \\ \nu_\mu \\ \nu_\tau \end{pmatrix}$	$\begin{pmatrix} 1 & 0 & 0 \\ 0 & \cos \theta_{23} & \sin \theta_{23} \\ 0 & -\sin \theta_{23} & \cos \theta_{23} \end{pmatrix}$	$\begin{pmatrix} \cos \theta_{13} & 0 & \sin \theta_{13} e^{-i\delta} \\ 0 & 1 & 0 \\ -\sin \theta_{13} e^{i\delta} & 0 & \cos \theta_{13} \end{pmatrix}$	$\begin{pmatrix} \cos \theta_{12} & \sin \theta_{12} & 0 \\ -\sin \theta_{12} & \cos \theta_{12} & 0 \\ 0 & 0 & 1 \end{pmatrix}$	$\begin{pmatrix} \nu_1 \\ \nu_2 \\ \nu_3 \end{pmatrix}$
	Atmospheric term	Reactor term	Solar term	

Neutrino electromagnetic properties & Pressing Questions for Neutrinos

1. *How do neutrinos get mass?*

2. *Nature of neutrinos (Dirac or Majorana ?)*

3. *Neutrino Mass ordering (Normal or Inverted ?)*

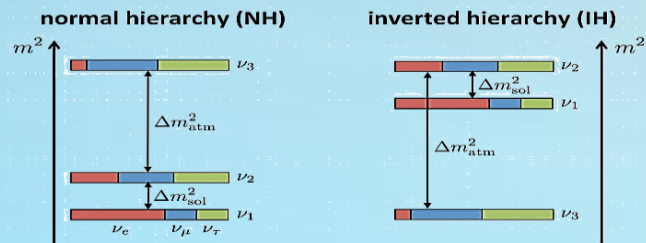

4. *Correlation between the magnetic moments of charged leptons and neutrinos?*

$$L_i \rightarrow \begin{pmatrix} \nu_i \\ l_i \end{pmatrix}$$

5. *Addressing anomalies*

.....

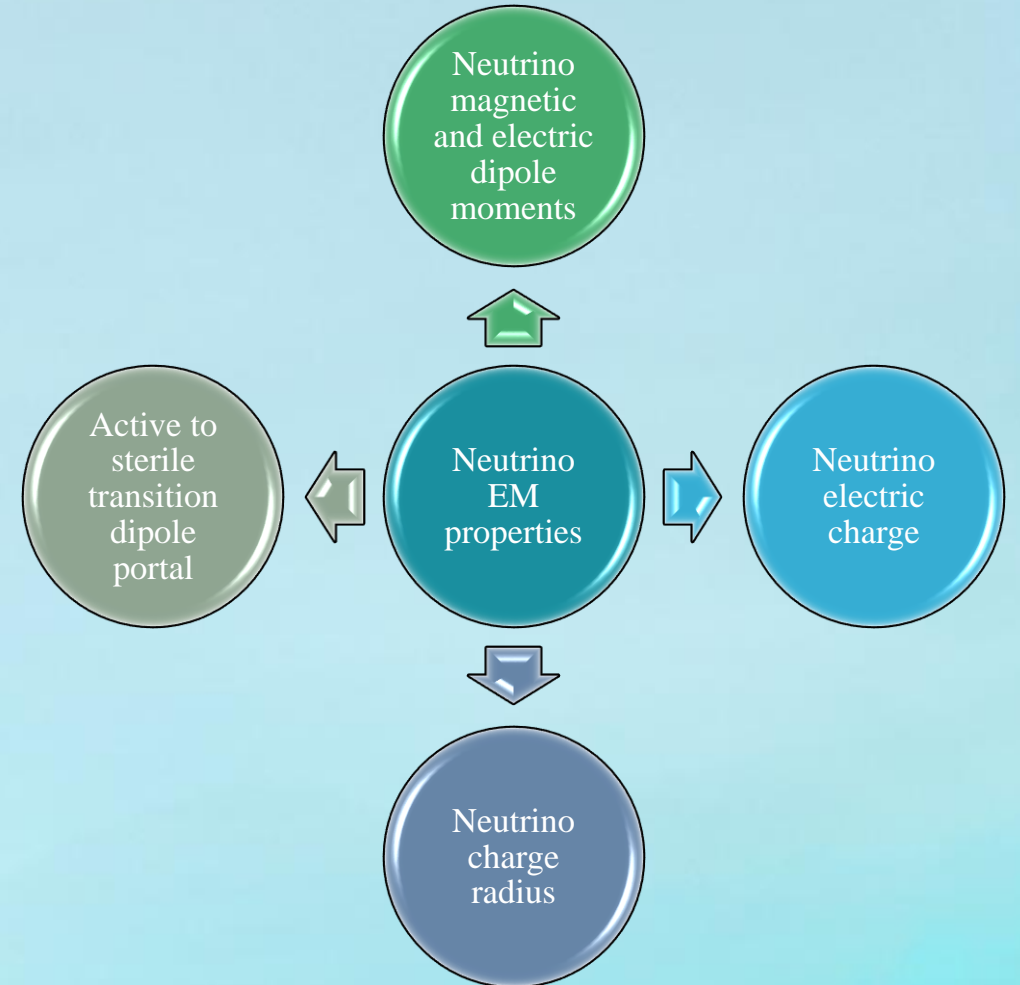

Neutrino electromagnetic properties

- In the *Standard Model*, neutrinos do not have direct coupling to photons.
- Quantum loop corrections can induce electromagnetic properties of neutrino.
- Study of neutrino electromagnetic interactions may shed light on the underlying theory.
- Anomalous electromagnetic properties of charged leptons and neutrinos can be correlated.

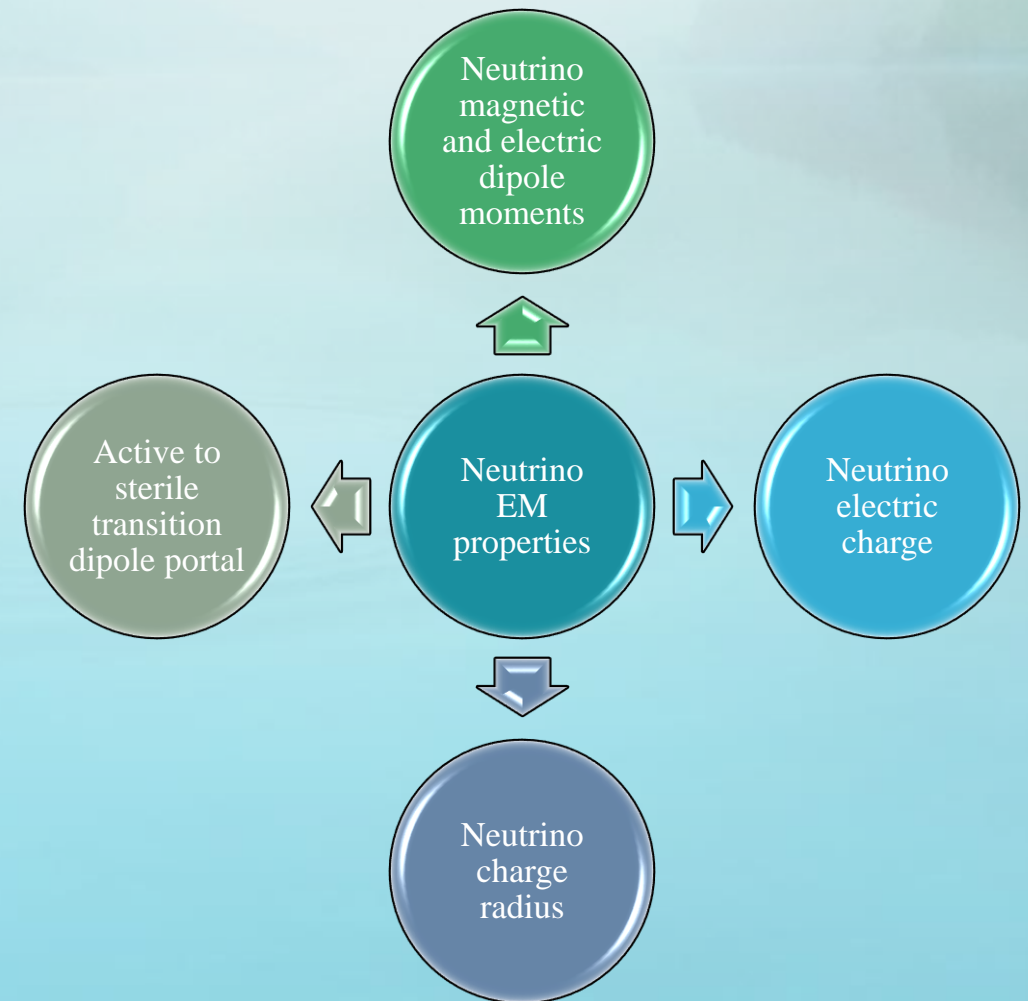

Talk is based on:

1. Babu, **SJ**, Lindner, (JHEP 2020)
2. Babu, **SJ**, Lindner, Vishnu, (JHEP 2021)
3. Ismail, **SJ**, Roshan, (PRD 2021)
4. **SJ**, Porto-Silva, Sen, (JCAP 2022)
5. Huang, **SJ**, Lindner, Rodejohann, (JCAP 2022)
6. **SJ**, Porto (PRL 2024)

Charged lepton magnetic moments

Neutrino magnetic moments

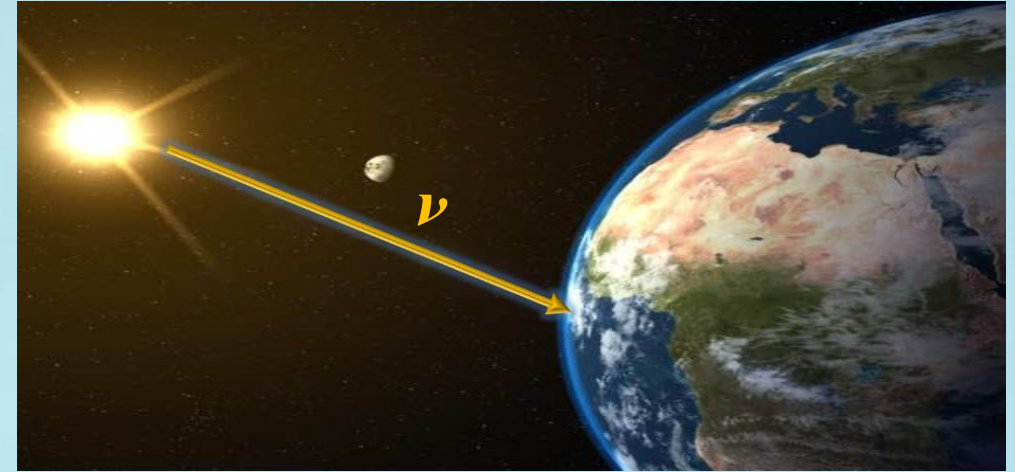

*How much do they rotate
on their axes in a powerful magnetic field
as they race around the magnet?*

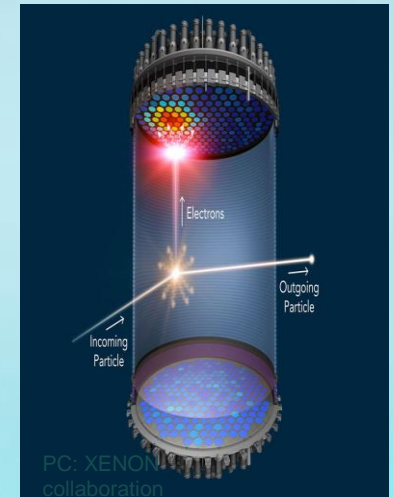
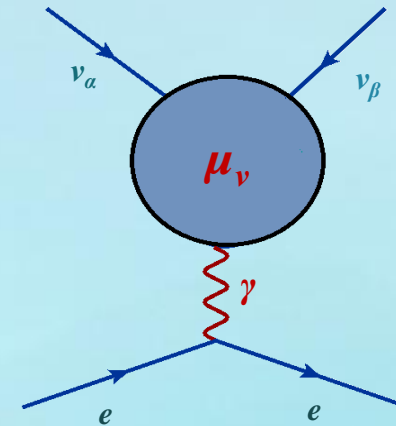

Consequences of neutrino magnetic moments

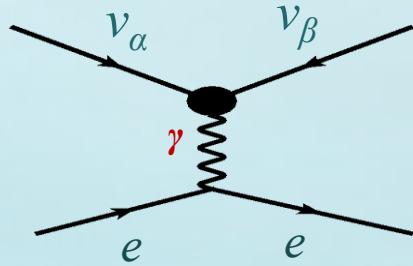

Scattering

$$\left(\frac{d\sigma_{\nu\alpha e}}{dT}\right)_{\text{tot}} = \left(\frac{d\sigma_{\nu\alpha e}}{dT}\right)_{\text{SM}} + \frac{\pi\alpha^2}{m_e^2} \left(\frac{1}{T} - \frac{1}{E_\nu}\right) \left(\frac{\mu_{\text{eff}}}{\mu_B}\right)^2$$

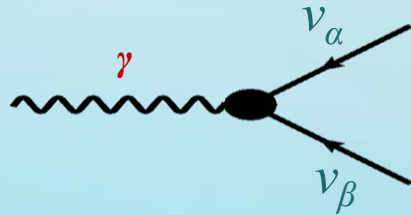

Plasmon decays
in stars

$$\Gamma = \frac{\mu_\nu^2}{24\pi} \omega_{\text{pl}}^3$$

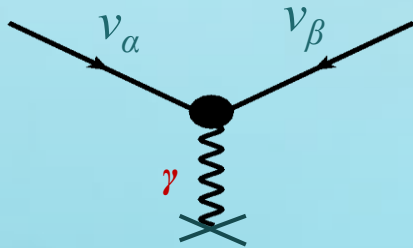

Spin precession in
external B field

$$i\frac{d}{dr} \begin{pmatrix} \nu \\ \bar{\nu} \end{pmatrix} = \begin{pmatrix} 0 & B_\perp M \\ -B_\perp M & 0 \end{pmatrix} \begin{pmatrix} \nu \\ \bar{\nu} \end{pmatrix}$$

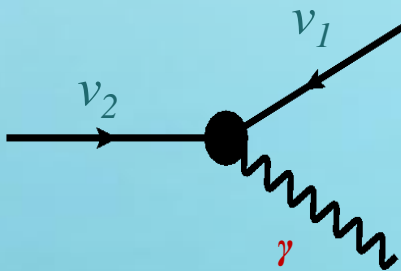

Decay or Cherenkov
effect

$$\Gamma = \frac{\mu_\nu^2}{8\pi} \left(\frac{m_2^2 - m_1^2}{m_2}\right)^3$$

Neutrino magnetic moments: experimental status

- The quest for measuring neutrino magnetic moments was begun even before the discovery of the neutrino.



Frederick Reines

1995 Nobel Prize in Physics

for his co-detection of the neutrino with Clyde Cowan in the neutrino experiment.

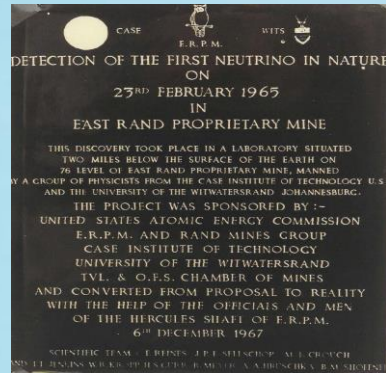

- **Cowan, Reines and Harrison** set an upper limit in the process of measuring background for a free neutrino search experiment with reactor antineutrinos.

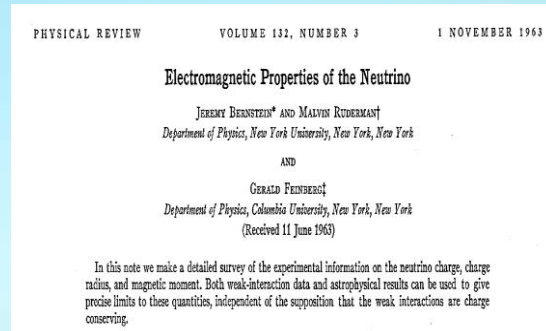
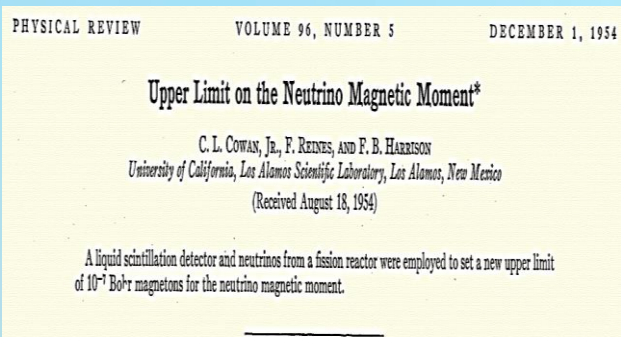

Neutrino magnetic moments: experimental status

- The quest for measuring neutrino magnetic moments was begun even before the discovery of the neutrino.



Frederick Reines

1995 Nobel Prize in Physics

for his co-detection of the neutrino with Clyde Cowan in the neutrino experiment.

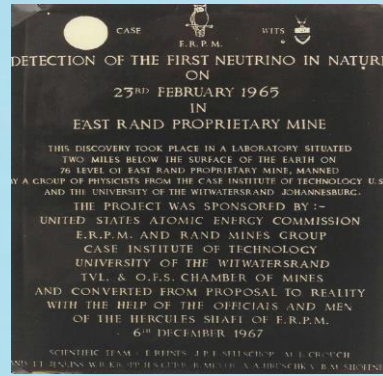

- Cowan, Reines and Harrison set an upper limit in the process of measuring background for a free neutrino search experiment with reactor antineutrinos.

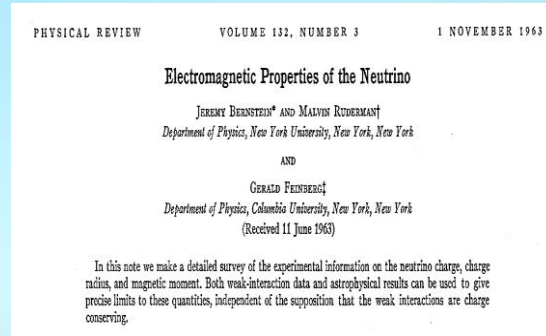
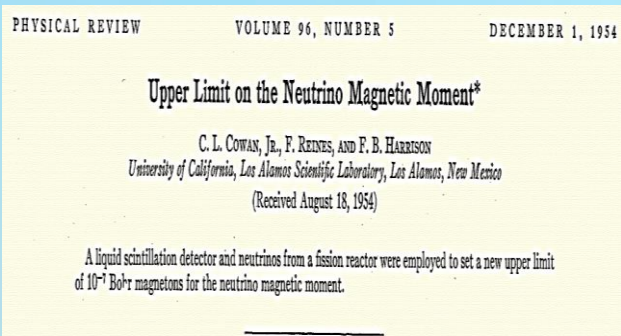

Reactor

- KRASNOYARSK (1992):
- ROVNO (1993):
- MUNU (2005):
- TEXONO (2010):
- GEMMA (2012):
- CONUS (2022):

$$\mu_\nu < 2.7 \times 10^{-10} \mu_B$$

$$\mu_\nu < 1.9 \times 10^{-10} \mu_B$$

$$\mu_\nu < 1.2 \times 10^{-10} \mu_B$$

$$\mu_\nu < 2.0 \times 10^{-10} \mu_B$$

$$\mu_\nu < 2.9 \times 10^{-11} \mu_B$$

$$\mu_\nu < 7.0 \times 10^{-11} \mu_B$$

Accelerator

- LAPMF (1993):
- LSND (2002):

$$\mu_\nu < 7.4 \times 10^{-10} \mu_B$$

$$\mu_\nu < 6.4 \times 10^{-10} \mu_B$$

Solar

- Borexino (2017):
- XENONnT (2022):

$$\mu_\nu < 2.8 \times 10^{-11} \mu_B$$

$$\mu_\nu < 6.4 \times 10^{-12} \mu_B$$

Excess between 1-7 keV

285 events observed
vs.
232 (+/- 15) events expected (from best-fit)

Would be a 3.5σ fluctuation
(naive estimate – we use likelihood ratio tests for main analysis)

E. Aprile et al. (2020)

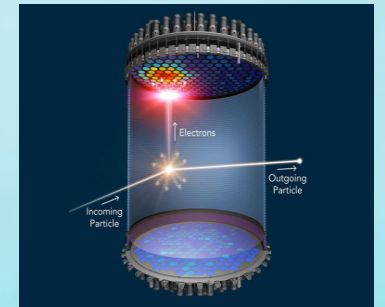

XENON Collaboration,

Neutrino Magnetic Moments: from astrophysics and cosmology

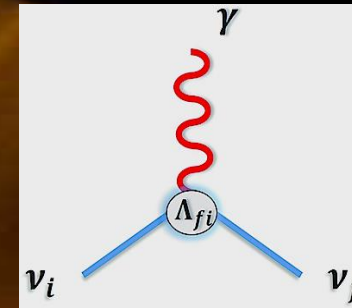

Photons in the plasma of stellar environments can decay either into $\nu\bar{\nu}$ for the case of Dirac neutrinos or into $\nu_\alpha\nu_\beta$ for the case of Majorana neutrinos.

If such decays occur too rapidly, that would drain energy of the star, in conflict with standard stellar evolution models.

The best limit on μ_ν arises from red giant branch of globular clusters: $\mu_\nu < 1.5 \times 10^{-12} \mu_B$ Raffelt et al.(2013, 2021), Barbieri and Mohapatra (1988) from SN1987A signal

Cosmological limits arising from big bang nucleosynthesis are less severe, of order $10^{-10} \mu_B$. Fuller et al. (2015)

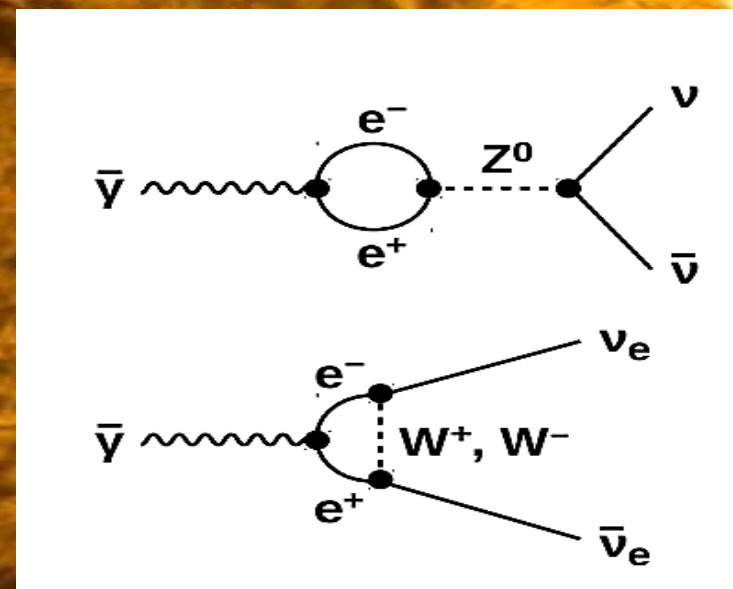

Neutrino Magnetic Moments: from astrophysics and cosmology

Photons in the plasma of stellar environments can decay either into $\nu\bar{\nu}$ for the case of Dirac neutrinos or into $\nu_\alpha\nu_\beta$ for the case of Majorana neutrinos.

If such decays occur too rapidly, that would drain energy of the star, in conflict with standard stellar evolution models.

The best limit on μ_ν arises from red giant branch of globular clusters: $\mu_\nu < 1.5 \times 10^{-12} \mu_B$ Raffelt et al. (2013, 2021)

Cosmological limits arising from big bang nucleosynthesis are less severe, of order $10^{-10} \mu_B$. Fuller et al. (2015)

Neutrino Trapping Mechanism

- Constraints from astrophysics may be evaded if the plasmon decay to neutrinos is kinematically forbidden.

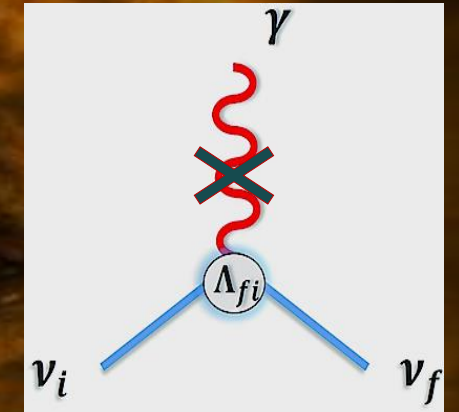
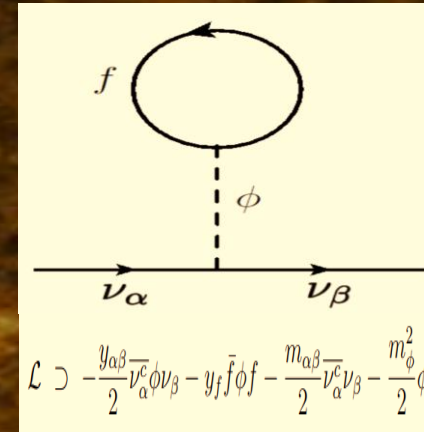

Babu, SJ, Lindner (2020)

- Medium-dependent mass of the neutrino in the presence of a light scalar that also couples to ordinary matter in illustrating the mechanism.
- For phenomenological implications, see Parke et al. (2018), Smirnov et al. (2019), Babu et al. (2019)

Neutrino magnetic moment – mass conundrum

- The magnetic moment and the mass operators are both *chirality flipping*.
- By *removing the photon line* from the loop diagram that induces μ_ν , one would generate a *neutrino mass* term.
- In *absence of additional symmetries* (and *without severe fine-tuning*), neutrino masses are several orders of magnitude larger than their measured values, if $\mu_\nu \sim 10^{-11} \mu_B$.

$$m_\nu \sim \frac{\Lambda^2 \mu_\nu}{2 m_e \mu_B} \sim 0.1 \text{ MeV} \text{ for } \Lambda \sim 100 \text{ GeV} \text{ and } \mu_\nu \sim 10^{-11} \mu_B$$

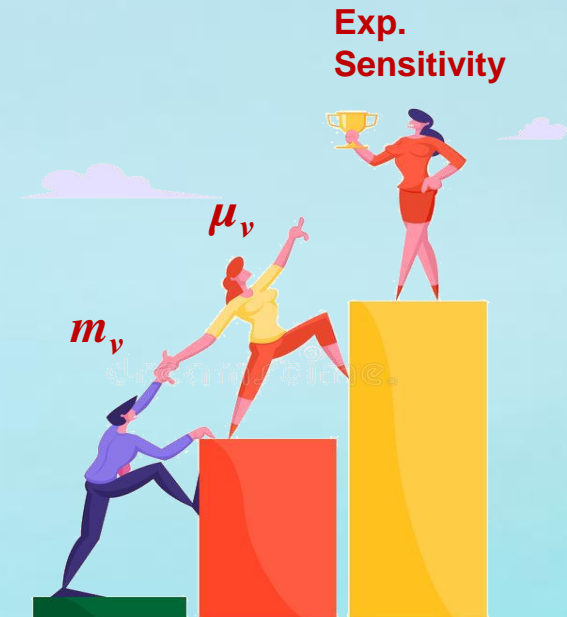
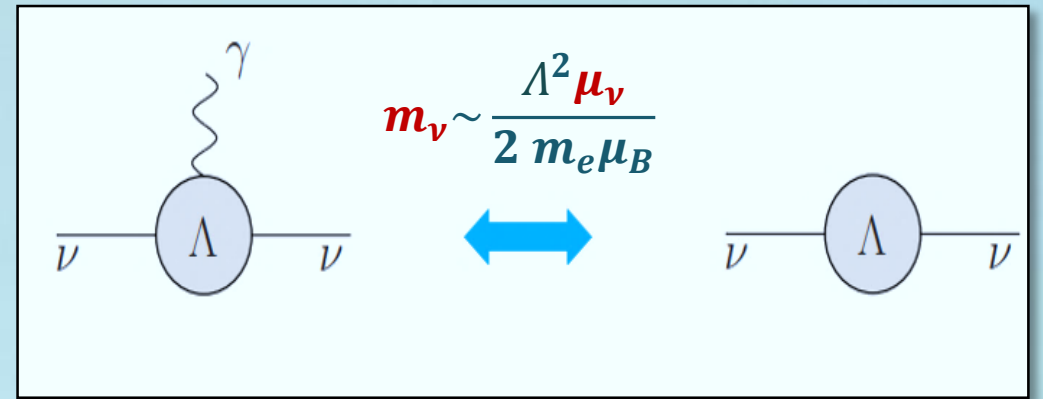

Neutrino magnetic moment – mass conundrum

*This conundrum was well recognized **three decades ago** when there was great interest in explaining **the apparent time variation of solar neutrino flux detected by the Chlorine experiment in anti-correlation with the Sun-spot activity.***

*NMM would lead to spin-flip transition inside the solar magnetic field. Such transitions could even undergo a matter enhanced resonance. **Lim, Marciano (1988), Akhmedov (1988)***

*In the **late 1980's and early 1990's** there were **significant theoretical activities** that addressed the compatibility of a large neutrino magnetic moment with a small mass.*

After that, in the theory side, no interesting developments have been made. These discussions become very relevant today.

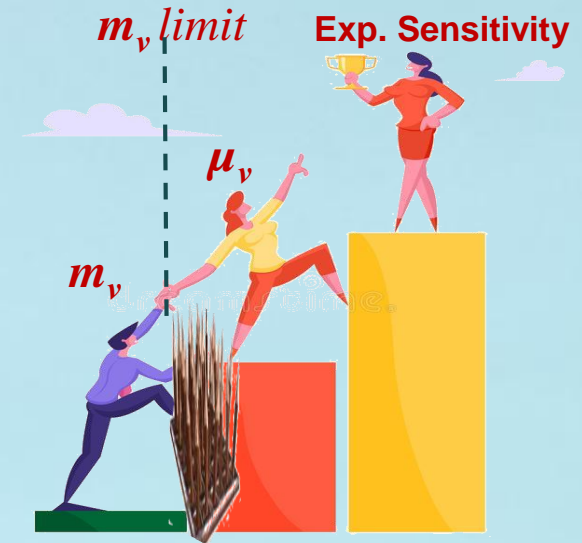

$$\nu \text{---} \textcircled{\Lambda} \text{---} \nu \quad \longleftrightarrow \quad m_\nu \sim \frac{\Lambda^2 \mu_\nu}{2 m_e \mu_B} \quad \longleftrightarrow \quad \nu \text{---} \textcircled{\Lambda} \text{---} \nu$$

Neutrino magnetic moments in beyond the Standard Model

SM + ν_R

The magnetic moment and mass operators for the neutrino have the same chiral structure, which for a Dirac neutrino has the form:

$$\mathcal{L} \supset \mu_\nu \bar{\nu}_L \sigma_{\mu\nu} \nu_R F^{\mu\nu} + m_\nu \bar{\nu}_L \nu_R + \text{H.c.}$$

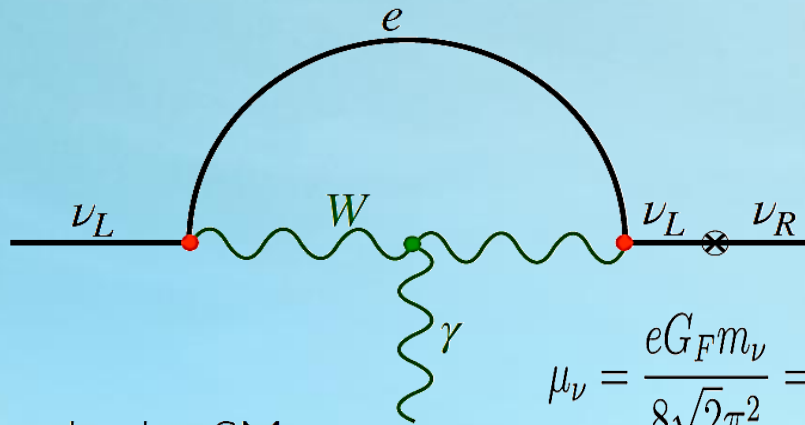

$$\mu_\nu = \frac{e G_F m_\nu}{8\sqrt{2}\pi^2} = 3 \times 10^{-20} \mu_B \left(\frac{m_\nu}{0.1 \text{ eV}} \right)$$

In the SM

$$\mu_\nu^{SM} \sim 10^{-20} \mu_B$$

K. Fujikawa and R. Shrock (1980)

Bell et al. (2005)

Neutrino magnetic moments in beyond the Standard Model

SM + ν_R

The magnetic moment and mass operators for the neutrino have the same chiral structure, which for a Dirac neutrino has the form:

$$\mathcal{L} \supset \mu_\nu \bar{\nu}_L \sigma_{\mu\nu} \nu_R F^{\mu\nu} + m_\nu \bar{\nu}_L \nu_R + \text{H.c.}$$

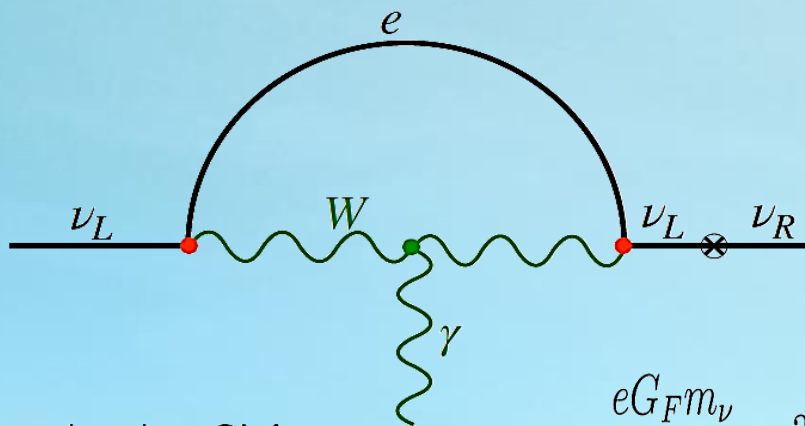

In the SM

$$\mu_\nu^{SM} \sim 10^{-20} \mu_B$$

$$\mu_\nu = \frac{e G_F m_\nu}{8\sqrt{2}\pi^2} = 3 \times 10^{-20} \mu_B \left(\frac{m_\nu}{0.1 \text{ eV}} \right)$$

K. Fujikawa and R. Shrock (1980)

Bell et al. (2005)

Left-Right Symmetric Model

Right-handed neutrino couples to a W_R gauge boson, which also has mixing with the W boson.

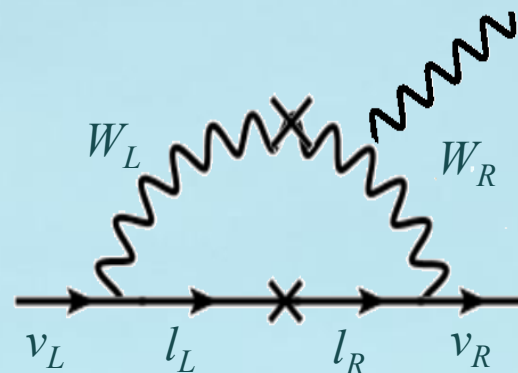

$$\mu_\nu \simeq \frac{G_F m_\ell}{2\sqrt{2}\pi^2} \sin 2\xi$$

Czakon, Gluza, Zralek (1999)
Giunti and A. Studenikin (2014)

This mixing angle is constrained by **muon decay asymmetry parameters**, $b \rightarrow s\gamma$ decay rate, indirect LHC limits leading to a limit $\mu_\nu < 10^{-15} \mu_B$

Neutrino magnetic moment – mass conundrum

SM + ν_R

The magnetic moment and mass operators for the neutrino have the same chiral structure, which for a Dirac neutrino has the form:

$$\mu_\nu = \frac{eG_F m_\nu}{8\sqrt{2}\pi^2} = 3 \times 10^{-20} \mu_B \left(\frac{m_\nu}{0.1 \text{ eV}} \right)$$

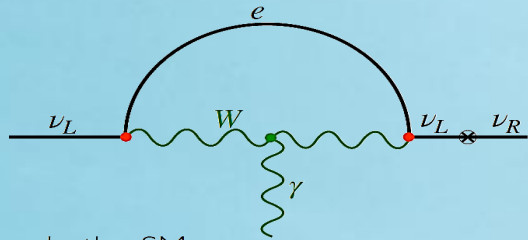

K. Fujikawa and R. Shrock (1980)

Bell et al. (2005)

In the SM

$$\mu_\nu^{SM} \sim 10^{-20} \mu_B$$

Supersymmetric theory

In **supersymmetric extensions** of the SM, lepton number may be violated by R-parity breaking interactions. In such contexts, without relying on additional symmetries, NMM will be (imposing experimental constraints on the SUSY parameters) of the order at most about $10^{-15} \mu_B$.

$$\mu_\nu \sim \lambda'^2 / (16\pi^2) m_\ell^2 A_\ell / M_\ell^4$$

Left-Right Symmetric Model

In left-right symmetric models, the right-handed neutrino couples to a W_R gauge boson, which also has mixing with the W boson:

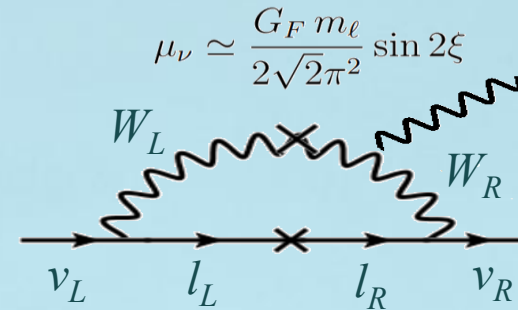

$$\mu_\nu \simeq \frac{G_F m_\ell}{2\sqrt{2}\pi^2} \sin 2\xi$$

$$\mu_\nu < 10^{-15} \mu_B$$

Czakon, Gluza, Zralek (1999)
Giunti and A. Studenikin (2014)

Majorana scenario

If neutrinos are Majorana particles, their transition magnetic moments resulting from Standard Model interactions is given by

$$\mu_{ij} = -\frac{3eG_F}{32\sqrt{2}\pi^2} (m_i \pm m_j) \sum_{\ell=e,\mu,\tau} U_{\ell i}^* U_{\ell j} \frac{m_\ell^2}{m_W^2}$$

At most of order $\mu_\nu \sim 10^{-23} \mu_B$

P. B. Pal and L. Wolfenstein (1982)

For a review, see Giunti and A. Studenikin (2014)

Clearly, these values are well below the sensitivity of current experiments!

Neutrino magnetic moment – mass conundrum

A. Spin Symmetry Mechanism

- In renormalizable gauge theories there are **no direct couplings** of the type $\gamma W^+ S^-$.
- As for its contribution to m_ν , for transversely polarized vector bosons, the transition from **spin 1 to spin 0 cannot occur**. Only the longitudinal mode, the Goldstone mode, would contribute to such transitions.
- This implies that in the two loop diagram utilizing the $\gamma W^+ S^-$ for generating μ_ν , if the photon line is removed, only the longitudinal W^\pm bosons will contribute, leading to a suppression factor of m_l^2/m_W^2 in the neutrino mass.

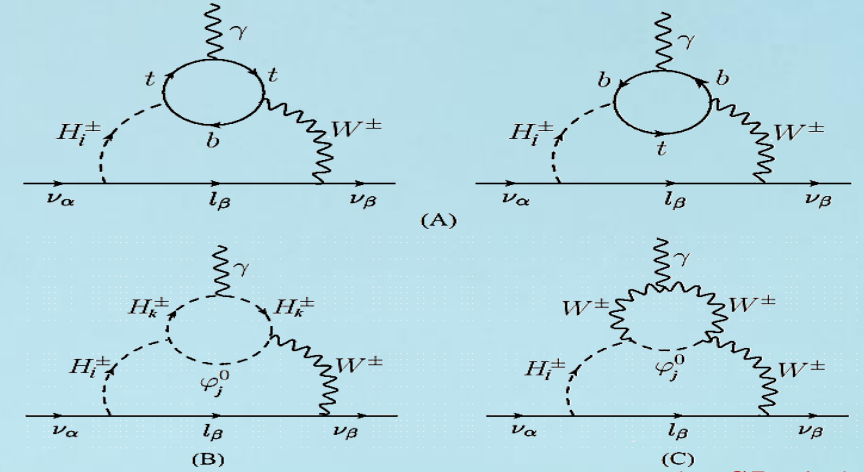

Babu, SJ, Lindner (2020)

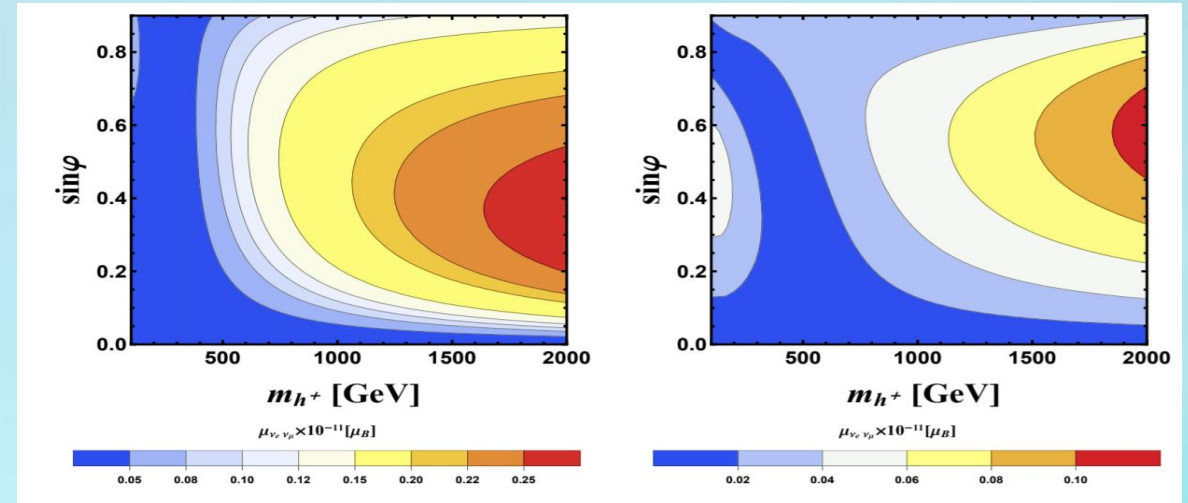

Barr, Freire, and Zee (1990), Babu et al. (1992),
Babu, SJ, Lindner (2020)

In this optimized setup, one can achieve neutrino transition magnetic moment as big as $\sim 10^{-12} \mu_B$

B. $SU(2)_H$ Symmetry for Enhanced Neutrino Magnetic Moment

While the neutrino mass operator and the magnetic moment operator both **are** *chirality flipping*, there is one important **difference** in their **Lorentz structures**.

The **mass operator**, being a **Lorentz scalar**, is **symmetric**, while the **magnetic moment**, being a **Lorentz tensor** operator is **antisymmetric** in the two fermion fields.

In **1988**, **Voloshin** proposed a new $SU(2)_\nu$ **symmetry** that transforms ν into ν^c .

A neutrino mass term, being symmetric under this exchange, would then be forbidden by the $SU(2)_\nu$ symmetry, while the magnetic moment operator, $\nu^T C \sigma_{\mu\nu} \nu^c F^{\mu\nu}$ is antisymmetric under the exchange.

1989: Barbieri and R. N. Mohapatra pointed out that its hard to implement the **Voloshin symmetry** since it does not commute with SM.

$$\mathcal{L}_{\text{mag.}} = (\nu_e^T \quad \nu_\mu^T) C^{-1} \sigma_{\mu\nu} \begin{pmatrix} 0 & 1 \\ -1 & 0 \end{pmatrix} \begin{pmatrix} \nu_e \\ \nu_\mu \end{pmatrix} F^{\mu\nu}$$

$$\mathcal{L}_{\text{mass}} = (\nu_e^T \quad \nu_\mu^T) C^{-1} \begin{pmatrix} 0 & 1 \\ 1 & 0 \end{pmatrix} \begin{pmatrix} \nu_e \\ \nu_\mu \end{pmatrix}$$

B. $SU(2)_H$ Symmetry for Enhanced Neutrino Magnetic Moment

A horizontal symmetry acting on the electron and the muon families can serve the same purpose, as such a symmetry commutes with the weak interactions.

Our simplification is that the symmetry is only **approximate**, broken explicitly by electron and muon masses.

The explicit breaking of $SU(2)_H$ by the lepton masses is analogous to chiral symmetry breaking in the strong interaction sector by masses of the light quarks.

$SU(2)_H$ **cannot be exact**, as it would imply $m_e = m_\mu$. Explicit but small breaking of $SU(2)_H$, so that realistic electron and muon masses can be generated.

Leptons of the Standard Model transform under $SU(2)_L \times U(1)_Y \times SU(2)_H$ as follows:

$$\begin{aligned}\psi_L &= \begin{pmatrix} \nu_e & \nu_\mu \\ e & \mu \end{pmatrix}_L & (2, -\frac{1}{2}, 2) \\ \psi_R &= (e \quad \mu)_R & (1, -1, 2) \\ \psi_{3L} &= \begin{pmatrix} \nu_\tau \\ \tau \end{pmatrix} & (2, -\frac{1}{2}, 1) \\ & \tau_R & (1, -1, 1)\end{aligned}$$

Higgs sector:

$$\begin{aligned}\phi_S &= \begin{pmatrix} \phi_S^+ \\ \phi_S^0 \end{pmatrix} & (2, \frac{1}{2}, 1) \\ \Phi &= \begin{pmatrix} \phi_1^+ & \phi_2^+ \\ \phi_1^0 & \phi_2^0 \end{pmatrix} & (2, \frac{1}{2}, 2) \\ \eta &= (\eta_1^+ \quad \eta_2^+) & (1, 1, 2) .\end{aligned}$$

Babu, **SJ**, Lindner (2020)

$$\begin{aligned}\mathcal{L}_{\text{Yuk}} &= h_1 \text{Tr} (\bar{\psi}_L \phi_S \psi_R) + h_2 \bar{\psi}_{3L} \phi_S \tau_R + h_3 \bar{\psi}_{3L} \Phi i \tau_2 \psi_R^T \\ &+ f \eta \tau_2 \psi_L^T \tau_2 C \psi_{3L} + f' \text{Tr} (\bar{\psi}_L \Phi) \tau_R + \text{H.c.}\end{aligned}$$

Here $SU(2)_H$ acts horizontally, while $SU(2)_L$ acts vertically.

B. $SU(2)_H$ Symmetry for Enhanced Neutrino Magnetic Moment

- ❖ The Lagrangian of the model **does not respect lepton number**. The $SU(2)_H$ limit of the model however **respects $L_e - L_\mu$ symmetry**. This allows a nonzero transition magnetic moment, while neutrino mass terms are forbidden.

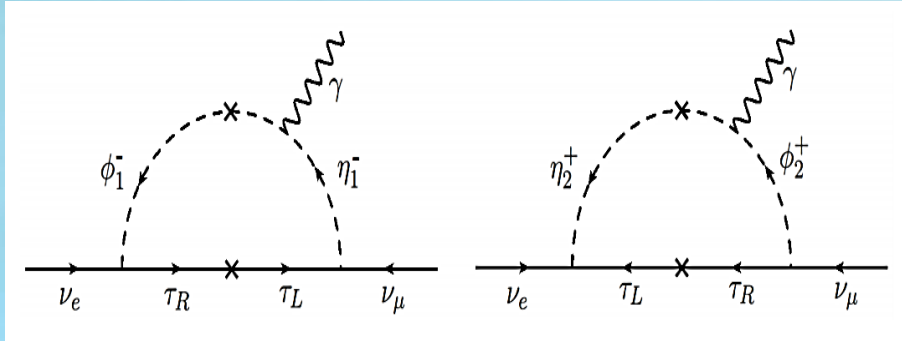

- ❖ In the $SU(2)_H$ symmetric limit, the two diagrams add for $\mu_{\nu_e\nu_\mu}$ while they **cancel** for m_ν .

$$\mu_{\nu_e\nu_\mu} = \frac{ff'}{8\pi^2} m_\tau \sin 2\alpha \left[\frac{1}{m_{h^+}^2} \left\{ \ln \frac{m_{h^+}^2}{m_\tau^2} - 1 \right\} - \frac{1}{m_{H^+}^2} \left\{ \ln \frac{m_{H^+}^2}{m_\tau^2} - 1 \right\} \right]$$

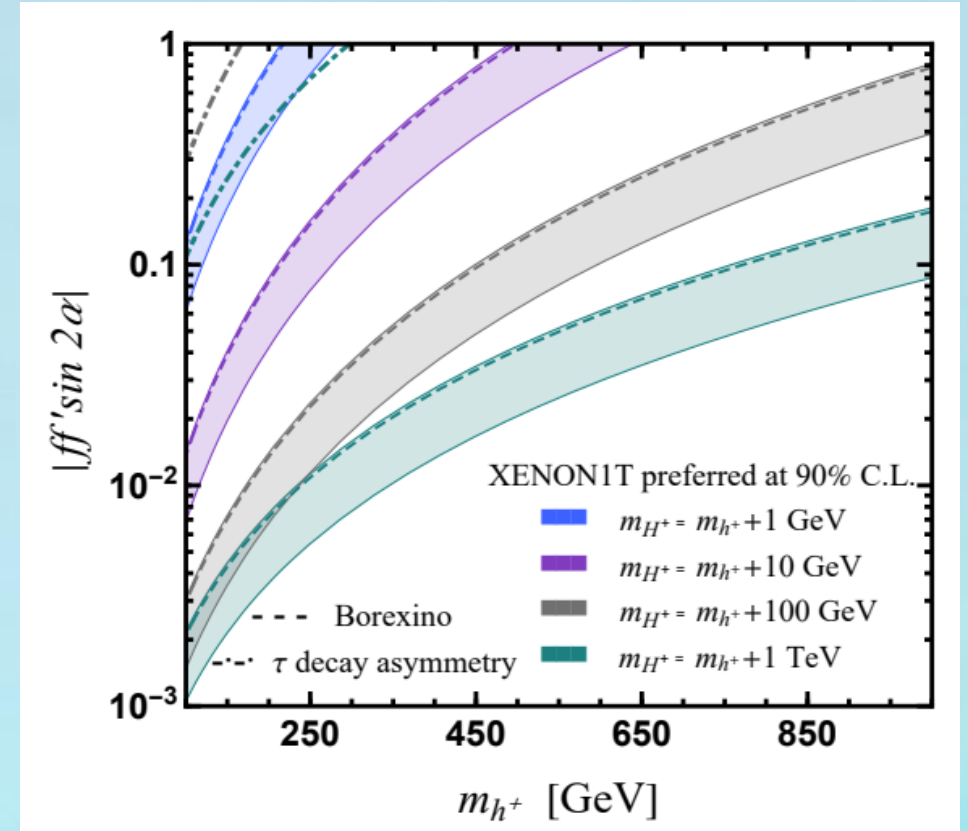

Babu, SJ, Lindner (2020)

Neutrino magnetic moments: a global picture

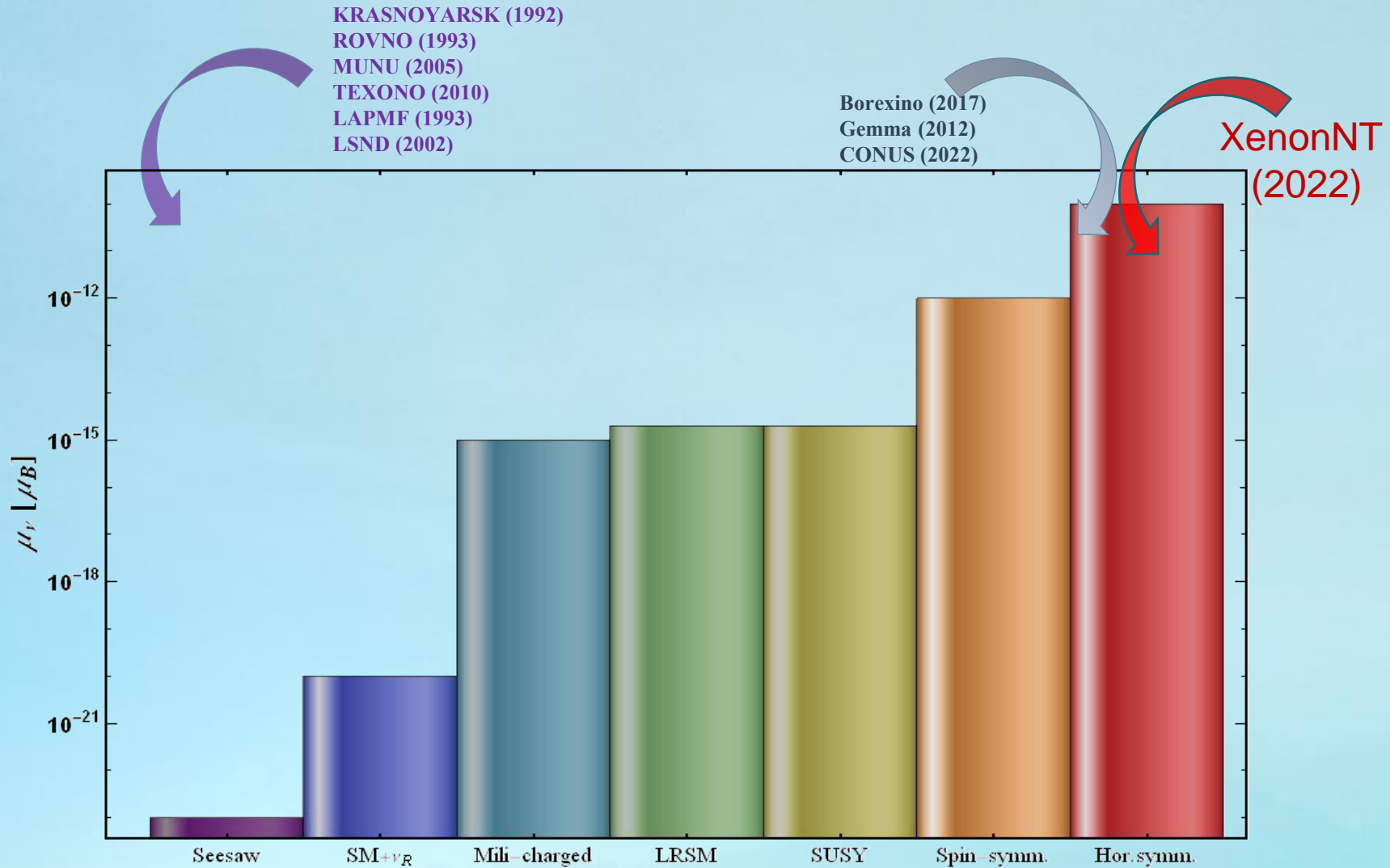

Neutrino magnetic moments: a global picture

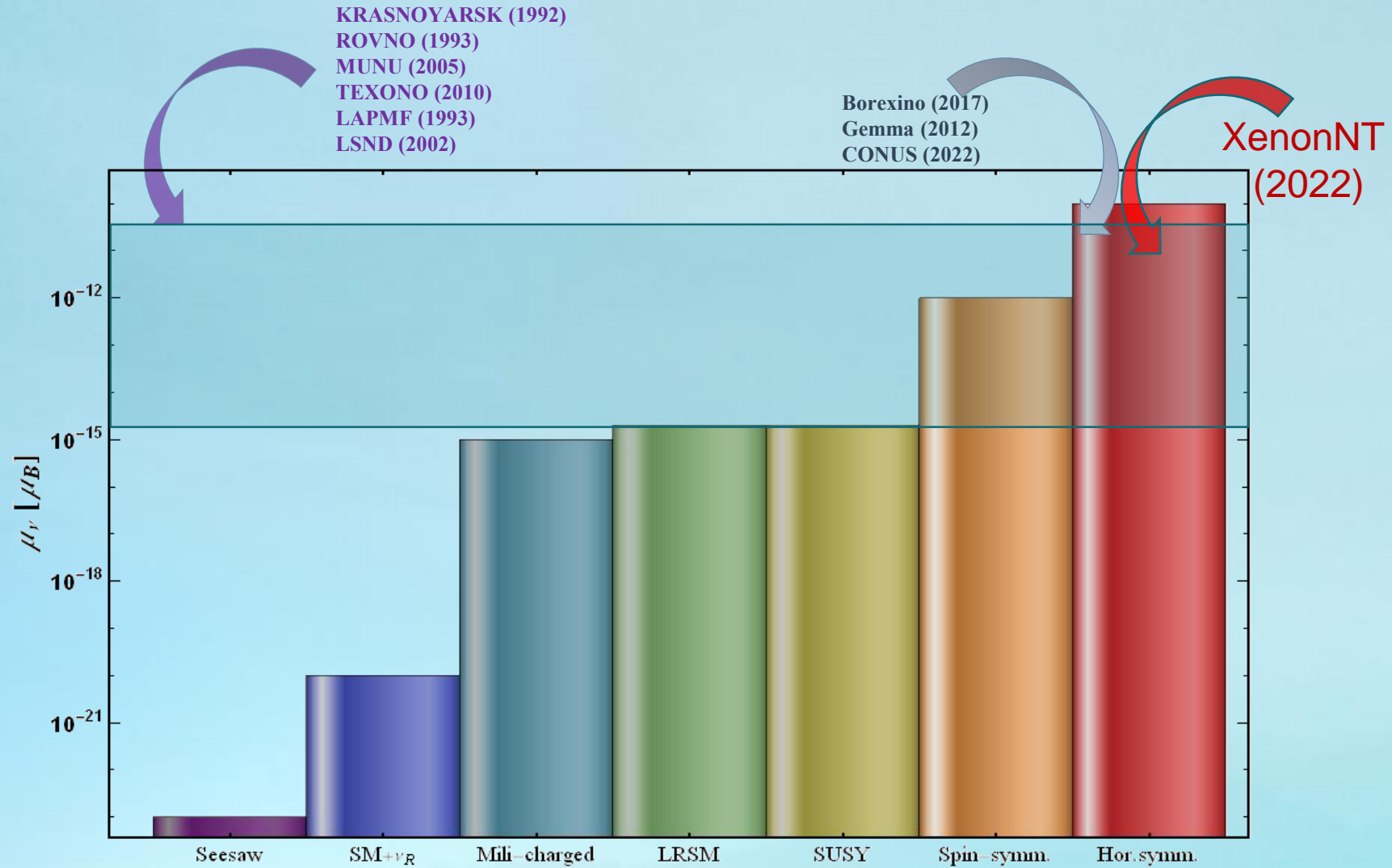

Neutrino magnetic moments – charged lepton $g-2$ correlation

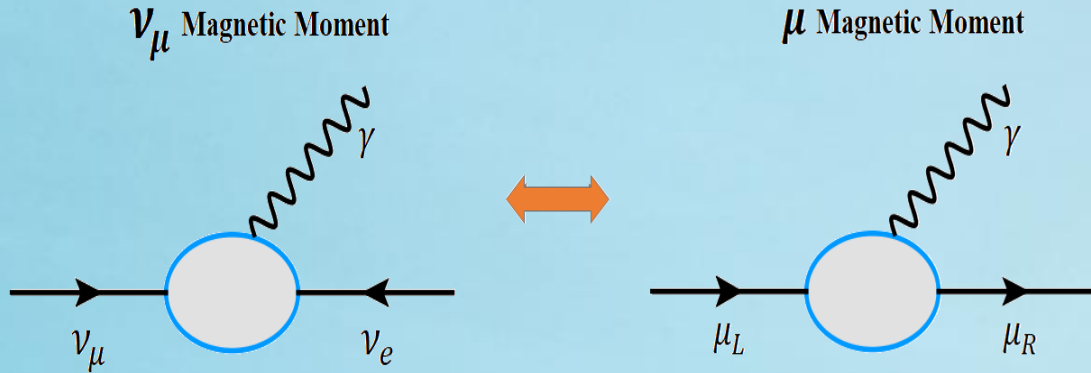

The models that induce neutrino magnetic moments while maintaining their small masses naturally also predict observable shifts in the charged lepton anomalous magnetic moment.

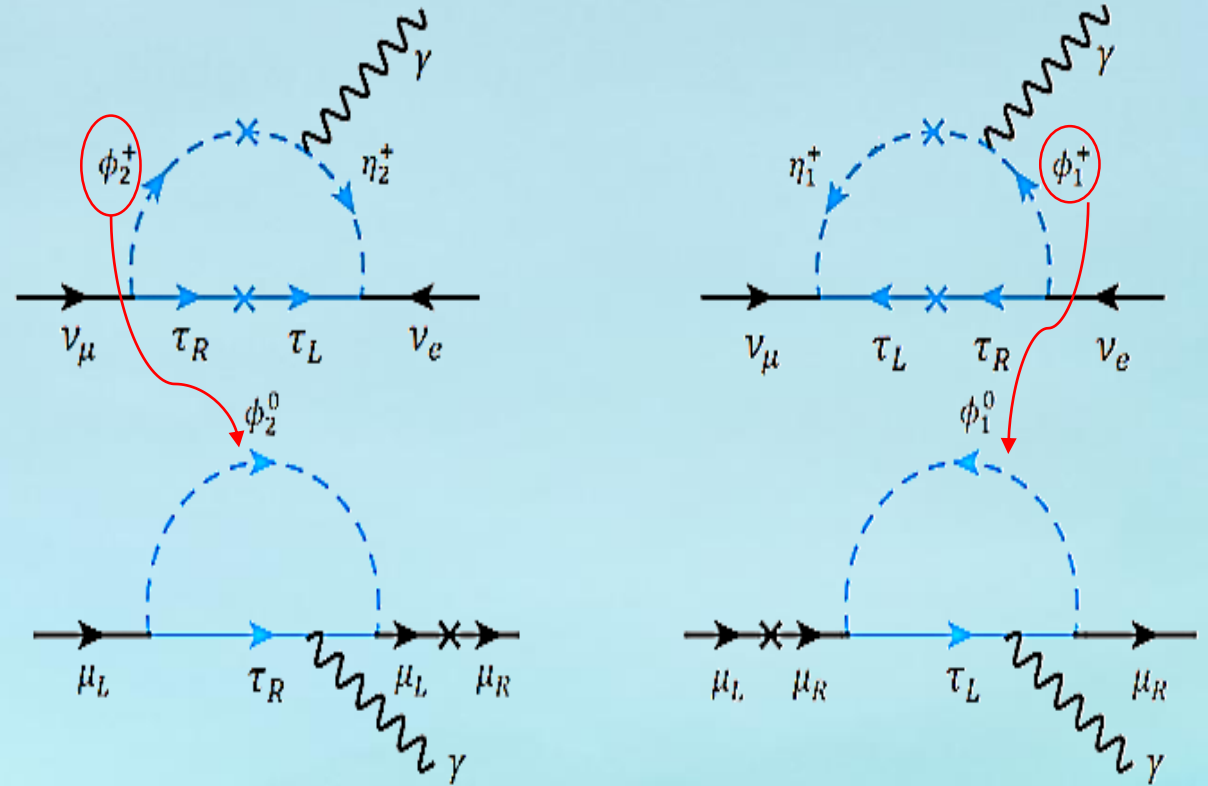

Neutrino magnetic moments – Muon $g-2$ anomaly

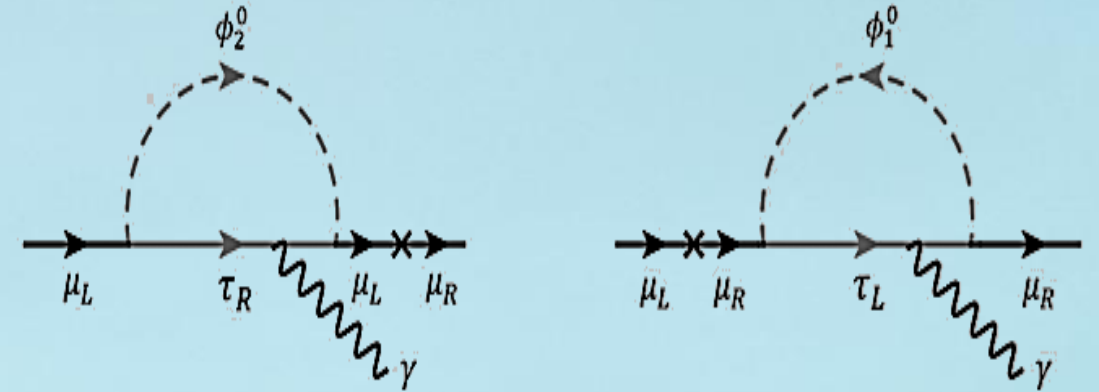
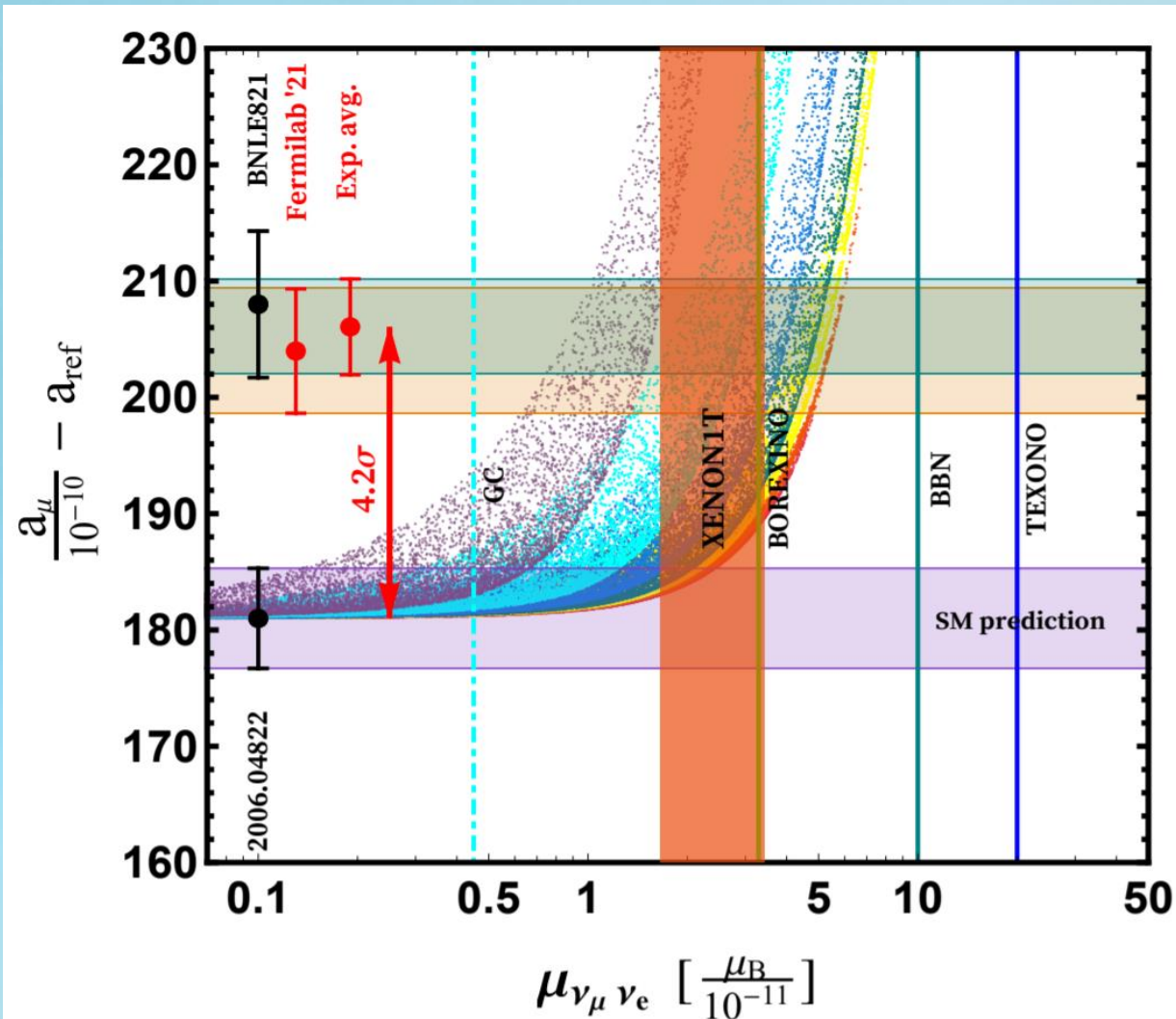

- *A direct correlation between the neutrino magnetic moment and muon $g-2$*
- Sign and strength are automatic here, no control over it.
- *A minimal unified framework: $\mu_\nu, m_\nu, (g-2)_\mu$.*

Exploiting a future galactic supernova to probe neutrino magnetic moments

Porto-Silva, SJ, Sen (2022)

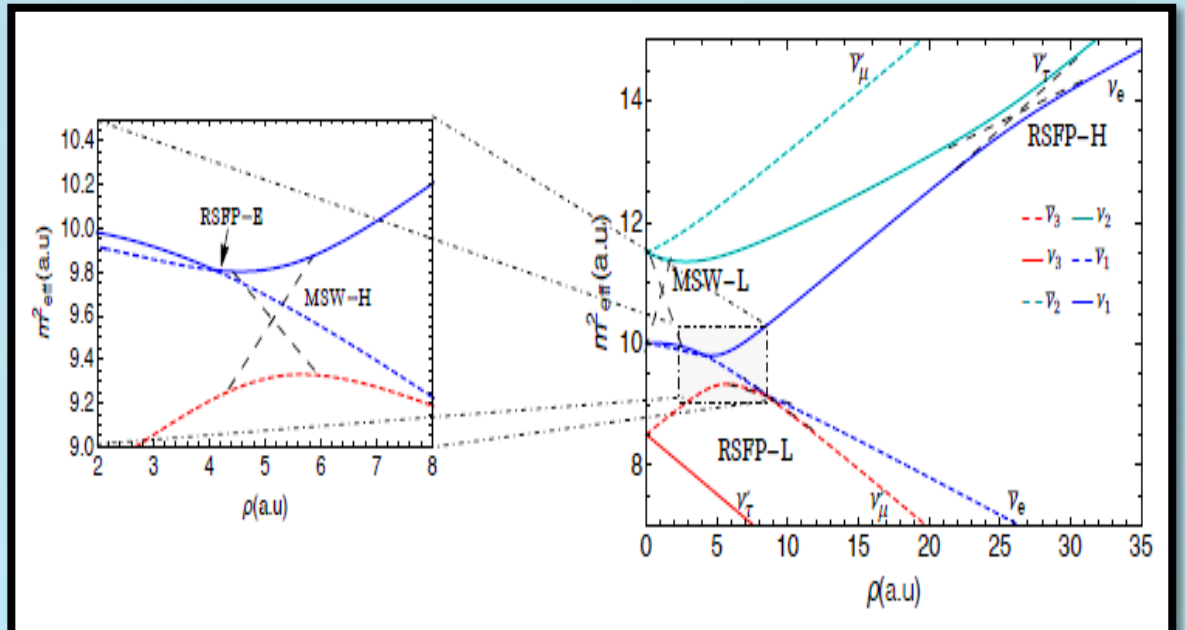
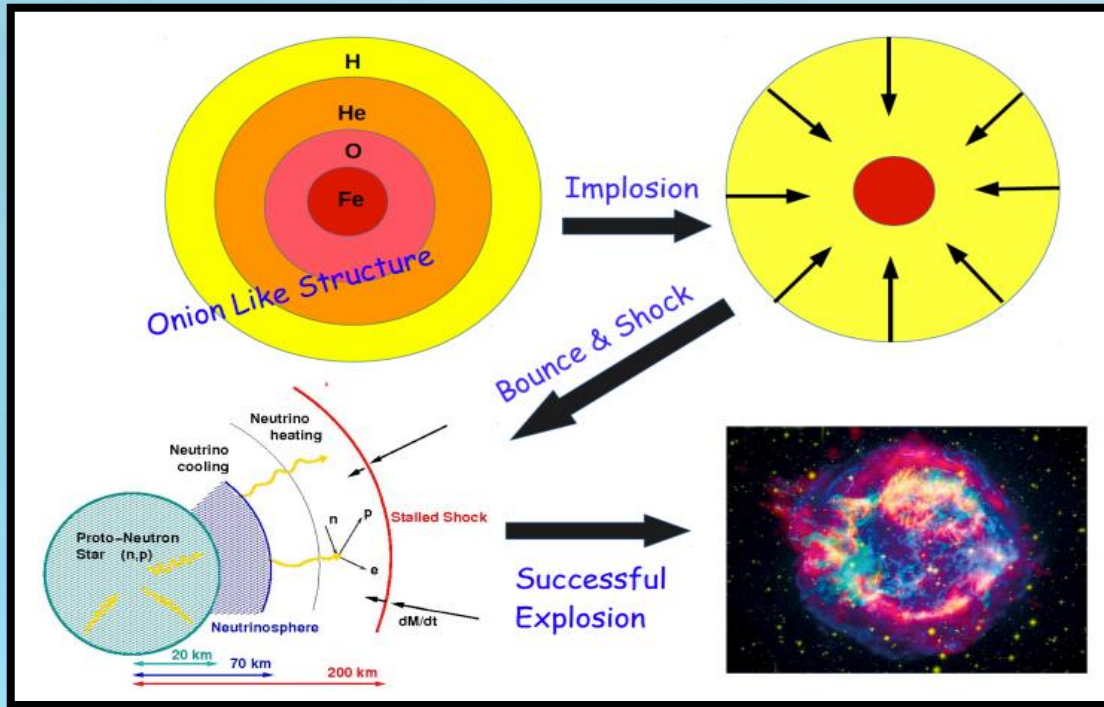

• Neutrino evolution equation:
$$i \frac{d}{dr} \begin{pmatrix} \nu \\ \bar{\nu} \end{pmatrix} = \begin{pmatrix} H_\nu & B_\perp M \\ -B_\perp M & H_{\bar{\nu}} \end{pmatrix} \begin{pmatrix} \nu \\ \bar{\nu} \end{pmatrix}$$

• Neutrino Hamiltonian in matter:
$$H_\nu = \frac{1}{2E} U \begin{pmatrix} 0 & 0 & 0 \\ 0 & \Delta m_{21}^2 & 0 \\ 0 & 0 & \Delta m_{31}^2 \end{pmatrix} U^\dagger + \begin{pmatrix} V_{\nu_e} & 0 & 0 \\ 0 & V_{\nu_\mu} & 0 \\ 0 & 0 & V_{\nu_\tau} \end{pmatrix}$$

Resonance Condition:
$$\frac{\Delta m_{21}^2}{2E_\nu} \cos 2\theta_{12} + \bar{V}_\mu - V_e = 0$$

Akhmedov and T. Fukuyama (2003),
Ando and Sato (2003)

Exploiting a future galactic supernova to probe neutrino magnetic moments

Porto-Silva, SJ, Sen (2022)

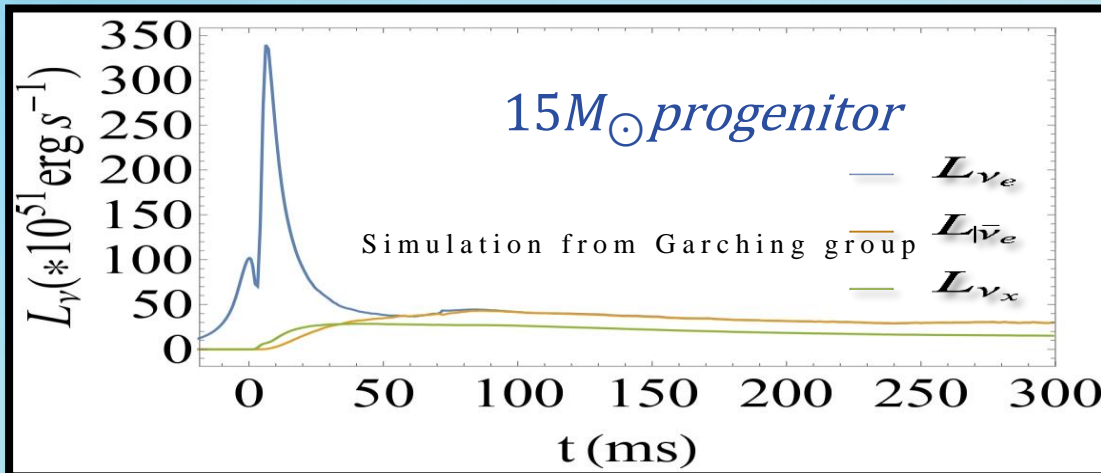
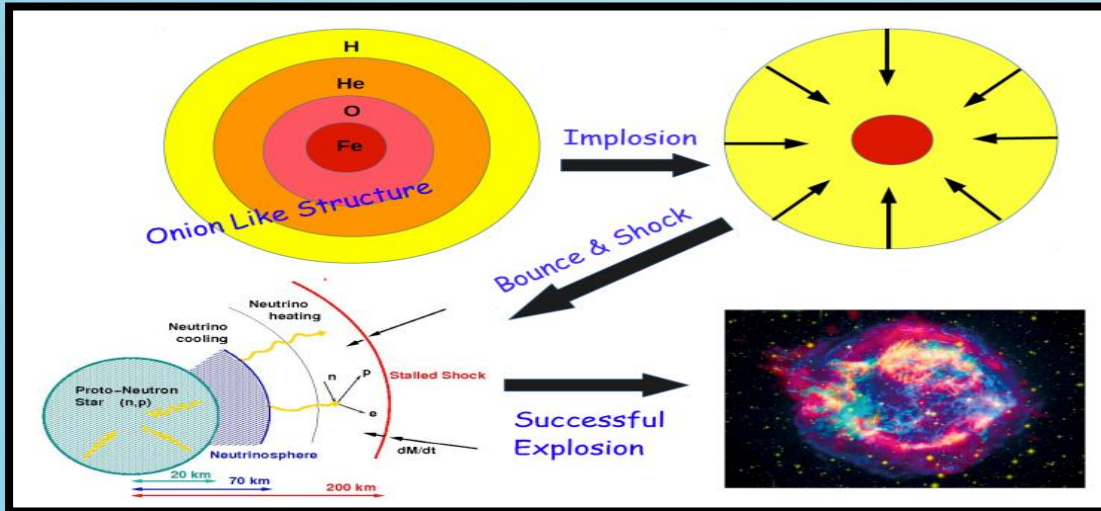

Akhmedov and T. Fukuyama (2003),
Ando and Sato (2003)

Resonance Condition:

$$\frac{\Delta m_{21}^2}{2E_\nu} \cos 2\theta_{12} + \bar{V}_\mu - V_e = 0$$

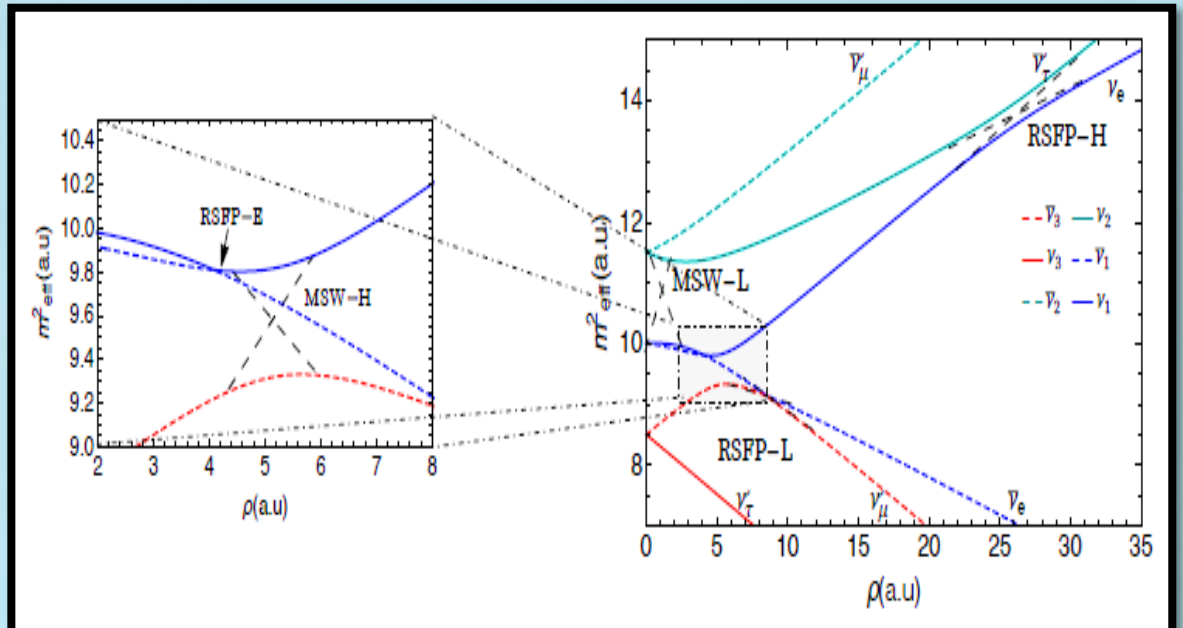

• Neutrino evolution equation:
$$i \frac{d}{dr} \begin{pmatrix} \nu \\ \bar{\nu} \end{pmatrix} = \begin{pmatrix} H_\nu & B_\perp M \\ -B_\perp M & H_{\bar{\nu}} \end{pmatrix} \begin{pmatrix} \nu \\ \bar{\nu} \end{pmatrix}$$

• Neutrino Hamiltonian in matter:
$$H_\nu = \frac{1}{2E} U \begin{pmatrix} 0 & 0 & 0 \\ 0 & \Delta m_{21}^2 & 0 \\ 0 & 0 & \Delta m_{31}^2 \end{pmatrix} U^\dagger + \begin{pmatrix} V_{\nu_e} & 0 & 0 \\ 0 & V_{\nu_\mu} & 0 \\ 0 & 0 & V_{\nu_\tau} \end{pmatrix}$$

Exploiting a future galactic supernova to probe neutrino magnetic moments

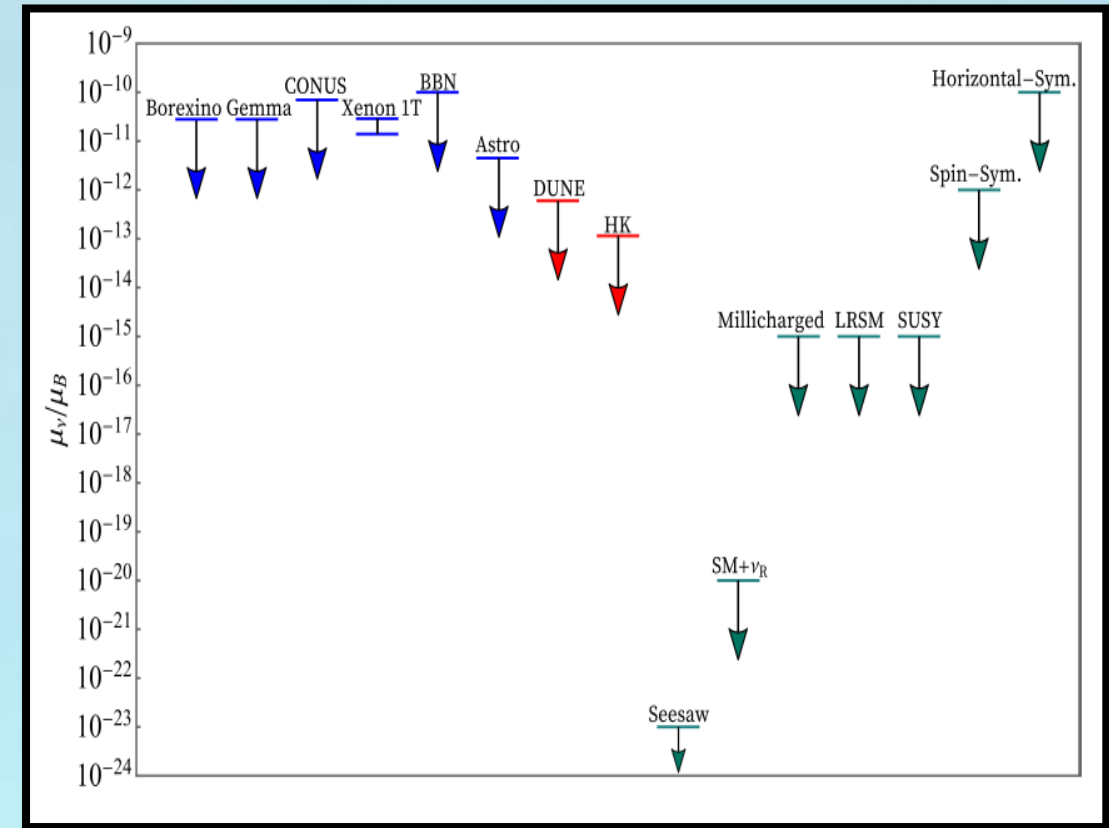
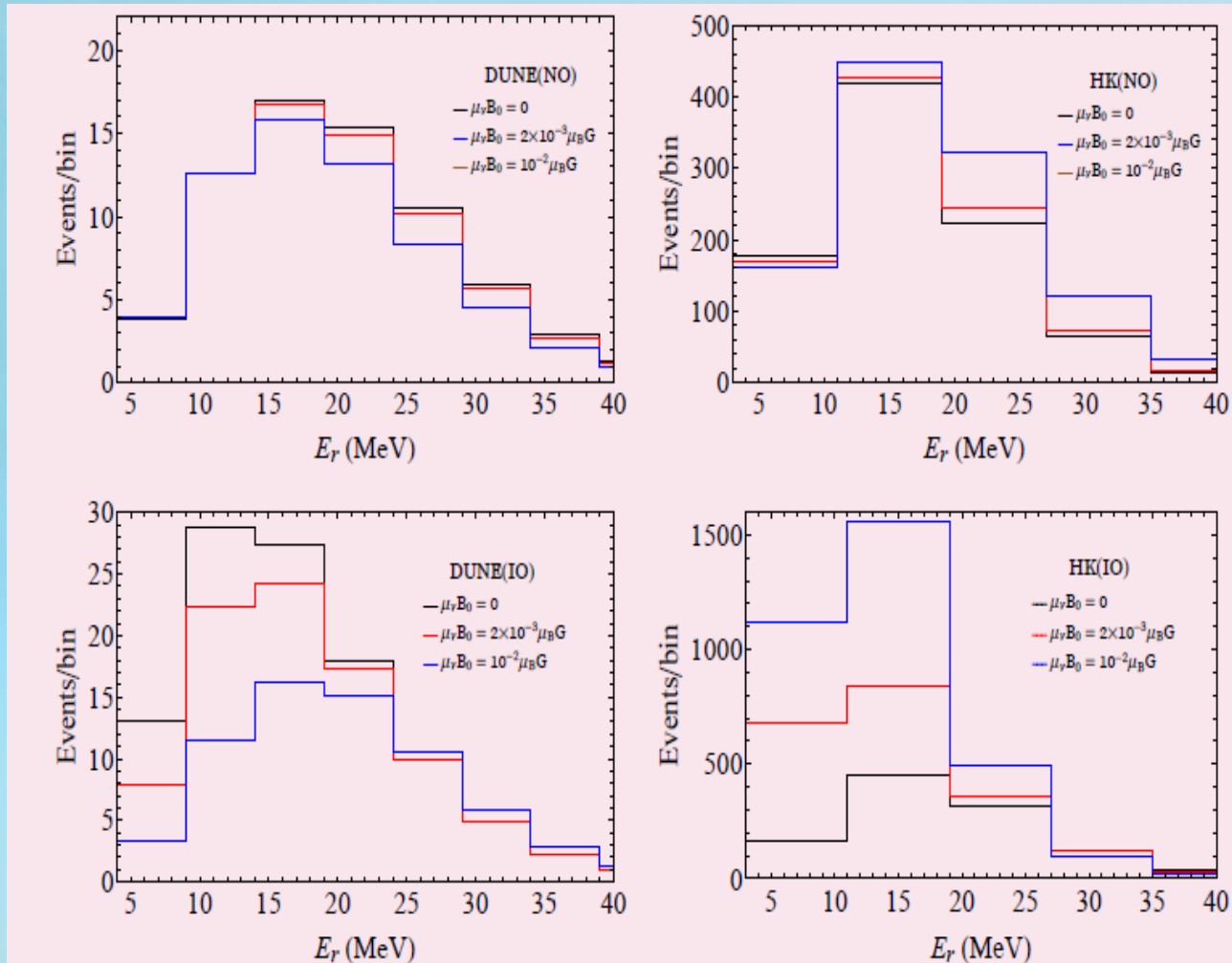

Porto-Silva, SJ, Sen (JCAP 2022)

Dirac neutrino magnetic moments in Sne?

$$i \frac{d}{dr} \begin{bmatrix} \nu_{eL} \\ \nu_{eR} \end{bmatrix} = \begin{bmatrix} V_e & \mu_\nu B(r) \\ \mu_\nu B(r) & 0 \end{bmatrix} \begin{bmatrix} \nu_{eL} \\ \nu_{eR} \end{bmatrix}$$

But $V_e \neq 0$ “Always”

SN neutrino flavor conversion was thought to be insensitive to Dirac Magnetic Moments.

Dirac neutrino magnetic moments in Sne?

$$i \frac{d}{dr} \begin{bmatrix} \nu_{eL} \\ \nu_{eR} \end{bmatrix} = \begin{bmatrix} V_e + \dot{\phi}/2 & \mu_\nu B(r) \\ \mu_\nu B(r) & -\dot{\phi}/2 \end{bmatrix} \begin{bmatrix} \nu_{eL} \\ \nu_{eR} \end{bmatrix}$$

$$V_e + \dot{\phi} = 0 \quad \text{(Resonance Condition)}$$

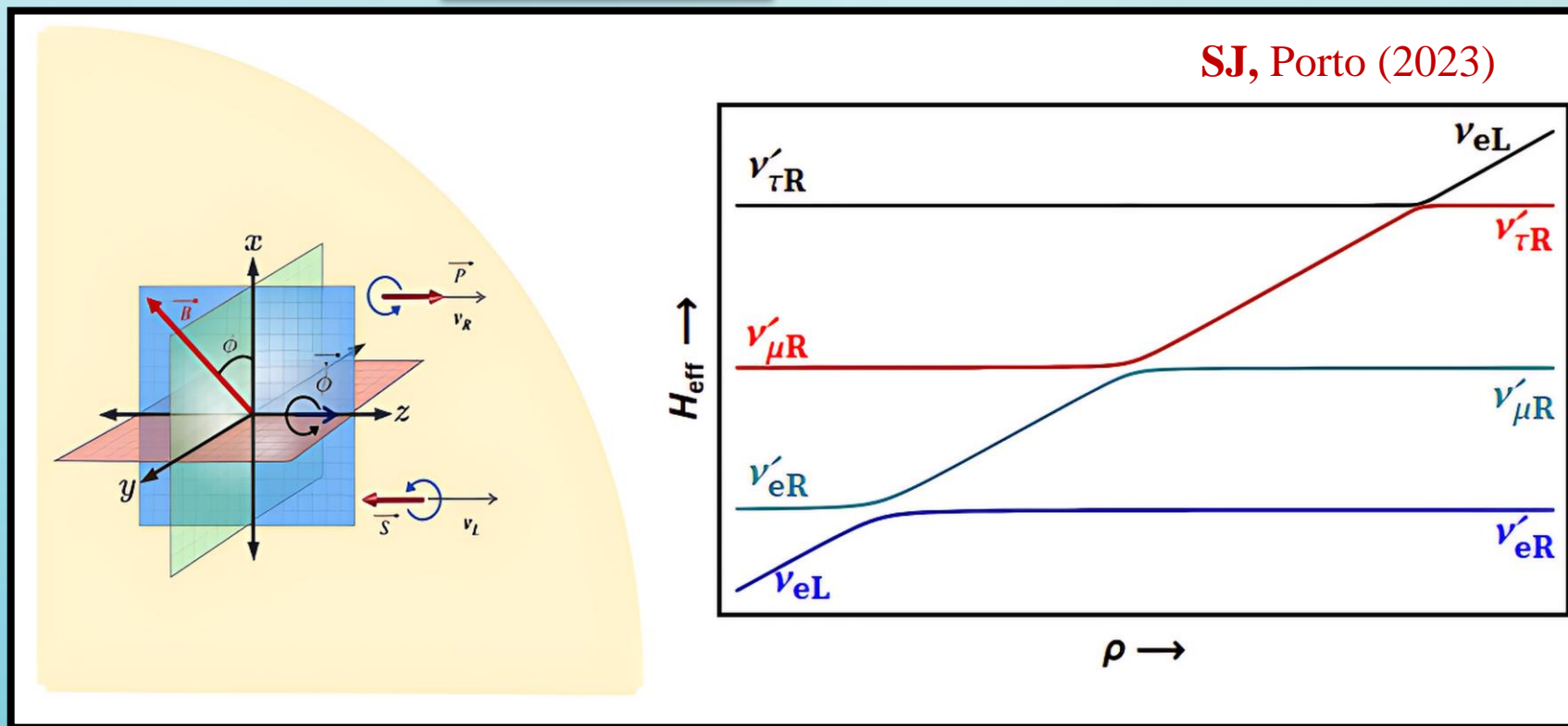

Neutrino evolution in Twisting Magnetic Fields

$$i \frac{d}{dr} \begin{bmatrix} \nu_L \\ \nu_R \end{bmatrix} = \begin{bmatrix} H_L + (\dot{\phi}/2)I & \mu B(r) \\ \mu^\dagger B(r) & H_R - (\dot{\phi}/2)I \end{bmatrix} \begin{bmatrix} \nu_L \\ \nu_R \end{bmatrix}$$

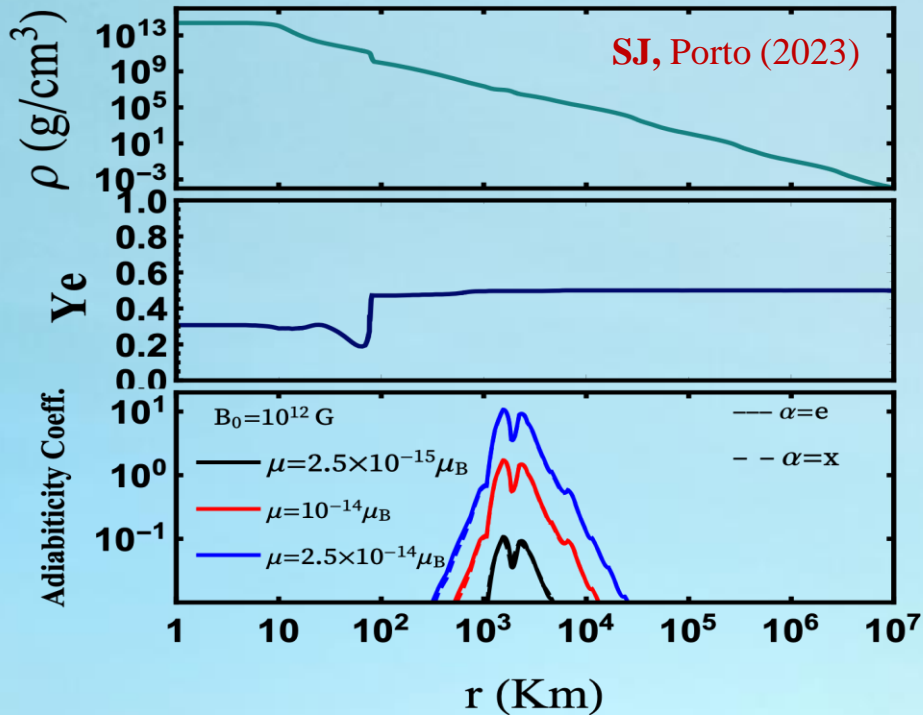

Efficient conversion in the edge of the Fe-core

$$\gamma_\alpha = \frac{2(2\mu_\nu B)^2}{|\dot{V}_\alpha + \ddot{\phi}|} \gg 1$$

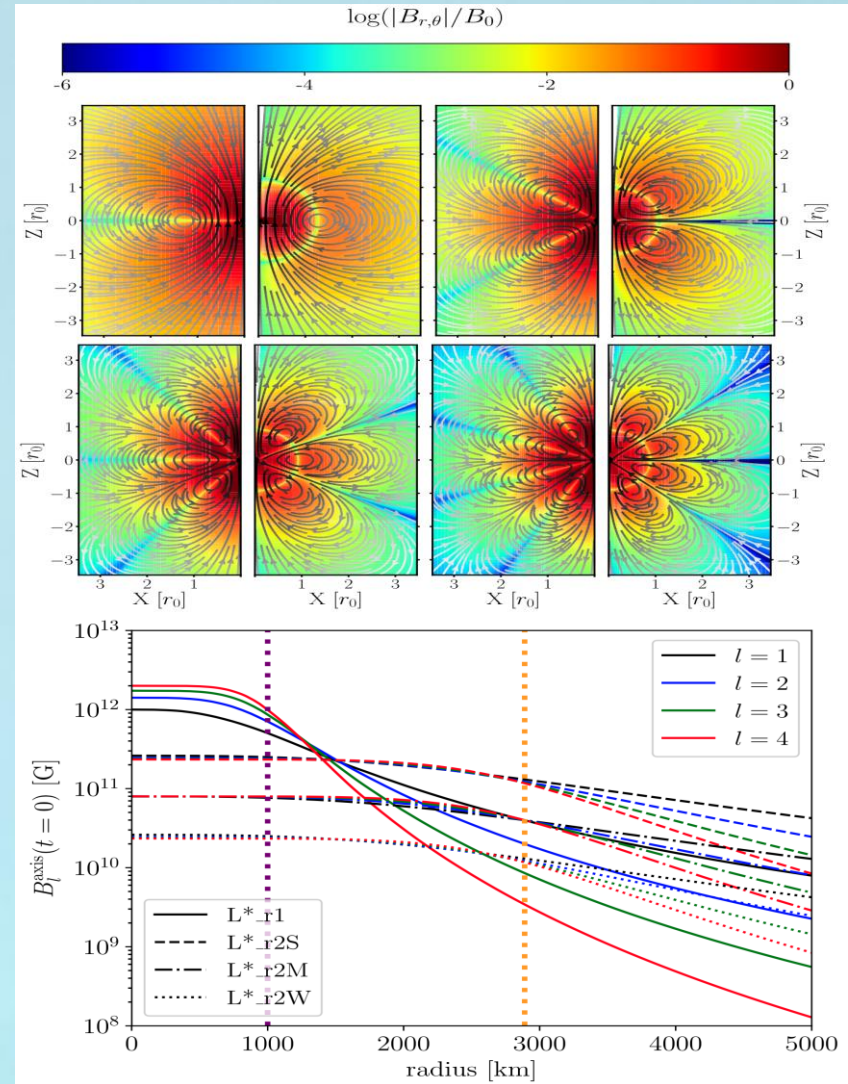

Bugli et al. "The impact of non-dipolar magnetic fields in core-collapse supernovae," Mon. Not. Roy. Astron. Soc. 492 (2020) no. 1, 58–71,

Neutrino evolution in Twisting Magnetic Fields

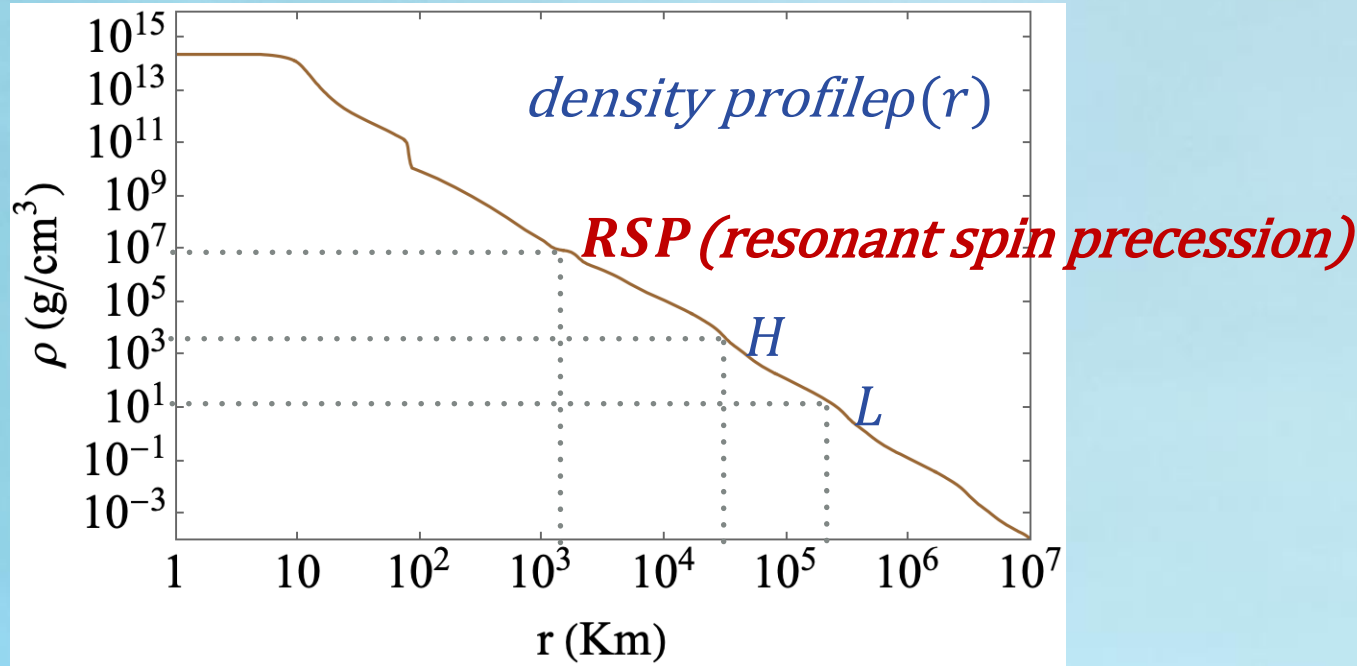

RSP converts left-handed neutrinos (ν_L) to their right-handed counterparts (ν_R) via interaction μ_ν and magnetic fields.

RSP happens at the edge of the Fe-core at $r_0 \sim [1,3] \times 10^3$ Km.

SJ, Porto (2023)

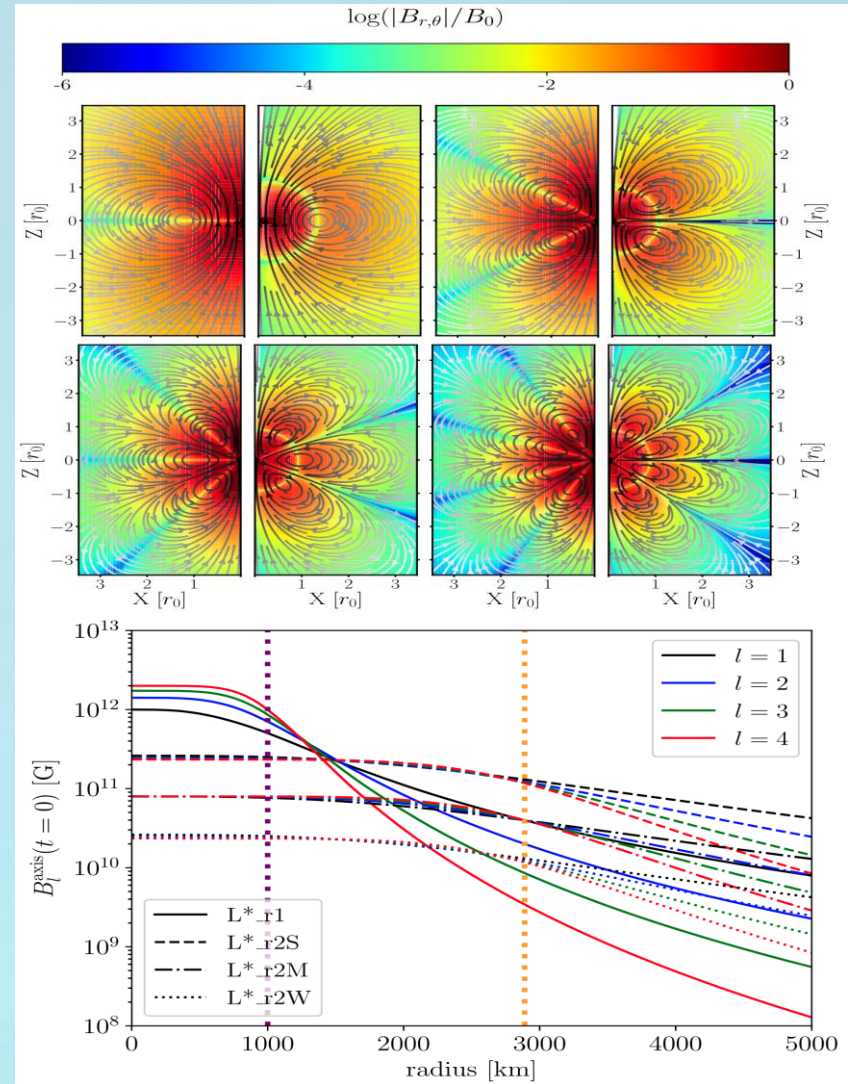

Bugli et al. "The impact of non-dipolar magnetic fields in core-collapse supernovae," Mon. Not. Roy. Astron. Soc. 492 (2020) no. 1, 58–71,

Simplified Picture of Flavor Conversions

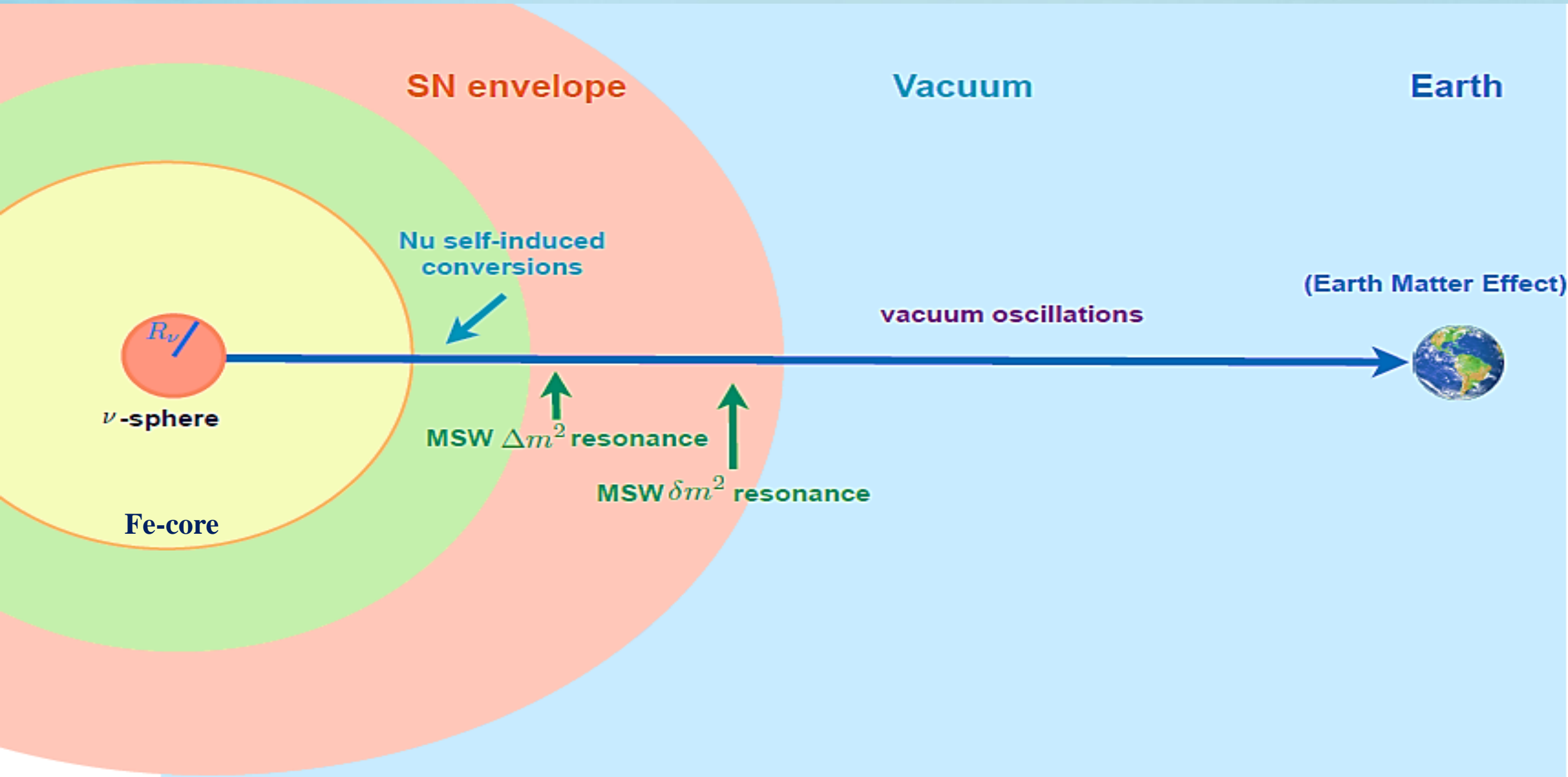

Simplified Picture of Flavor Conversions

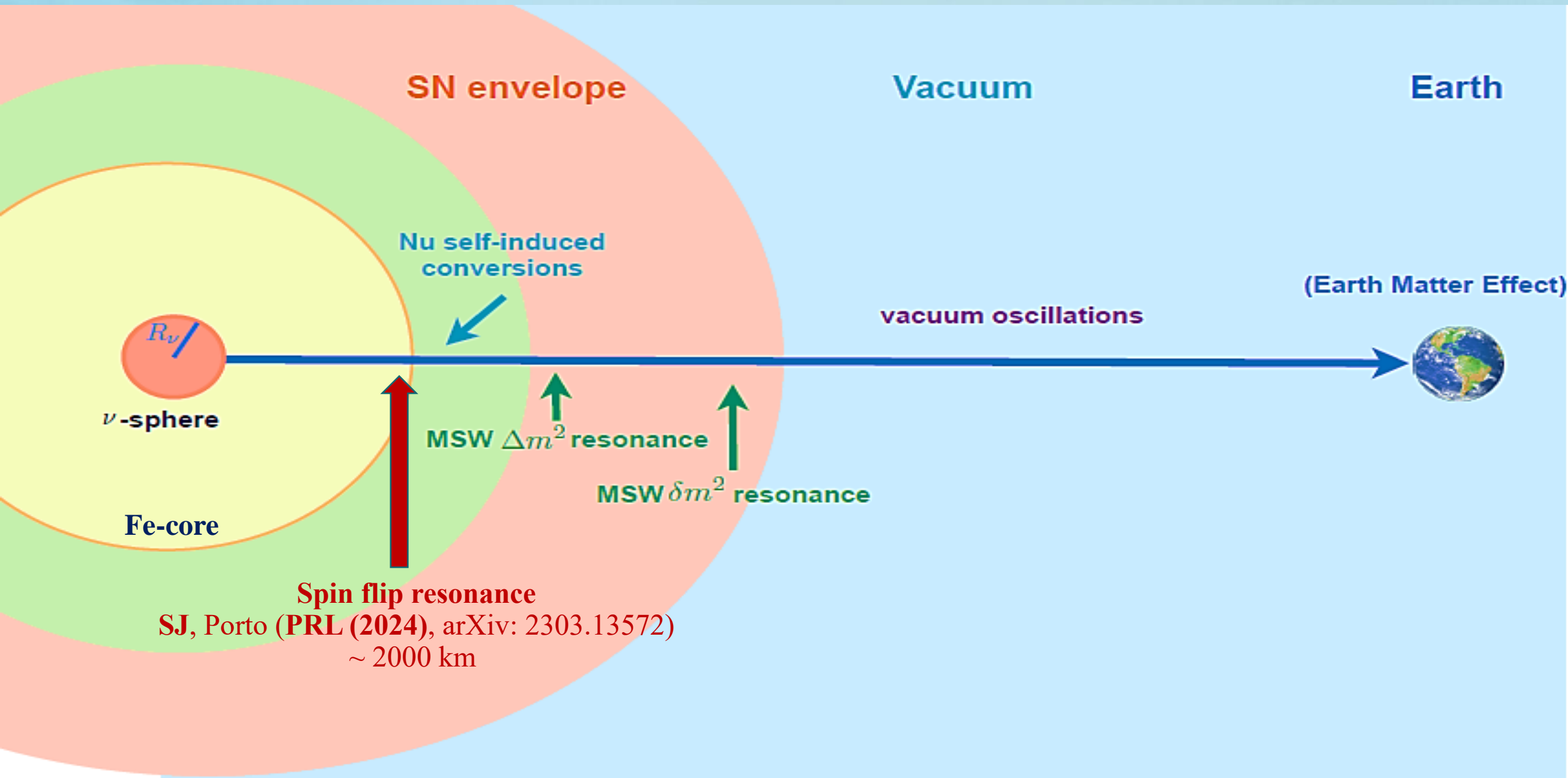

Neutrino spectra at DUNE and HK

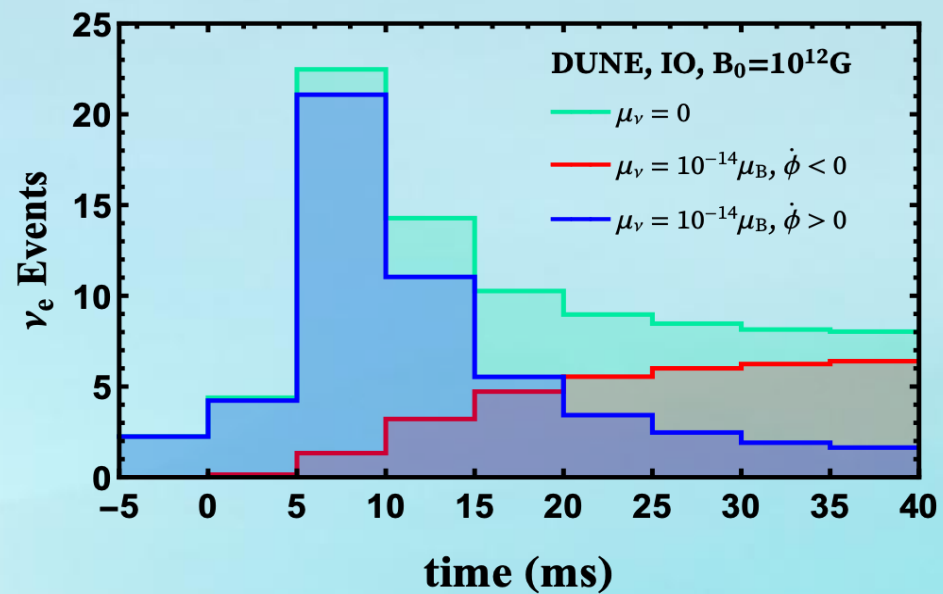
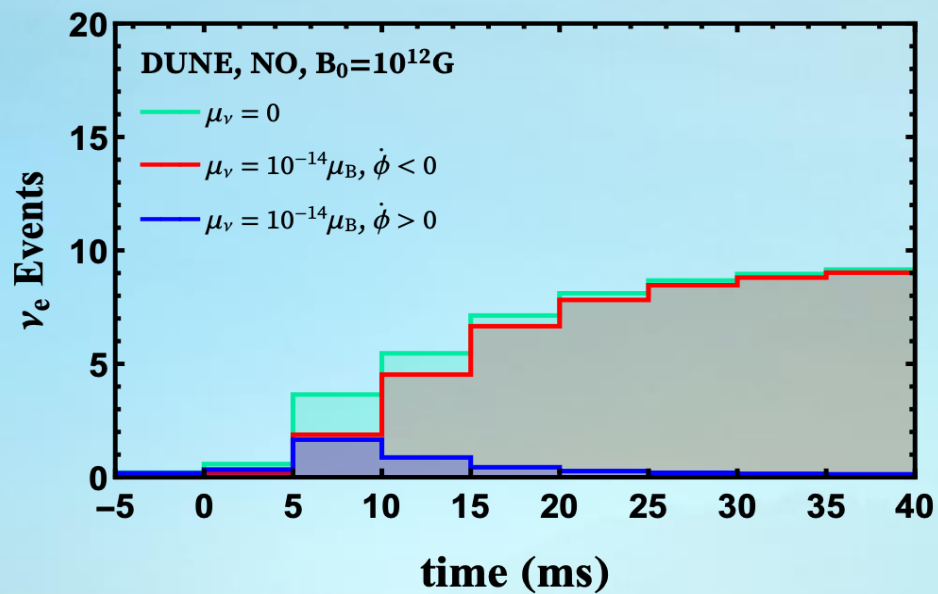
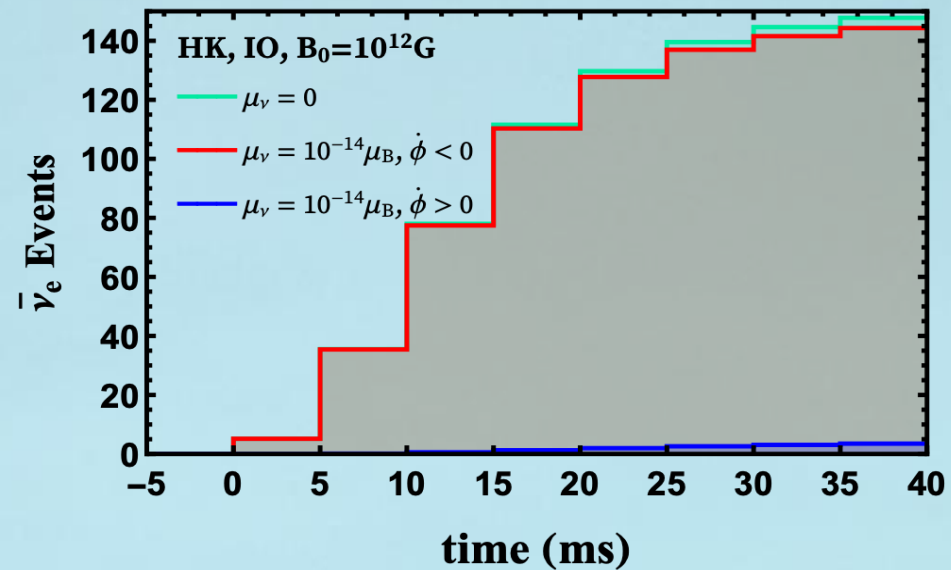
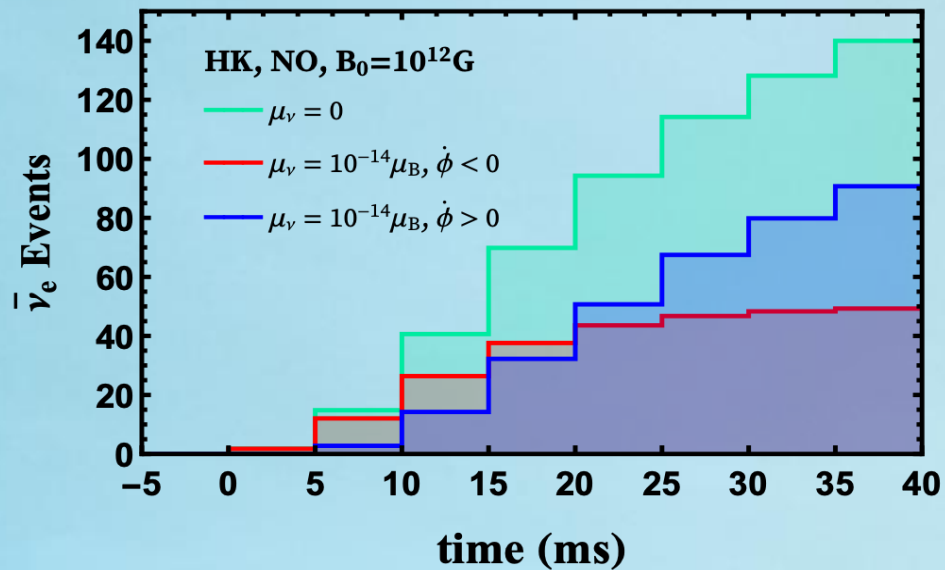

Neutrino spectra at DUNE and HK

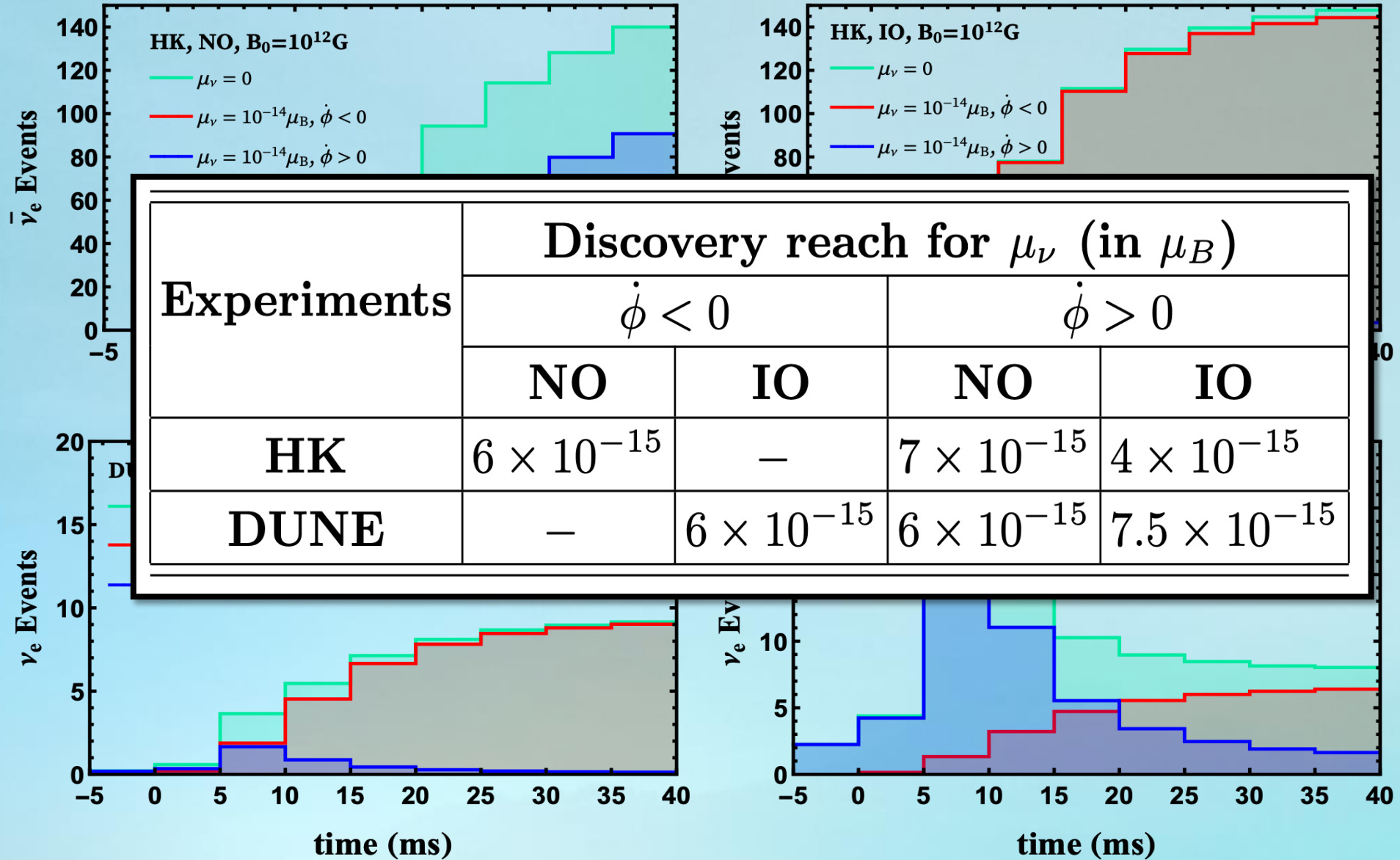

Active to sterile transition magnetic moments

Triggered by the several anomalies such as **XENON1T** and the long-standing **MiniBooNE** anomalies, the **magnetic dipole portal** linking the active and sterile neutrinos has been recently received attention and studied at various facilities.

$$\mathcal{L}_{\text{dipole}} \supset \frac{1}{2} \mu_\nu^\alpha \bar{\nu}_L^\alpha \sigma^{\mu\nu} N_R F_{\mu\nu}$$

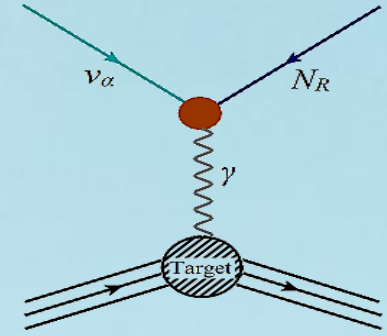

Ismail, **SJ**, Mammen Abraham (2021)

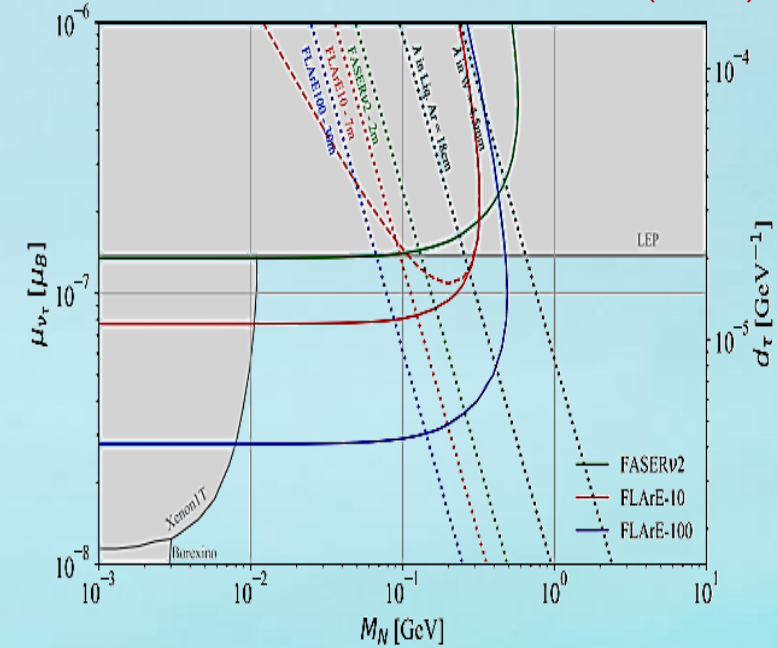
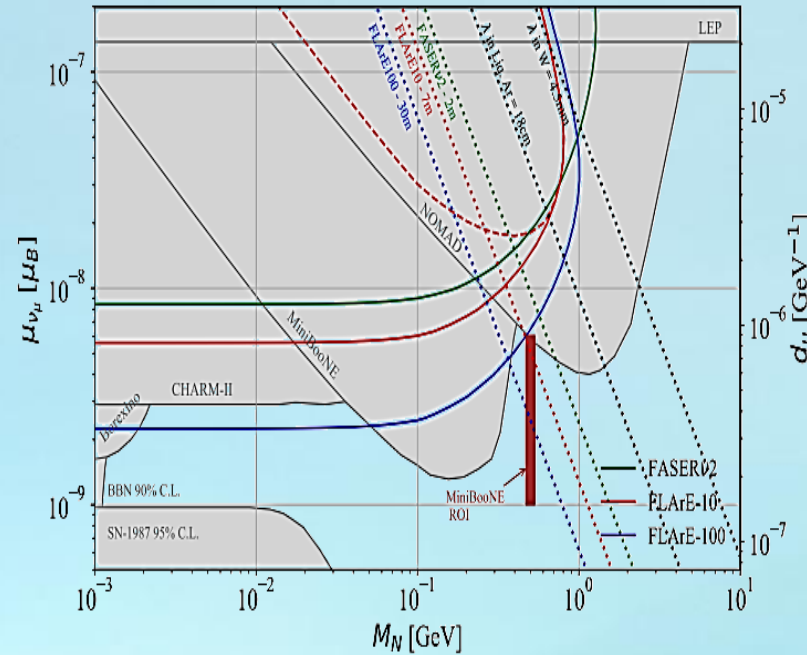
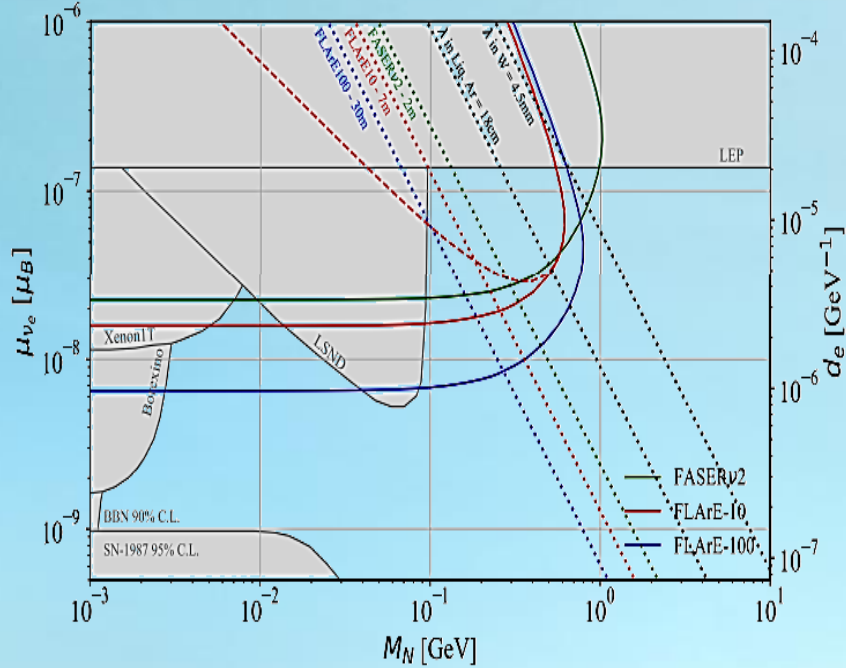

For other works on dipole portal in different contexts, see S. Gninenko (2009, 2012), Magill et al. (2018), Schwetz et al. (2020), Brdar et al. (2021), Shoemaker et al. (2021), Bolton et al. (2021), Miranda et al. (2021), Zhange et al. (2022), Jodłowski et al. (2020), Machado et al. (2023) ...

Active to sterile transition magnetic moments

The EeV cosmogenic neutrino flux, though uncontrollable, represents a new energy frontier with collision energies much higher than what has been achieved by colliders. With this energy frontier, UHE neutrino telescopes have many advantages in probing certain new physics processes.

Primakoff production of heavy sterile neutrino via ν transition magnetic moment

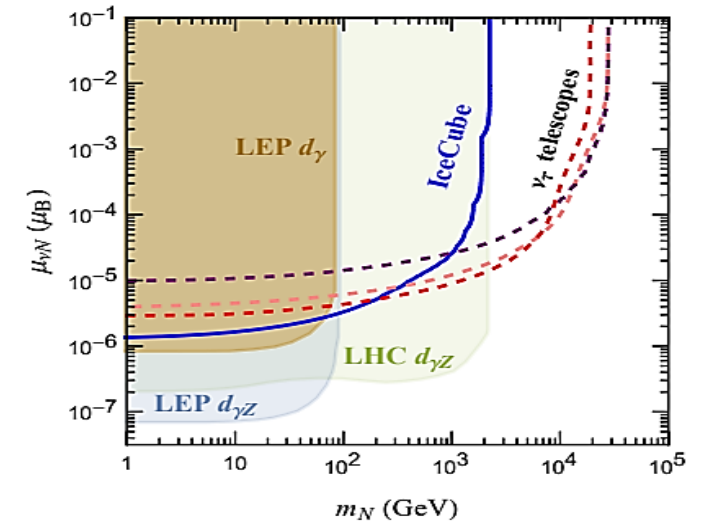
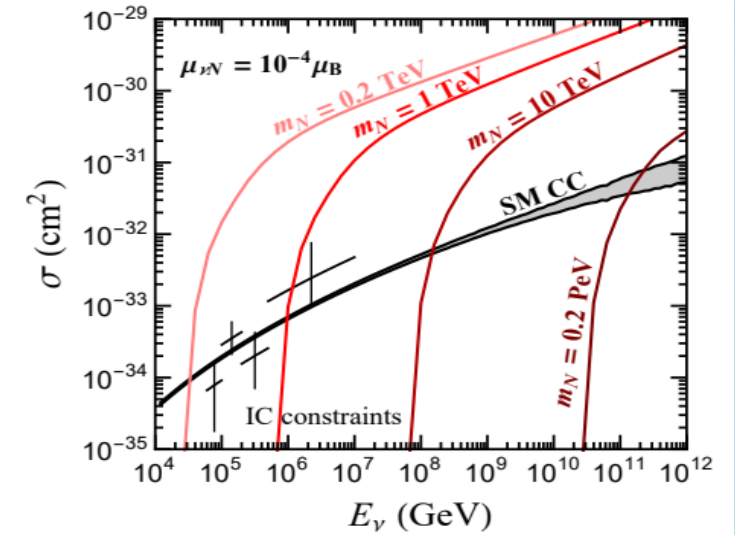
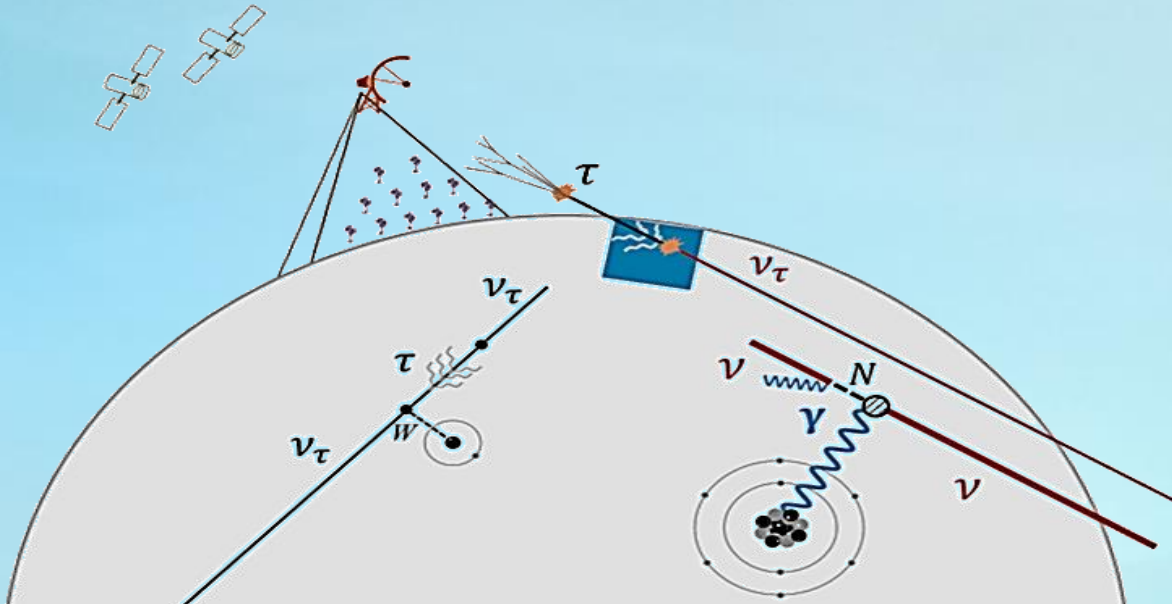

Huang, SJ, Lindner, Rodejohann (2022)

Other electromagnetic properties of neutrino

Electric (milli-) charge of neutrinos

Neutrinos can have nonzero neutrino electric millicharges. The introduction of a right-handed neutrino ν_R into the standard model brings a new hypercharge parameter, into the anomaly equations which destroys the charge quantization.

$$\mathcal{L} \supset q_{\nu_\alpha} \bar{\nu}_\alpha \gamma_\mu \nu_\alpha A^\mu$$

$$Q_{st} + \epsilon(L_i - L_j)$$

Consequences:

1. Charge conservation in β -decay
2. Physical consequences of charged atoms
3. Anomalous magnetic moments of charged leptons
4. Neutrino-electron/nucleon scattering
5. Energy loss in red giant and white dwarf stars
6. Limits on a cosmologically induced thermal photon mass

Constraints:

- $q_\nu \sim 10^{-21} e$ from neutrality of the hydrogen atom
- $q_\nu \leq 10^{-19} e$ from astrophysical limit (from the impact of the neutrino star turning mechanism)
- $q_\nu \leq 1.5 \times 10^{-11} e$ from reactor neutrino constraint

Neutrino charge-radius

- Even if a neutrino millicharge is vanishing, the electric form factor can still contain nontrivial information about neutrino electromagnetic properties.

$$\langle r_{ij}^2 \rangle = -6 \frac{df_Q^{ij}(q^2)}{dq^2} \Big|_{q^2=0}$$

- For a massless neutrino the neutrino charge radius is the only electromagnetic characteristic that can have nonzero value.

$$\langle r_{\nu_\alpha}^2 \rangle_{\text{SM}} = \frac{G_f}{4\sqrt{2}\pi^2} \left[3 - 2 \log \frac{m_\ell^2}{m_W^2} \right]$$

$$\langle r_{\nu_e}^2 \rangle_{\text{SM}} \simeq 4.1 \times 10^{-33} \text{ cm}^2$$

$$\langle r_{\nu_\mu}^2 \rangle_{\text{SM}} \simeq 2.4 \times 10^{-33} \text{ cm}^2$$

$$\langle r_{\nu_\tau}^2 \rangle_{\text{SM}} \simeq 1.5 \times 10^{-33} \text{ cm}^2$$

- The best constraints (in cm^2) come from CCFR and CHARM-II:

$$-2.6 \times 10^{-33} < \langle r_{\nu_e}^2 \rangle < 6.6 \times 10^{-32}$$

$$-5.2 \times 10^{-33} < \langle r_{\nu_\mu}^2 \rangle < 6.8 \times 10^{-33}$$

Bernabeu et al. (2000), Hirsch et al. (2003)...

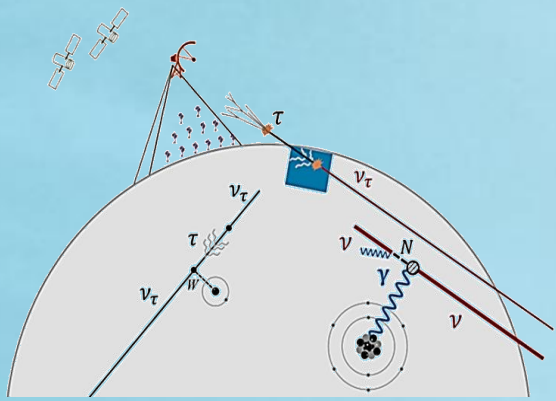

Summary

- The theoretical and experimental investigation of neutrino electromagnetic interactions can serve as a powerful tool in the search for the fundamental theory behind the neutrino mass generation mechanism.*
- Anomalous electromagnetic properties of charged leptons and neutrinos can be correlated.*
- If neutrinos are Dirac particles possessing large magnetic moments, the new resonance effect will present the most optimal avenue towards unravelling the scenario at hand.*

.....

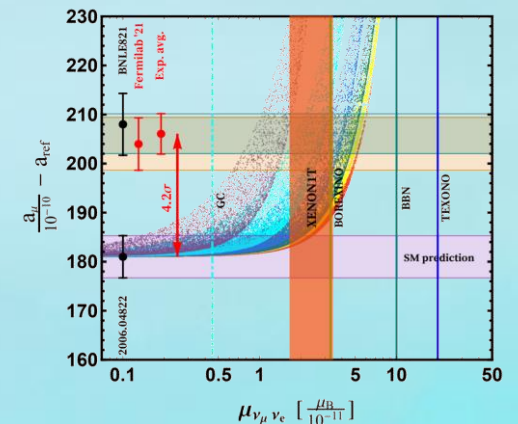
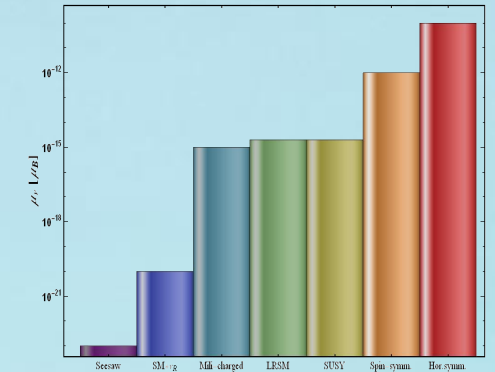



Thank you!