

# Probing New Physics with Double Beta Decay

Frank Deppisch  
[f.deppisch@ucl.ac.uk](mailto:f.deppisch@ucl.ac.uk)

University College London

# Dirac versus Majorana

- ▶ Origin of neutrino masses beyond the Standard Model
- ▶ Two possibilities to define neutrino mass

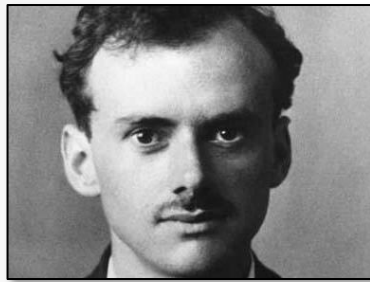

Dirac mass analogous to other fermions but with  $m_\nu / \Lambda_{EW} \approx 10^{-12}$  couplings to Higgs

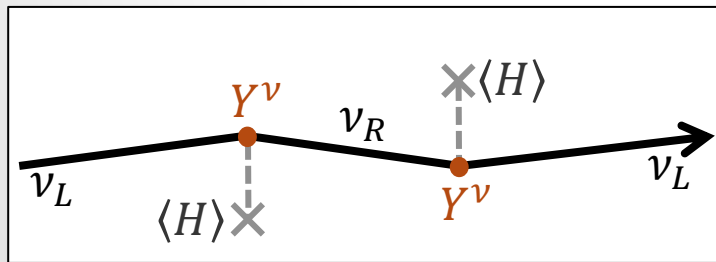

Majorana mass, using only a left-handed neutrino  
→ Lepton Number Violation

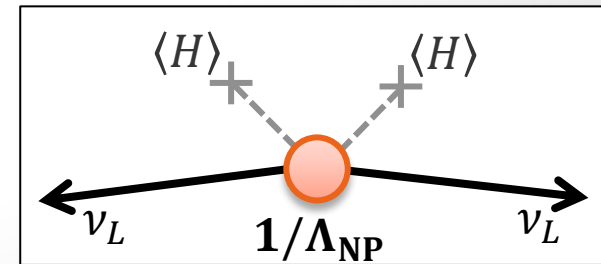

# Beta Decays and $\nu$ Nature

## ▶ Single beta decay

$$(A, Z) \rightarrow (A, Z + 1) + e^- + \bar{\nu}_e$$

- Tritium decay, KATRIN:  $m_\beta \approx 0.2 \text{ eV}$
- Project 8: Atomic Tritium + Cyclotron Radiation Spectroscopy:  $m_\beta \approx 0.05 \text{ eV}$

## ▶ Allowed double beta ( $2\nu\beta\beta$ ) decay

$$(A, Z) \rightarrow (A, Z + 2) + 2e^- + 2\bar{\nu}_e$$

## ▶ Neutrinoless double beta ( $0\nu\beta\beta$ ) decay

$$(A, Z) \rightarrow (A, Z + 2) + 2e^-$$

- Violation of lepton number
- Mediated by Majorana neutrinos

## ▶ Majoron assisted double beta ( $0\nu\beta\beta J$ ) decay

- Missing energy  $\rightarrow$  lepton number violated?

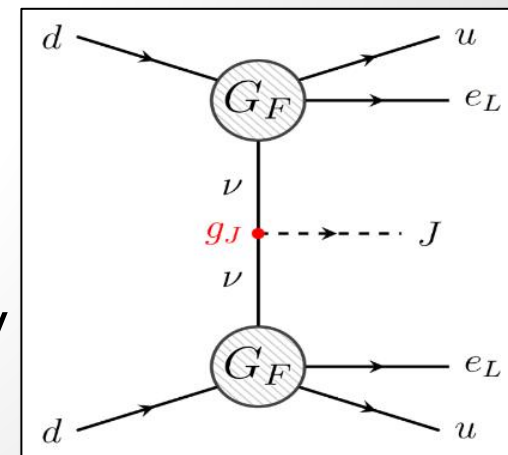
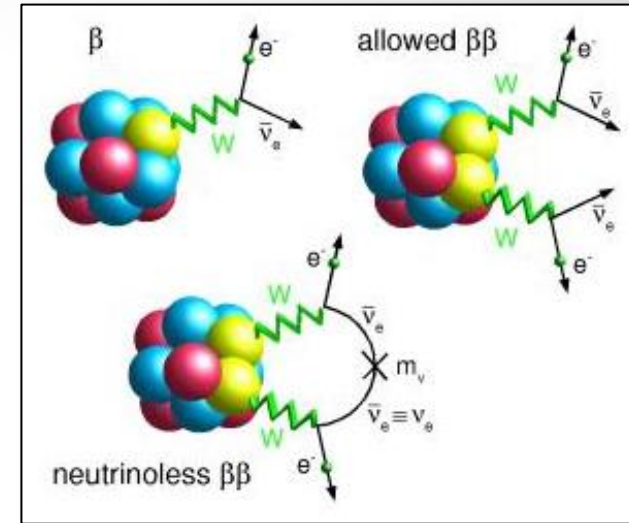

# Neutrinoless Double $\beta$ Decay

▶ Half-life

$$T_{1/2}^{-1} = |m_{\beta\beta}|^2 G^{0\nu} |M^{0\nu}|^2$$

▶ Particle Physics

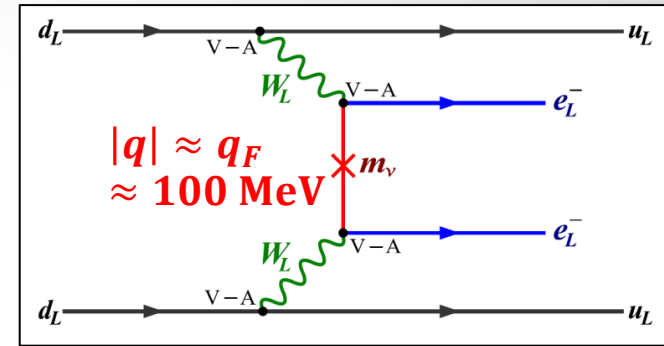

$$\mathcal{A}_{\mu\nu}^{lep} = \frac{G_F^2}{4} \sum_{i=1}^3 U_{ei}^2 \gamma_\mu (1 + \gamma_5) \frac{\not{q} + m_{\nu_i}}{q^2 - m_{\nu_i}^2} \gamma_\nu (1 - \gamma_5) \approx G_F^2 \frac{\gamma_\mu (1 + \gamma_5) \gamma_\nu}{4q^2} \sum_{i=1}^3 U_{ei}^2 m_{\nu_i} \rightarrow m_{\beta\beta}$$

▶ Atomic Physics

- Leptonic phase space  $G^{0\nu} \propto Q^5$

$$\Gamma_{0\nu\beta\beta} \sim m_\nu^2 G_F^4 q_F^2 Q^5 \sim (m_\nu / 0.1 \text{ eV})^2 (10^{26} \text{ yr})^{-1}$$

▶ Nuclear Physics

- Nuclear matrix element  $M^{0\nu} \approx 1$  but large uncertainties

$Q + 2m_e \approx 3-5 \text{ MeV}$

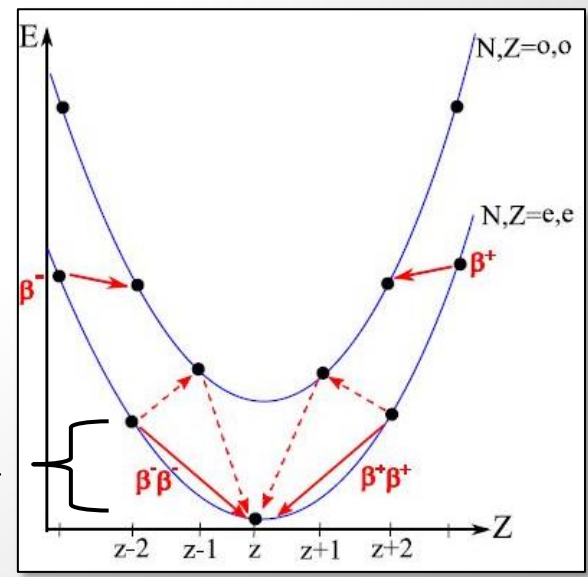

# Nuclear Matrix Elements

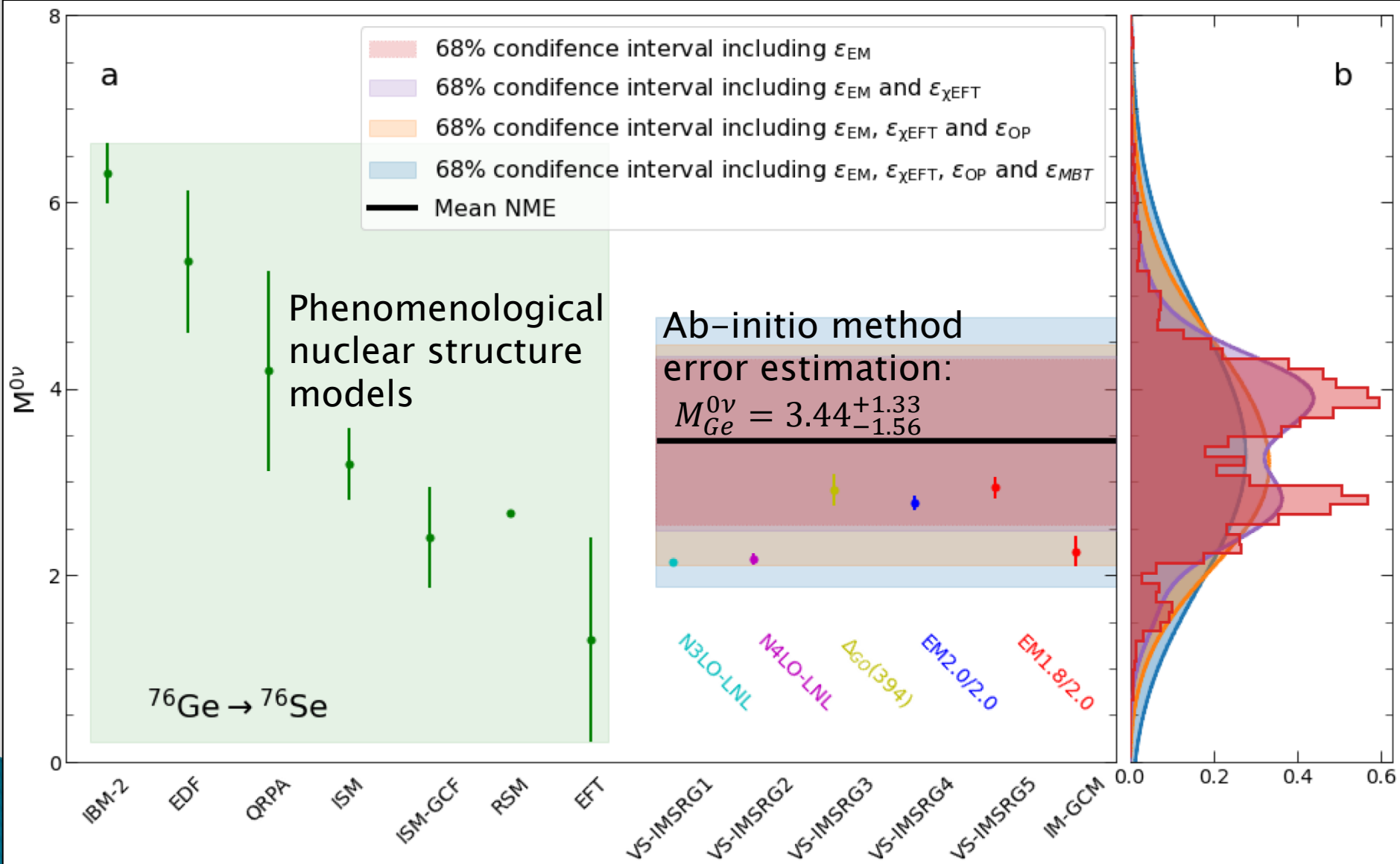

# Three Active Neutrinos

▶ Effective  $0\nu\beta\beta$  Mass

degenerate  $\nu$  &  $\theta_{13} \approx 0$

$$|m_{\beta\beta}| = |c_{12}^2 c_{13}^2 m_{\nu_1} + s_{12}^2 c_{13}^2 m_{\nu_2} e^{i\phi_{12}} + s_{13}^2 m_{\nu_3} e^{i\phi_{13}}| \approx m_{\nu} \sqrt{1 - \sin^2(2\theta_{12}) \sin^2(\phi_{12}/2)}$$

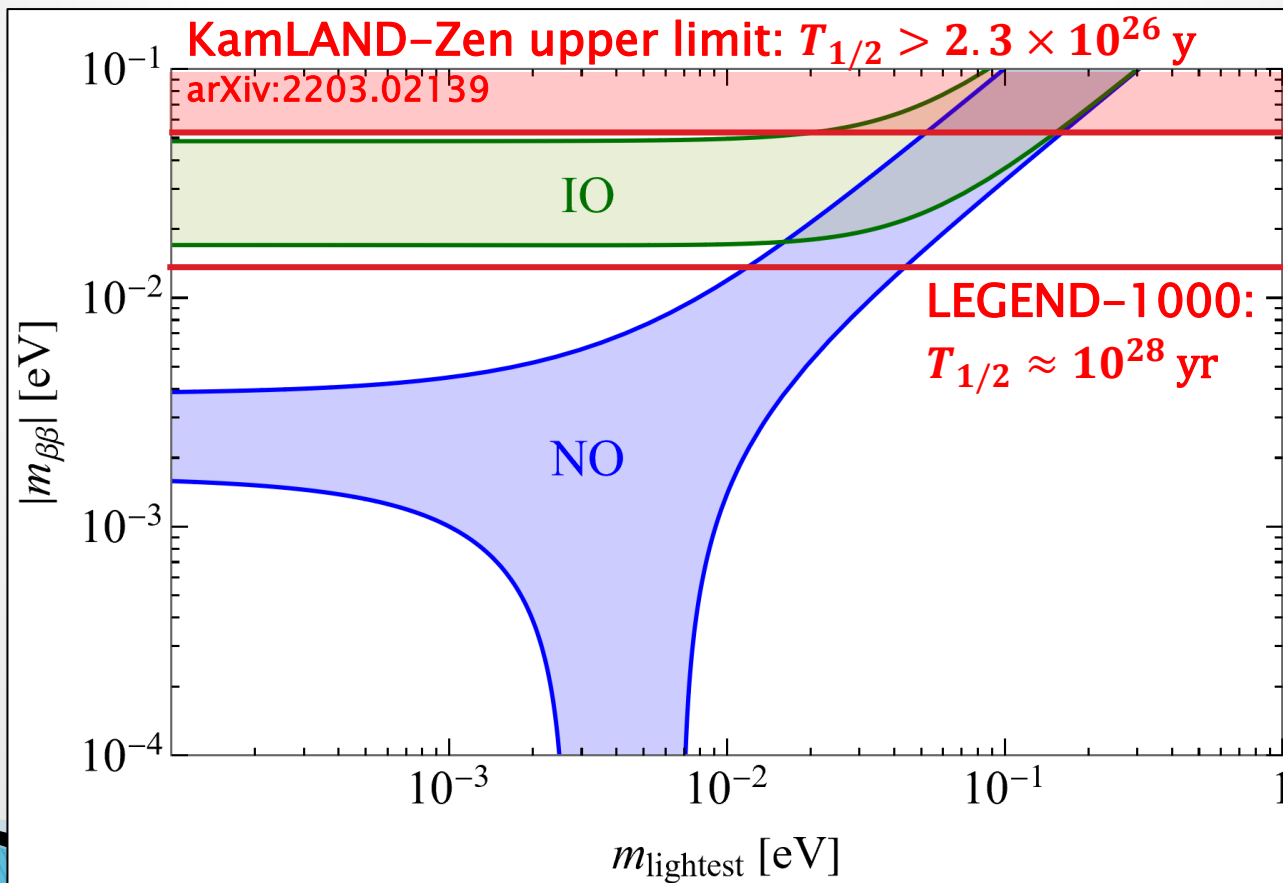

# Three Active Neutrinos

## ▶ Effective $0\nu\beta\beta$ Mass

degenerate  $\nu$  &  $\theta_{13} \approx 0$

$$|m_{\beta\beta}| = |c_{12}^2 c_{13}^2 m_{\nu_1} + s_{12}^2 c_{13}^2 m_{\nu_2} e^{i\phi_{12}} + s_{13}^2 m_{\nu_3} e^{i\phi_{13}}| \approx m_{\nu} \sqrt{1 - \sin^2(2\theta_{12}) \sin^2(\phi_{12}/2)}$$

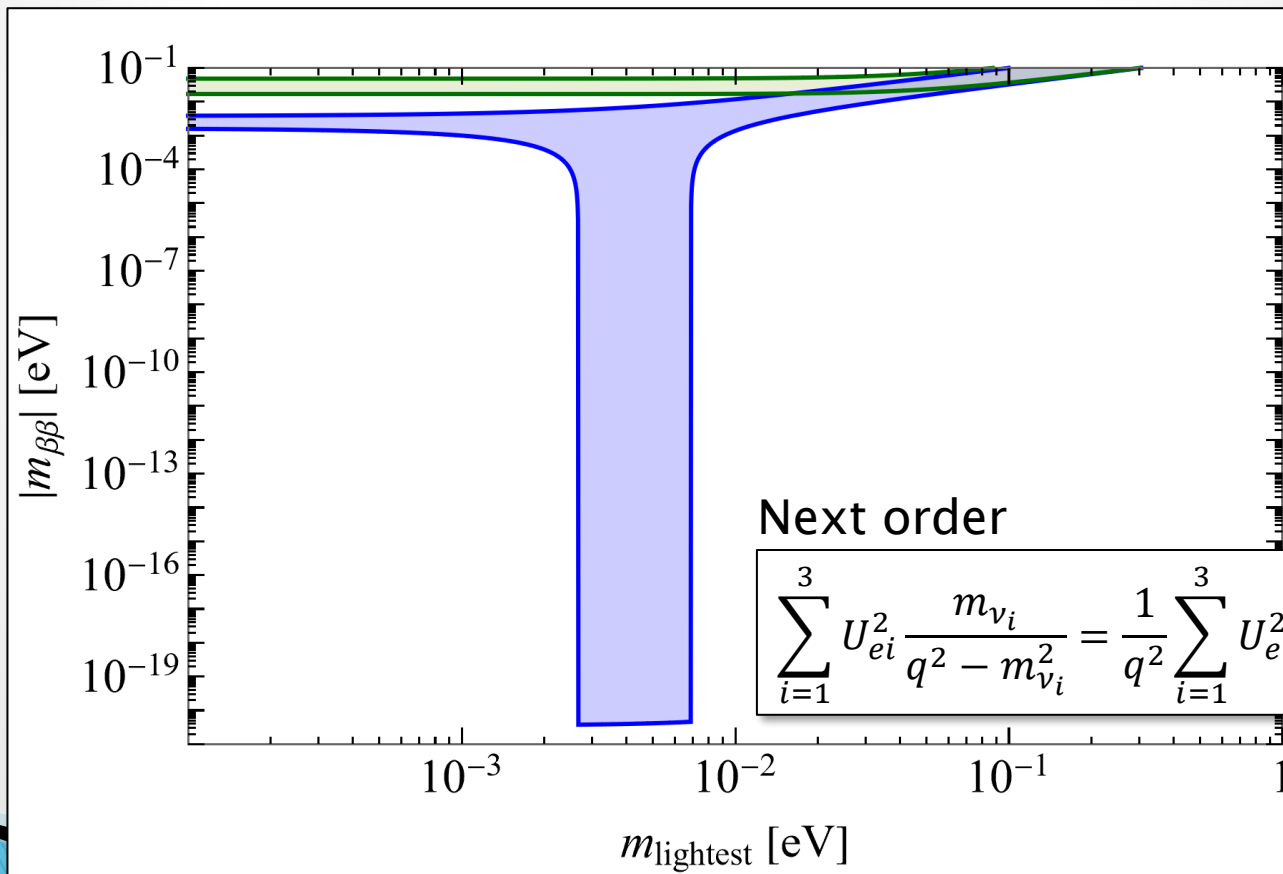

# New Physics and $0\nu\beta\beta$

► Plethora of New Physics scenarios

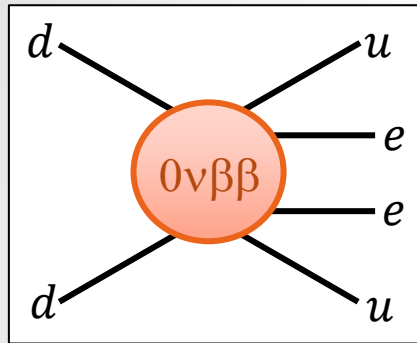

=

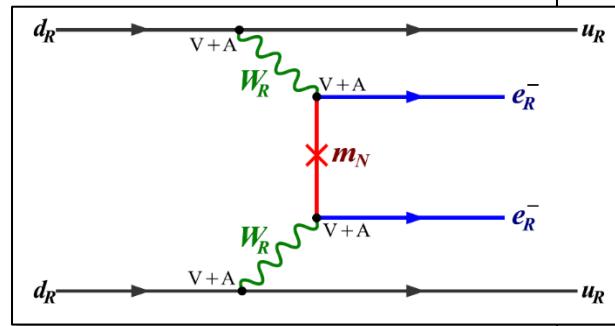

Left-Right Symmetry

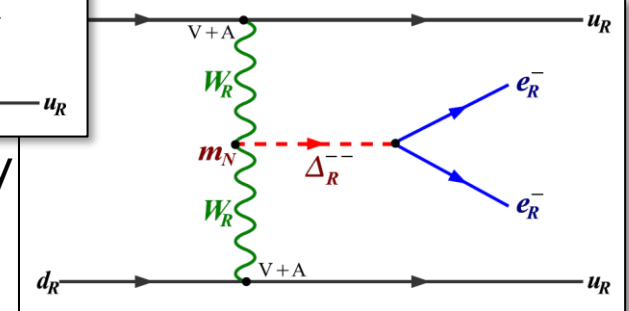
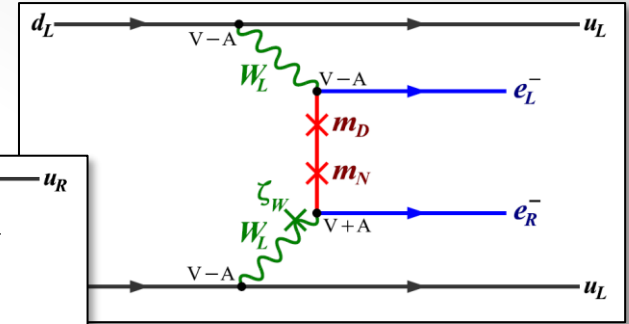

$$T_{1/2}^{-1} = \epsilon_{NP}^2 G_{NP}^{0\nu} |M_{NP}^{0\nu}|^2$$

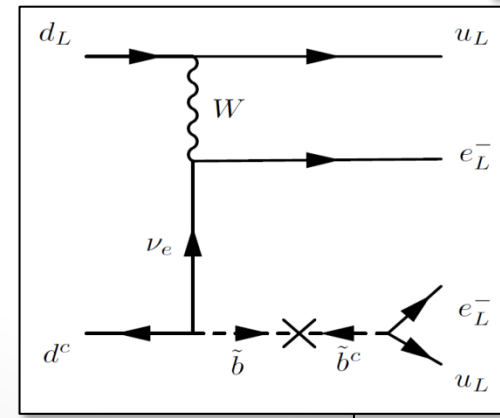

R-Parity Violating SUSY

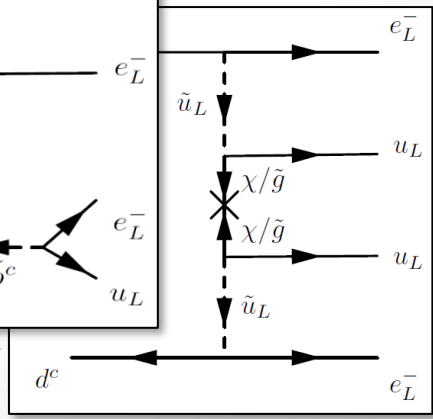

- Extra Dimensions
- Majorons
- Leptoquarks
- ...



# New Physics and $0\nu\beta\beta$

- ▶ Plethora of New Physics scenarios

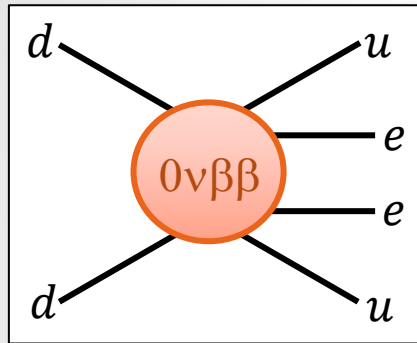

=

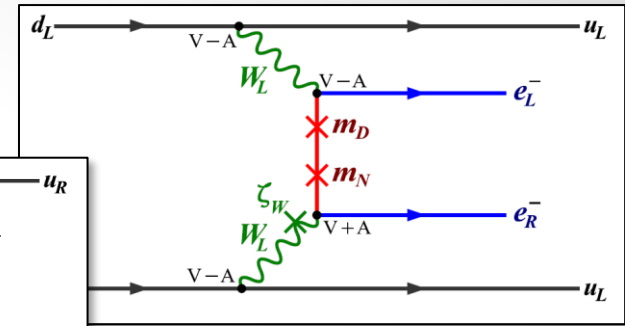
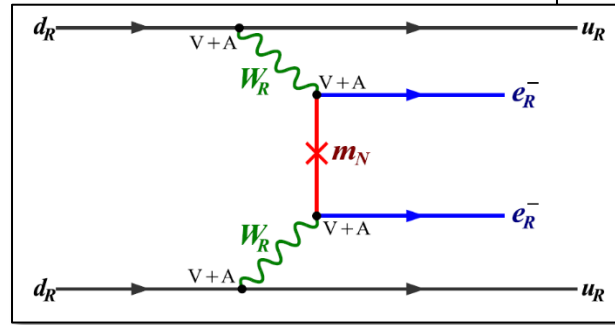

$$T_{1/2}^{-1} = \epsilon_{NP}^2 G_{NP}^{0\nu} |M_{NP}^{0\nu}|^2$$

$$\epsilon_3^{RRZ} = \sum_{i=1}^3 V_{ei}^2 \frac{m_p}{m_N} \frac{m_W^4}{m_{WR}^4} \approx \frac{10^{-8}}{(\Lambda/1 \text{ TeV})^5}$$

$$\epsilon_{V-A}^{V+A} = \sum_{i=1}^3 U_{ei} W_{ei} \tan \zeta_W \approx \frac{10^{-9}}{(\Lambda/10 \text{ TeV})^3}$$

- ▶  $0\nu\beta\beta$  probes the TeV scale
- ▶ Limits on 7D and 9D eff. operators

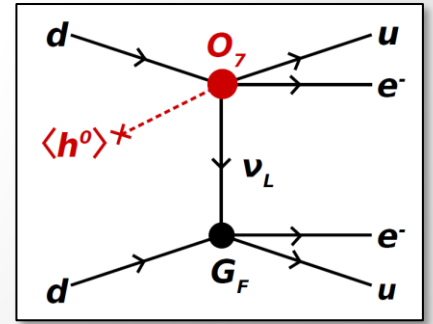
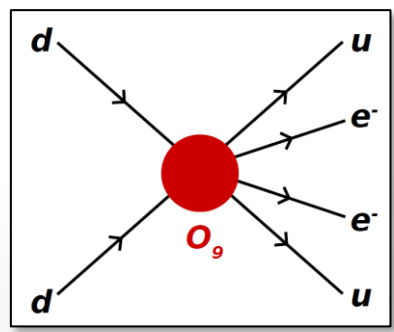

# Short-Range Mechanisms

FFD, Graf, Iachello, Kotila, Phys.Rev.D 102 (2020)

- ▶ Limits on short-range operators
  - NMEs from IBM-2 with  $g_A = 1.0$  and short-range correlations in Argonne parametrization

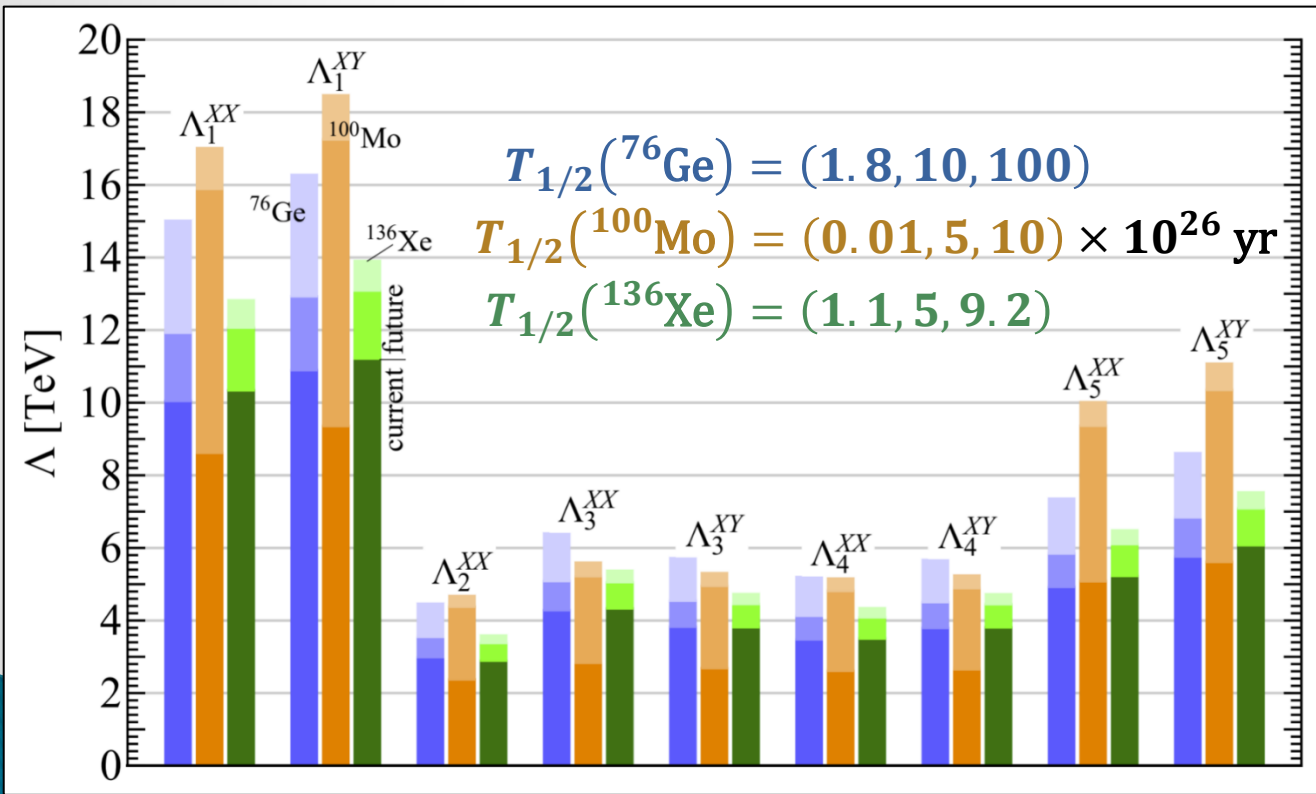
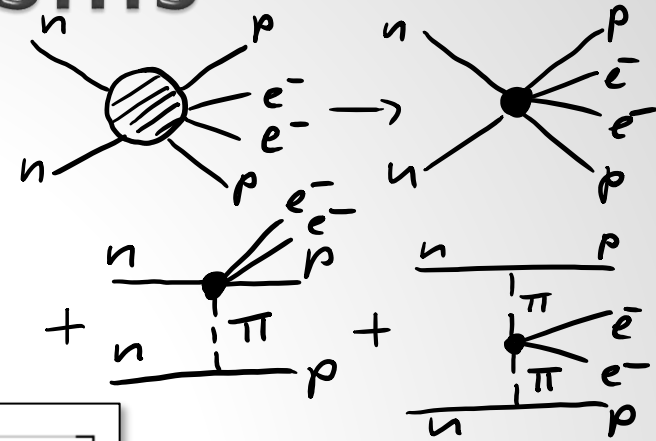

## Pion-mediated contributions

- ▶ R-parity violating SUSY (Faessler, Kovalenko, Simkovic, Schwieger, Phys.Rev.Lett. 78 (1997) 183)
- ▶ Chiral EFT with Pion operators from Lattice QCD (Cirigliano, Dekens, de Vries, Graesser, Mereghetti, JHEP 1812 (2018) 097)

# Majorons and RH Currents

Cepedello, FFD, González, Hati, Hirsch, Phys.Rev.Lett. 122 (2019) 18, 181801

- ▶ Effective RH lepton currents with massless scalar  $\phi$

$$\mathcal{L}_{0\nu\beta\beta\phi} = \frac{G_F \cos \theta_C}{\sqrt{2}} \left( j_L^\mu J_{L\mu} + \frac{\epsilon_{RL}^\phi}{m_p} j_R^\mu J_{L\mu} \phi + \frac{\epsilon_{RR}^\phi}{m_p} j_R^\mu J_{R\mu} \phi \right) + \text{h.c.}$$

- ▶ Giving rise to long-range contribution to  $0\nu\beta\beta\phi$  decay

$$\mathcal{M} = \epsilon_{RX}^\phi \frac{(G_F \cos \theta_C)^2}{\sqrt{2} m_p} \sum_N \int d^3x d^3y \int \frac{d^3q}{2\pi^2 \omega} \phi(\mathbf{y}) e^{i\mathbf{q}(\mathbf{x}-\mathbf{y})} \times \left\{ \left[ \frac{J_{LX}^{\rho\sigma}(\mathbf{x}, \mathbf{y}) u_{\rho\sigma}^L(E_1\mathbf{x}, E_2\mathbf{y})}{\omega + \mu_N - \frac{1}{2}(E_1 - E_2 - E_\phi)} - \frac{J_{XL}^{\rho\sigma}(\mathbf{x}, \mathbf{y}) u_{\rho\sigma}^R(E_1\mathbf{x}, E_2\mathbf{y})}{\omega + \mu_N - \frac{1}{2}(E_1 - E_2 + E_\phi)} \right] - [E_1 \leftrightarrow E_2] \right\}$$

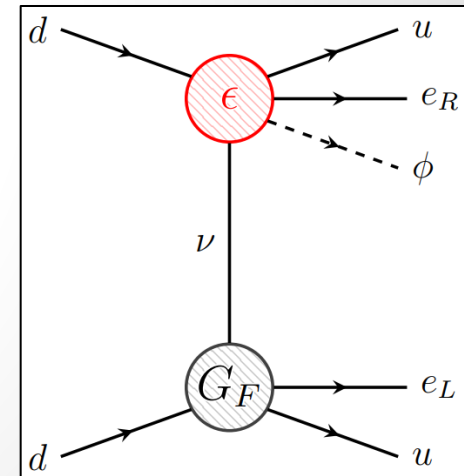

- No suppression with  $\nu$  mass

- ▶ Calculation follows long-range  $\eta$  and  $\lambda$   $0\nu\beta\beta$  modes

Doi, Kotani, Takasugi, Prog. Theor. Phys. Suppl. 83 (1985) 1

# Majorons and RH Currents

Cepedello, FFD, González, Hati, Hirsch, Phys.Rev.Lett. 122 (2019) 18, 181801

- ▶ Sensitivity (massless  $\phi$ , recasting single Majoron searches)

Isotope	$T_{1/2}$ [y]	$ \epsilon_{RL}^\phi $	$ \epsilon_{RR}^\phi $
$^{82}\text{Se}$	$3.7 \times 10^{22}$ [14]	$4.1 \times 10^{-4}$	$4.6 \times 10^{-2}$
$^{136}\text{Xe}$	$2.6 \times 10^{24}$ [13]	$1.1 \times 10^{-4}$	$1.1 \times 10^{-2}$
$^{82}\text{Se}$	$1.0 \times 10^{24}$	$8.0 \times 10^{-5}$	$8.8 \times 10^{-3}$
$^{136}\text{Xe}$	$1.0 \times 10^{25}$	$5.7 \times 10^{-5}$	$5.8 \times 10^{-3}$

- ▶ Searched for in EXO-200  
(Phys.Rev.D 104 (2021) 11, 112002)

$$T_{1/2}^{Xe} > 4 \times 10^{24} \text{ y}$$

# UV Model: LR Symmetry

Cepedello, FFD, González, Hati, Hirsch, Phys.Rev.Lett. 122 (2019) 18, 181801

## ▶ Extended Gauge Symmetry

$$G_{LR} = SU(3)_C \times SU(2)_L \times SU(2)_R \times U(1)_X \rightarrow SU(3)_C \times SU(2)_L \times U(1)_Y$$

- Minimal LR model:  $X = B - L$
- We consider  $X \neq B - L$  broken but  $B - L$  conserved
- Dirac neutrinos (and charged SM fermions) via Dirac seesaw via heavy, vector-like fermions (Bolton, FFD, Hati, Sarkar, Phys.Rev.D 100 (2019) 3, 035013)

Field	$SU(2)_L$	$SU(2)_R$	$B - L$	$\zeta$	$X$	$SU(3)_C$
$q_L$	2	1	1/3	0	1/3	3
$q_R$	1	2	1/3	0	1/3	3
$\ell_L$	2	1	-1	0	-1	1
$\ell_R$	1	2	-1	0	-1	1
$U_{L,R}$	1	1	1/3	+1	4/3	3
$D_{L,R}$	1	1	1/3	-1	-2/3	3
$E_{L,R}$	1	1	-1	-1	-2	1
$N_{L,R}$	1	1	-1	+1	0	1
$\chi_L$	2	1	0	+1	1	1
$\chi_R$	1	2	0	+1	1	1
$\phi$	1	1	2	-2	0	1

# UV Model: LR Symmetry

Cepedello, FFD, González, Hati, Hirsch, Phys.Rev.Lett. 122 (2019) 18, 181801

## UV Diagram

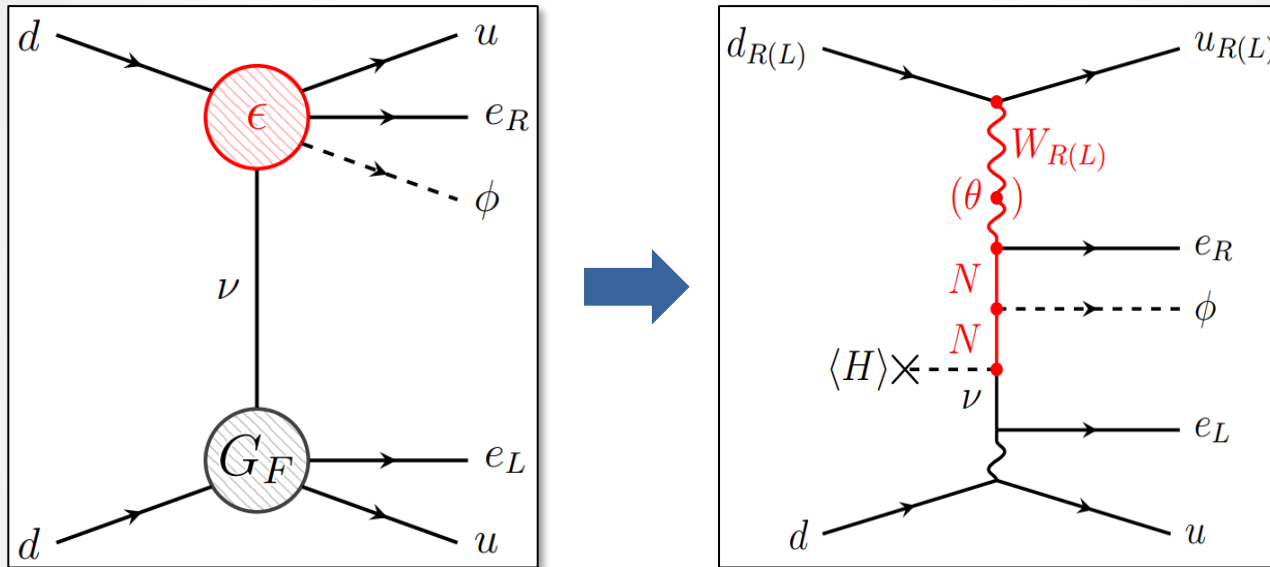

## Sensitivity from $\epsilon_{RL}^\phi$

$$\frac{T_{1/2}^{\text{Xe}}}{10^{25} \text{ y}} \approx \left( \frac{1.4 \times 10^{-4}}{g_R^2 \kappa y_N y_\nu} \right)^2 \left( \frac{m_{W_R}}{25 \text{ TeV}} \right)^4 \left( \frac{m_N}{100 \text{ MeV}} \right)^4$$

# New Physics in $2\nu\beta\beta$

Bolton, FFD, Graf, Simkovic, Phys.Rev.D 103 (2021) 055019

- ▶ Sterile neutrino search through energy endpoint (also Agostini, Bossio, Ibarra, Marcano, PLB 815 (2021))
  - Emission of one sterile neutrino in double beta decay:  $\nu N\beta\beta$
  - Same principle as endpoint searches in single  $\beta$  decays
  - Observed limit at GERDA (JCAP 12 (2022) 012)

$$|V_{eN}|^2 < 1.3 \times 10^{-2}$$

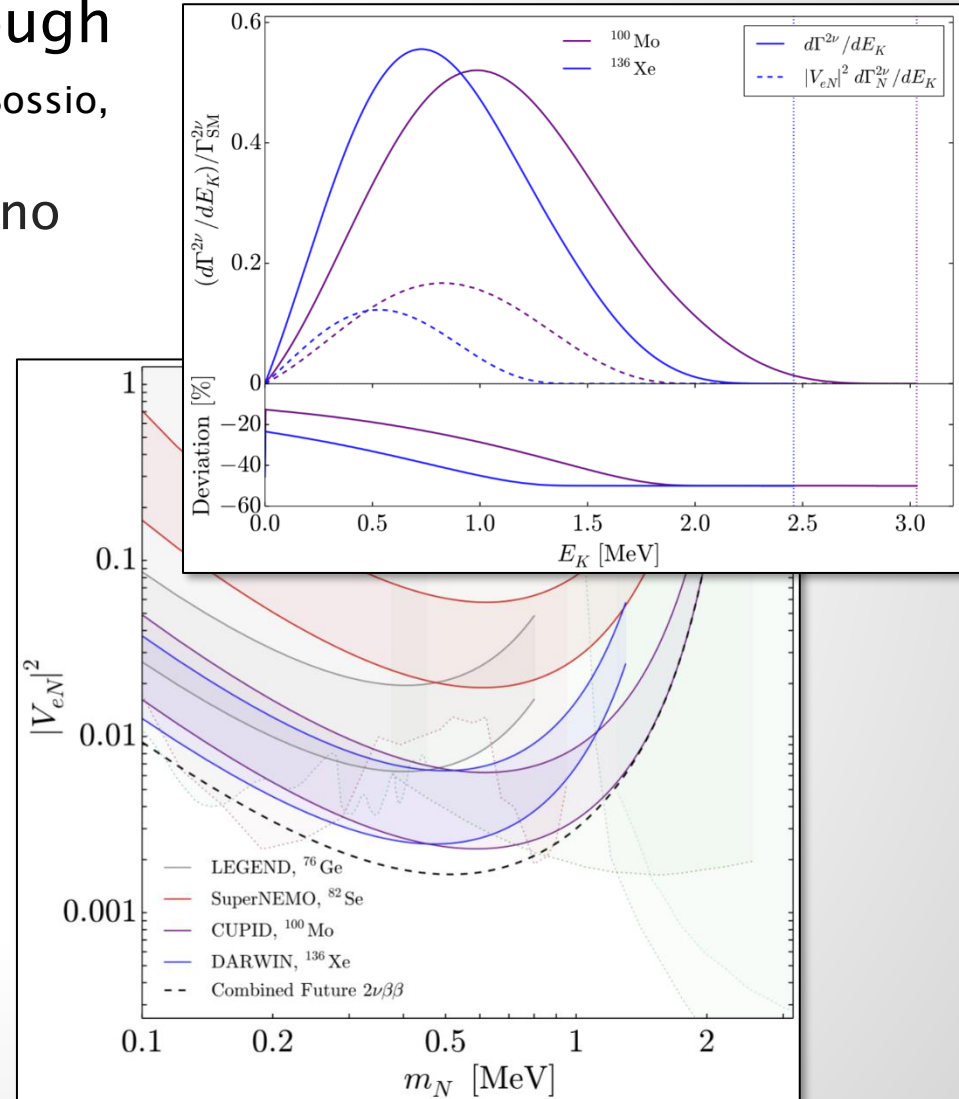

# New Physics in $2\nu\beta\beta$

FFD, Graf, Simkovic, Phys.Rev.Lett. 125 (2020) 17, 171801

- ▶ Lepton number conserving RH currents
  - Exotic charged currents probed e.g.
    - in neutron and single  $\beta$  decay
    - at LHC in  $pp \rightarrow eX + MET$
  - Limits on RH currents

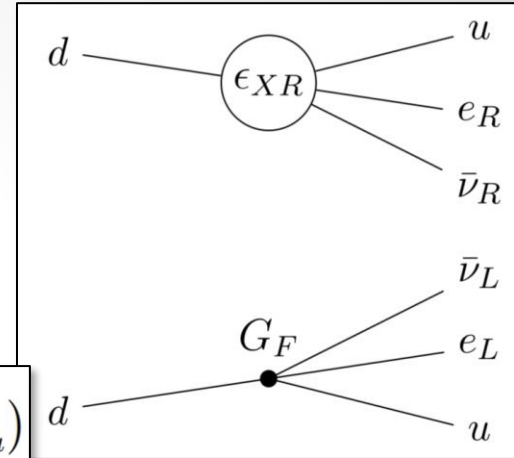

$$\frac{G_F \cos \theta_C}{\sqrt{2}} \left( (1 + \delta_{SM} + \epsilon_{LL}) j_L^\mu J_{L\mu} + \epsilon_{RL} j_L^\mu J_{R\mu} + \epsilon_{LR} j_R^\mu J_{L\mu} + \epsilon_{RR} j_R^\mu J_{R\mu} \right)$$

less severe due to lack of interference with SM

- ▶ Modification of angular and energy distribution in  $2\nu\beta\beta$  decay
  - Observation of two  $e^-$  instead of one in single  $\beta$  decay
  - Current limit  $\epsilon_{XR} < 3 \times 10^{-2}$  from NEMO3 competitive to other searches



# New Physics in $2\nu\beta\beta$

FFD, Graf, Simkovic, Phys.Rev.Lett. 125 (2020) 17, 171801

- ▶ Lepton number conserving RH currents
  - Main effect: Opposite angular distribution
  - Small modification of energy distribution

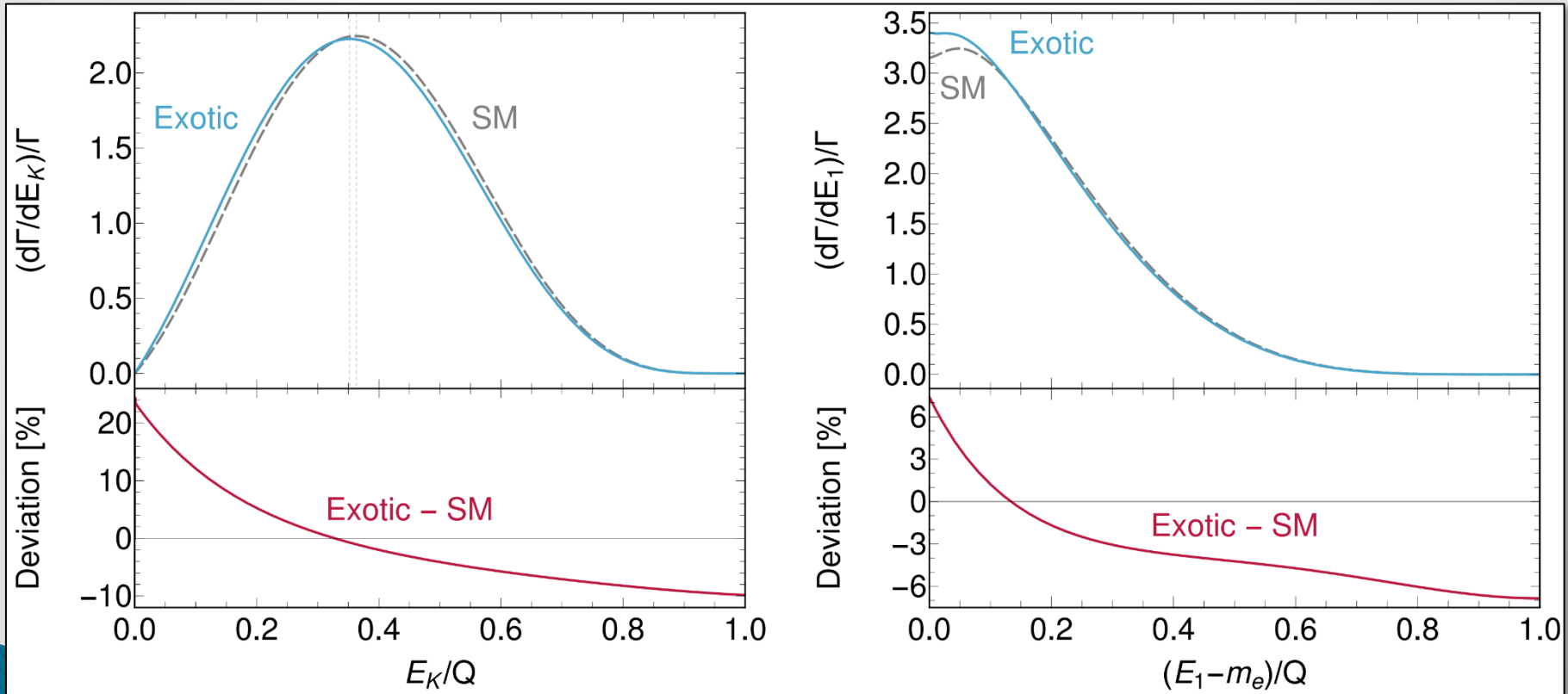

# New Physics in $2\nu\beta\beta$

FFD, Graf, Rodejohann, Xu, Phys.Rev.D 102 (2020) 5, 051701

## ▶ Neutrino self-interactions

- Same signature as SM  $2\nu\beta\beta$  decay

$$\Gamma_{2\nu} + \Gamma_{\nu\text{SI}} \approx \left( |\mathcal{M}_{2\nu}|^2 + \left| \frac{G_S m_e}{2R} \right|^2 \frac{|\mathcal{M}_{0\nu}|^2}{4\pi^2} \right) \mathcal{G}_{2\nu}$$

- Interference with SM  $2\nu\beta\beta$  decay neglected
- Non-observation of enhanced rate

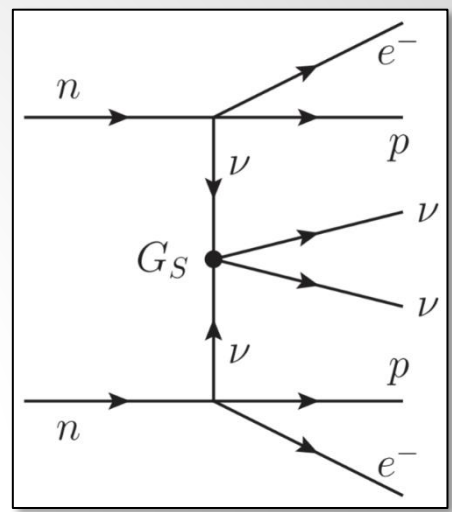

$$\Gamma_{\nu\text{SI}} / \Gamma_{2\nu}^{\text{ex}} < 1$$

excludes regime  $G_S \approx 4 \times 10^9 G_F$   
 suggested to resolve Hubble  
 tension (Kreisch, Cyr-Racine, Doré,  
 PRD 101 (2020) 12, 123505)

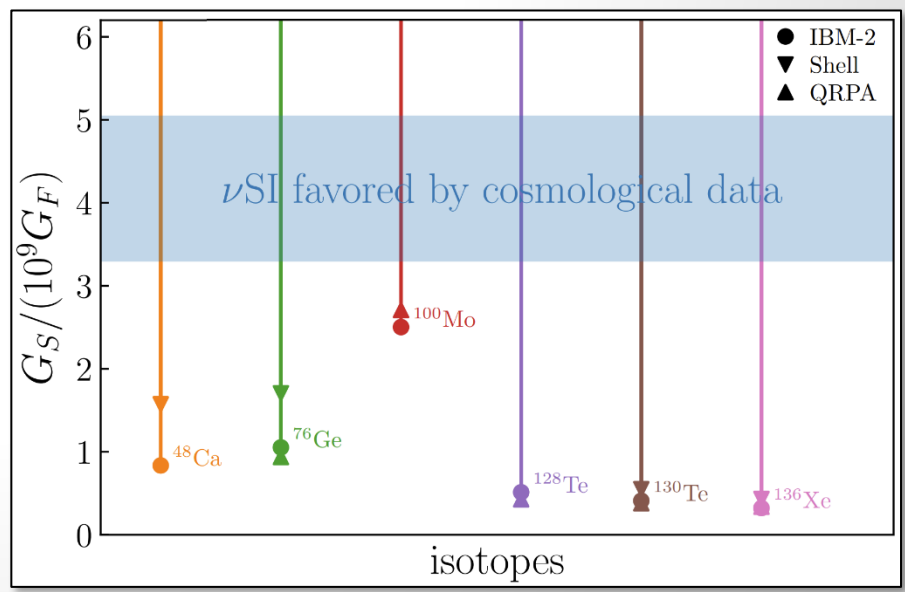

# New Physics in $2\nu\beta\beta$

FFD, Graf, Rodejohann, Xu, Phys.Rev.D 102 (2020) 5, 051701

## ▶ Neutrino self-interactions

- Same signature as SM  $2\nu\beta\beta$  decay

$$\Gamma_{2\nu} + \Gamma_{\nu\text{SI}} \approx \left( |\mathcal{M}_{2\nu}|^2 + \left| \frac{G_S m_e}{2R} \right|^2 \frac{|\mathcal{M}_{0\nu}|^2}{4\pi^2} \right) \mathcal{G}_{2\nu}$$

- Interference with SM  $2\nu\beta\beta$  decay neglected
- Modification of energy spectrum for light mediator(s), e.g., s-channel scalar  $m_\phi = Q + 0.1m_e$

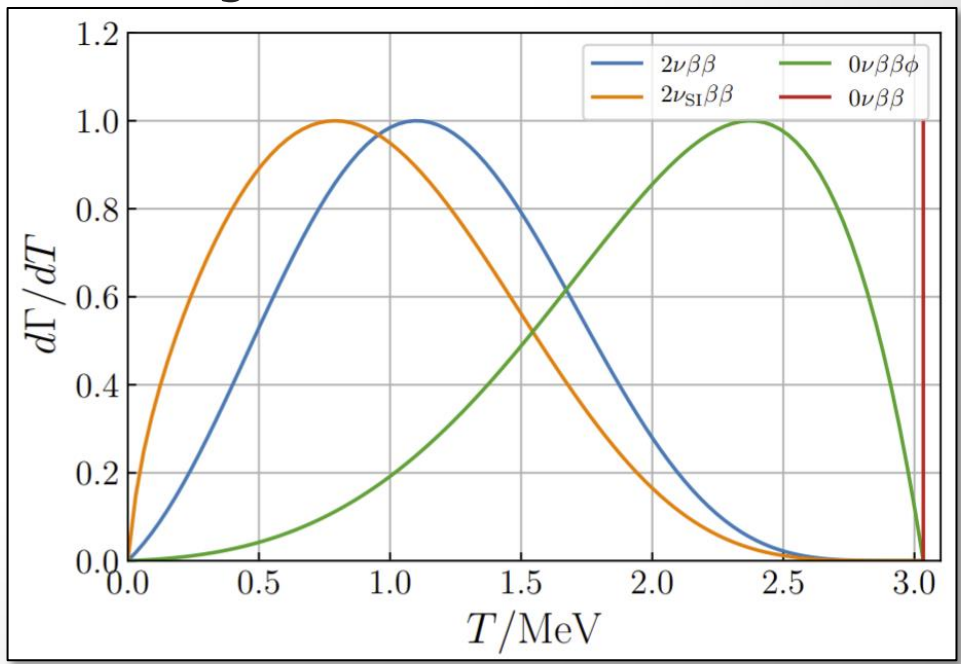
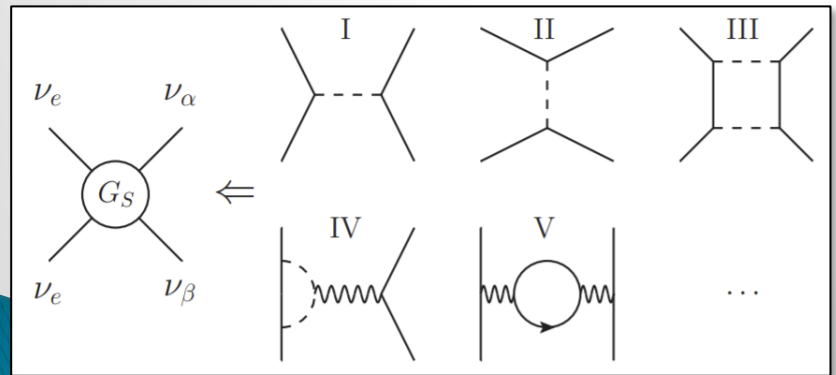
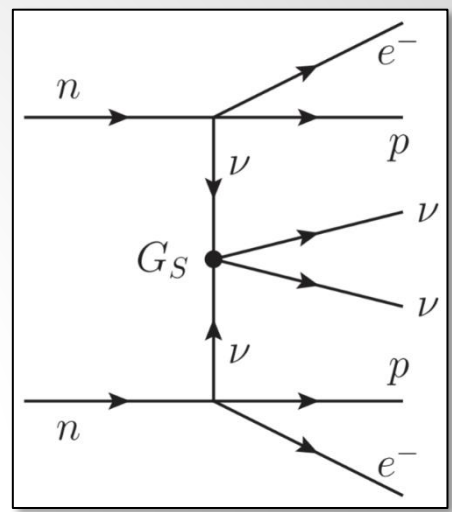

# Corrections to $0/2\nu\beta\beta$

Boudjema, Canning, FFD, Van Goffier, work in progress

## ▶ Radiative Corrections

- Photon-loop and soft photon emission
- Calculated for  $\beta$  decay (Repko, Wu, PRC 28 (1983) 2433)
- Application to  $0/2\nu\beta\beta$  decay

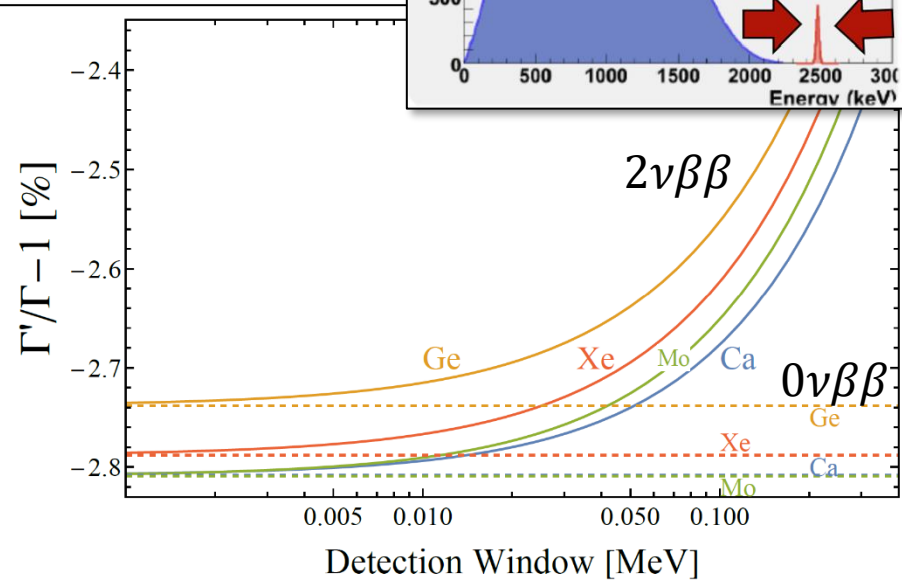
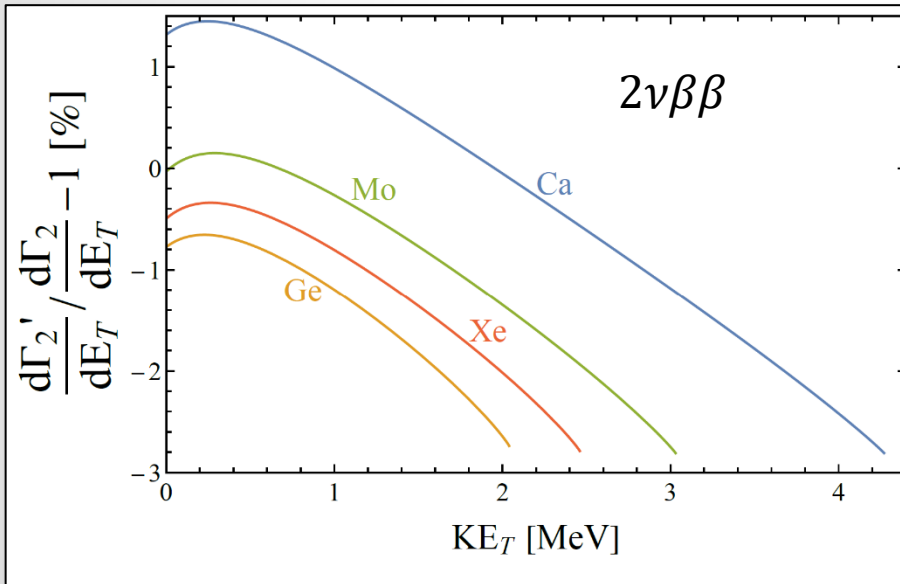
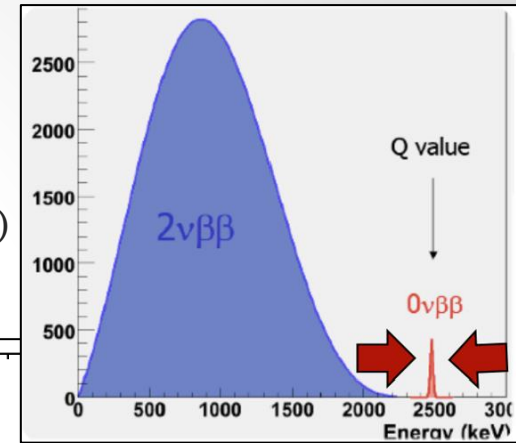

Boudjema, Canning, FFD, Van Goffier, preliminary

# Corrections to $0/2\nu\beta\beta$

Boudjema, Canning, FFD, Van Goffier, work in progress

- ▶ Radiative Corrections
  - Photon-loop and soft photon emission
  - Calculated for  $\beta$  decay (Repko, Wu, PRC 28 (1983) 2433)
  - Application to  $0/2\nu\beta\beta$  decay
- ▶ Electromagnetic interaction between emitted electrons
  - Relativistic  $e^-$  in Coulomb field of nucleus, atomic  $e^-$  **and sister  $e^-$**

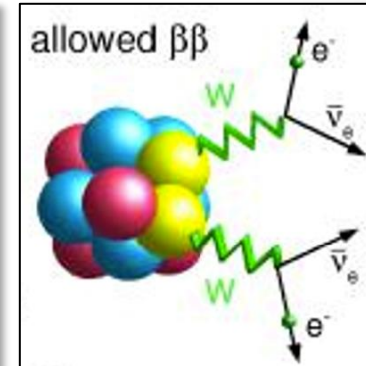
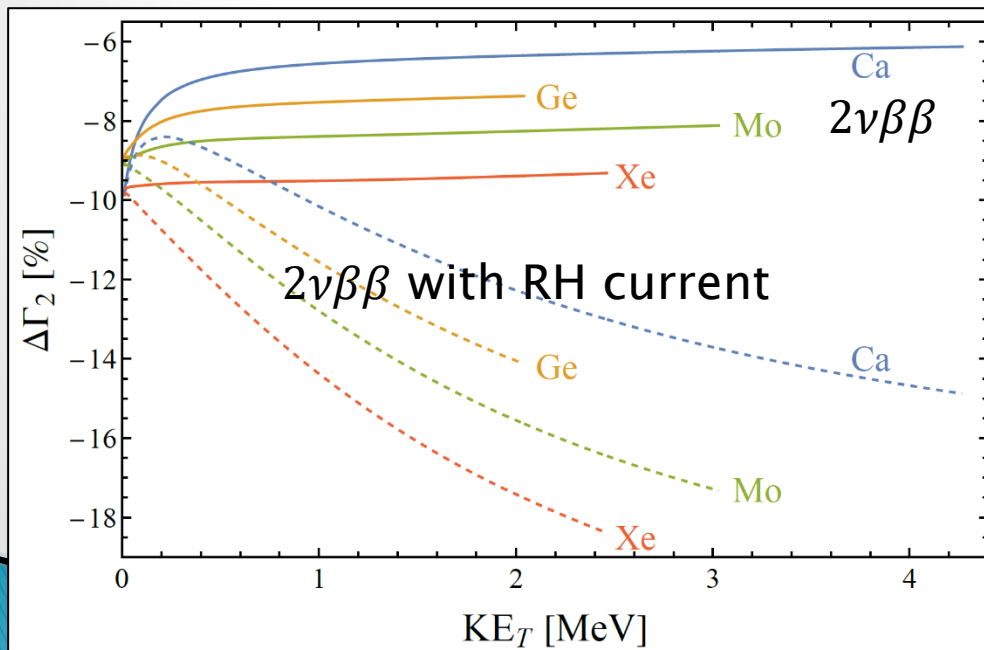

Boudjema, Canning, FFD, Van Goffier, preliminary

# Conclusion

▶  **$0\nu\beta\beta$  is crucial probe for BSM physics**

- Universal probe of LNV
- Proof that light  $\nu$  are Majorana
- $m_{\beta\beta} = O(10 \text{ meV}) \leftrightarrow$  LNV near GUT scale through dim-5 Weinberg operator
- LNV at scales  $\Lambda \approx 1 \text{ eV} - 100 \text{ TeV}$

▶  **$2\nu\beta\beta$  is sensitive to New Physics**

- Ongoing and future searches probe  $2\nu\beta\beta$  decay with high statistics
- Examples considered
  - Majoron emission with RH current
  - Exotic RH currents
  - Sterile neutrino endpoint search
  - Neutrino self-interactions

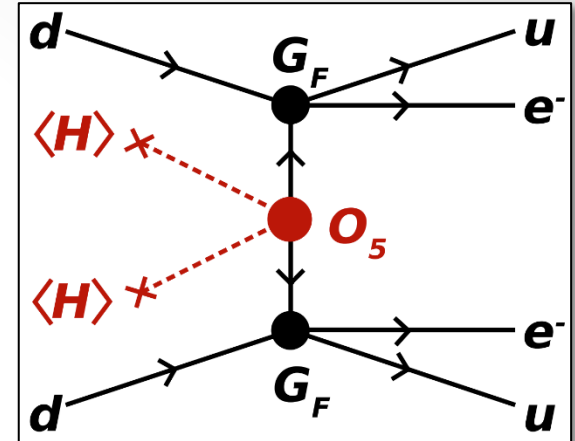

$$\frac{T_{1/2}^{0\nu\beta\beta}}{10^{28} \text{ y}} \approx \left( \frac{\Lambda_{\text{NP}}}{10^{15} \text{ GeV}} \right)^2$$