



# Single-particle structure and shell evolution from an experimental point of view

Sean J Freeman EP Department, CERN and Department of Physics and Astronomy, the University of Manchester

UK Nuclear Physics Summer School 2024

# Plan of Action

Keep it simple and give a flavour of WHY/WHAT/HOW, illustrated with some examples.

- *Back to basics: what is a nucleus and what is single-particle structure?*  
nucleus as a quantum system, single-particle structure, exotic nuclei and shell evolution – not comprehensive, just a flavour!
- *How would you probe single-particle structure?*  
direct nuclear reactions; nucleon transfer as an example.
- *How do you do experiments and what do you measure?*  
kinematics, detection methodologies – illustrated by some examples (not meant to be a review or survey!)

⚠ Taking an experimental, intuitive, pedagogical, heuristic approach – with lots of “cartoon” explanations- you have theorists coming who can correct me!

⚠ Concentrating on transfer – knockout reactions equally important, more so in the most extreme nuclei.

PHYSICS  
EXPERIMENTS



# PART 1: Nuclei, single-particle structure and shell evolution

# What is a nucleus?

- Protons (charged) and neutrons; *nucleons*.
- Electrostatic repulsion vs strong attraction.
- Nucleon incompressibility,  $r=1.2A^{1/3}$  fm.
- Looks static, dull and uninteresting.

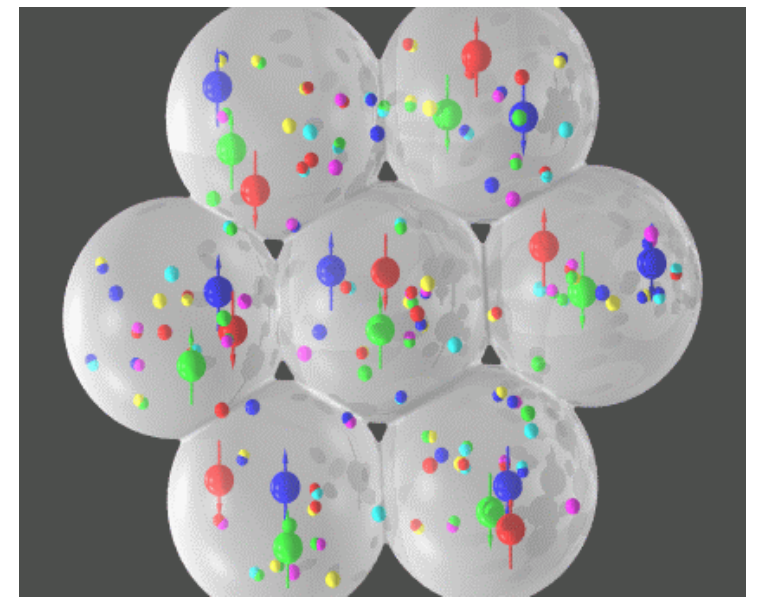
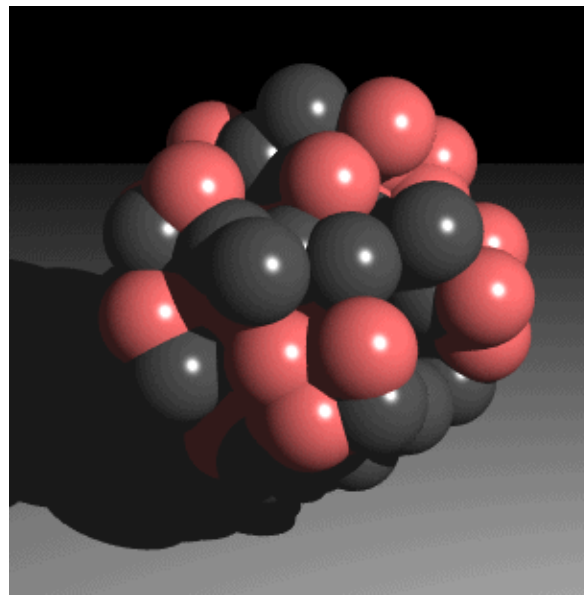

- Quantum mechanics makes it much more dynamic.
- N-N binding force arising from fundamental strong interactions.
- In-medium effects make things even more complex with three-body forces and higher order contributions.

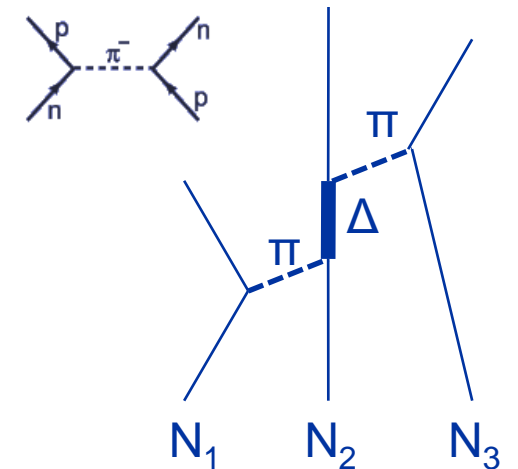
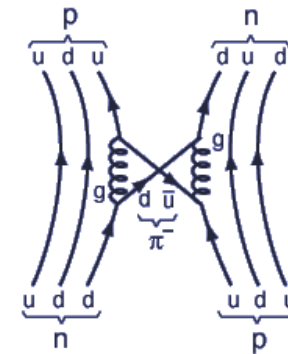
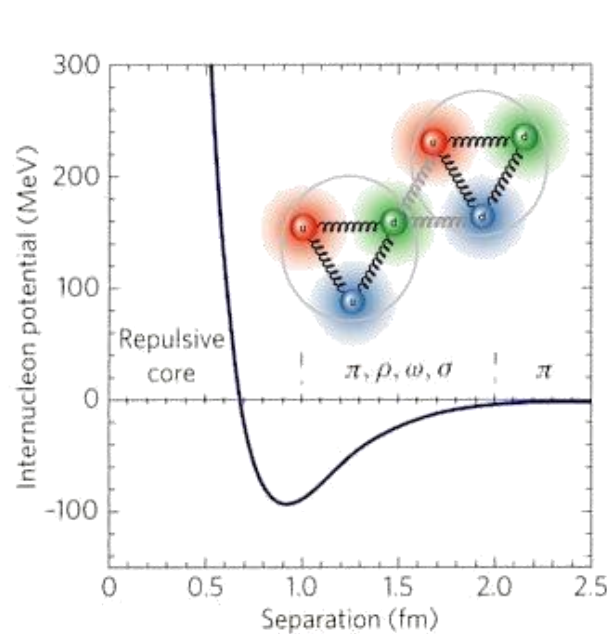



# Forces between two nucleons

Characteristic	Some examples of evidence...
short-ranged <2 fm	deviation from Coulomb scattering for distance of closest approach <2 fm – Rutherford spotted this hundred years ago!
strong and attractive between $\approx 0.5$ to 2 fm	nucleons bind into nuclei – also from N-N scattering.
very repulsive <0.5 fm	nuclei don't collapse and nucleons keep their integrity in the nucleus – also from N-N scattering.
charge independent	similarity of structure of mirror nuclei imply n-n and p-p forces similar, and isobaric multiplets imply n-p are similar again – they are all NUCLEONS! – also from N-N scattering.
dependent on spin orientations	gs of deuteron is approx $s_{1/2}^2$ but associated $1^+$ and $0^+$ states are not degenerate.
dependent relative momentum via spin-orbit effects	spin-orbit coupling in nuclei - also from polarised N-N scattering – LS force!
non-central component	magnetic and quadrupole moment of deuteron only reproduced if gs is a mixture of L=0 and L=2 – so-called TENSOR force!
exchange character	forward-backward symmetry in n-p scattering differential cross sections

Not strictly N-N only, but in nuclei, saturation property – nucleons only interact strongly with their nearest neighbours since BE per nucleon roughly constant 7-8 MeV/u – connected to short-range nature.

Many and varied forms of the NN force available – those that are empirical or phenomenological, those that are inspired by theory such as effective field theory...usually tweaked to fit NN scattering data.

Later will talk about central part, two-body LS part and tensor parts.

Radial dependence reminiscent of Lennard Jones potentials!

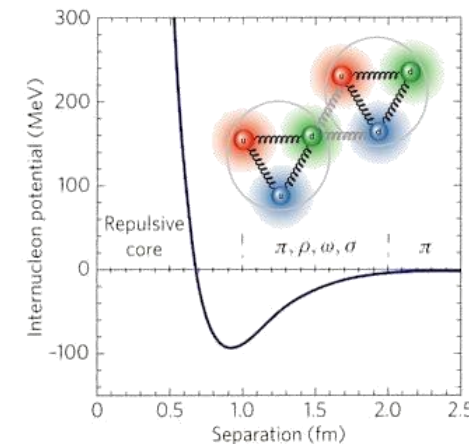

# Challenges in nuclear structure

- Describe a many-body system using quantum mechanics where particles interact via a complicated force.
- In principle, could operate like solving hydrogen atom.  
*Ab-initio Models*: write down the Schrödinger equation for each nucleon including interactions with all other nucleons using nucleon-nucleon interaction.
- Calculations beyond  $A=12$  become difficult; with a good form of the N-N force:
  - ${}^4\text{He}$  takes  $\sim 1$  cpu-hour
  - ${}^8\text{Be}$  takes  $\sim 300$  cpu-hour
  - ${}^{12}\text{C}$  takes  $\sim 70,000$  cpu-hour (8 years!)
- In principle, could operate like solid-state physics and use statistical mechanics, but up to  $\sim 300$  particles rather than several  $10^{23}$ !
- Some analogy with a liquid droplet, can approach macroscopically.

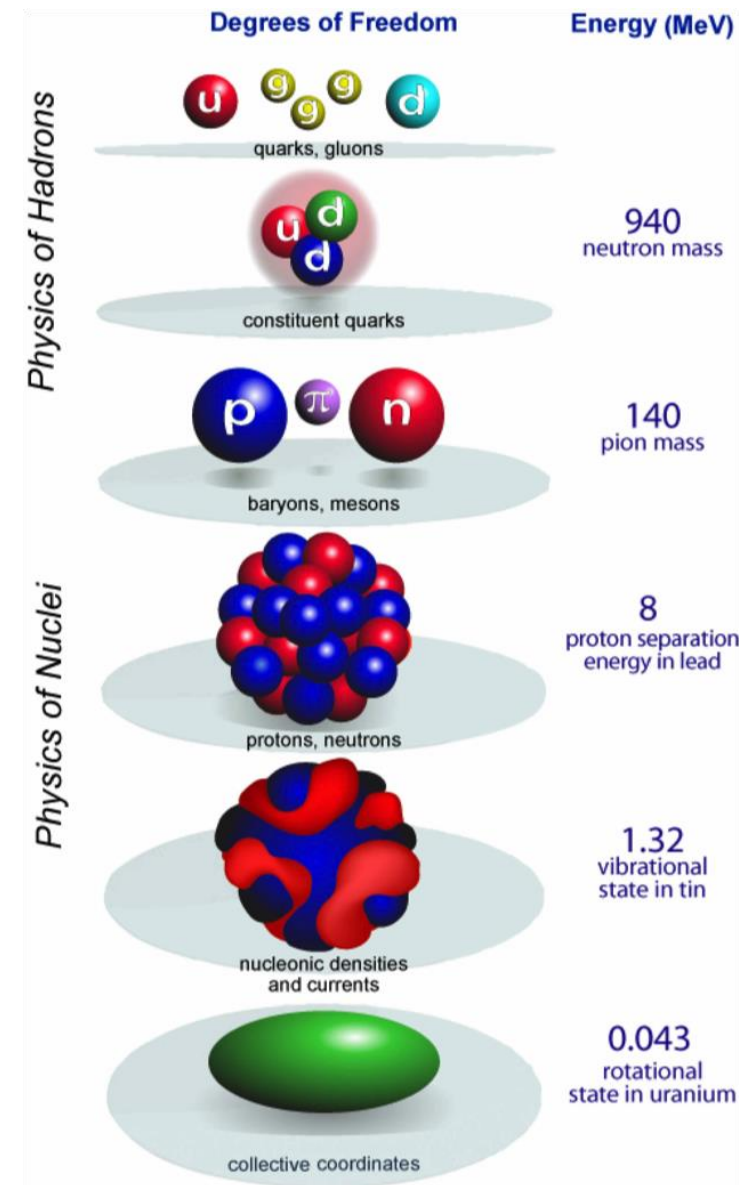

Ekström A, Forssén C, Hagen G, Jansen GR, Jiang W and Papenbrock T (2023), *What is ab initio in nuclear theory?* Front. Phys. 11:1129094.

# Mean-field approaches to single-particle structure

- *Mean-field potential*: assume that all the interactions with all the other nucleons averages out to some potential that only depends on the coordinates of the nucleon in question. Schrödinger equation separates into single nucleon equations.
- *Hartree-Fock* is one theoretical tool – but you can guess the general form!
- The *nuclear shell-model* uses a simple approach with a harmonic oscillator potential with a *spin-orbit interaction* – could use anything that is a complete basis set!
- *Spin-orbit interaction* is a famous addition from 75 years ago that “fixes” the magic numbers.
- *Run the now “easy” quantum mechanics and get levels in the well...*

$$\hat{H}\Psi \approx \left[ -\frac{\hbar^2}{2m} \sum_i^A \nabla_i^2 + U(r_i) \right] \Psi = \sum_i^A h_i \Psi = E\Psi$$

$$\Psi = \psi_1 \cdot \psi_2 \cdot \psi_3 \dots \psi_A \quad E = \sum_i^A E_i$$

$$\left[ -\frac{\hbar^2}{2m} \nabla_i^2 + U(r_i) \right] \psi_i = E_i \psi_i$$

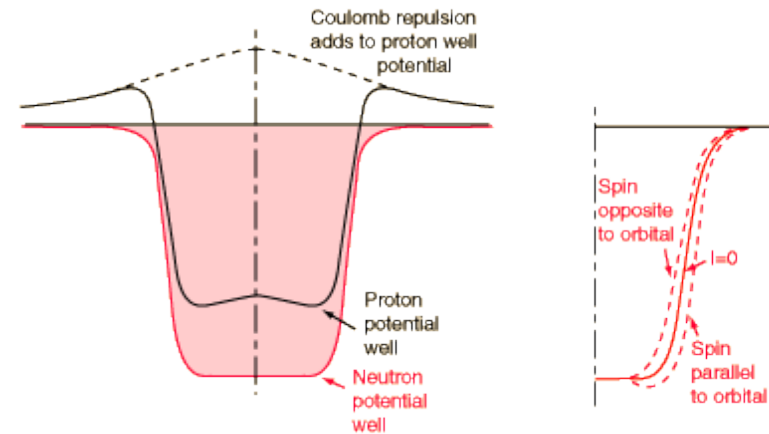

Example of potentials for a neutron bound to a  $^{112}\text{Sn}$  nucleus

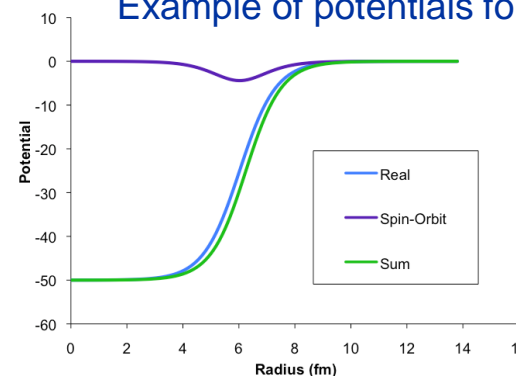

$$V_{so} = -V_0 \frac{1}{r} \frac{\partial U(r)}{\partial r} \ell \cdot s$$



# Independent-particle model:

Single-nucleon wavefunctions characterised by:  
 $n$ ,  $l$ , and  $j$  quantum numbers.

Nuclear wavefunction constructed using products of single-nucleon wavefunctions coupled to give the right spin and appropriately anti-symmetrised.

$$\Psi = \psi_1 \cdot \psi_2 \cdot \psi_3 \dots \psi_A \quad \text{is too simple!}$$

Actually – IPM extremely limited success in describing experimental data.

*Essentially just spin-parities of a few nuclei around closed shells along the line of stability* – mean field isn't such a good approximation.

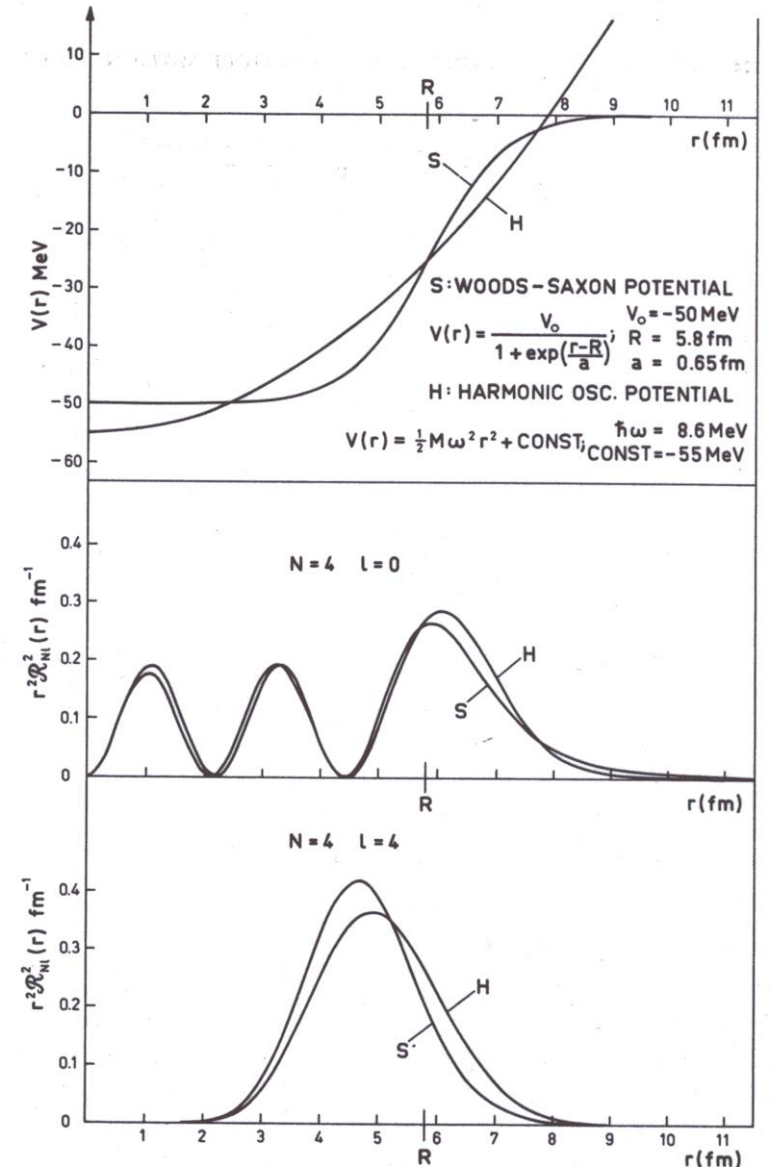

Figure 2-22 The square of the wave function times  $r^2$  for the harmonic oscillator and the Woods-Saxon potential are plotted in units of  $\text{fm}^{-1}$ .





AIP Emilio Segrè Visual Archives, Born Collection

Bavaria-Verlag

1959

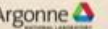

### On Closed Shells in Nuclei. II

MARIA GOEPPERT MAYER

Argonne National Laboratory and Department of Physics,  
University of Chicago, Chicago, Illinois

February 4, 1949

THE spins and magnetic moments of the even-odd nuclei have been used by Feenberg<sup>1,2</sup> and Nordheim<sup>3</sup> to determine the angular momentum of the eigenfunction of the odd particle. The tabulations given by them indicate that spin orbit coupling favors the state of higher total angular momentum. If strong spin-orbit coupling, increasing with angular momentum, is assumed, a level assignment different from either Feenberg or Nordheim is obtained. This assignment encounters a very few contradictions with experimental facts and requires no major crossing of the levels from those of a square well potential. The magic numbers 50, 82, and 126 occur at the place of the spin-orbit splitting of levels of high angular momentum.

### On the "Magic Numbers" in Nuclear Structure

OTTO HAXEL

Max Planck Institut, Göttingen

J. HANS D. JENSEN

Institut f. theor. Physik, Heidelberg

AND

HANS E. SUSS

Inst. f. phys. Chemie, Hamburg

April 18, 1949

A SIMPLE explanation of the "magic numbers" 14, 28, 50, 82, 126 follows at once from the oscillator model of the nucleus,<sup>1</sup> if one assumes that the spin-orbit coupling in the Yukawa field theory of nuclear forces leads to a strong splitting of a term with angular momentum  $l$  into two distinct terms  $j = l \pm \frac{1}{2}$ .

## The Nobel Prize in Physics 1963



Photo from the Nobel Foundation archive.

Eugene Paul Wigner

Prize share: 1/2

Photo from the Nobel Foundation archive.

Maria Goeppert Mayer

Prize share: 1/4

Photo from the Nobel Foundation archive.

J. Hans D. Jensen

Prize share: 1/4



So, all done and dusted?

# Expectations...

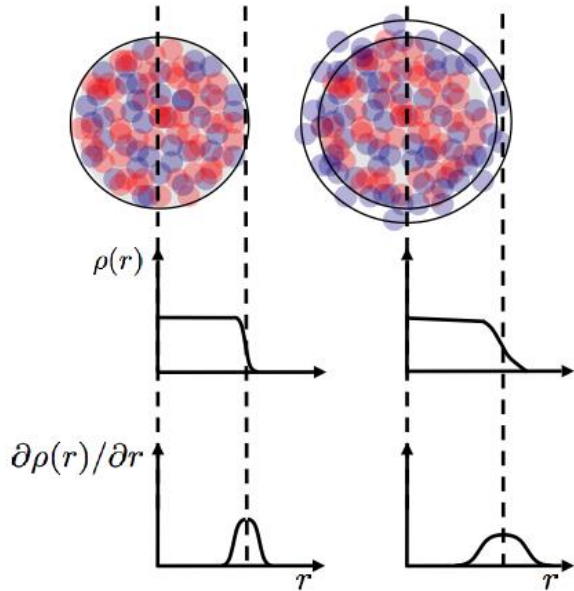

When adding nucleons can expect the system to become less well bound; final nucleons can wander more: surface becomes more diffuse.

$$V_{so} = -V_0 \frac{1}{r} \frac{\partial U(r)}{\partial r} \ell \cdot s$$

Changes in diffuseness of mean-field potential near neutron drip line may influence spin-orbit interaction.

Nuclei with neutron haloes have been observed!

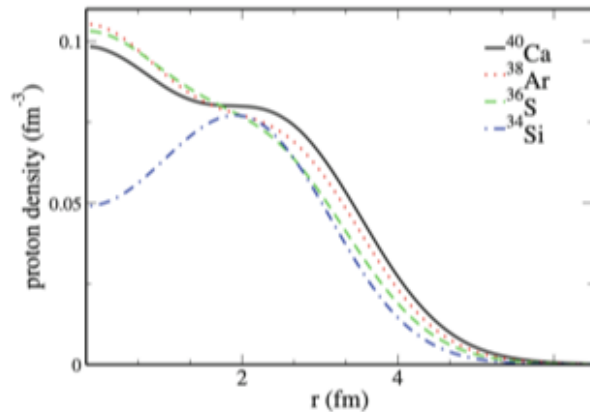

Depletion of  $s_{1/2}$  orbits could generate a bubble nucleus – negative slope affects the spin-orbit splitting...

Contentious!

## Nuclear Shell Structure

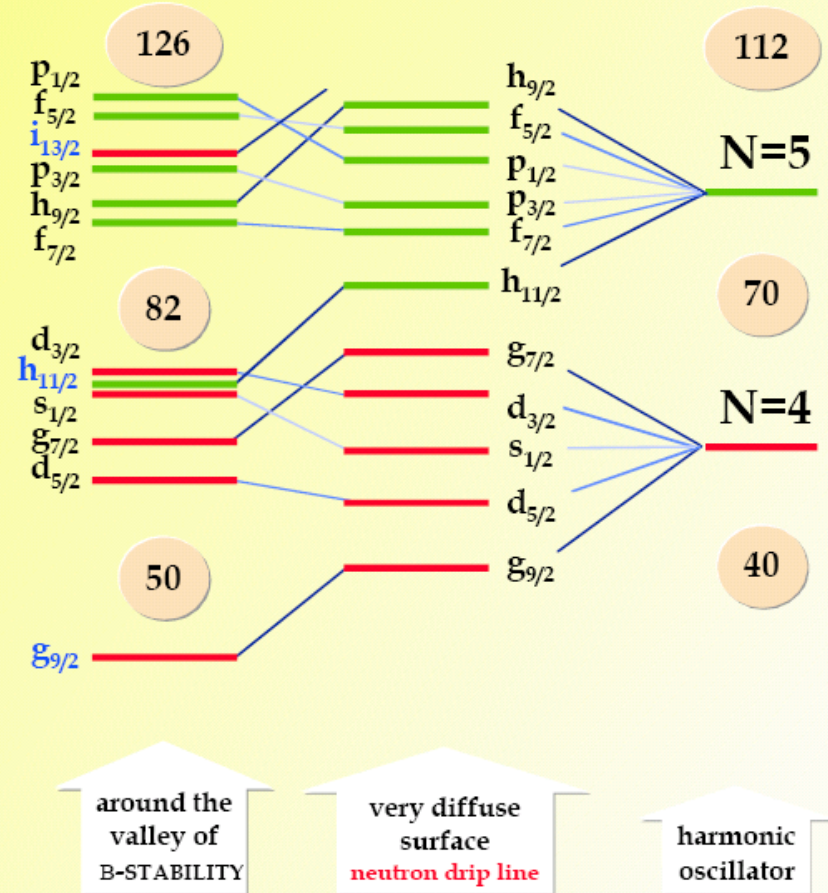

J.Dobaczewski *et al.* Prog.Part.Nucl.Phys. 59 432 (2007)



# Independent particles in strongly interacting matter...?!?!?!?

Two independent particles – probability of location of one independent of the other – so fair chance they might come close to one another. *Nuclear force is very strong and repulsive at short distances so they would interact strongly so how can they be independent?*



Two particle state: prob that they are at particular positions

$$P = |\Phi|^2 d\mathbf{r}_1 d\mathbf{r}_2$$

distinguishable particles

$$\Phi = \phi_m(1)\phi_n(2)$$

indistinguishable fermions

$$\Phi = \frac{1}{2} [\phi_m(1)\phi_n(2) - \phi_m(2)\phi_n(1)]$$

$$P_{\text{fermions}} = P_{\text{dist}} [1 - F_1(k_F r)]$$

*Exclusion-principle correlations* keep two identical nucleons apart – suppressing effects of short-range repulsion and perhaps allowing extension of IPM to describe real nuclei?

Mention another effect of Pauli later related to energetics that helps!

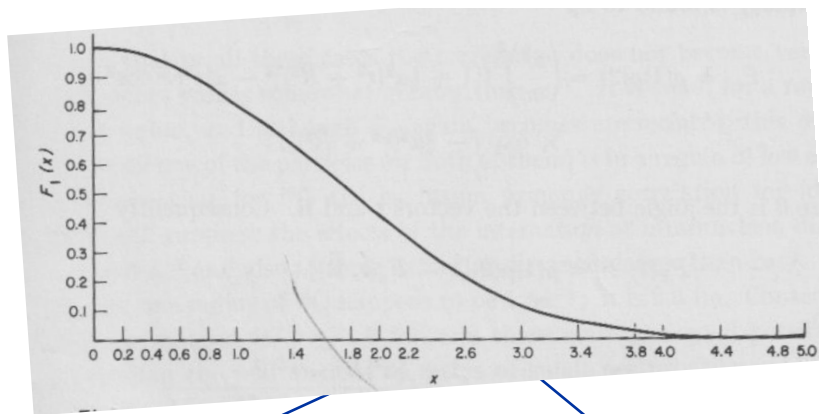

1.5 fm

2.2 fm

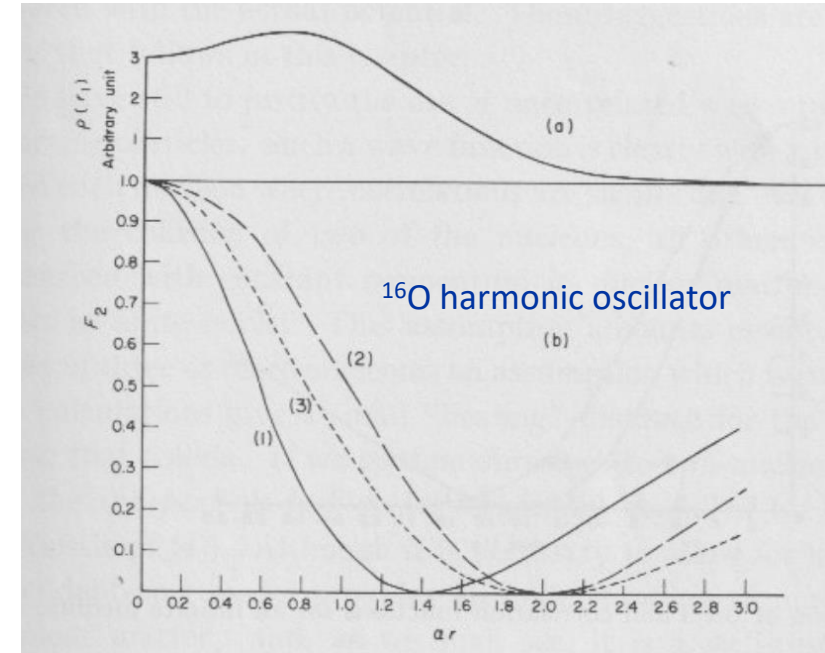

# Beware the residual interaction:

The nucleus is made up of  $A$  nucleons:

$$\hat{H}\Psi = \left[ -\frac{\hbar^2}{2m} \sum_i^A \nabla_i^2 + \sum_{ij} V_{ij} \right] \Psi = E\Psi$$

Depends only on coordinates of one nucleon,  $i$   
*one-body operator*

Limit to two-body interaction – ignoring 3-body forces already!

Invent an AVERAGE or MEAN-FIELD POTENTIAL:

$$\hat{H}\Psi = \left[ \sum_i^A \left( -\frac{\hbar^2}{2m} \nabla_i^2 + U(r_i) \right) + \left( \sum_{ij} V_{ij} - \sum_i^A U(r_i) \right) \right] \Psi = E\Psi$$

KE plus mean-field potential are *one-body operators*  
generates *IPM configurations as a basis set*

*the residual interaction*, contains the two-body terms that mixes the eigenfunctions of the basis set.

Depends on the motion of nucleons  $i$  and  $j$ , i.e. the associated single-particle quantum numbers, and builds “*correlations*” between nucleons.

Mixing of basis sets implies probability of finding nucleus in different single-particle configurations.

Can picture as a scattering from below Fermi surface to above (later!).

You cannot ignore the residual interaction – nuclear shell model uses phenomenological residual interactions and matrix diagonalization to solve the problem – results are admixtures of independent-particle configurations.

# Approaches to the shell model....

choose model space

create different configurations within that valence space  
add effective interactions and deal them with using matrix  
diagonalisation

where do interactions come from?

old days – purely empirical or schematic. Nowadays:

- (i) take an N-N force (realistic) – modify within the nuclear medium (G-matrix,  $V_{\text{low } k}$ , etc)
- (ii) then tune against some experimental data in “simpler nuclei” – attempt to modify for effects of restricted model space

choice of model space = degrees of freedom needed + size of calculation  
codes = ANTOINE, NUSHELL, KSHELL, OXBASH...etc

interactions = Brown/Wildenthal USD, USDA, USDB, GXFP1, GXFP1A,  
Kuo/Brown, KB3, KB3G, FPD6, JUN45, SDPF, ... etc

*KSHELL is particularly easy to install and use – you can learn a lot by doing a few simple calculations and working through the results – try it out!*

<https://sites.google.com/alumni.tsukuba.ac.jp/kshell-nuclear/>

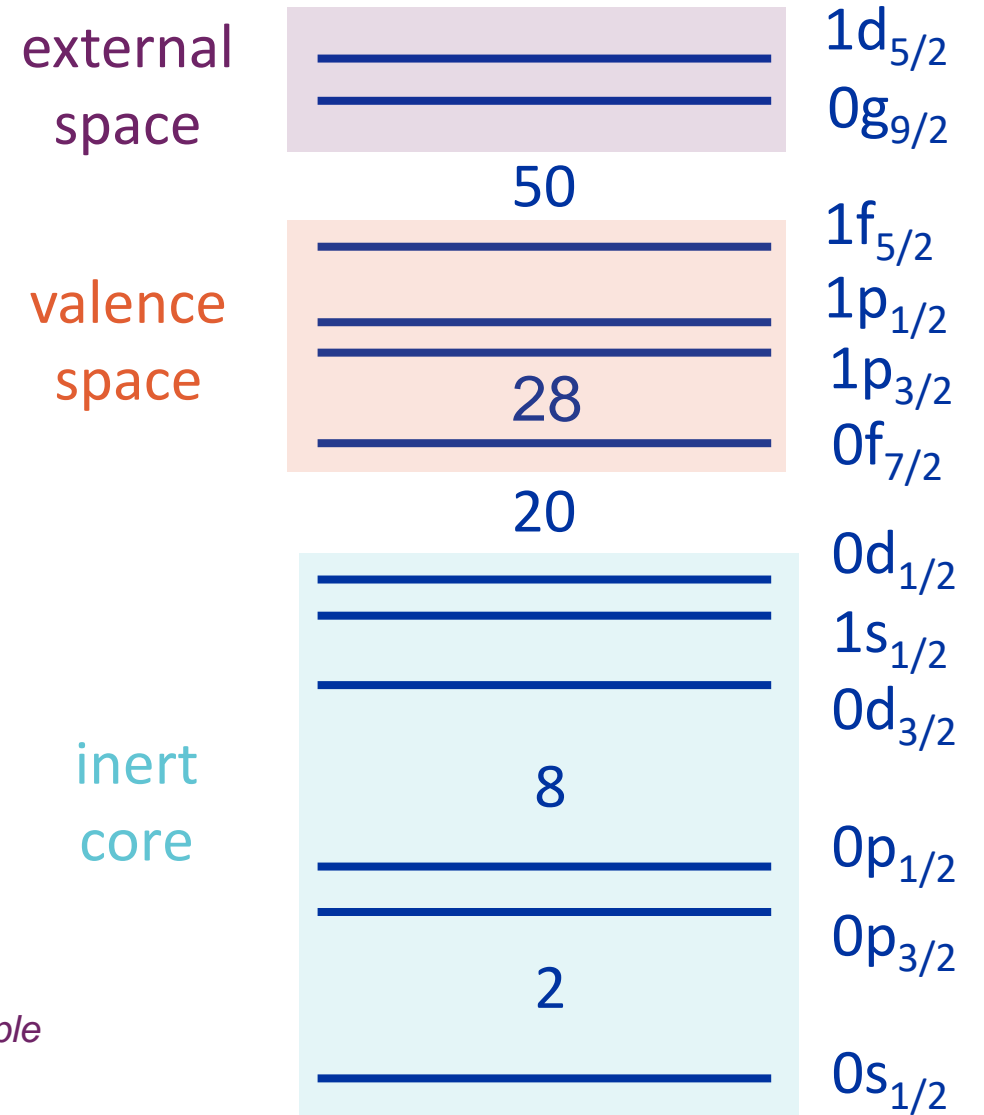



# Shell evolution

In IPM, protons and neutrons fill the levels according to Pauli, e.g. stable mid-shell nucleus with  $N > Z$ .

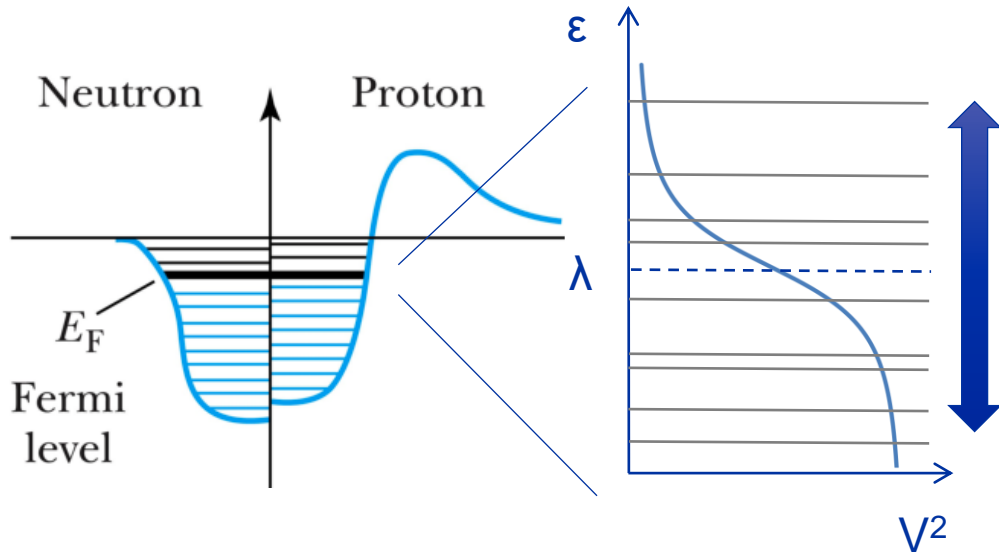

- Single-nucleon potentials around 50 MeV deep (nucleon scattering).
- Energy in N-N residual interactions  $\ll$  7 MeV (binding energy per nucleon).
- To scatter – Pauli says you need an empty orbit!
- So residual interactions mainly scatter nucleons from orbitals around the Fermi level (watch SRC later on!)

- Different isotopes have different  $N/Z$
- Fermi surfaces sample different single-particle orbitals.
- Correlations between nucleons depend on their orbitals, expect to different nuclear structure in different nuclei.

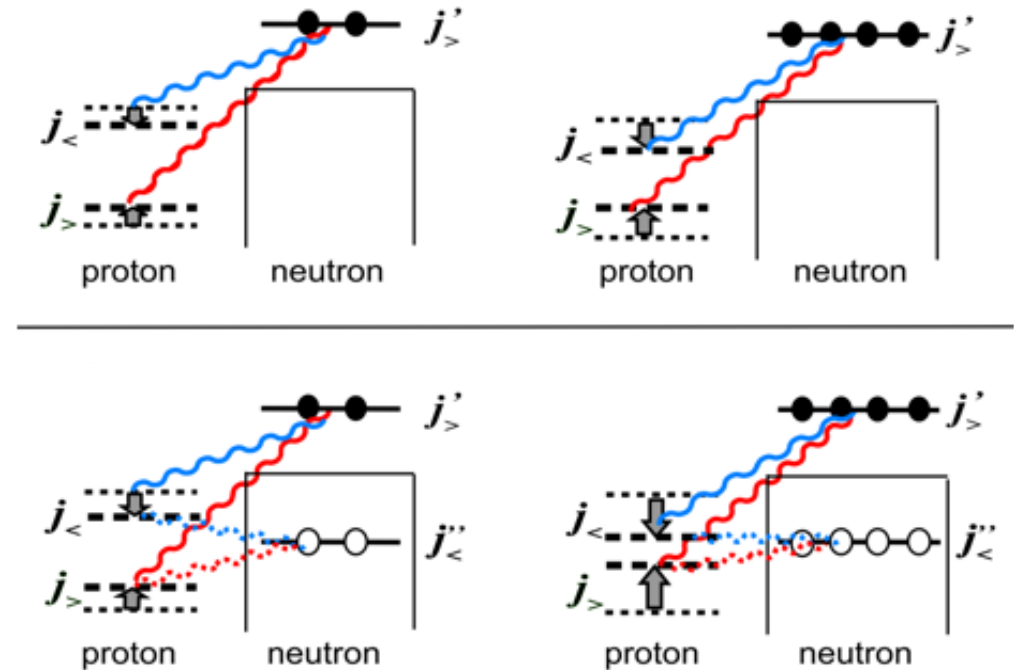

- Expect changes in shell structure of protons/neutrons as you move along a chain of isotones/isotopes – sometimes enough to create or destroy magic numbers
- Expect differences in the overall effect of residual interactions when you excite nucleons within a nucleus.



# Shell evolution

$^{16,18}\text{O}$  are stable!

As chains of isotopes and exotic nuclei are probed, beginning to see examples of phenomena.

Proton states in Sb isotopes probed by gently adding a proton to Sn targets in a *transfer reaction*.

$^{25}\text{O}$  produced in single-neutron *knockout reaction* from  $^{26}\text{O}$ . Ground-state mass reconstructed from the reaction products; difference with  $^{24}\text{O}$  tells you the  $d_{3/2}$  energy.

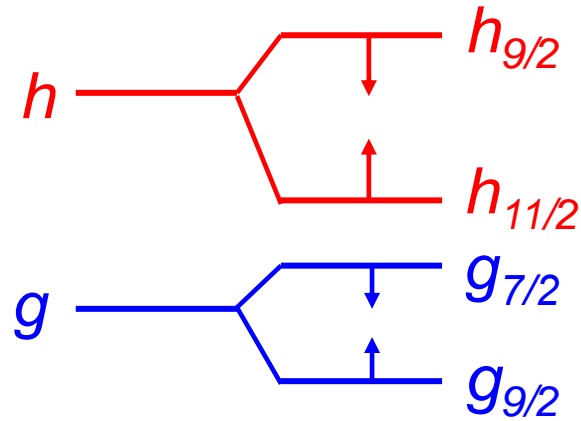
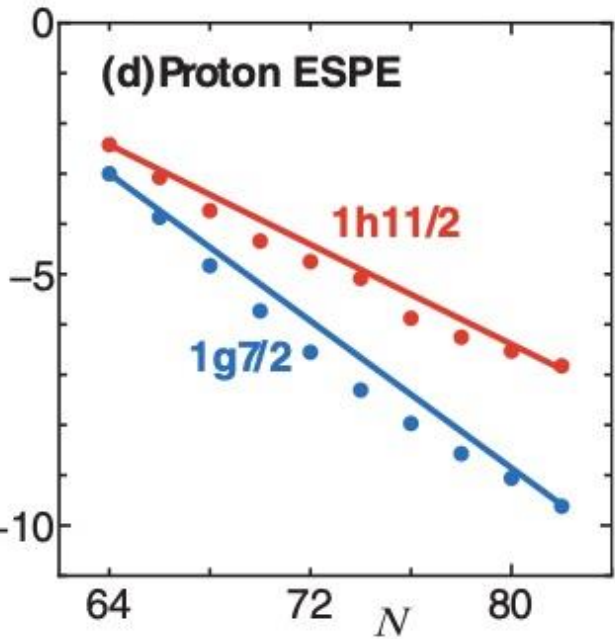

Neutrons filling  $h_{11/2}$  tensor interactions with proton orbitals.

Schiffer et al. PRL **92**, 162501 (2004)

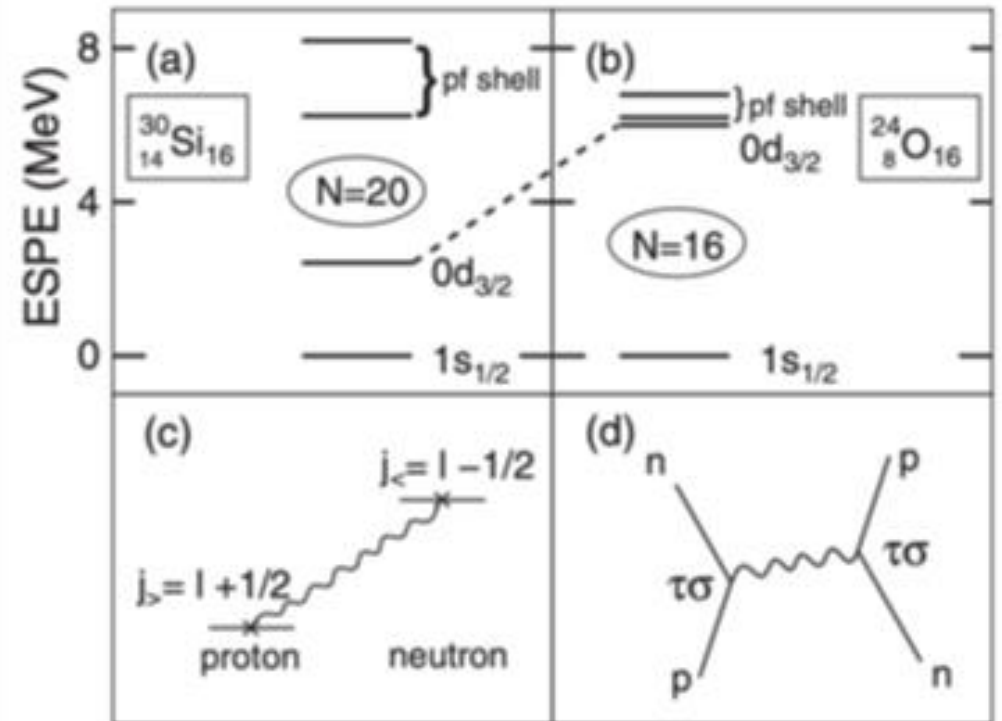

Otuska et al. RMP **92**, 015002 (2020)

Other examples of new magic numbers starting to emerge e.g.  $N=32$  and  $N=34$  in calcium isotopes.



# But unusual features of weak binding....

Contributes to the energy between spin-orbit partners at the edge of stability...e.g. (d,p) reactions to nuclei with N=17, 19, and 21.

Experiments with exotic beams necessary!

P.T. MacGregor *et al.* *PRC Letts* 104, L051301 (2021)

G. Burgunder *et al.* *PRL* 112, 042502 (2014)

J. Chen *et al.* *PLB* 853, 138678 (2024)

.....and with tricky stable targets!

Š. Piskoř *et al.* *NPA* 662, 112 (2000)

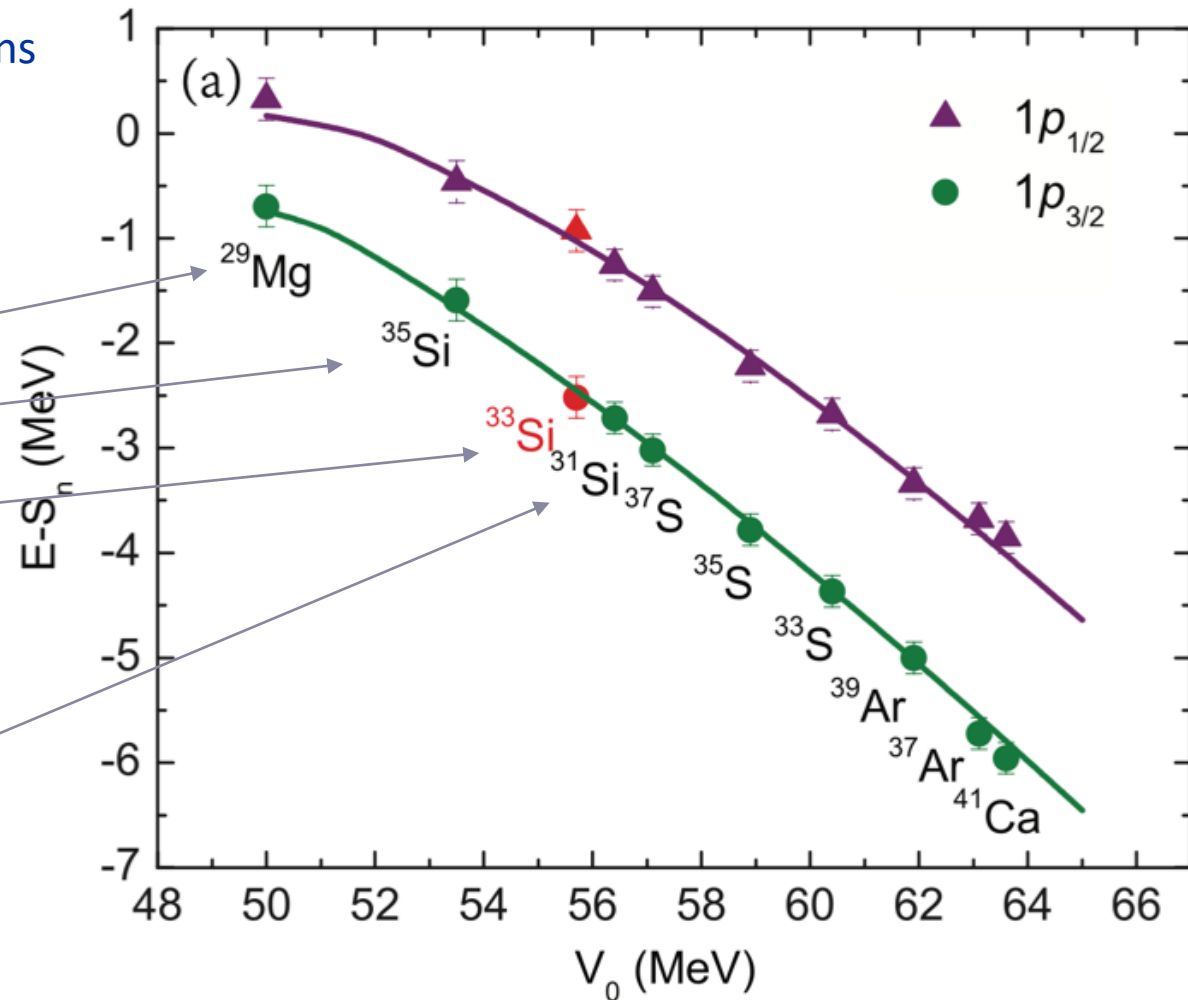



# Cautionary Tales: Does single-particle structure exist at all?

*Glib*: not able to completely define the interactions so wave functions from any model will always be mixed.

*Slightly less glib*: single particle orbits and energies are model-dependent fictions and not observable quantities.

*Slightly deeper*: single-particle potentials used are all attractive – the  $N-N$  force has a strong repulsive core and tensor components that so things must fail!

*But shell model does quite well – where the calculations are tractable – doesn't it?*

Yes, but... most knowledge of nuclei comes from surface properties 😞:

(i) hadronic probes cannot sample very far into the nucleus because of strong absorption, e.g. hadronic reactions sample the tails of wave functions at densities much less than the core.

(ii) many quantities calculated by integrals across the nucleus, e.g. energy eigenvalues, are weighted by  $r^2$ .

(iii) least-bound states are most accessible to experiment and are typically higher  $\ell$  values where radial wavefunctions peak nearer surface. Fewer low  $\ell$  states that peak at low radii.

Elastic electron scattering has sensitivity independent of  $r!$  😊

Measure densities to as low as 1% accuracy and can compare to HF calculations.

SHAPES of nucleon wave function in the interior are close to single-particle calculations – but what about the absolute values i.e. probabilities of finding nucleons... or occupancies of single-particle states.

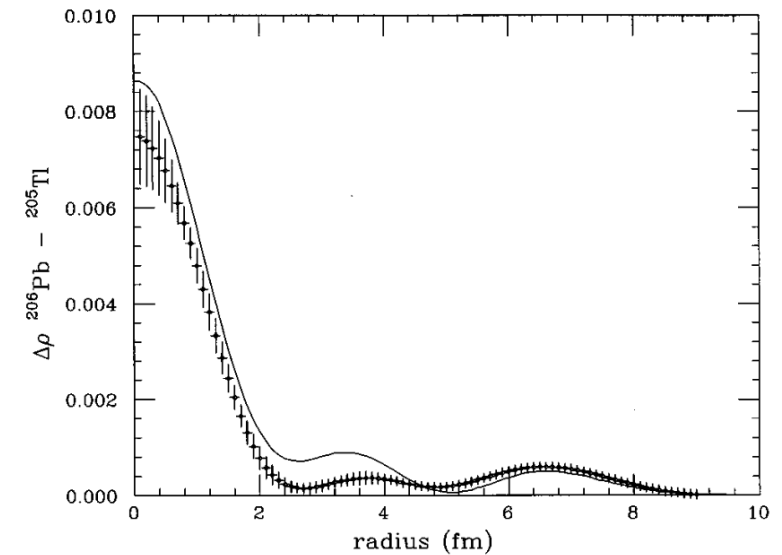
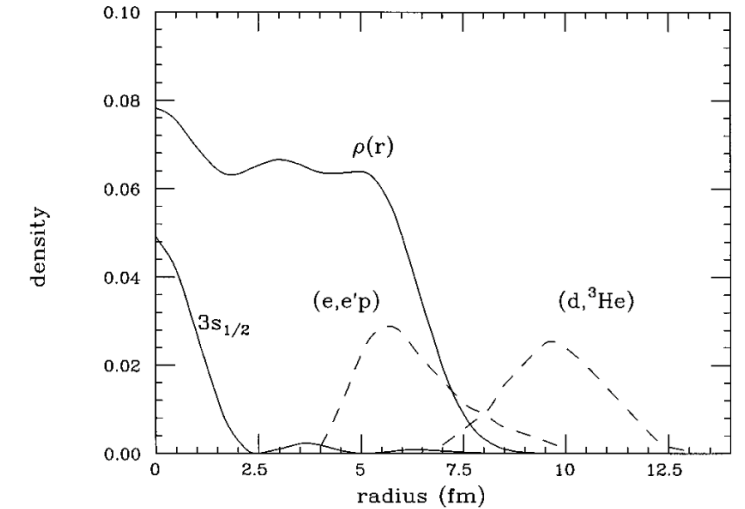

# Cautionary Tales: Does single-particle structure exist at all?

*What about nucleon occupancies of single-particle levels then?*

Early transfer reaction experiments appeared to show occupancy of 90-100% below the Fermi surface – but the analysis is model dependent (biased?) ! Became apparent when (e,e'p) reactions (less model dependent) showed values of ~60% IPM.

G. J. Kramer, H. P. Blok, and L. Lapikas, NPA 679, 267 (2001).

Kay, Schiffer, Freeman PRL **111**, 042502 (2013)

Hang on – only around 2/3<sup>rd</sup> of nucleons in the nucleus are in single-particle orbitals below the Fermi surface, where are the other 1/3<sup>rd</sup>?

Yes - interactions between particles will scatter them between single-particle states - smearing the Fermi surface.

But short-range interactions will generate a high momentum (or high excitation) tail - where there is a larger fraction of the minority nucleons.

Tensor interaction seems to generate more np SRC pairs so equal numbers of majority and minority pairs are involved.

Piasetzky et al. PRL. **97**, 162504 (2006)

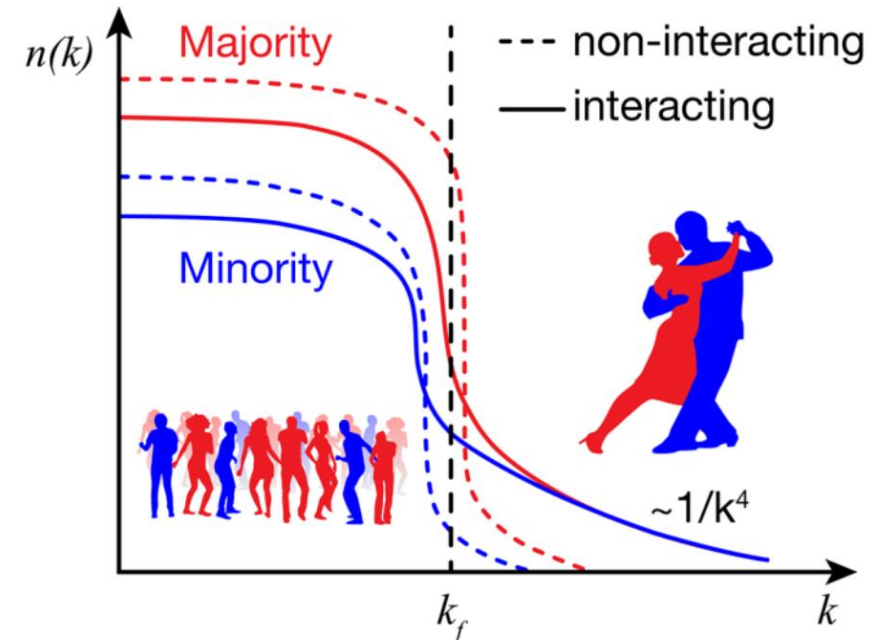

Hen et al. Science **1256785** (2014)

So, concluding – if we realise that single-particle phenomena at lower energies might be quenched by around 60%, then single-particle structure is a reasonable thing to talk about – but it is STILL a model construct and not reality!

“But what is reality anyway.....?”



# Pause for thought:

- Nuclei = a complex, many-body problem bound with complicated strong force.
- Correlations between nucleons are very important.
- The only bound system of two different fermions – the proton/neutron Fermi surfaces sample different single-particle orbitals and the resulting correlations support different structures.
- Leads to an evolution of shell structure.
- Expectation of strange effects in the most exotic, least bound systems near the proton and neutron driplines.

Theoretical descriptions (in all but the lightest nuclei) are imperfect:

- shell model is usually truncated, and interactions have empirical elements.
- close to the edge – coupling to the continuum is important and difficult to deal with.

Gianluca will tell you more!

Data on nuclei far from the line of stability are important for testing and motivating theoretical developments.

“You can’t just see an  $11/2^-$  state and claim that it is  $h_{11/2}$ ?”

*How do we ~~measure~~ probe single-particle properties of exotic nuclei?*



## PART 2: Direct reactions and shell structure

*Caveat 1: One can always measure energies, spins, moments, sizes and shapes and compare to a shell-model calculation, but direct transfer reactions are one of the more “direct” probes of shell structure.*

*Caveat 2: Focus on direct one-nucleon transfer reactions at energies around 10 MeV/u that are nowadays done at ISOL radioactive beam facilities. Knockout reactions at  $>100$ s MeV/u are often used at fragmentation facilities - but will only get a brief mention here.*

# Compound Nucleus Mechanism

Niels Bohr 1936: Guided by the knowledge of a strong, short-ranged nuclear force...

...projectile and target lose their integrity to form CN. Incoming energy shared randomly over all nucleons (equilibration). Major part of the total reaction cross section in many cases...

Randomization suggests that any outgoing particles will be emitted in an essentially isotropic angular distribution...<sup>1</sup>

<sup>1</sup> Although if large amount of CN angular momentum (heavy-ion induced reaction) tendency for preferential emission at 0° and 180°: *forwards/backwards symmetry*

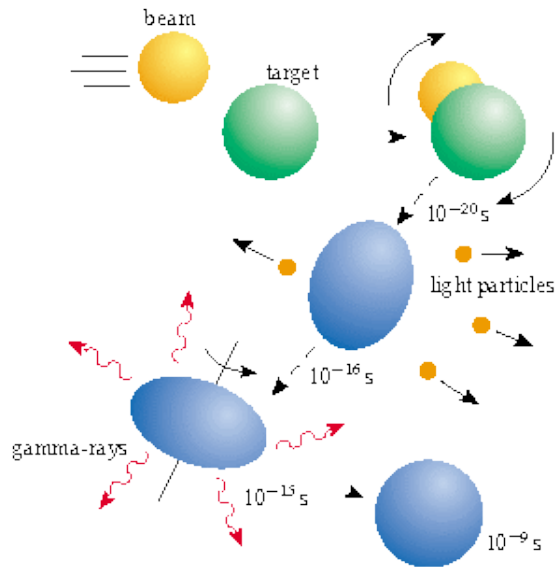

A powerful method to populate excited states in nuclei, particularly to study their  $\gamma$  decay.



# A new reaction mechanism in 1950

A direct mechanism to explain pronounced structure at forward angles in (d,p) reactions.

Precursor ideas: Oppenheimer and Phillips PR 48 (1935) 500 and Serber PR 72 (1947)

1008

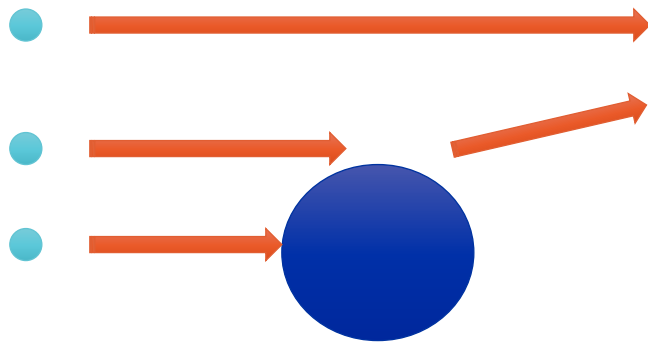

## Letters to the Editor

PUBLICATION of brief reports of important discoveries in physics may be secured by addressing them to this department. The closing date for this department is five weeks prior to the date of issue. No proof will be sent to the authors. The Board of Editors does not hold itself responsible for the opinions expressed by the correspondents. Communications should not exceed 600 words in length.

### Angular Distributions of Protons from the Reaction $O^{16}(d, p)O^{17}$

HANNAH B. BURROWS  
University of Liverpool, Liverpool, England  
W. M. GIBSON  
University of Bristol, Bristol, England

J. ROTBLAT  
Medical College of St. Bartholomew's Hospital, London, England  
October 30, 1950

THE reaction  $O^{16}(d, p)O^{17}$  gives a number of groups of protons, of which the two corresponding to the ground state and first excited state of  $O^{17}$  have  $Q$ -values of 1.925 Mev and 1.049 Mev (Buechner *et al.*<sup>1</sup>). The intensities of these two groups have been measured at seven angles by Heydenburg and Inglis,<sup>2</sup> using deuteron energies between 0.65 Mev and 3.05 Mev.

We have used the 8-Mev deuteron beam from the University of Liverpool cyclotron, and a scattering camera in which photographic plates record particles emitted from a gas target at all angles from  $10^\circ$  to  $165^\circ$ , to obtain detailed angular distributions for the charged particles emitted in a number of deuteron-induced reactions. A full account of the method and results will be published elsewhere, but because of their theoretical interest (Butler<sup>3</sup>), the angular distributions of the two groups of protons from the reaction  $O^{16}(d, p)O^{17}$  are presented here.

Tracks of protons from the two groups were identified by their ranges in the photographic emulsion, and the number of protons in each group, found in a given area, was determined for a series of angles from  $10^\circ$  to  $160^\circ$ . Ordinarily, measurements were made at  $5^\circ$  intervals, but at the more critical angles the interval was reduced to  $2.5^\circ$  or even to  $1.25^\circ$ . Using these numbers and the geometry of the apparatus, we calculated the angular distributions

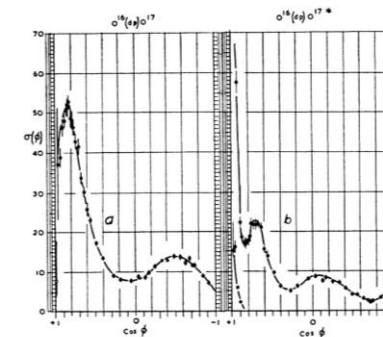

FIG. 1.  $O^{16}(d, p)O^{17}$  angular distributions in the center-of-mass (c.m.) system:  $\phi$ =c.m. angle,  $\sigma(\phi)$ =c.m. differential cross section in arbitrary units. Curve a is for formation of  $O^{17}$  in the ground state, and curve b is for the 0.88-Mev excited state.

of the two shown in cross sect at a cente

Figure ground  $\sigma$   $\cos\phi=0.8$  minimum falls again tending t cluded th further c be studie

In cont of  $O^{17}$  in  $\cos\phi=0.7$  rising ste The m in behav shown th formed, tions, acc The obs theoretical angular d parities

<sup>1</sup> Buechner, Strait, Sperduto, and Malm, Phys. Rev. 76, 1543 (1949).  
<sup>2</sup> N. P. Heydenburg and D. R. Inglis, Phys. Rev. 73, 230 (1948).  
<sup>3</sup> S. T. Butler, Phys. Rev. 80, 1095 (1950). Following letter.

### On Angular Distributions from $(d, p)$ and $(d, n)$ Nuclear Reactions

S. T. BUTLER\*  
Department of Mathematical Physics, University of Birmingham, Birmingham, England  
October 30, 1950

THE purpose of this note is to report the results of calculations which show how information regarding the spins and parities of nuclear energy levels can be obtained from angular distributions from nuc

sity of a nucleus. Peierls, v reactions Rotblat, and the structure moment radius. least in of the d merely c process i of the lo

I have stripping wave fu wave fu equation of the n distribu sulting i director spins an the fact

mentum and of parity allow the nucleus to accept a particle (say a neutron) with only very limited values of angular momenta  $l_n$ , and the angular distribution depends very sensitively on these



# Direct Reactions

A process going *directly* from initial to final state in a single step without CN formation, the projectile just interacts with one “degree of freedom” in the target (single nucleon, a normal mode of nuclear motion...).

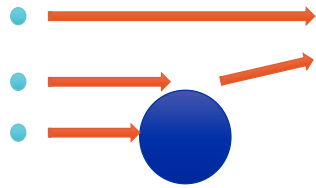

Tendency for surface localization (*subject to QM!*)

...at least for most non-elastic direct reactions (watch elastic scattering with light ions)...

Sometimes better to think of localization in angular momentum space

( $\underline{L} = \underline{r} \times \underline{p}$ ) where  $L_{grazing}$  partial waves contribute most.

Explicit dependency on the initial and final states; reaction amplitudes depend on their overlap.

Example:  $A(d,p)B$  depends on:  $\langle A + n | B \rangle$

*i.e. how much does the final state look like the target plus a neutron in a single-particle orbital*

If two nuclear states differ by ... or have important components that differ ... only in the excitation of a single fundamental mode, they will be strongly connected by the appropriate direct reaction:

*direct inelastic scattering e.g.  $(p,p')$   $\Rightarrow$  collective modes*

*single-nucleon transfer e.g.  $(d,p)$   $\Rightarrow$  single-particle states*

*two-nucleon transfer e.g.  $(^3\text{He},n)$   $\Rightarrow$  states with strong pair correlations*

*cluster transfer e.g.  $(^6\text{Li}, d)$   $\Rightarrow$  states with strong cluster structure*

# Compare and Contrast

	<b>DIRECT</b> <i>single step</i>	<b>COMPOUND</b> <i>fully equilibrated</i>
<b>Angular Distribution</b>	Forward	Isotropic; Fwd/Bck symmetric
<b>Reaction Time</b>	Fast $\approx$ transit time, $10^{-22}$ s	Slow $\approx$ equilibration time, $10^{-16}$ to $10^{-18}$ s
<b>Energy Variation</b>	Slow	Rapid: resonances
<b>Energy Transfer</b>	Small	Large
<b>Outgoing Particle</b>	Large energy	Small energy
<b>Selectivity</b>	Initial/final state dependent	Only dependent on overall spin and energy conservation

*DIRECT*  $\longleftrightarrow$  *CN*  
 Single step – Multistep – Pre-equilibrium – Fully equilibrated

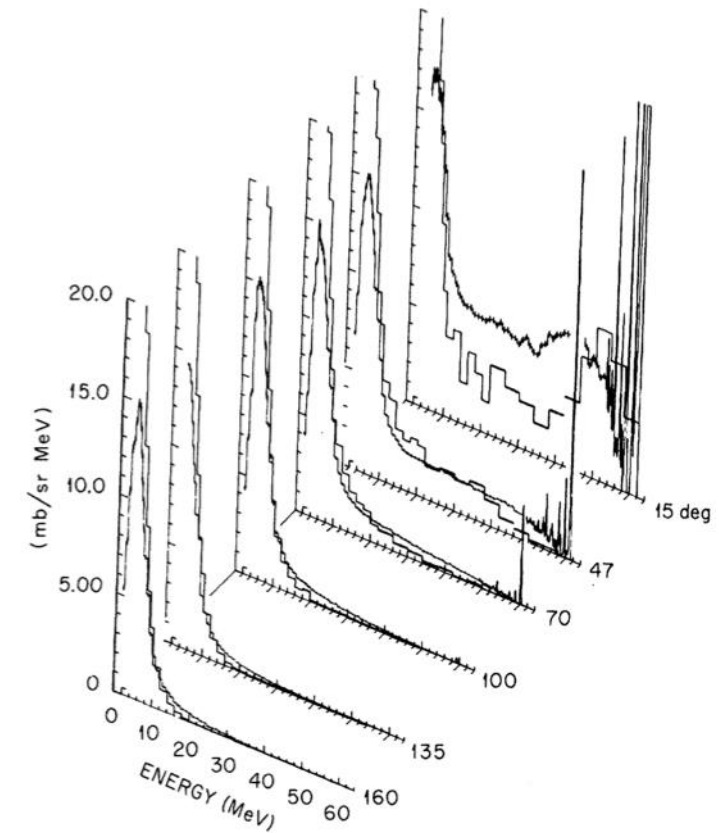

Energy spectra of protons emitted at various angles following bombardment of  $^{54}\text{Fe}$  by 62-MeV protons – inelastic scattering via direct and CN mechanisms.

Bertrand *et al.* PRC **8** 1045 (1973)

The single-step of the direct processes may act as a *doorway* into CN formation.

# What can you measure?

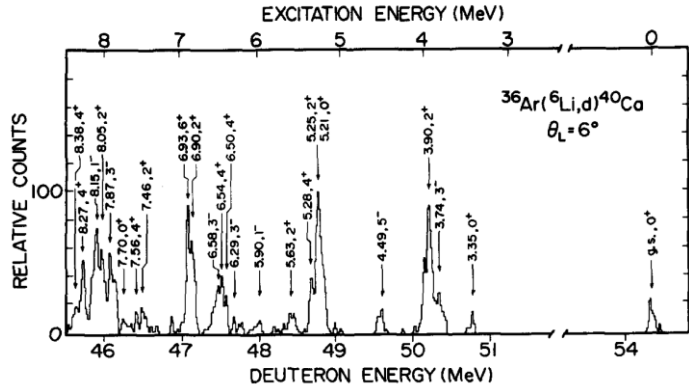

Yamaya *et al.* NPA 573 154 (1994)

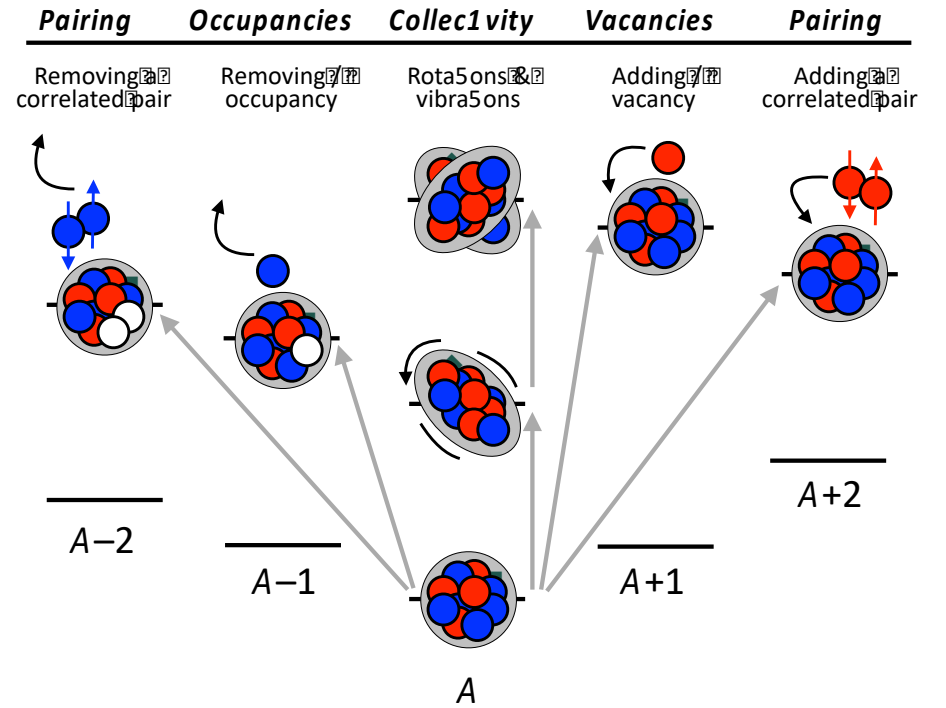
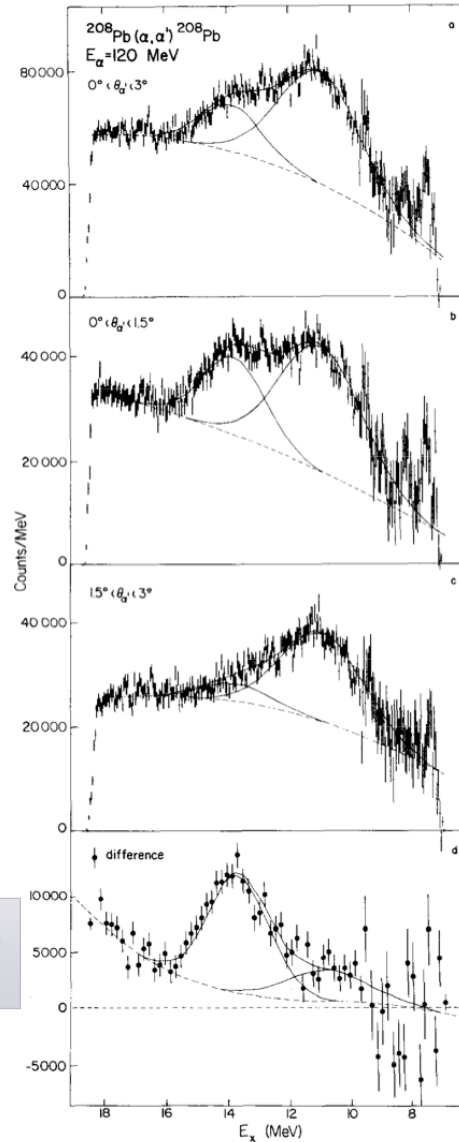

**Energetics:**

reaction Q values, masses, excitation energies from ejectile momenta.

**Quantum numbers:**

orbital angular momentum transferred  
total angular momentum transferred.

**Overlap between initial and final states:**

reduced transition probabilities (inelastic scattering),  
deformation parameters (inelastic scattering),  
single-particle nature of states (nucleon transfer/knockout),  
pairing correlations (two-nucleon transfer),  
cluster structure of states (alpha transfer etc.).

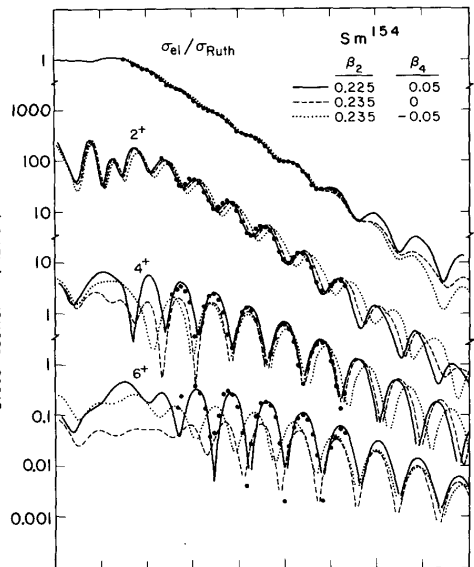

Brandenburg *et al.* NPA 446 29 (1989)

D.L. Hendrie *et al.* PLB 26 127 (1969)

# Transfer Reactions

Typical and well-studied direct reactions of topical value: many similarities with other direct reactions in terms of angular distributions, momentum matching, DWBA etc.  
Use as an example of the issues associated with direct reactions.

Examples:

neutron adding:  $(d,p)$   $(\alpha,h)$  ( $^{12}\text{C}, ^{11}\text{C}$ )...  
proton adding:  $(d,n)$   $(h,d)$   $(\alpha,t)$  ( $^{16}\text{O}, ^{15}\text{N}$ ) ...  
neutron removing:  $(p,d)$   $(h,\alpha)$  ( $^{12}\text{C}, ^{13}\text{C}$ )...  
proton removing:  $(d,h)$   $(t,\alpha)$  ( $^{16}\text{O}, ^{17}\text{F}$ )...  
pair transfer:  $(t,p)$   $(p,t)$   $(h,n)$   $(d,\alpha)$   
cluster transfer: ( $^6\text{Li}, d$ )...

$h=^3\text{He}$ ="helion"

Old fashioned nomenclature:

*Stripping*: removing from the projectile e.g.  $(d,p)$

*Pickup*: adding to the projectile e.g.  $(t,\alpha)$

Gets very confusing especially in inverse kinematics: much better to talk about adding/removing to/from the species of interest whether that is the target or the projectile!

Take care:

*Transfer reactions often means "transfer reactions via a direct mechanism"!*

Can (for example) go via CN mechanism - so choose your experimental conditions carefully!



# Transfer Reactions



time reversal

$$a = b + x$$

$$B = A + x$$

i.e.  $x$  is transferred between projectile and target.

Three-body problem:  $A$ ,  $b$  and  $x$  made worse by possible internal excitations!

## Distorted-Wave Born Approximation (DWBA):

1. Single-step reaction from entrance ( $A+a$ ) to exit channel ( $B+b$ ).
2. Transfer probability is so low that it can be treated in first order.
3. Optical model wave functions describe relative motion in both channels.

**Vertices**: elementary transitions described by “*form factors*” dependent on degree of overlap of the heavier nucleus with the lighter one plus  $x$ .

*Optical model*: “elastic scattering wave functions”.

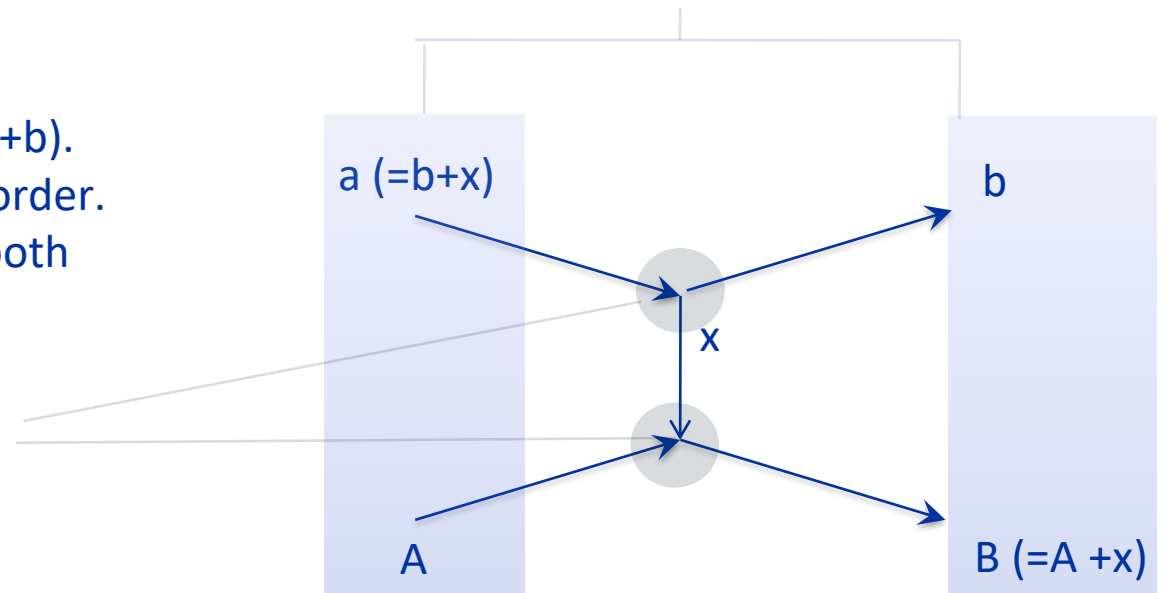

# the Optical Model

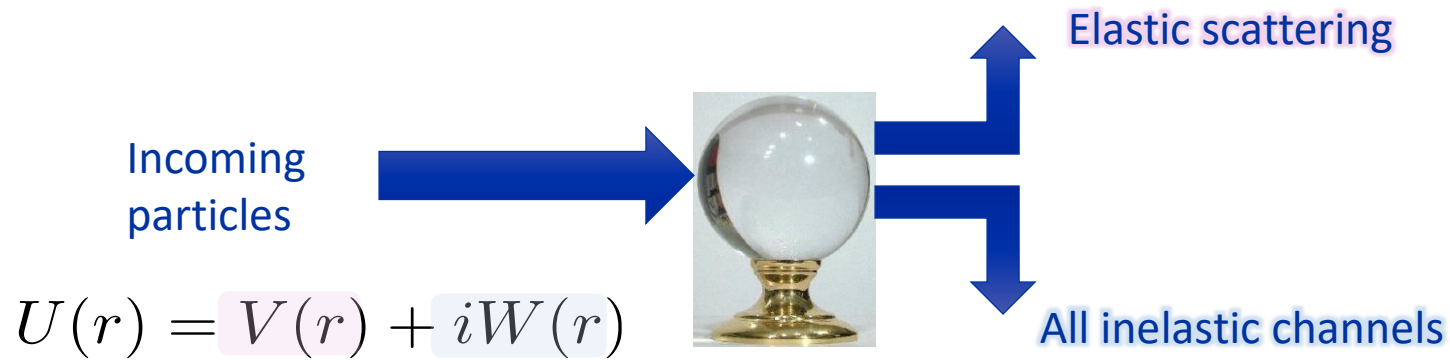

Real and imaginary potentials are responsible for elastic scattering and absorption of incoming particles, respectively.

Variety of choices for form of potentials motivated by physical considerations: Woods-Saxon, WS derivatives, spin-orbit potentials and add Coulomb term.

*Empirically* adjust the parameters in the potentials to fit experimental *elastic scattering* data.

*Fitting is dangerous – do you fall into a secondary minimum reproducing cross section but without an unrealistic potential...? “Local fits” might capture structural effects in a small region, but more susceptible to hidden fitting issues.*

*“Global fits” to wide ranges of nuclei not so subject to vagaries in fitting – but miss real local effects...*

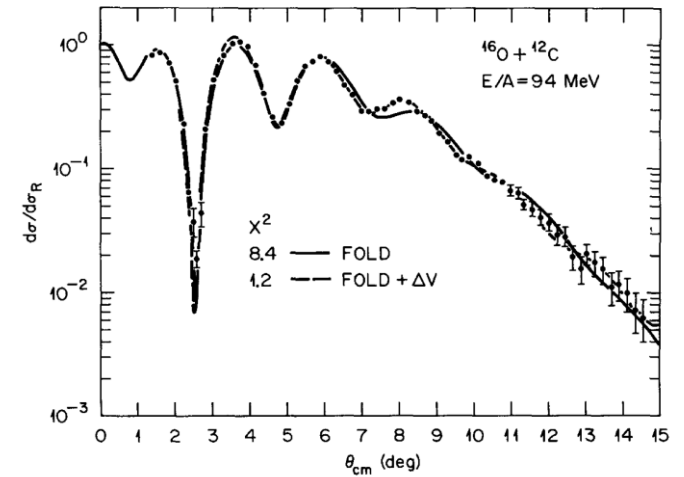

Kobos *et al.* NPA **487** 457 (1988)

Rather like the shell model approach but for scattering states...  $U(r)$  is the average interaction of the projectile with all nucleons.

# DWBA Example

## Ingredients for $^{64}\text{Zn}(d,p)^{65}\text{Zn}$ :

- (i) relative wave function of d moving in nuclear and Coulomb field of  $^{64}\text{Zn}$
- (ii) relative wave function of p moving in nuclear and Coulomb field of  $^{65}\text{Zn}$
- (iii) bound-state wave function of neutron in  $^{65}\text{Zn}$
- (iv) bound-state wave function of neutron in d (or some suitable internal wave function for the deuteron).

(i) and (ii) from OPTICAL MODEL

(iii) Often from Woods-Saxon calculation - requires  $V$ ,  $r_0$  and  $a$ .

(iv) These days often from an ab-initio calculation for light species – or Woods-Saxon if heavy,

Run DWUCK, PTOLEMY, TWOFNR, FRESCO.....scale resulting curves onto data!

“Hides a lot of understandable physics!”

Often, DWBA gets first maximum reproduced very well – some details of wiggles okay – back angles are terrible!

Example:  $^{64,66}\text{Zn}(d,p)$  @ 5 MeV/A

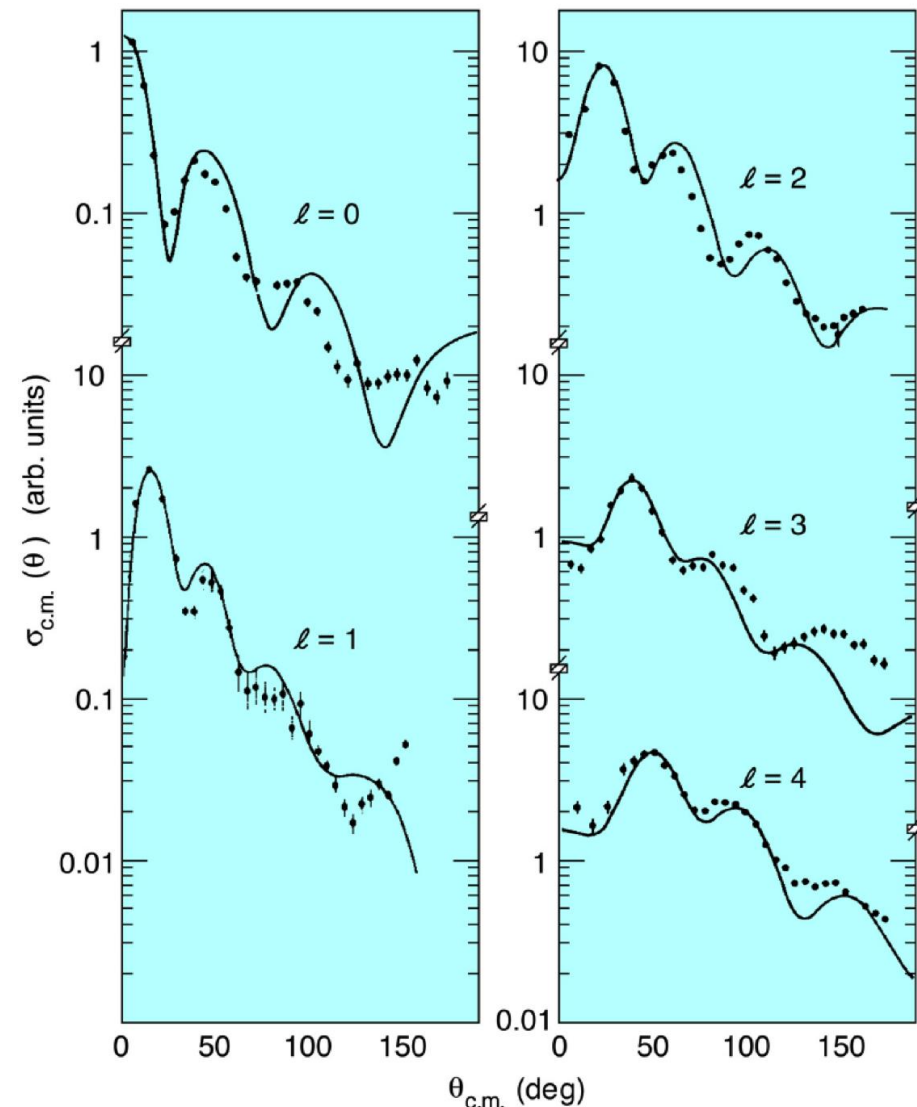

von Ehrenstein *et al.* PRC **164** 1374 (1967)

# QM vs. Semi-classical / Light Ions versus Heavy Ions

Hides a lot of understandable physics!

Think in terms of semi-classical ways: trajectories, geometry etc...

But QM is the way to describe it!

10 MeV/A d  $r \sim 2.1$  fm,  $p \sim 270$  MeV/c, de Broglie wavelength of 4.5 fm.

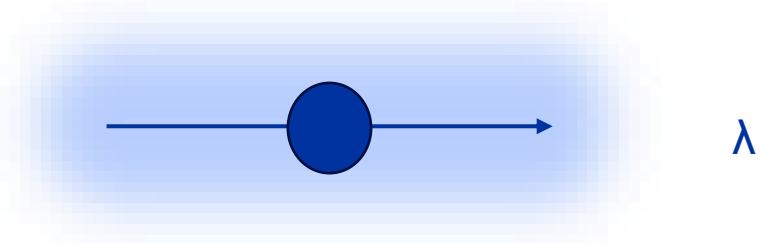

10 MeV/A  $^{18}\text{O}$   $r \sim 3.1$  fm,  $p \sim 2500$  MeV/c, de Broglie wavelength of 0.5 fm.

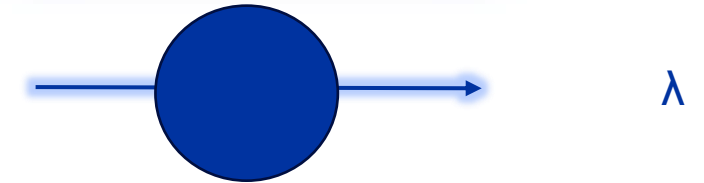

Heavy ions: shorter de Broglie wavelengths, higher angular momentum and stronger absorption effects. More spatial localization. Trajectories a more sensible concept...

....*semi-classical* approaches more plausible!

Tight kinematic selectivity and complex angular distributions, combined with difficulties with experimental resolution, make heavy-ion transfer somewhat less useful for detailed spectroscopy.

# Angular momentum selection rules

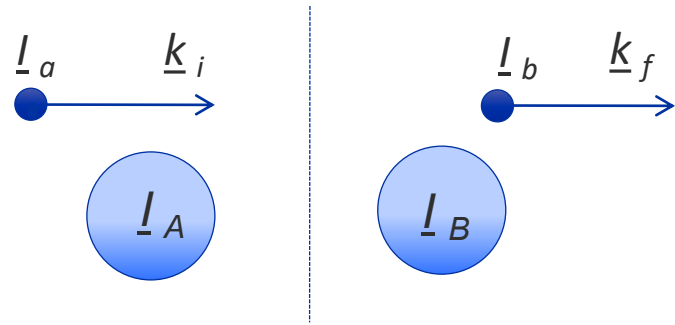

Light ion,  
zero spins.

**Examples:**

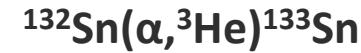

$$j_1, \ell_1 = s_{1/2} \text{ so } \ell = \ell_2$$

i.e. angular mom. transfer tells you the orbital angular mom of final bound state.

Heavy ion,  
zero spins.

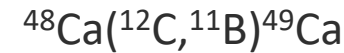

$$j_1, \ell_1 = p_{3/2} \text{ so } \ell = \ell_2, \ell_2 \pm 1$$

i.e. several angular momentum values contribute to transfer.

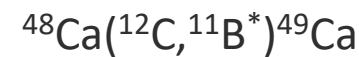

i.e. internal excitation of ejectiles can complicate the energy spectrum as well as the spin coupling.

Non-zero  
spins.

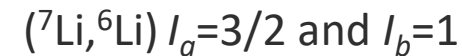

i.e. mixture dependent on the structure of the two nuclei!

Angular momentum conservation:

$$\underline{L}_i + \underline{I}_A + \underline{I}_a = \underline{L}_f + \underline{I}_B + \underline{I}_b$$

Orbital angular momentum transferred:

$$\ell = \underline{L}_i - \underline{L}_f = \underline{I}_B - \underline{I}_A + \underline{I}_b - \underline{I}_a$$

x transferred to  $j_2$  in B, from state  $j_1$  in a and :

$$\ell = j_2 - j_1 \text{ i.e. } |j_2 - j_1| \leq \ell \leq j_2 + j_1$$

Orbital nature:

$$\ell = \underline{\ell}_2 - \underline{\ell}_1 \text{ i.e. } |\ell_2 - \ell_1| \leq \ell \leq \ell_2 + \ell_1$$

$$\Delta\pi = \pi_A \pi_a \pi_B \pi_b = (-)^{\ell_1 + \ell_2}$$

Finding the orbital angular momentum transferred helps make assignments of the final state quantum numbers.



# Angular Distributions

Simple *geometric* connection between angular momentum transfer and angular distributions.

Linear momentum transferred:

$$\underline{q} = \underline{k}_i - \underline{k}_f$$

Angular momentum transferred:

$$\underline{\ell} = \underline{r} \times \underline{q}$$

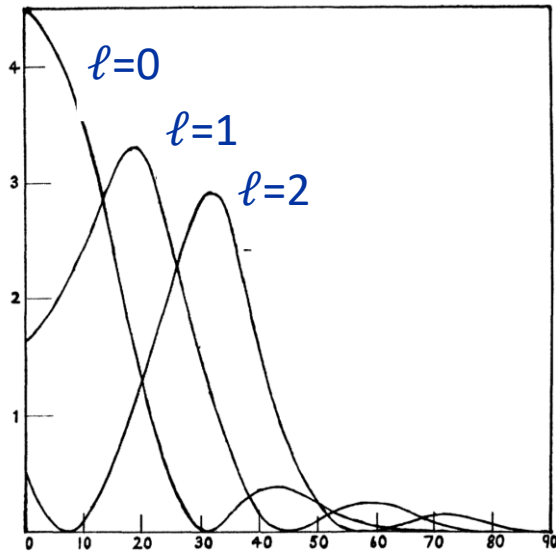
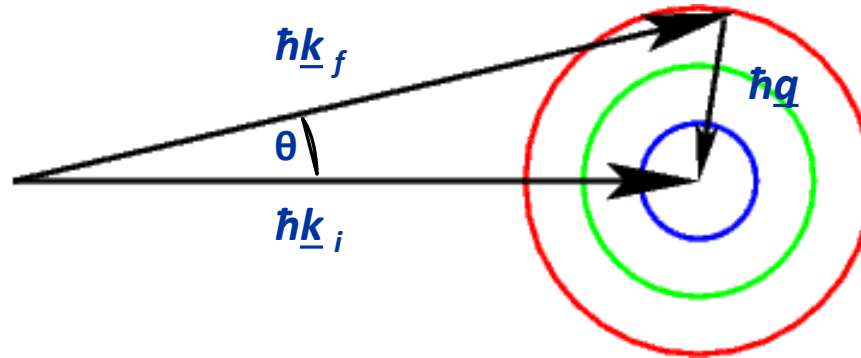

Surface localization means  $r$  is restricted to be around the nuclear radius.

To accommodate higher  $\ell$ , angle must get larger.

*Essence of simple semi-classical argument remains valid in quantum mechanical treatments.*

Note: peak cross sections when linear momentum matched to angular momentum

*so called “momentum matching”*

# Experimental Angular Distributions

- Good angular-momentum meter: peak yield moves to larger angles with higher angular momenta.
- Interference of near-side and far-side scattering causes “diffraction-like” effects.
- *In the region of the peak cross section: DWBA usually satisfactory with a shape only mildly dependent on optical-model and bound-state potential parameters.*

Example:  $^{64,66}\text{Zn}(d,p)$  @ 5 MeV/A

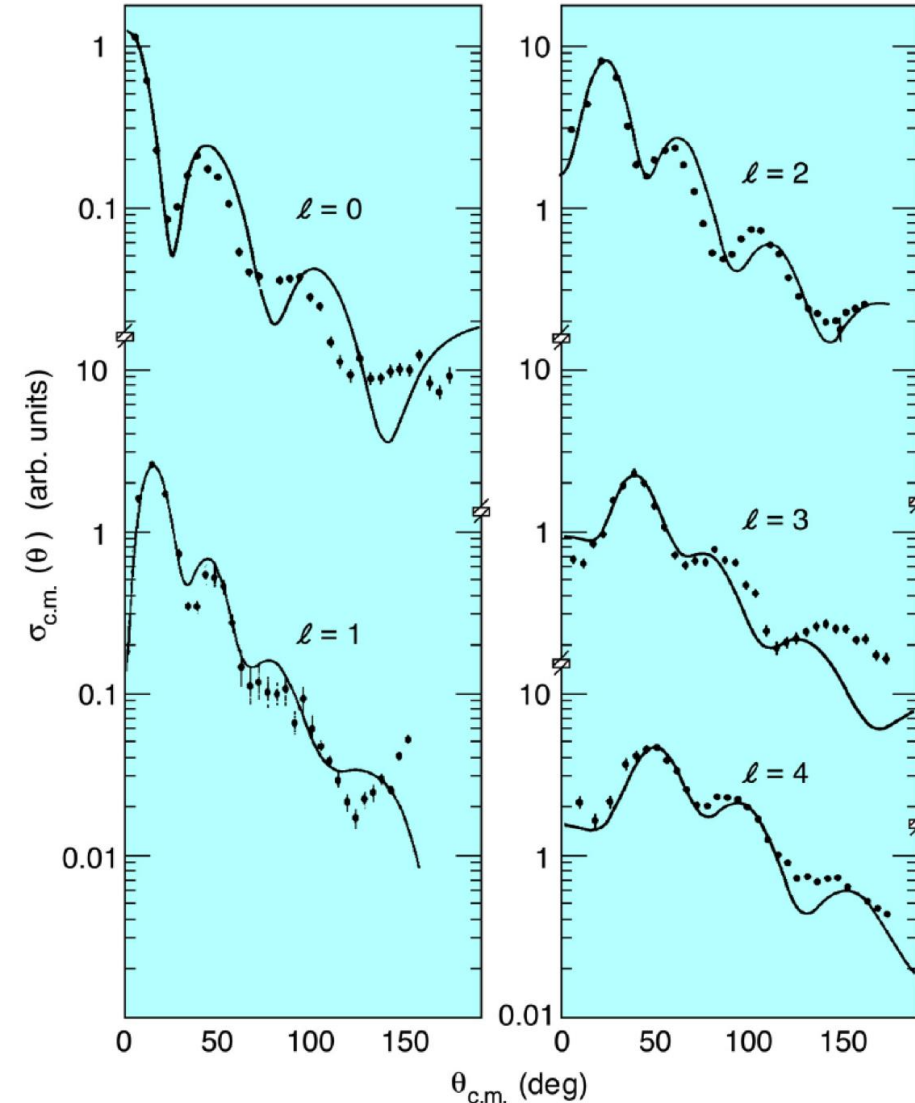

von Ehrenstein *et al.* PRC **164** 1374 (1967)

# Energy Dependence of Angular Distributions

Angular distribution depends on energy...not always forward peaked, but no forward/backward symmetry.

Low-energy (d,p):

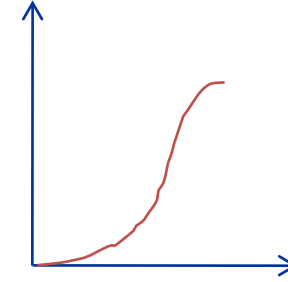
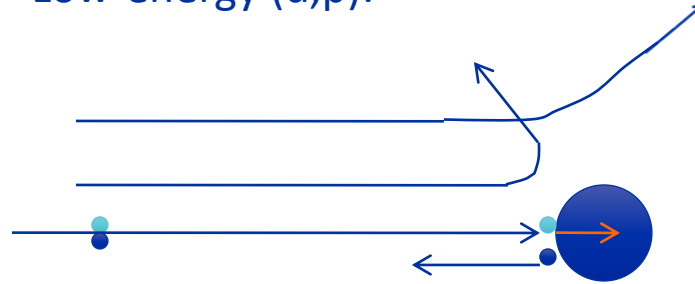

High-energy (d,p):

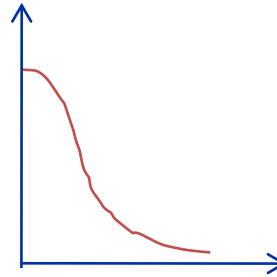
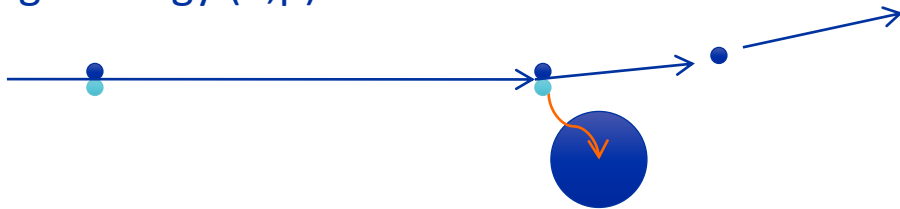

Diffractive wiggles more pronounced at higher energies...  
...best  $\ell$  assignments at  $\geq \sim 10\text{MeV/A}$ .

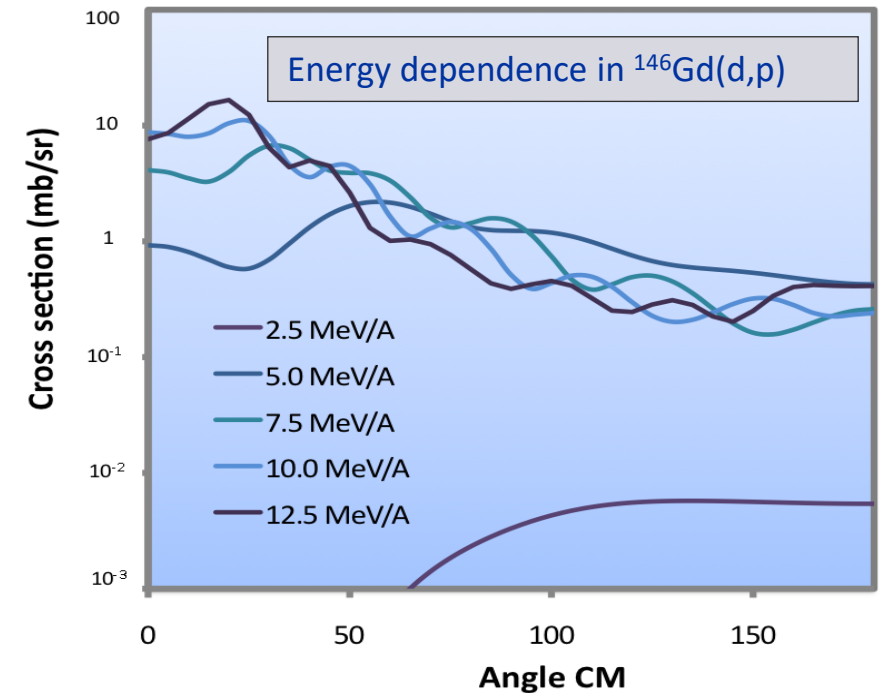

# Diffractive Effects: Semi-classical Ideas from HI Transfer

Coulomb field acts as divergent lens...separating near-side/far-side waves at low energies.

Nuclear interactions at closer distances/high energies, bring waves together producing interference patterns:  $\Delta\theta = \pi/kR$

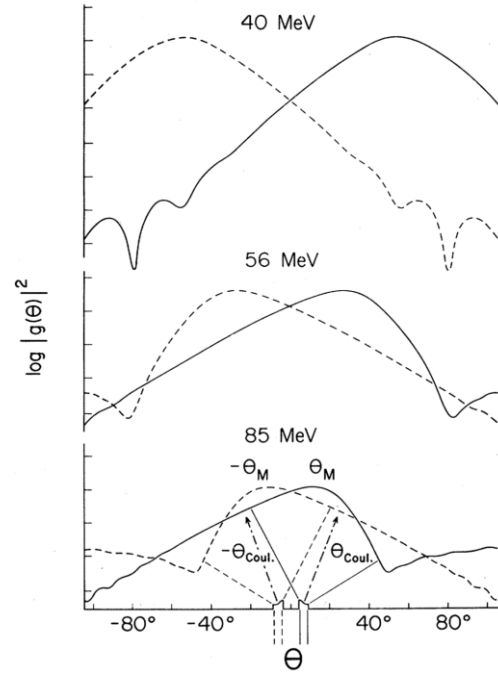
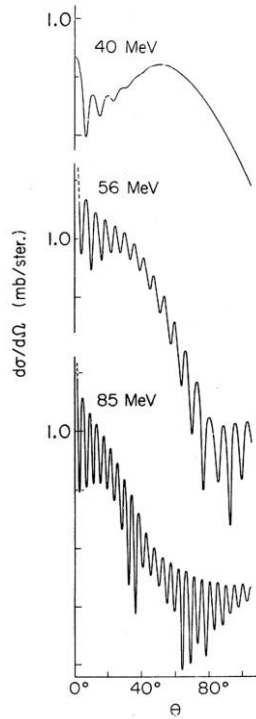
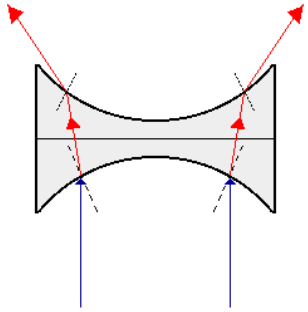

Friedman *et al.* PRL **33** 308 (1979)

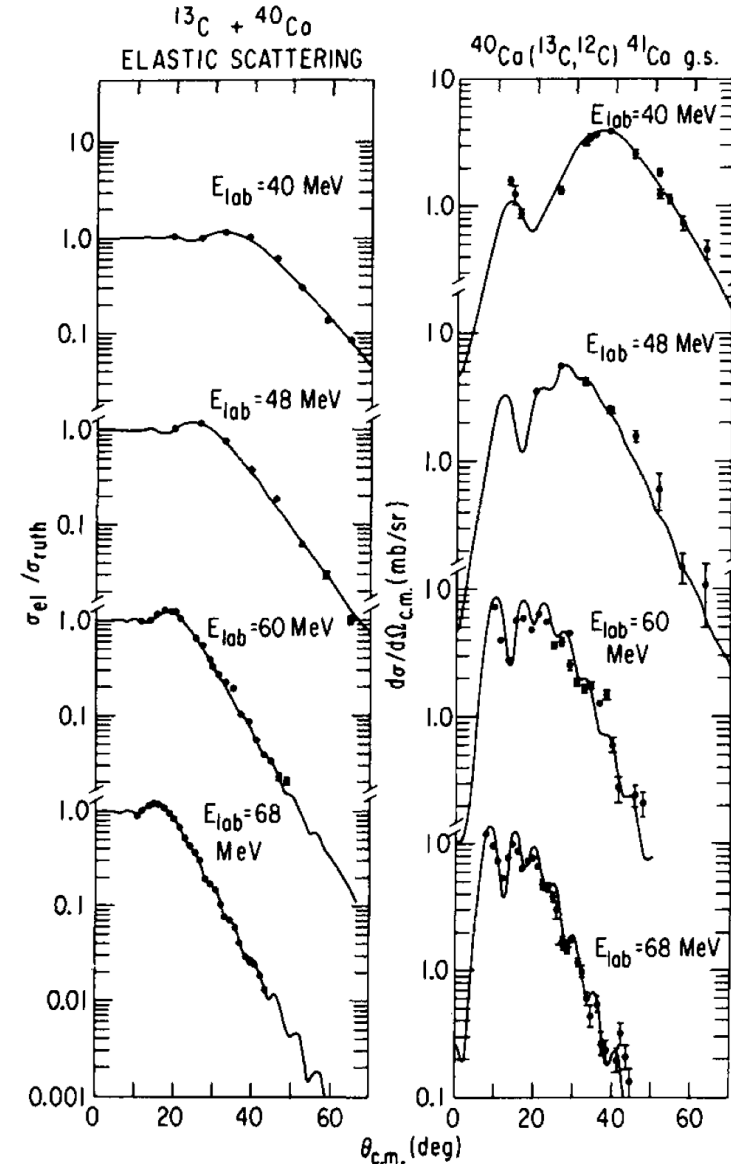

Bell-shaped



Diffractive

# Momentum Matching

$$\ell = L_i - L_f \approx r(k_i - k_f) \approx rq$$

Example, Proton-adding reactions on a  $^{124}\text{Sn}$ :

$(^3\text{He},d)$   $Q = -1.088 \text{ MeV}$

small linear momentum transfer, low  $\ell$  favoured

$(\alpha,t)$   $Q = -15.408 \text{ MeV}$

high linear momentum transfer, high  $\ell$  favoured

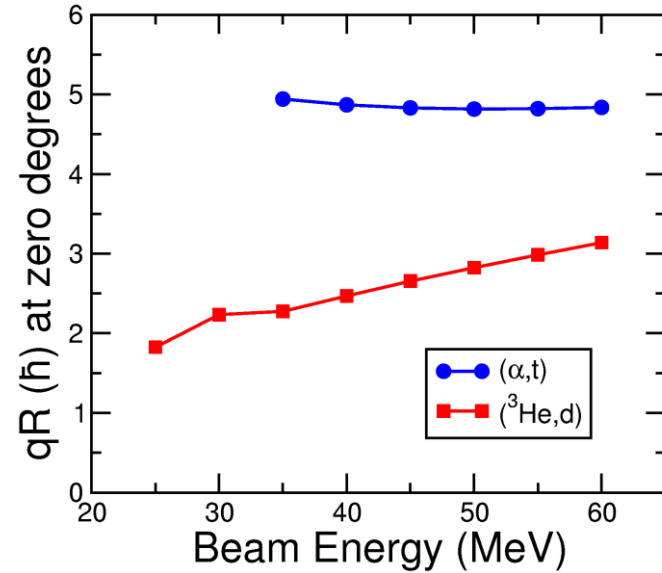

Indicative semi-classical kinematics calculation done for  $0^\circ$  ejectiles and ignoring Coulomb effects.

Reason why transfer not very practical at higher energies...800MeV/A (p,d)!

G.R. Smith *et al.* PRC **30** 593 (1984)

Heavy ions: Sharper localization in both space and L lead to stringent matching and sharp *Q-windows* arise...

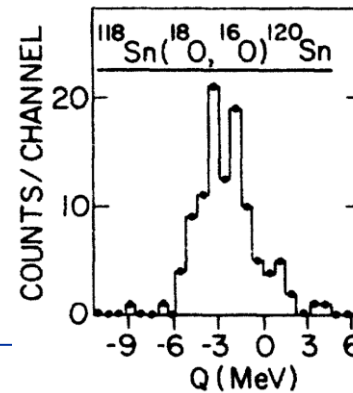
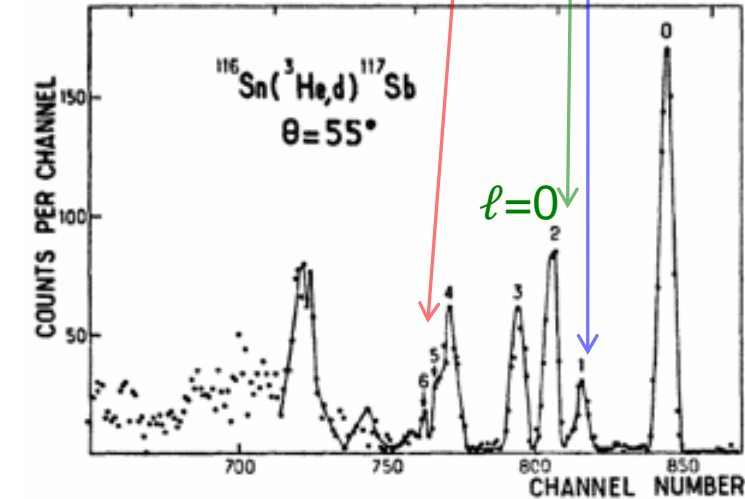
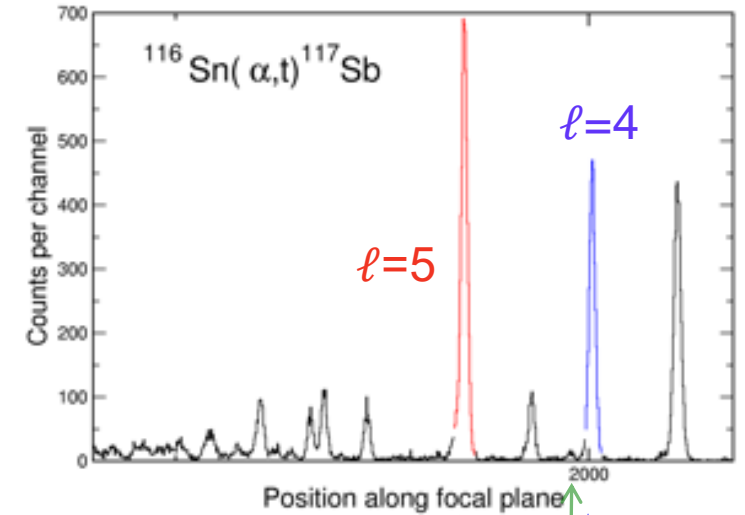



# Spectroscopic Factors (Equation-less version)

- Transfer adds/removes a nucleon in a single step to make final states in the residual nucleus.
- For final states that look like the target plus/minus a nucleon, high reaction rate: *core plus single-particle state in the independent-particle model (IPM)*.
- Other states, which do not have a simple single-particle structure, will not be as *strongly* populated in a *transfer* reaction, e.g. vibrations.
- Spectroscopic factors “compare” the observed cross section with that expected for an IPM state – giving you an idea of how single-particle-like the state is.
- Correlations between nucleons in a nucleus mean that the IPM is never right; spectroscopic factors are generally less than 100%.

# Spectroscopic Factors

Nucleon-removing reactions:

$$\frac{d\sigma}{d\Omega} = S_{j\ell} \left[ \frac{d\sigma(E, \theta, j\ell)}{d\Omega} \right]_{\text{DWBA}}$$

Detailed balance.  
Reciprocity.



Nucleon-adding reactions:

$$\frac{d\sigma}{d\Omega} = \frac{2J_B + 1}{2J_A + 1} S_{j\ell} \left[ \frac{d\sigma(E, \theta, j\ell)}{d\Omega} \right]_{\text{DWBA}}$$

DWBA essentially calculates the cross section to a “pure” single-particle state in *independent-particle model*:

$$“\Psi = \Phi_{\text{core}}\phi_{njl}”$$

In reality, residual interactions mix these states to produce more complex wave functions:

$$“\Psi = \sum a_{njl} \Phi_{\text{core}}\phi_{njl}”$$

...so probability amplitude of a transfer reaction via a particular  $njl$  will be reduced by factor dependent on  $a_{njl}^2$  i.e. cross section is less than a “pure” single-particle state by a factor  $S_{jl}$  the *spectroscopic factor*.

More correctly, spectroscopic factor measures the squared overlap:

$$S_{j\ell} = \left| \langle \Phi_{J_B}^{m_B} | \left[ \Phi_{J_A}^{M_A} \psi_{njl} \right]_{J_B}^{M_B} \rangle \right|^2 = \sum_{M_A, m} C_{M_A m M_B}^{J_A j J_B} \langle J_B M_B | a_{jm}^\dagger | J_A M_A \rangle$$

Calculate and extract from experiment:  
TESTS MODELS. But like many quantities  
they are NOT observables.

# Example: $^{40}\text{Ca}(d,p)^{41}\text{Ca}$

*Independent-particle model:*

One neutron goes into empty single-particle states, each with  $S=1$ .

*Reality:* Residual interactions mix states; single-particle strength is fragmented over many states, each with  $S < 1$ .

*Data from Nuclear Data Sheets:*

Upper diagram contains the centroid of the experimental strength:

$$E_{\text{centroid}} = \frac{\sum_i E_i S_i}{\sum_i S_i}$$

Mixing fragments and redistributes strength; it will all be there, but you may not observe it all!

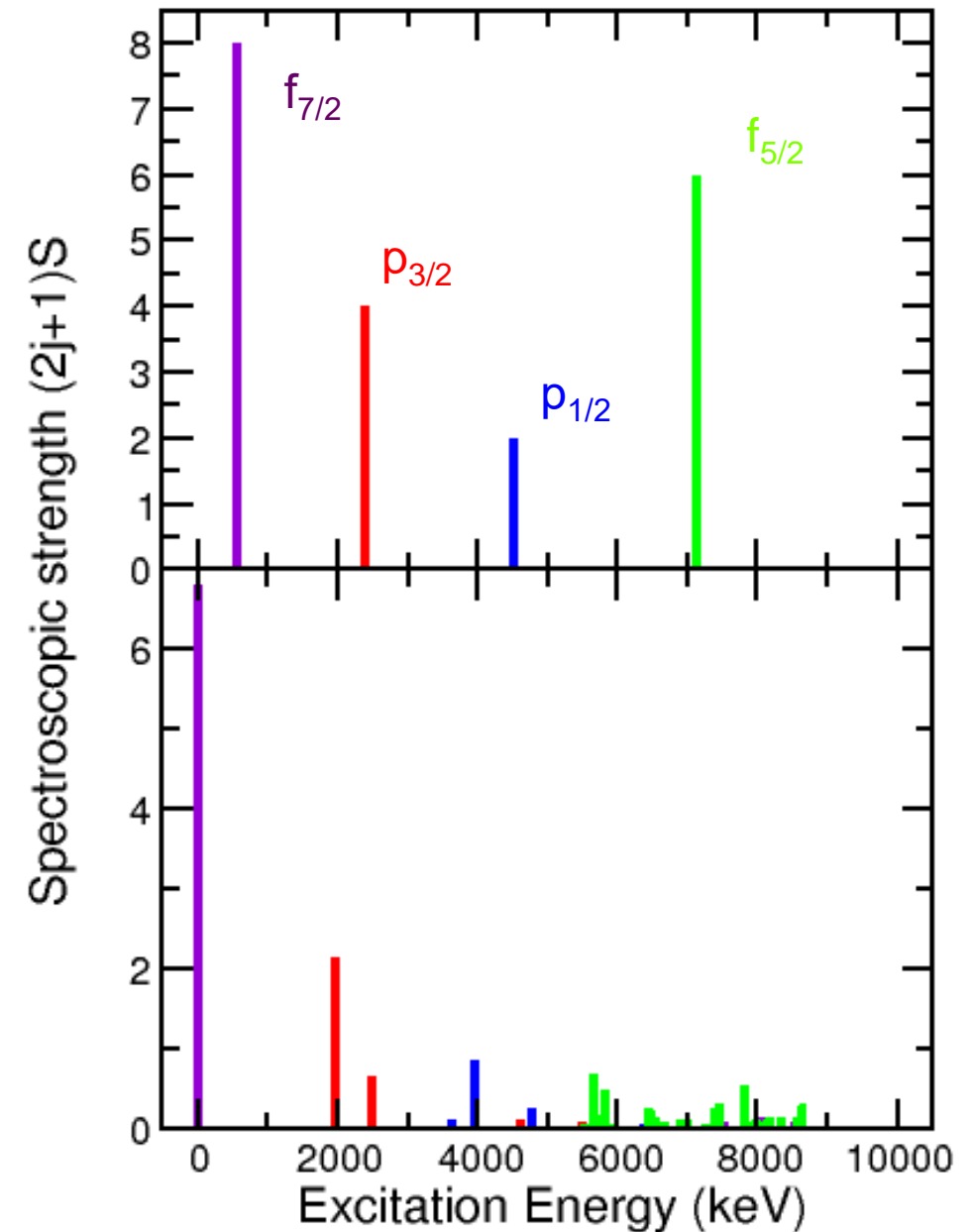

# Sum Rules (Equation-less)

If you have  $j$  orbit which is full with  $(2j+1)$  nucleons, how can you add anymore to it?

*Cross section for neutron adding = 0*

If you have  $j$  orbit which is empty,  $(2j+1)$  holes, there is nothing to remove from it!

*Cross section for neutron removing = 0*

The overall transfer strength to a particular orbital  $jl$  must be proportional to the *number of nucleons* in it for *neutron removing*, and proportional to the *number of nucleon vacancies* in it for *neutron adding*...

The transfer strength to a particular final *state* is related to its spectroscopic factor.

The transfer strength to a particular *orbital* is related to the sum of spectroscopic factors to states with the right quantum numbers,  $njl$ .

If the spectroscopic factors of each final state populated via a particular orbital  $jl$  are added up....sum rules should exist...related to orbital occupancy and vacancy.

# McFarlane and French Sum Rules

In a neutron-adding reaction,  $A(a,b)B$ , sum over all states and all possible  $J_B$  values:

$$\sum_{J_B} \frac{(2J_B + 1)}{(2J_A + 1)} S_{j\ell} = (2j + 1) - n_j(A)$$

For a spin-zero target,  $J_B=j$ :

$$\sum_i (2j + 1) S_{j\ell} = (2j + 1) - n_j(A)$$

MacFarlane and French, Rev.  
Mod. Phys. **32** 567 (1960)

*DEDUCE* occupancies and vacancies of single-particle states in the target nucleus!

In a neutron-removing reaction,  $B(b,a)A$ , sum over all states and all possible  $J_A$  values:

$$\sum_i S_{j\ell} = n_j(B)$$

For a spin-zero target,  $J_A=j$ :

$$\sum_{J_A} S_{j\ell} = n_j(B)$$

For an empty orbital, the *neutron-adding* reaction:

$$S_{max}=1.$$

For a full orbital, the *neutron-removal* reaction:

$$S_{max}=(2j+1).$$



# Cautionary Tales: DWBA

Spectroscopic factors are only as good as the DWBA calculation they are based on!

Inherent dependency on the *optical-model parameters*: often find the angular distributions are good, but cross sections vary by sizeable factors.

Strong absolute dependence on *bound-state potential*, especially the radius.

Often have to perform overall normalization of DWBA onto the data using careful methods: absolute spectroscopic factors become questionable, but relative values often quite reliable!

If possible, choose optical-model parameters fitted to elastic scattering on a range of nuclei in the vicinity - "locally global".

Energies in the region 10-15 MeV/A usually give reasonable yield whilst lowering the dependency on BS.

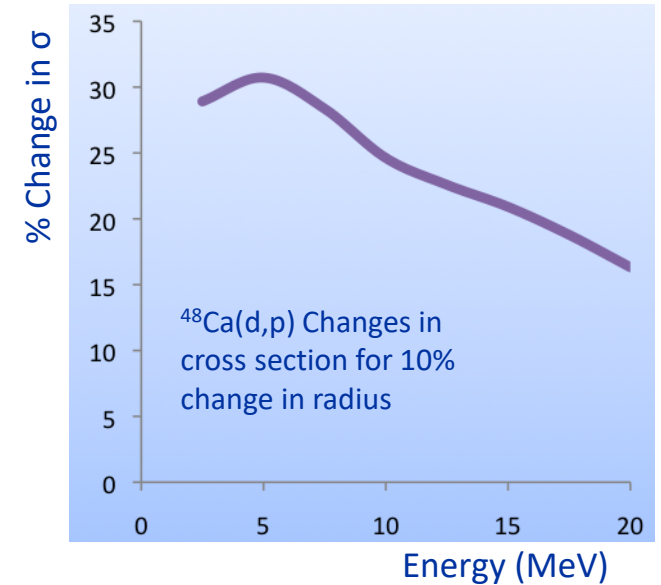

# Cautionary Tales: Mechanism

If actual reaction mechanism has significant non-direct contributions: whole edifice falls.

Reaction can go by either mechanism:  
e.g. (d,p): is proton from direct process or evaporated following fusion?

Measurements of angular distributions / energy dependence...could be checked.

Where direct cross sections are small (mismatched reactions/small  $S_{ji}$ ) multi-step contributions to observed yield can be significant.

Multi-step processes can be structurally dependent:  
e.g. Coulomb excitation in deformed systems.  
Can go “beyond” DWBA with coupled-channels calculations CCBA.

The higher the energy the less likely CN reactions are for few particles out. Energies in the region 10-15 MeV/A usually give reasonable yield, whilst lowering the contribution from multi-step processes.

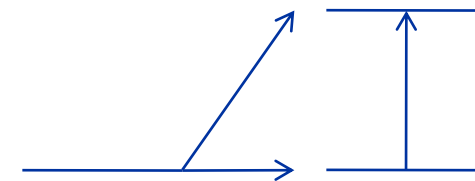

# Cautionary Tales: Physics

Is it meaningful to add up measured  $S_{jl}$  and expect them to give the single-particle limit? Won't you always miss something?

*Pragmatic answer:* the relative values do appear to obey MF sum rules, at least to within one overall normalization factor.

*Old problem, now solved:* Non-hadronic probes also sensitive to  $S_{jl}$ , but saw strong quenching in sum rules. E.g. (e,e'p) reactions only measure ~60% of the total strength; quenching not "seen" in (d,<sup>3</sup>He) until consistent BS analysis performed.

Modern nuclear structure calculations see short-range, high-momentum correlations shift single-particle strength to high energies, leaving behind only 50-60% at low energies.

Given pragmatic finding above, appears that this quenching somewhat similar for all valence orbitals.

Independent analyses

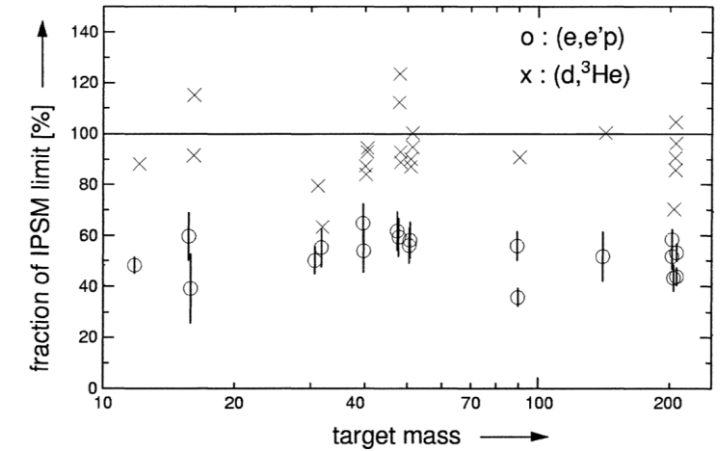

Consistent DWBA

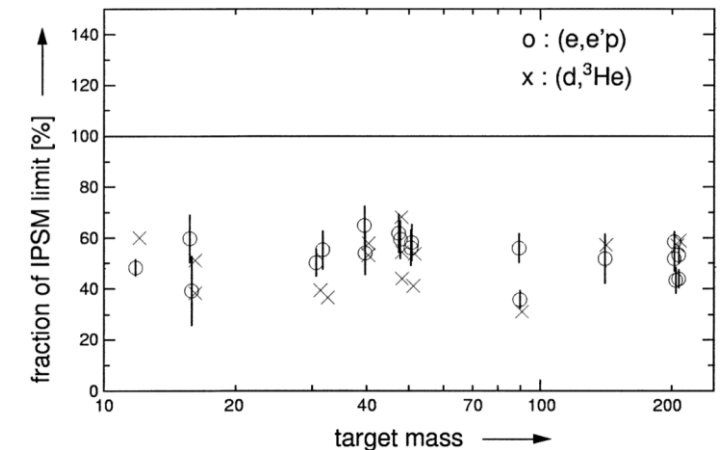

Kramer *et al.* NPA **679** 267 (2001)

# Cautionary Tales: Physics

Other reactions face similar troubles – e.g. knockout on “composite” nucleon targets.

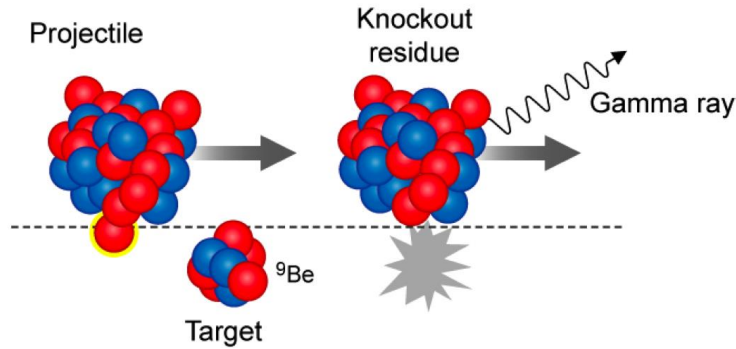

High energy beams >50 MeV/A.  
Thick targets, strong forward focusing, and essentially background-free event-by-event tracking.

Theoretical advantages using reaction models based on the sudden and the eikonal approximations.

Longitudinal momentum distribution indicates orbital angular momentum of the removed nucleon  
Cross section of the one neutron knockout process allows spectroscopic factors to be deduced.

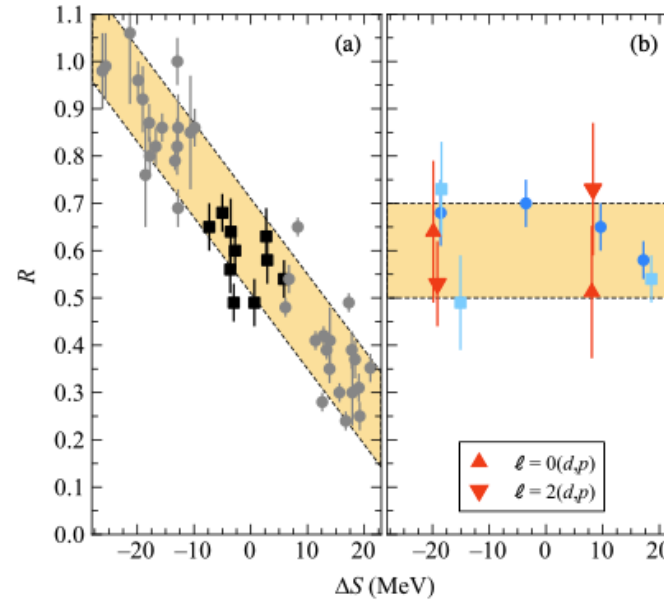

FIG. 1. (a) Degree of quenching  $R$ , as a function of  $\Delta S$  deduced from  $(e,e'p)$  reactions [3] (black squares) and from knockout reactions on  ${}^9\text{Be}$  and  ${}^{12}\text{C}$  targets (gray circles)—data and shaded band from Ref. [5], compared with (b) results from the current measurement (red triangles) and previous neutron- and proton-removing transfer reaction study of Ref. [7] (blue squares) and the  $(p,2p)$  study [8] (blue circles). The shaded band,  $R = 0.6(1)$ , (b) is to guide the eye. The  $(e,e'p)$  and  $(p,2p)$  measurements are compared to the independent single-particle model and the results, including the present Letter, to the shell model.

Kay *et al.* PRL **129** 152501 (2022)

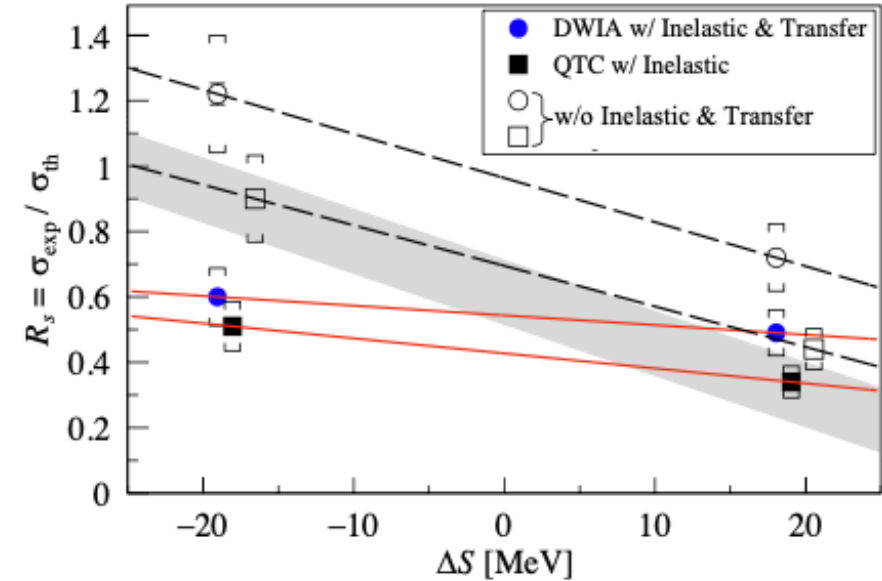

FIG. 3.  $R_s$  as a function of  $\Delta S$  from the present work (blue dots and black squares) compared to the trend extracted from Be or C induced nucleon-removal cross sections analysed with the eikonal model [19–21] (grey shaded region). The square brackets indicate the total systematic uncertainties. Red solid and black dashed lines are shown to guide the eyes.

Pohl *et al.* PRL **130** 172501 (2023)

# Pause for thought:

- Direct reactions – single step – present a useful tool for probing the structure of nuclei.
- Transfer reactions are just one well-studied example.
- Inelastic scattering, pair transfer, cluster transfer...
- Generally – angular distributions give orbital ang mom and cross section can tell you structural information – but always dependent on reaction model to a greater or lesser extent.
- Total spin assignments you need to work harder – or use model dependent assumptions.
- Sum rules can help you – if you are confident of the absolute scales.
- But you need to be assured that the reaction is proceeding via the mechanism that your reaction model assumes!
- You can help this by choosing the reaction and experimental conditions appropriately – but you need to be very careful!
- Given the model-dependencies, using different reactions to probe the same phenomena can be useful.

## PART 3: Doing Experiments



# Experimental Philosophy

Measure: differential cross section,  $d\sigma/d\Omega$ , as a function of angle for population of the state of interest by the reaction  $A(a,b)B$ :

$$\frac{d\sigma}{d\Omega} = \frac{\text{Yield per sec}}{nJ\Delta\Omega}$$

*Yield*: Measure either b or B or both in a detector. Detection resolution, efficiency and solid angle are important.

*Detectors/spectrometers*: count, identify, measure energy and/or momentum of products.

*Incident flux J*:

Count incoming/outgoing beam particles using tracking detectors, or measure total charge dumped after target using Faraday cup.

*Target*:

$n$  is number of target atoms  
Energy losses, straggling and uniformity set limit on energy resolutions. Look for changes in target using monitor detectors.

*Calibration*: Many factors can be obtained by empirical calibration using a process with known cross section:  
E.g. elastic scattering in Rutherford regime or robust optical model.

Rate and beam intensity/quality/species/stability determine much of experimental setup, e.g. whether to track or use collimators and FC, measure b and/or B.

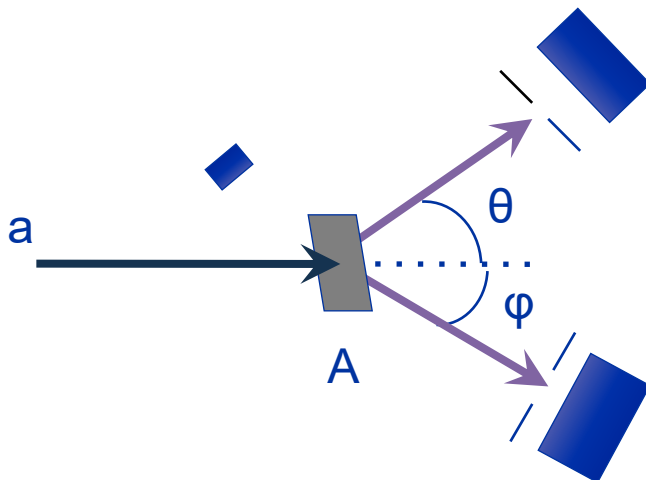

# Get a Feeling for Kinematics

For theorists, use of the CM frame of reference allows the trivial motion of the centre of mass to be factored out, reducing a six-dimensional Schrodinger equation to three relative coordinates...

BUT experimenters live in the laboratory frame!

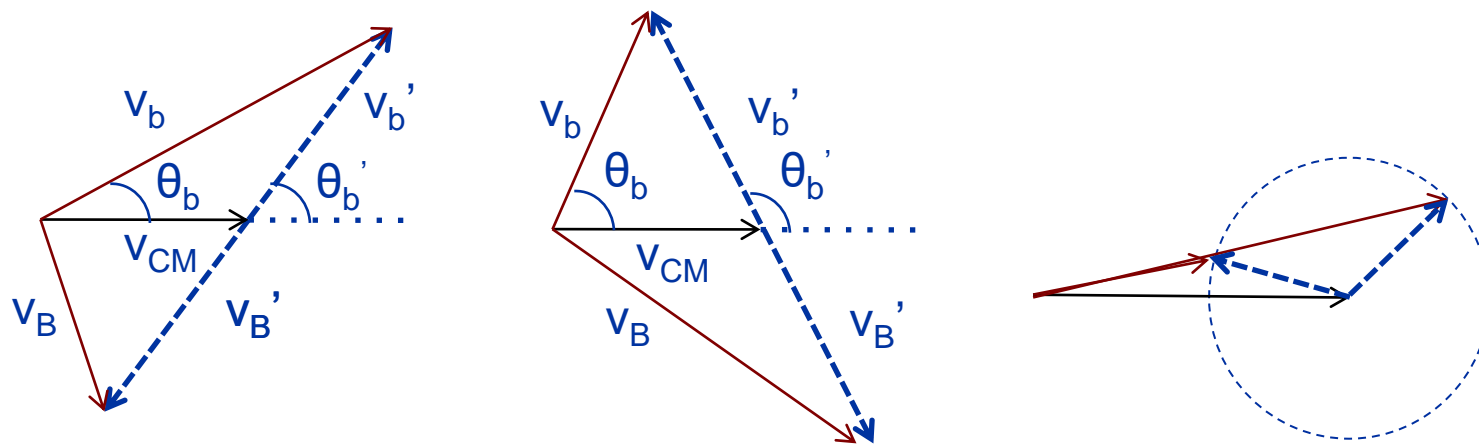

$$E_{CM} = E_{lab} \frac{m_p}{(m_p + m_t)}$$

$$E_{rel} = E_{lab} \frac{m_t}{(m_p + m_t)}$$

Energies and angles in LAB and CM are different.

Despite same velocity in CM, LAB velocity changes with angle; resolution implications.

*Kinematic shift:*  $\kappa = \frac{1}{p} \frac{dp}{d\theta}$

CM angle changes faster than LAB angle, solid angles differ.

*Jacobian:*  $\frac{d\Omega_{LAB}}{d\Omega_{CM}}$

For large  $v_{CM}$ , one LAB angle, two CM angles with two energies!

Higher  $v_{CM}$  the bigger the problems.

# Historical aside

(i) Early Years: discoveries of radioactivity, nucleus, nuclear reactions, protons and neutrons, isotopes – using mainly decay.

(ii) Neutrons: from reactions initiated by radioactivity, then fission, then accelerators.

(iii) Light-ion accelerators: explosion of small machines for protons, deuterons and alphas for elastic/inelastic scattering, compound nucleus, transfer, with increasing energy allows spallation etc.

*“Normal” kinematics: light ion beams on stable heavy targets  $v_{cm}$  quite modest.*

(iv) Heavy-ion accelerators: Coulomb excitation, fusion evaporation, with increasing energy projectile fragmentation

(v) Radioactive ion beam facilities: early work on spallation and fragmentation harnessed for production of beams of exotic nuclei used to induce secondary nuclear reactions.

*“Inverse” kinematics: heavy radioactive ion beams on stable light targets.  $v_{cm}$  very large.*

from “The Discovery of Isotopes” Michael Thoennessen

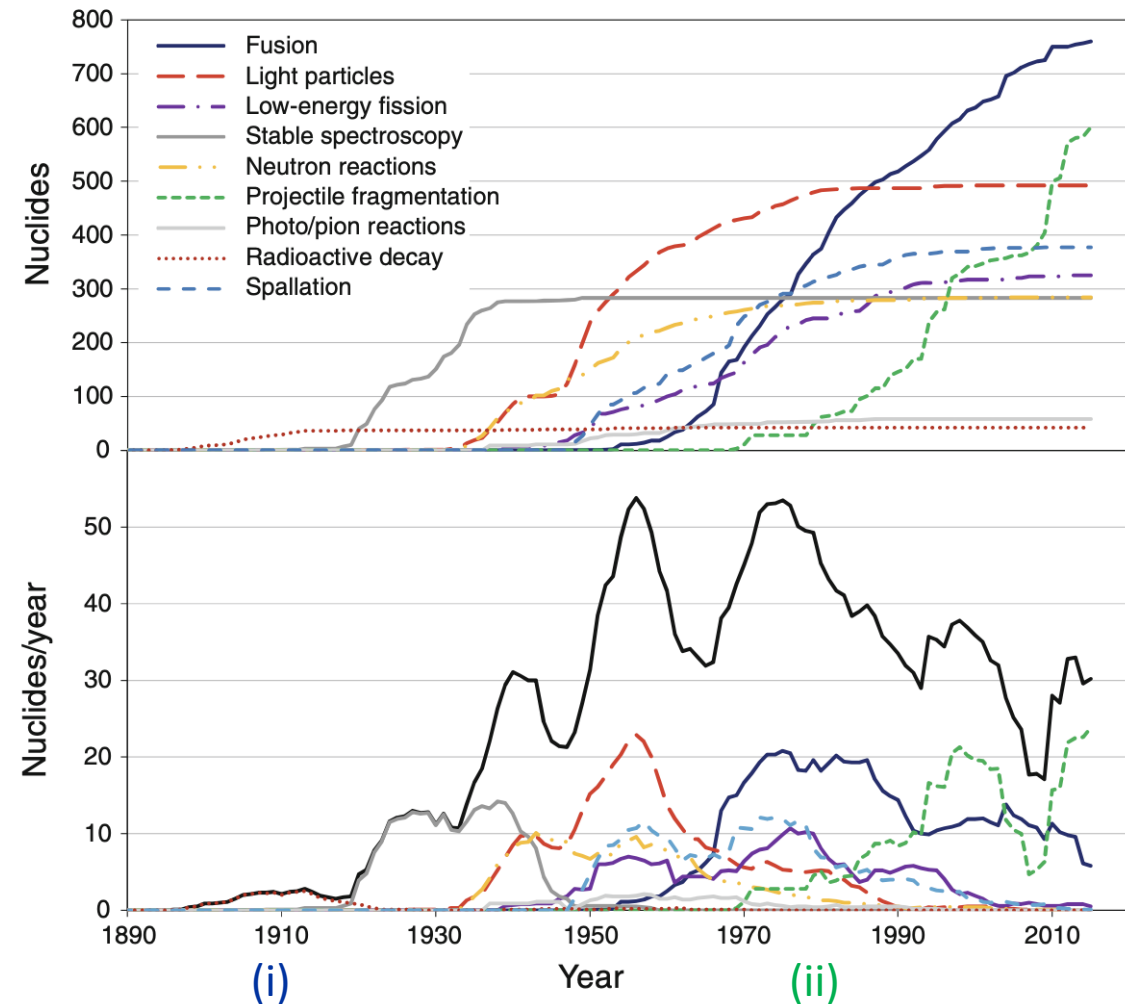

(i)

Year

(ii)

(iii)

(iv)

(v)

# Normal Kinematics: Inverse Kinematics

In CM, transfer cross section is high at small scattering angles for light partner (forward peaking):

**Dotted lines:** CM velocities  
**Solid Lines:** LAB velocities **Black:**  $v_{cm}$   
**Green:** heavy partner **Blue:** light partner

Physics is usually at small CM angles

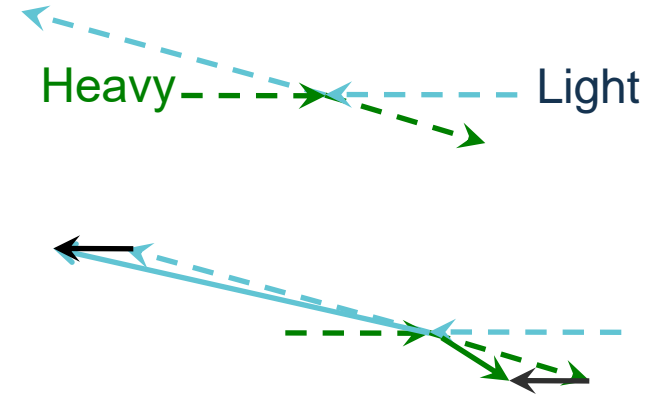

In LAB, for “normal” kinematics (light projectile on heavy target,  $v_{cm}$  small – so beam going right to left) transfer cross section is high for light particle at small scattering angles.

In LAB, for “inverse” kinematics (heavy projectile on light target,  $v_{cm}$  large – beam going left to right) the peak of the transfer yield depends on the relative lengths of CM velocity vectors and  $v_{cm}$ .

For low  $Q$  value reactions, sizes of CM velocity vectors largely dependent on mass transfer:

(d,p) proton  
 highest yield  
 backward in LAB.

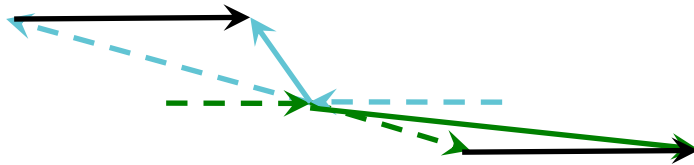

(d,t) triton  
 highest yield  
 forward in LAB.

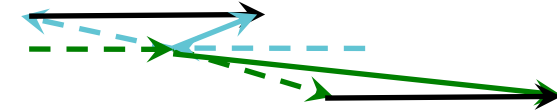

Inverse kinematics is a strange un-real world...be careful with kinematics calculations.  
 NB: Scattering angle is conventionally taken to be that of the projectile...which is different in inverse/normal kinematics.

# Reconstructing Q values by LAB $\Rightarrow$ CM Transformations

LAB velocity of outgoing particles populating the same state varies with angle.

Kinematic shift often limits ion-energy resolution of detector at a certain scattering angle with finite acceptance.

Variation of kinematic shift with angle is different for different ion energies, which dictates the separation of different excited states.

BOTH effect the resolution obtained in a Q-value or excitation energy spectrum.

Exacerbated for inverse kinematics – measurements of just ion energy or momenta at a fixed angle yield poor Q value resolutions (100's keV).

Need new techniques!

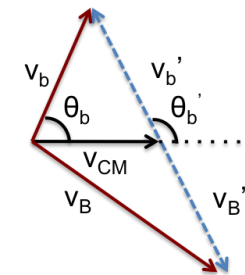
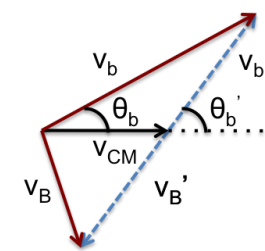
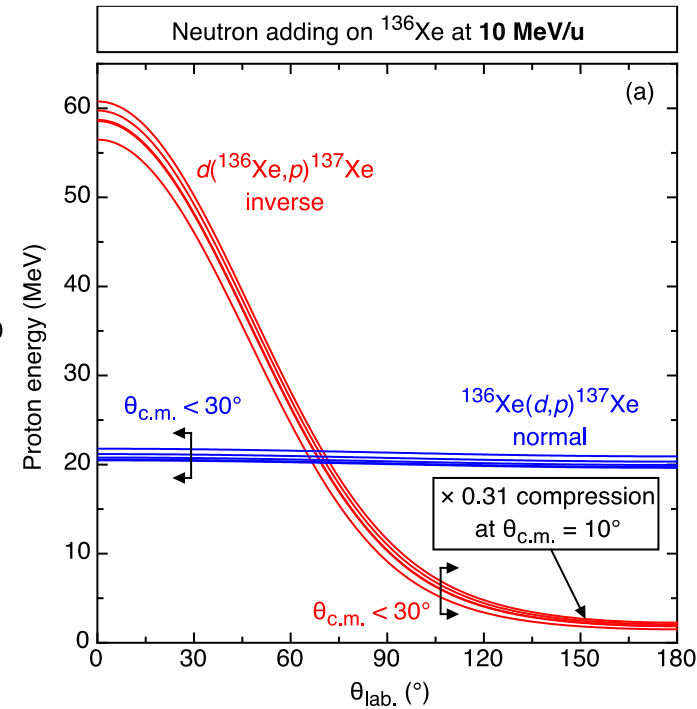
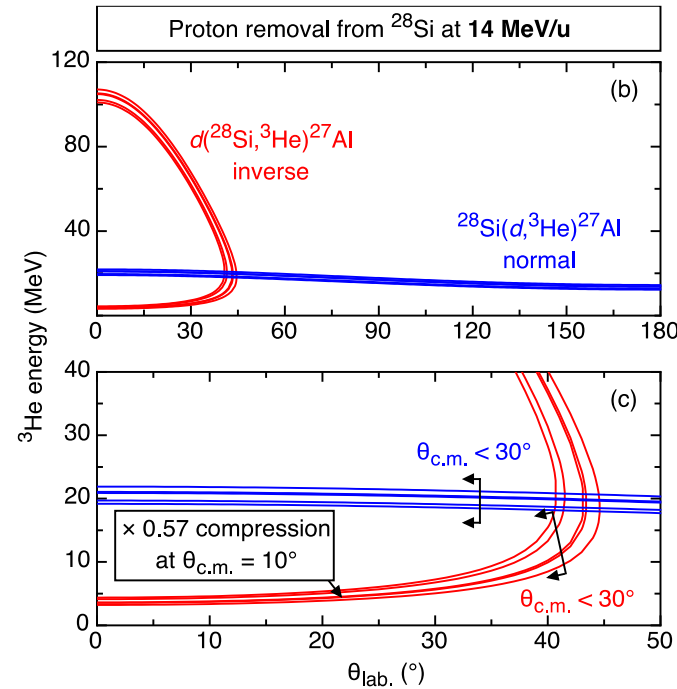

$$\kappa = \frac{1}{p} \frac{dp}{d\theta}$$



# Classical solution 1: Magnetic analysis *in normal kinematics*

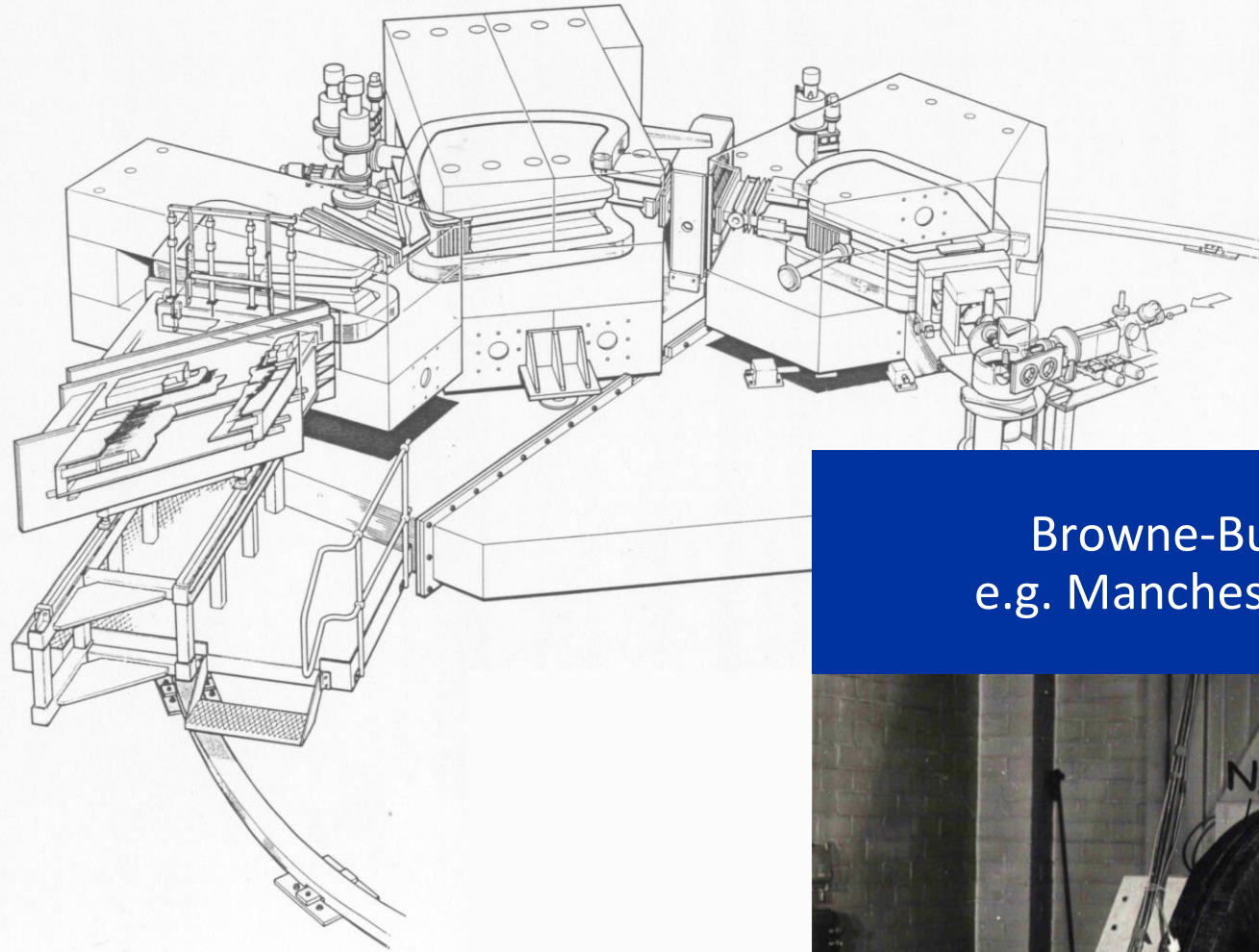

Browne-Buckner  
e.g. Manchester 1955

Dispersion in  $p$  along a focal plane, measuring position followed by  $\Delta E-E$ .

Quickly lose the fight to increase acceptance whilst still correct kinematic shift and minimise introducing optical aberration.

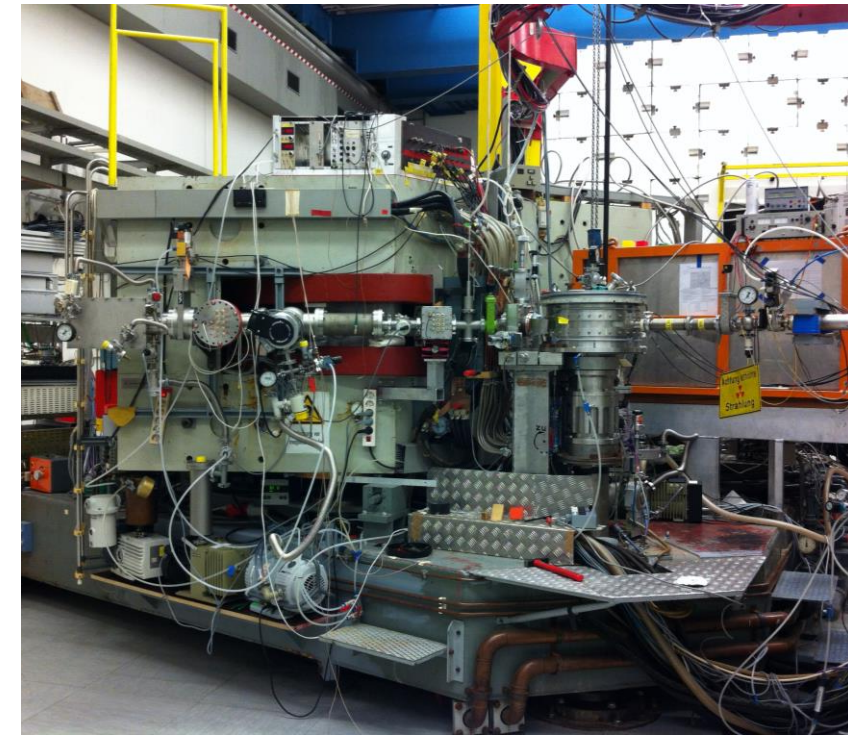
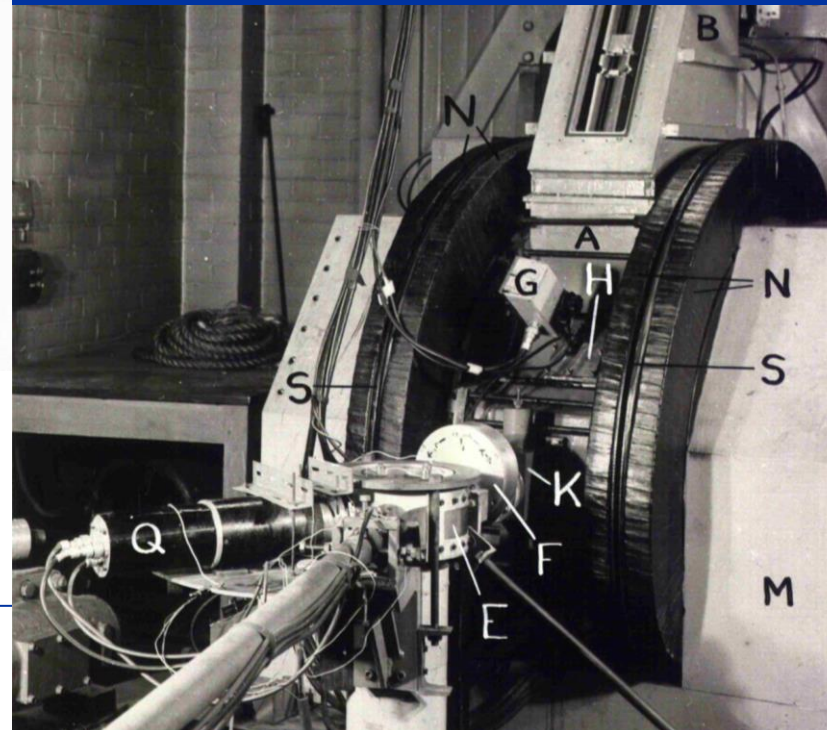

Split-pole, Q3D, QMG2, etc  
e.g. Munich Q3D



# Example: tensor monopole shifts in Sb revealed by Sn( $\alpha$ ,t)

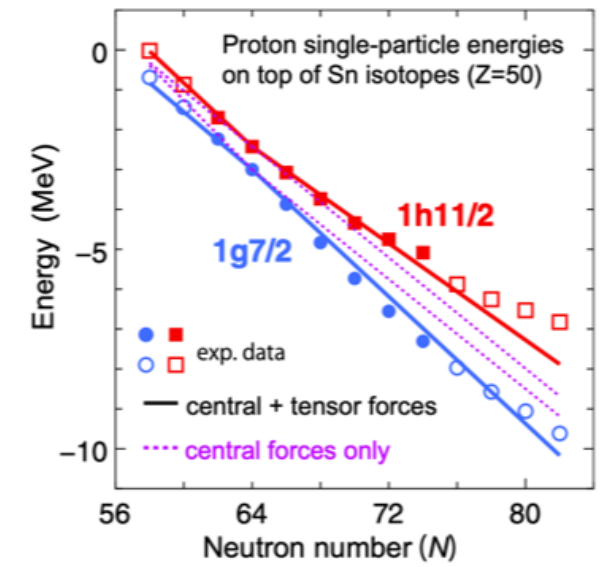
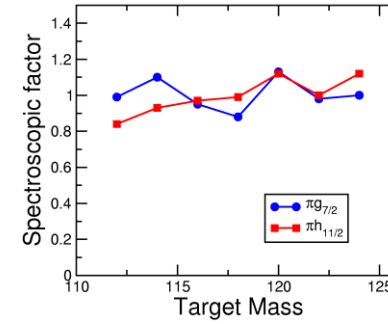
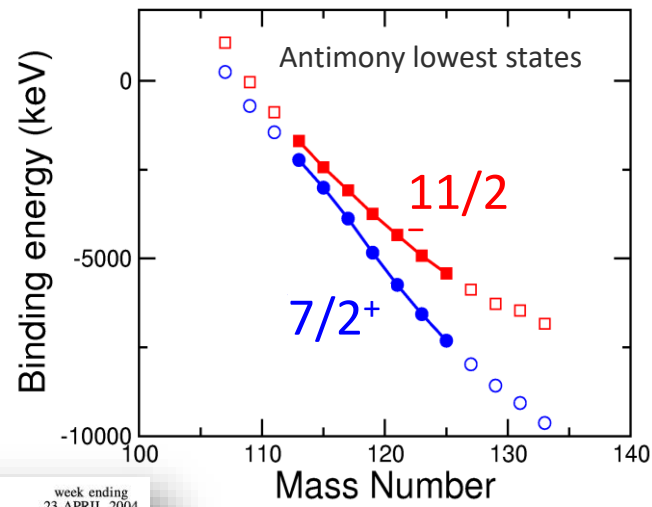

Actually the tensor force in action!

VOLUME 92, NUMBER 16      PHYSICAL REVIEW LETTERS      week ending 23 APRIL 2004

**Is the Nuclear Spin-Orbit Interaction Changing with Neutron Excess?**

J. P. Schiffer,<sup>1</sup> S. J. Freeman,<sup>1,2</sup> J. A. Caggiano,<sup>3</sup> C. Deibel,<sup>3</sup> A. Heinz,<sup>3</sup> C.-L. Jiang,<sup>1</sup> R. Lewis,<sup>3</sup> A. Parikh,<sup>3</sup> P. D. Parker,<sup>3</sup> K. E. Rehm,<sup>1</sup> S. Sinha,<sup>1</sup> and J. S. Thomas<sup>4</sup>

<sup>1</sup>Physics Division, Argonne National Laboratory, Argonne, Illinois 60439, USA  
<sup>2</sup>University of Manchester, Manchester M13 9PL, United Kingdom  
<sup>3</sup>Yale University, New Haven, Connecticut 06520, USA  
<sup>4</sup>Rutgers University, Piscataway, New Jersey 08854, USA  
 (Received 17 December 2003; published 20 April 2004)

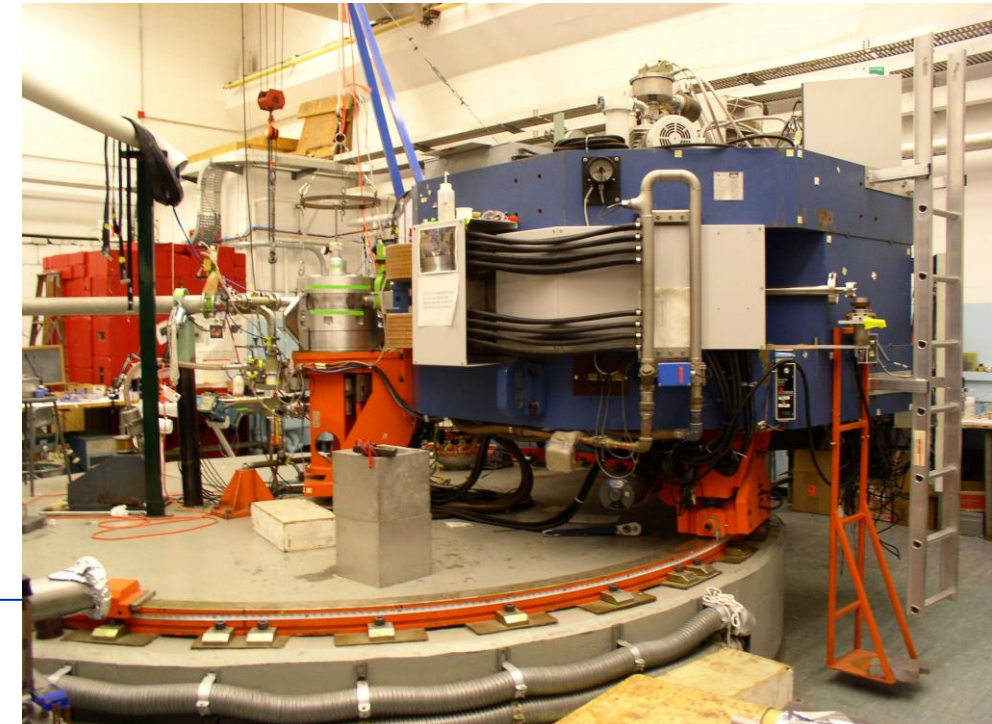
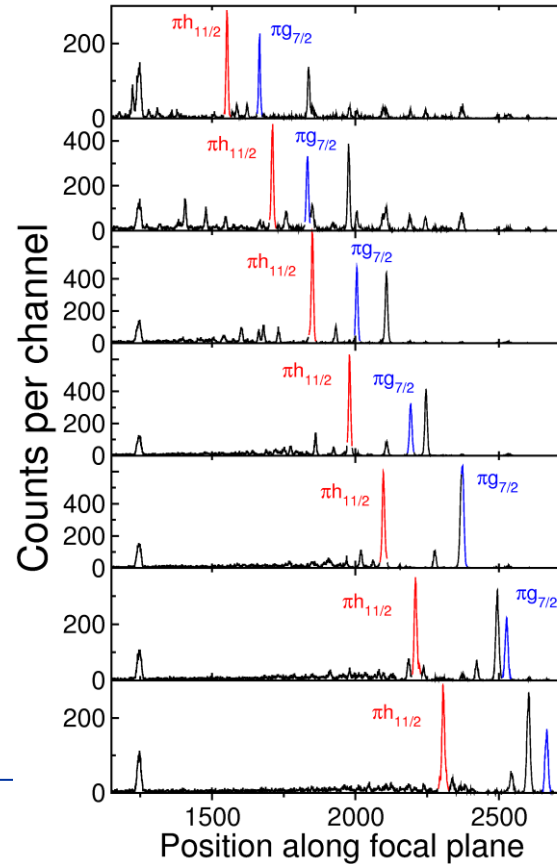
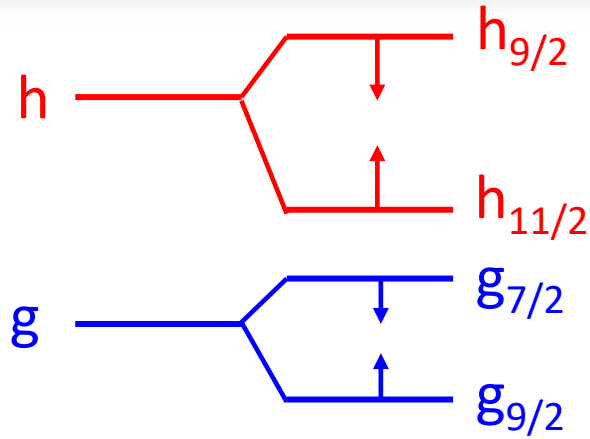

# Classical solution 2: Direct particle-energy detection

Improvements in large area segmented detectors, but with increasing complexity in readout.



Si surface barrier

Si strip detectors

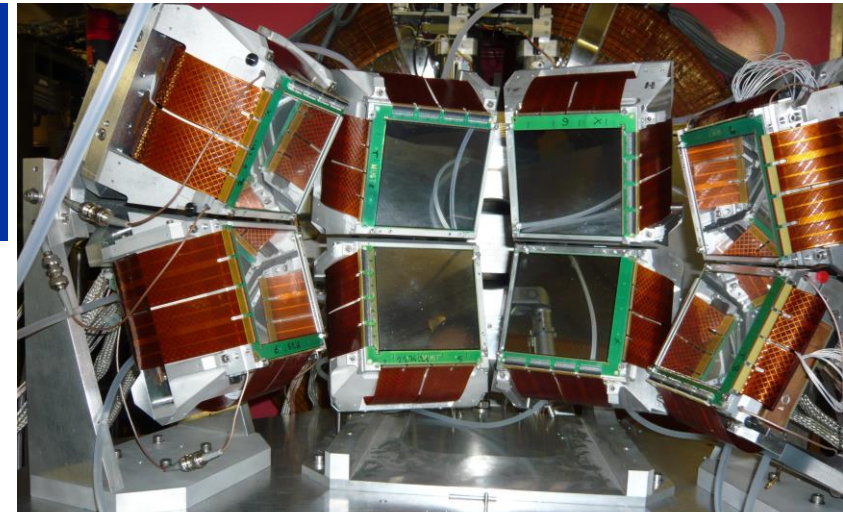

Composite Si, Si(Li), CsI, ion  
chambers  
e.g. MUST2



# Particle- $\gamma$ coincidences

— if the state decays radiatively inside the  $\gamma$  array...  
*but ground states and isomers longer than few tens of ns don't!*

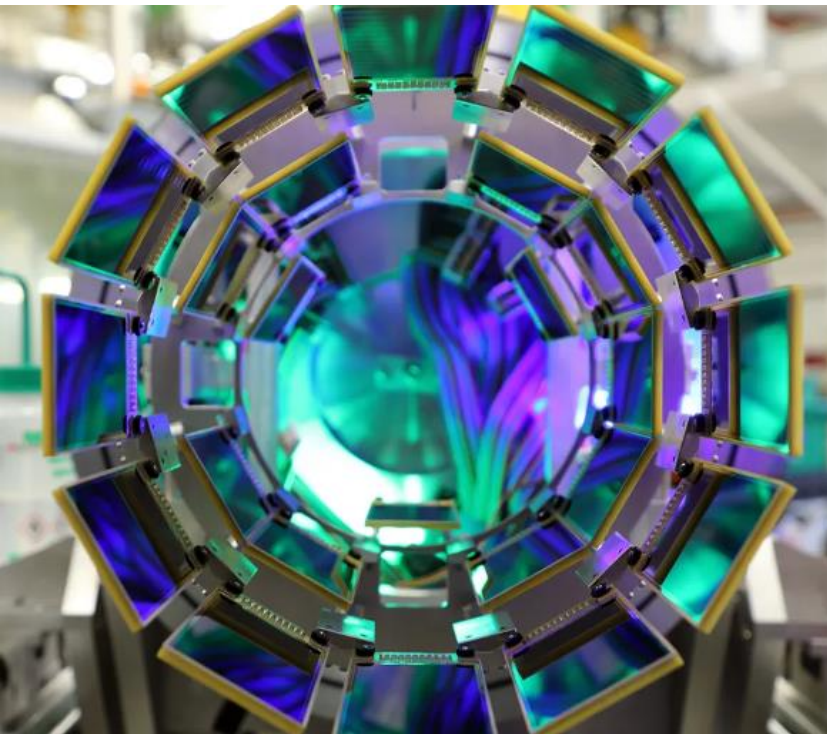

ORRUBA+GRETA @ FRIB

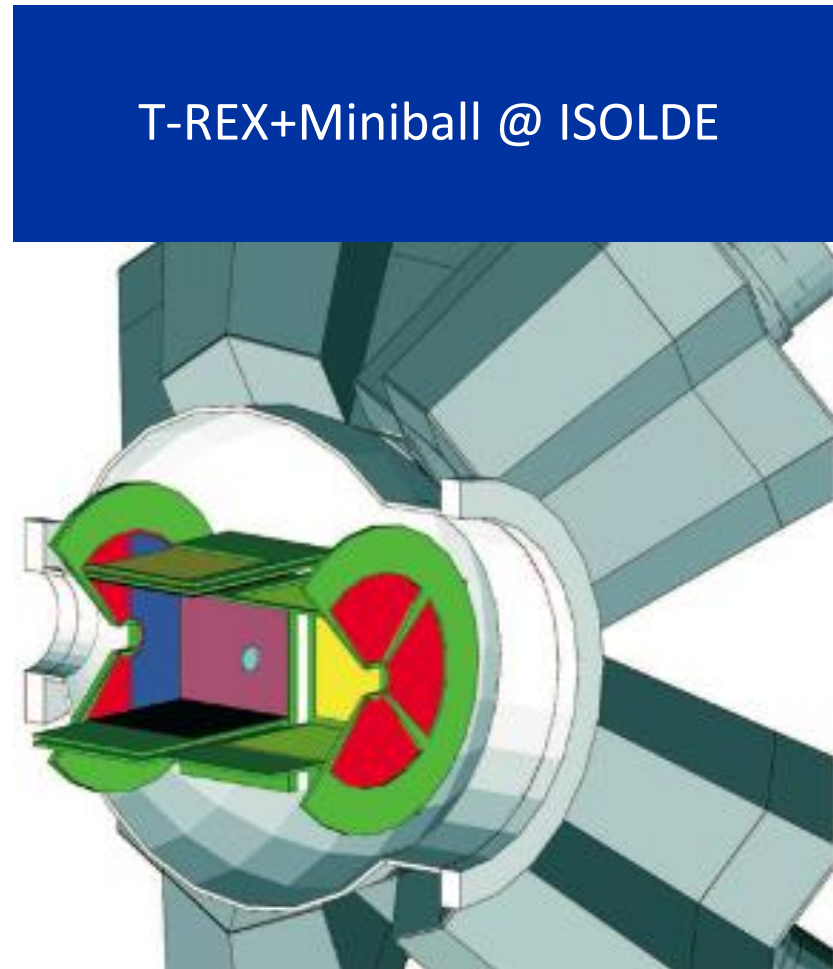

T-REX+Miniball @ ISOLDE

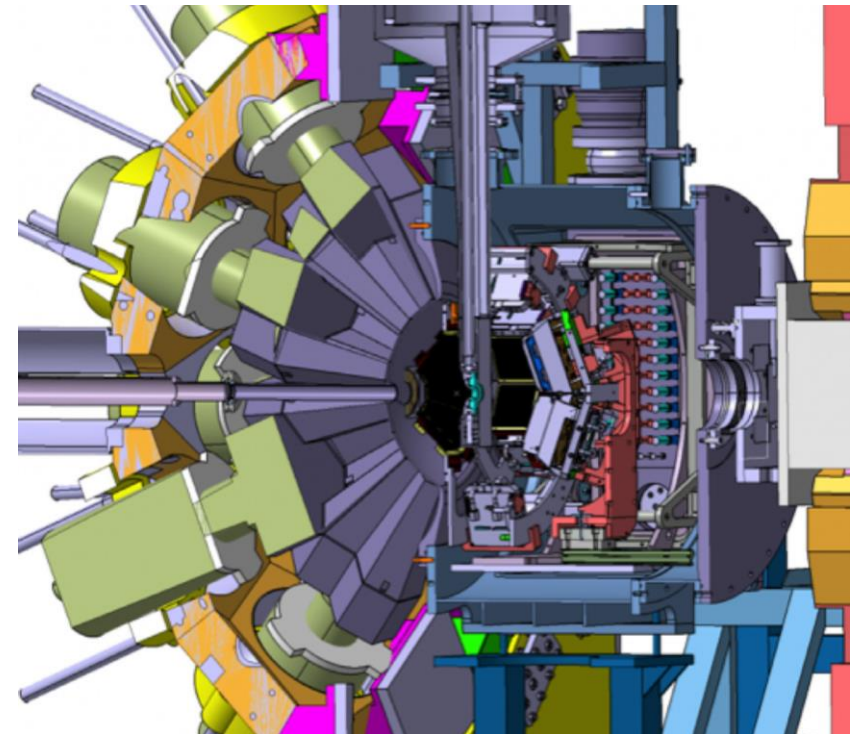

MUGAST+AGATA+VAMOS  
@ GANIL

# Silicon Array Design Criteria.

## ENERGY RESOLUTION and THRESHOLD

- resolving high density of excited states.
- good ion energy resolution mitigates the effect of compression of different excited states from differential kinematic shift.
- threshold imposes limitations on angular and excitation energy coverage.

## ANGULAR COVERAGE

- overall efficiency.
- particle angular distributions.

## ANGULAR RESOLUTION

- one of the limiting factors in energy resolution via kinematic shift.
- required for good angular distributions.
- required for gamma-ray Doppler correction.

## PARTICLE IDENTIFICATION

- natural preference in kinematics (maybe for (d,p))?
- recoil measurement (non-unique)?
- gamma-ray coincidences?
- $E\Delta E$  (imposes further reductions on energy resolution and threshold)?
- new technologies looking at particle id from the pulse shapes?

Variants:  $E\Delta E$  telescopes, CsI, gammas, spectrometers, ASIC readouts....

Good coverage in solid angle.  
But many channels in electronics and DAQ.

Gamma detectors easy: resolution for state energies and identifying multiplets.

Q-Value spectra: resolving power limited by kinematic shift and target effects .

Particle-gamma spectra; resolving power is good, but efficiency hit; for absolute yields need to know absolute efficiency; watch out for p- $\gamma$  angular correlation effects.

# Example: single-neutron transfer on $^{23}\text{Ne}$

- Resonances in  $^{24}\text{Al}$  important for  $^{23}\text{Al}(p,\gamma)$  astrophysical reactions that occur in Type-I X-ray bursters.
- Can't easily study  $^{24}\text{Al}$  – so probe the mirror nucleus  $^{24}\text{Ne}$ .
- TRIUMF:  $2 \times 10^4$  pps @ 8 MeV/u on  $1 \text{ mg cm}^{-2} \text{ CD}_2$ .
- Prompt  $\gamma$ -rays in 12 Compton-suppressed Ge detectors (TIGRESS).
- Charged-particles in SHARC – two "boxes" of DSSD's.

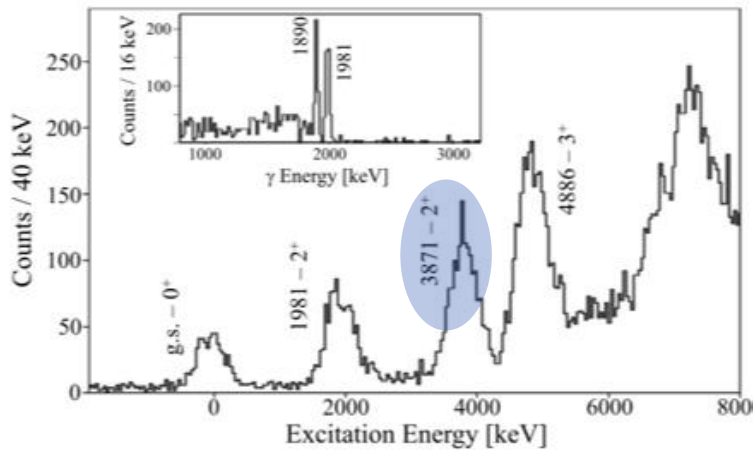
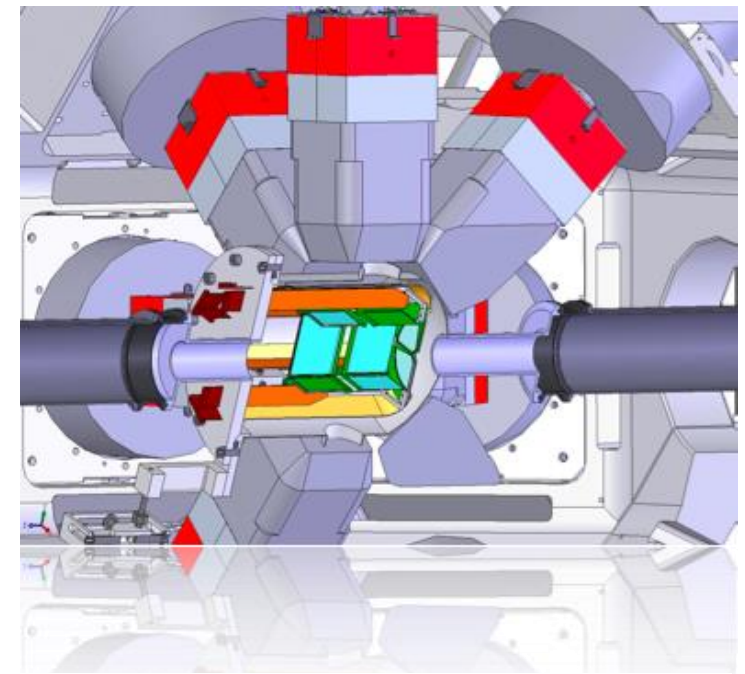

- Excitation resolution around 300 keV.
- Expectation of additional states in the region above 3 MeV – are these peaks doublets?
- Use coincident  $\gamma$  rays to put limits on contributions from unresolved peaks.
- Estimates errors on absolute SF are 20% (reaction models) and assume states in  $^{24}\text{Al}$  identical.
- Uncertainty in contribution from particular resonance in  $^{23}\text{Al}(p,\gamma)$  reduced by factor 4.

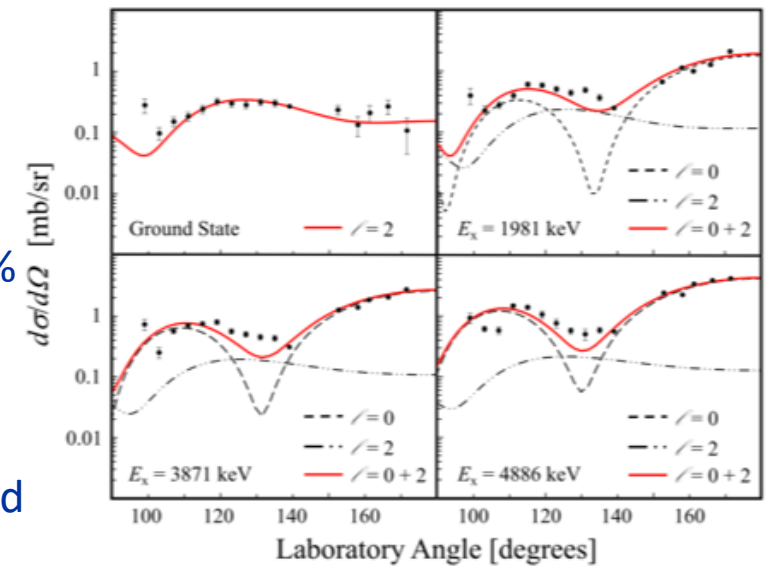



# Solenoidal Spectrometers

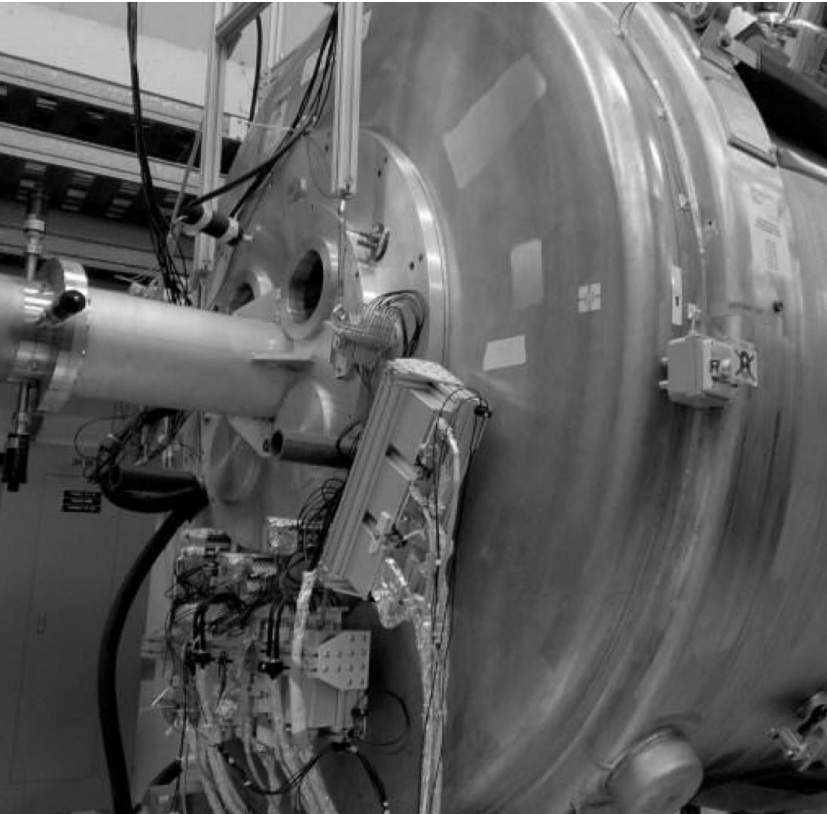

HELIOS @ Argonne

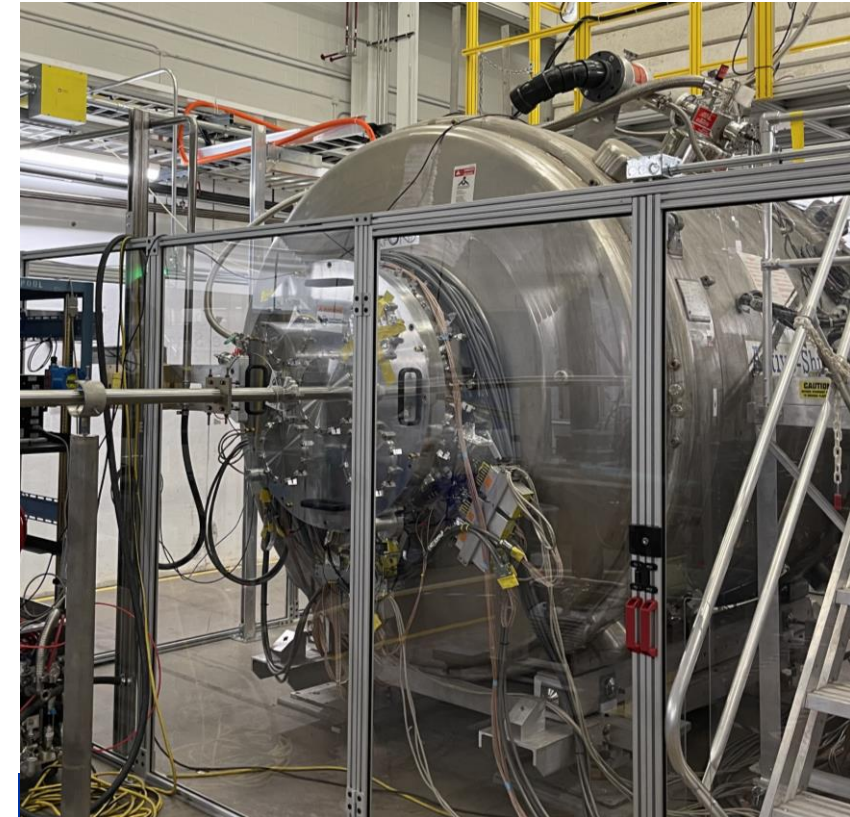
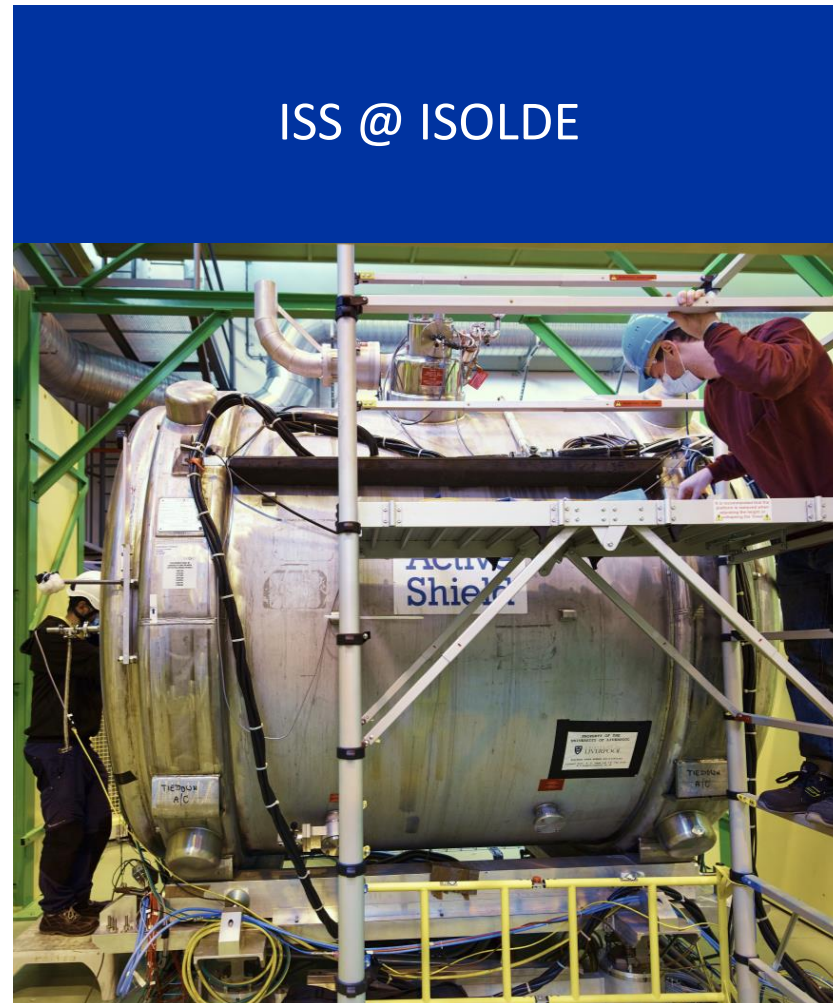

SOLARIS  
@ FRIB



# Solenoidal Spectrometer Concept

- Particles from target follow helical orbits, returning to the axis after one cyclotron period.
- Dispersive along axis according to parallel velocity component in LAB.
- Measure light ejectiles in hollow position-sensitive array.

Measured Quantities:

- position  $z$
- lab particle energy  $E_{\text{lab}}$
- cyclotron period  $T_{\text{cyc}}$

Particle ID:  $T_{\text{cyc}} = \frac{2\pi m}{B qe}$  or infer from recoil.

CM Energy:  $E_{\text{cm}} = E_{\text{lab}} + \frac{mV_{\text{cm}}^2}{2} - \frac{mzV_{\text{cm}}}{T_{\text{cyc}}}$

CM Angle:  $\cos \theta_{\text{cm}} = \frac{v_{\text{lab}}^2 - V_{\text{cm}}^2 - v_0^2}{2v_0 V_{\text{cm}}}$

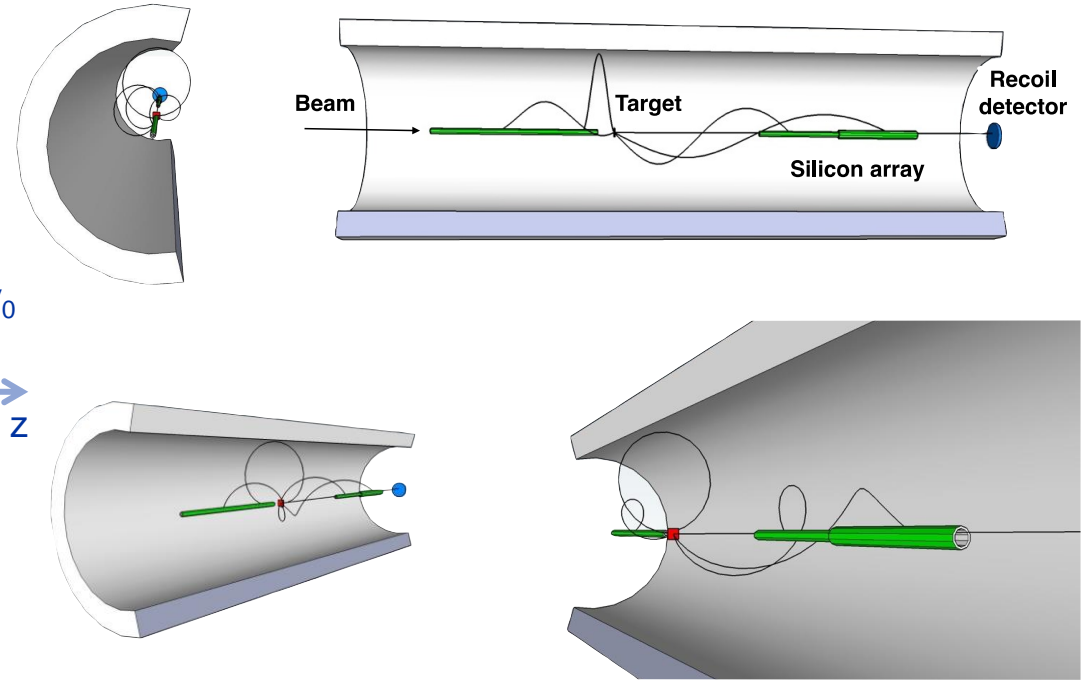

# An example – $d(^{132}\text{Sn},p)$ @ 8 MeV/u

$$E_{\text{cm}} = E_{\text{lab}} + \frac{mV_{\text{cm}}^2}{2} - \frac{mzV_{\text{cm}}}{T_{\text{cyc}}}$$

For a particular  $E^*$ , different CM angles have different parallel components of lab velocity leading to different  $z$ .

For a particular  $z$ , energies in CM and ion energies in LAB related by an additive offset – but expression is linear in  $z$ .

Eliminates kinematic compression in excitation energy spectra; spacing of energies in CM is the same as ion energies in LAB.

The equivalent of kinematic shift  $dE/dz$  gives only small contribution via position resolution ( $\sim 15$  keV in this example).

Good acceptance for geometries imposed by a “cheap” second-hand hospital MRI magnets.

When target effects dominate ion-energy resolution, Q-value spectrum still benefits from the lack of compression.

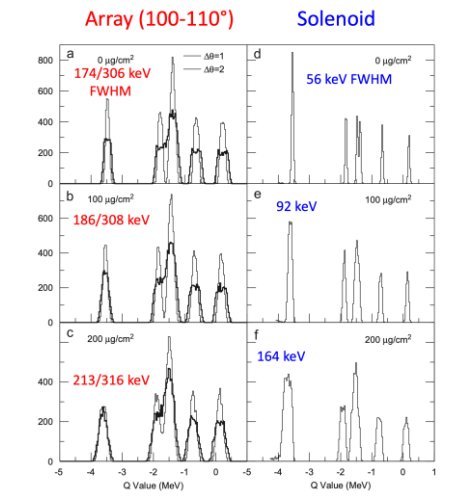
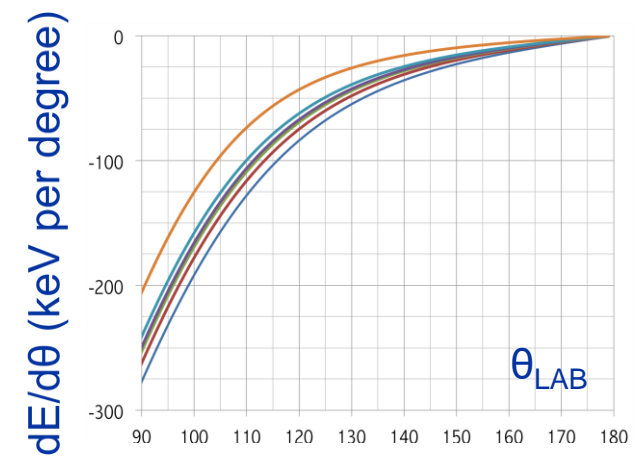
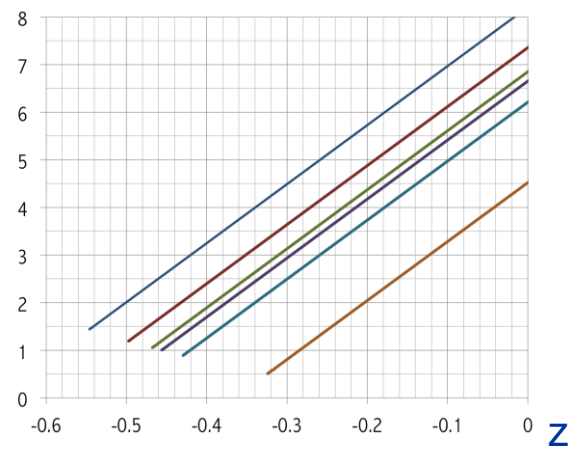
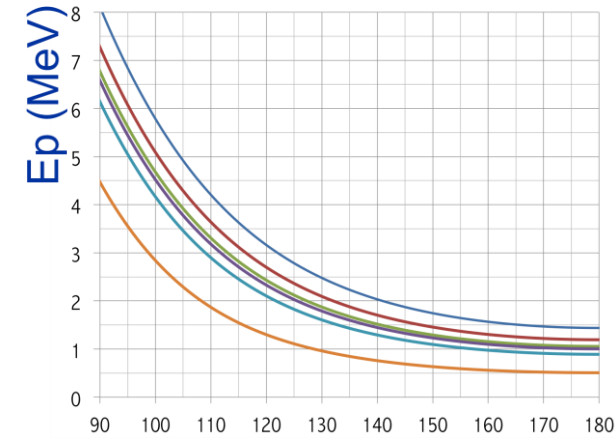
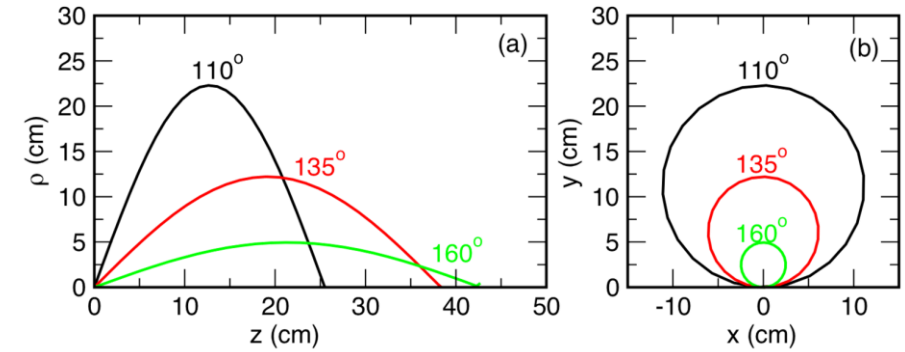

# An example – $d(^{132}\text{Sn},p)$

Silicon array @ 4.77 MeV/u.

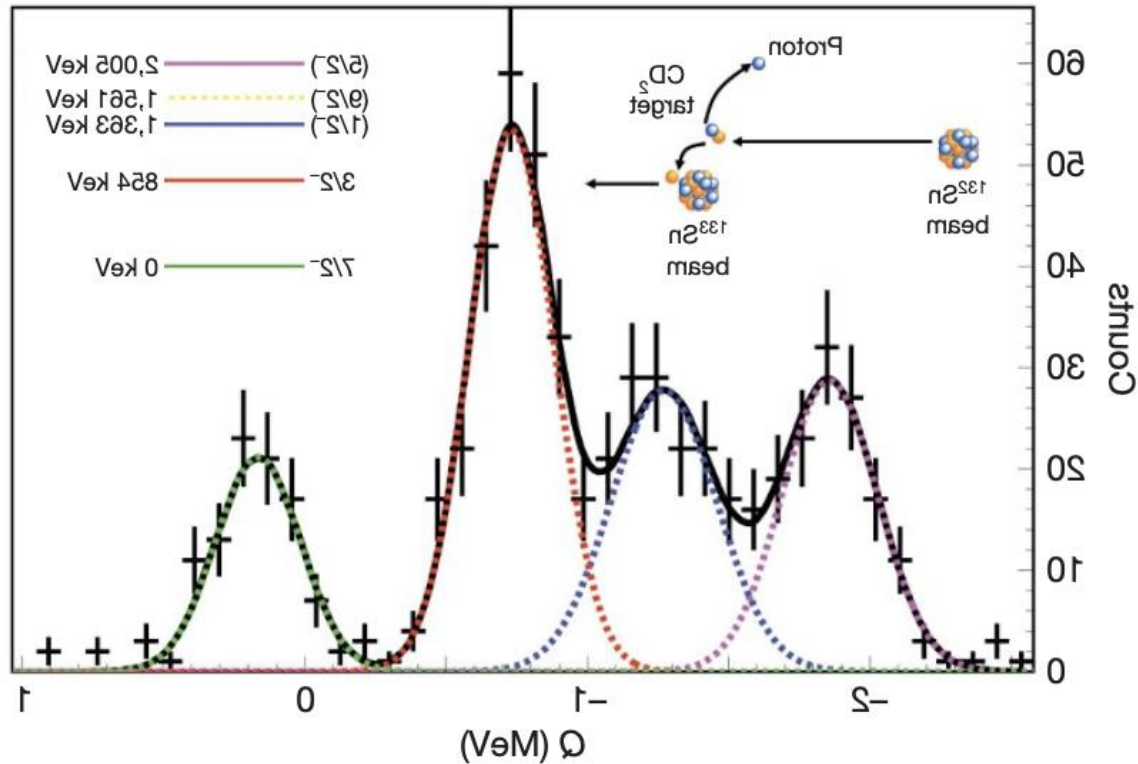

Solenoidal spectrometer @ 7.65 MeV/u: around 150 keV resolution.

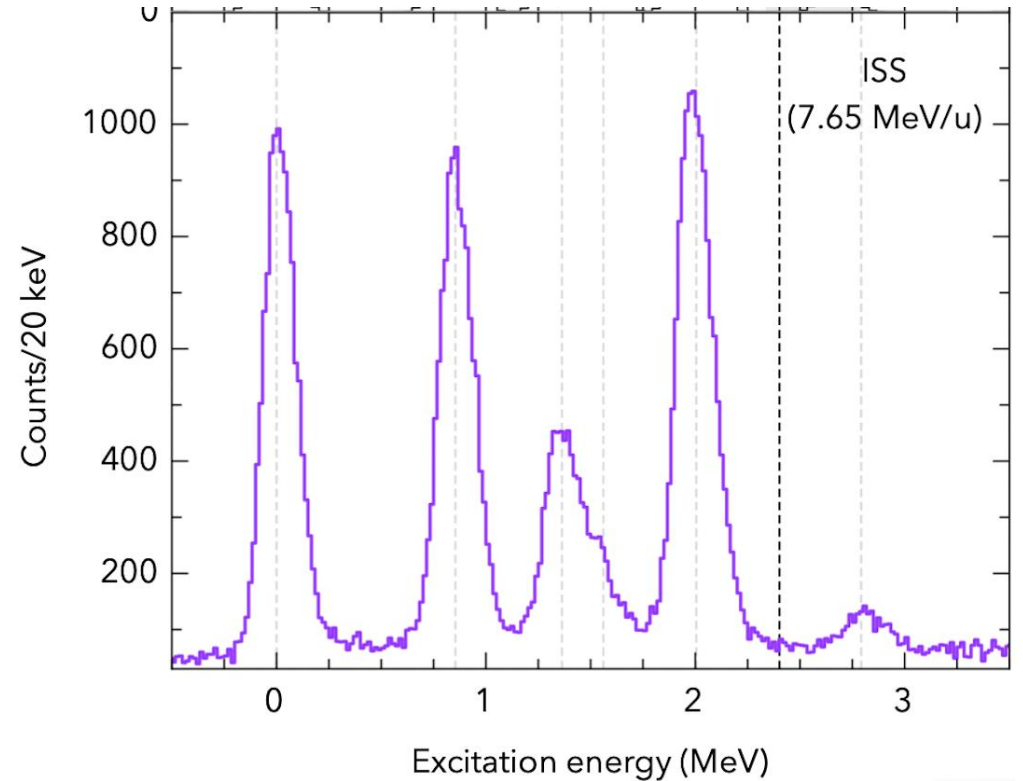

# Example - single-particle states along N=126, $^{212}\text{Rn}(d,p)^{213}\text{Rn}$ .

Radioactive  $^{212}\text{Rn}$  beam from HIE-ISOLDE @7.63 MeV/u – 1.4 GeV protons on thick U carbide target.

CD<sub>2</sub> target in the ISOLDE Solenoidal spectrometer

~5x10<sup>6</sup> pps  $^{212}\text{Rn}$  array singles, 125μg/cm<sup>2</sup>, 140-keV FWHM.

Background mainly from α decay of beam – EBIS on/EBIS off subtraction.

Reconstruct excitation energy and find ~24 states identified up to 5 MeV, predominately ℓ=2 and 4 strength.

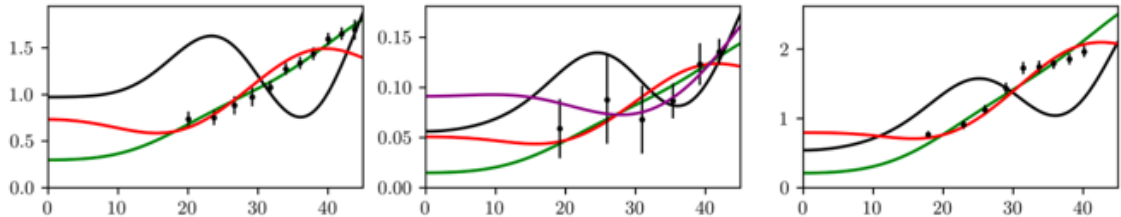
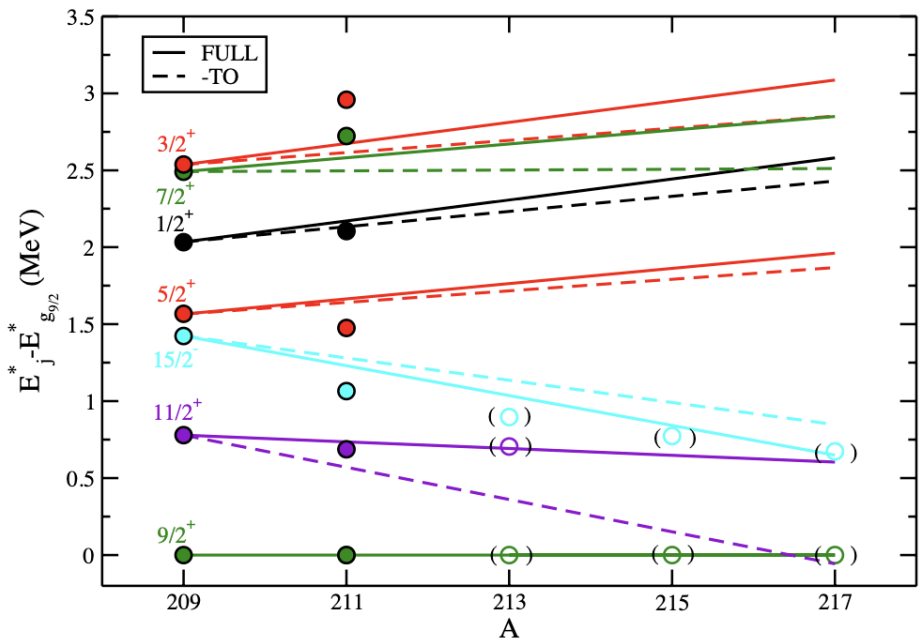
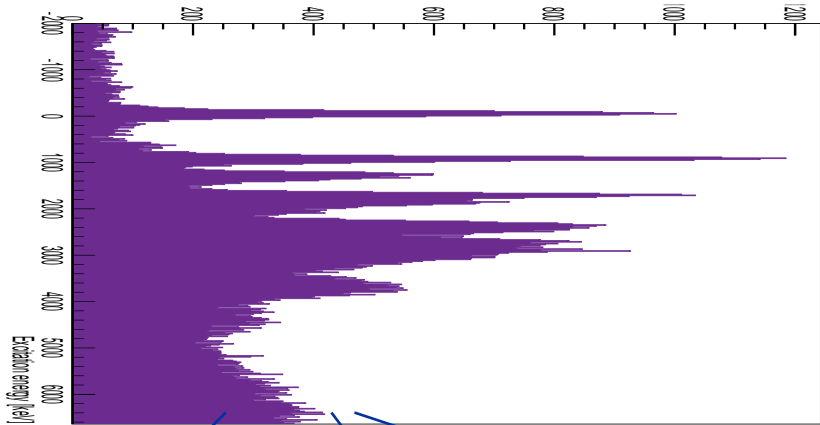

known 9/2+ state.

known 11/2+ state.

Cross sections => large SF

Calculations of shifts in energy using N-N force between these orbitals and protons filling h<sub>9/2</sub> orbital as moving up in Z along N=127 with and without the tensor contribution.



# Active Targets

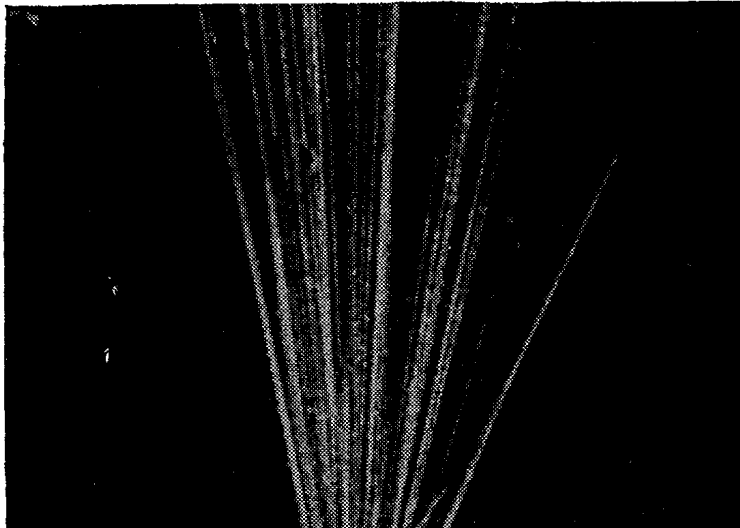

Blackett – Cambridge 1925  
 $^{14}\text{N} + \alpha \Rightarrow ^{17}\text{O} + \text{p}$

P.M.S. Blackett Proc.Roy. Soc. 107 (1925)

SPECMAT @ ISOLDE

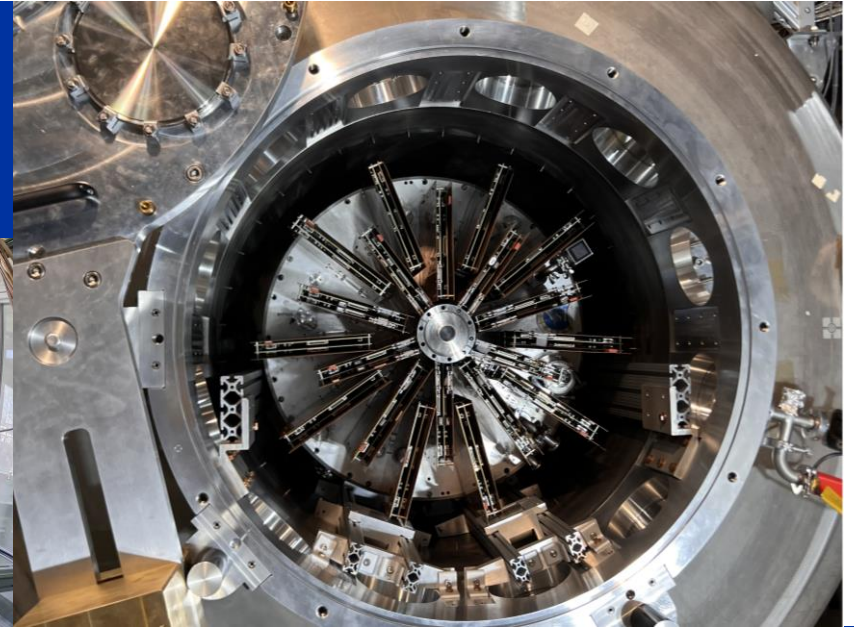

AT-TPC  
@ FRIB/ARGONNE

# ACTIVE TARGETS

Limited intensity beams drive a need for high efficiency and thick targets.

Detector also acts as the target; large active volume, no dead layers, low threshold and high efficiency.

Track particles:

- determine interaction point (avoids target effects); angular distribution.
- PID via range, energy deposition and kinematics.

Particularly useful for low-energy detection: light unbound states, astrophysics...  
Escaping particles require ancillary devices.

Suffer pileup at higher rates....  
Analysis is tricky...

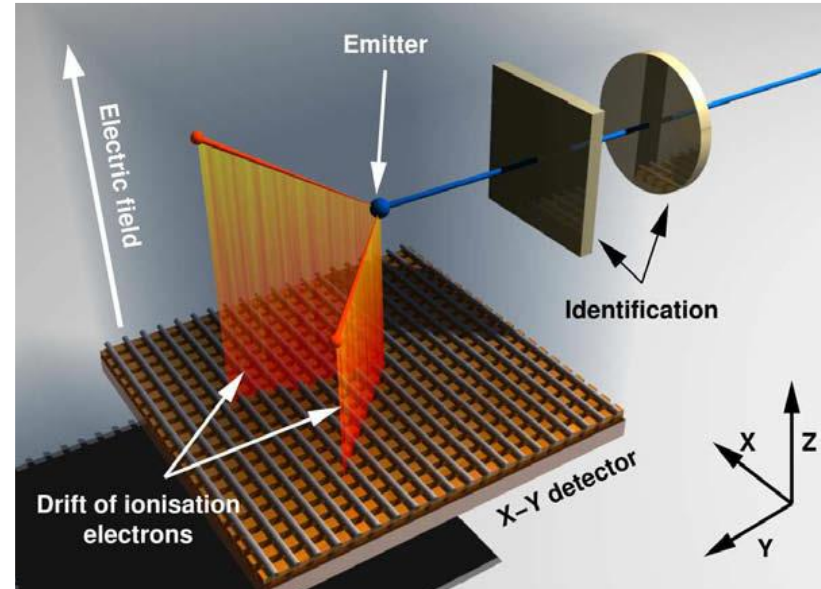

CENBG-TPC: Bordeaux

Variations in details, use of magnetic fields and types of additional detectors.

Thicknesses up to  $10^{21}$  atoms/cm<sup>2</sup>  $\Rightarrow$  down to  $\sim 10^2$  to  $3$  pps.  
Exceptionally low thresholds.

Energy resolution:  $\sim 0.5\%$

Tracking copes with poor quality beams.  
Target materials: isobutane, H<sub>2</sub>, D<sub>2</sub>, He at few atm.

Escaping particles require ancillary detectors.

Tracking rates limited  $< 10^5$  pps.  
Improve by de-sensitizing or blind regions to beam.

Beam-energy losses: always using a range of (known) energies, useful for excitation functions!



## Example - Study of spectroscopic factors at N= 29 using isobaric analogue resonances in inverse kinematics.

- $^{47}\text{Ar}$  appeared to have reduced  $p_{1/2^-}$   $p_{3/2^-}$  splitting in a  $(d,p)$  measurement but questioned due to missing fragments.
- Use resonant elastic scattering  $^{46}\text{Ar}(p,p)^{46}\text{Ar}$  to identify isobaric analogue states in  $^{47}\text{K}$ .
- 140 MeV/u  $^{48}\text{Ca}$  on Be,  $^{46}\text{Ar}$  fragments selected, stopped in gas, charge bred and reaccelerated to 4.6 MeV/u at NSCL@MSU – average rate 1180 pps (instantaneous 5k to 60 kpps).
- Into AT-TPC with 19.2 Torr  $\text{C}_4\text{H}_{10}$  in a 1.68 T field - look for trajectories matching reactions on protons.
- Energy varies as beam slows down in gas and stopped.

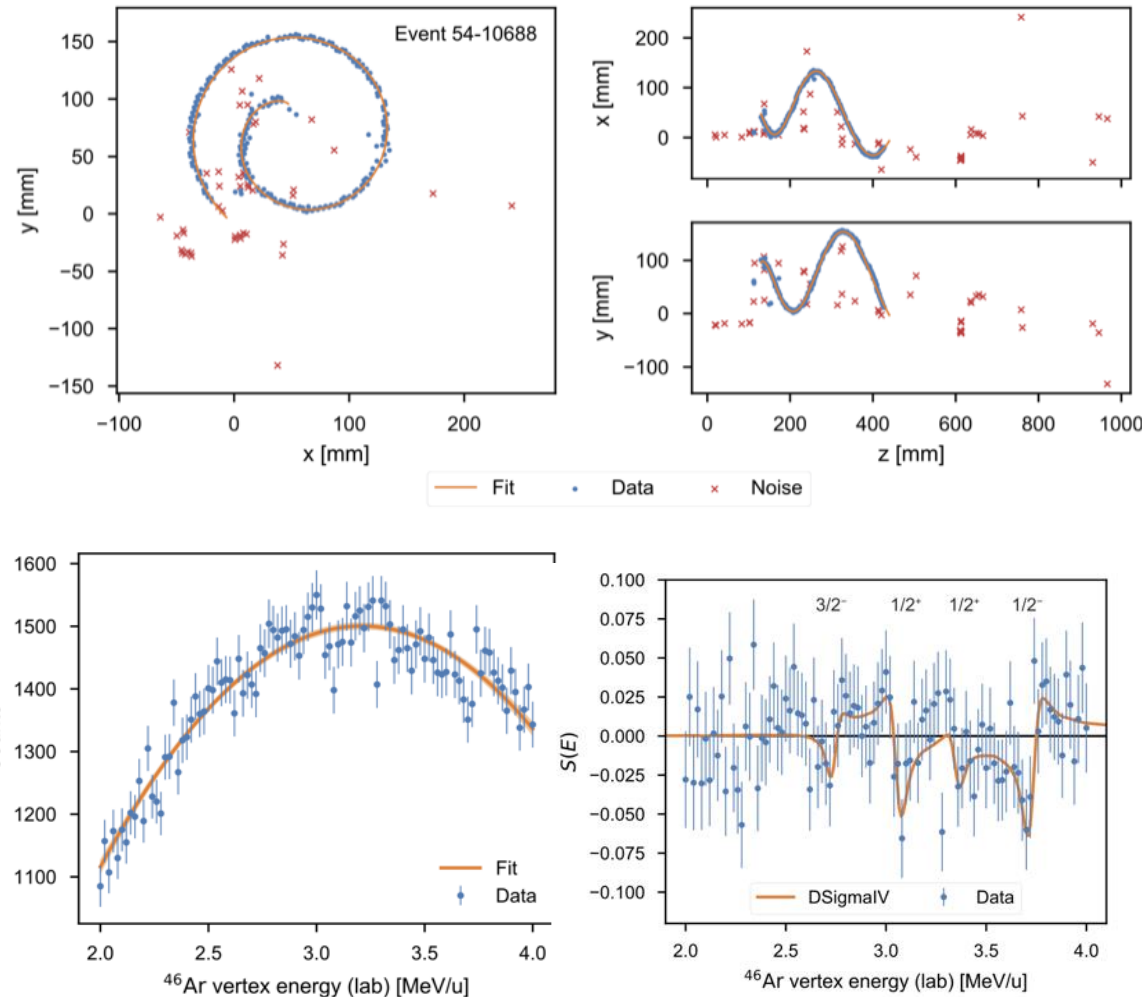

- Theoretically, this data consists of resonances superimposed on a slowly varying baseline:  $S(E)=[N(E)-B(E)]/B(E)$ .
- Analysis of resonances modelled using R-matrix theory to get energies and partial widths (related to proton SF).
- Resonances are very odd shapes – not Breit-Wigner forms due to the interference is the amplitudes from resonant and potential scattering.

# And now at the end?

- Wow – we've been through A LOT of physics – nuclear structure, reactions and detectors strategies.
- Single-particle structure of nuclei is important – it is usually at the root of most nuclear phenomena (structure or reactions, single-particle or collective) across quite a wide energy range from a few to many tens of MeV.
- It is not (perhaps) as straightforward as you might have thought in the 1980's:
  - (a) seeing single-particle structure evolve and change away from stability.
  - (b) exciting but, unobserved, expectations in dripline nuclei.
  - (c) understanding of nucleon correlations now much deeper and better appreciation of reaction mech.
  - (d) a renaissance in transfer reactions just above the Coulomb barrier with radioactive beams.
  - (e) studies of the most exotic systems via knockout from secondary fragments at higher energies.

Where is it going...

Scratching the surface of reactions with radioactive beams mainly (d,p) so far – much more to do with neutron removal, proton transfer, charge exchange, cluster and pair transfer...

Polarised radioactive ion beams?

More selective measurements? Measurements with weaker and weaker beams? Storage rings?



[home.cern](http://home.cern)

# Backups and extras

# Isospin...

Quantity conserved by nuclear forces.

Spin-like quantum mechanics:

$$t_{z \text{ proton}} = -1/2 \text{ and } t_{z \text{ neutron}} = +1/2.$$

For a nucleus,  $T_z = (N-Z)/2$  and  $T \geq T_z$  and usually  $T_{gs} = T_z$ .

### Deuteron Key Properties:

- Binding energy 2.224 MeV.
- No bound excited states.
- Ground-state spin and parity  $1^+$ .

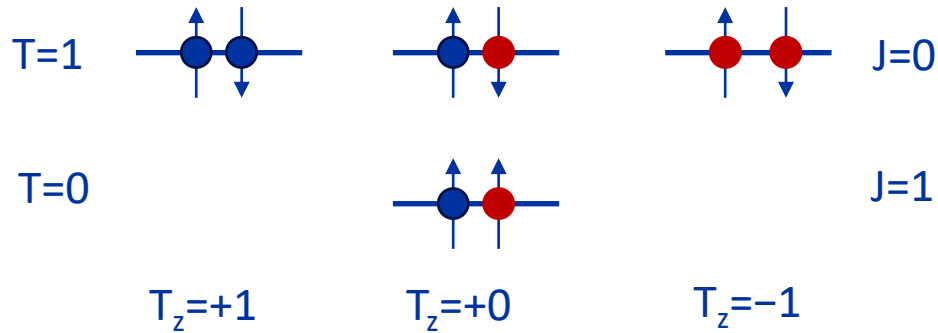

two nucleons in a  $s_{1/2}$  state

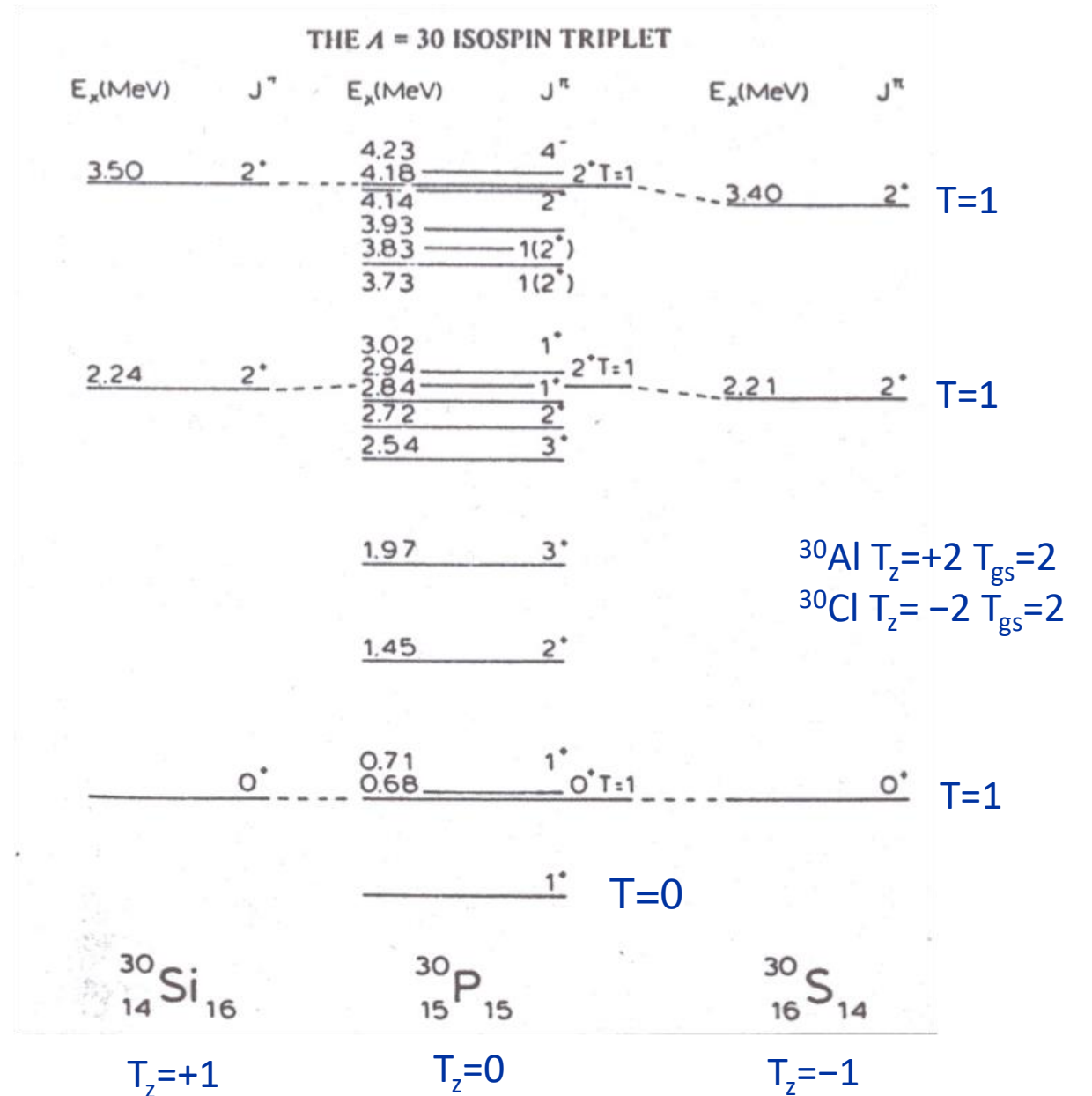

Coulomb energy differences removed

# Isobaric analogue resonances.

- Proton elastic scattering as a function of energy shows resonances at low energy corresponding to the formation of states of the CN.
- As energy increases and for heavier nuclei, these broaden to give a smooth variation of cross section with energy.
- At higher energies, you sometimes see surprisingly narrow resonances due to the formation of isobaric analogue states in the CN.
- These have very different isospin to the surrounding sea of states so don't mix and retain a narrow width.
- Shapes of resonances can be used to determine the L value.
- Formed by adding a proton, so the resonant cross section is related to a SF.

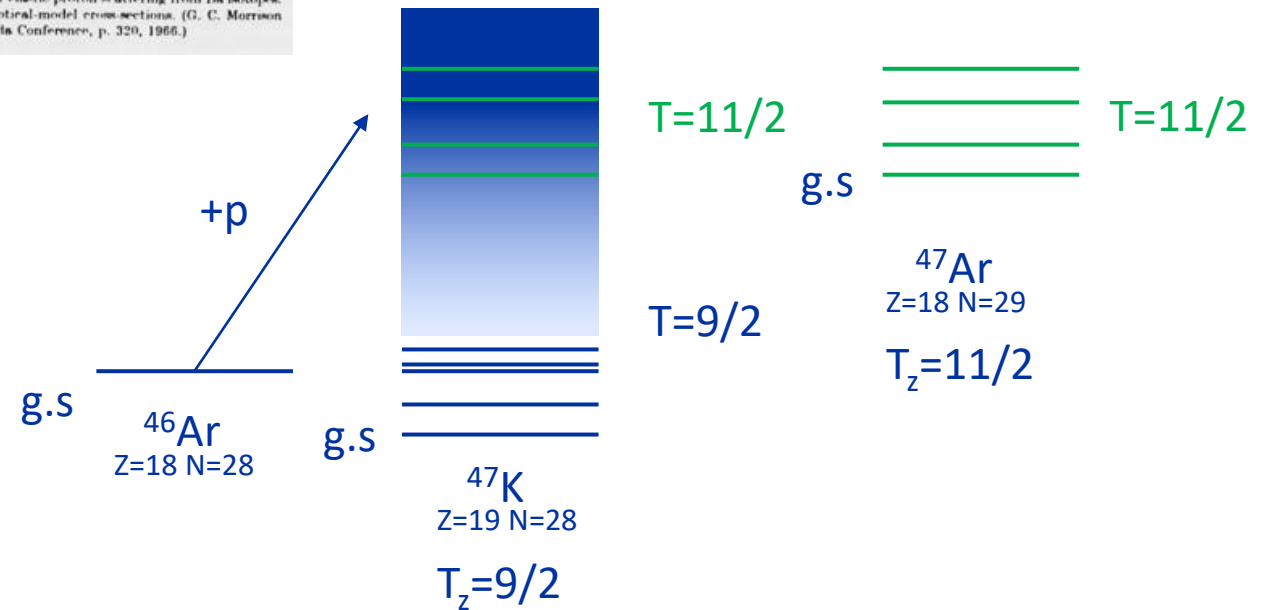
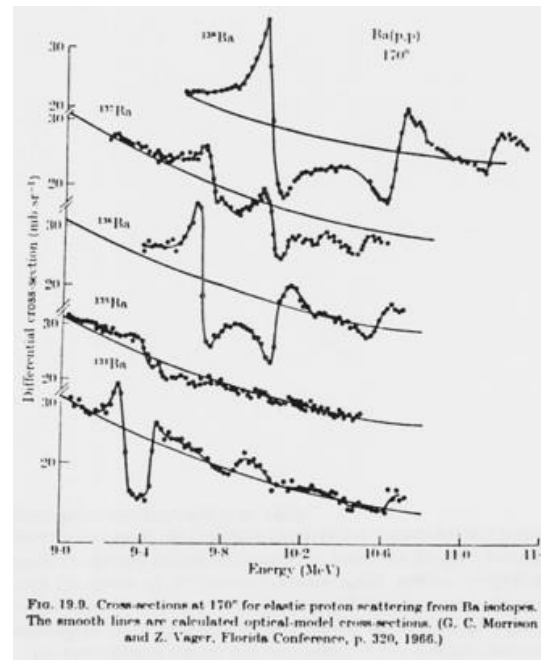



## Calculating using two-body matrix elements calculated in isospin formalism

$$V_T(j_1 j_2) = \frac{\sum_J (2J + 1) \langle j_1, j_2; J, T | V | j_1, j_2; J, T \rangle}{\sum_J (2J + 1)}$$

for  $T=0$  or  $1$  and where  $J$  takes only even/odd integers for  $j_1=j_2$  with  $T=1/0$ .

$$\epsilon_{j_1}^{np} = \sum_{j_2} \frac{1}{2} [V_{T=0}(j_1, j_2) + V_{T=1}(j_1, j_2)] n_{j_1}$$

averaging over  $T=0$  and  $T=1$  with no weighting since only 1 substate of each has the right  $T_z$  to be in this nucleus!

# Evidence for Tensor component of NN forces?

Deuteron: two nucleons in a  $s_{1/2}$  state?  
ground state is  $1+$ , spins parallel?  
 $^3S_1$  state?

$$\mu = \mu_n + \mu_p = 0.8797\mu_N$$

Expt:  $\mu = 0.85743823(3)\mu_N$

Spherical symm  $Q=0$

Expt:  $Q_0 = +0.286(2) \text{ fm}^2$

Can't be pure S state!

Mixing with other configurations?

Possible couplings with  $J=1$ :  $^1P_1$  ( $S=0$   $L=1$   $J=1$ ) or  $^3P_1$  ( $S=1$   $L=1$   $J=1$ ) or  $^3D_1$  ( $S=1$   $L=2$   $J=1$ )

Possible couplings with  $J=1^+$ :  $^3D_1$  ( $S=1$   $L=2$   $J=1$ )

Wave function:  $\psi = \alpha ^3S_1 + \beta ^3D_1$  and  $\beta \approx 0.08$  gives right  $Q_0$ .

What kind of term in N-N potential would do this?

$$V_T = f_T(r) \left[ \frac{3 (\underline{s}_1 \cdot \underline{r}) (\underline{s}_2 \cdot \underline{r})}{r^2} - \underline{s}_1 \cdot \underline{s}_2 \right]$$

Called **TENSOR** force due to its transformation properties.  
It is non-central in nature i.e. orbital ang mom not conserved.  
c.f. a central force:

$$\mathbf{F} = |F(\mathbf{r})| \hat{\mathbf{r}} \quad V = V(r)$$

Favoured

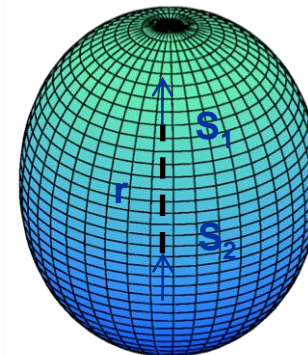

Unfavoured

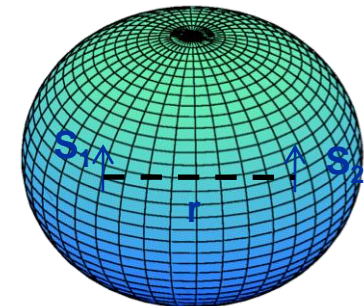

## No tensor interaction in a singlet state:

Easy option is to argue that  $S=0$  is spherically symmetric but tensor force depends on orientations so it has to be zero for  $S=0$ .

$$3(\underline{s}_1 \cdot \hat{r})(\underline{s}_2 \cdot \hat{r}) - \underline{s}_1 \cdot \underline{s}_2$$

$$\underline{S} = \underline{s}_1 + \underline{s}_2 \quad S^2 = s_1^2 + s_2^2 - 2\underline{s}_1 \cdot \underline{s}_2$$

$$\rightarrow \underline{s}_1 \cdot \underline{s}_2 = \frac{1}{2}(S^2 - s_1^2 - s_2^2)$$

$$= \frac{1}{2}(S^2 - \frac{1}{2}(\frac{1}{2}+1) \times 2) = \frac{1}{2}(S^2 - \frac{3}{2})$$

$$= \frac{1}{2}(S(S+1) - \frac{3}{2}) = \begin{matrix} -3/4 & S=0 \\ 1/4 & S=1 \end{matrix}$$

$$\text{If } S=0 \rightarrow \underline{s}_1 = -\underline{s}_2$$

$$\rightarrow -3(\underline{s}_1 \cdot \hat{r})^2 + s_1^2$$

$$-\frac{3}{4} + \frac{3}{4} = 0$$

So no tensor force for <sup>two</sup> particles with  $S=0$ .

$\underline{s}_1 \cdot \hat{r}$  component in direction  $\hat{r} \rightarrow \pm \frac{1}{2}$

## Intuitive interpretation of tensor TBME

Tensor only in  $S=1$  so spins parallel.

- (a) Two particles have high relative momentum for opposite-sense spin-orbit couplings. Uncertainty principle suggests spatial compression in that direction. Looks like a prolate/deuteron shape – *favoured!*
- (b) Two particles have low relative momentum for same-sense spin-orbit couplings. Uncertainty principle suggests spatial extended in that direction. Looks like an oblate shape – *unfavoured!*

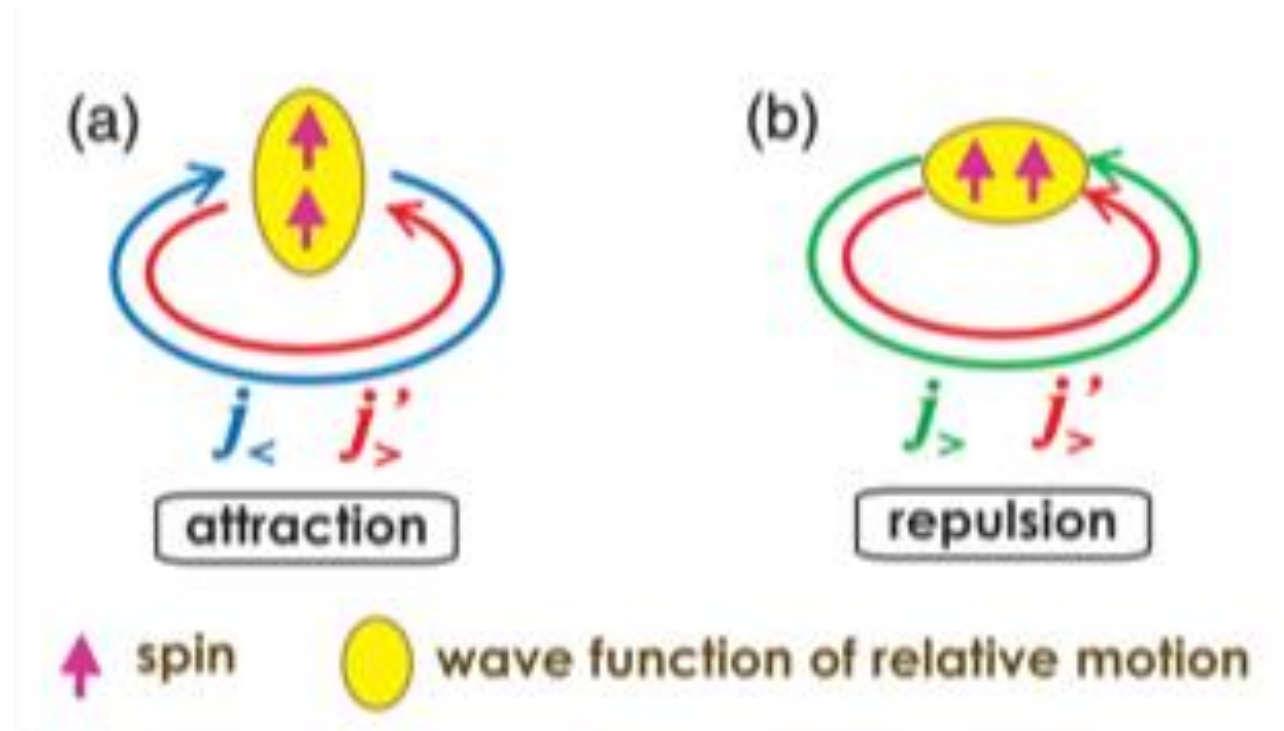

So tensor interaction between  $j_>$  and  $j_<'$  is attractive, and between  $j_>$  and  $j_>'$  is attractive.

# Collectivity and nuclear shape

For a nucleus corresponding to a shell closure, large jump from Fermi level to the next empty orbital – effect of residual interactions low and IPM works (a little) better.

Going away from a closed shell, with increasing numbers of (valence) nucleons outside the shell, the correlations between them increase and can have macroscopic effects on the nuclear structure, distorting the surface.

Distortions of the nuclear surface described by a spherical harmonic expansion – good angular momentum:

$$R(\theta, \phi) = c(\alpha_{\lambda\mu})R_0 \left[ 1 + \sum_{\lambda=0}^{\infty} \sum_{\mu=-\lambda}^{\lambda} \alpha_{\lambda\mu} Y_{\lambda\mu}(\theta, \phi) \right]$$

Excitations can arise if the shape changes with time – NUCLEAR VIBRATIONS.

Permanent distortions lead to NUCLEAR SHAPE and excitations can arise from ROTATIONS of that shape.

Coherence in the admixtures of single-particle configurations can greatly increase some observables – e.g. electrostatic moments, e/m transition rates...

Example: quadrupole shapes

$$Q_0 = Z [3\langle z^2 \rangle - \langle r^2 \rangle]$$

$$\langle z^2 \rangle > \frac{1}{3} \langle r^2 \rangle$$

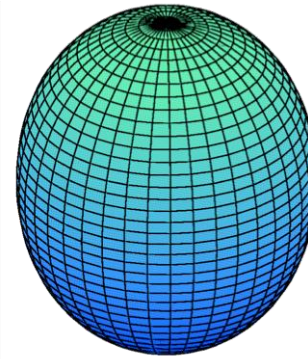

$$Q_0 > 0$$

Prolate

$$3\langle z^2 \rangle = \langle r^2 \rangle$$

$$\langle x^2 \rangle = \langle y^2 \rangle = \langle z^2 \rangle$$

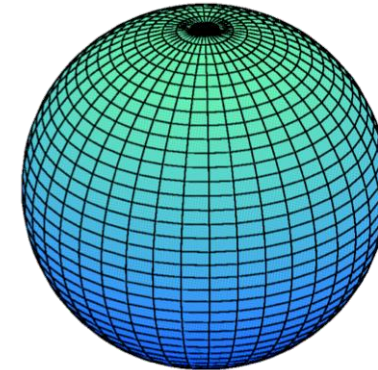

$$Q_0 = 0$$

Spherical

$$\langle z^2 \rangle < \frac{1}{3} \langle r^2 \rangle$$

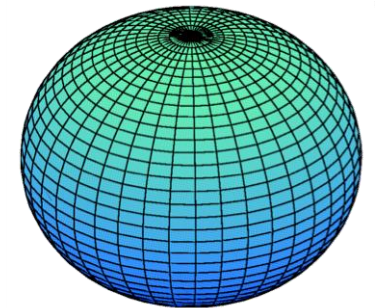

$$Q_0 < 0$$

Oblate

Given the nucleus has a charge – distortion results in electromagnetic moments, which can be probed experimentally in some nuclear reactions or by their effect on electron levels in the associated atom/ion (see later!).



# Shape evolution and coexistence

We saw that the effect of residual interactions changes along chains of isotopes/isotones and within excited states in the same nucleus – these also drive evolution in nuclear shape. You need to access particular (N,Z) to study certain shapes.

EXAMPLE: octupole or pear-shaped deformation related to correlations induced by a  $Y_3$  operator, strong between orbitals of opposite parity and  $\Delta J, \Delta L = 3$  close to the Fermi level.

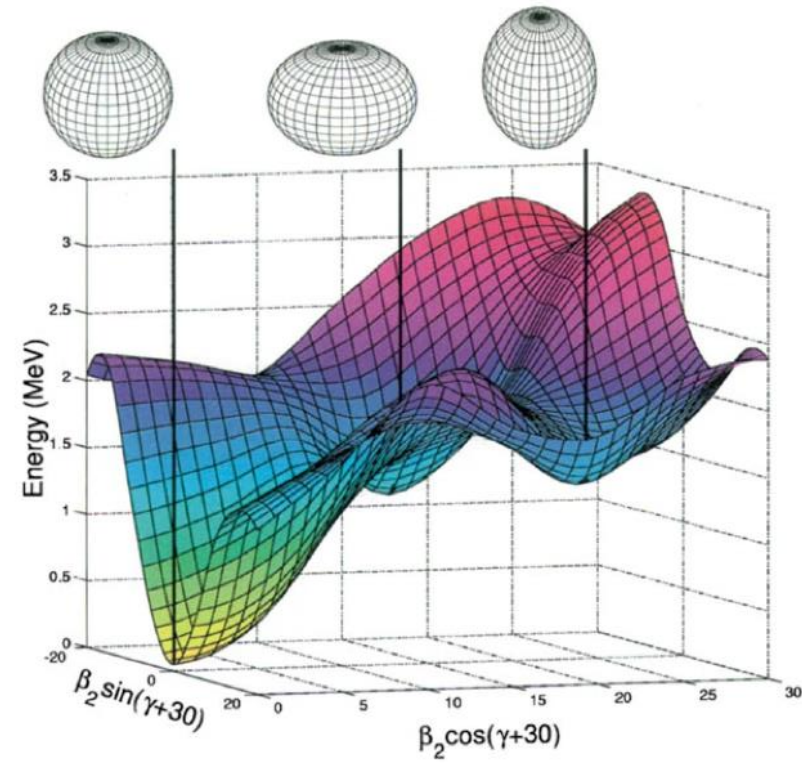
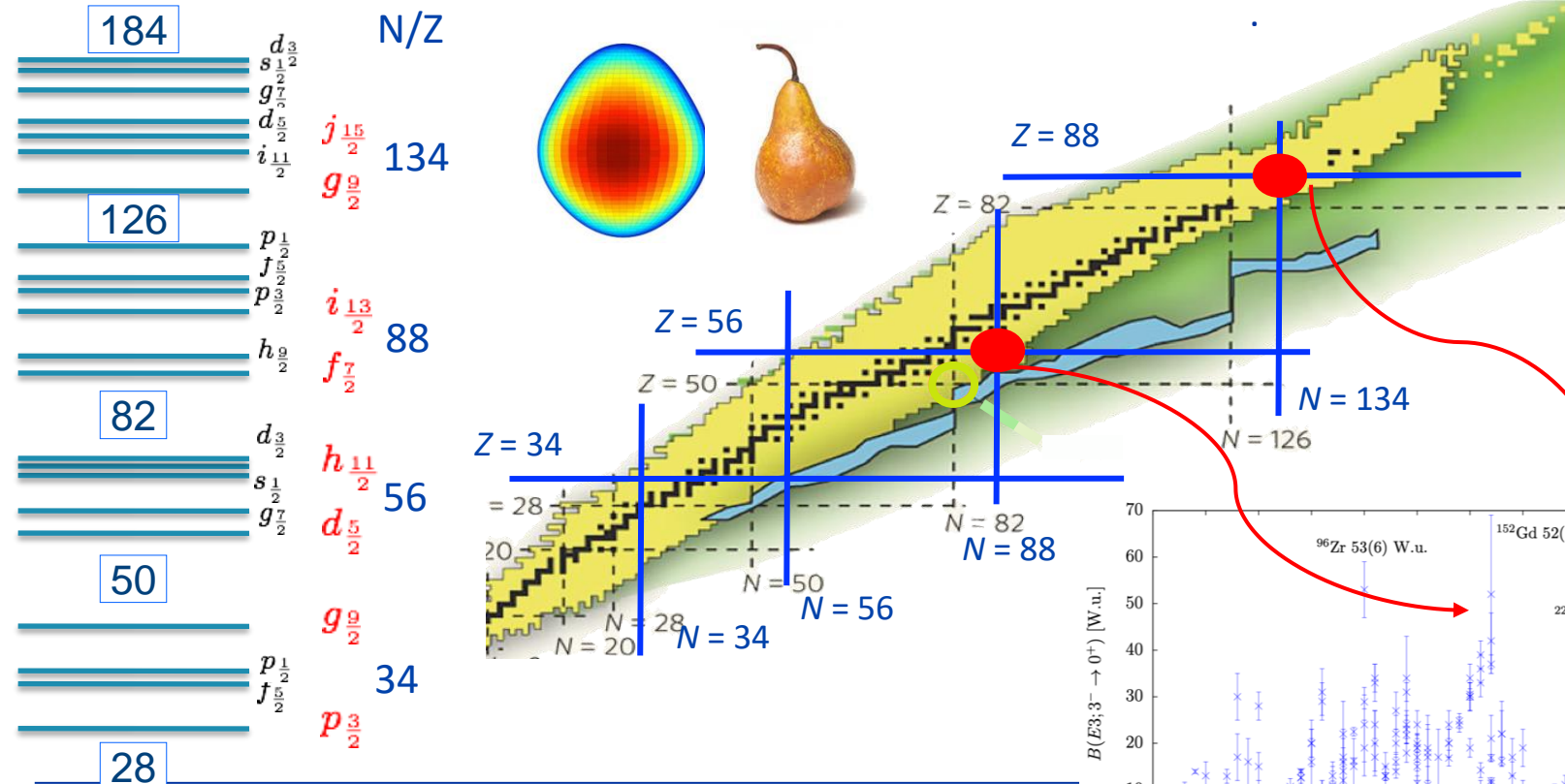

EXAMPLE: spherical, oblate and prolate shapes exist as different excited states in the same nucleus  $^{186}\text{Pb}$ .

# What characterizes a nucleus?

Some examples of relevant quantities....

numbers of nucleons

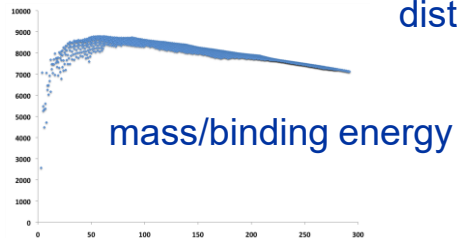
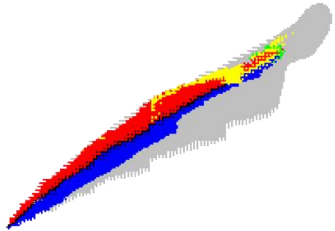

radii, charge and matter distributions

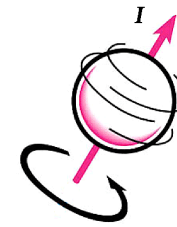
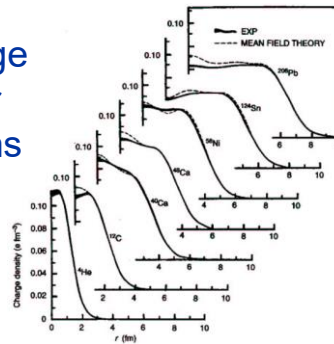

spin-parity and e/m moments

decay properties: mode, lifetime, BR...

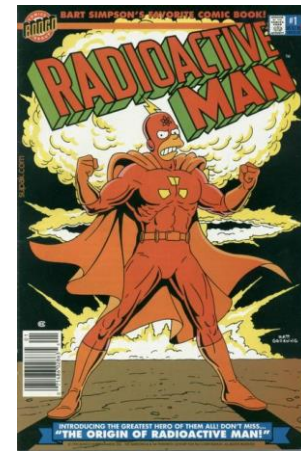

....in principle, for the ground state and excited states.

Nuclear reactions are important tools:

- (i) produce nuclides.
- (ii) select states.
- (iii) reaction properties such as cross sections.

Deduce, mostly model-dependently:  
 transition rates  
 orbital occupancy  
 single-particle nature  
 pairing and clustering etc.

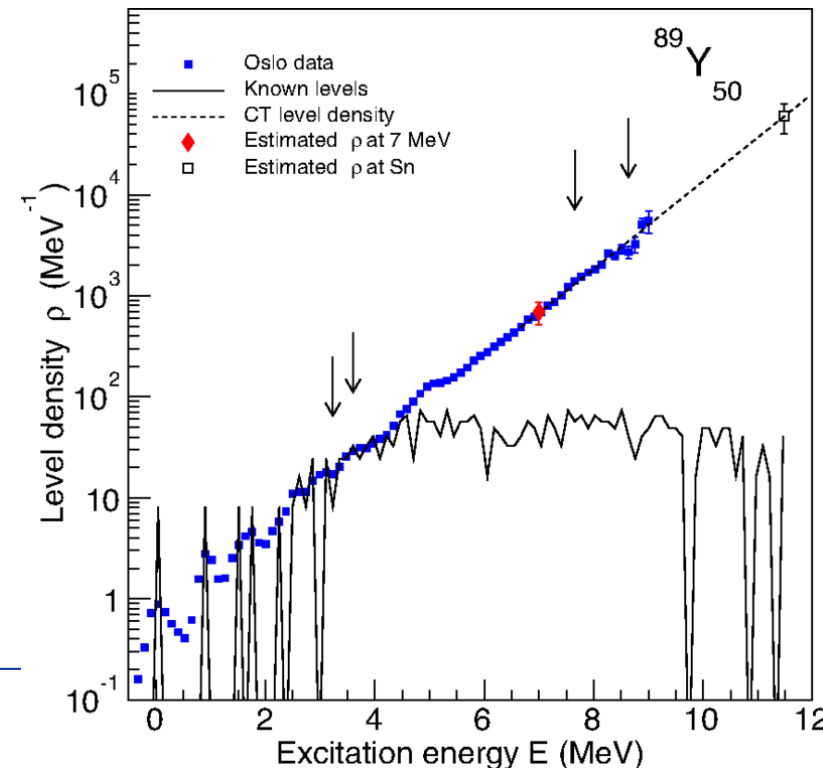
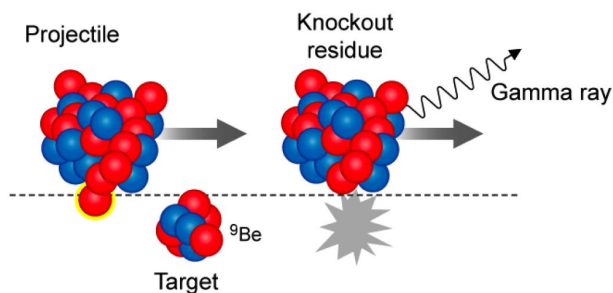

*M. Guttormsen et al.,  
 PRC 90, 044309  
 (2014)*

# Radioactive Ion Beam Facilities

- Most isotopes predicted to exist are not known.
- Many known exotic isotopes have only rudimentary studies.
- The proton drip line has been reached in many cases; the neutron drip line is largely unknown.

## Requires:

- i. high-intensity exotic nuclei for direct study.
- ii. high-energy exotic beams to initiate secondary reactions

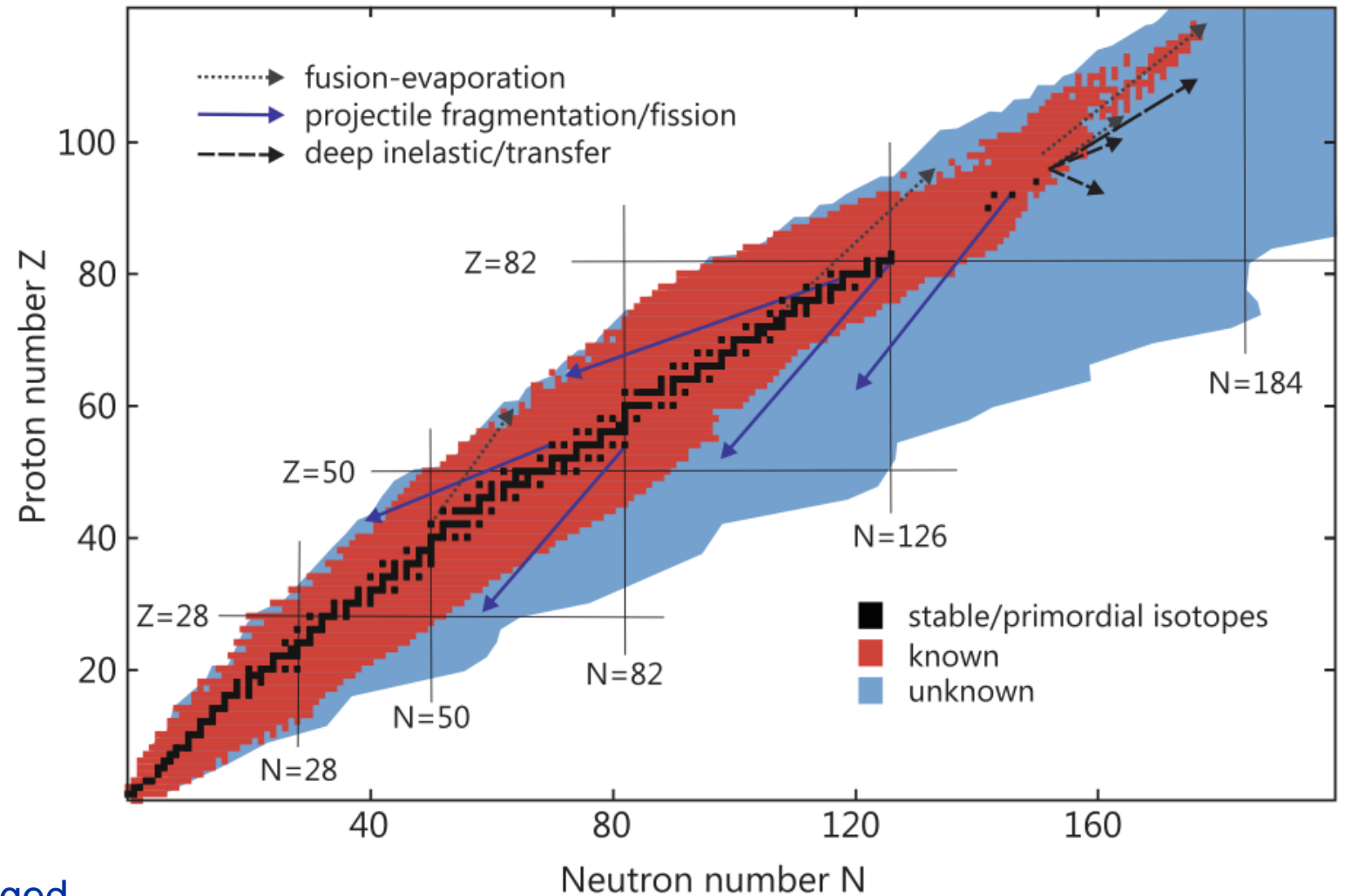

Two main types of facility have emerged.

from "The Discovery of Isotopes" Michael Thoennessen

# ISOL

- uranium carbide, Ta metal, molten metals and salts
- fusion, fission, spallation, fragmentation

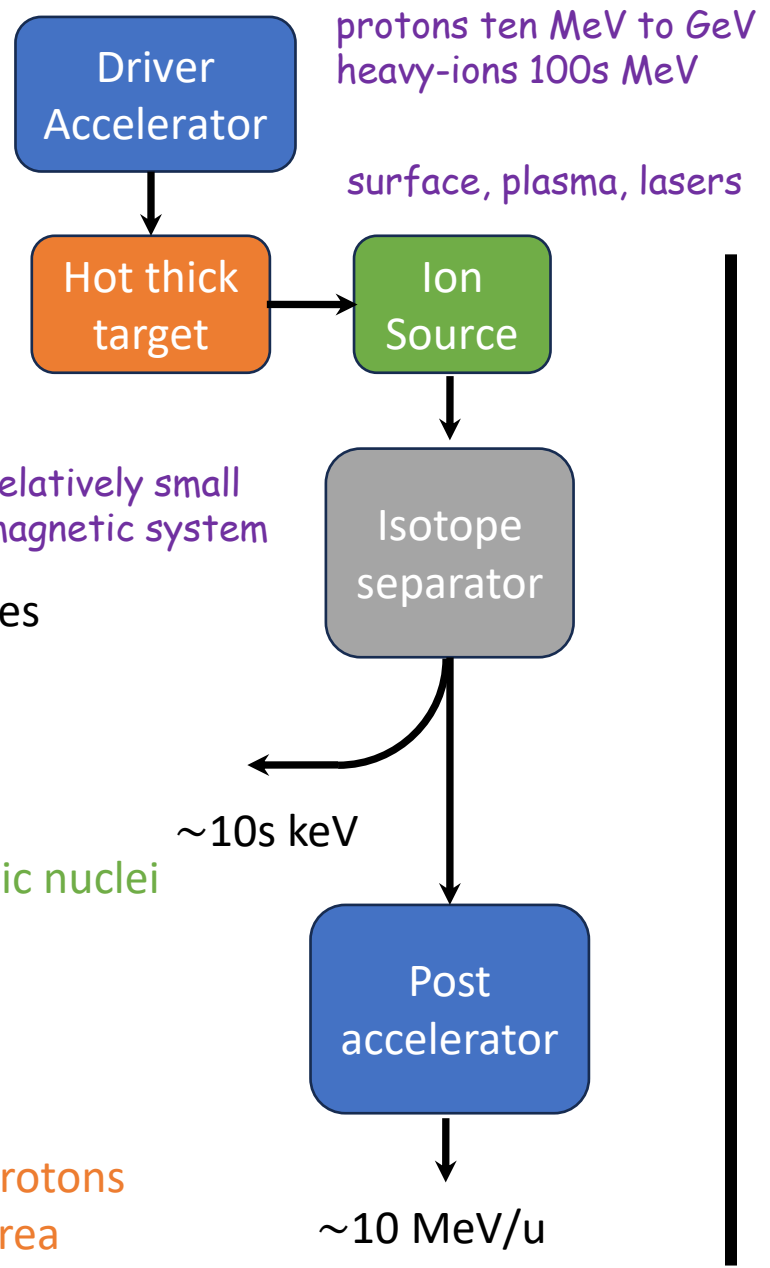

excellent beam properties  
chemical sensitivity  
half-lives > 1ms

DISCOVERY POTENTIAL:  
precision studies of exotic nuclei

- Examples:
- ISOLDE 1.4 GeV protons
  - TRIUMF-ISAC 600 MeV protons
  - INFN-SPES and RAON-Korea 70 MeV protons
  - SPIRAL/DESIR-GANIL heavy-ions 25 MeV/A (fusion etc.)

# IN-FLIGHT

usually heavy-ions 100s MeV/A

- thin light target: Be, Li..
- projectile fragmentation

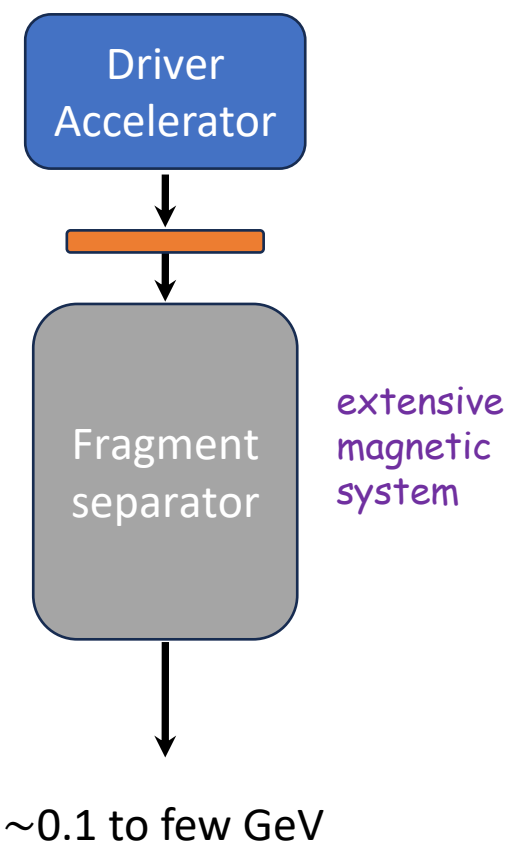

chemical insensitivity  
half-lives < 1ms  
beam properties fixed

DISCOVERY POTENTIAL:  
loosely-bound isotopes at the very edge of stability

- Examples:
- RIBF-RIKEN 350 MeV/A heavy ions
  - FRIB-USA 200-250 MeV/A heavy ions
  - FAIR-GERMANY 2 GeV/A heavy ions
  - GANIL 95 MeV/A

# ISOL - TRICKS

play with chemistry e.g. make and extract molecules for refractory species

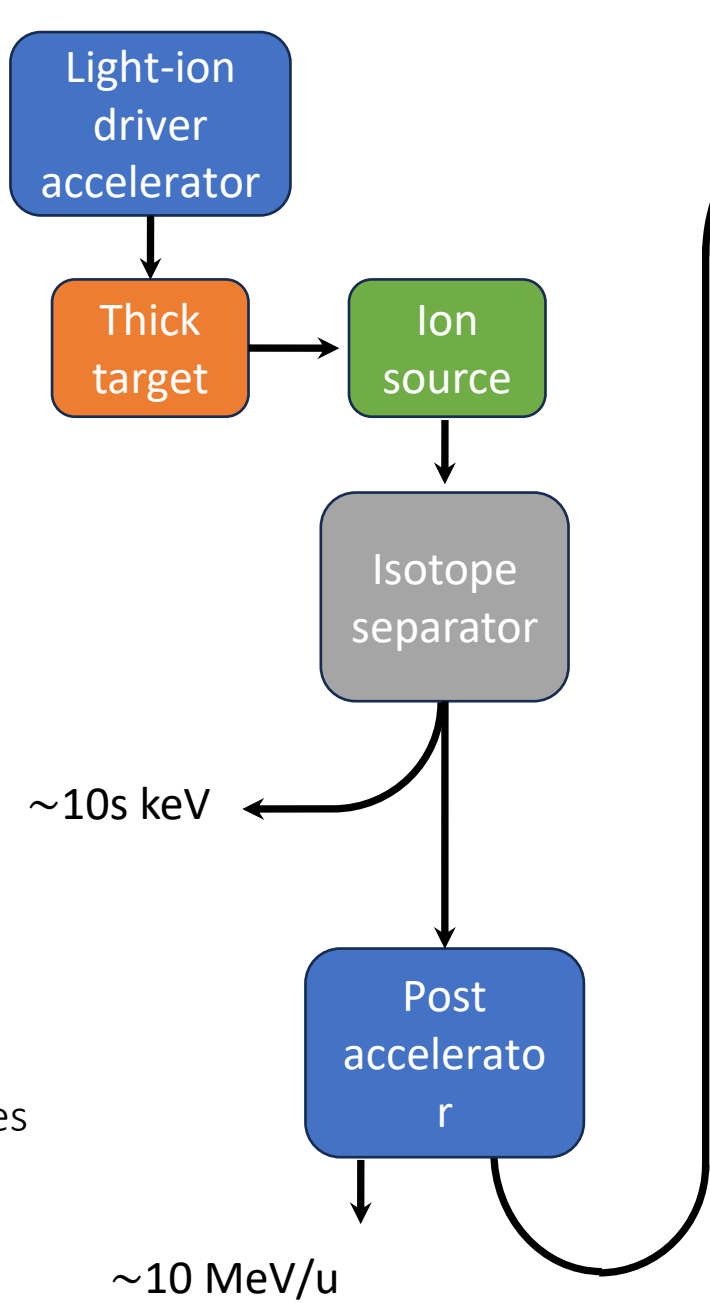

>1 ms is fundamental limit, but has the advantage of easy to switch between isotopes with systematics under control

$\sim 10 \text{ MeV/u}$

RAON plan – very ambitious!

# IN-FLIGHT -TRICKS

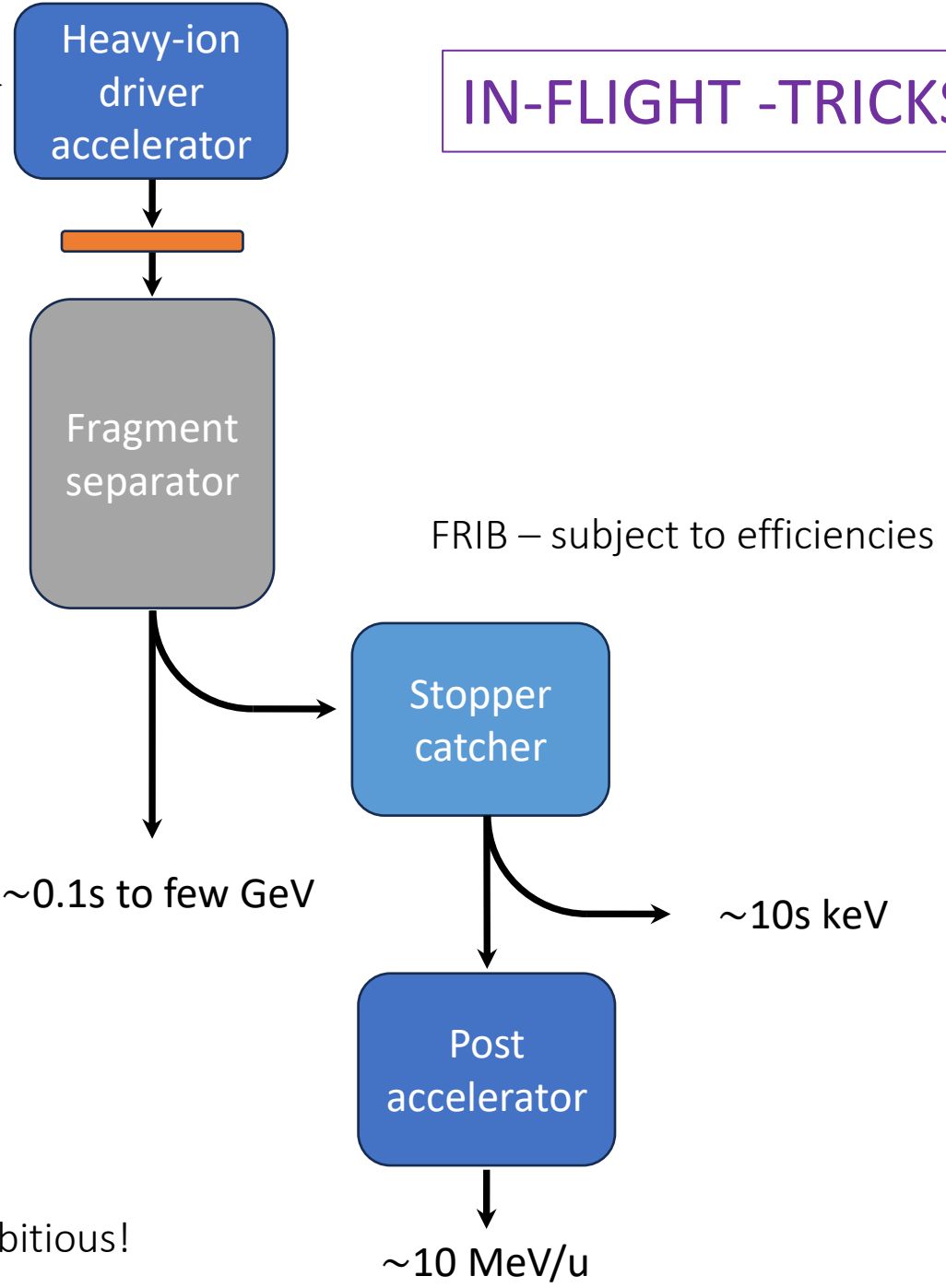

FRIB – subject to efficiencies

$\sim 10\text{s keV}$

$\sim 10 \text{ MeV/u}$





# Facility for Rare Isotope Beams at Michigan State University



Experiments with fast, stopped,  
and reaccelerated beams

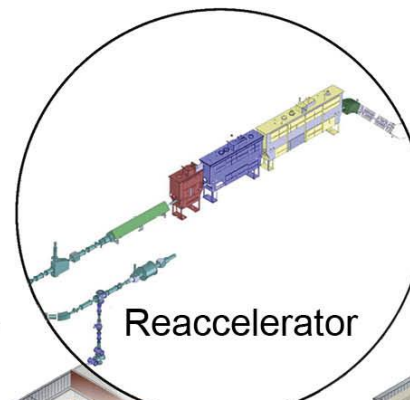

Reaccelerator

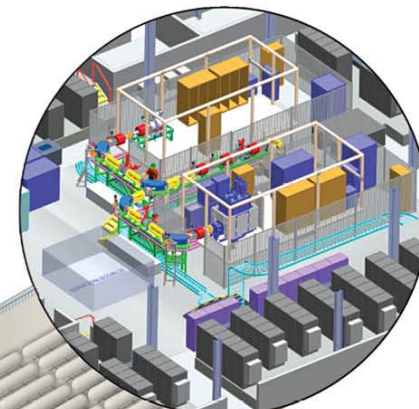

Ion source

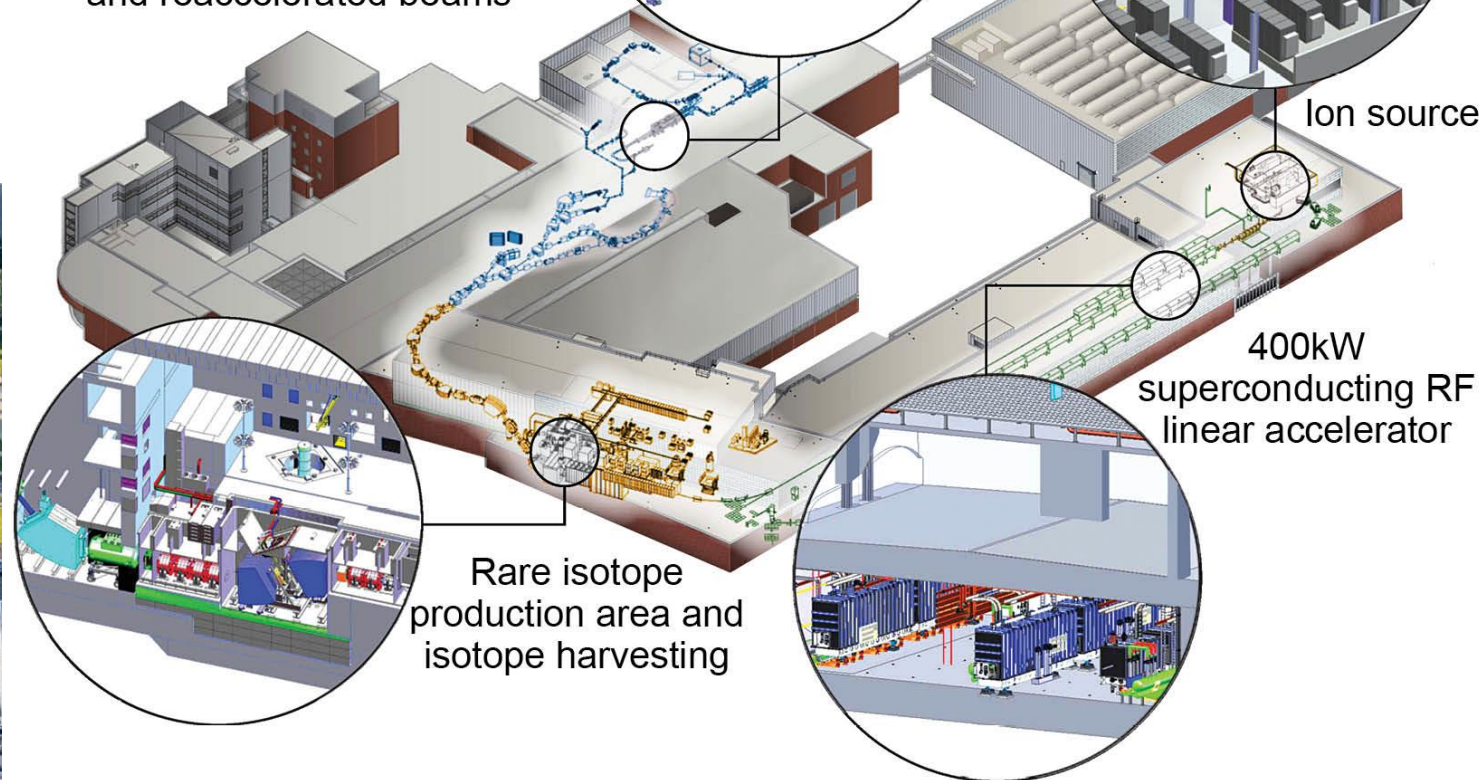

400kW  
superconducting RF  
linear accelerator

Rare isotope  
production area and  
isotope harvesting



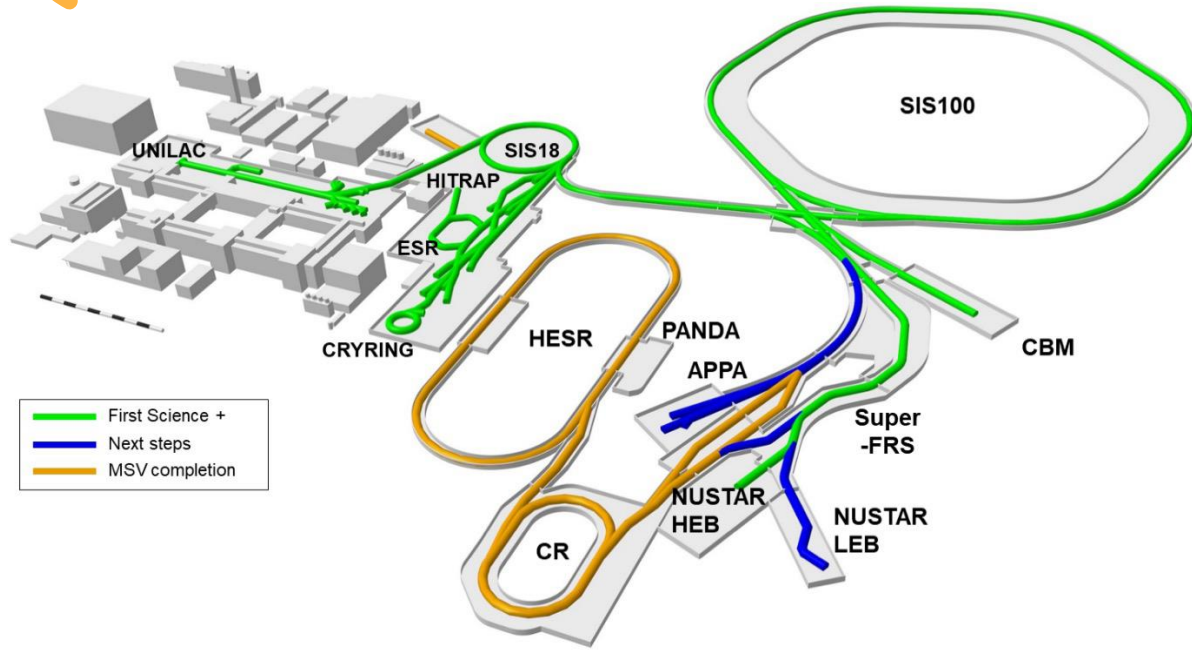





# ISOLDE

As an example of an ISOL facility and a slightly deeper dive into the experiments in nuclear structure and the physics that can be addressed....will stray into other scientific areas in the process!

*Still high-level view – presenting work of a vast array of scientific, engineering and technical experts.*





ISOLDE





# The CERN accelerator complex

## Complexe des accélérateurs du CERN

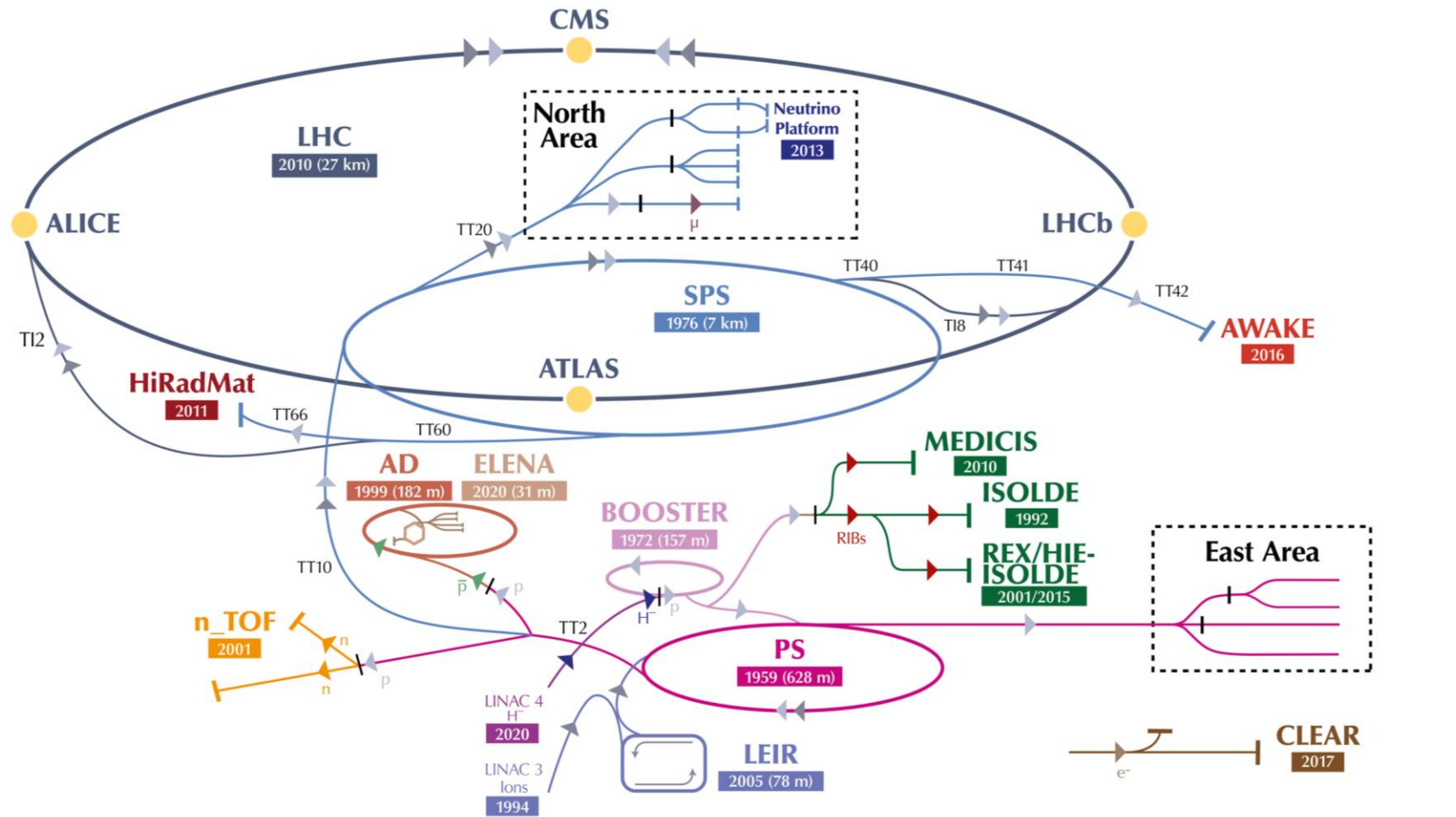

▶  $H^-$  (hydrogen anions)   ▶ p (protons)   ▶ ions   ▶ RIBs (Radioactive Ion Beams)   ▶ n (neutrons)   ▶  $\bar{p}$  (antiprotons)   ▶  $e^-$  (electrons)   ▶  $\mu$  (muons)

LHC - Large Hadron Collider // SPS - Super Proton Synchrotron // PS - Proton Synchrotron // AD - Antiproton Decelerator // CLEAR - CERN Linear Electron Accelerator for Research // AWAKE - Advanced WAKEfield Experiment // ISOLDE - Isotope Separator OnLine // REX/HIE-ISOLDE - Radioactive Experiment/High Intensity and Energy ISOLDE // MEDICIS // LEIR - Low Energy Ion Ring // LINAC - LINear ACcelerator // n\_TOF - Neutrons Time Of Flight // HiRadMat - High-Radiation to Materials // Neutrino Platform



# ISOL with GeV Protons

High-energy protons are impacted onto a thick target, e.g.  $^{238}\text{U}$ .

With GeV protons, reactions produce a wide variety of nuclei simultaneously.

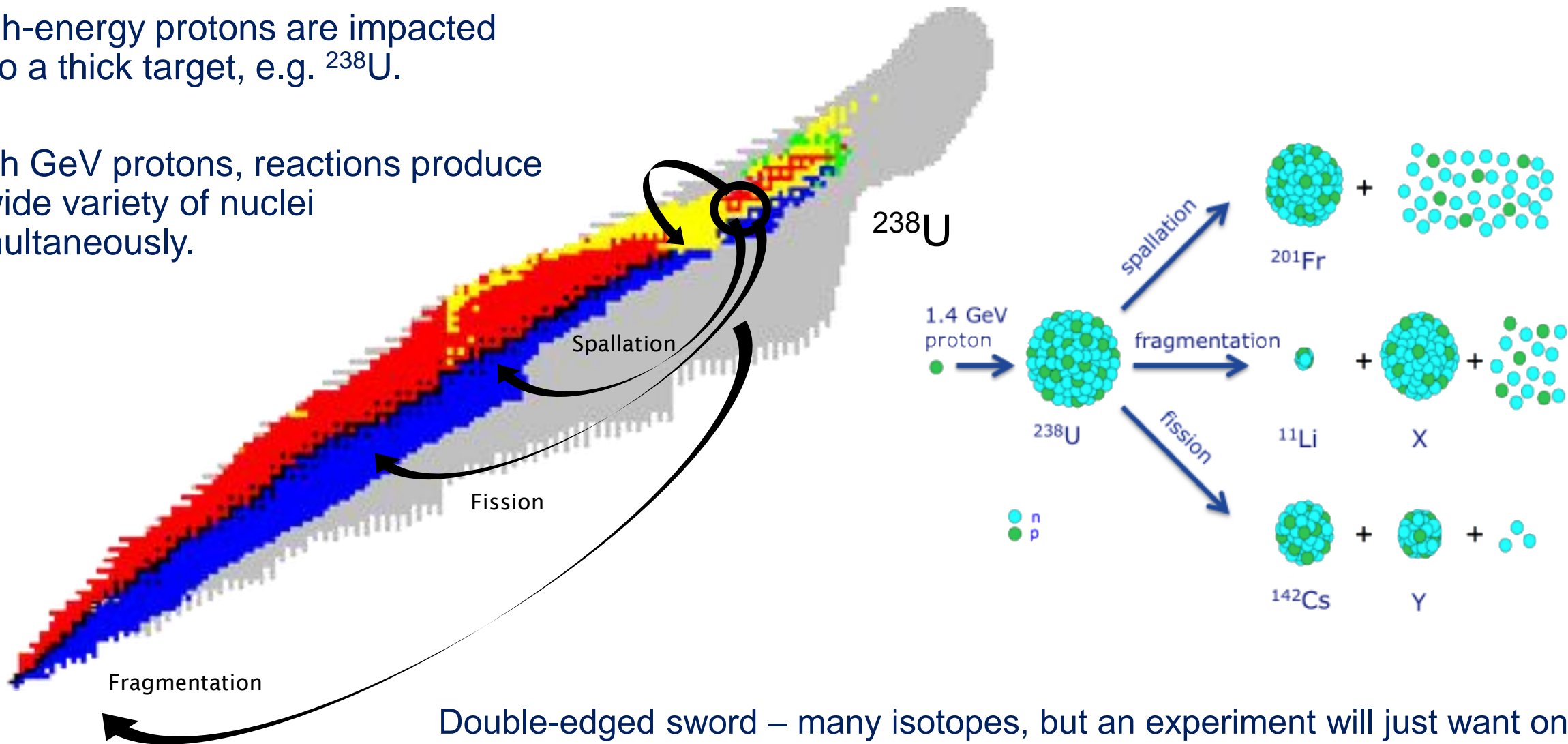

Double-edged sword – many isotopes, but an experiment will just want one!

# Low-energy installations

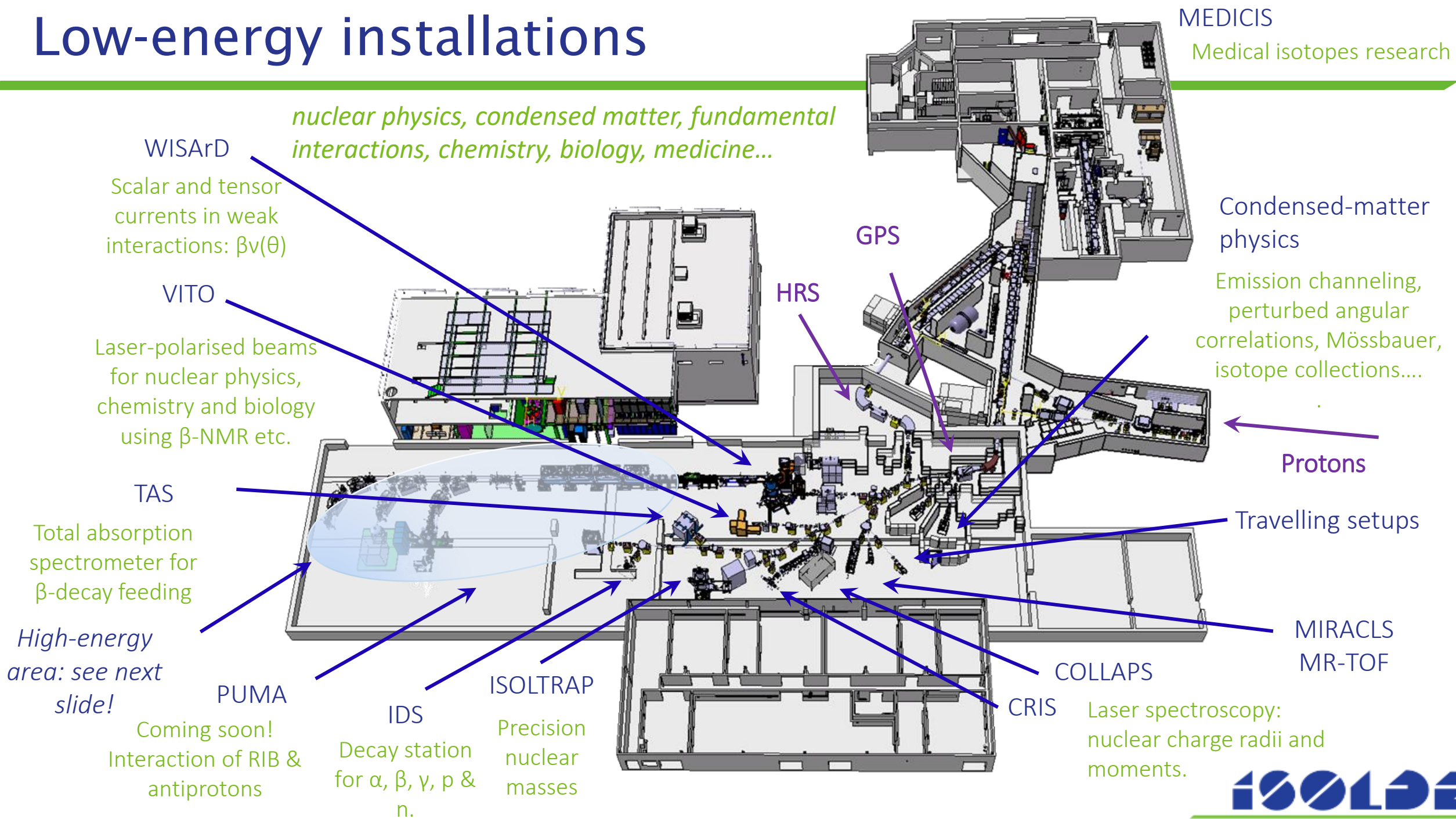



# HIE-ISOLDE completed 2018



Four cryomodules  
each with five rf  
cavities

REX TRAP + EBIS  
1+ to N+

40-60 keV 1+ ions



REX normal conducting  
linac <3.1 MeV/u  
(2001-12)

HIE super conducting linac <9.2 MeV/u  
(2014-18)

MINIBALL  
(array of 24 segmented  
Ge crystals)

Scattering  
Expts Chamber (SEC)

ISOLDE Solenoidal Spectrometer (ISS)

*nuclear  
structure,  
reactions and  
astrophysics*

# ISOLDE Solenoidal Spectrometer

Direct reactions: e.g. addition of neutron to a nucleus (d,p) without excitation of other degrees of freedom probe single-particle strength distributions.

*Stable species:* deuteron beam on target – CM with small velocity.

*Unstable species:* heavy beam on deuterated target - CM with large velocity, creating kinematic issues for measuring outgoing proton.

## Helical orbit spectrometer principle

Target on the field axis + array of Si detectors.

MEASURE: position  $z$ , cyclotron period  $T_{\text{cyc}}$  and **energy  $E_p$  of emitted protons** from transfer reaction

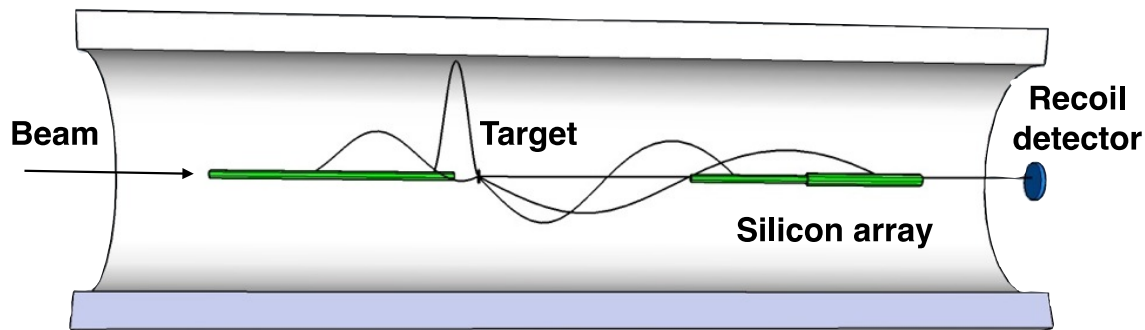

4T superconducting (former MRI) solenoid from UQ hospital, Brisbane to ISOLDE in 2017

Linear transformation between  $E_{\text{cm}}$  and  $E_{\text{lab}}$

$$\text{CM Energy: } E_{\text{cm}} = E_{\text{lab}} + \frac{mV_{\text{cm}}^2}{2} - \frac{mzV_{\text{cm}}}{T_{\text{cyc}}}$$

No kinematic compression of the Q-value spectrum – excellent resolution without need for  $\gamma$  rays.



# First ISS Physics (CERN Run 2) 2018 – with HELIOS Si array.

## (i) Terra incognita $Z < 82$ $N > 126$

Study excited states in  $^{207}\text{Hg}$  for the first time using transfer reactions,  $^{206}\text{Hg}(d,p)$  @ 7.4 MeV/A,  $5 \times 10^5$  pps,  $165 \mu\text{g}/\text{cm}^2$ , 140-keV FWHM.

*on-axis singles*

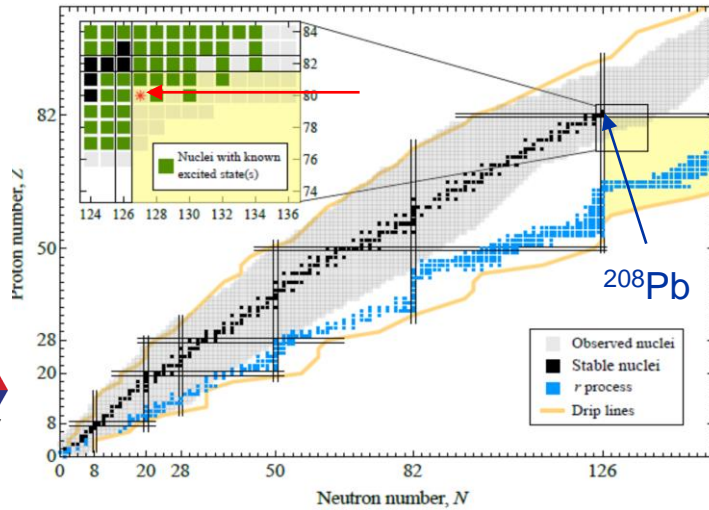

A first step in improving the understanding of  $sp$  structure of nuclei in a key part of the  $r$  process

Tang et al.  
PRL 124, 062502 (2020)

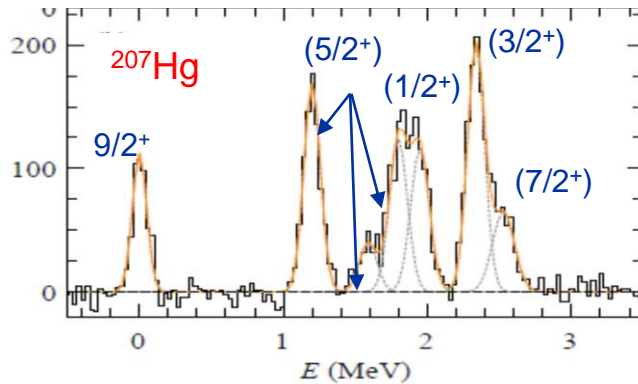

## (ii) Single-particle evolution driving shape changes

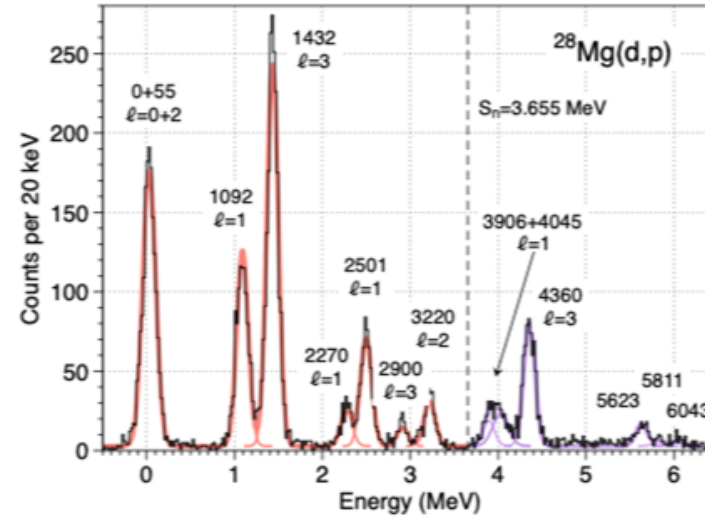

Map single-particle trends close to abrupt shape change in  $^{30}\text{Mg}$ :  $^{28}\text{Mg}(d,p)$  @ 9.47 MeV/A,  $10^6$  pps, 80 and 120  $\mu\text{g}/\text{cm}^2$ , 150-keV FWHM.

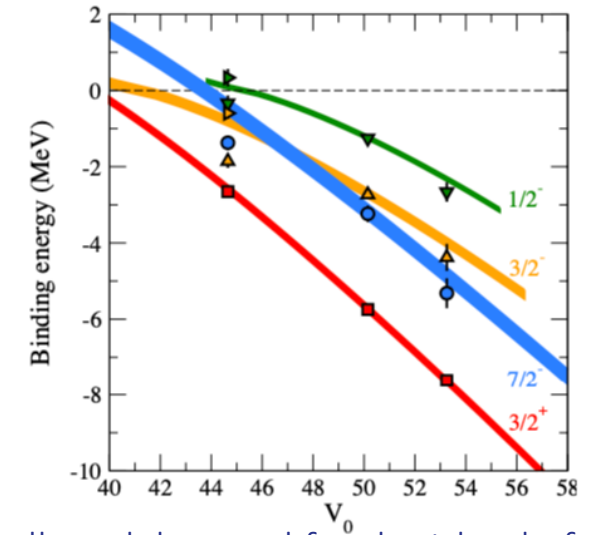

*Si recoil detector*

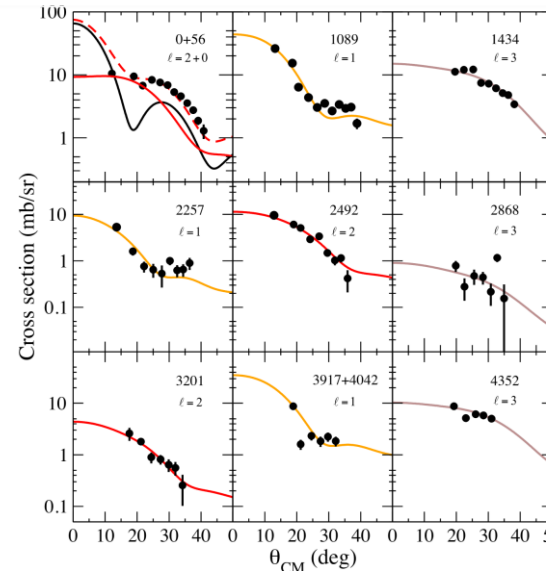

Tests of shell models tuned for the Island of Inversion and highlights the role of geometry of the binding potential on behaviour of orbitals close to threshold.

MacGregor et al.  
PRC Letts 104, L051301 (2021)



# Transfer-induced fission:

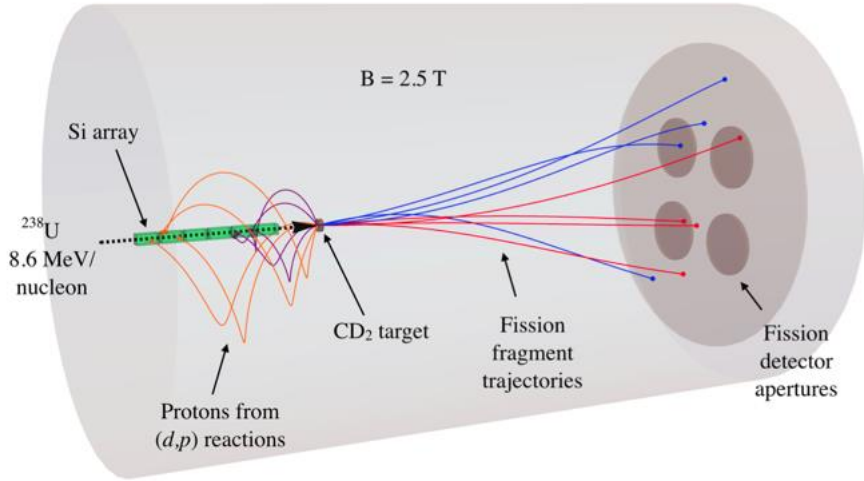

Proof of principle  
 experiment using the  
**HELIOS@ANL**  
 $^{238}\text{U}(d, pf) \text{ 8.6 MeV/u}$

Accepted PRL 2023

MANCHESTER  
1824

The University of Manchester

CHALMERS

ISOLDE: MWPC coupled to solar-cell array being developed to study transfer-induced fission

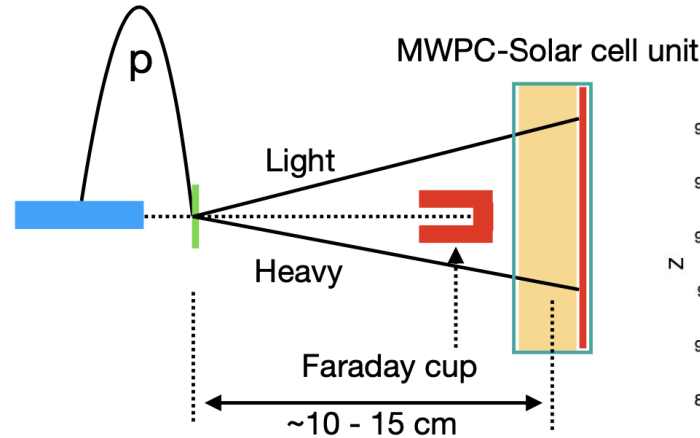

ISOLDE – LISA initiative to develop actinide beams for study

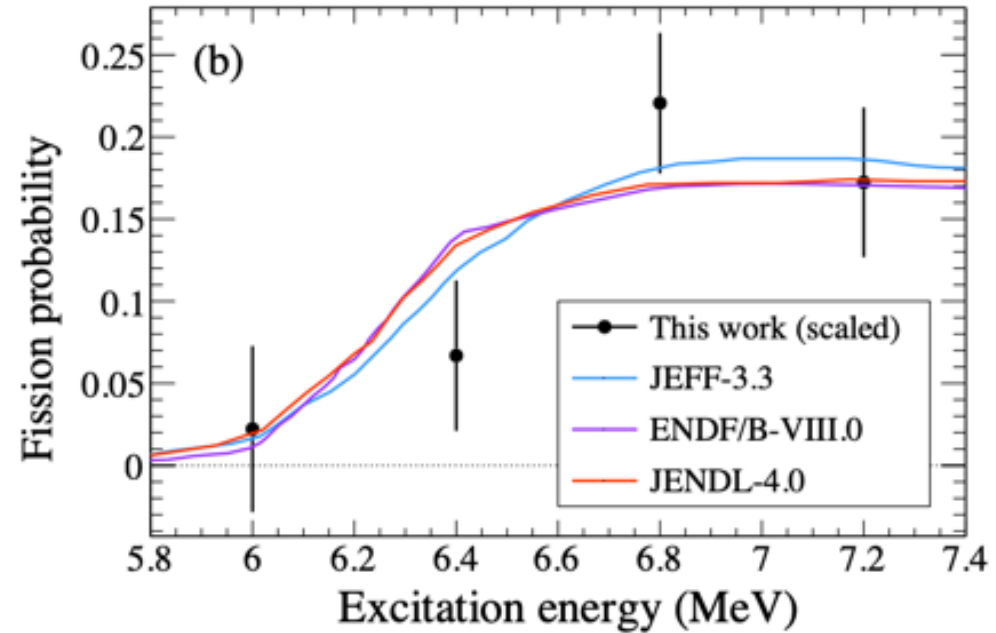
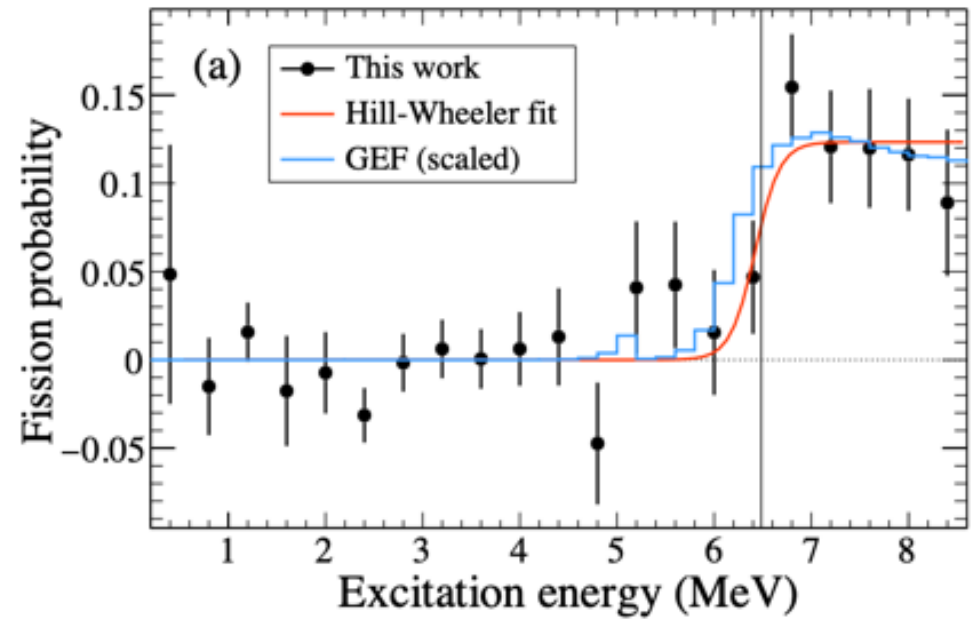
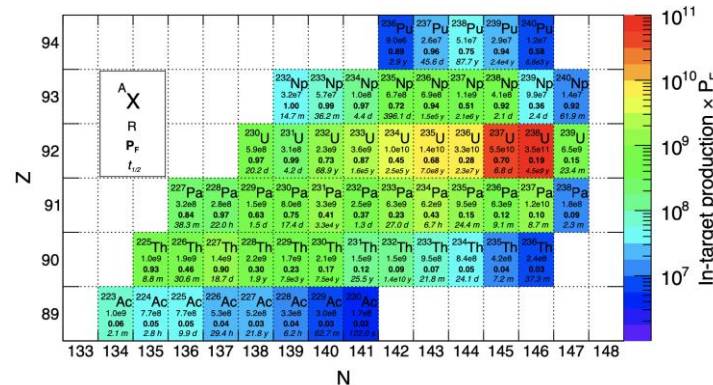

# Large Shape Staggering in Neutron-Deficient Bi Isotopes

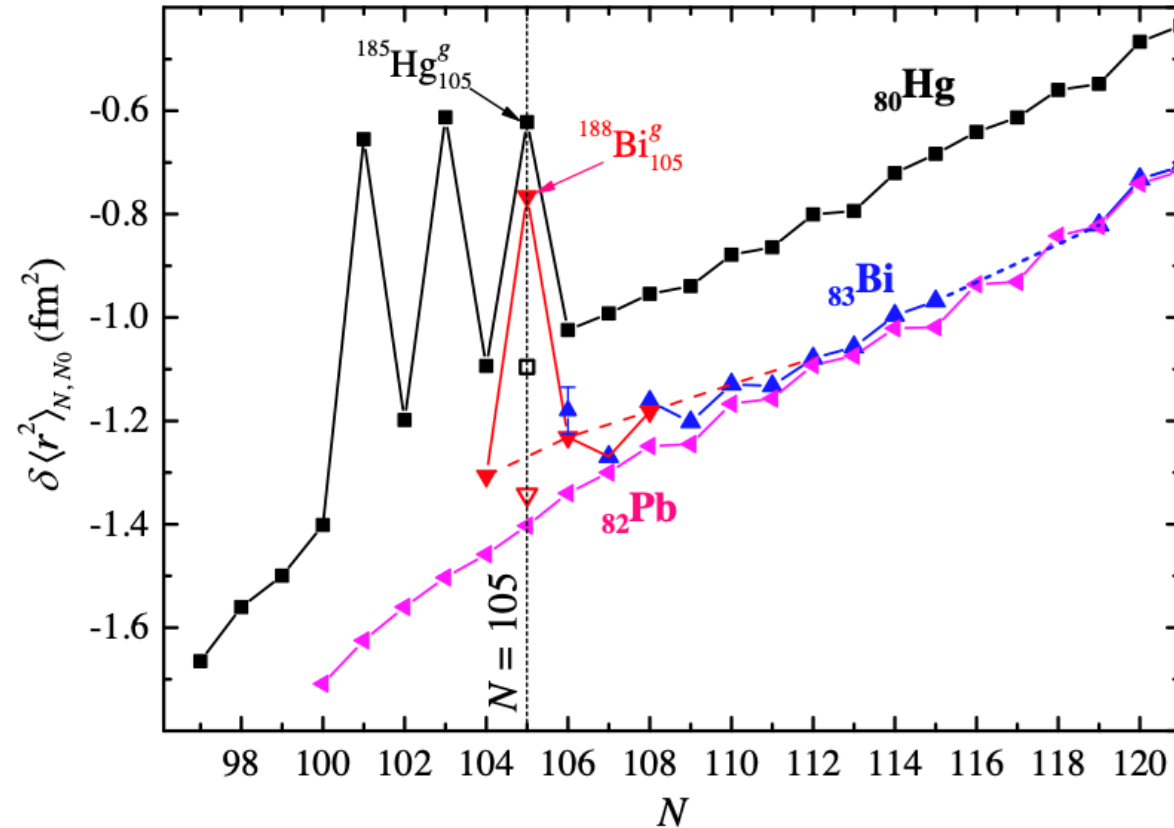

In-source laser spectroscopy – wavelengths of ionising lasers scanned as yields deduced by measurements of  $\alpha$  decay, mapping out the atomic hyperfine structure.

Deduce changes in mean-square charge radii via the isotope shifts.

Spectacular changes in radius in Bi isotopes due to rapidly changing gs shapes.

Only second example of such dramatic changes – Hg isotopes studied at ISOLDE 50 years ago.

*PRL 127, 192501 (2021)*



# ISS Science Programme: (d,p) studies



Early implementation 2018

CERN Long Shutdown 2019-20 (🙄)

Fully commissioned 2021

Fully commissioned 2022

For the future:  
(t,p) and (t, $\alpha$ )  
forward-going reactions (d,d')

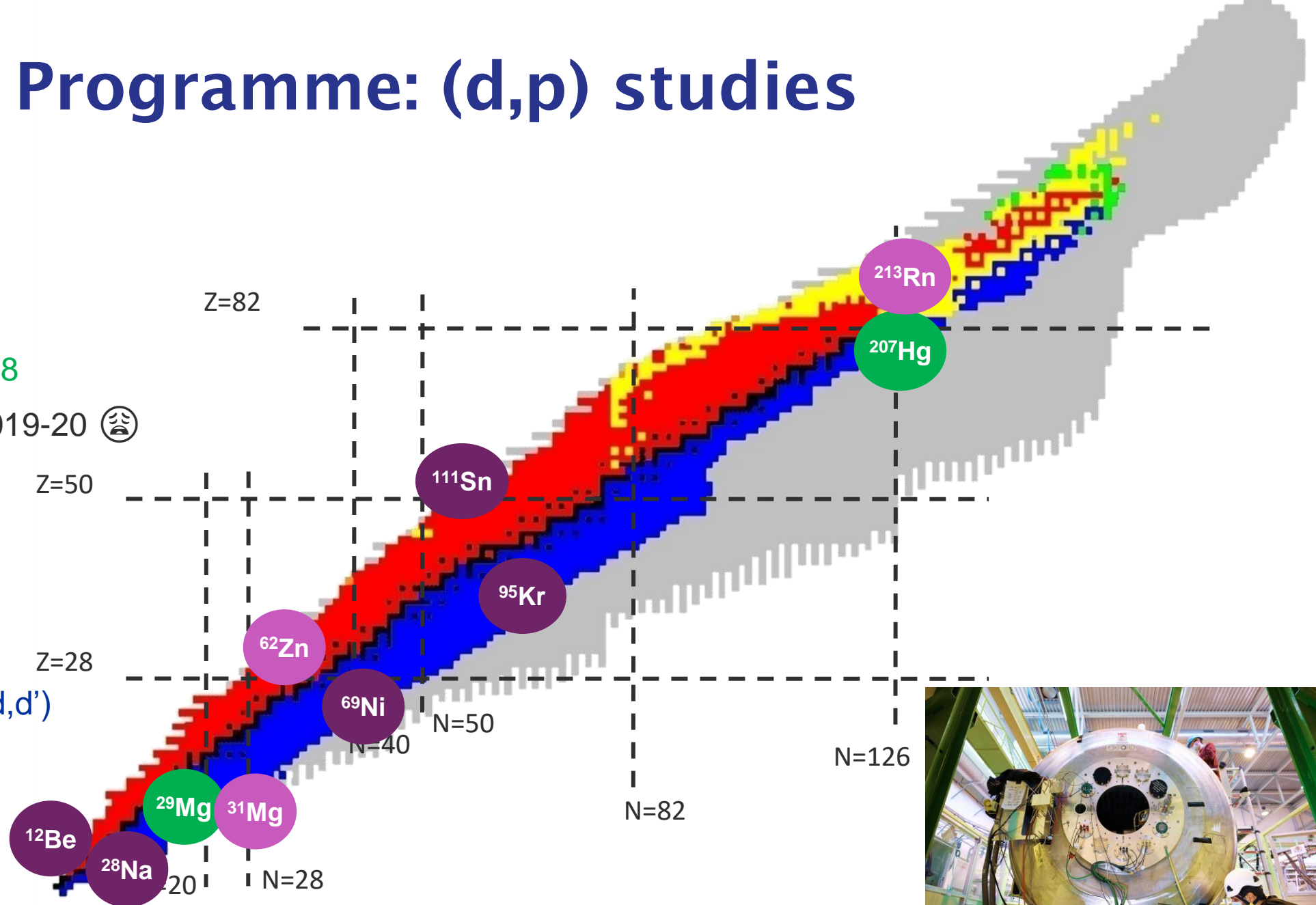

# Third ISS Physics (CERN Run 2) 2022 – with ISS Si array.

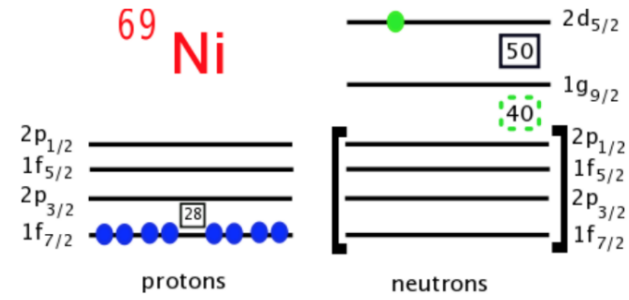
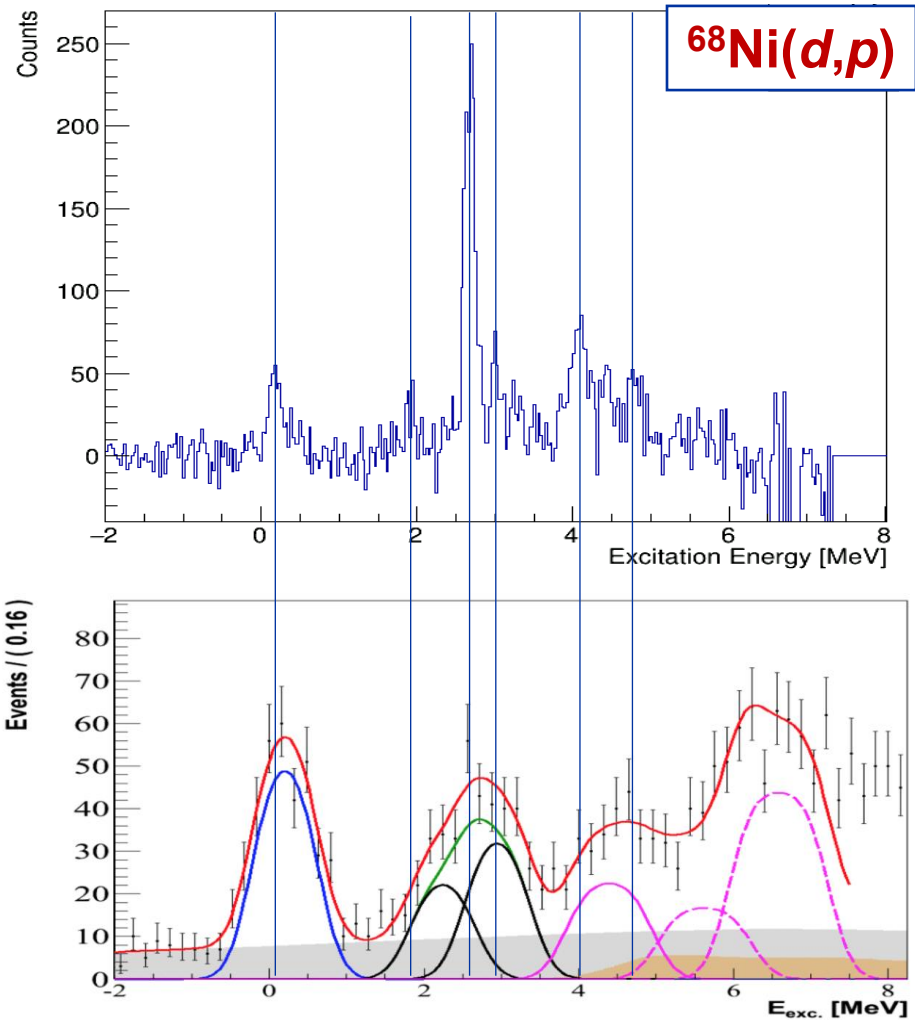

- $^{68}\text{Ni}$   $\sim 2 \times 10^4$  pps @ 6.0 MeV/u
- $N = 50$  shell gap approaching  $^{78}\text{Ni}$
- Intruder configurations leading to shape coexistence

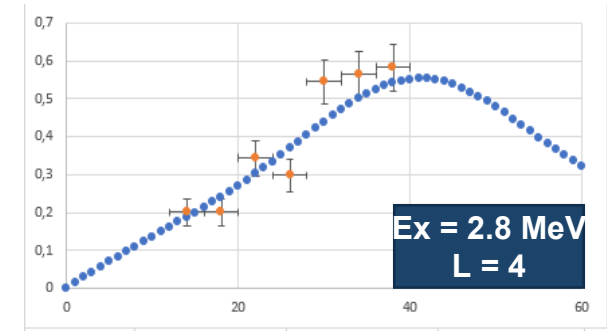
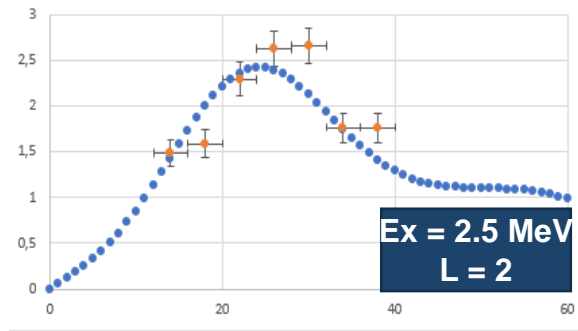

GANIL experiment  
(2010, unpublished, M. Moukkamad et al.)  
 $E_{\text{beam}} = 25.14$  MeV/u;  $\text{CD}_2$  Target : 2.6  
mg/cm<sup>2</sup>

KU LEUVEN

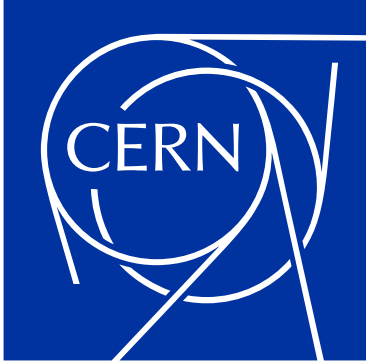

[home.cern](http://home.cern)