

Color-flow in $t\bar{t}$ events at D0

Andy Haas, SLAC

BOOST 2011 Workshop
May 24, 2011

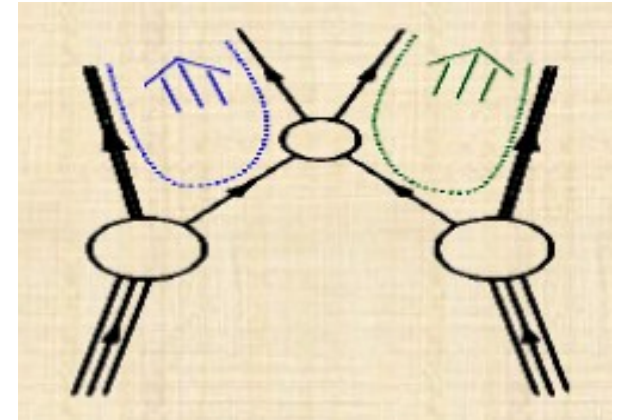
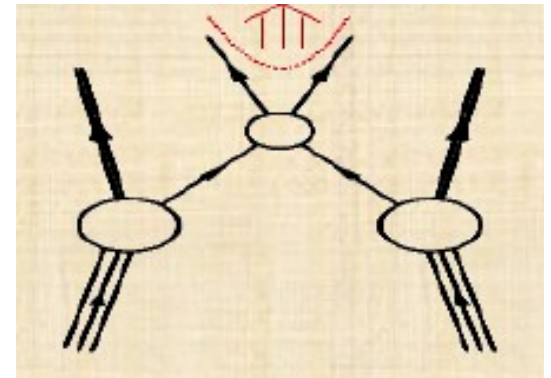

What is "color flow" ??

- QCD color charge is conserved locally
 - It "flows", just like electric charge
 - Quarks carry one **color** (triplet)
 - Gluons carry a **color** and an **anti-color** (octet)
 - Others (W,Z,H,etc.) carry no color (singlet)
-
- Pulling apart a color from its anti-color takes a lot of energy ($\sim 1 \text{ GeV/fm}$)
 - "color string" or "color connection" formed
 - Eventually color strings "break" by pulling quarks out of the vacuum \rightarrow *hadronization*

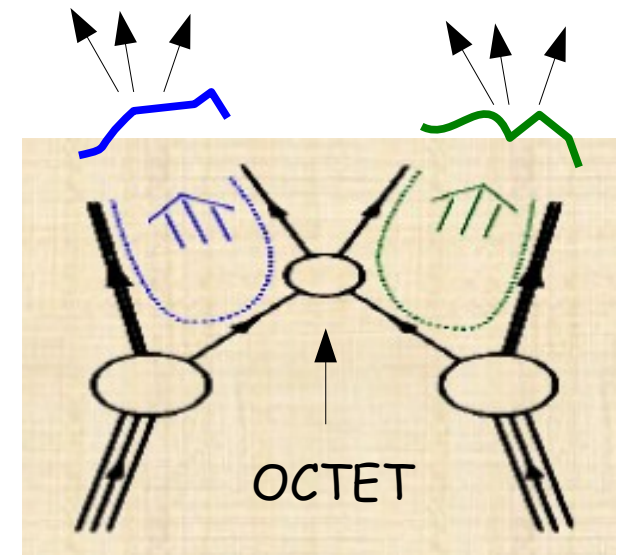
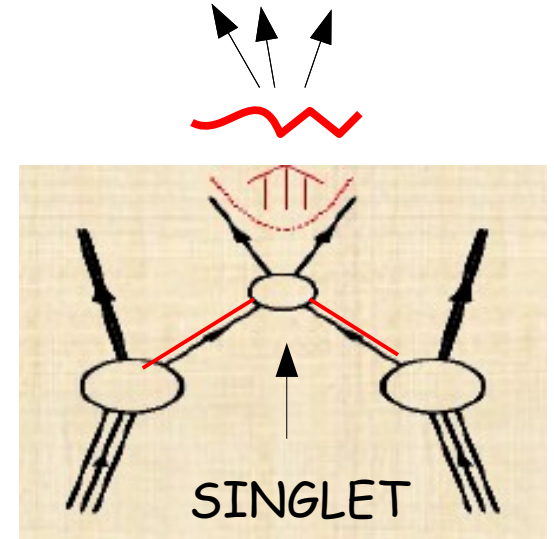

How to see color flow → "Jet Pull"

Jets are not "round" → shape is influenced by color flow !!!

Pull vectors point more *towards* each other for color singlet than octet

0.5 RunII cone jet,
loop over all cells in $dR < 0.7$:

$$\vec{\theta} = \sum_i \frac{E_T^i |r_i|}{E_T^{\text{jet}}} \vec{r}_i$$

where r points from
jet center to each cell

Matt Schwartz and Jason Gallicchio
Phys.Rev.Lett.105:022001,2010
<http://arxiv.org/abs/1001.5027>

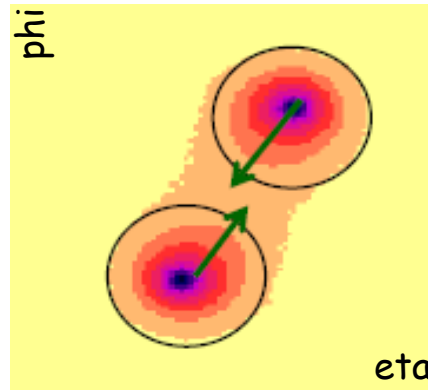

SINGLET

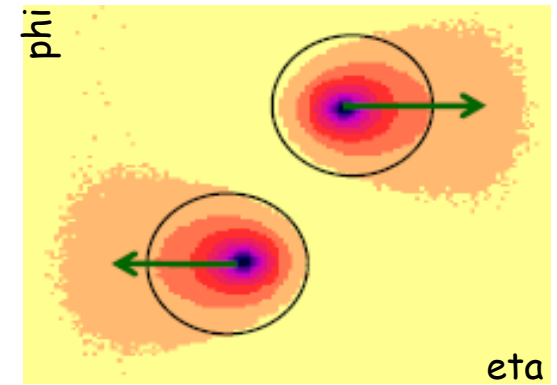
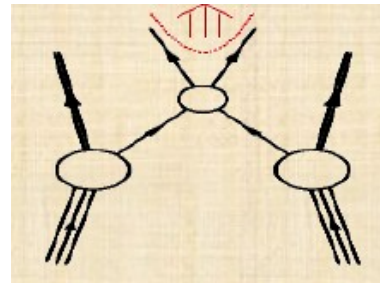

OCTET

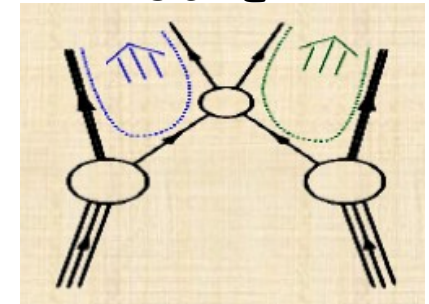

How to see color flow → "Jet Pull"

Jets are not "round" → shape is influenced by color flow !!!

Pull vectors point more *towards* each other for color singlet than octet

0.5 RunII cone jet,
loop over all cells in $dR < 0.7$:

$$\vec{\theta} = \sum_i \frac{E_T^i |r_i|}{E_T^{\text{jet}}} \vec{r}_i$$

where r points from
jet center to each cell

Matt Schwartz and Jason Gallicchio
Phys.Rev.Lett.105:022001,2010
<http://arxiv.org/abs/1001.5027>

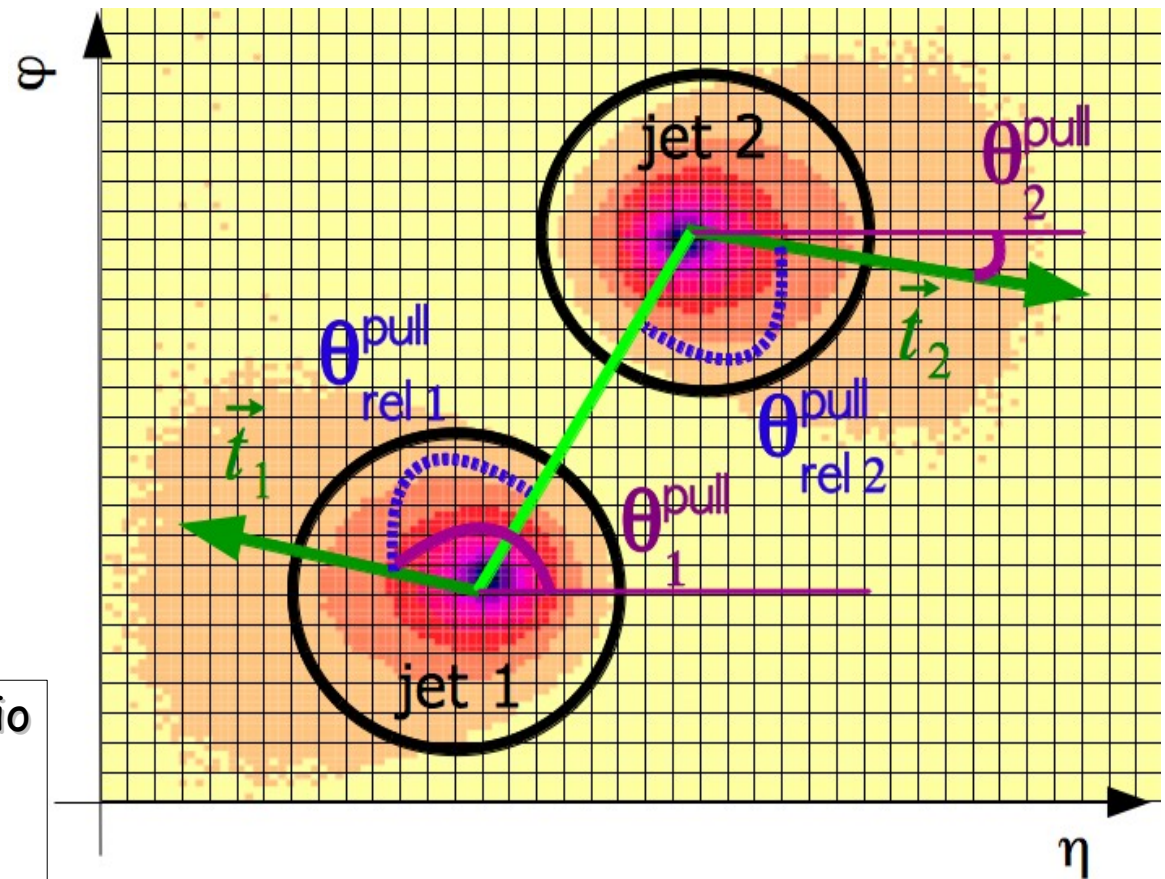

Low mass SM Higgs

Additional difference between $H \rightarrow bb$ and $g \rightarrow bb$:

- H is color singlet - b's must have same color and are "connected together"
- **g is color octet** - b's have different color and are "connected to beam"

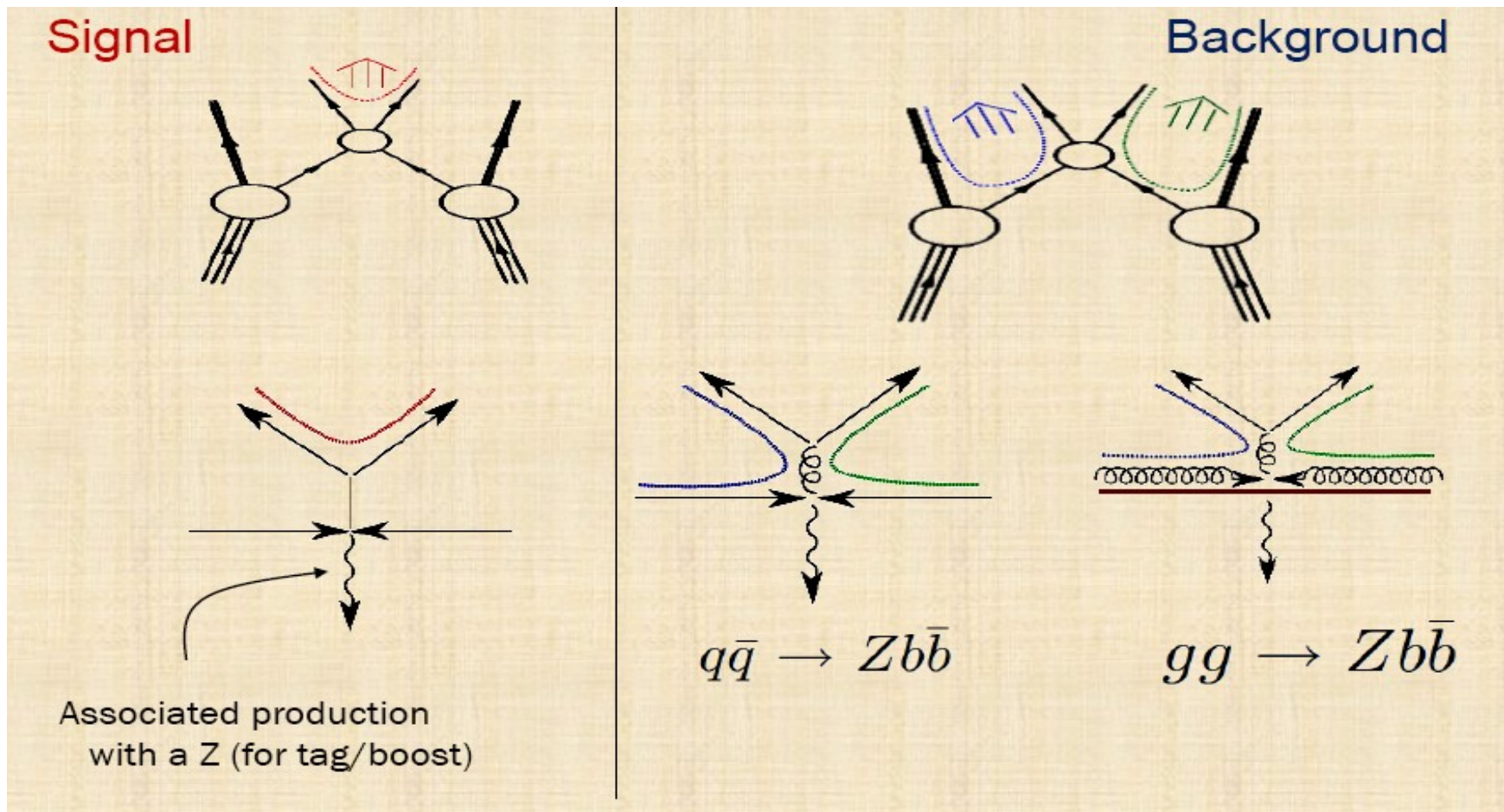

Example from D0 Higgs analysis

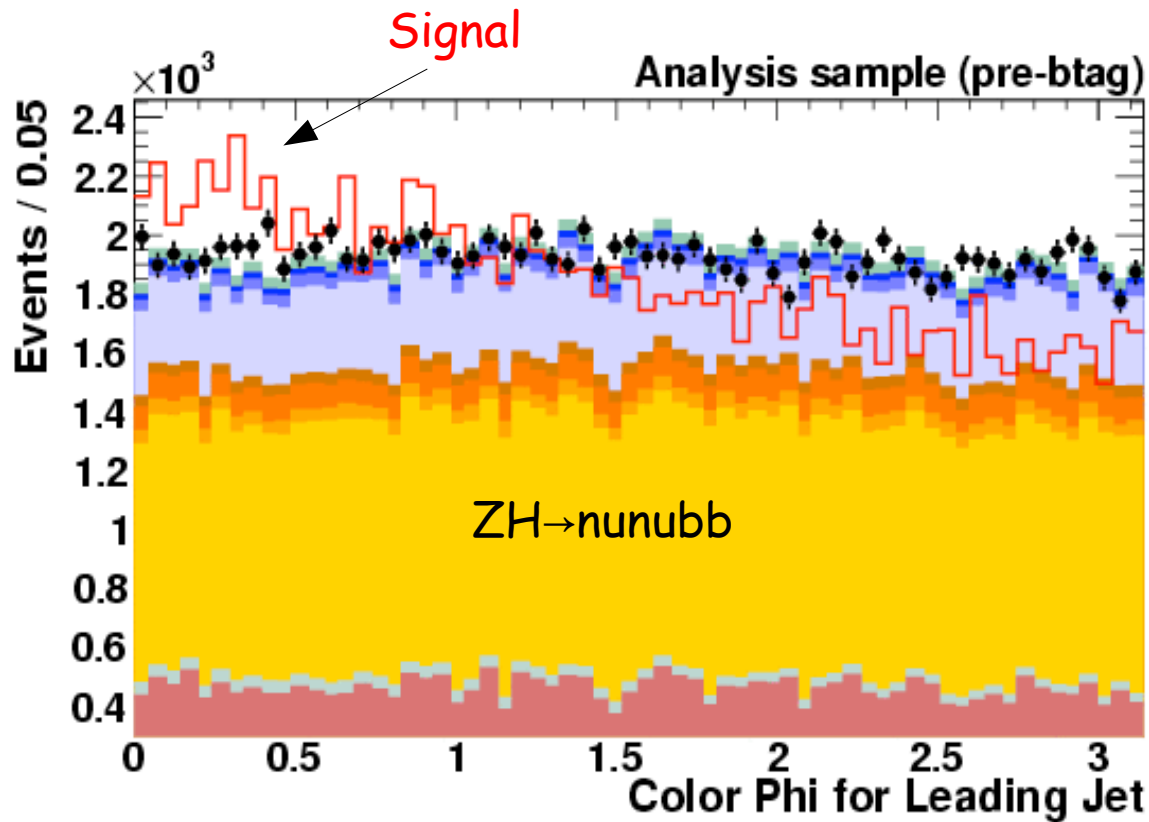

Used for D0's
ZH \rightarrow nu nu bb search

Extra ~5% sensitivity !

(Could be improved to ~10%?)

Background (mostly octet) shape well-modeled by MC

But is the signal (singlet) shape well-modeled by MC?

("Color flow" studied at LEP, but not jet pull, and these are hadron collisions...)

Testing color singlet jet pull in data

- Need clean sample of $W/Z/H$ decays to jets
- $t\bar{t}$ is the most promising
 - Have ~ 500 double b-tagged lepton + 4-jet events at D0
 - $\sim 90\%$ pure $t\bar{t}$ sample
- $W \rightarrow jj$ decay is pure color singlet
- Verifying singlet color flow / jet pull for the first time at a hadron collider

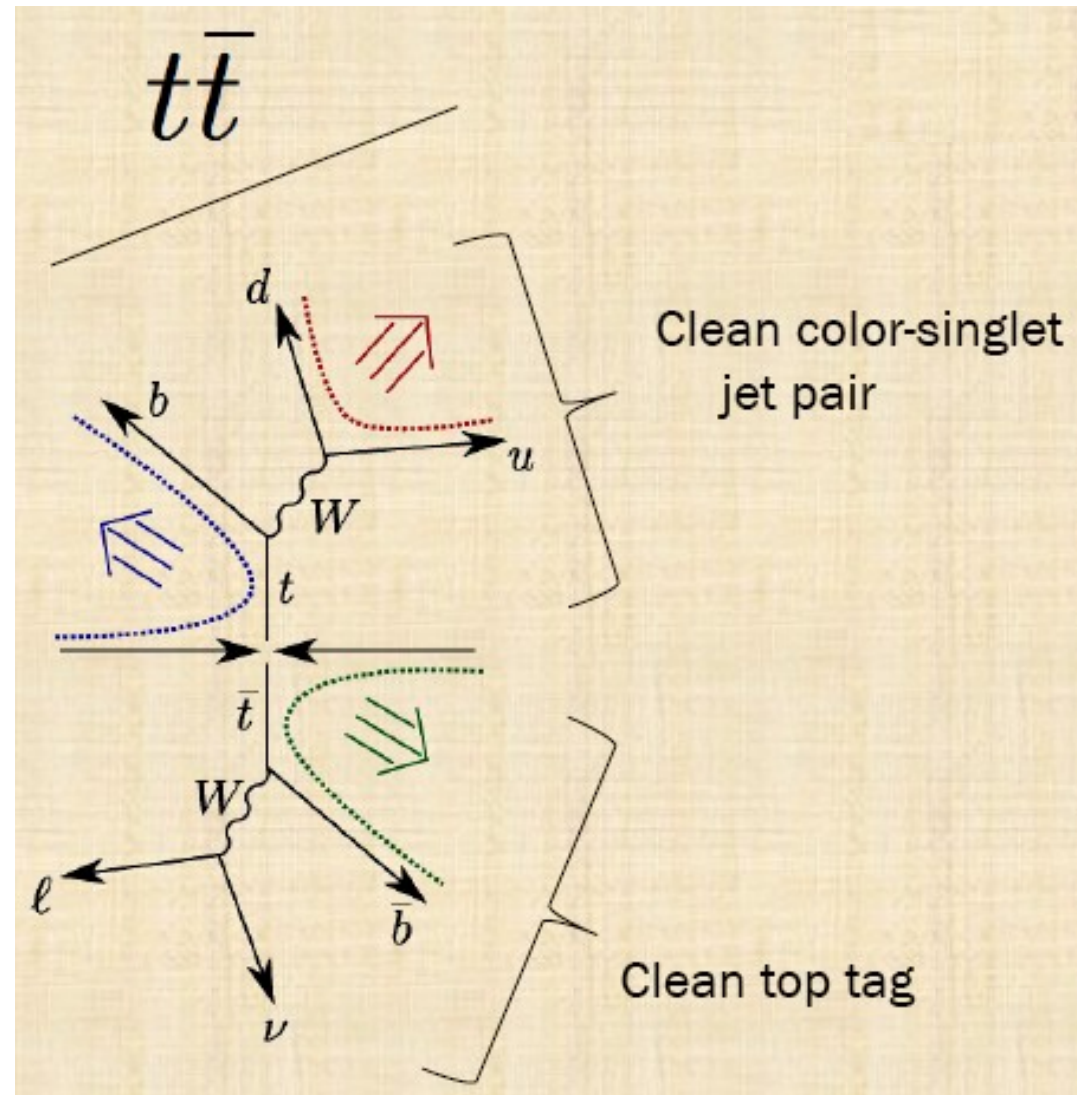

Added "jet pull" variables to standard D0 l+jets analysis

5.3/fb L+jets selection

- Dataset: Run IIa & full RunIIb2 (Summer09 extended)
- SuperOr trigger for e+jets, SingleMuonTrigger for mu+jets Run IIb, MuJets for Run Iia
 - ◆ SingleMuonTrigger: Now the fully debugged version!
- Require one isolated electron or muon with $p_T > 20\text{GeV}$
- $\cancel{E} > 20\text{GeV}$ (e) or $\cancel{E} > 25\text{GeV}$ (mu)
- 3 or at least 4 (in Run IIb: vertex confirmed) jets
 - ◆ $p_T > 20\text{GeV}$
 - ◆ leading jet $> 40\text{GeV}$
- Triangle cut:
 - ◆ ejets: $d\phi(\cancel{E}, \text{lep}) > 2.2 - 0.045\cancel{E}$
 - ◆ mujets: $d\phi(\cancel{E}, \text{lep}) > 2.1 - 0.035\cancel{E}$
- Additional cuts in mu+jets: $M_T^W < 250\text{GeV}$ & $\cancel{E} < 250\text{GeV}$

Extra Cuts:
 ≥ 2 L4 b-tags
4 or ≥ 5 jets
 $|m_{W-(jj)}| < 30$

Standard CSG MC samples

$t\bar{t}$ MC:

AlpGen+Pythia, top mass 172.5GeV

Studies of $t\bar{t}$ lepton+jets

- 66% (46%) pure $W \rightarrow jj$ decays in $|M-mW| < 30$ GeV for 4 (≥ 5) jets

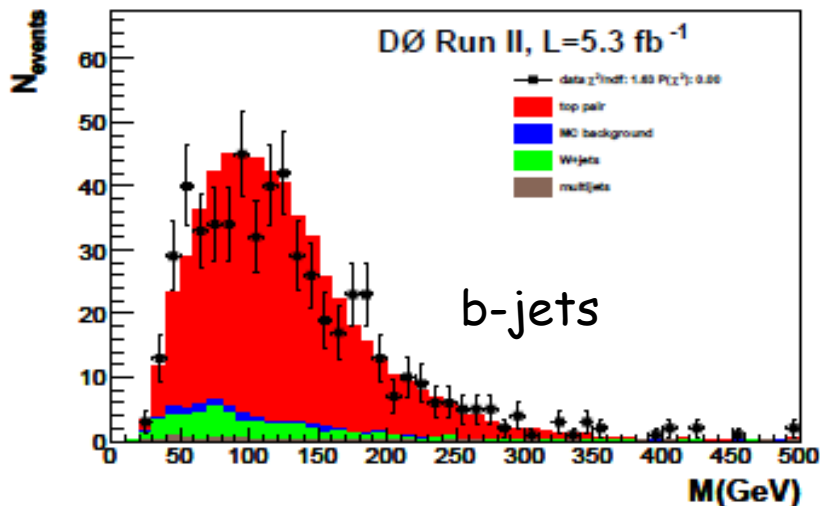
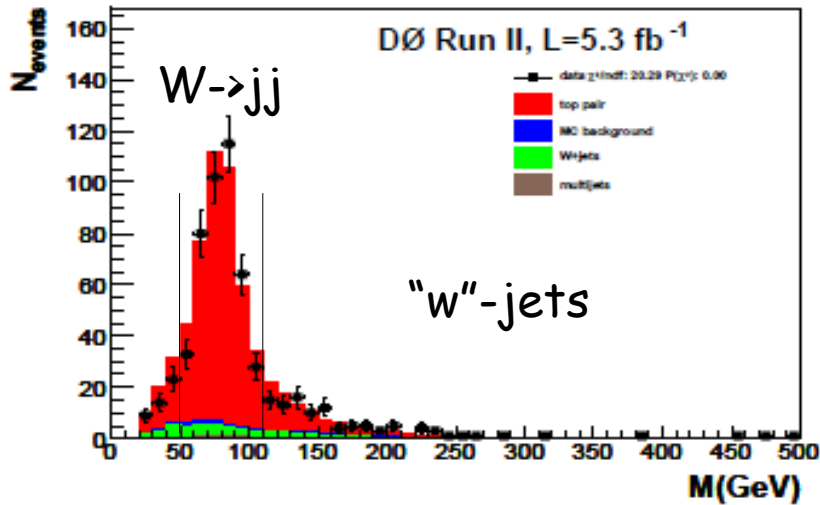

channel	sample	0 b -tags	1 b -tag	≥ 2 b -tags
$\ell+4$ jets	W +jets	576 ± 75	229 ± 32	49 ± 8
	Multijet	115 ± 16	46 ± 7	7 ± 2
	Z +jets	42 ± 6	16 ± 3	4 ± 1
	Other	31 ± 4	19 ± 2	9 ± 1
	$t\bar{t}$	160 ± 22	417 ± 38	519 ± 51
Total	923 ± 62	727 ± 24	589 ± 48	
Observed	923	743	572	
$\ell+\geq 5$ jets	W +jets	60 ± 22	26 ± 11	7 ± 3
	Multijet	17 ± 3	12 ± 2	3 ± 1
	Z +jets	4 ± 1	2 ± 1	1 ± 1
	Other	3 ± 1	3 ± 1	2 ± 1
	$t\bar{t}$	34 ± 6	90 ± 13	132 ± 17
	Total	118 ± 19	132 ± 7	145 ± 15
Observed	112	127	156	

ttbar event display

Run 250150 Evt 12909475 Mon Mar 9 13:06:04 2009

Triggers:

DMU3_ITK10_ILM6
 DMU3_LM6_TK12
 DMU3_TK8_TLM8
 DMU6_ITK10_ILM6_NOLUM
 DMU6_LM6_TK12_NOLUM
 DMU6_TK8_TLM8_NOLUM
 DTAJT2_2T102TK
 DTAJT2_2T10NN1
 DTAJT2_2T10NN3TK
 DTAU2_2TNN12TK
 DTAU2_T15NN3T20K
 JT125_L3J125
 JT125_L3J125_NOLUM
 J m M

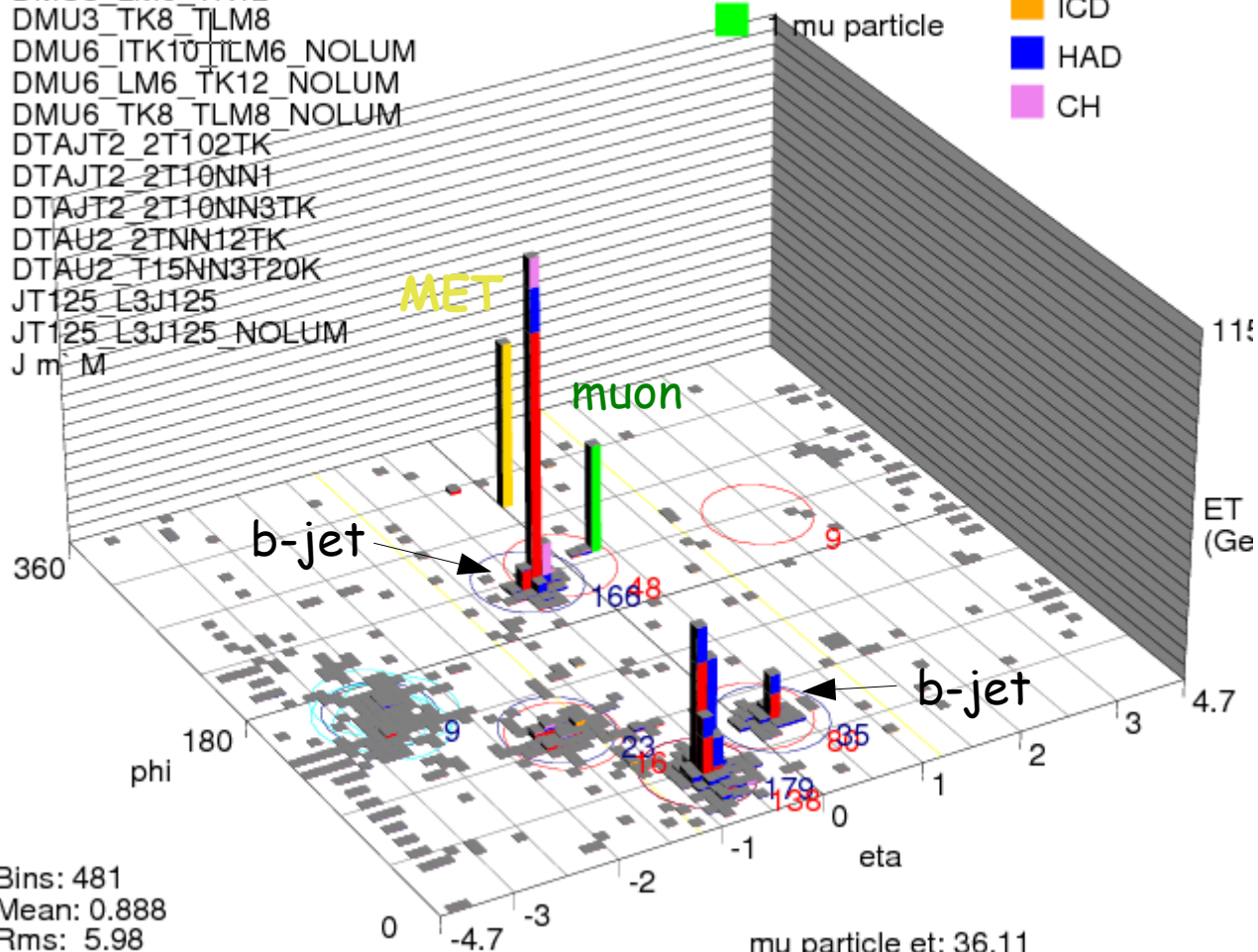
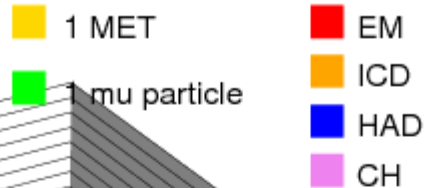

Bins: 481
 Mean: 0.888
 Rms: 5.98
 Min: 0.00316
 Max: 111

mu particle et: 36.11
 MET et: 55.86

Jet pull reconstruction

Compute "MC truth jet pull"

- Use truth particles within $dR < 0.7$ of jet and $|dz| < 1$ cm of primary vertex (except muons and neutrinos)

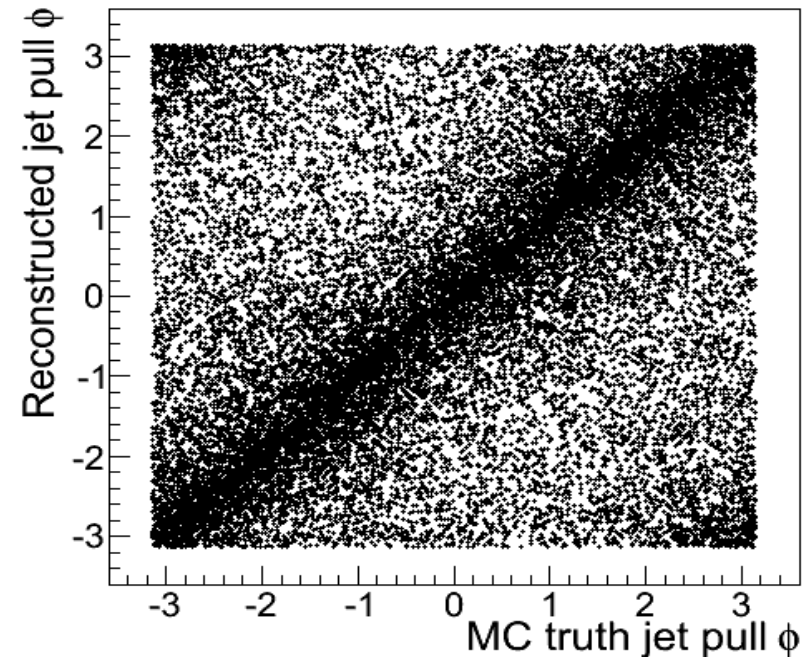
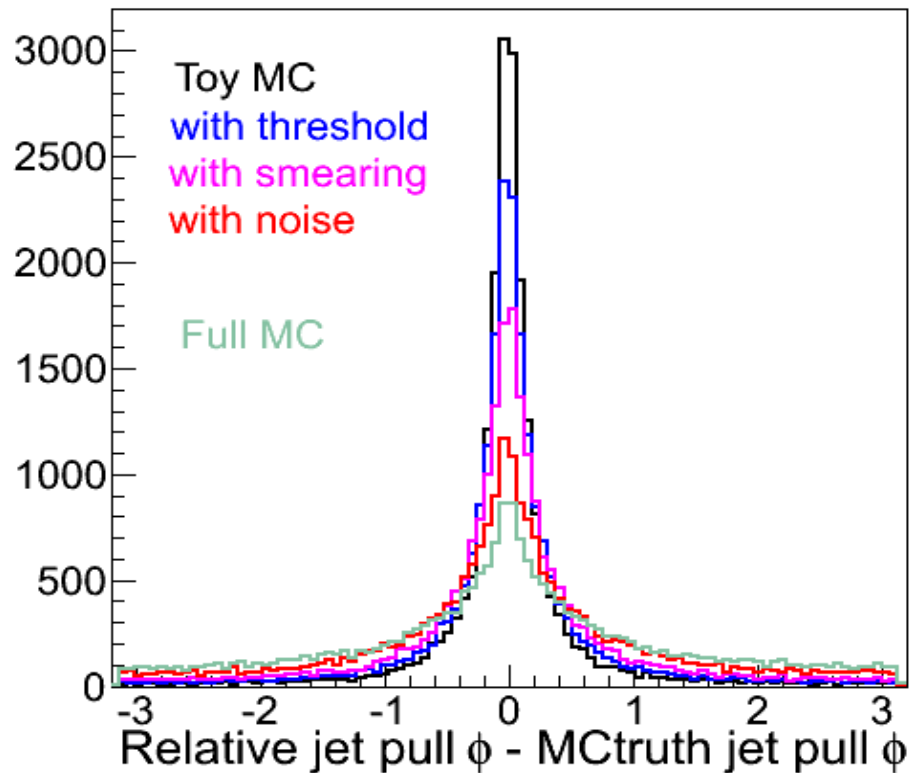

← Do a "Toy MC" of calorimeter to see effects individually of:

- detector granularity
- energy thresholds / resolution
- detector noise / pileup

Separated by eta's of jets

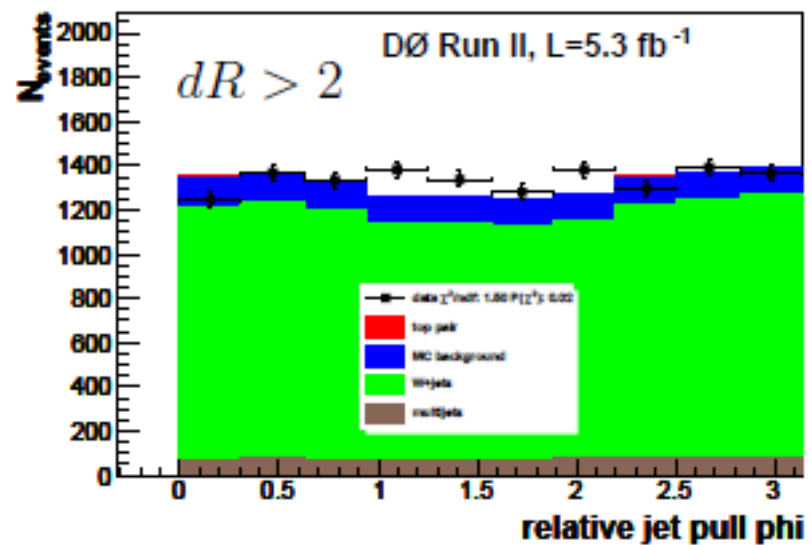
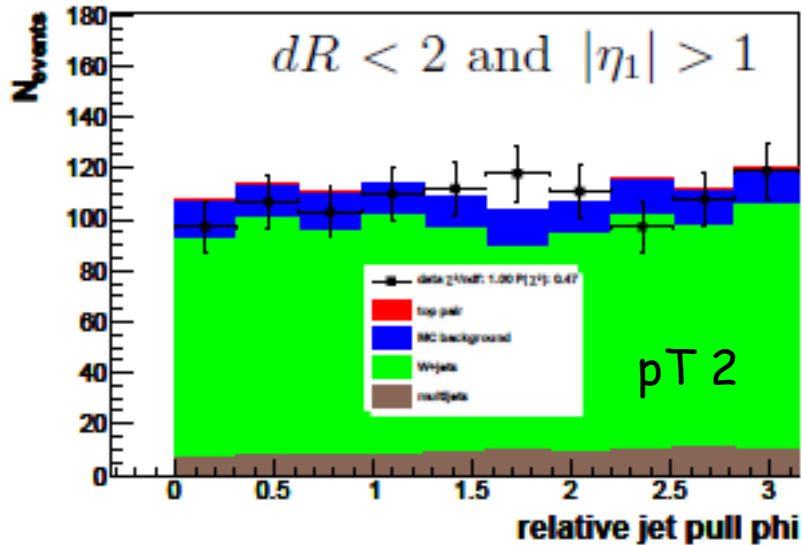
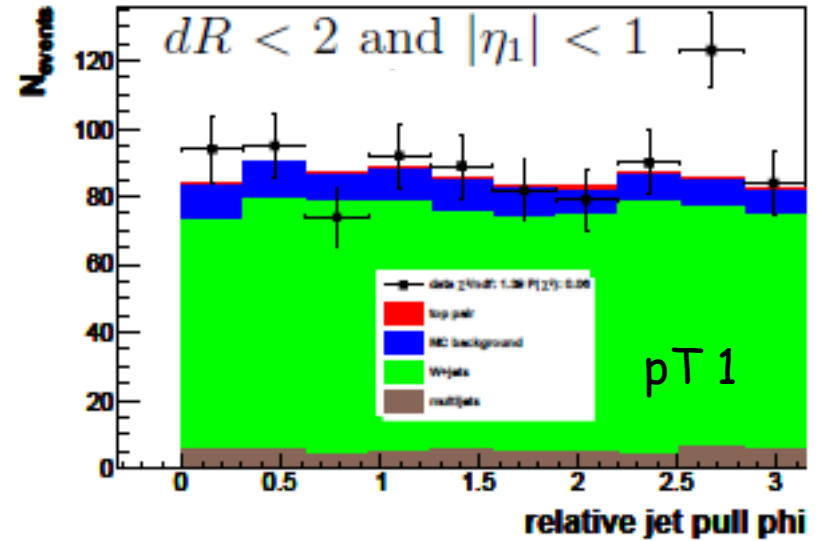
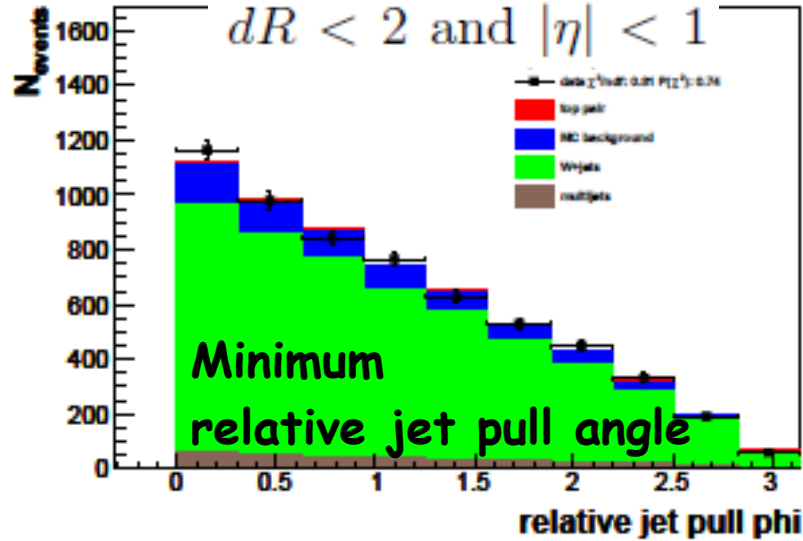

W + 2 light jets sample

Checks of jet pull reconstruction

- Look at jets which were **split** and **not split**
- Also check dependence on jet eta, cone size, dR, pileup, etc. (see backup slides)

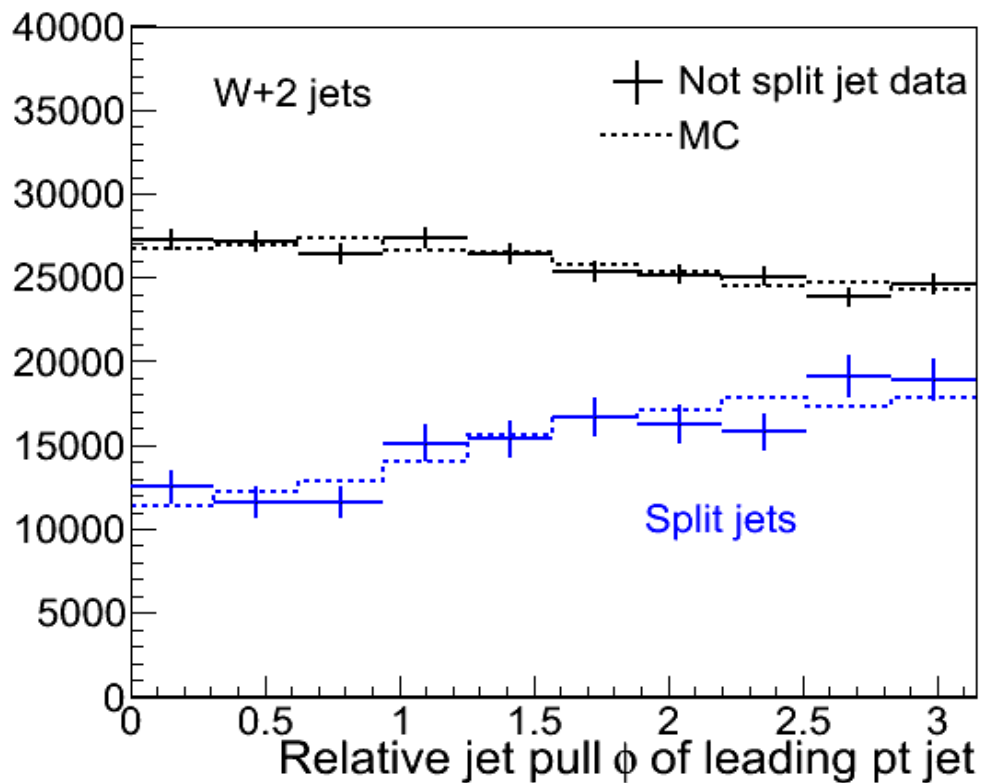

Noise/pileup area smaller towards other jet!

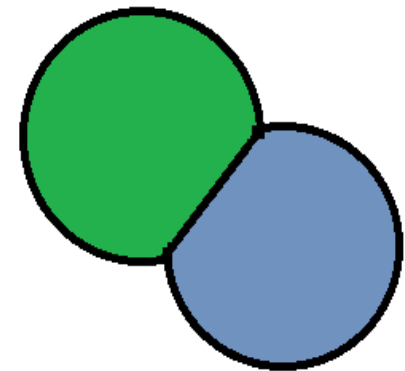

Cells are assigned to the *nearest jet*

Jet pull in $t\bar{t}$ bar, data/MC

- Good data/MC agreement, for both "w" and b jets
- w-jets peak more towards zero (pointing towards each other) !
- But this is not an apples-to-apples comparison \rightarrow different kinematics and flavor for the light and b jets
- Next we do a *direct* comparison, in events with identical kinematics

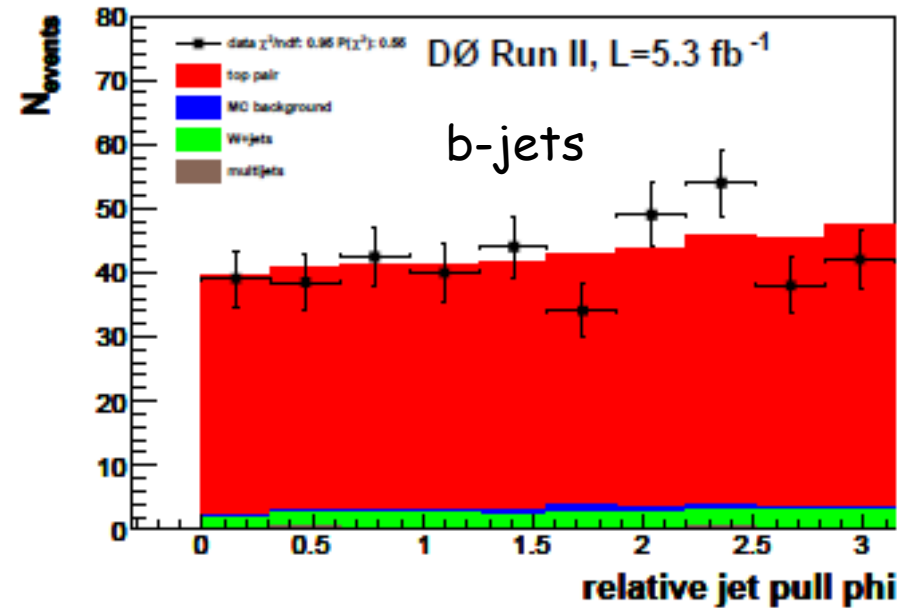
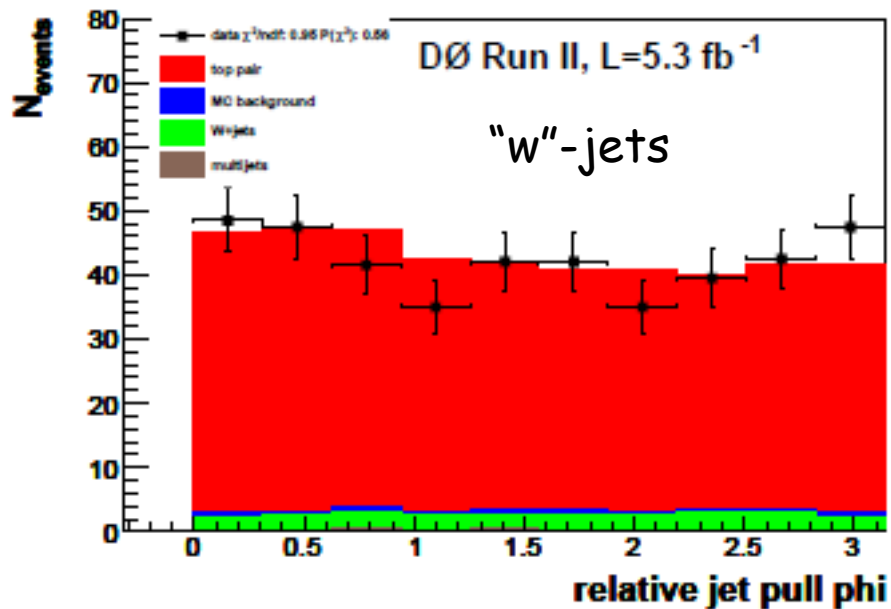

What "color" is the X in $t\bar{t} \rightarrow b\bar{b}W(-\rightarrow l\nu)X(-\rightarrow qq')$?

- Of course we know that X is a W, which is a color singlet...
- Test our sensitivity to separate singlet/octet and simulation modeling
- $t\bar{t}$ MC with OCTET hadronic "X" decay using MadGraph+Pythia

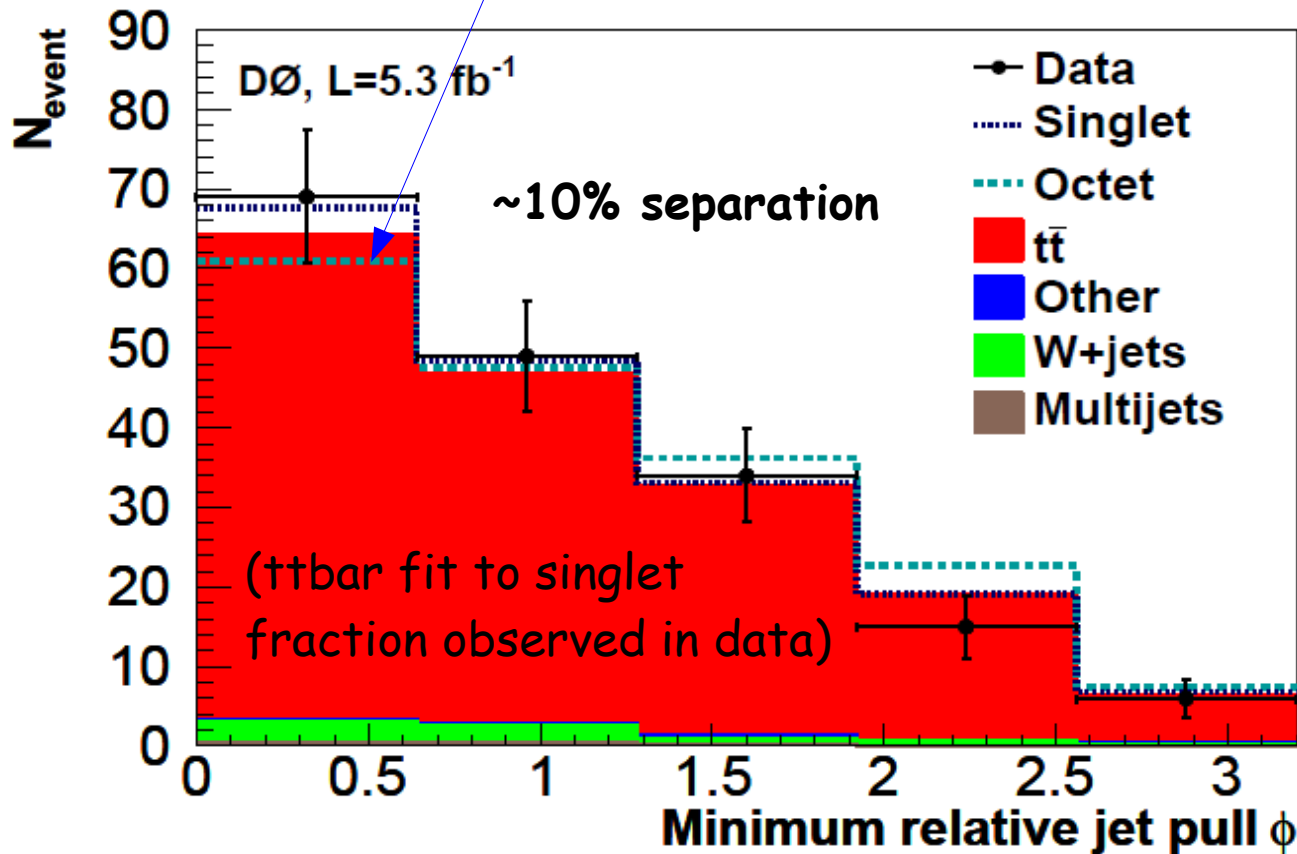

Split into 5 "regions" based on dR , η , and m_W

Central region, $|M-m_W| < 30$, with $dR < 2$ is most sensitive \rightarrow need BOOST

Data prefer a color singlet "X"

Systematics on jet pull shape

ALPGEN+Pythia agrees with ALPGEN+Herwig showering

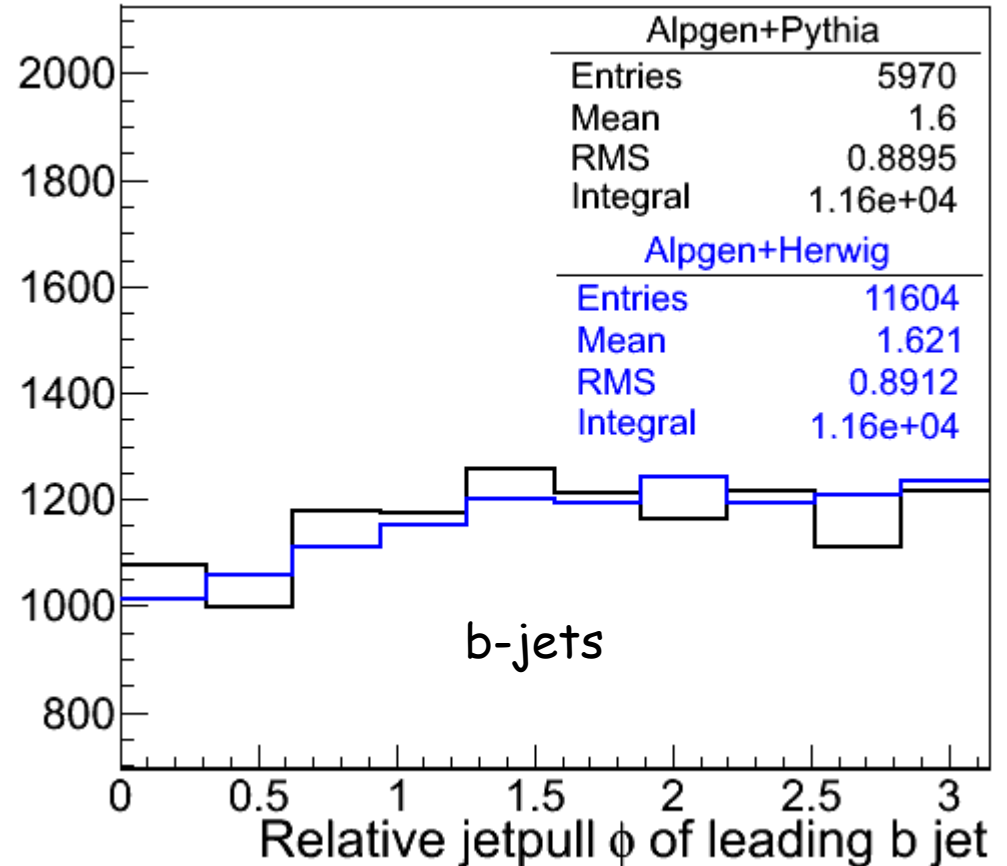
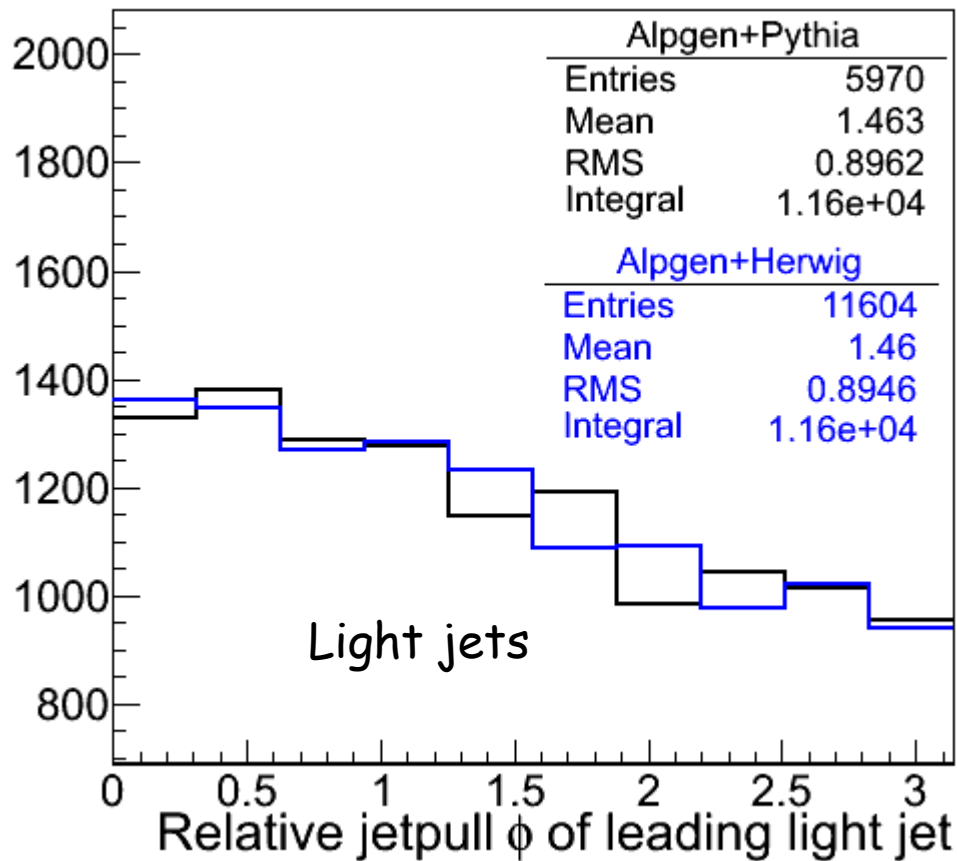

Systematics on jet pull shape

- Various Pythia "tunes", underlying event, other parameters, etc.
 - All give similar jet pull shapes
- **Tune ACR is flatter, unphysical color reconnection model for W**

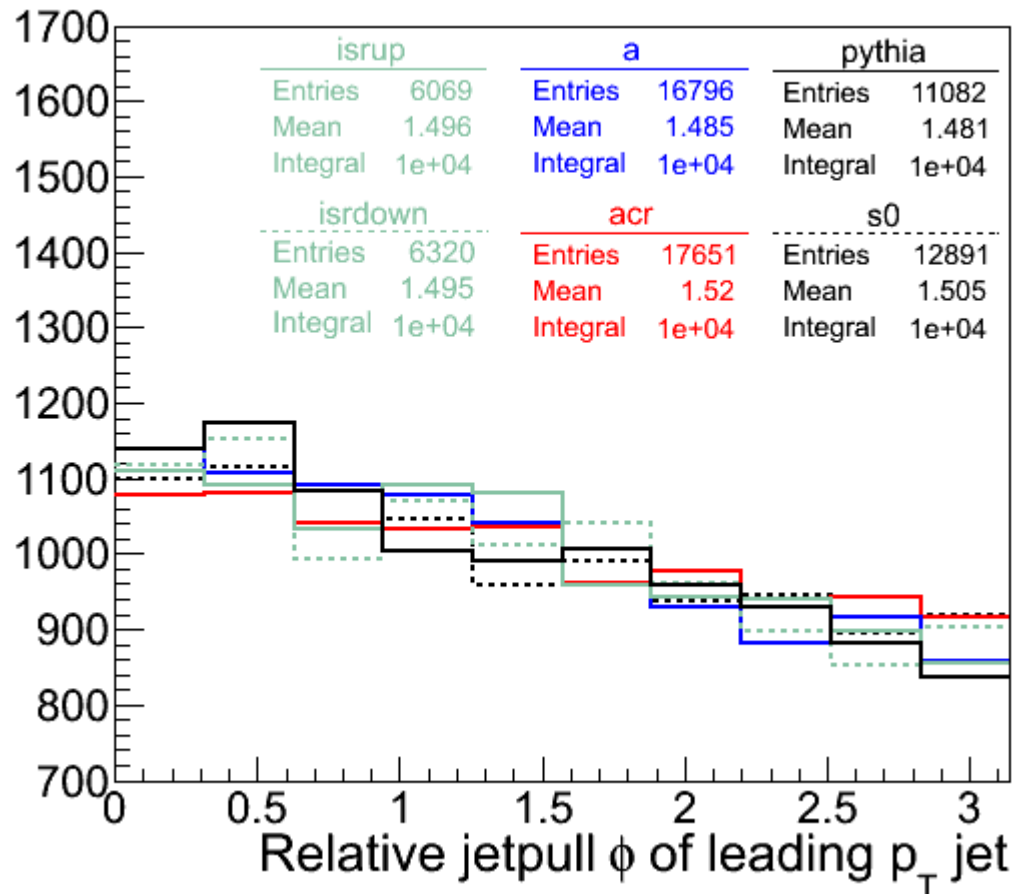

Systematics on jet pull shape

- Recent Pythia tunes have a more physical way of turning on/off color reconnection, while still maintaining (most) agreement with UE
- No large effects from color reconnection (theoretically also <10%)

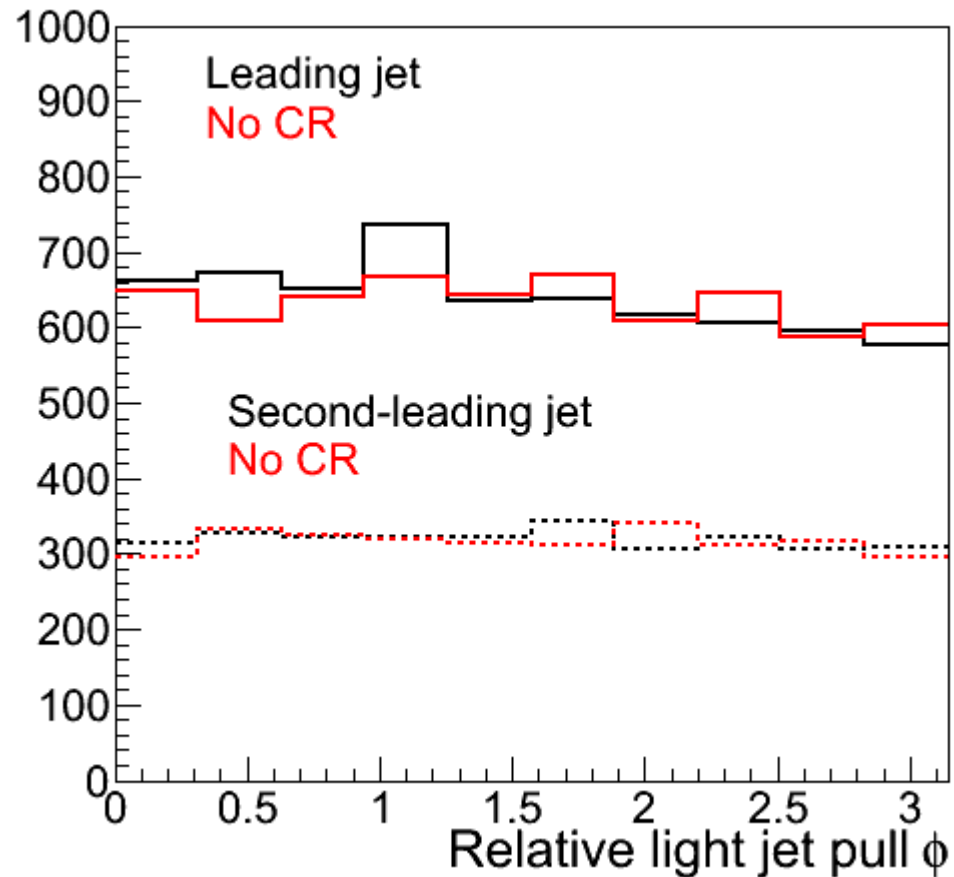

Systematics

- Limited MC stats for singlet/octet templates
 - Private production
 - Managed to make ~1M events
 - Still less than statistical uncertainty from data
- Next largest is data/MC correction for jet eta dependence (ICR region)

Source	$+\sigma$	$-\sigma$
Singlet/octet MC shapes	0.188	-0.188
Jet pull reconstruction	0.100	-0.093
Jet energy resolution	0.033	-0.013
Vertex confirmation	0.028	-0.029
PYTHIA tunes	0.023	-0.025
Jet energy scale	0.024	-0.009
Jet reconstruction and identification	0.017	-0.017
$t\bar{t}$ modeling	0.014	-0.033
Event statistics for matrix method	0.009	-0.010
Other Monte Carlo statistics	0.009	-0.007
Multijet background	0.006	-0.007
Total systematic	0.222	-0.218

What "color" is the X in $t\bar{t} \rightarrow b\bar{b}W(-\rightarrow l\nu)X(-\rightarrow qq')$?

<http://arxiv.org/abs/1101.0648>

Phys.Rev.D 83:092002,2011.

Results!

$$f_{\text{Singlet}} = 0.65^{+0.37}_{-0.38}(\text{stat})^{+0.22}_{-0.22}(\text{syst})$$

$$\sigma_{t\bar{t}} = 8.54^{+0.32}_{-0.31}(\text{stat})^{+0.87}_{-0.81}(\text{syst+lumi}) \text{ pb}$$

- Expected to exclude octet W at 99% CL in >half of experiments
- Data fluctuated by ~ 1 sigma?
Or hint of imperfect simulations?

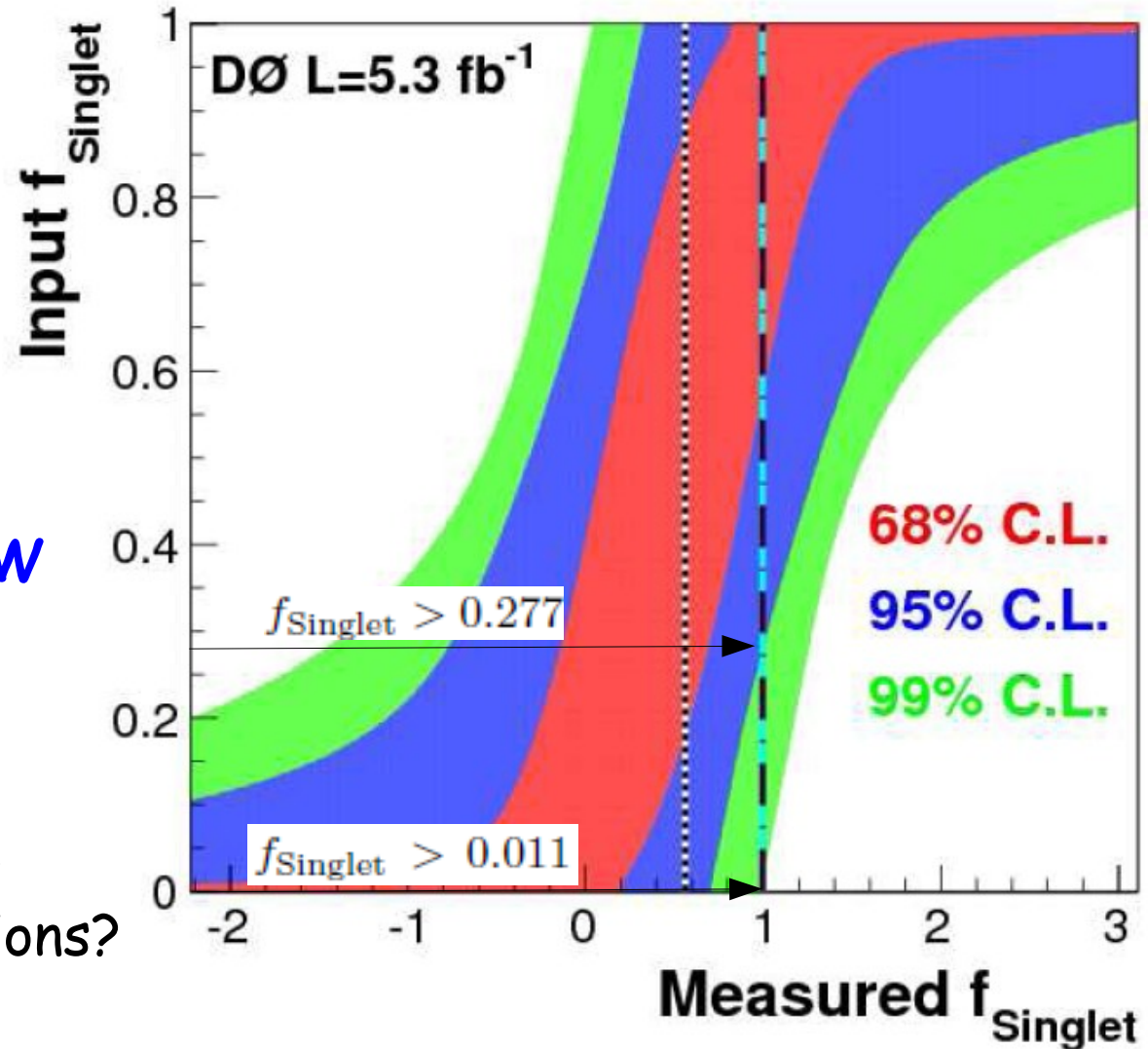

Putting **color** to use

- Help Higgs- \rightarrow bb searches
 - MSSM $b(h\rightarrow bb)$, SM $W/Z(H\rightarrow bb)$, $tt(H\rightarrow bb)$, ...
- Separate s-channel from t-channel single-top
- Test color reconnection in QCD ?
- *Aid in hadronic top-tagging*
- Understand SUSY decay chains
 - Can tell gluino decay from squark decay
 - Reduce combinatorics
- Many other BSM models

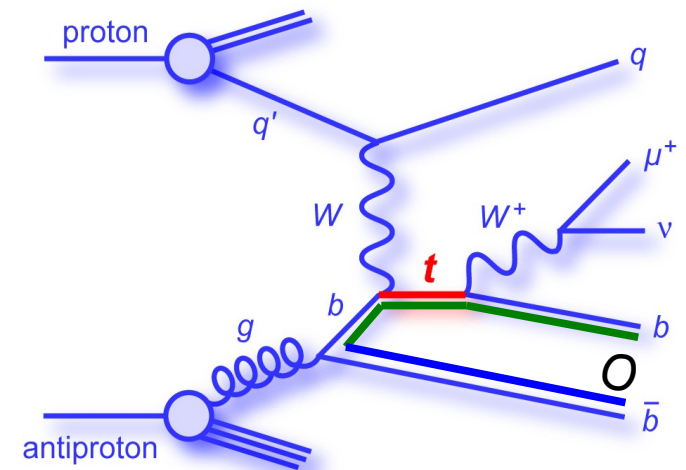
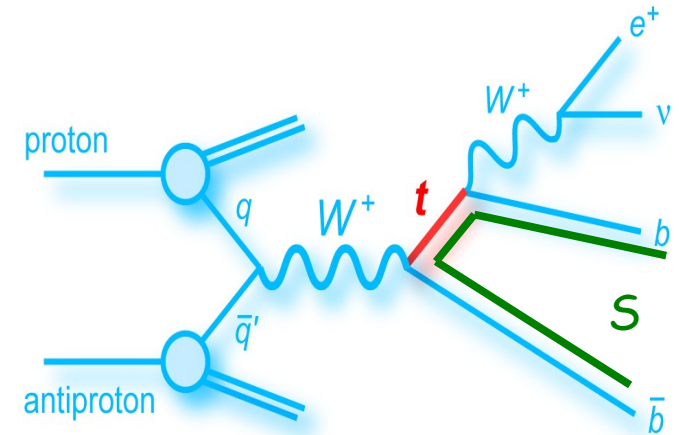

Summary

- Color-flow is a useful discriminant for decays of boosted objects to jets ($H \rightarrow bb$, top-tagging, SUSY chains, etc.)
- Studies of $t\bar{t}$ data and simulations from D0 give confidence that color-flow (in high-pt jets) can be:
 - simulated accurately
 - measured with reasonable systematics experimentally
- With more data and studies, color-flow / jet pull will become a precise tool
- Analysis of ATLAS simulations / data are underway !

Backup Slides

W matching fraction

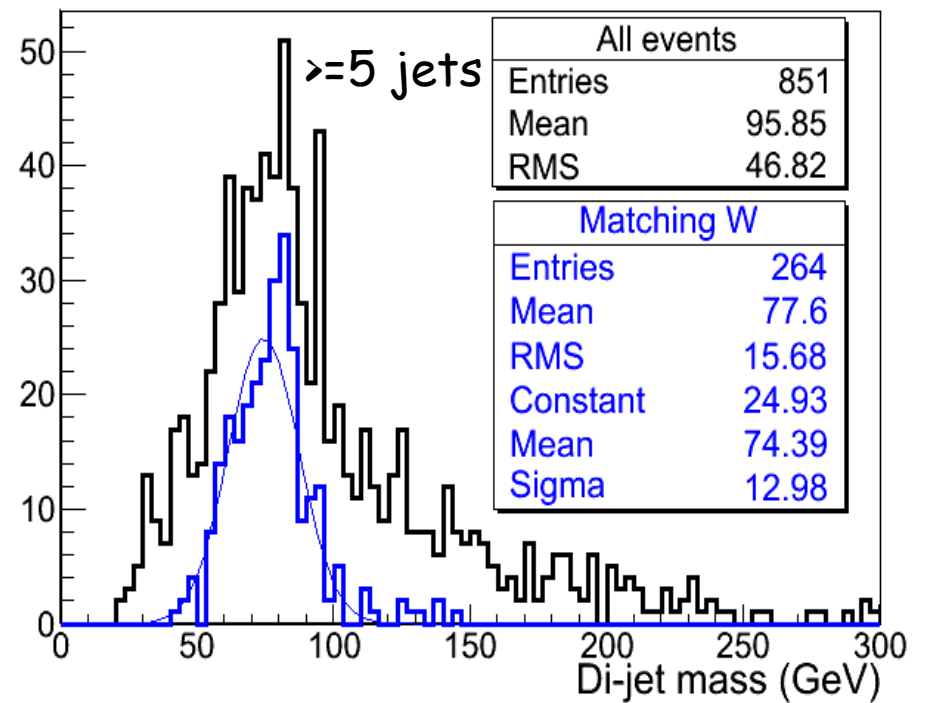
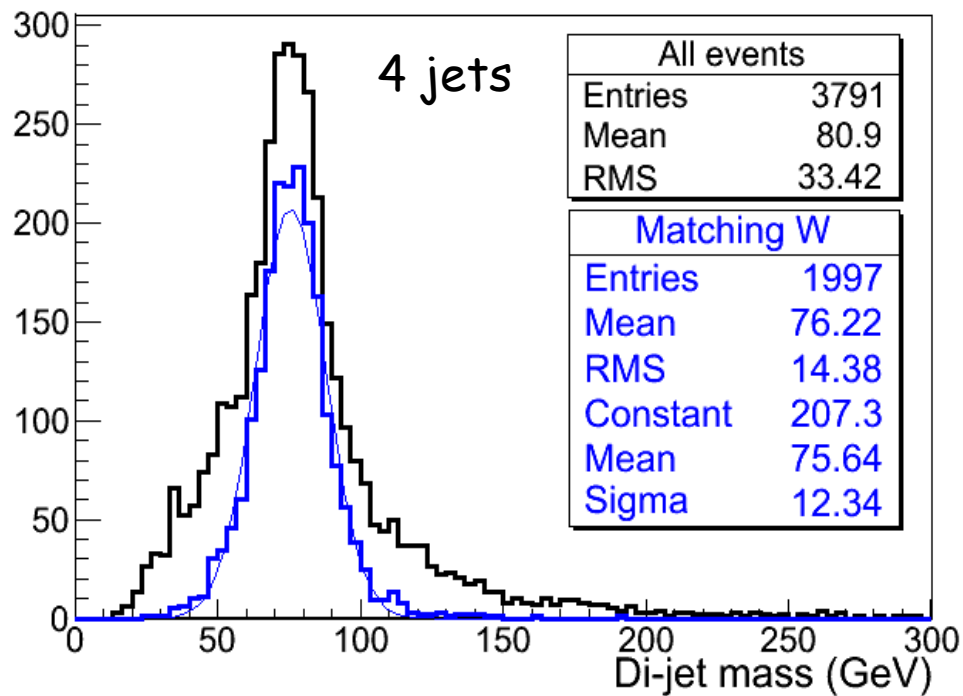

Jet pull in control samples, data/MC

- Look at light jets in *anti-b-tagged* W +jets samples
- Good data/MC agreement, for both jets

Leading-pT light jet

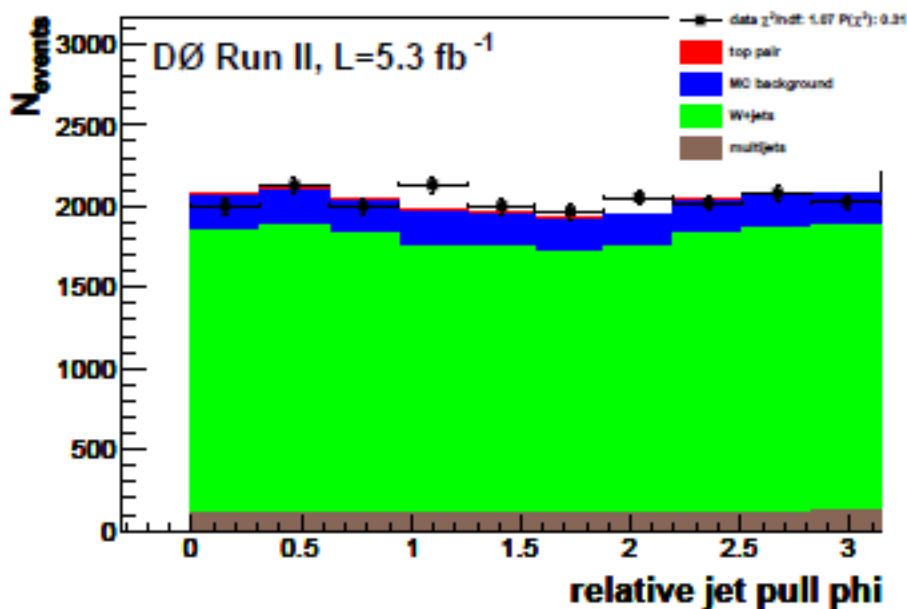

Second-leading-pT light jet

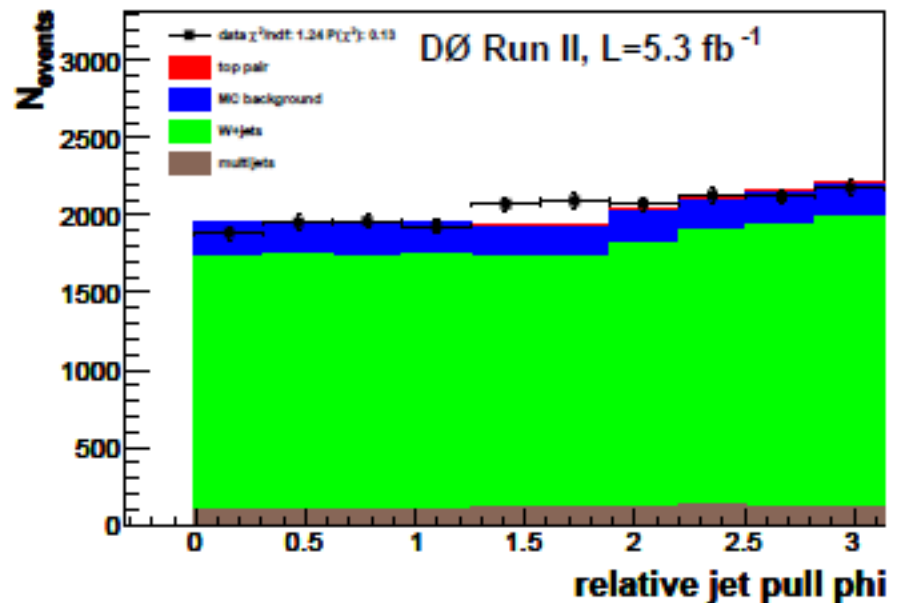

$W + 2$ light jets sample

Checks of jet pull reconstruction

- Jet pull *magnitude* (amount of eccentricity) is also well-modeled
- But **excess eccentricity is induced by the ICR**
 - Corrected for by adding a vector to the jet pull opposite to ICR direction
- Correction is also $\sim 20\%$ different for data/MC, used as systematic

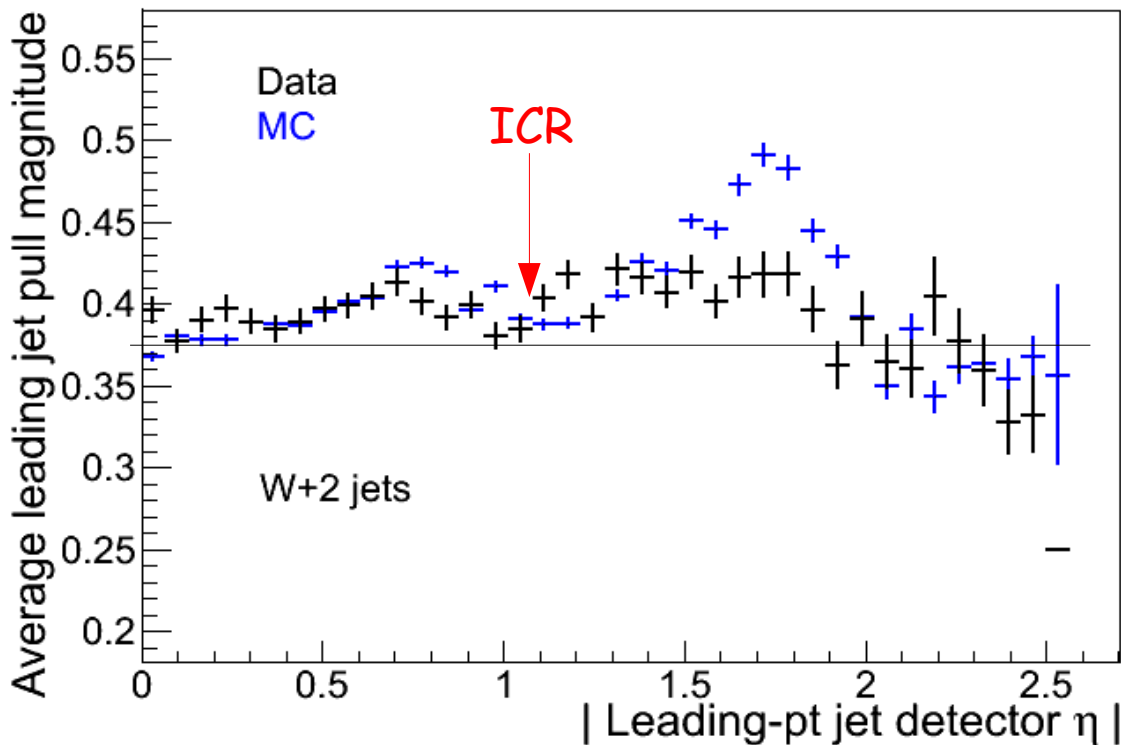

Different response/noise
in ICR region

Pull biased towards $\pm\eta$
direction

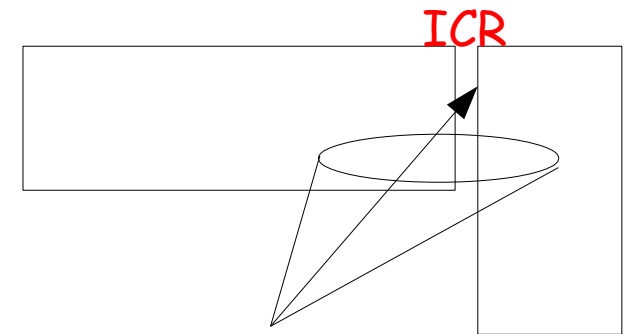

Checks of jet pull reconstruction

- Look at jets which overlap and don't overlap for .5 and .7 cones

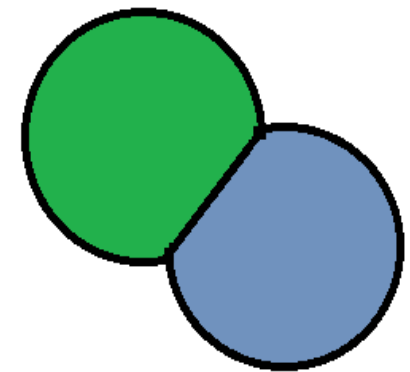
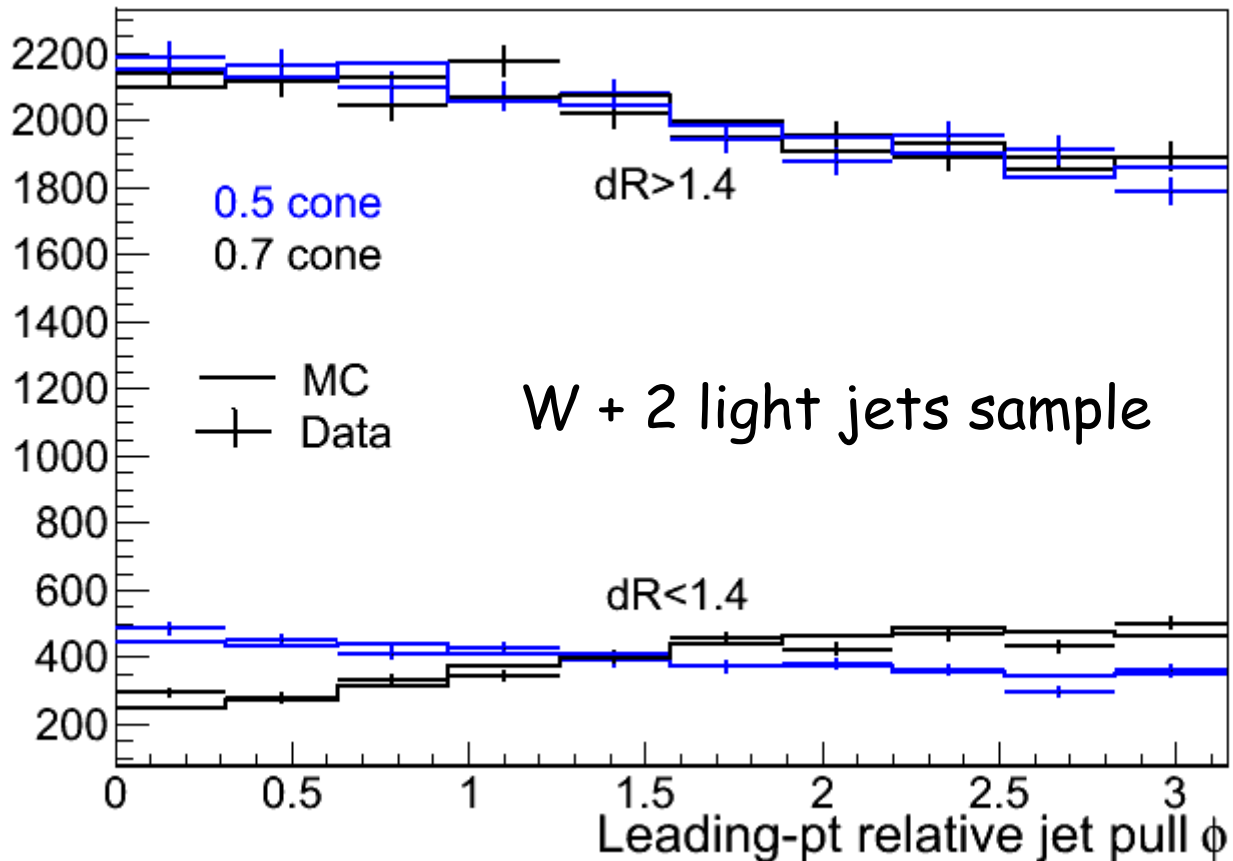

Cells are assigned to the *nearest jet*

Checks of jet pull reconstruction

- Bias of jet pull direction from *non-uniformity of calorimeter vs. eta*
 - Particularly the ICR has lower response and more noise
- Fairly well-modeled by the MC, within ~20%
- Relative jet pull angle is not significantly affected

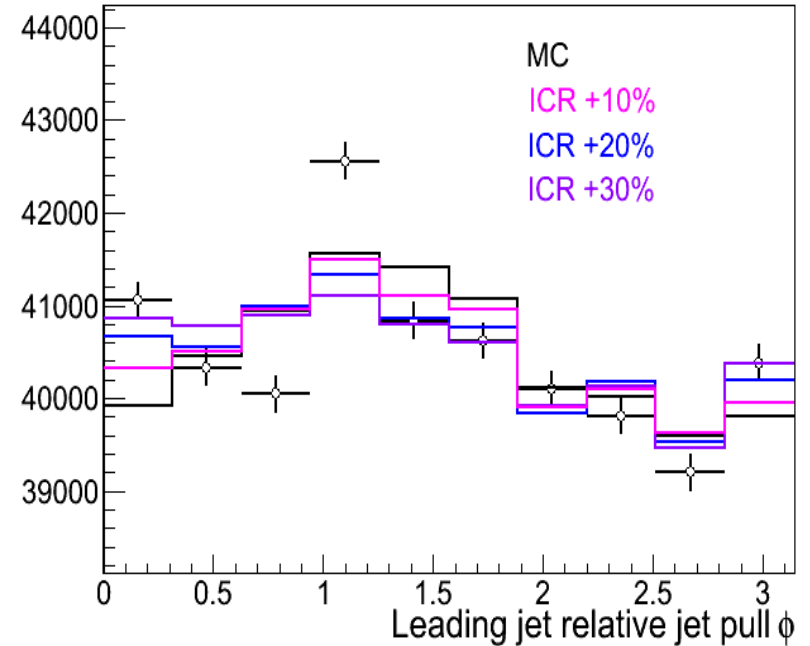
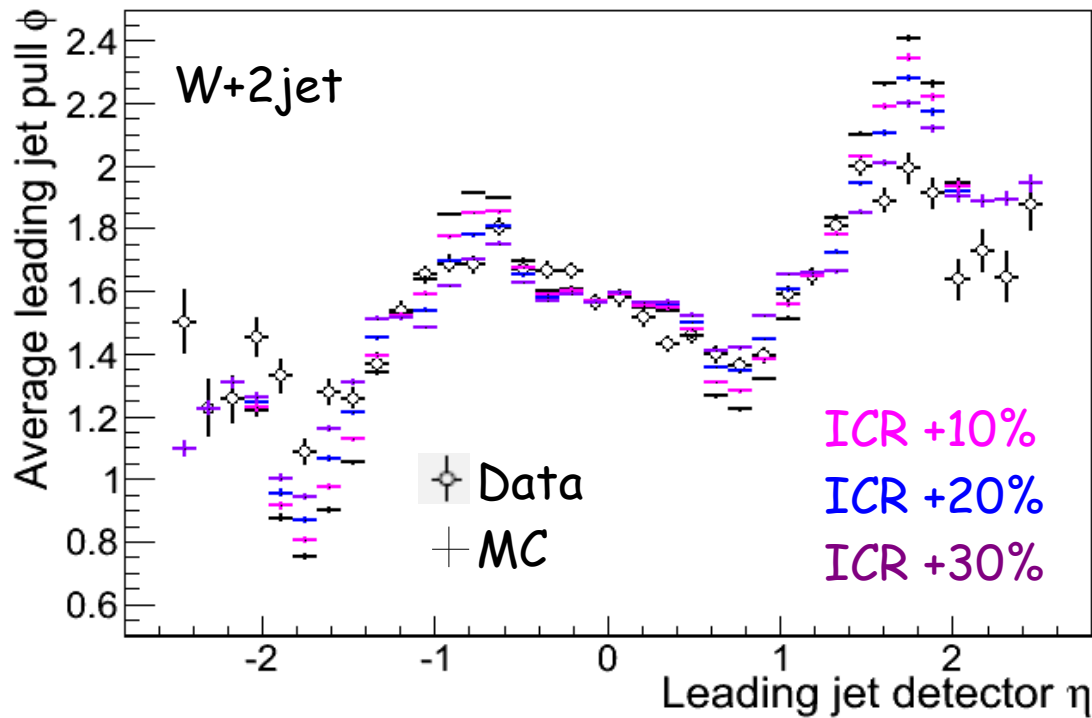

Jets touching ICR region

Studies of $t\bar{t}$ lepton+jets

What do we expect from (full) MC ?

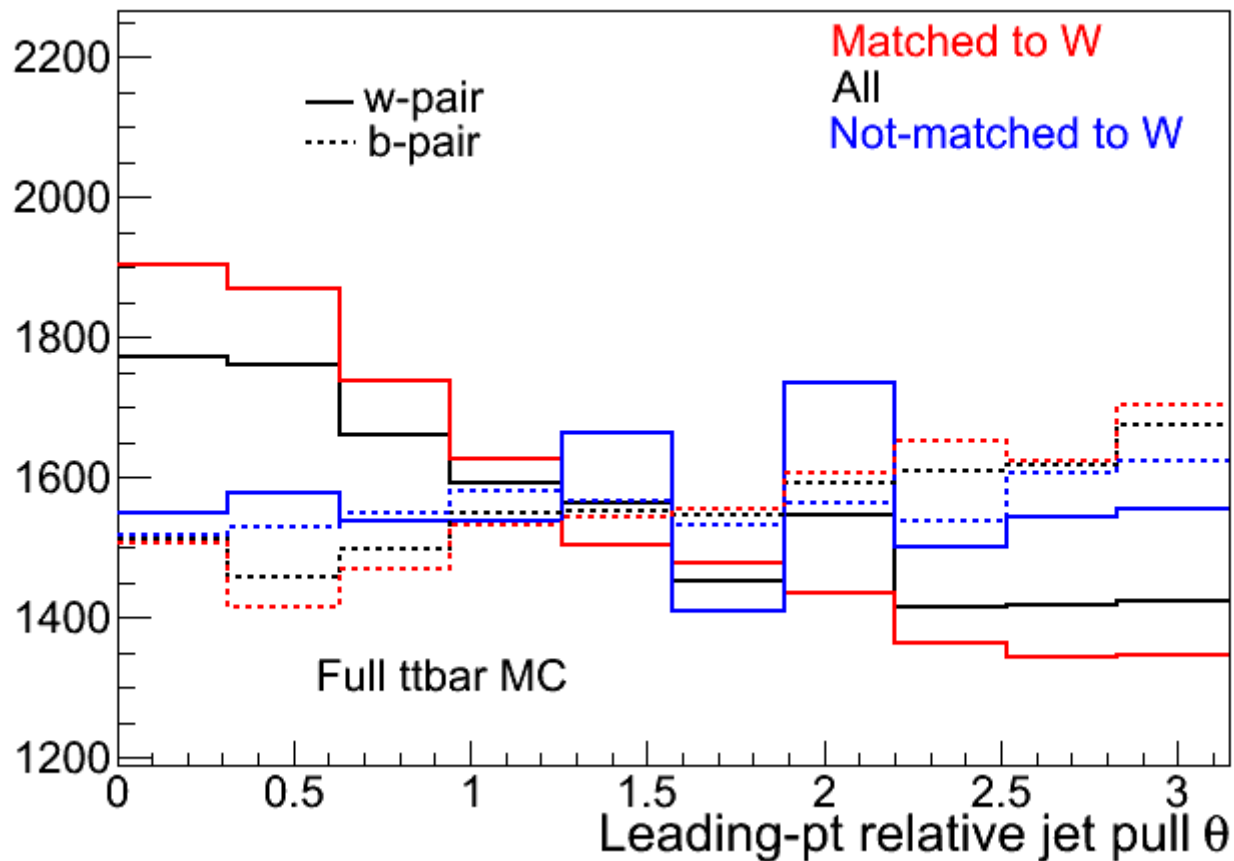

Separation is degraded by misidentified $W \rightarrow jj$ decays

Full MC vs. MC truth

~75% more separation of "w" vs. b pairs in MC truth

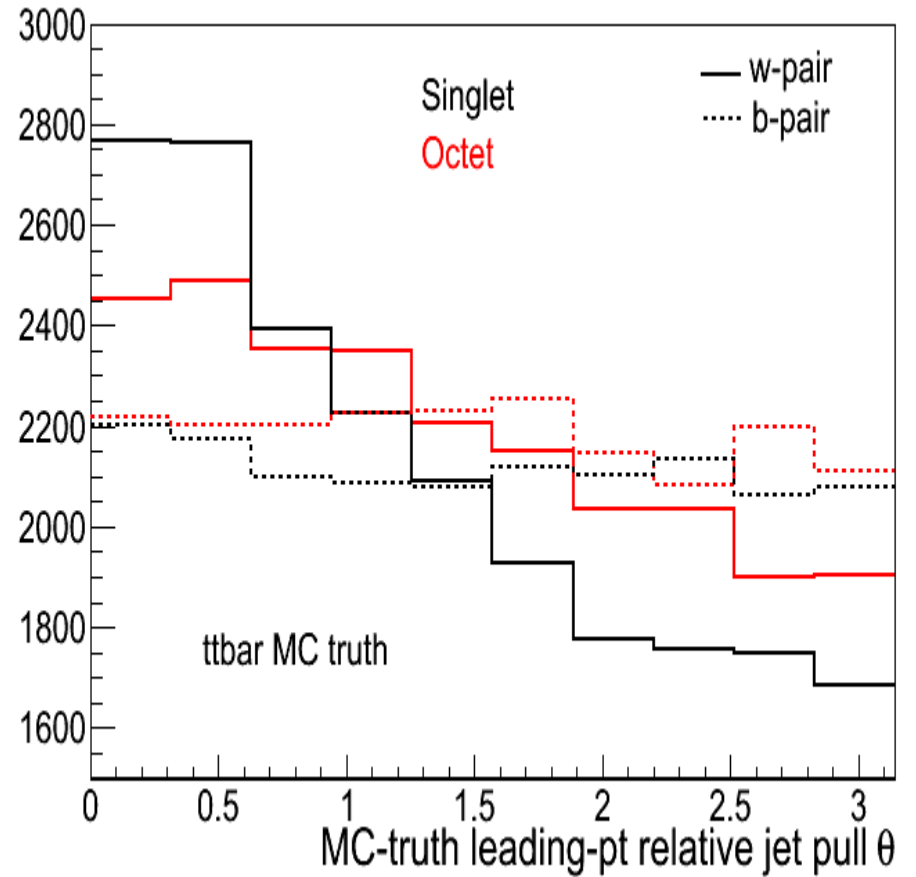
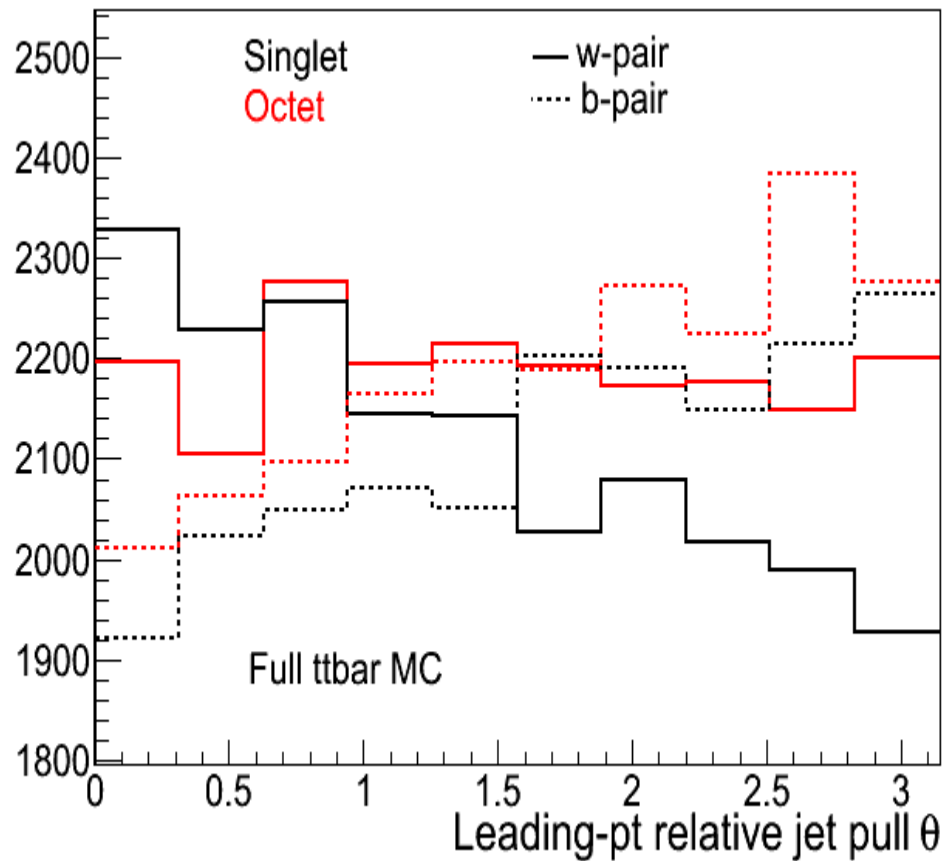

Matching W in ttbar MC truth

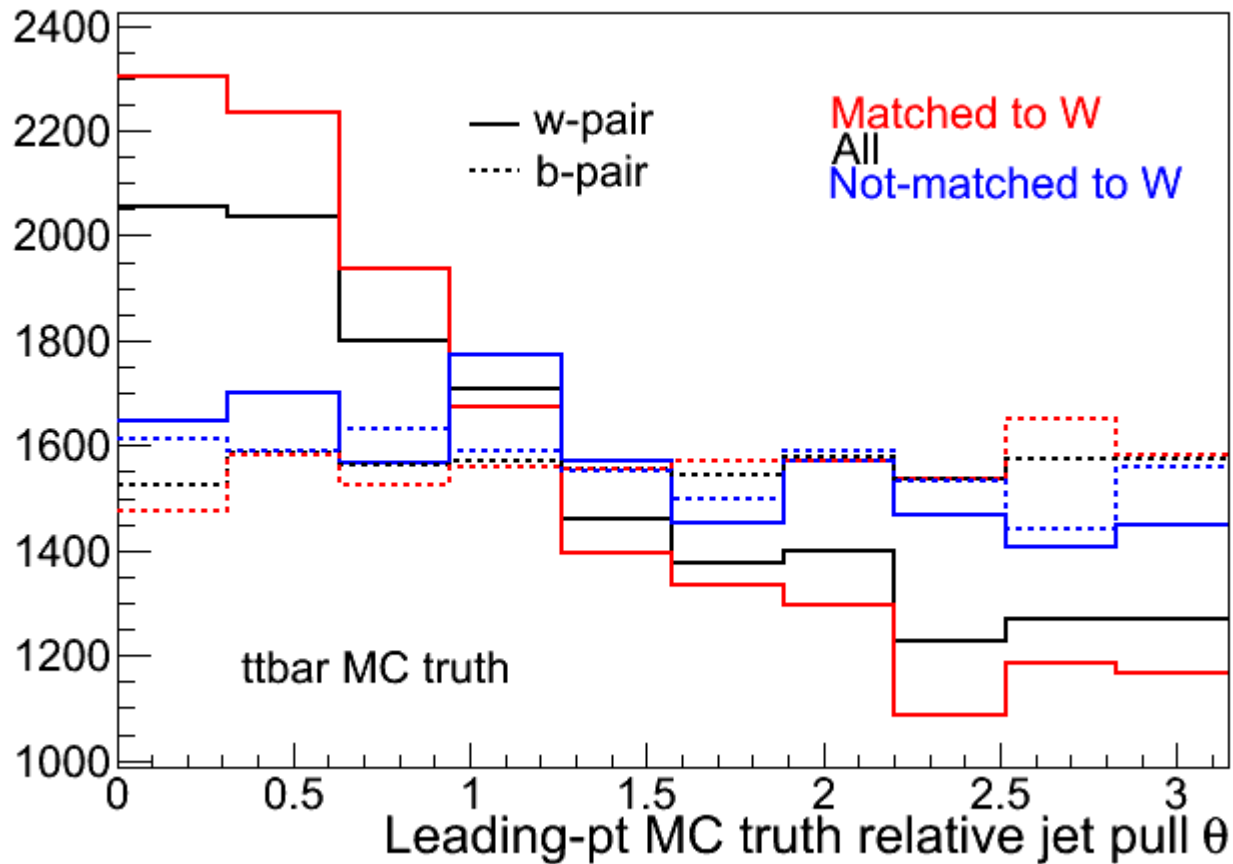

Jet pull in control samples, data/MC

- Look at light jets in *anti-b-tagged* $W+3$ jets sample
- Good data/MC agreement, for both jets

Leading p_T light jet

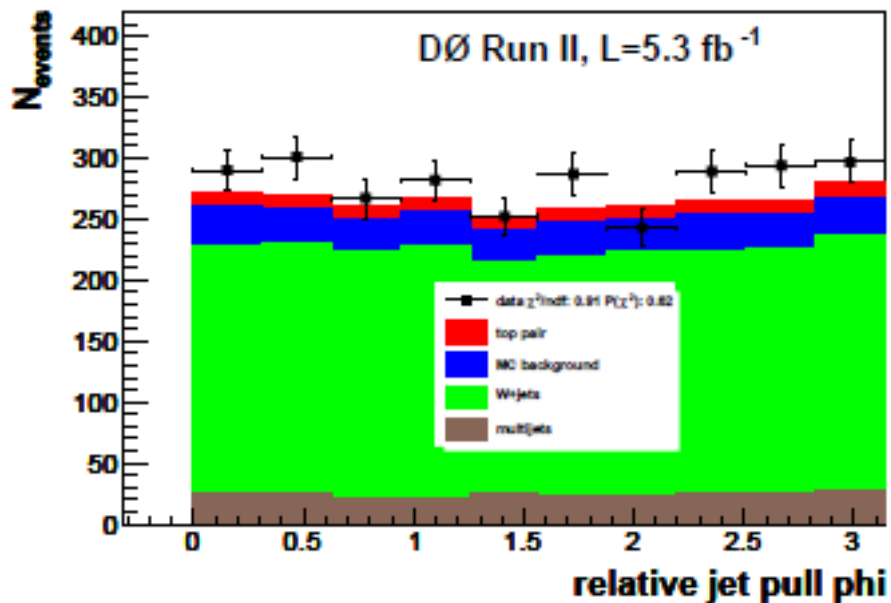

Second-leading p_T light jet

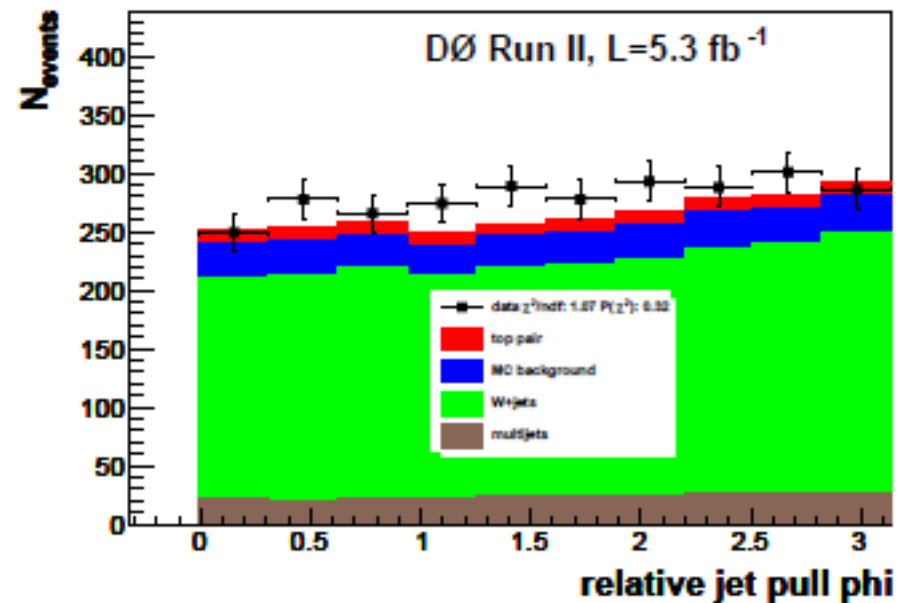

Jet pull in control samples, data/MC

- Look at light jets in *b*-tagged $W+3$ jets sample
- Good data/MC agreement, for both jets

Leading pT light jet

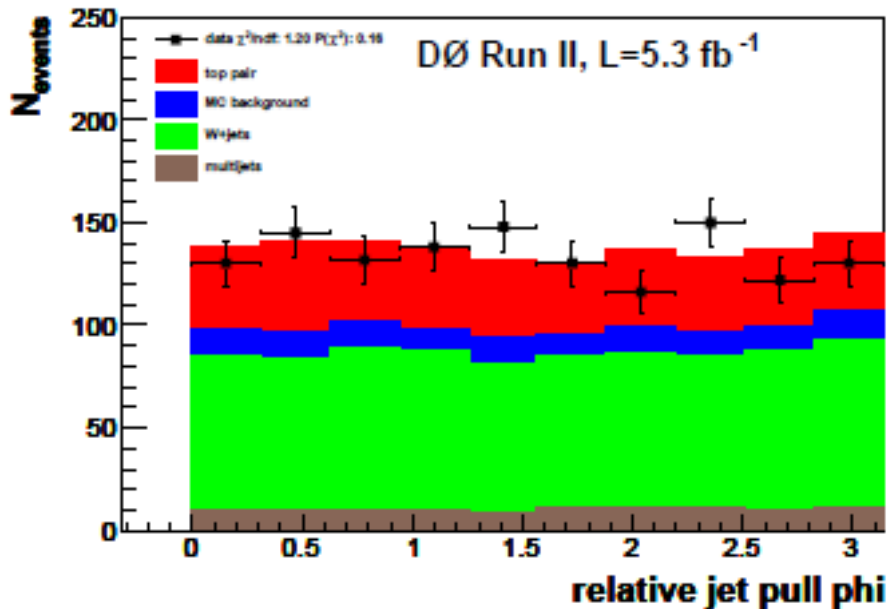

Second-leading pT light jet

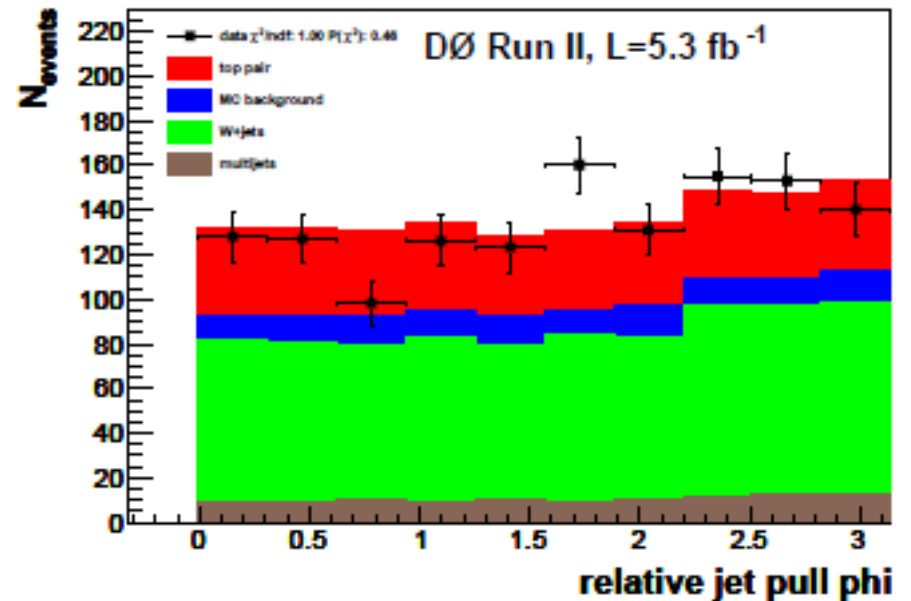

Jet pull in control samples, data/MC

- Look at *anti-b-tagged* $W+4$ jets samples
- Good data/MC agreement, for both sets of jets
- Flatter than in real $t\bar{t}$ (since there's not real color connections?)

Two jets with M_{jj} closest to m_W

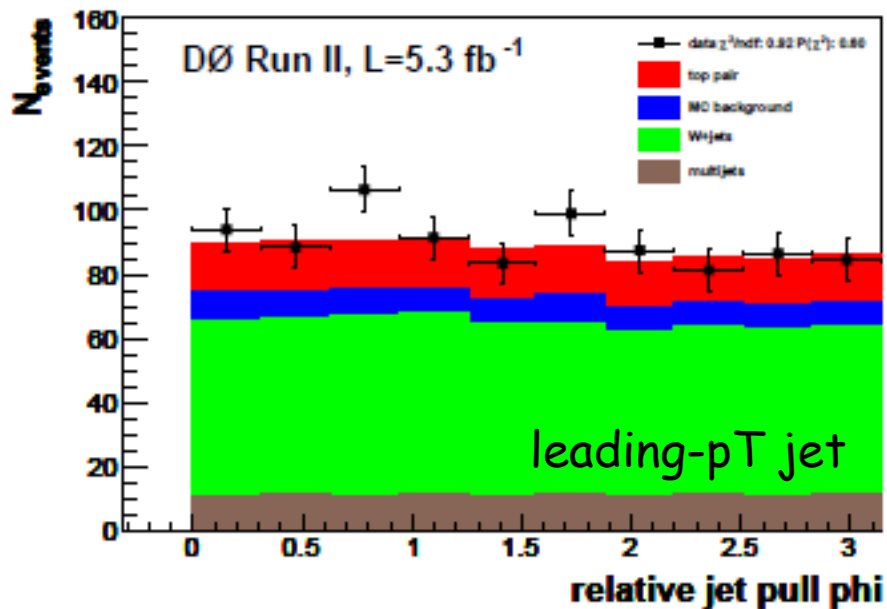

Other two jets in the event

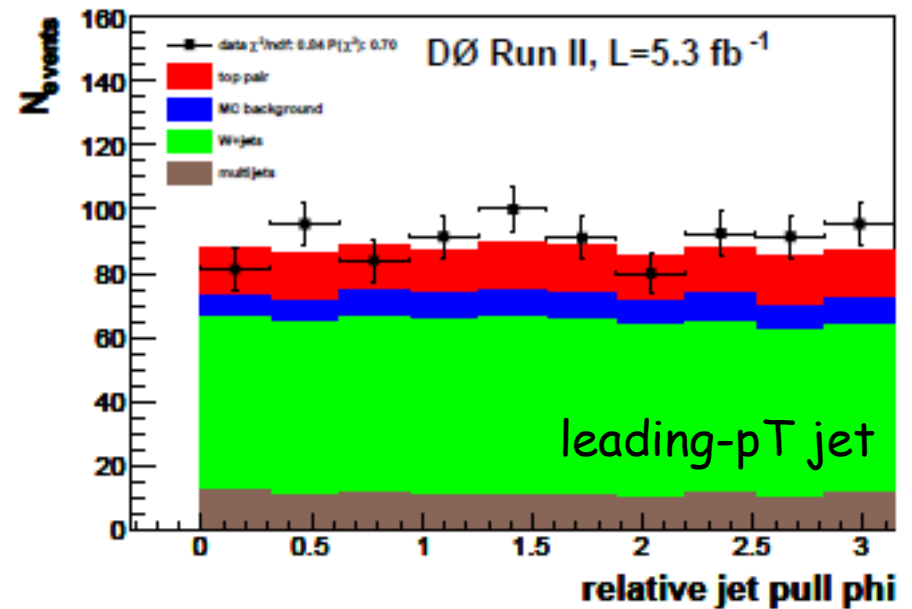

Separated by eta's of jets

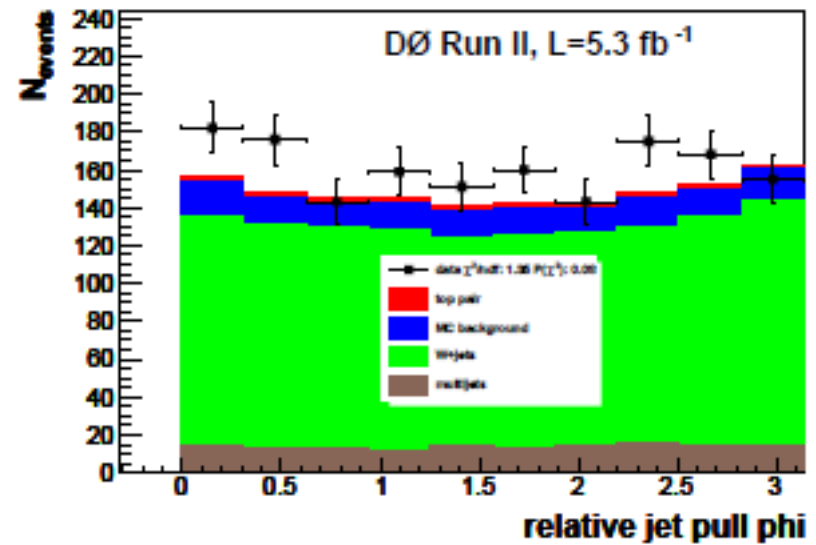
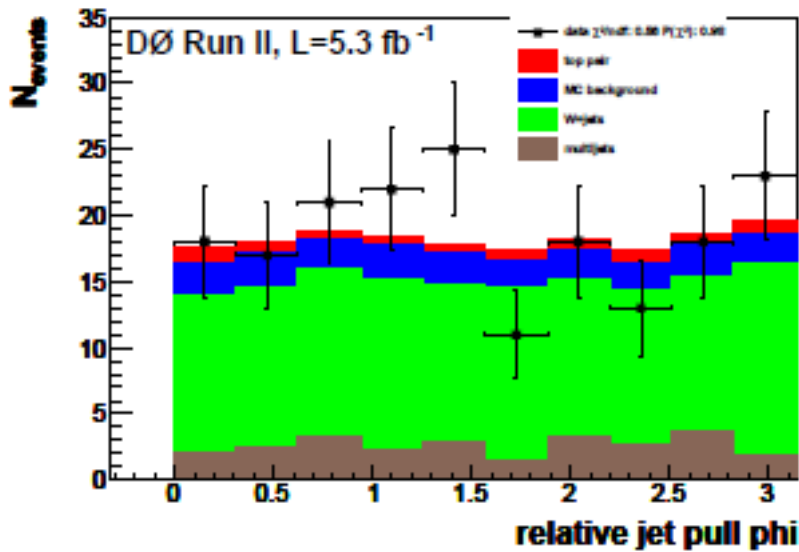
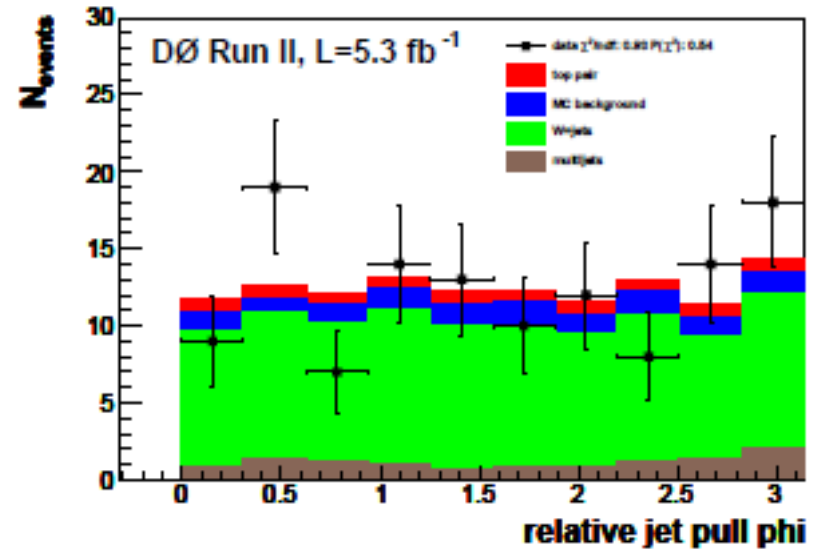
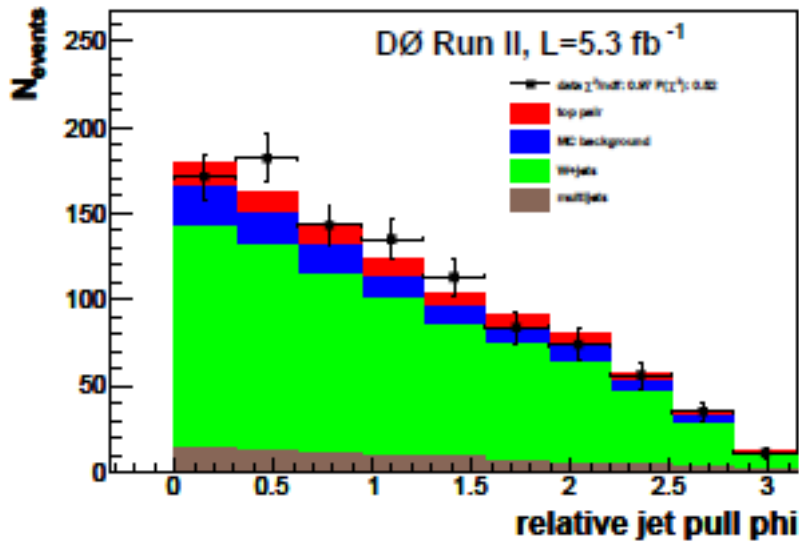

W + 3 light jets sample

Separated by eta's of jets

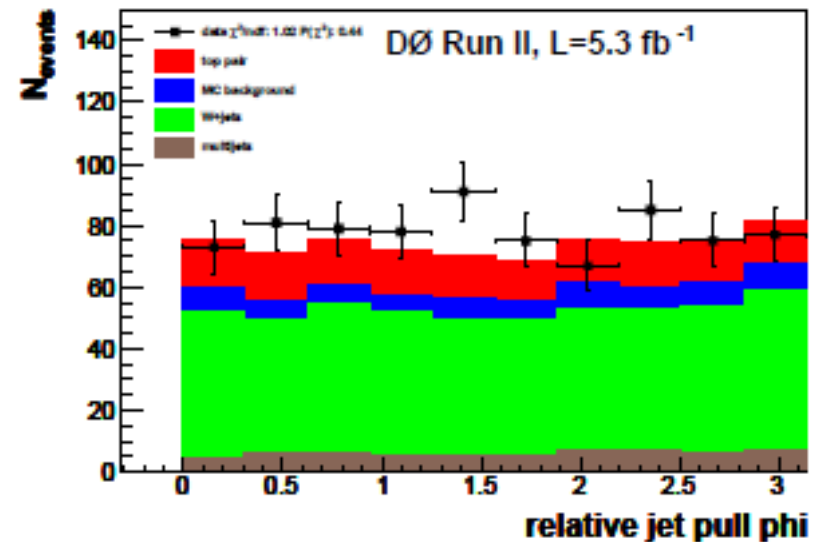
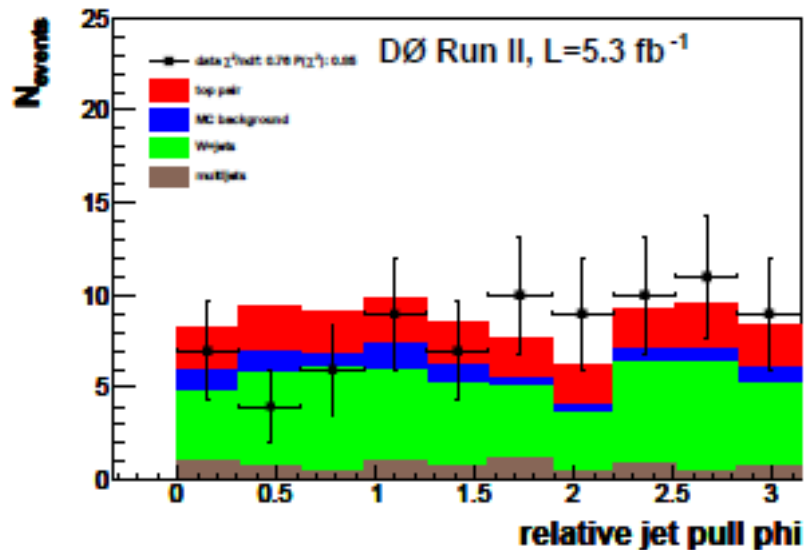
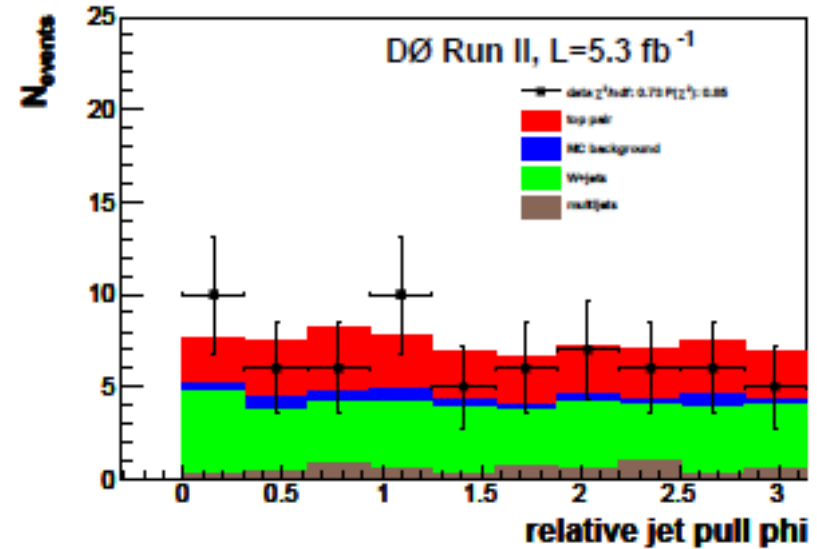
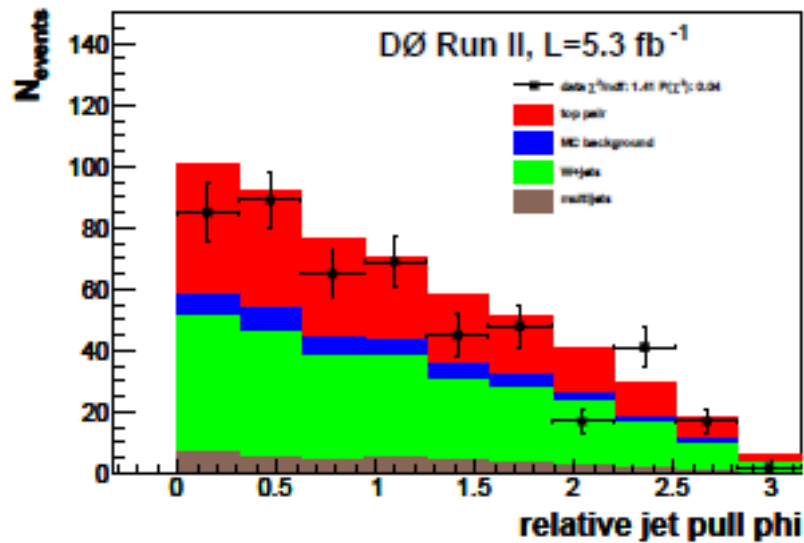

W + 3 jets *b*-tagged sample

Other eta,dR regions

fitted distribution (combined) for $dR > 2$

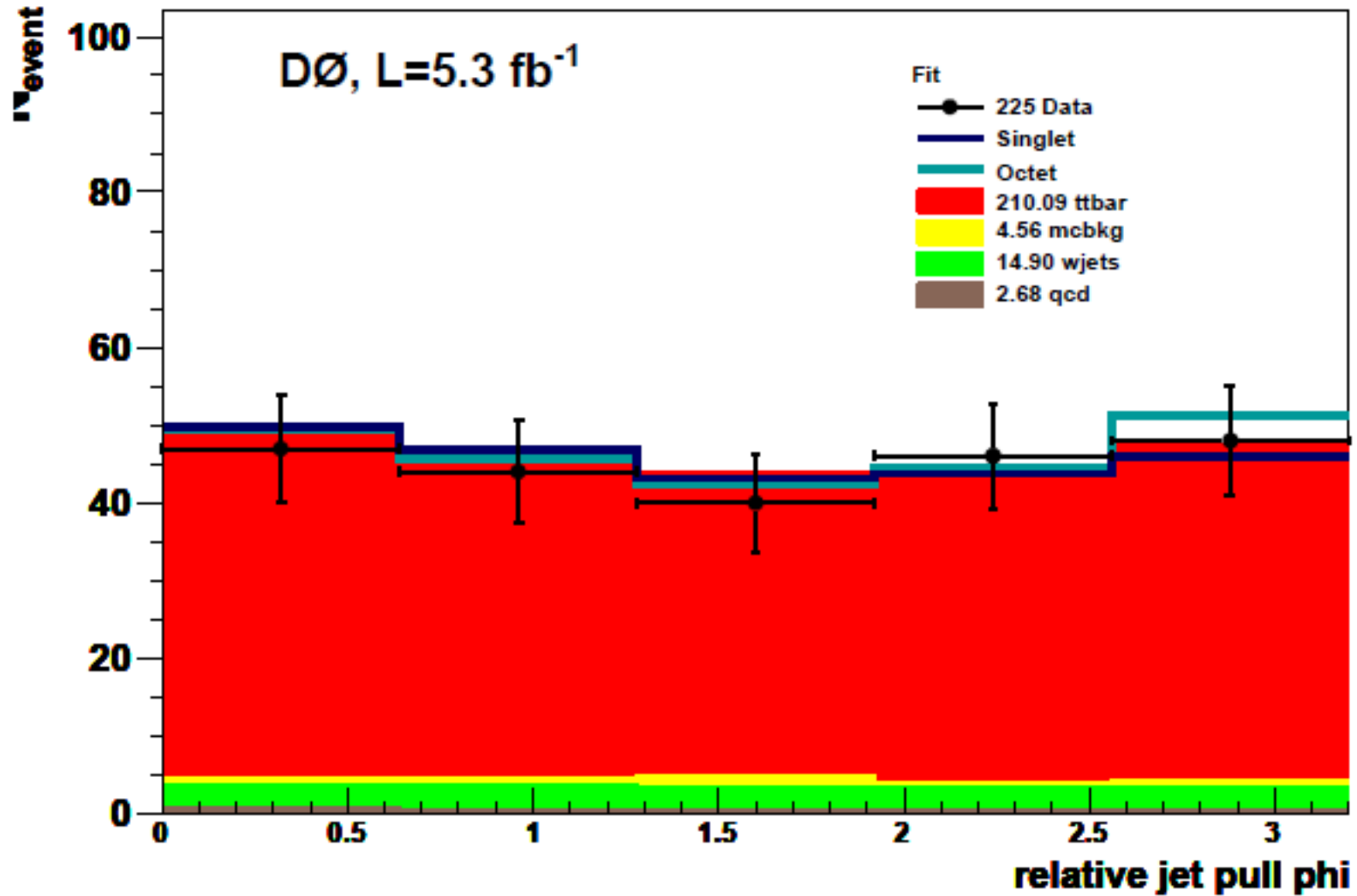

Other eta,dR regions

fitted distribution (combined) for $dR < 2$ and $|\text{leading jet eta}| < 1$ and $|\text{second leading jet eta}| > 1$

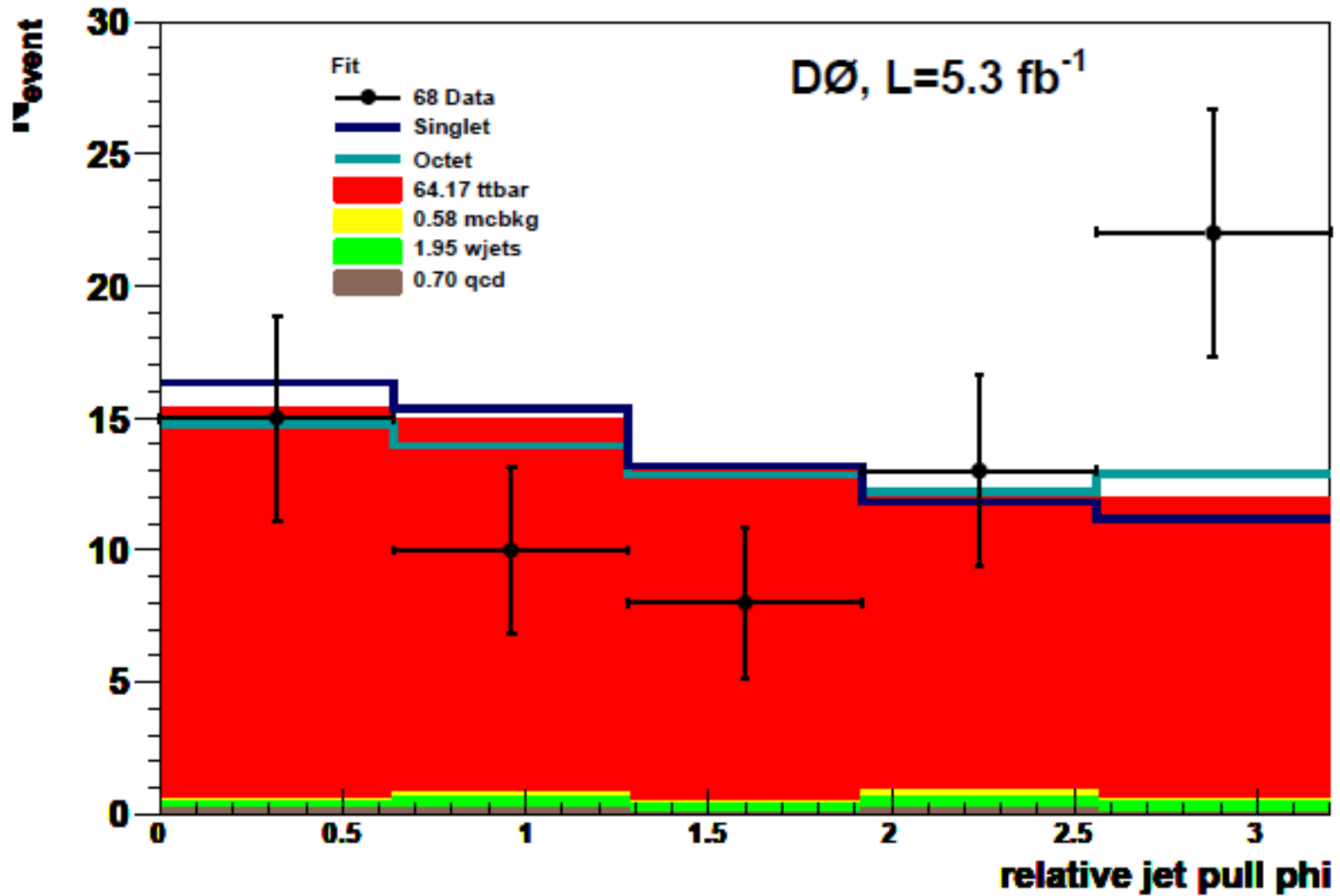

Other eta,dR regions

fitted distribution (combined) for $dR < 2$ and $|\text{leading jet eta}| > 1$

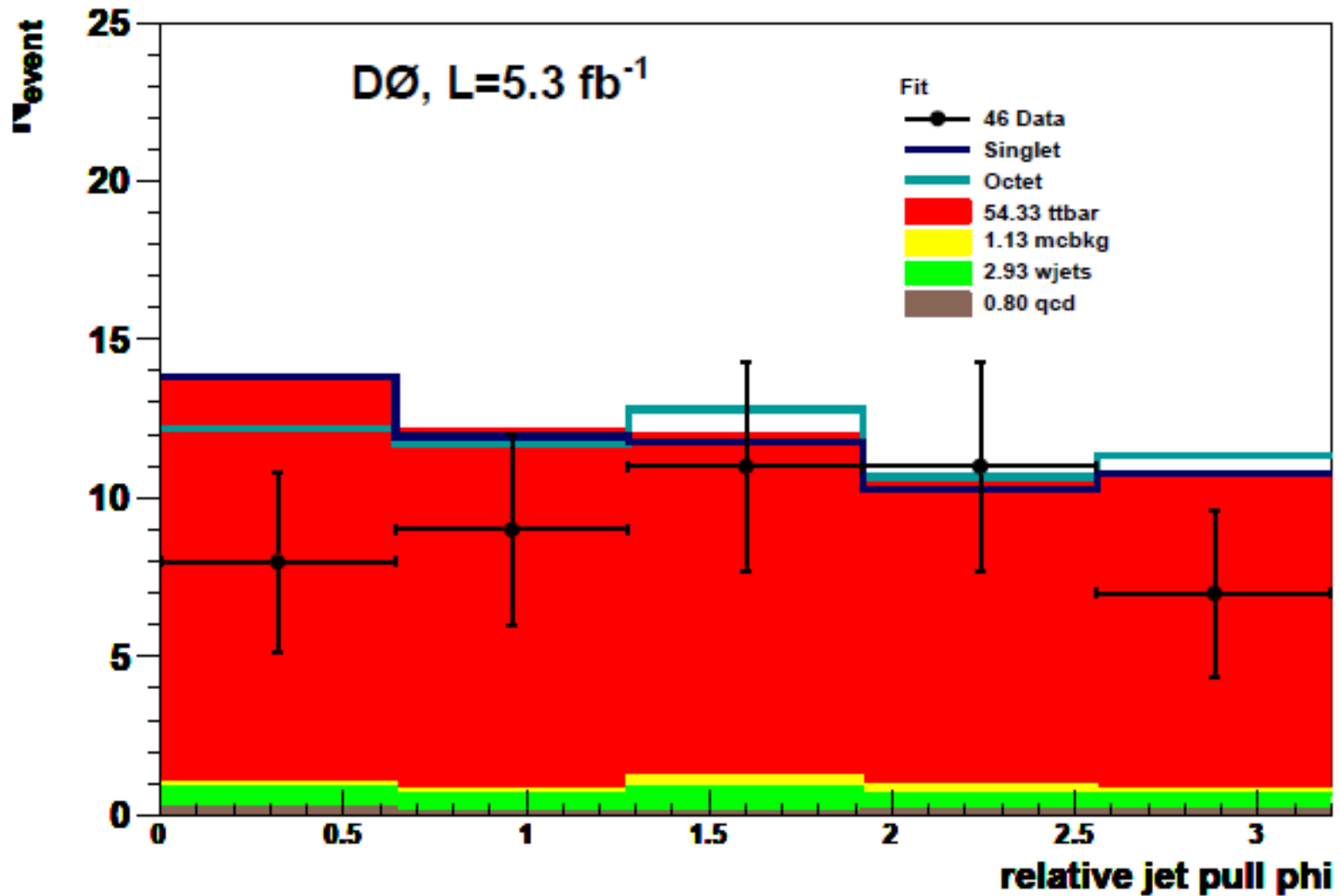

Other eta,dR regions

fitted distribution (combined) for $|m_{jj}-m_W|>30\text{GeV}$

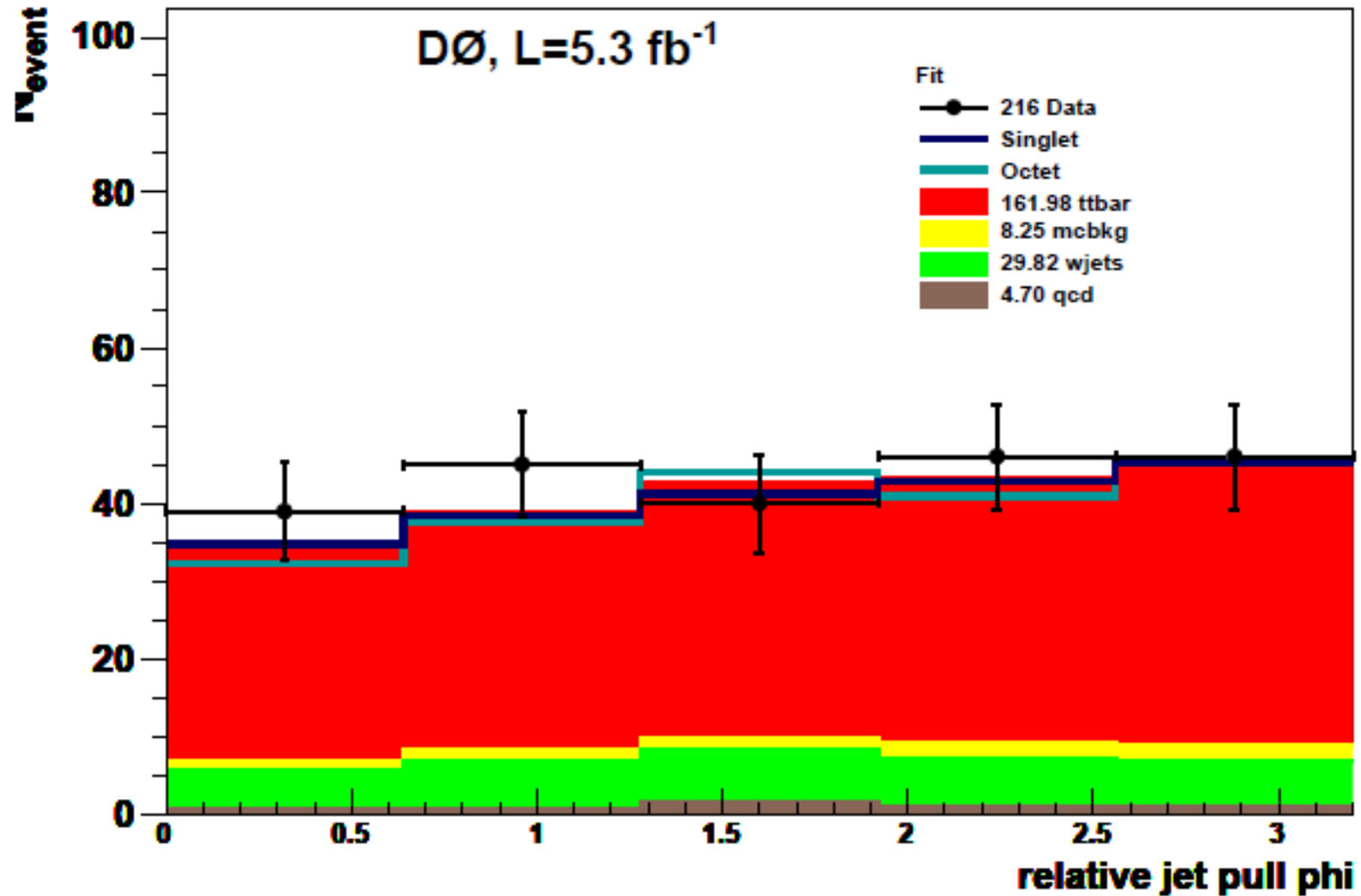

b-jets

- b-jets don't care much about the color representation of the "X"

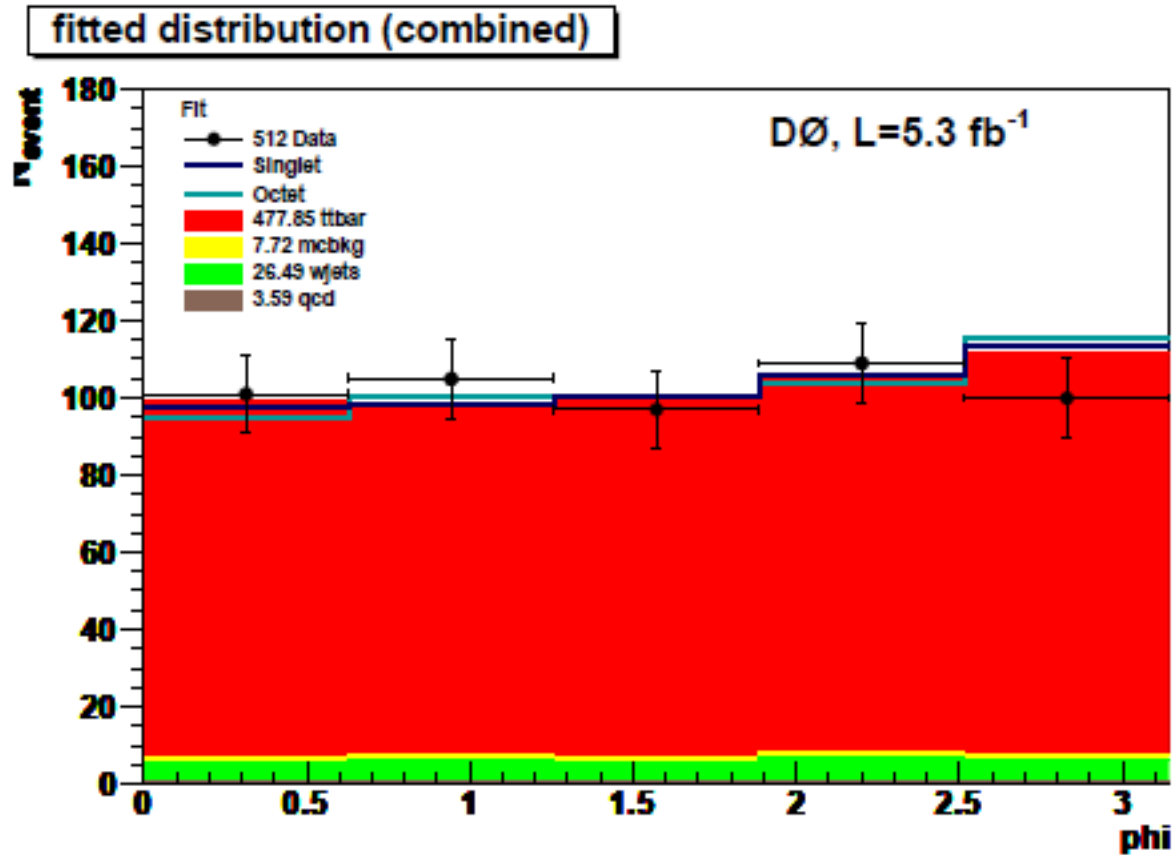

Pileup

- Amount of "noise" increases with #PV
- Changes average relative jet pull angles
- Separation between singlet and octet degrades only slightly

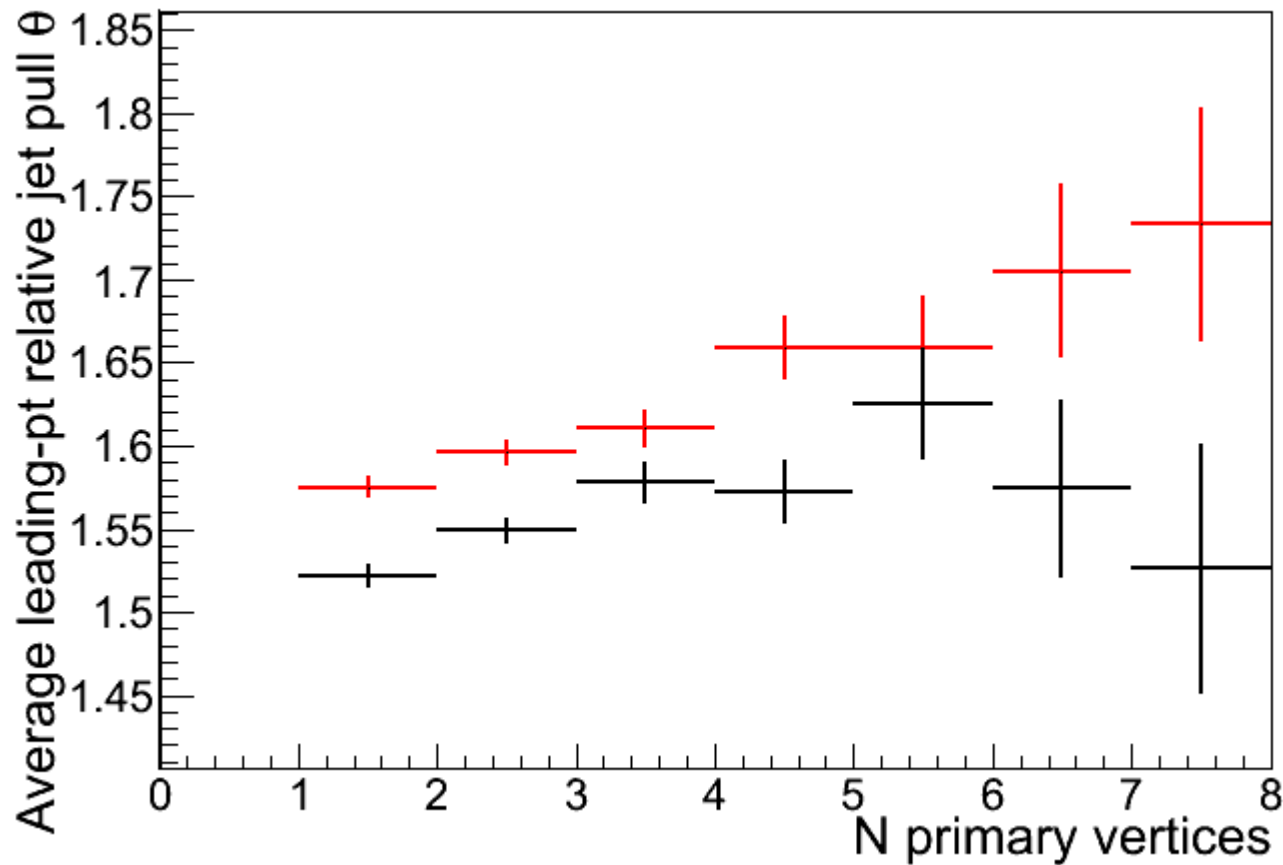

Systematics on jet pull shape

MCNLO+Herwig agrees with plain Pythia

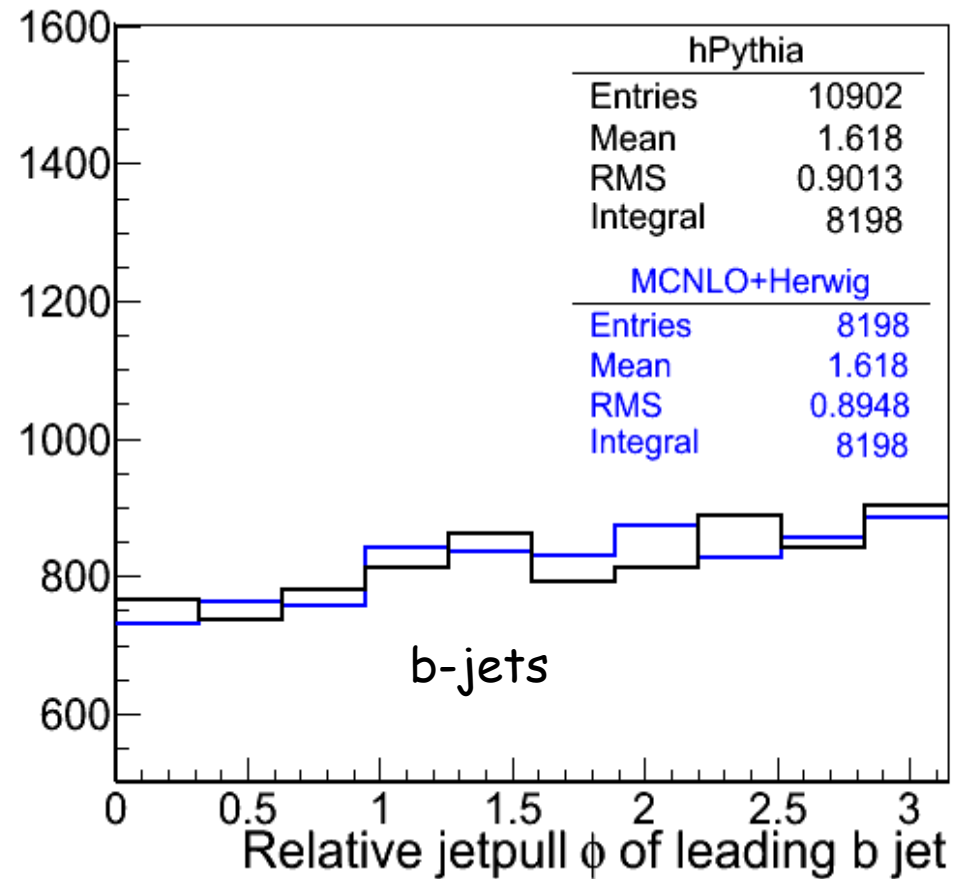
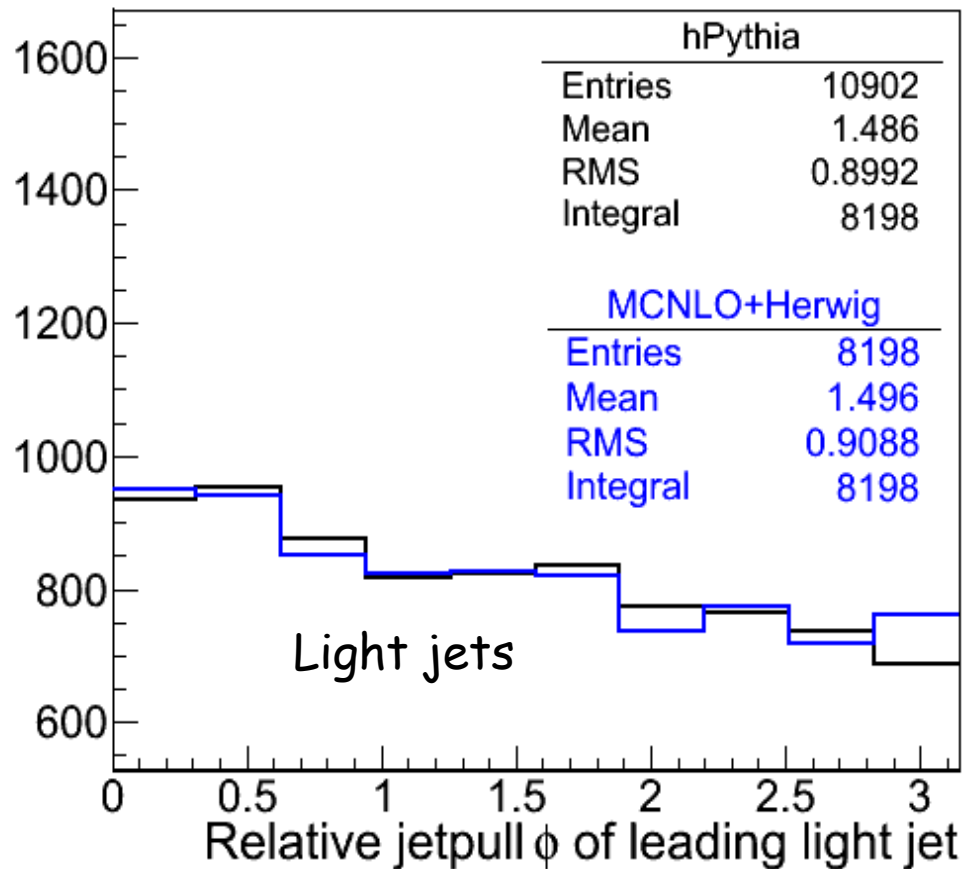

Systematics

Other systematics (standard in $t\bar{t}$ analyses) are found to be very small...

Summary of systematics on $f_{Singlet}$ with standard method		
Source	sigma+	sigma-
Event pre-selection	0.000	-0.000
Muon identification	0.001	-0.000
Muon resolution and scale	0.000	-0.000
Electron identification and smearing	0.001	-0.000
Electron scale	0.000	-0.000
Luminosity reweighting	0.000	-0.000
Z p_T reweighting	0.001	-0.000
EM triggers	0.000	-0.000
Muon triggers	0.001	-0.001
Monte Carlo background x-section	0.001	-0.001
Monte Carlo signal & bkgd branching ratio	0.000	-0.000
b-Jet energy scale	0.001	-0.000
Taggability in data	0.001	-0.000
b-tag TRF	0.000 (0.001)	-0.000 (0.000)
light tag TRF	0.000 (0.000)	-0.000 (0.000)
b fragmentation	0.000	-0.000
W fractions matching + higher order effects	0.003	-0.004
Luminosity	0.001	-0.000

Results in various sub-samples

channel	$\sigma_{t\bar{t}}$ [pb]	$f_{Singlet}$
e +jets	$7.78^{+0.40}_{-0.39}$ (stat) $^{+0.82}_{-0.76}$ (syst+lumi)	$0.394^{+0.483}_{-0.491}$ (stat) $^{+0.305}_{-0.297}$ (syst)
μ +jets	$9.67^{+0.53}_{-0.51}$ (stat) $^{+1.06}_{-0.97}$ (syst+lumi)	$1.012^{+0.557}_{-0.586}$ (stat) $^{+0.291}_{-0.294}$ (syst)
Run IIa	$8.40^{+0.65}_{-0.62}$ (stat) $^{+0.88}_{-0.81}$ (syst+lumi)	$0.081^{+0.595}_{-0.609}$ (stat) $^{+0.366}_{-0.367}$ (syst)
Run IIb	$8.59^{+0.37}_{-0.36}$ (stat) $^{+0.98}_{-0.90}$ (syst+lumi)	$1.041^{+0.483}_{-0.491}$ (stat) $^{+0.275}_{-0.268}$ (syst)

Event display

Run 246692 Evt 31312096 Thu Oct 23 09:37:40 2008

Triggers:

DTAJT2_2T102TK
DTAJT2_2T10NN3TK
JT1_ACO_MHT_BDV
JT1_ACO_MHT_LM0
JT1_MET
JT2_3J152J25_SVX
JT2_3JT10L_LM3_V
JT2_3JT12L_MM3_V
JT2_3JT15L_IP_VX
JT2_ACO_MHT_BDV
JT2_ACO_MHT_LM0
JT2_MET
JT3_3JT10L_LM3_V
JT3_3JT12L_MM3_V
JT m M

1 MET

1 mu particle

EM

ICD

HAD

CH

