



Experimental techniques - TCT

Daniel Hynds

Disclaimer

I am definitely not an expert in this topic!

TCT

Transient Current Technique

- The whole concept is to look at the induced current on an electrode/cathode while charges move through the device

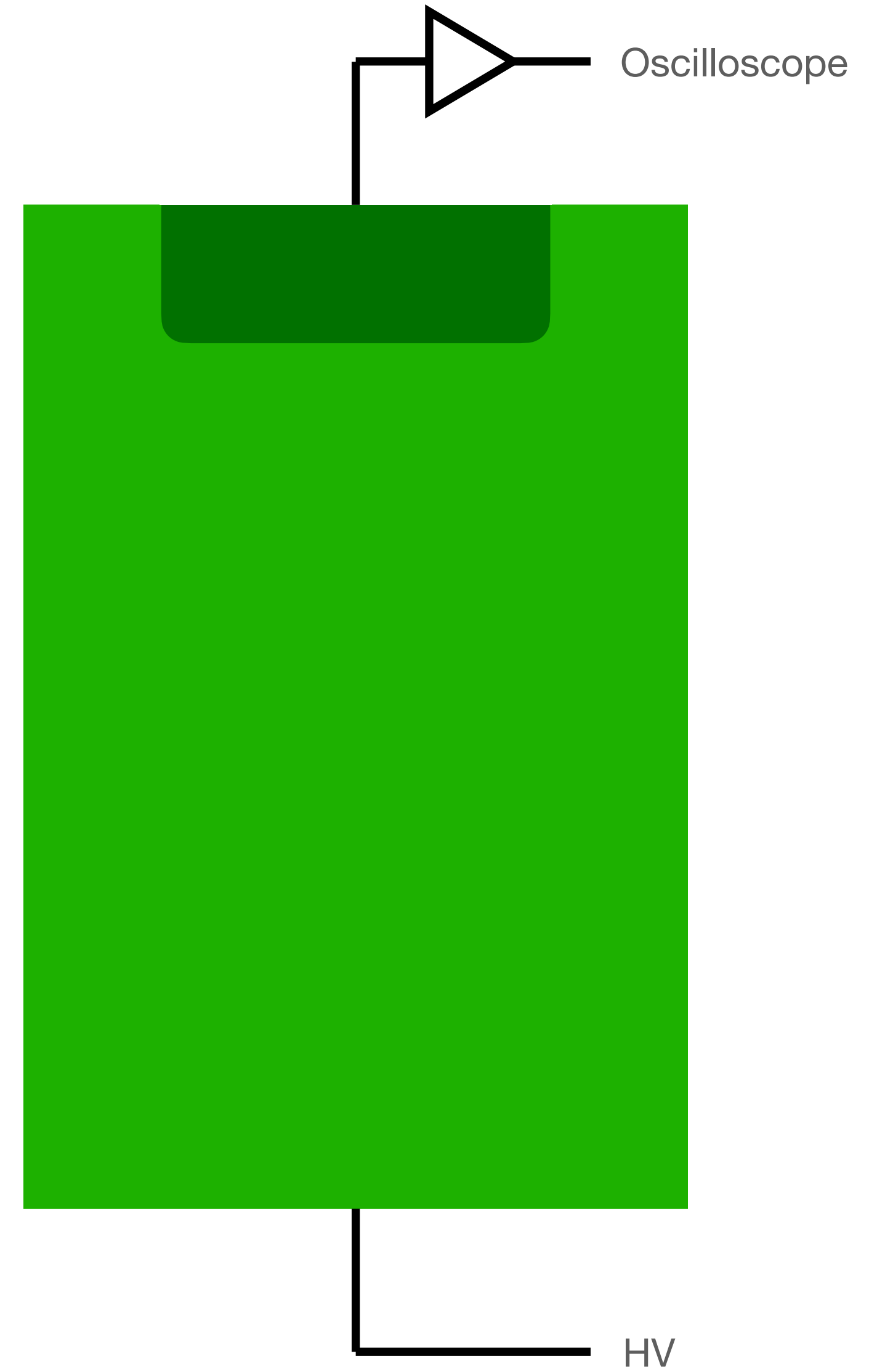

TCT - signal generation

Transient Current Technique

- The whole concept is to look at the induced current on an electrode/cathode while charges move through the device
- Consider charge carriers within the sensor:

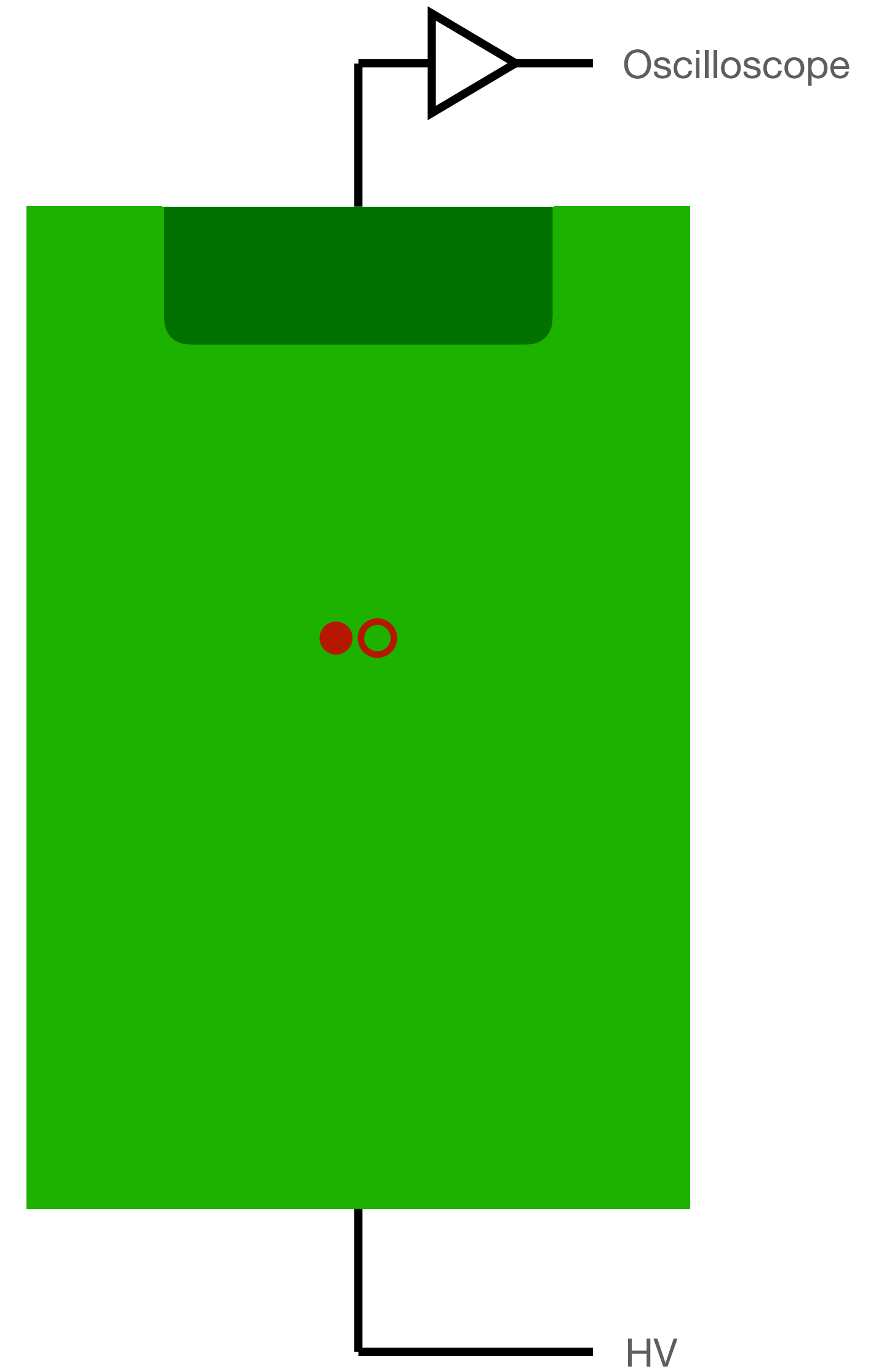

TCT - signal generation

Transient Current Technique

- The whole concept is to look at the induced current on an electrode/cathode while charges move through the device
- Consider charge carriers within the sensor:
 - $v_d = \mu E$

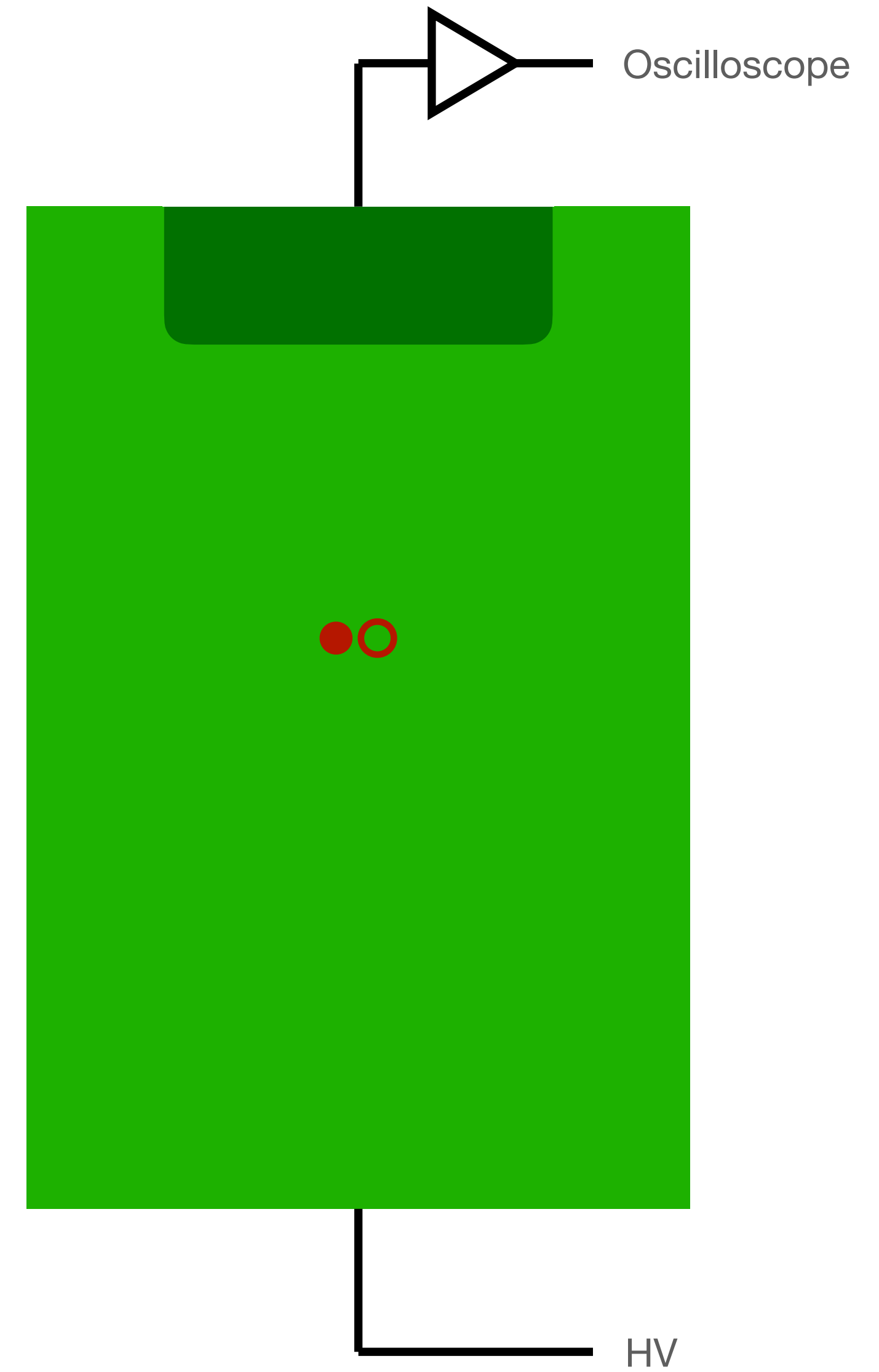

TCT - signal generation

Transient Current Technique

- The whole concept is to look at the induced current on an electrode/cathode while charges move through the device
- Consider charge carriers within the sensor:
 - $v_d = \mu E$
 - $I(y,t) = I_e(y,t) + I_h(y,t)$

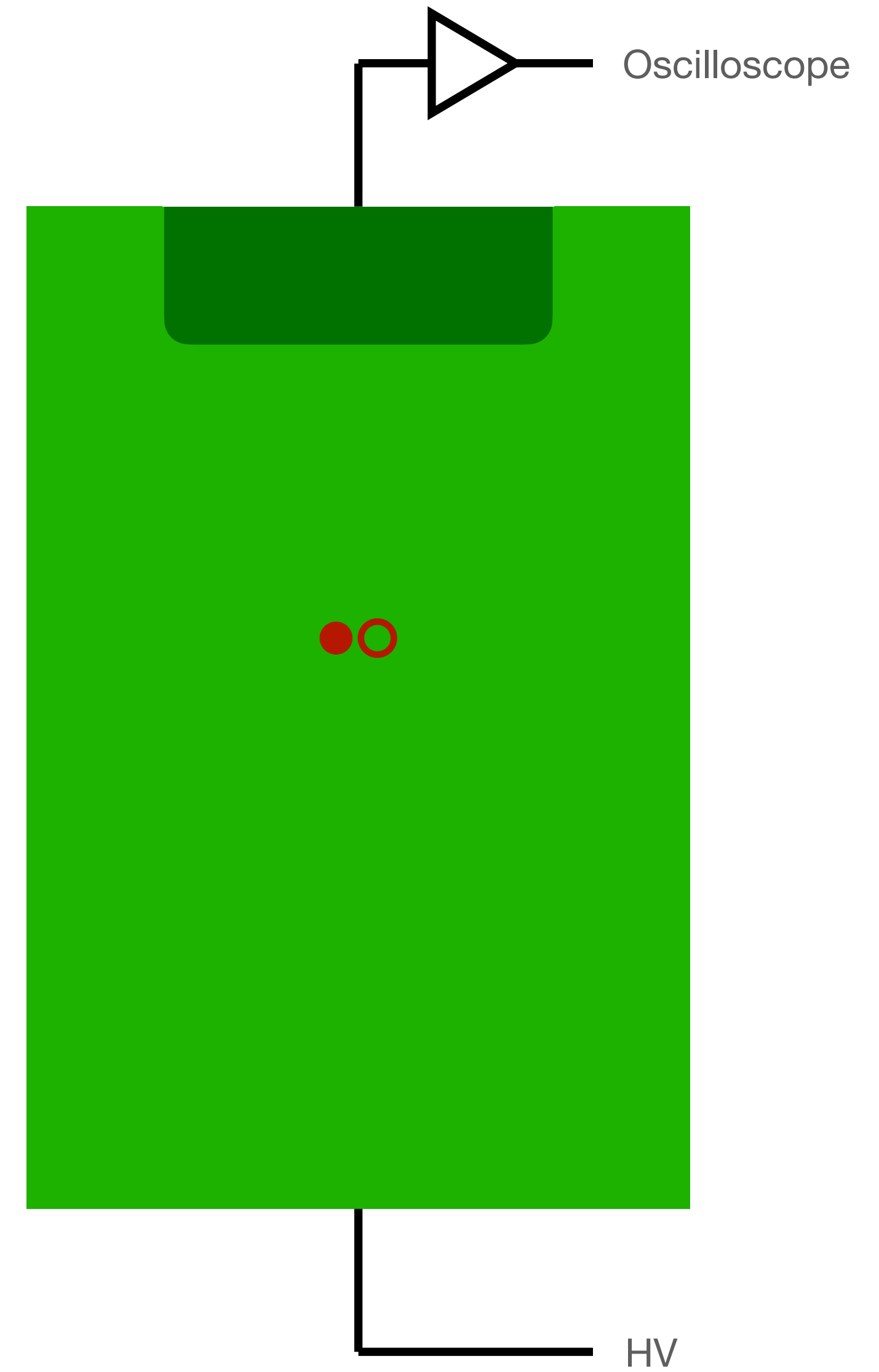

TCT - signal generation

Transient Current Technique

- The whole concept is to look at the induced current on an electrode/cathode while charges move through the device
- Consider charge carriers within the sensor:

- $v_d = \mu E$

- $$I(y,t) = I_e(y,t) + I_h(y,t) \approx e_0 N_{e-h} \frac{1}{W} \left[v_e(y_e(t)) e^{-t/\tau_{\text{eff},e}} + v_h(y_h(t)) e^{-t/\tau_{\text{eff},h}} \right]$$

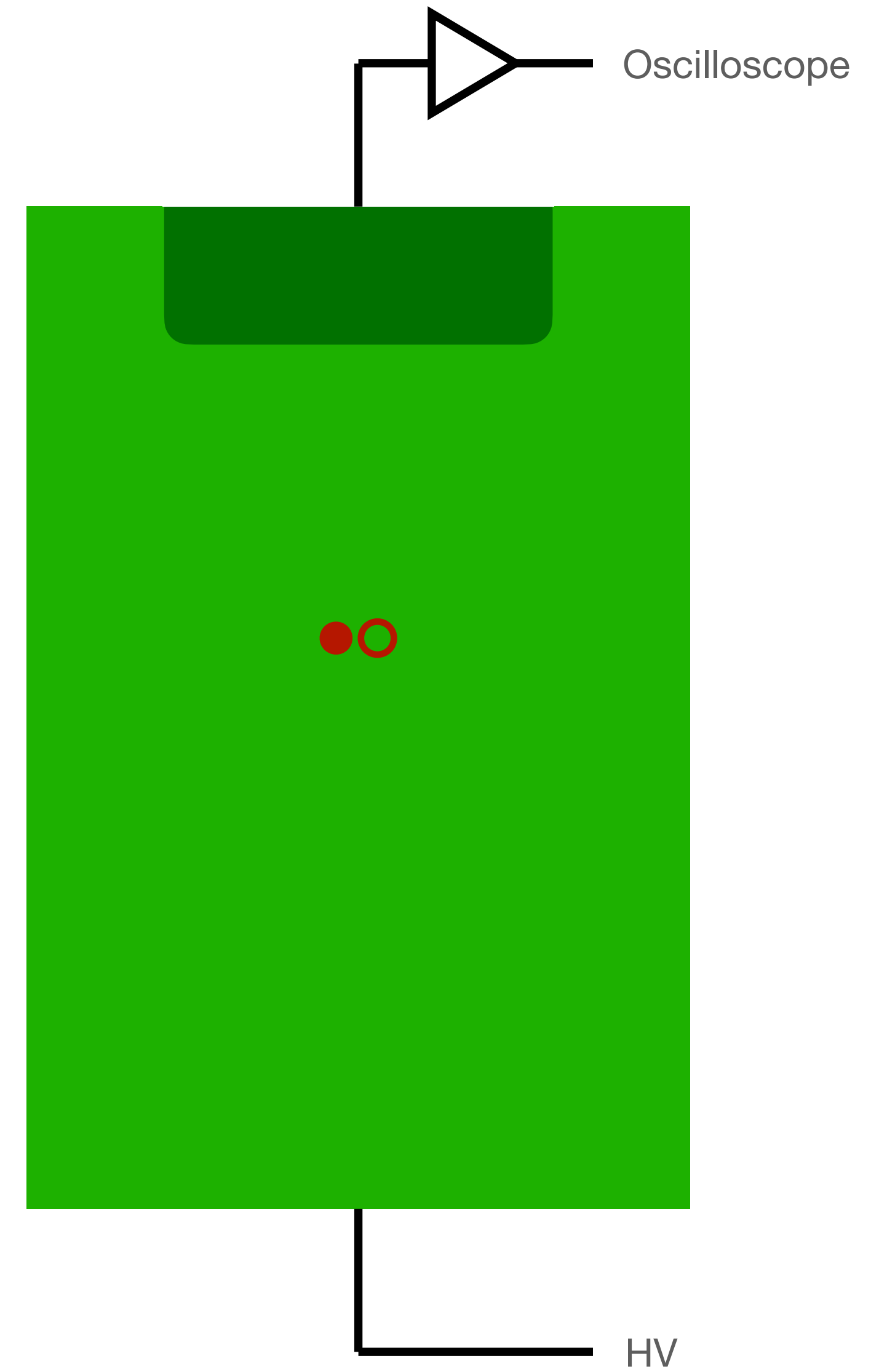

TCT - signal generation

Transient Current Technique

- The whole concept is to look at the induced current on an electrode/cathode while charges move through the device
- Consider charge carriers within the sensor:

- $v_d = \mu E$

- $$I(y,t) = I_e(y,t) + I_h(y,t) \approx e_0 N e^{-k y} \left[\frac{1}{W} \left[v_e(y_e(t)) e^{-t/\tau_{\text{eff},e}} + v_h(y_h(t)) e^{-t/\tau_{\text{eff},h}} \right] \right]$$

Weighting field

Electron velocity

Hole velocity

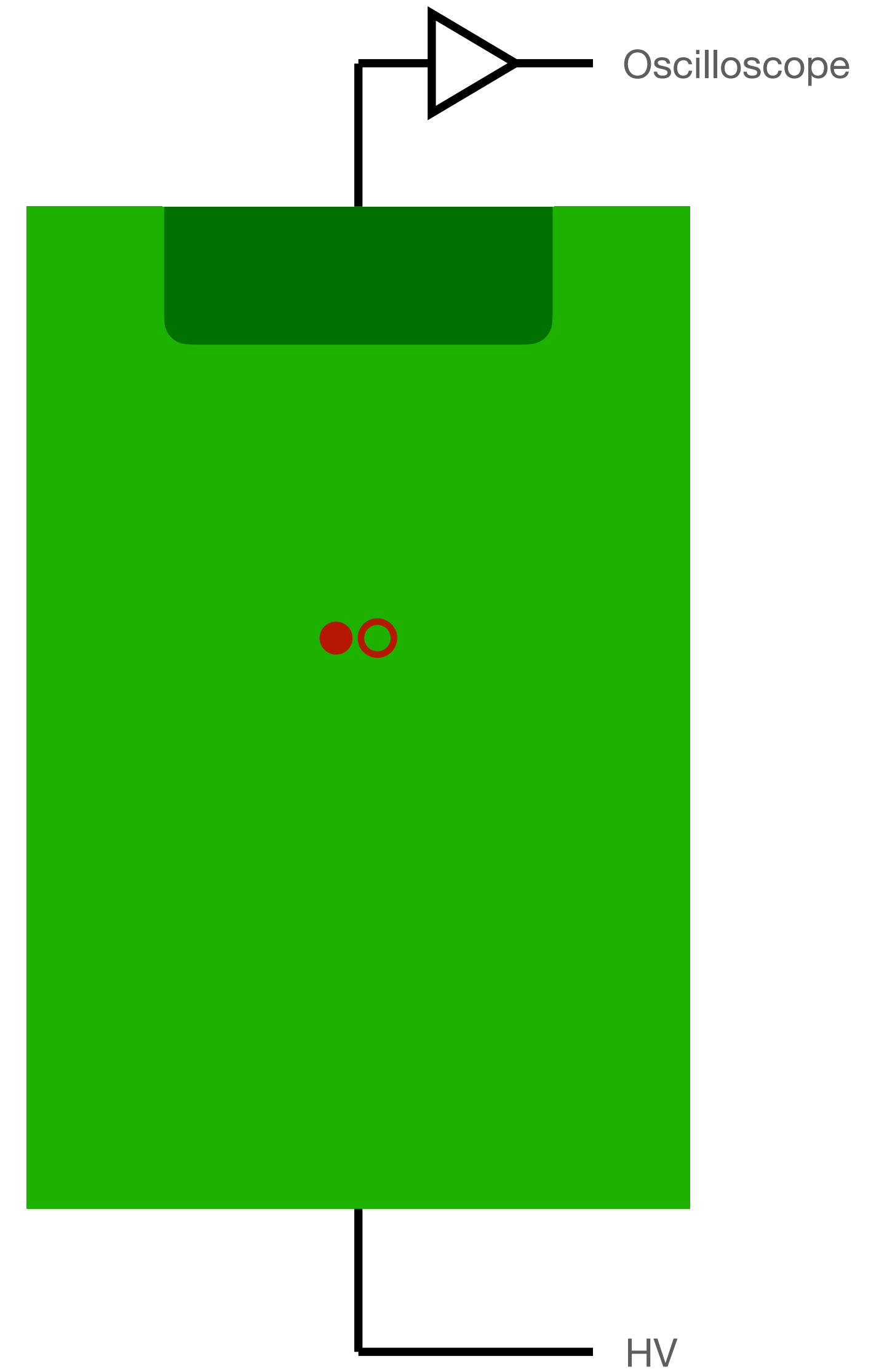

TCT - signal generation

Transient Current Technique

- The whole concept is to look at the induced current on an electrode/cathode while charges move through the device
- Consider charge carriers within the sensor:

- $v_d = \mu E$

- $I(y,t) = I_e(y,t) + I_h(y,t) \approx e_0 N e^{-k} \frac{1}{W} \left[v_e(y_e(t)) e^{-t/\tau_{eff,e}} + v_h(y_h(t)) e^{-t/\tau_{eff,h}} \right]$

Weighting field

Electron velocity

Hole velocity

Proportional to Electric field
(below saturation)

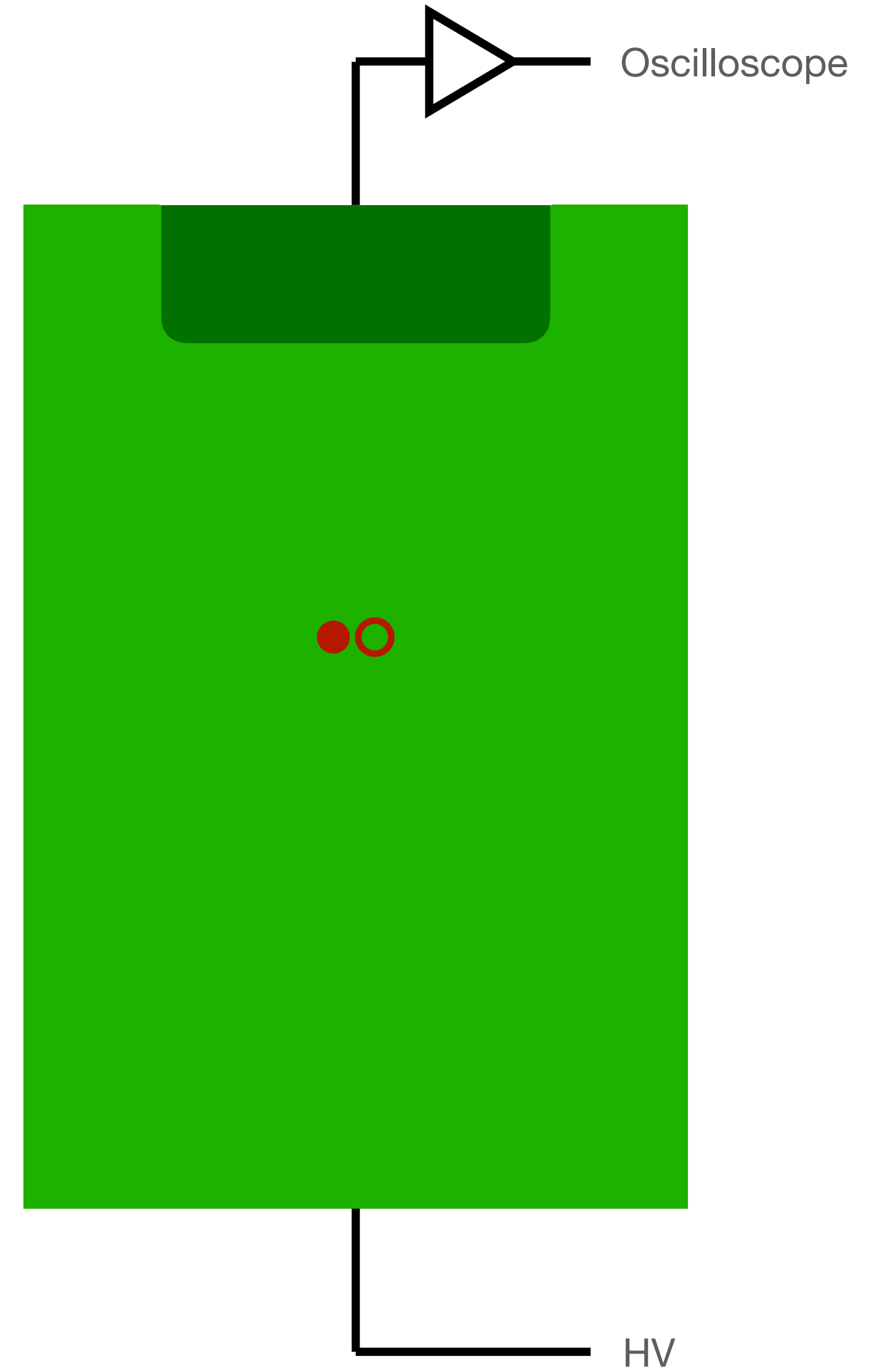

TCT - signal generation

Transient Current Technique

- Consider a typical electric field, with a sensor biased to around depletion

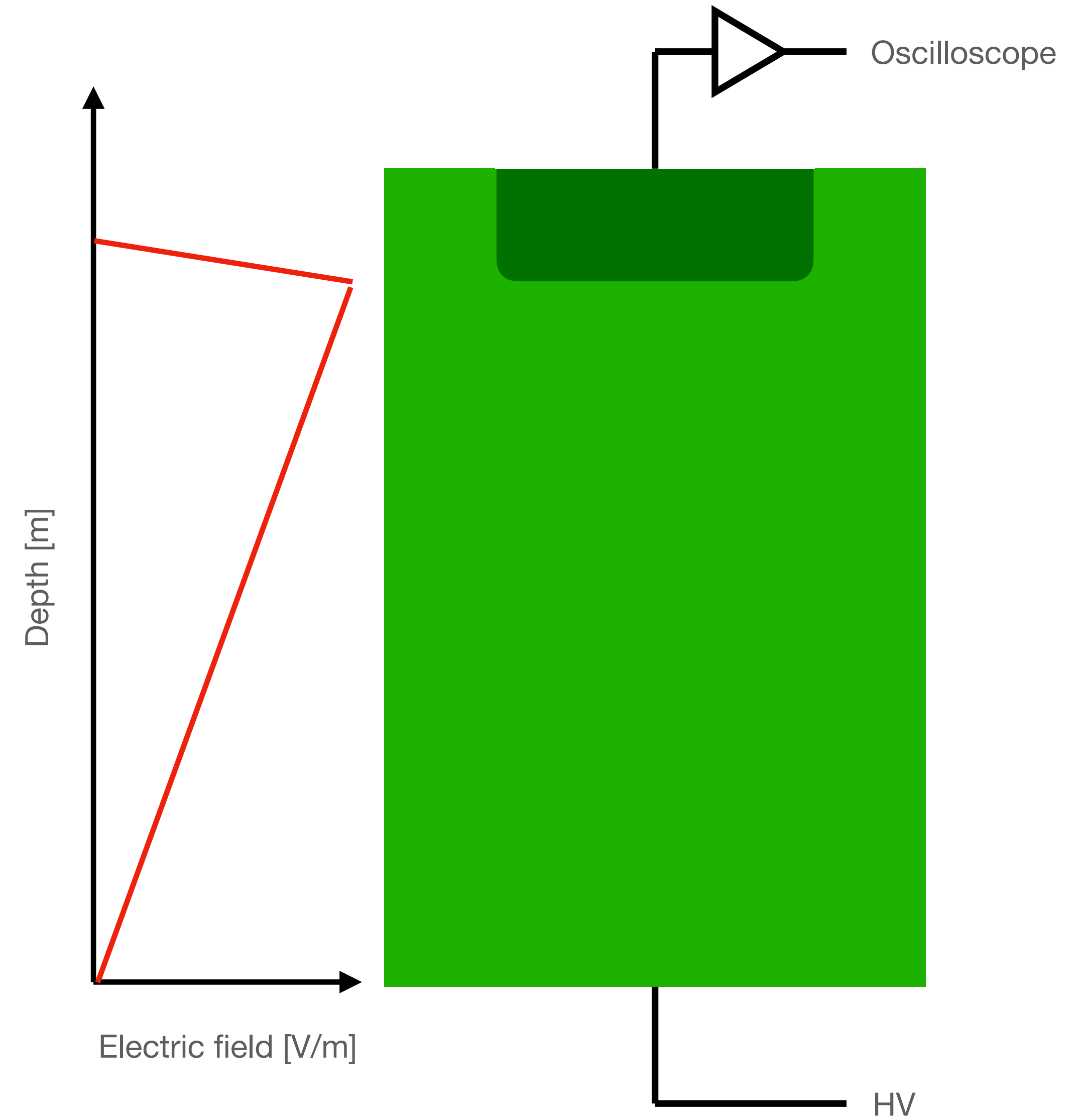

TCT - signal generation

Transient Current Technique

- Consider a typical electric field, with a sensor biased to around depletion
- Look at the induced signal as charge carriers are created at a single spatial point within the sensor

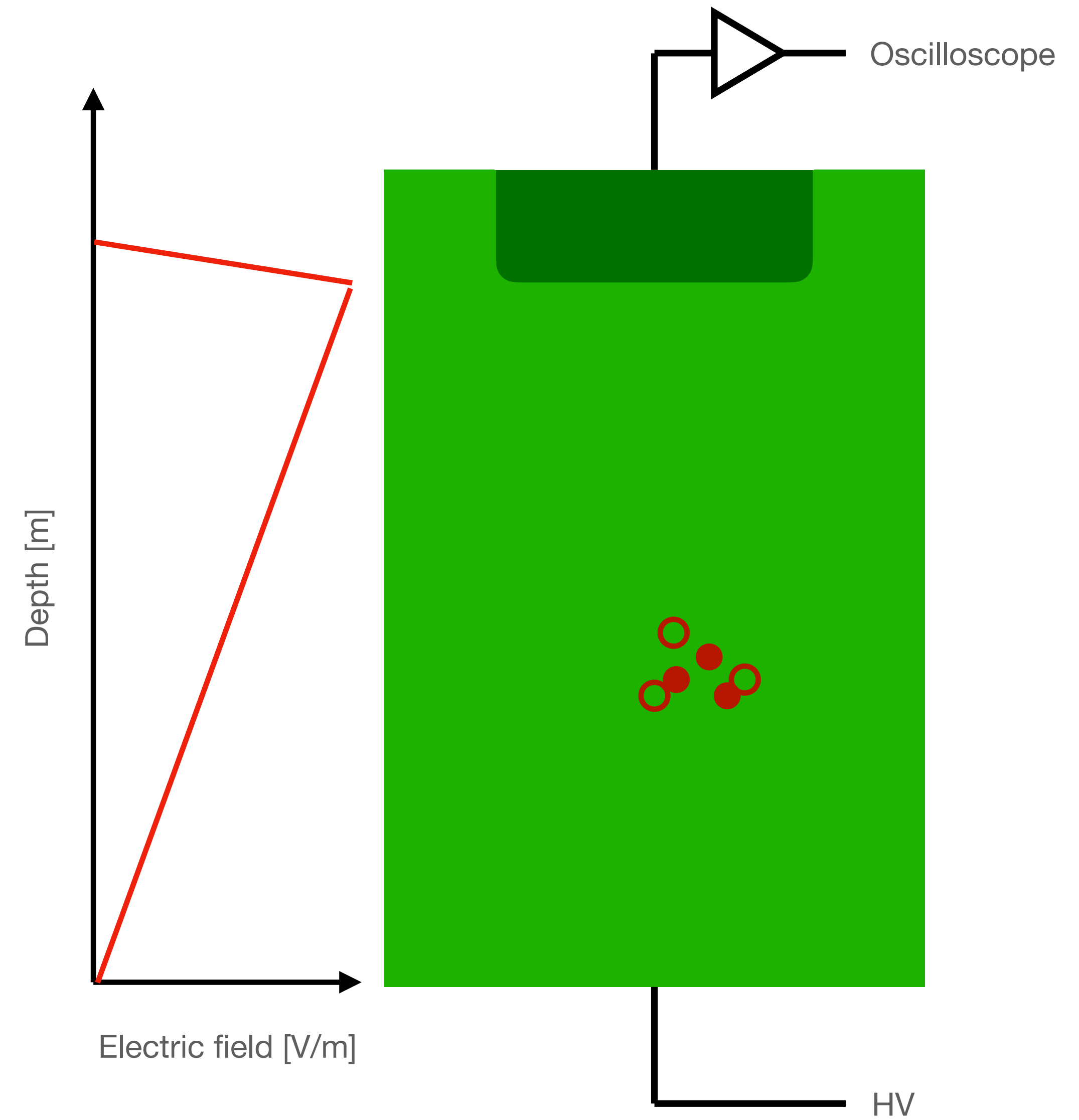

TCT - signal generation

Transient Current Technique

- In most approximations, the acceleration time of the charge carriers is ignored and they are considered to effectively hit their drift velocity instantaneously
- Electron and hole velocities are different, so their current pulses look different (holes move a factor ~ 3 slower)
- Note that the charge carriers are assumed to be independent and do not see each other

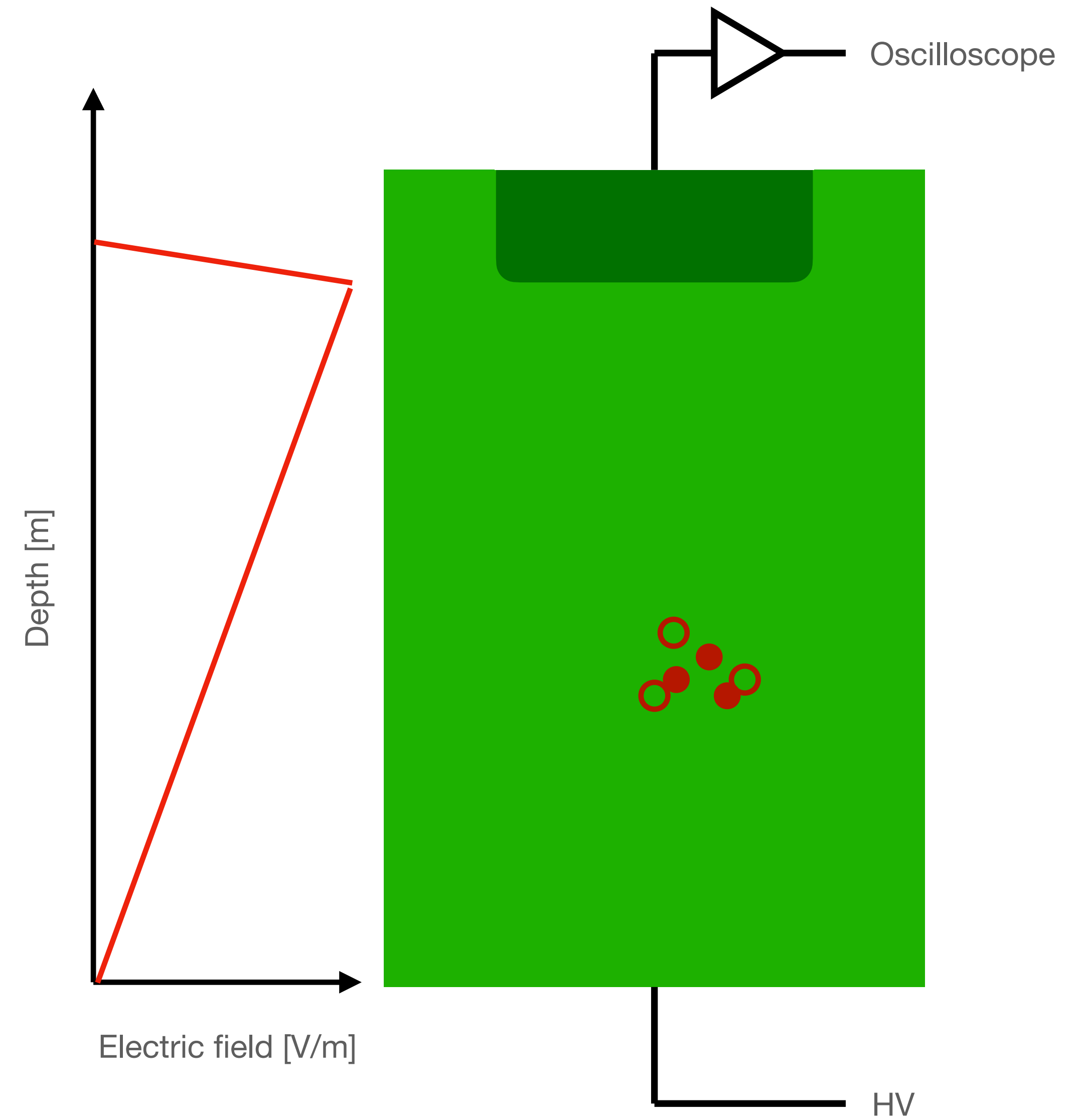

TCT - signal generation

Transient Current Technique

- As the carriers drift, their drift velocities change with the local electric field - in this case the electrons are getting faster and the holes are getting slower
- The change in weighting field also leads to greater contribution to the induced current closer to the junction

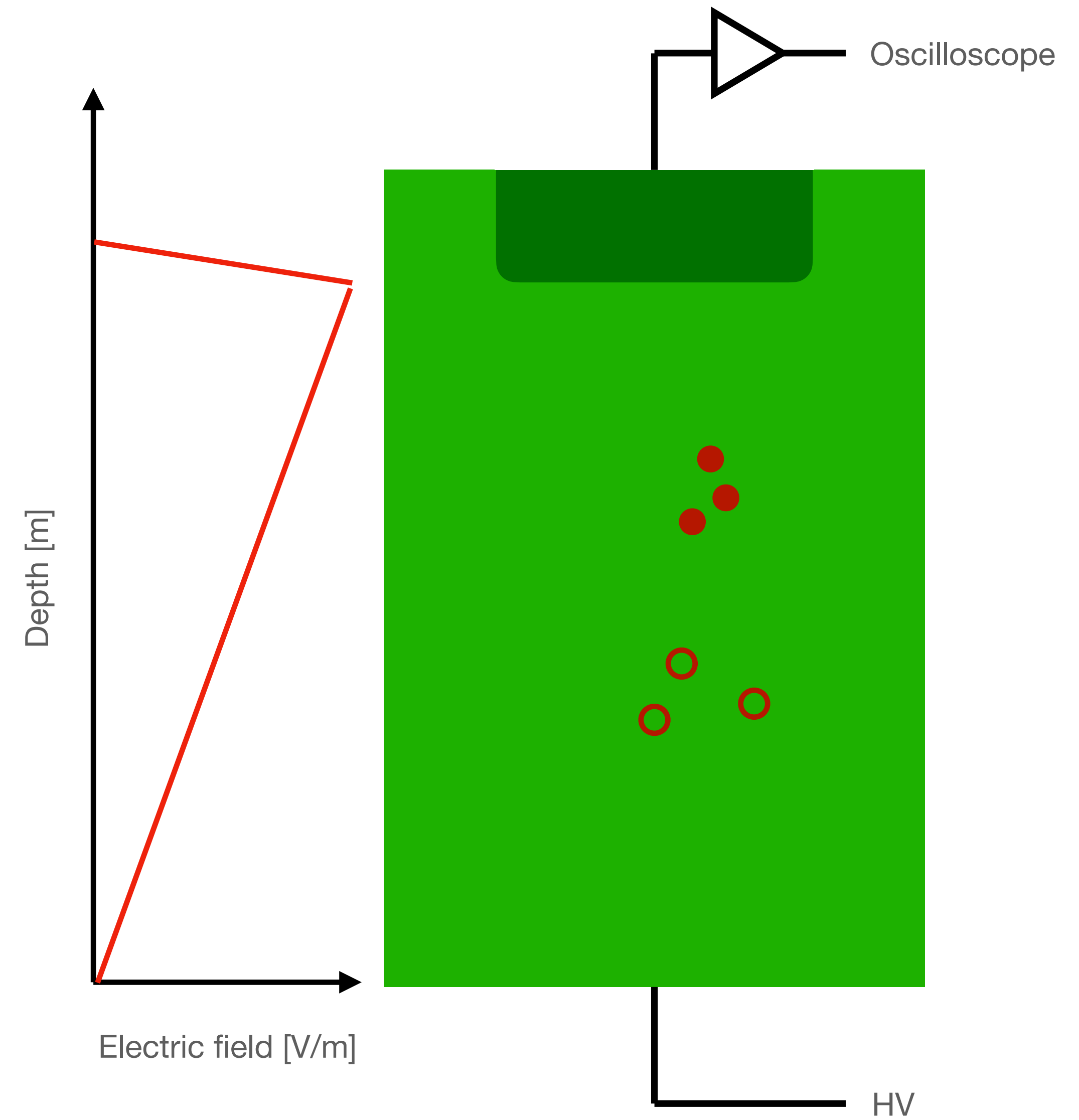
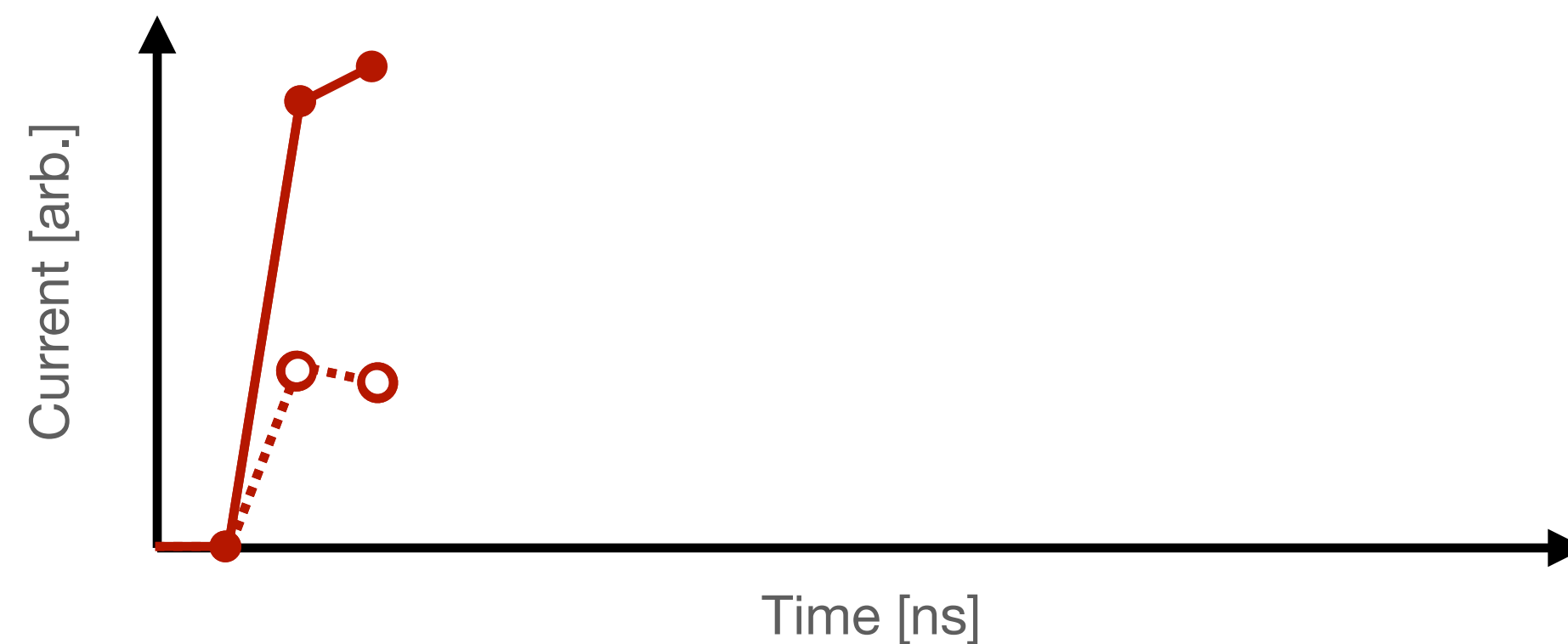

TCT - signal generation

Transient Current Technique

- Carriers continue to drift until they are collected (or stopped via other means - see radiation damage later)

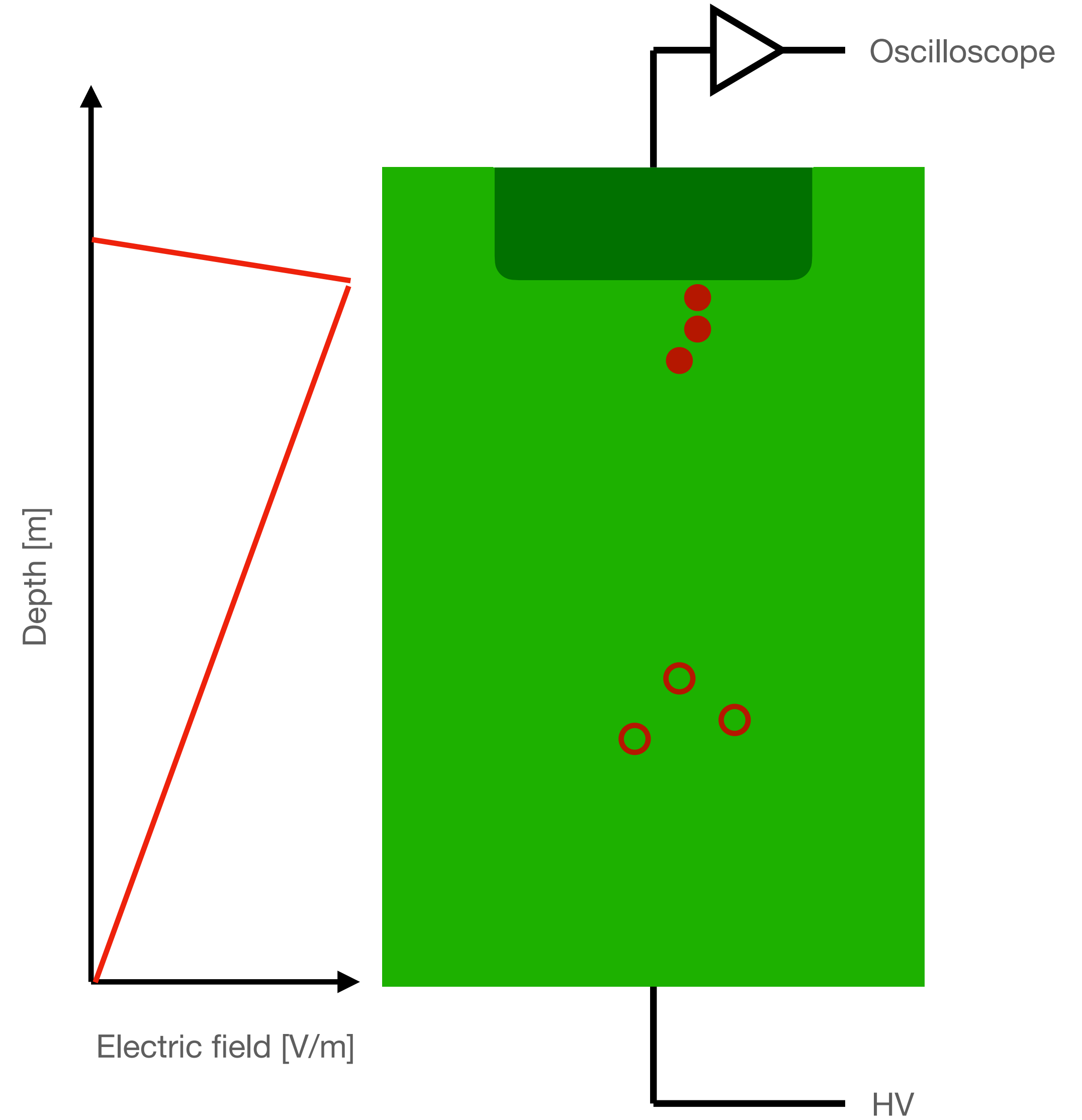
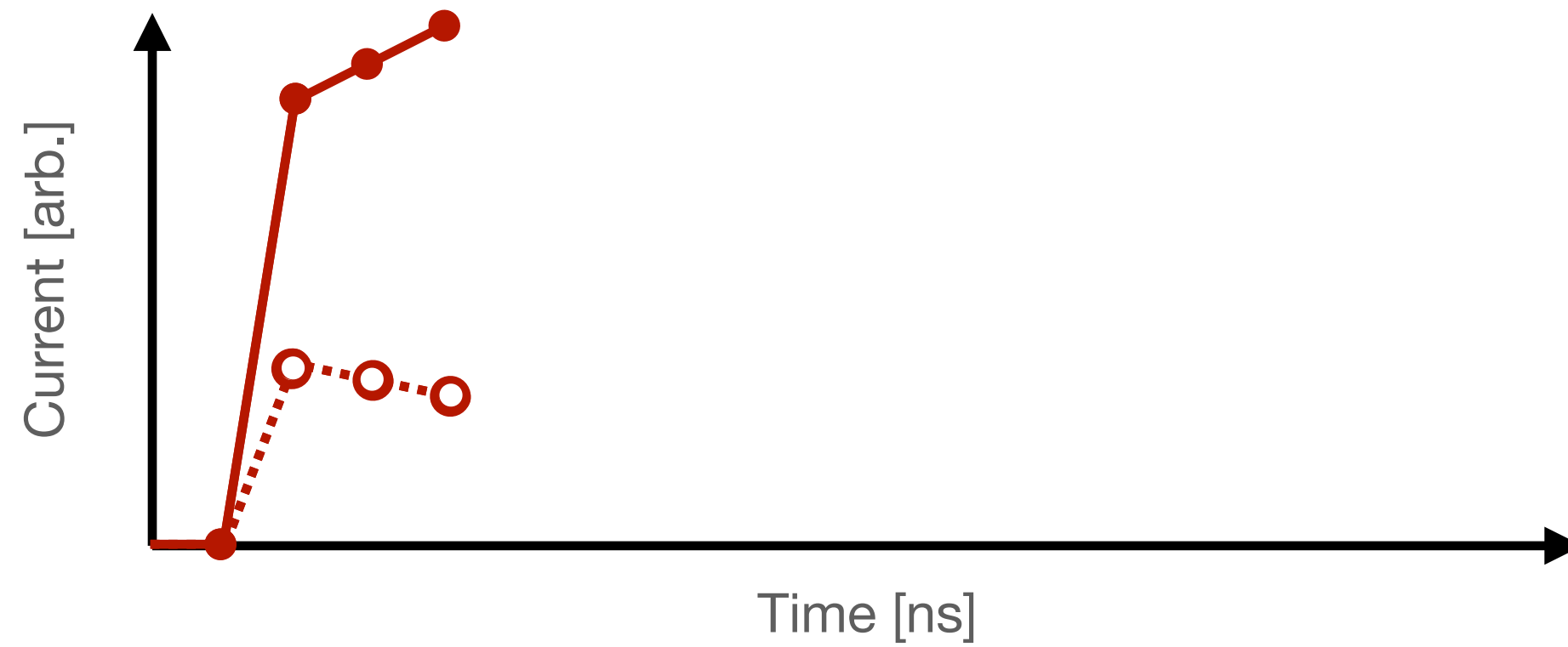

TCT - signal generation

Transient Current Technique

- Carriers continue to drift until they are collected (or stopped via other means - see radiation damage later)

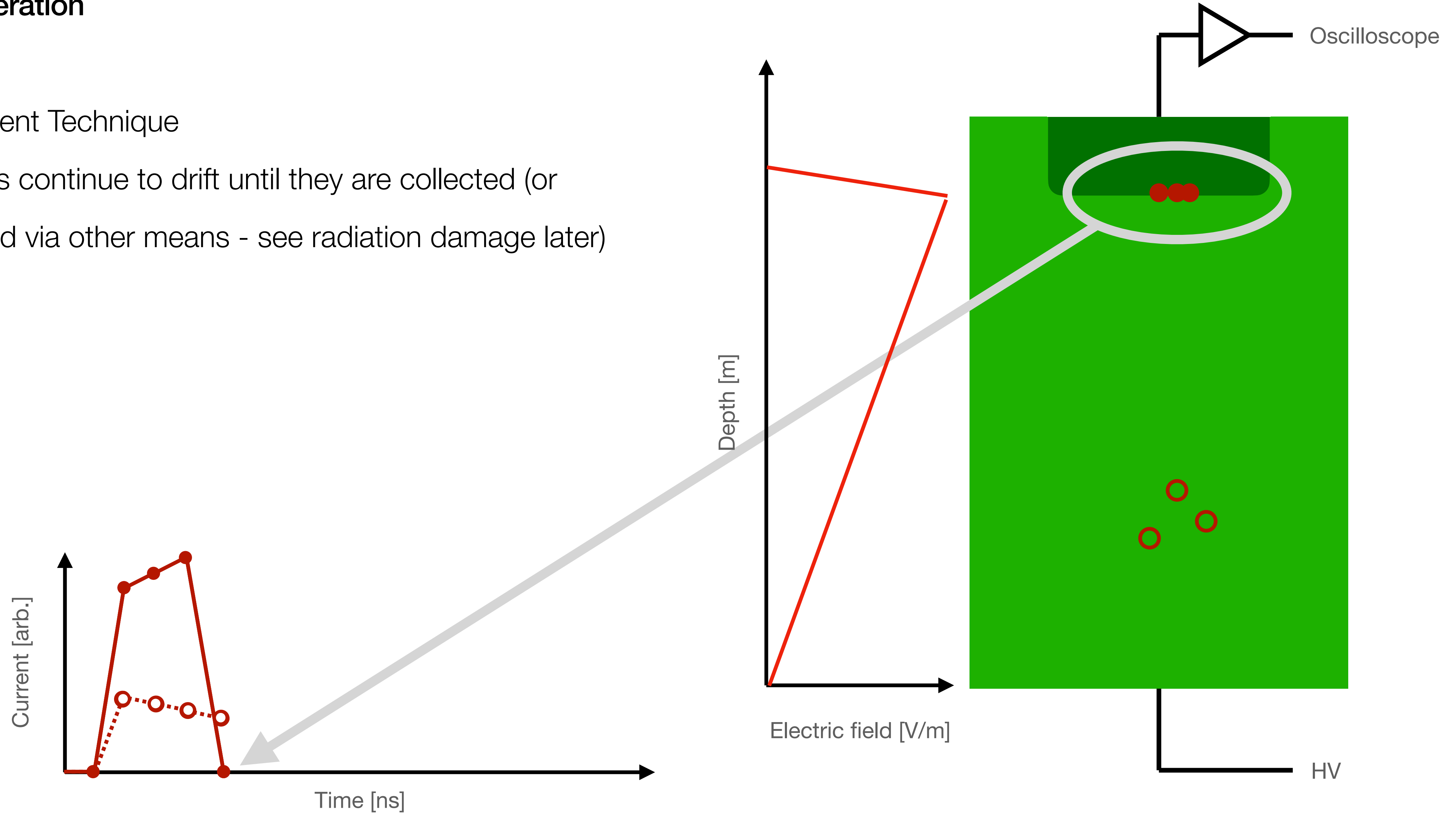

TCT - signal generation

Transient Current Technique

- Carriers continue to drift until they are collected (or stopped via other means - see radiation damage later)

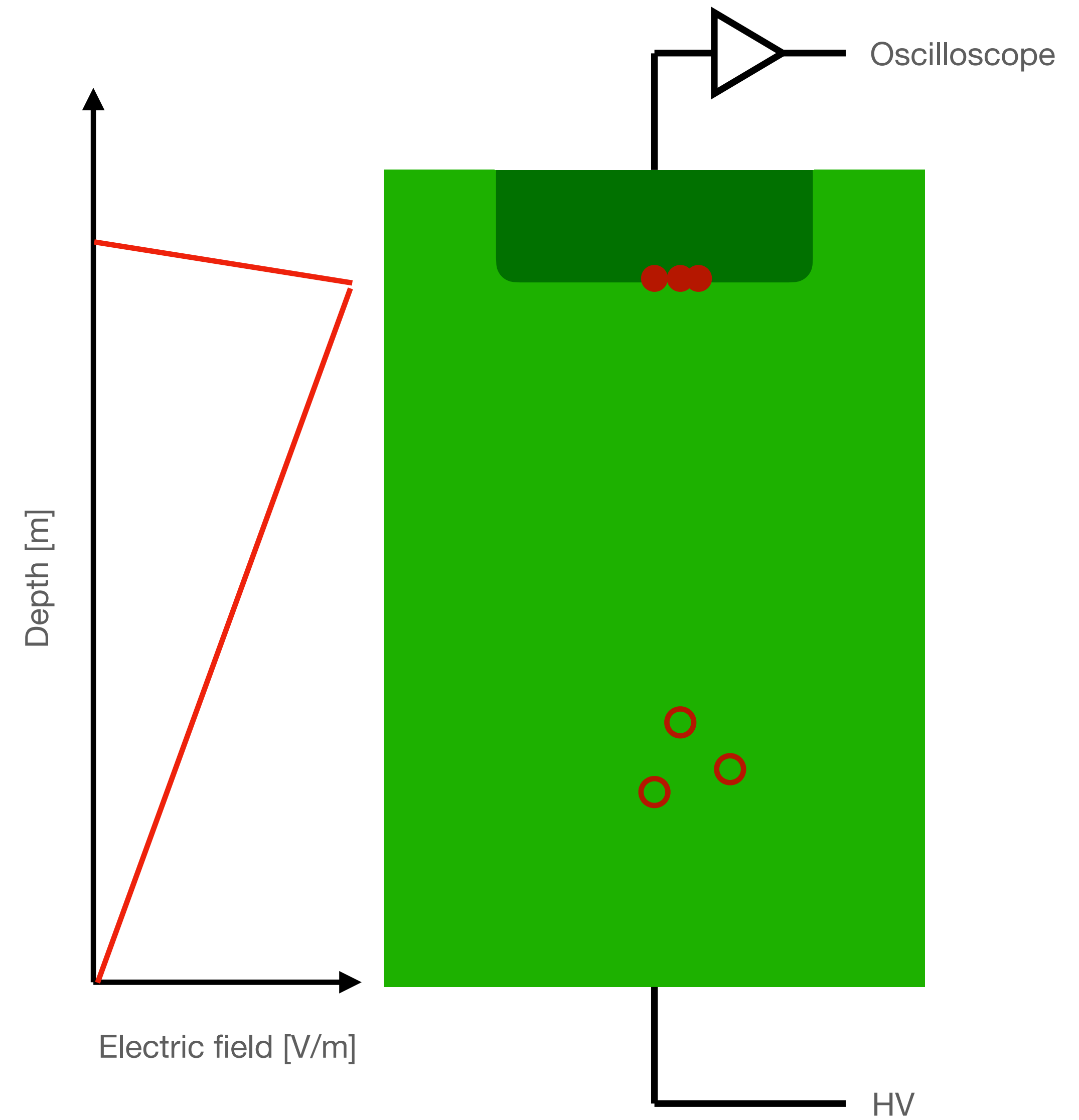
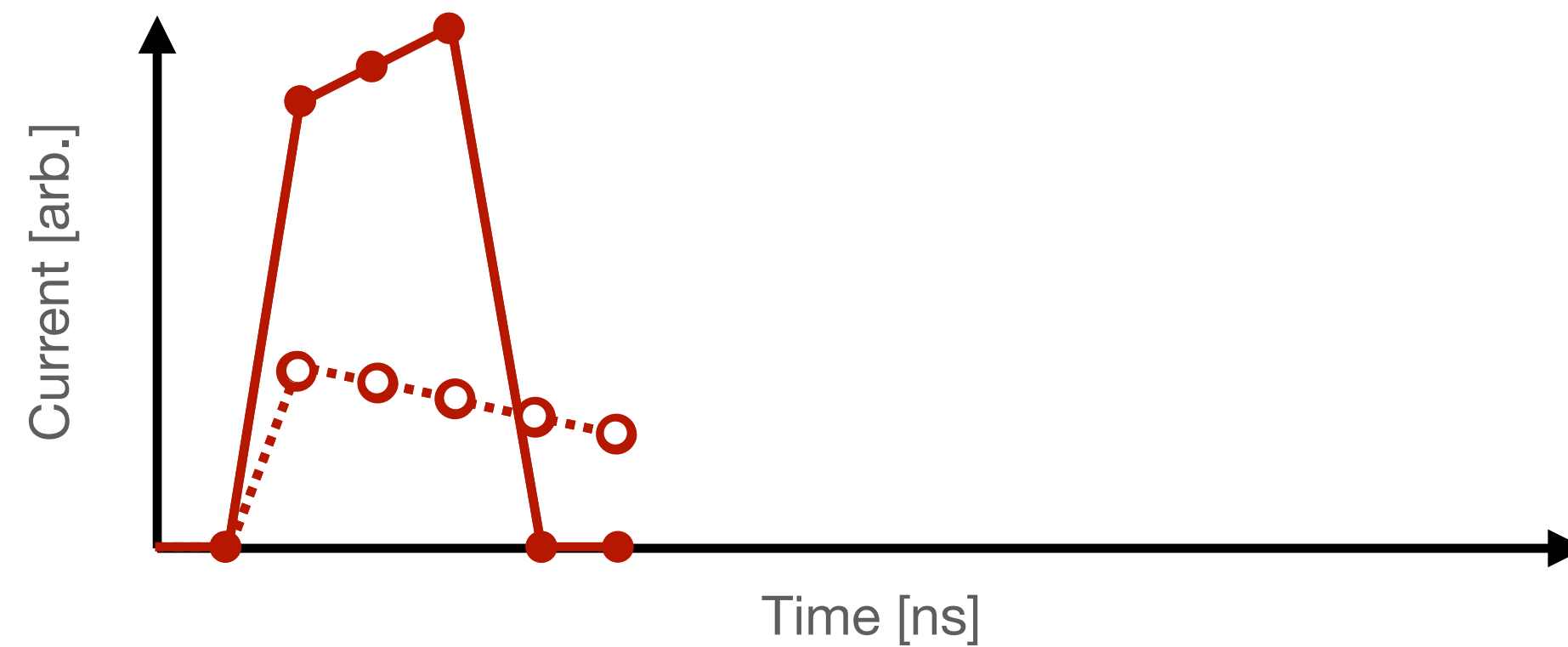

TCT - signal generation

Transient Current Technique

- Carriers continue to drift until they are collected (or stopped via other means - see radiation damage later)

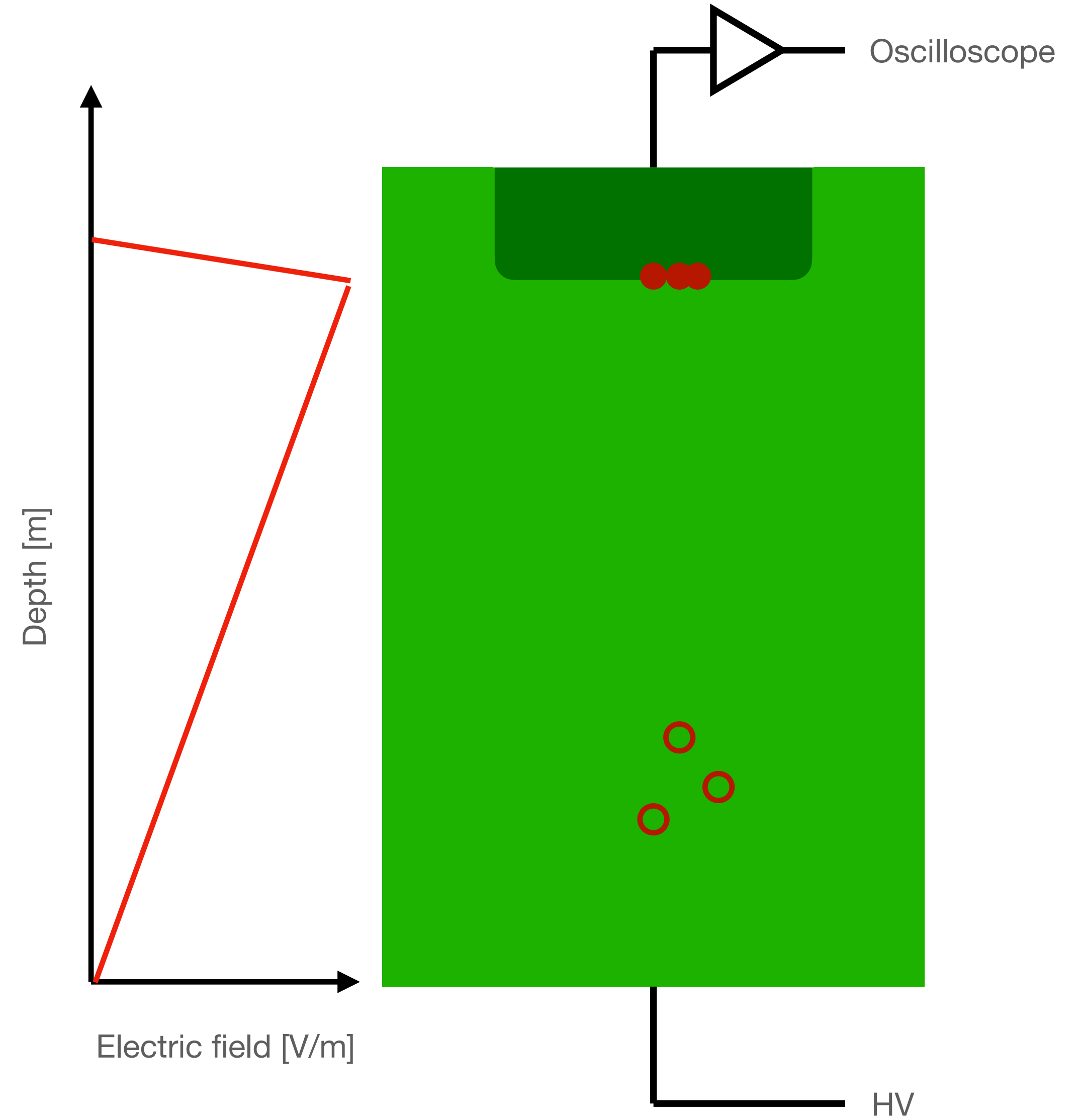
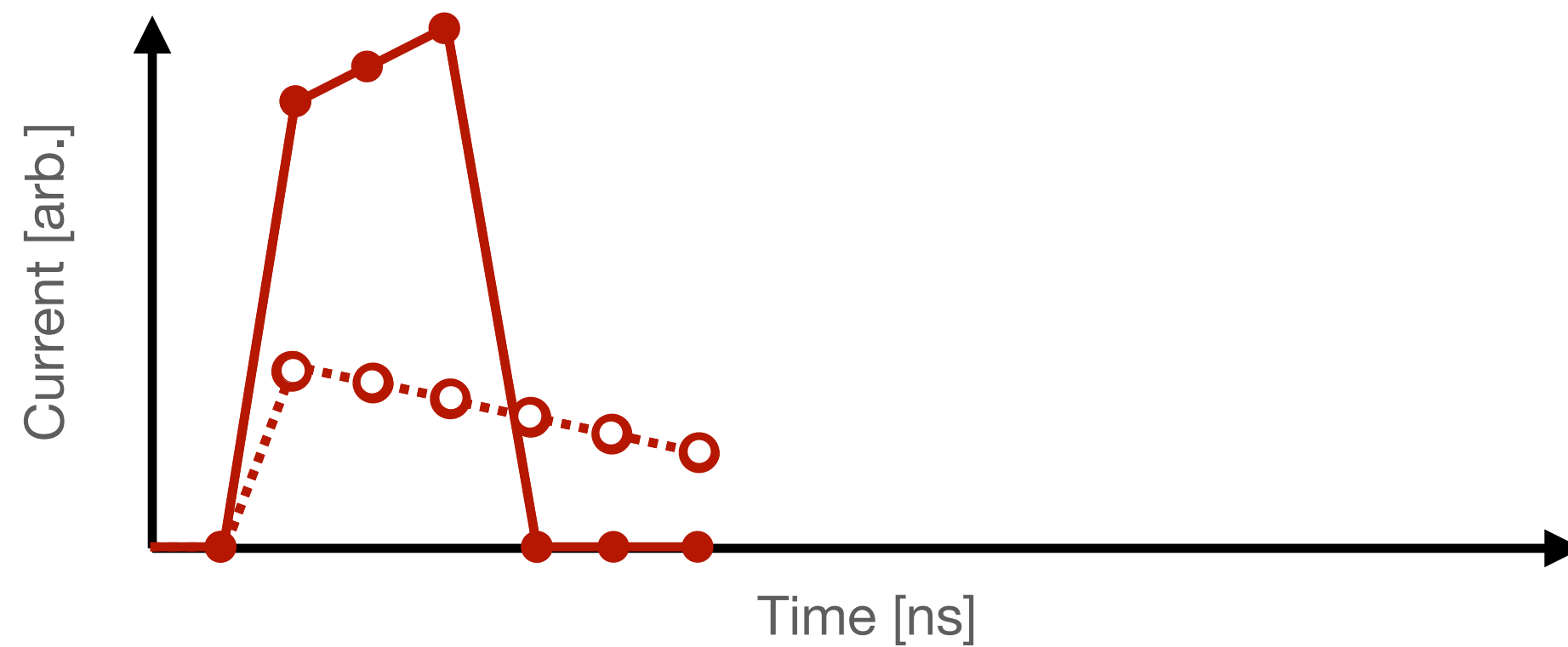

TCT - signal generation

Transient Current Technique

- Carriers continue to drift until they are collected (or stopped via other means - see radiation damage later)

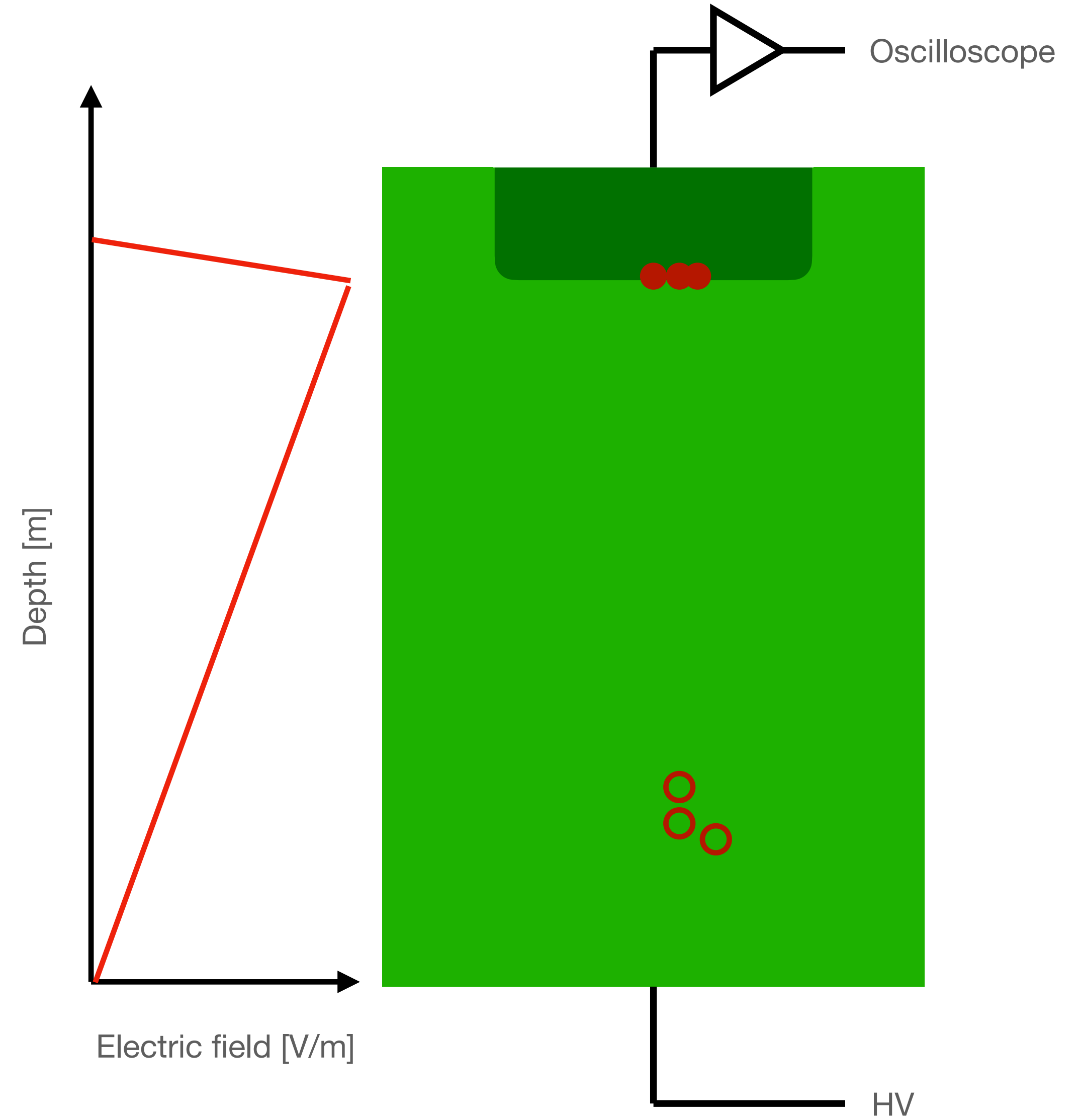
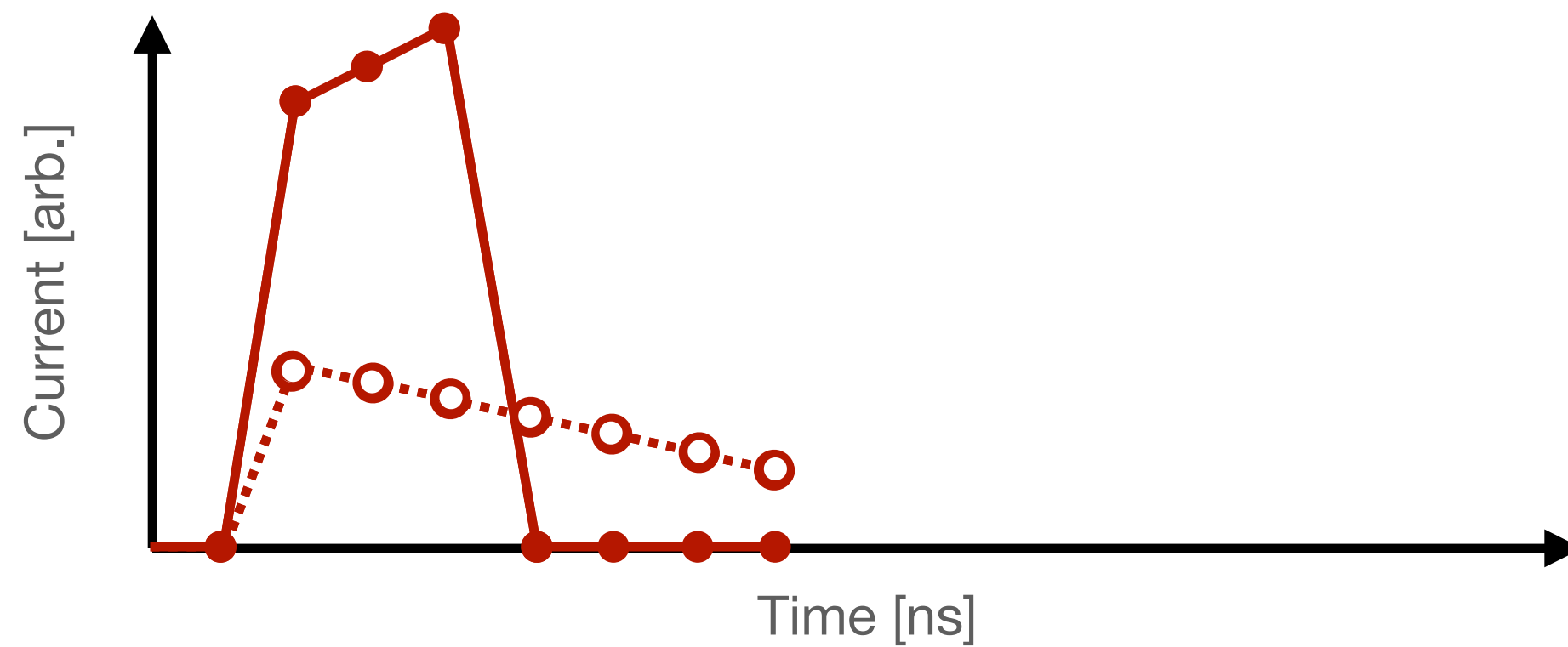

TCT - signal generation

Transient Current Technique

- Carriers continue to drift until they are collected (or stopped via other means - see radiation damage later)

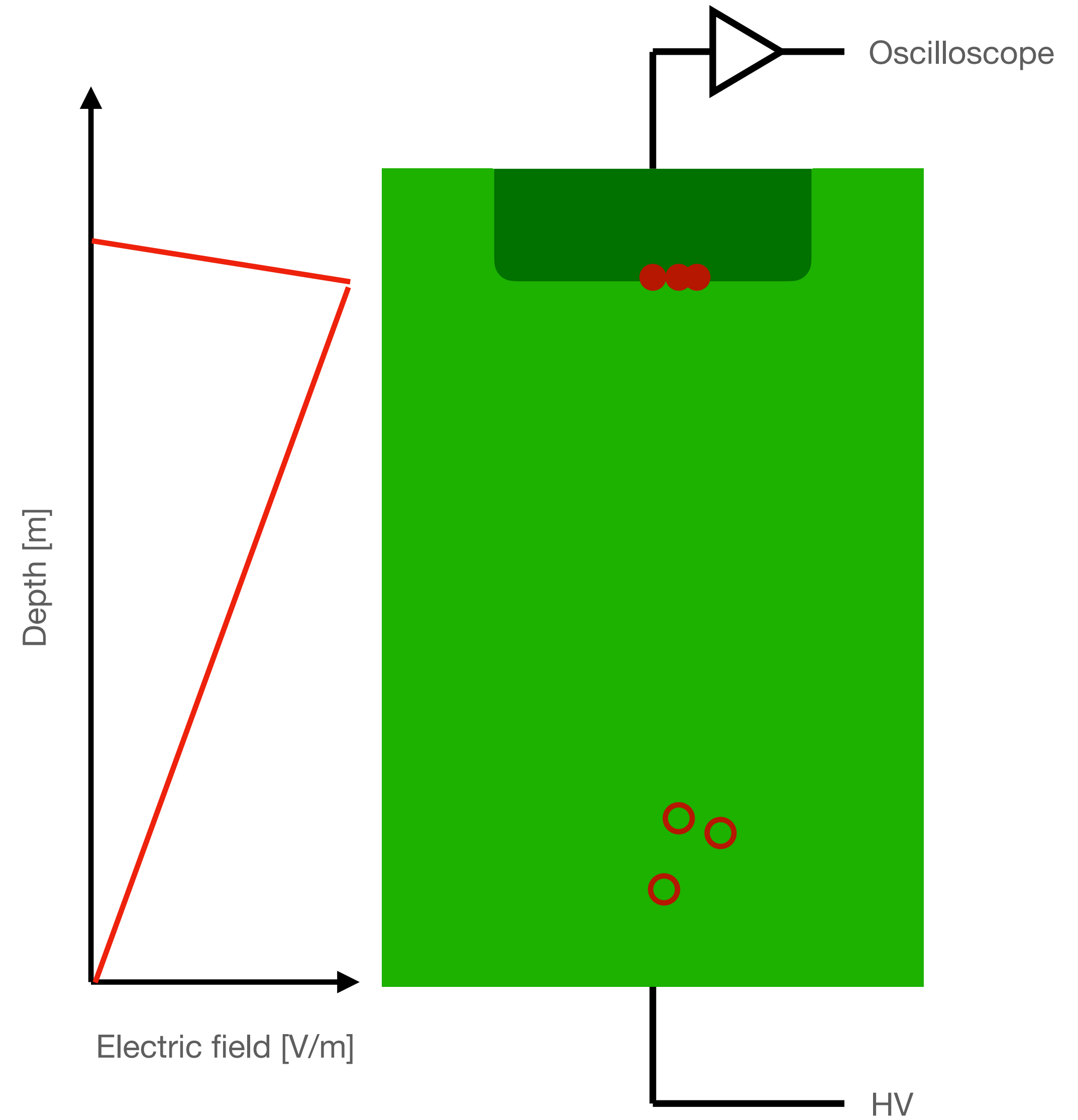
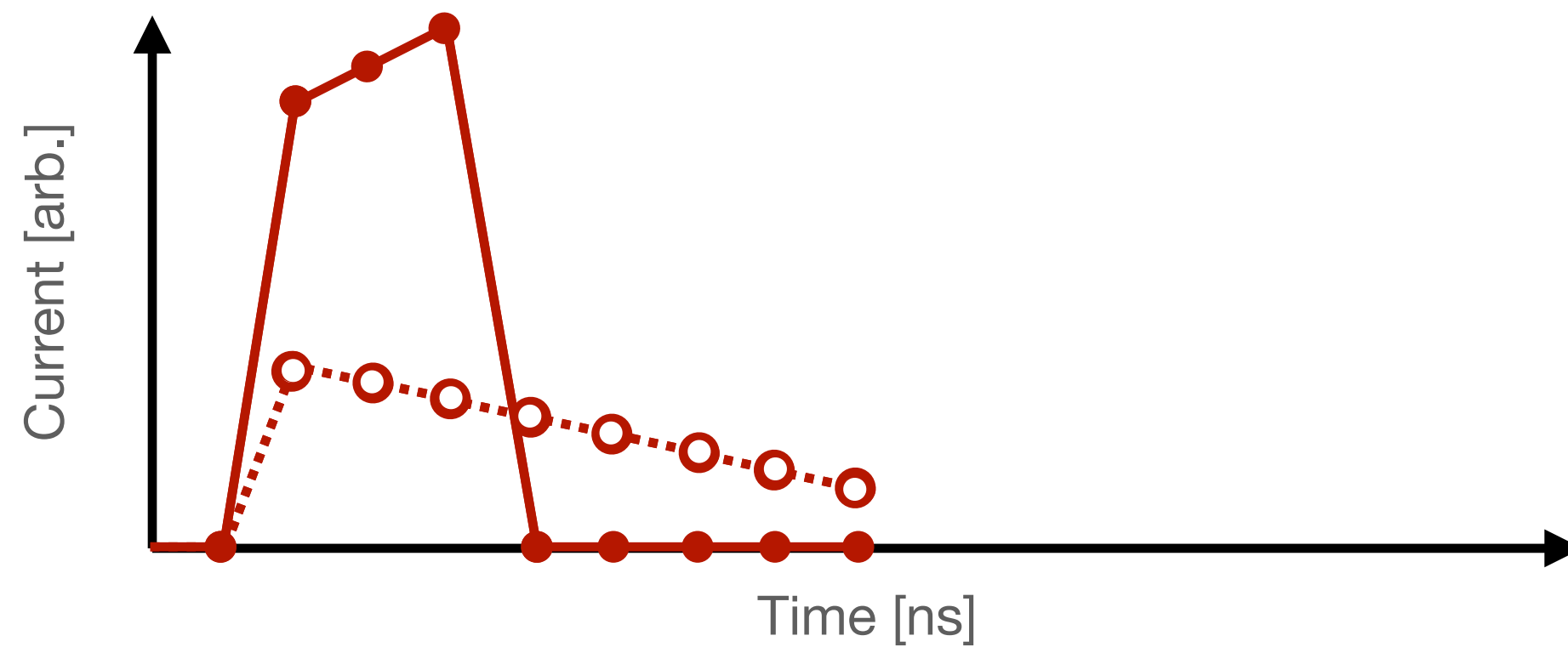

TCT - signal generation

Transient Current Technique

- Carriers continue to drift until they are collected (or stopped via other means - see radiation damage later)

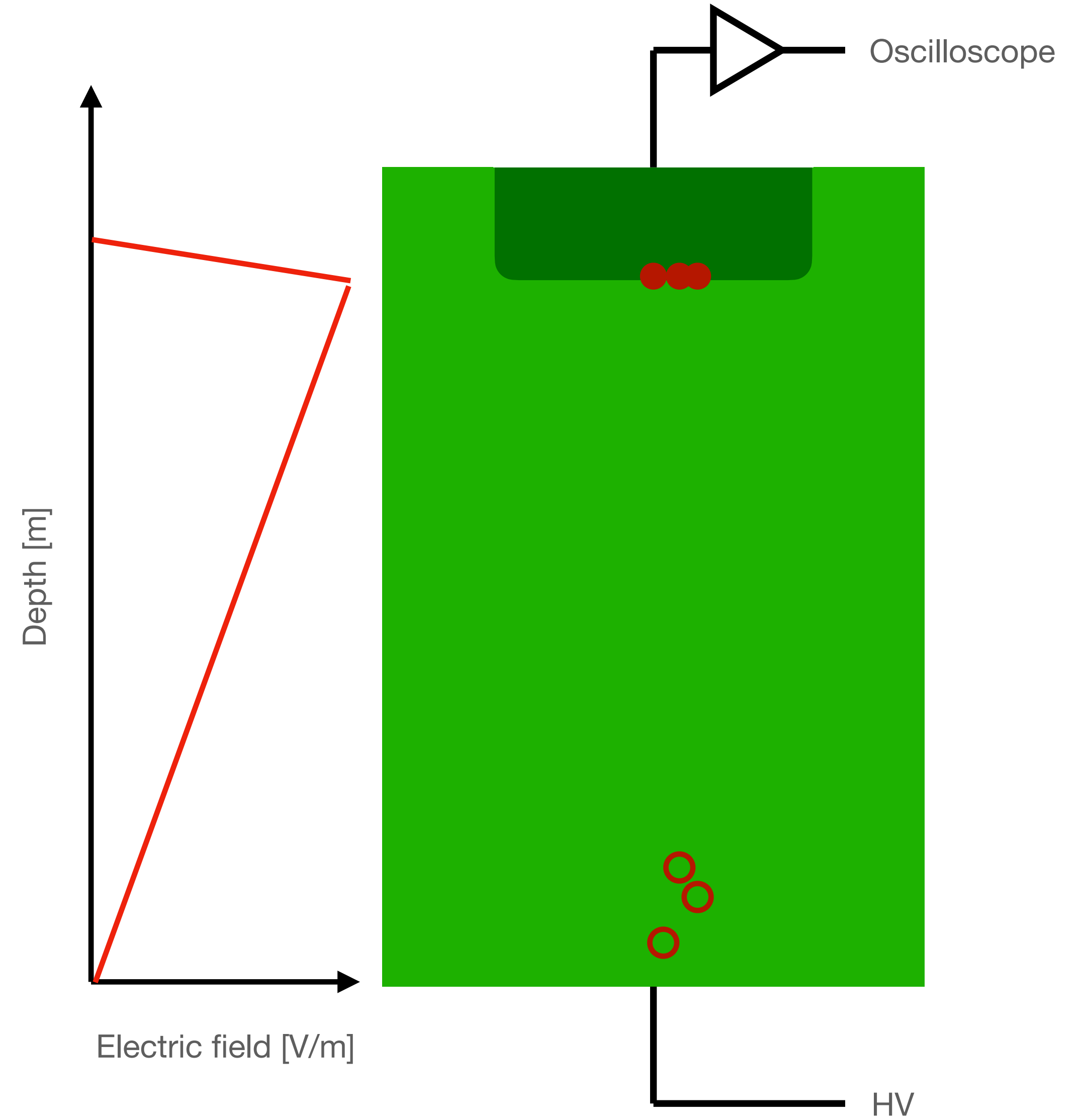
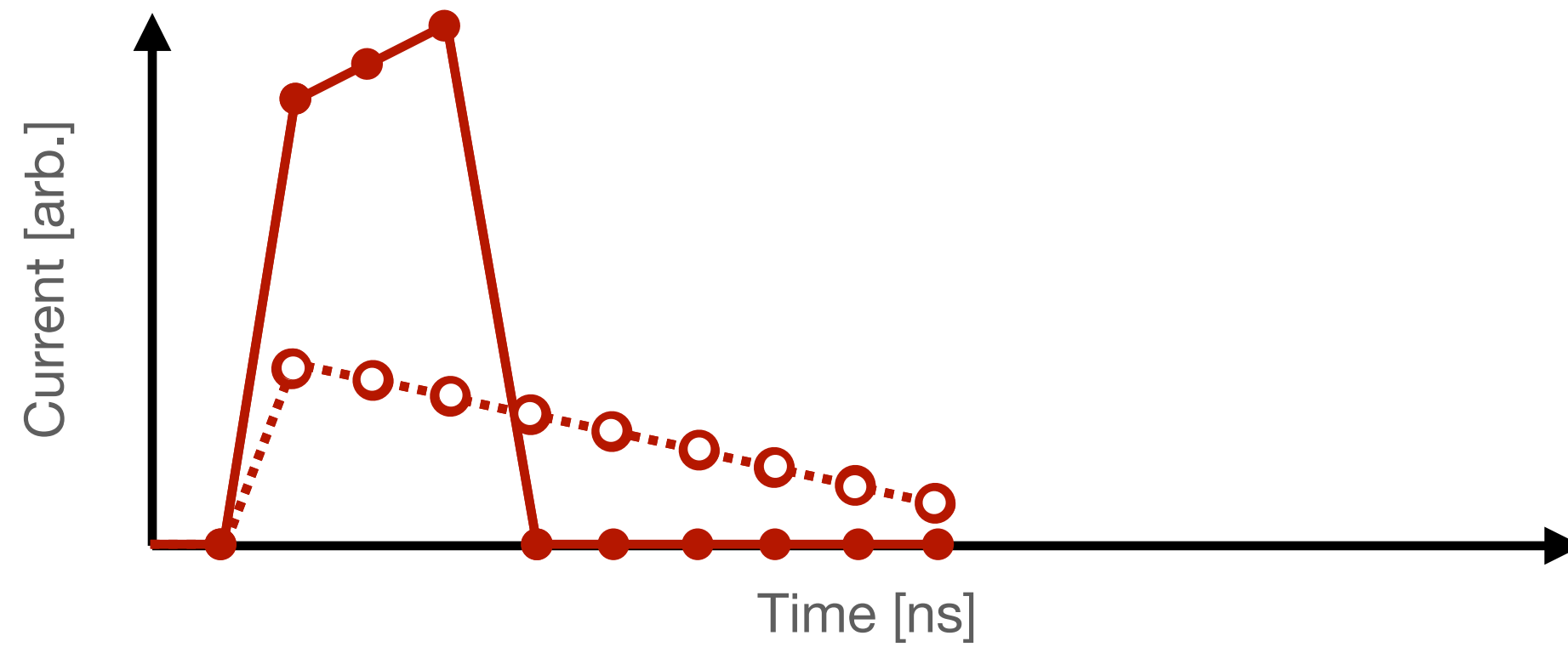

TCT - signal generation

Transient Current Technique

- Carriers continue to drift until they are collected (or stopped via other means - see radiation damage later)

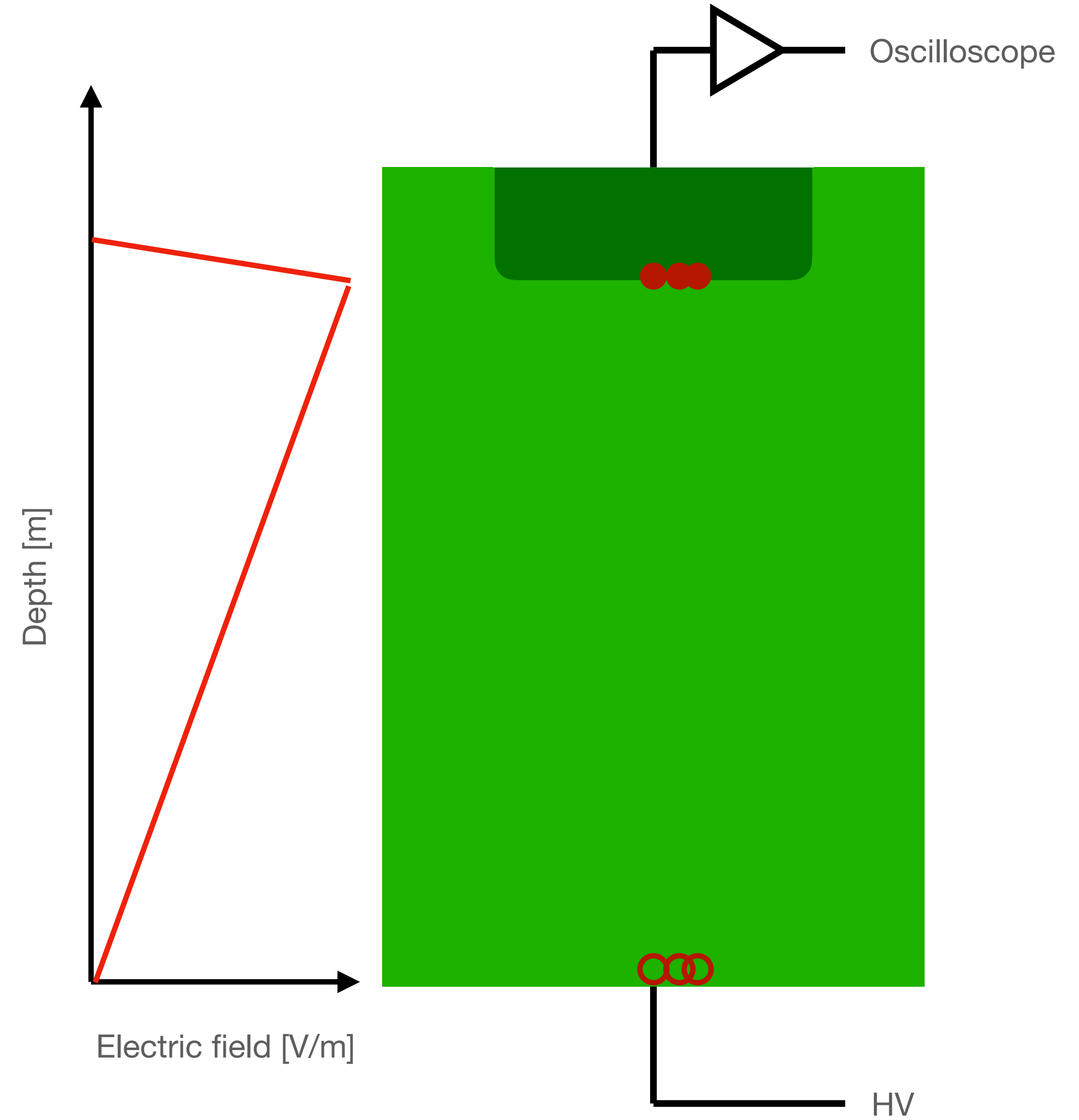
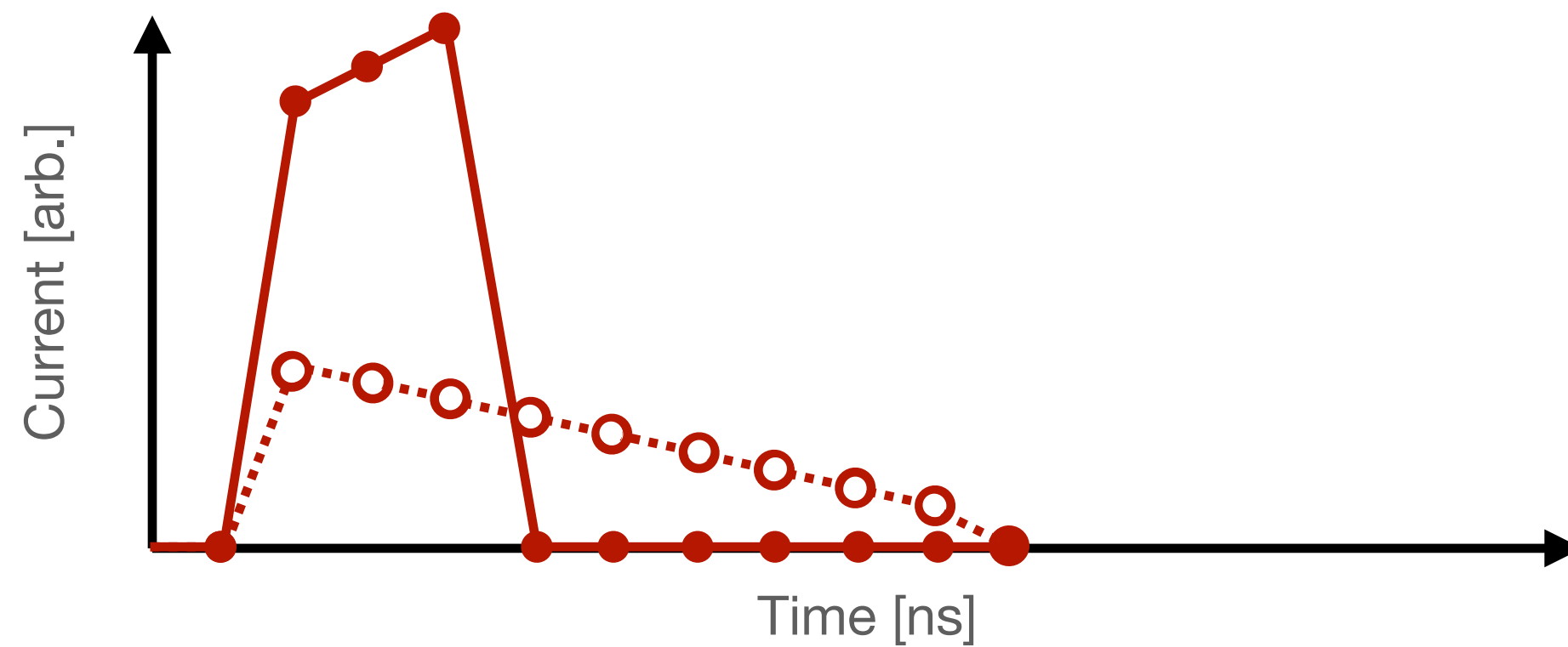

TCT - signal generation

Transient Current Technique

- Finally we have our total current pulse from a single set of generated charge carriers

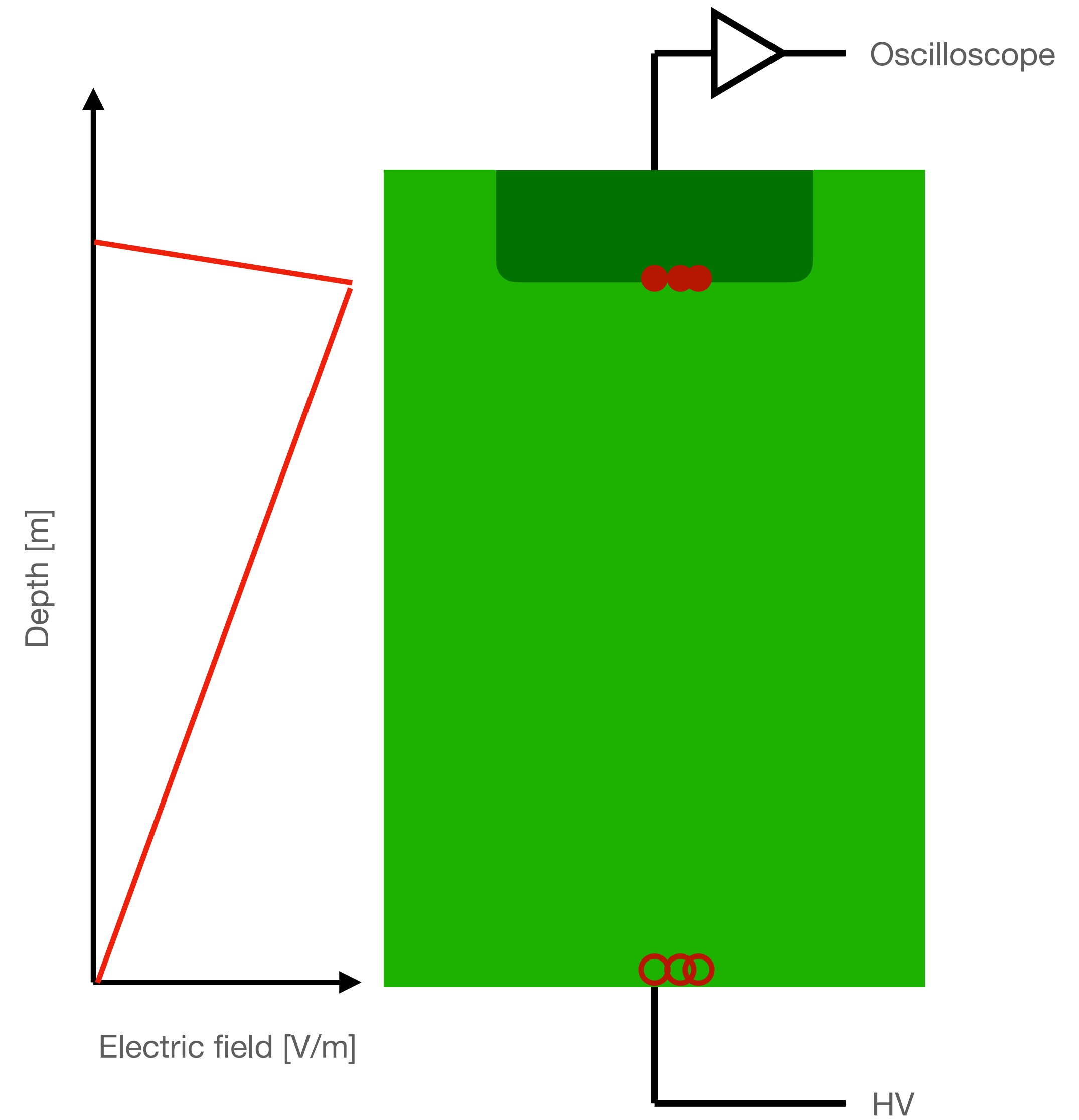
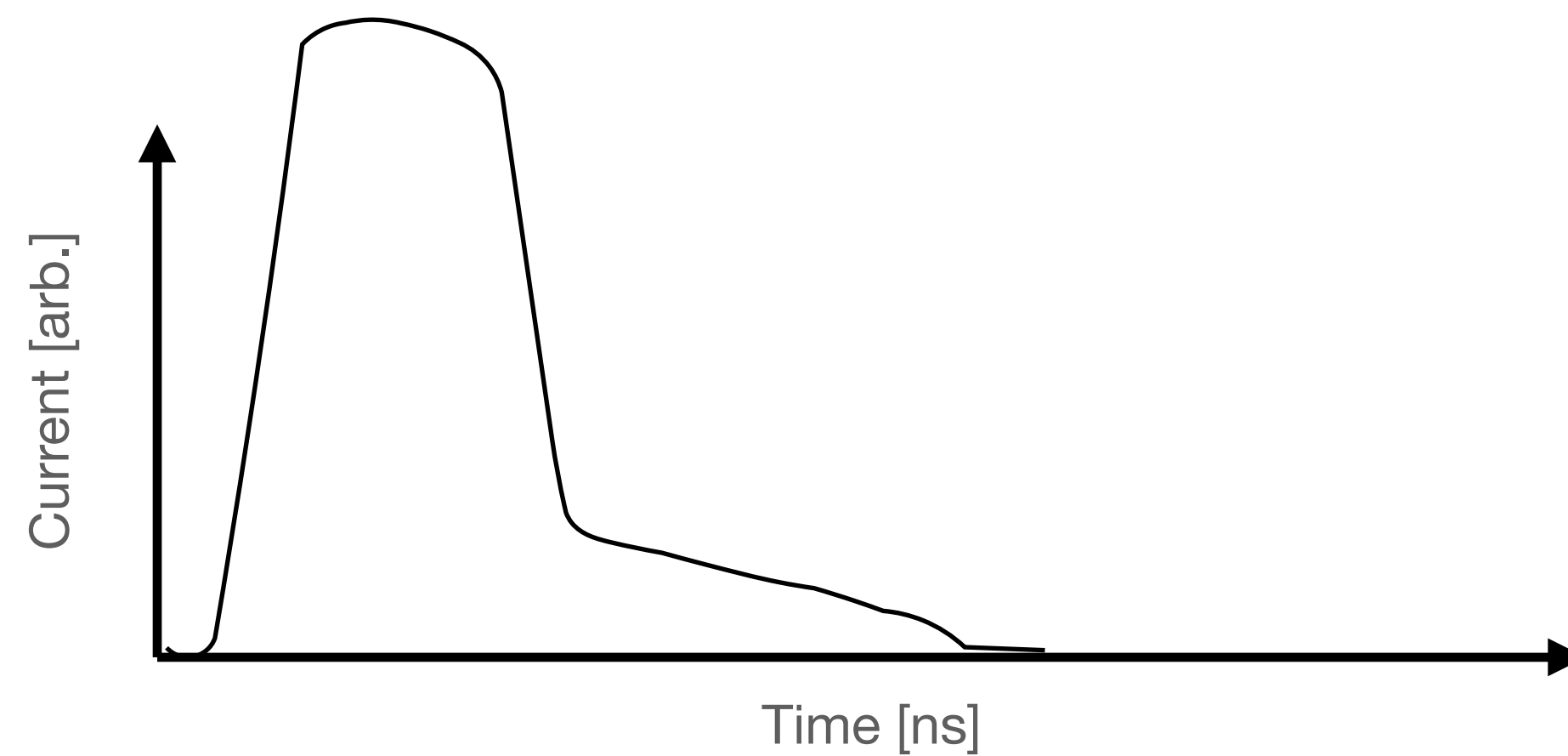

Pulse analysis

The main use of TCT is to map the electric field profile inside the sensor

- Analysing the full pulse can be complex given the varying electric field, weighting field and combination of charge carrier movement
- In principle we can simply take the **initial current** at the injection position to give us the field **at that point in space**

To account for finite response time of amplifiers, etc. the current is usually taken at a fixed point after the start, and this is plotted versus the stepped laser position/depth

- Note that in many cases the gain of the amplifiers etc. are not quantified, and this is left as “arb. units”

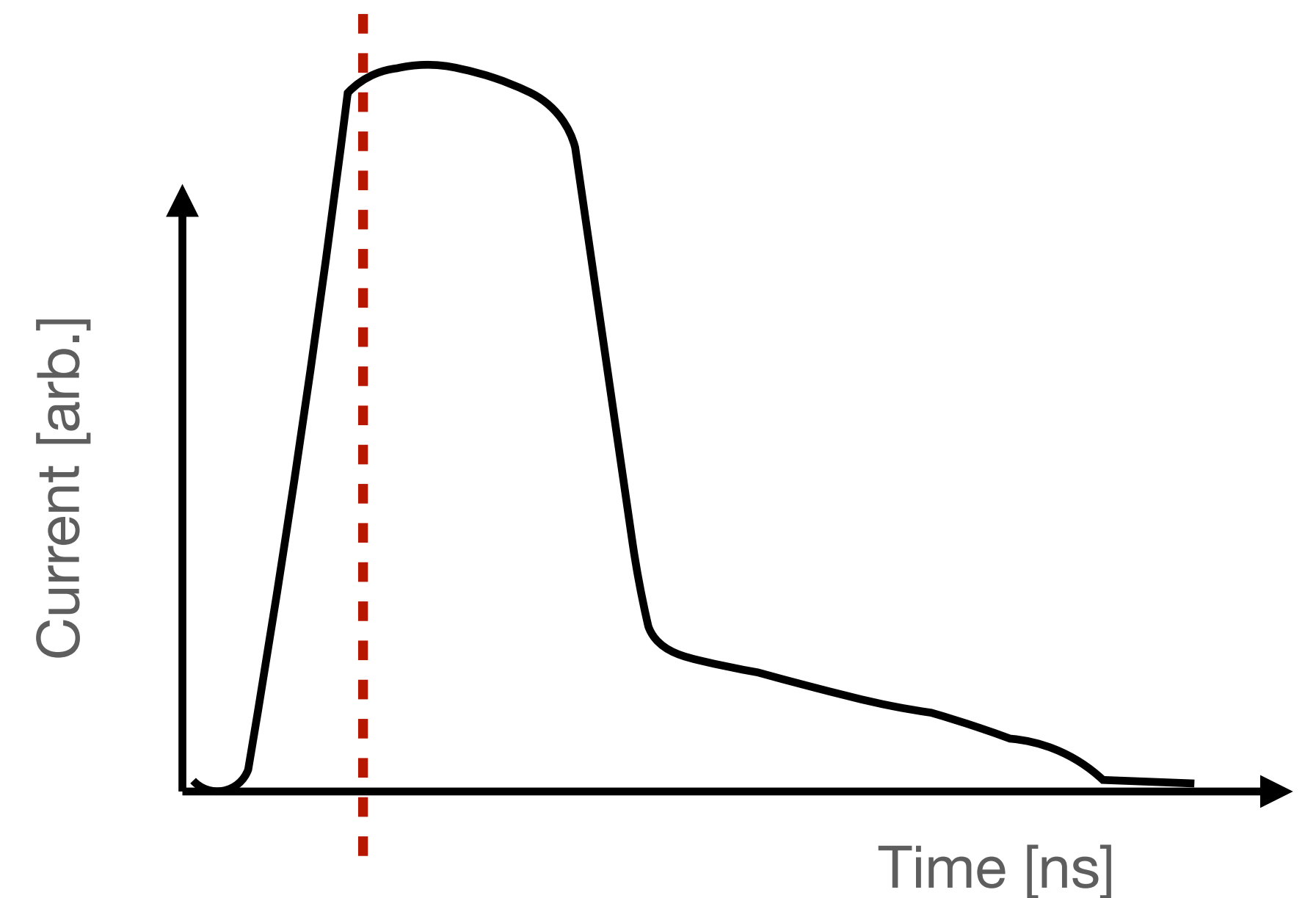

TCT - charge generation

TCT is most commonly used with light sources, to better control the amount of deposited charge. Several options are possible:

- **Red laser** - absorption within a few microns, typically used for 2D scans from the front/back side of a sensor
- **Infrared laser** - exponential distribution of charge carriers along the path of the beam, typically used side-on to do depth measurements

Note that laser light will not penetrate metal contacts, and that these can lead to reflections and more complicated analysis

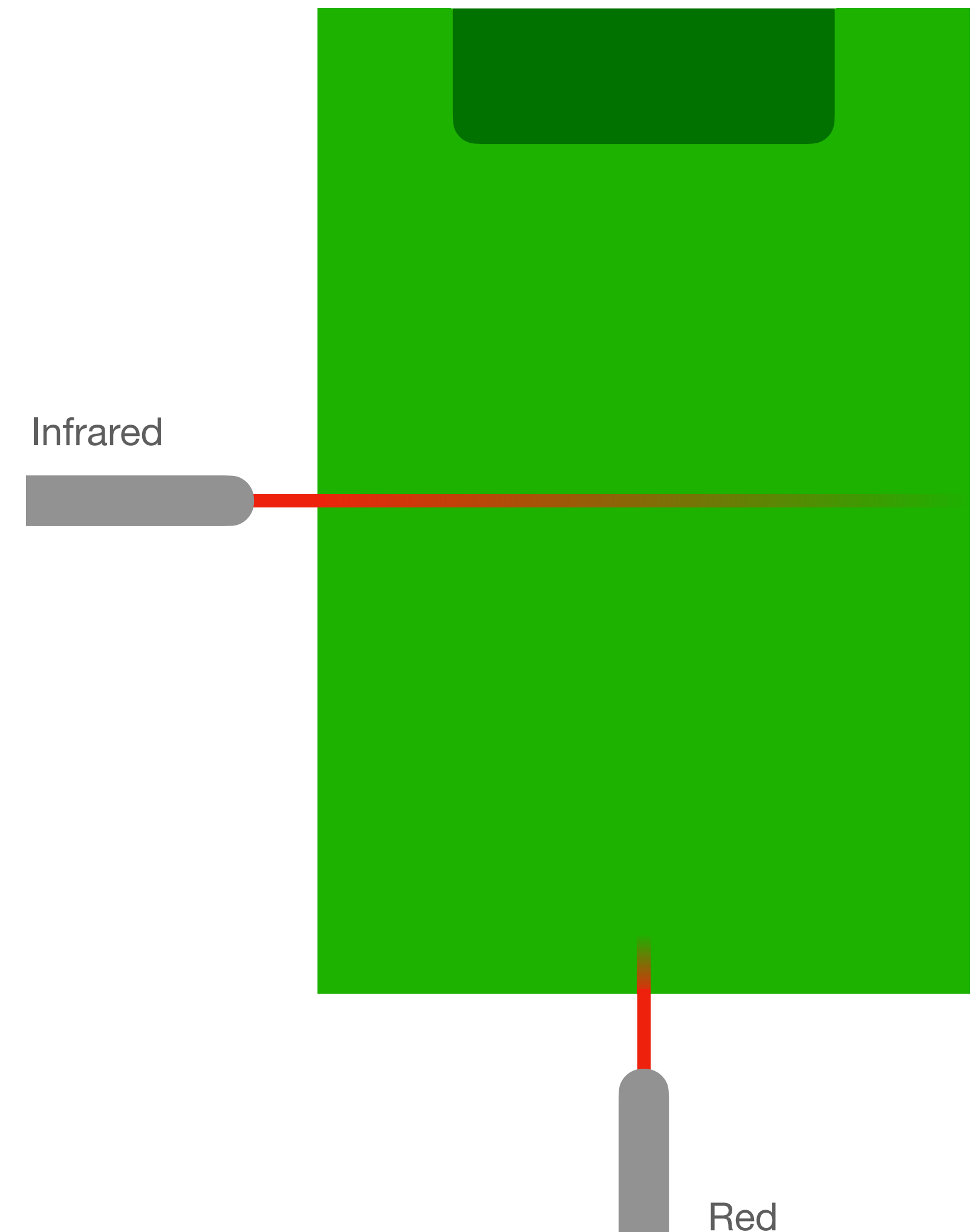

TCT - real data

Will illustrate this with some measurements described in G. Kramberger et al, 2014 JINST 9 P10016

- <https://iopscience.iop.org/article/10.1088/1748-0221/9/10/P10016>

Edge TCT with IR laser on 300 μm thick silicon strip sensors, with 180 V depletion voltage

- 1 cm long strips, with 100 μm pitch and 20 μm implant width

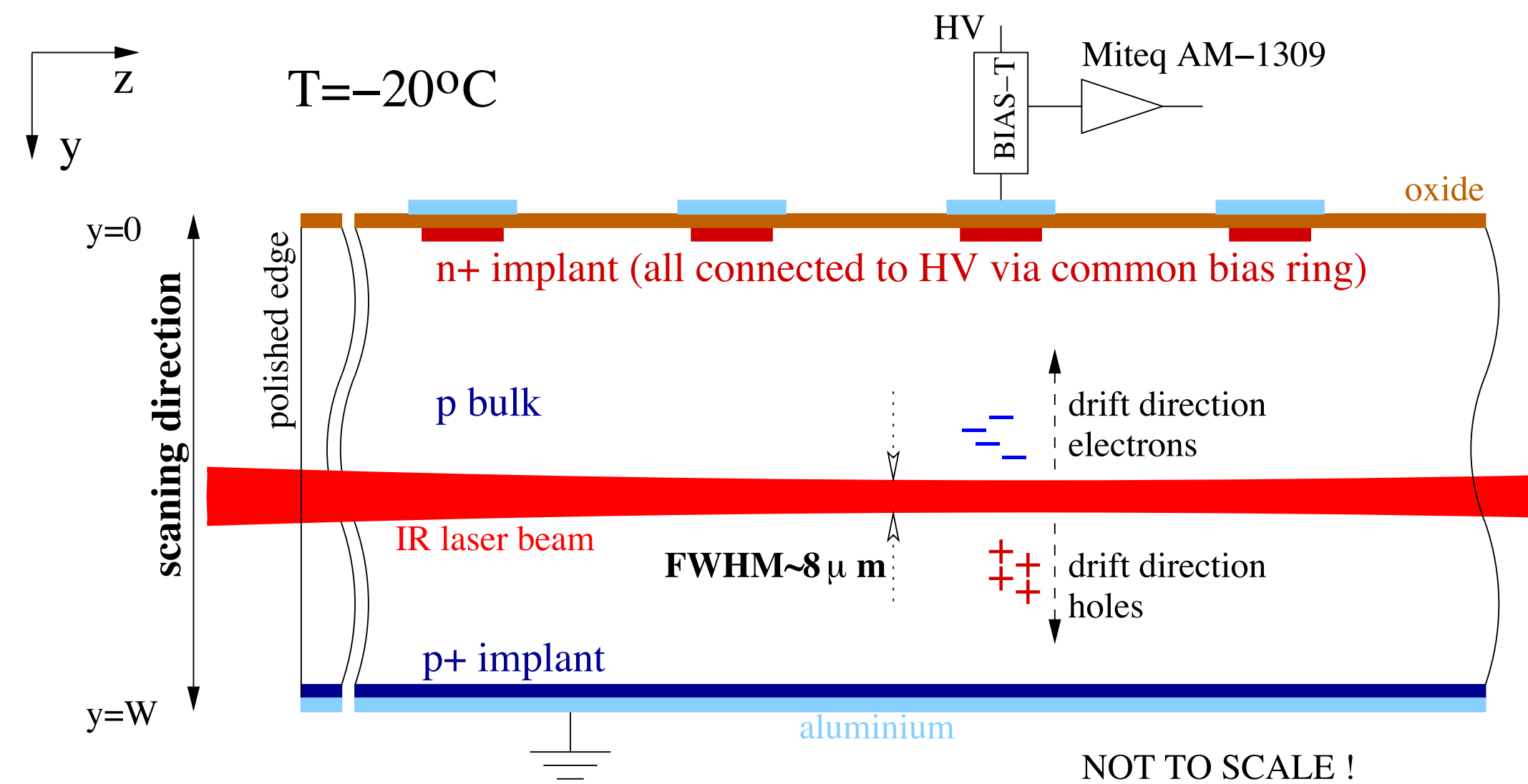

Real data - individual pulses

Individual current pulses shown for several bias voltages

- Clearly see the different contributions from electrons (until ~ 2 ns) and holes (continues afterwards)
- The hole current drops sharply to 0 within a few nanoseconds **once the sensor is over-depleted**, showing full collection
- The total width of the pulse narrows as the field increases

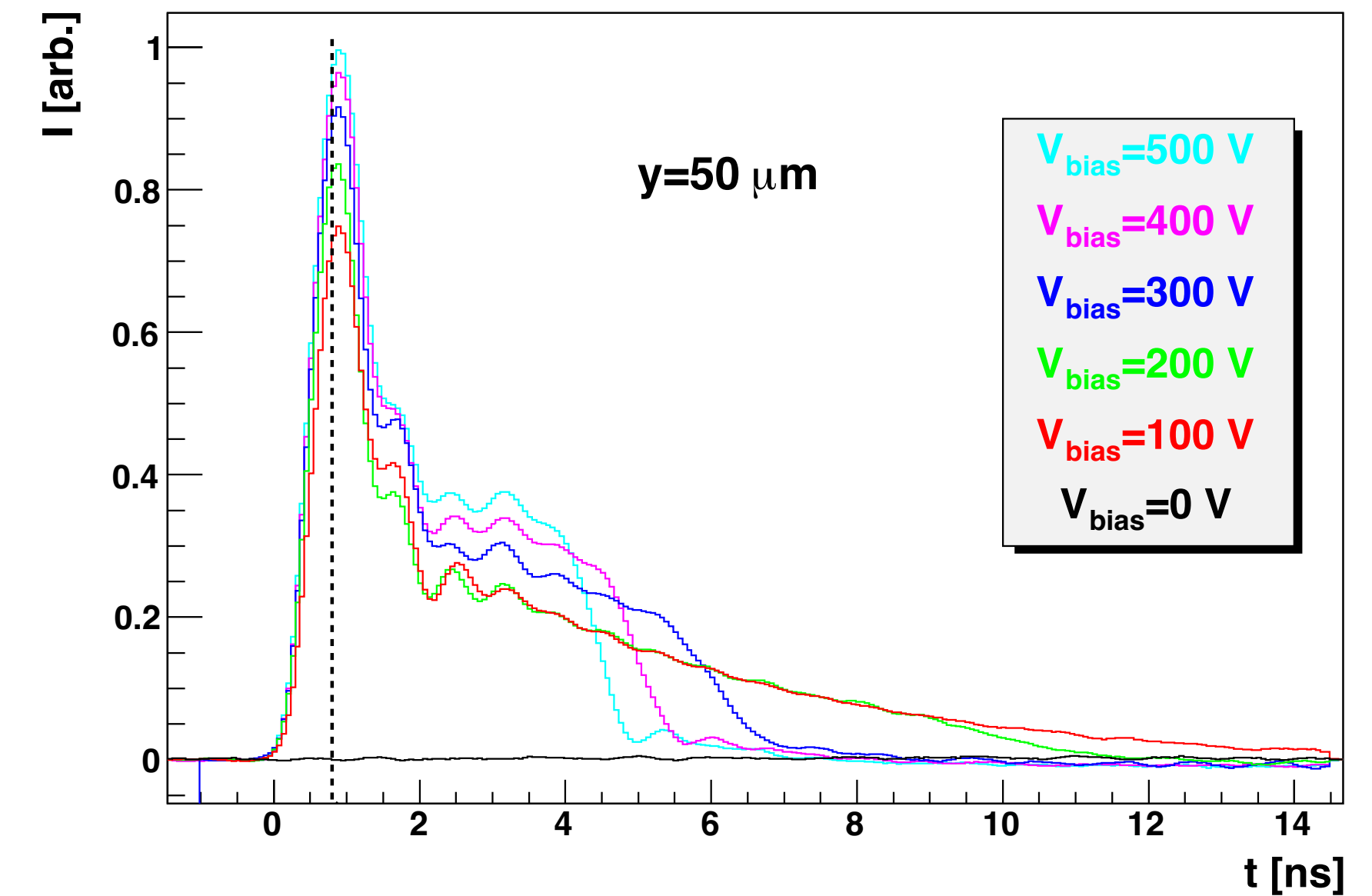
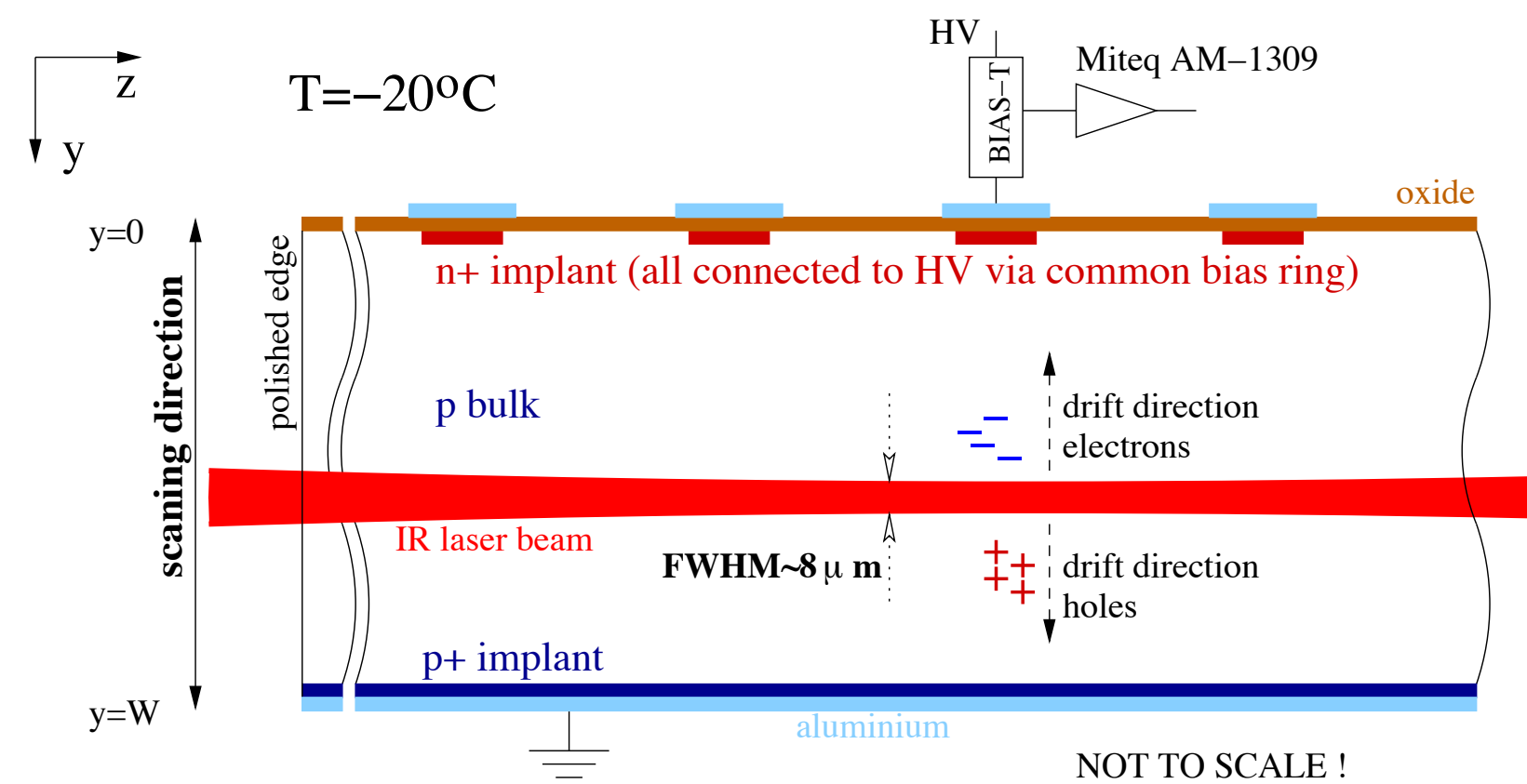

Real data - velocity/electric field profiles

The dashed line is used as the point from which to calculate the velocity profiles/electric field

- No normalisation performed, no calibration of the gain, no calculation of the absolute field strength
- This number (proportional to E) plotted versus the laser position
- Evolution of the depletion clearly visible

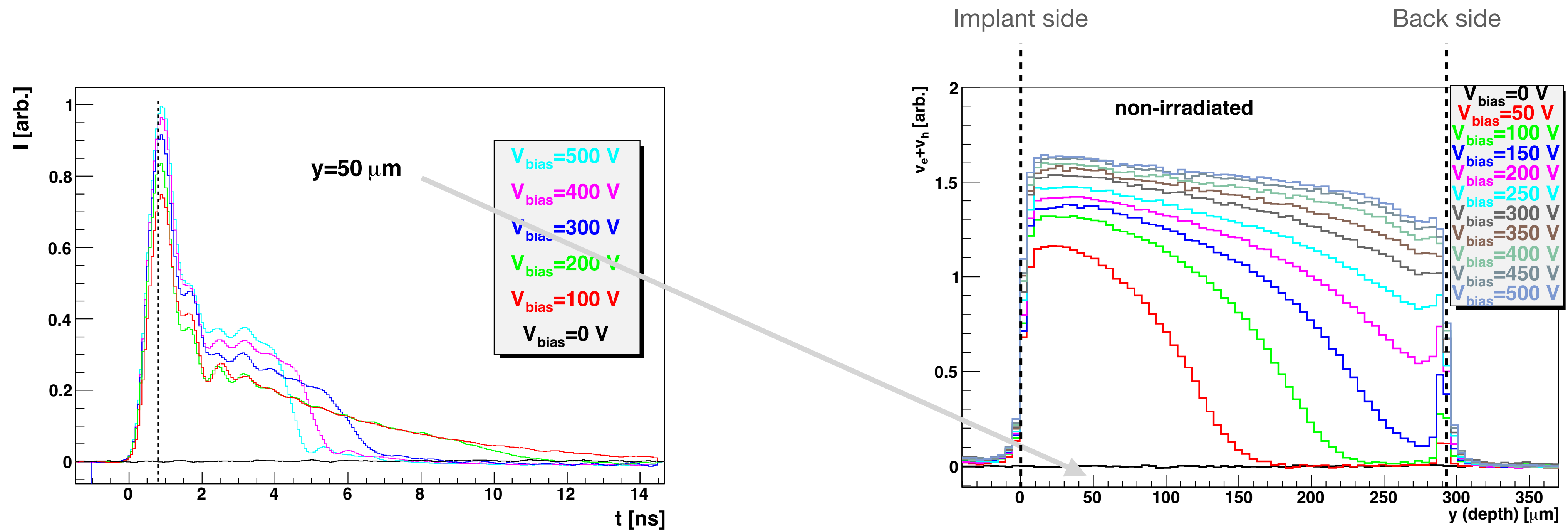

Real data - irradiated sampling time

Moving from unirradiated to irradiated samples brings new complications

- The sampling time used is now of the same order of magnitude as the effective carrier lifetime due to trapping

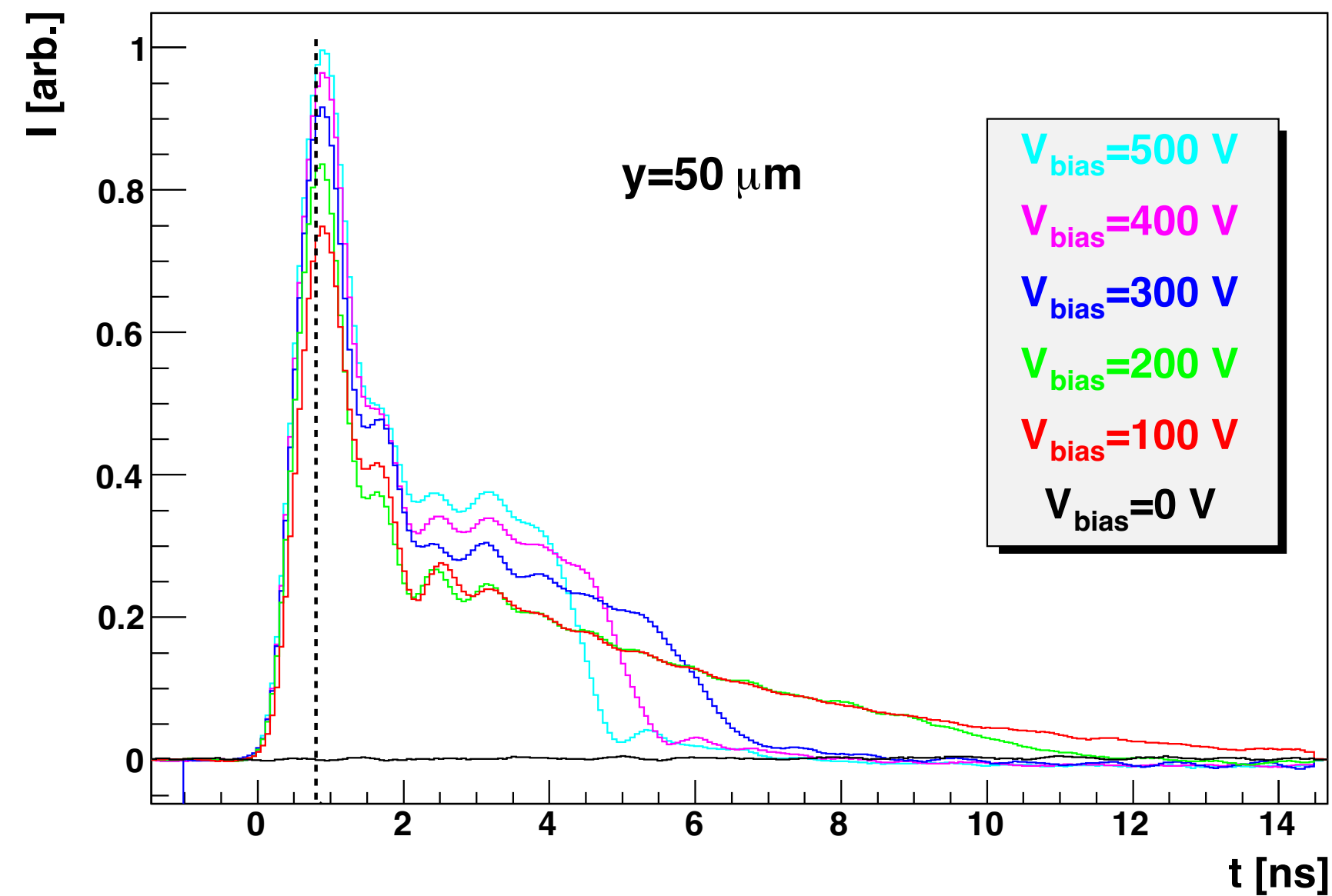

Real data - irradiated sampling time

Moving from unirradiated to irradiated samples brings new complications

- The sampling time used is now of the same order of magnitude as the effective carrier lifetime due to trapping
- Repeat the same electric field profile extraction for different sampling times and compare... (spoiler, they stick to 600 ps)

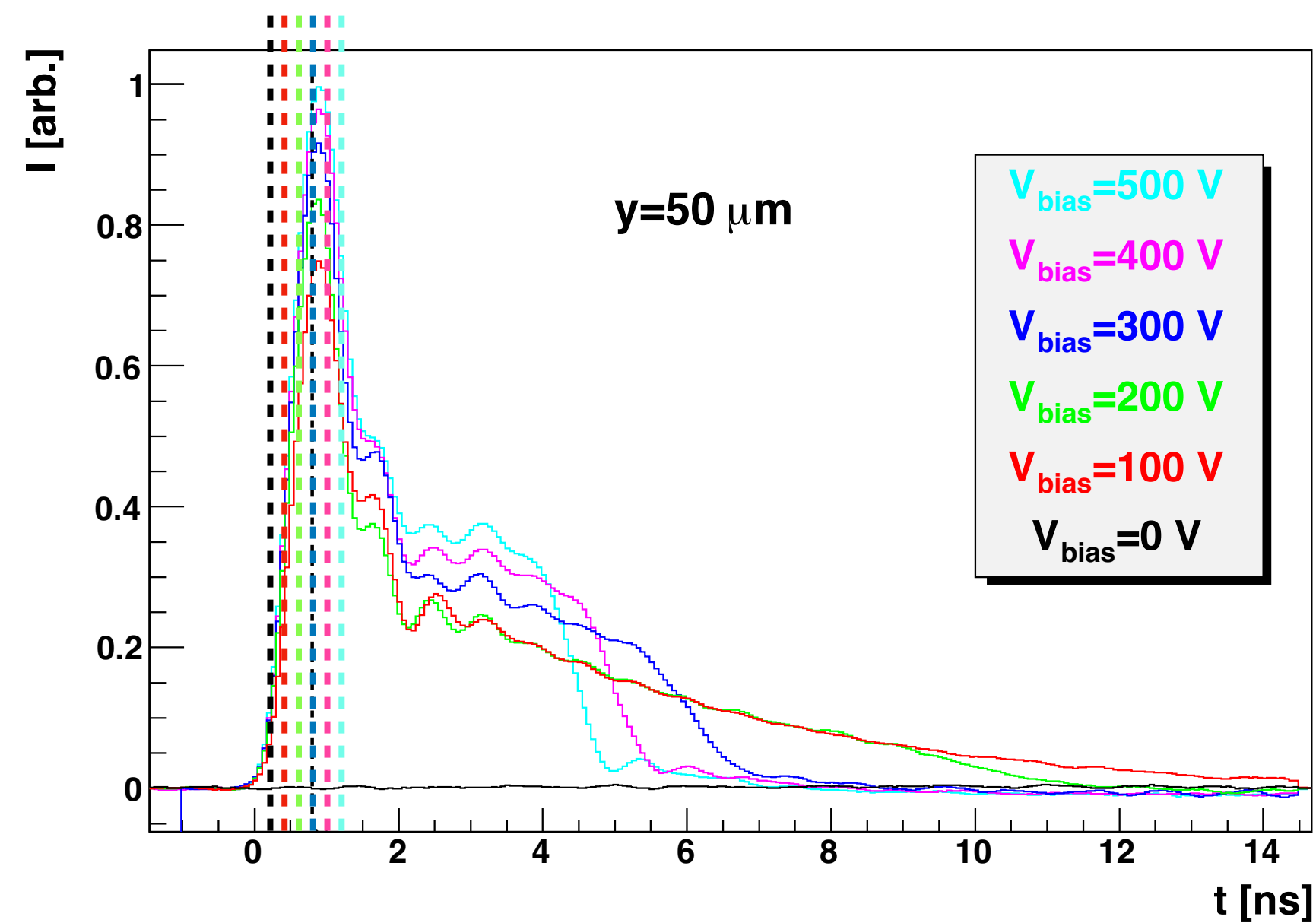

Real data - irradiated sampling time

Moving from unirradiated to irradiated samples brings new complications

- The sampling time used is now of the same order of magnitude as the effective carrier lifetime due to trapping
- Repeat the same electric field profile extraction for different sampling times and compare... (spoiler, they stick to 600 ps)

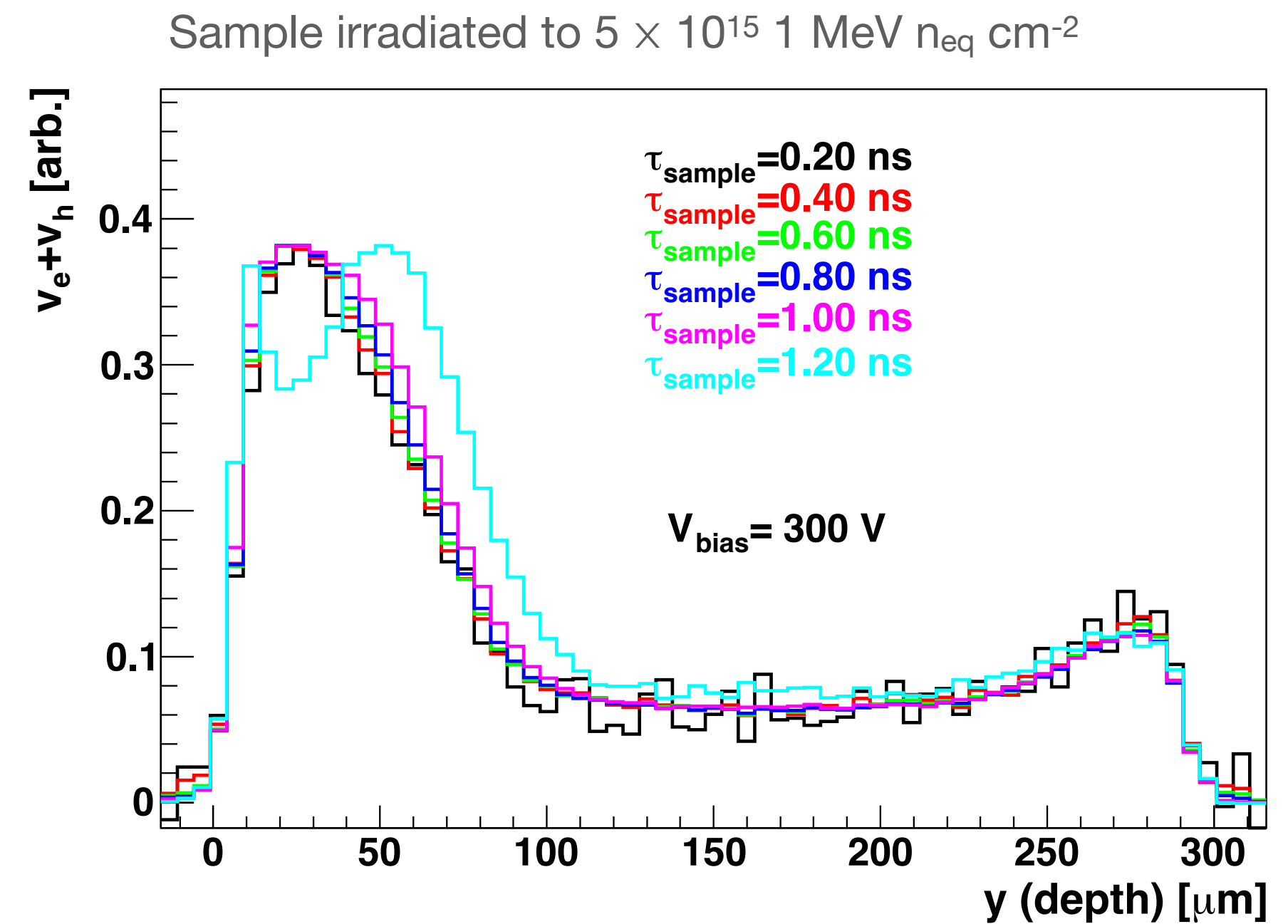
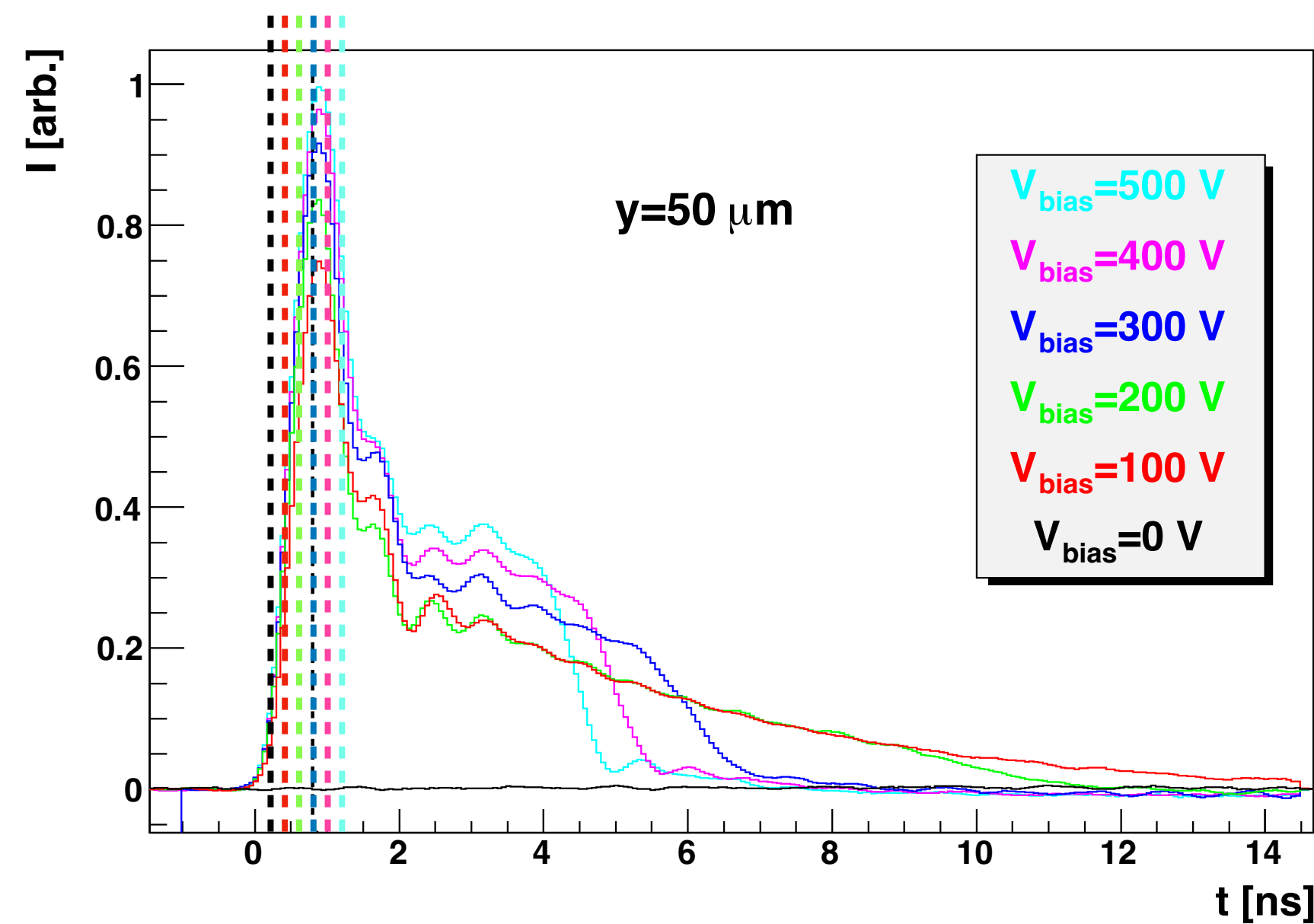

Real data - irradiated field profiles

The paper then goes on to look at the electric field profile in depth for progressively more irradiated samples. A couple of effects are visible

- The bulk becomes more p-type with increasing fluence, and is therefore harder to deplete
- The total amount of collected charge is lower due to trapping

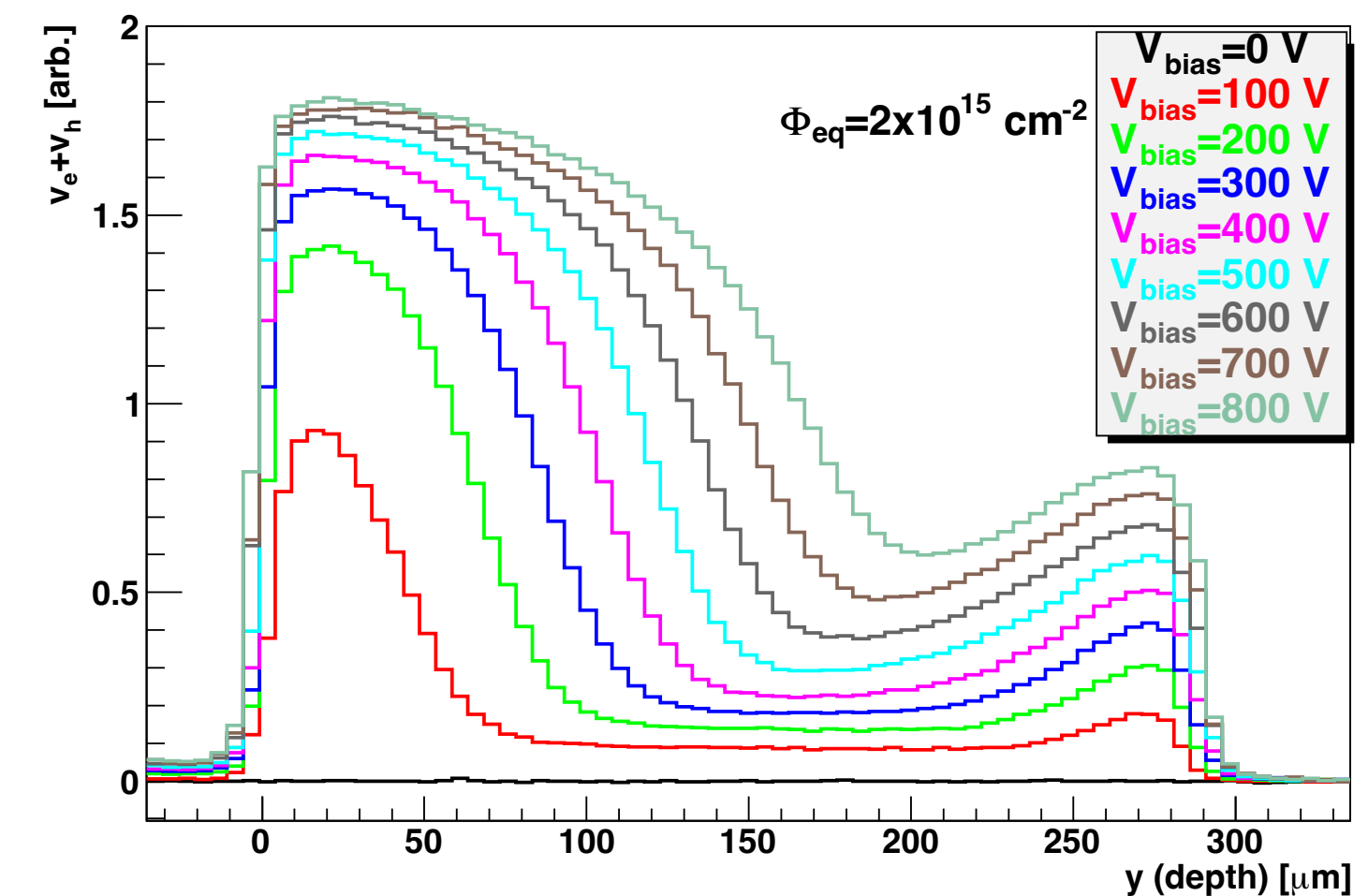
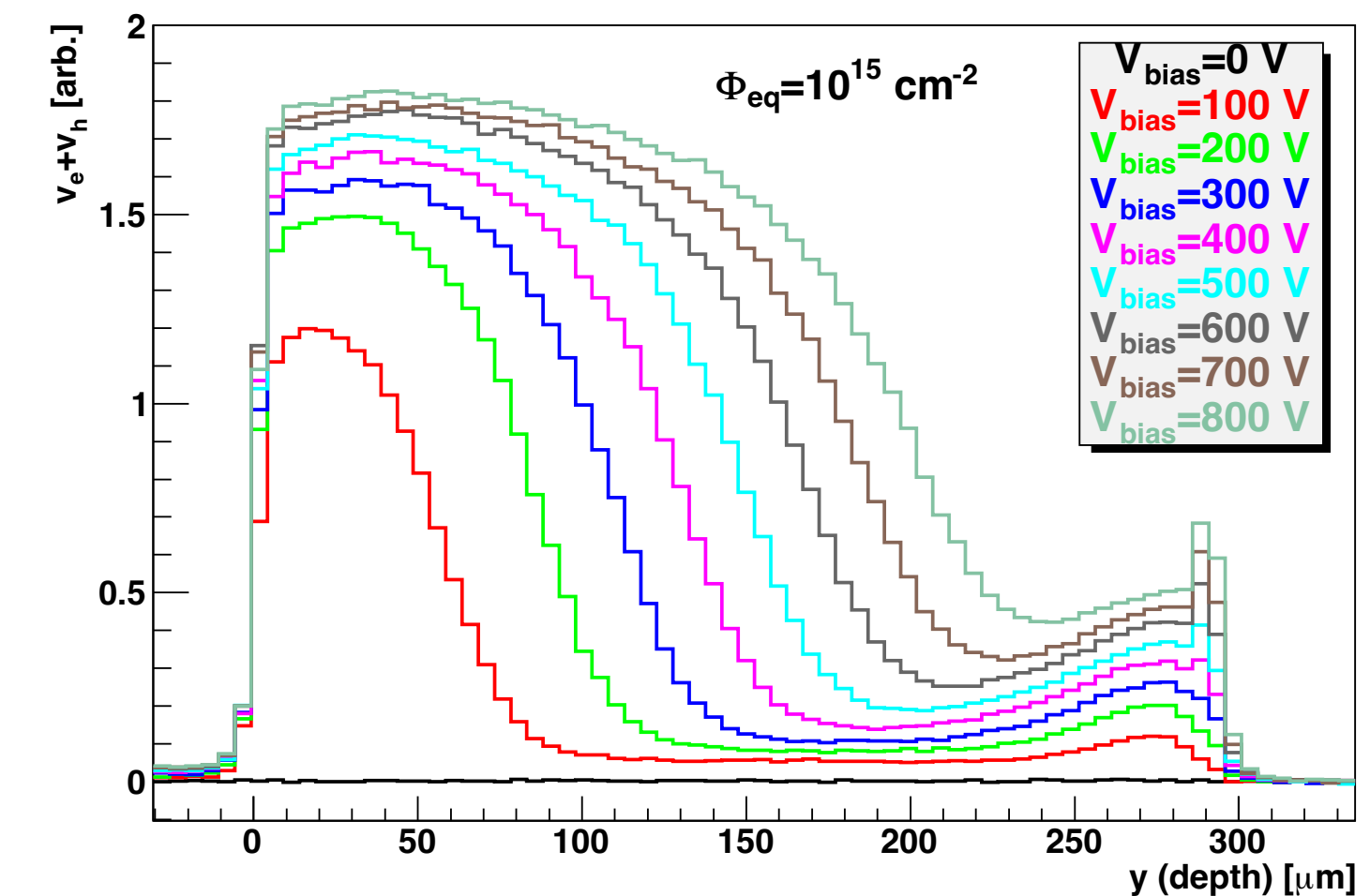

Real data - irradiated field profiles

The paper then goes on to look at the electric field profile in depth for progressively more irradiated samples. A couple of effects are visible

- The bulk becomes more p-type with increasing fluence, and is therefore harder to deplete
- The total amount of collected charge is lower due to trapping
- At even higher fluences, a double-junction electric field profile can be seen, due to space charge accumulating in radiation-induced defect sites
- The paper also references charge multiplication onset...

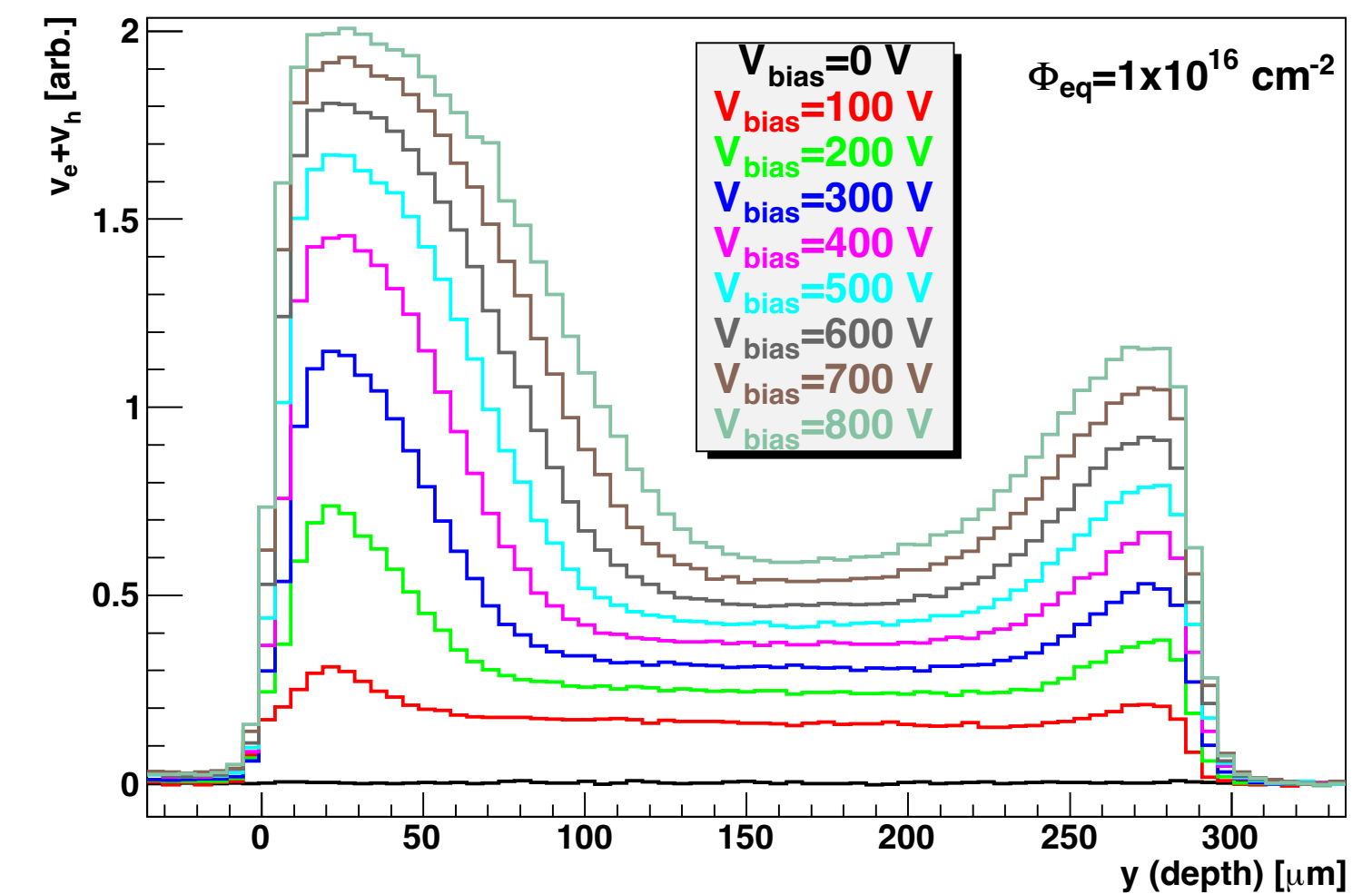
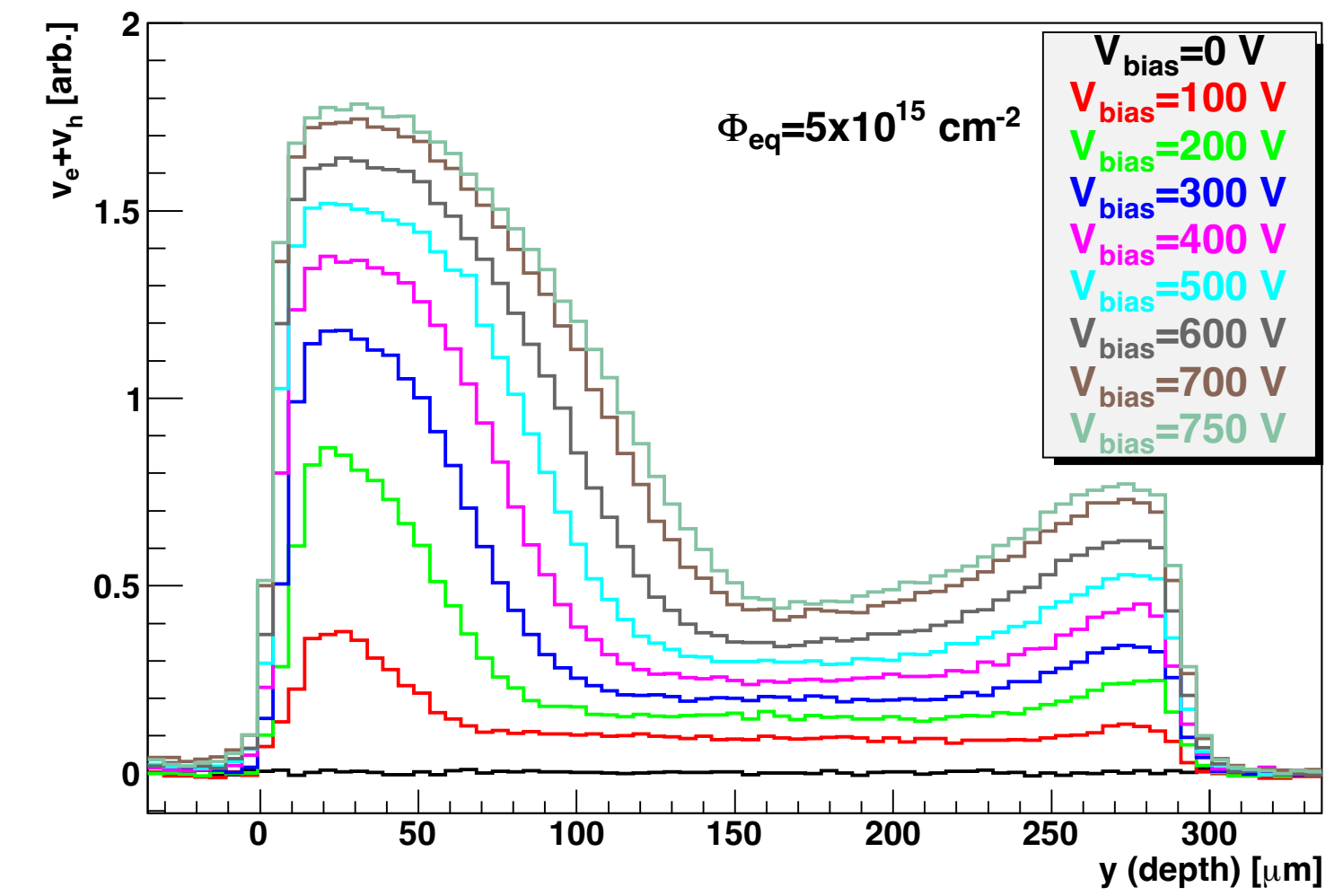

TCT - weighting field effects

The next few slides taken from DT training seminar

- M. Fernández & S. Otero Ugobono – The Transient Current Technique – 30th Nov 2017
- <https://indico.cern.ch/event/684193>

Weighting fields for segmented detectors are quite radically different from diodes (“parallel plates”)

- Important to understand or simulate in order to properly convert current measurements into field strength!

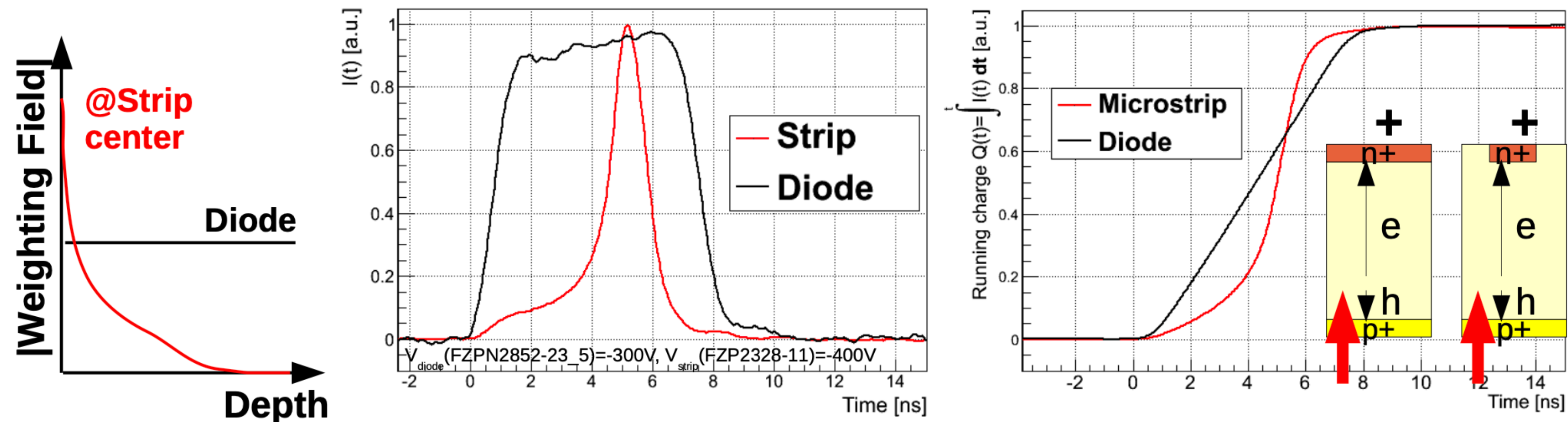

More interesting TCT - LGADs

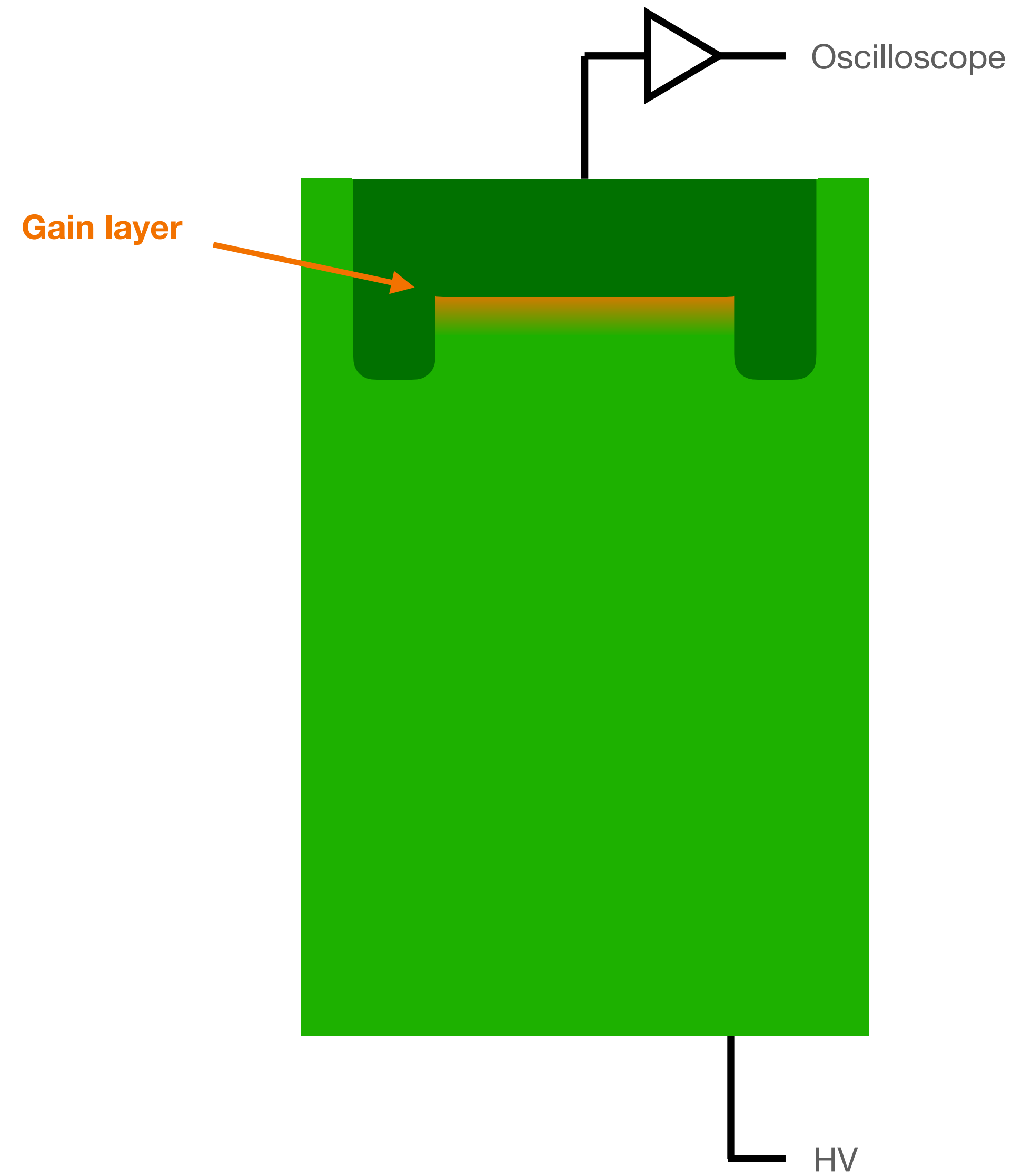
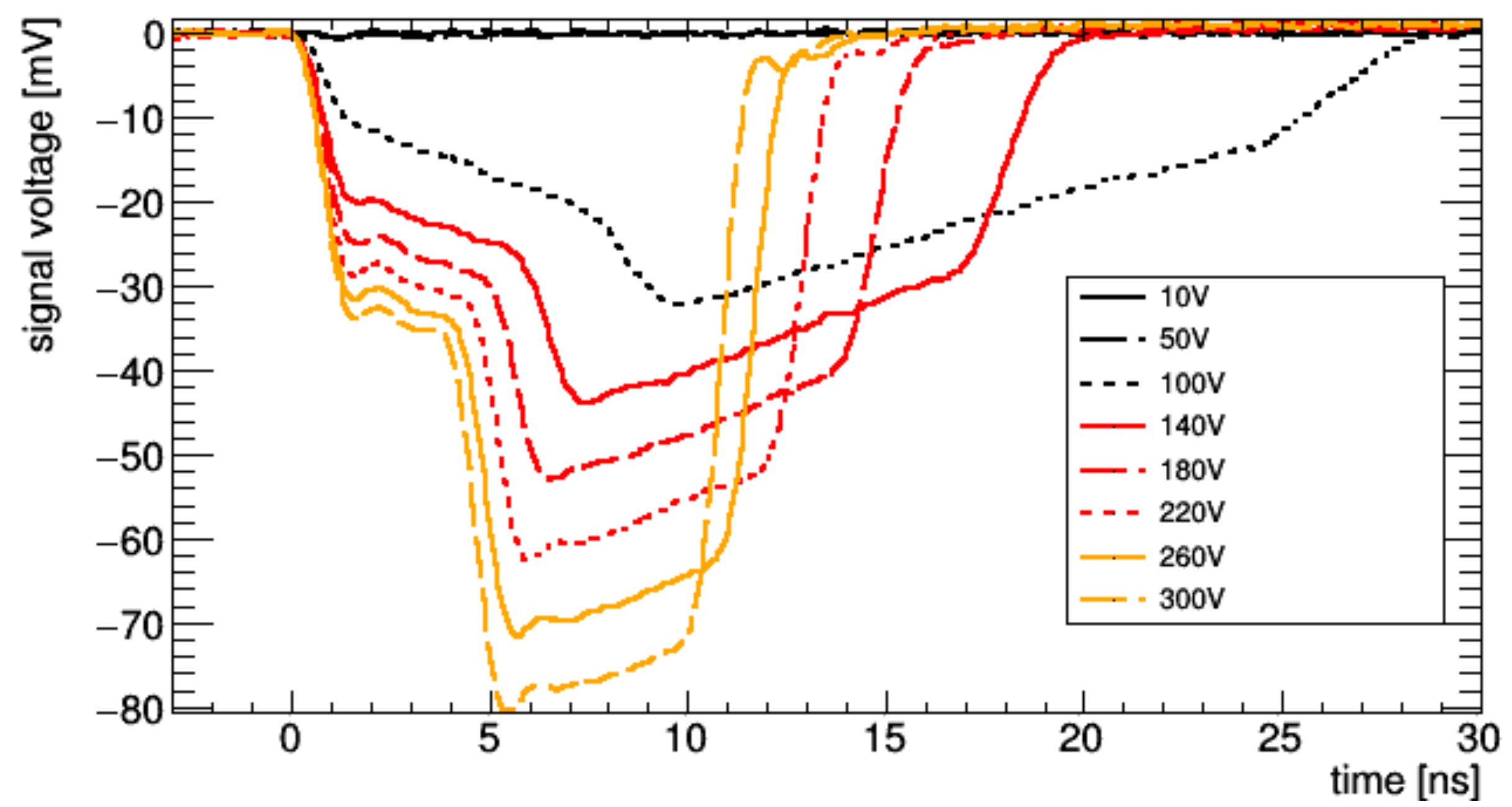

More interesting TCT - LGADs

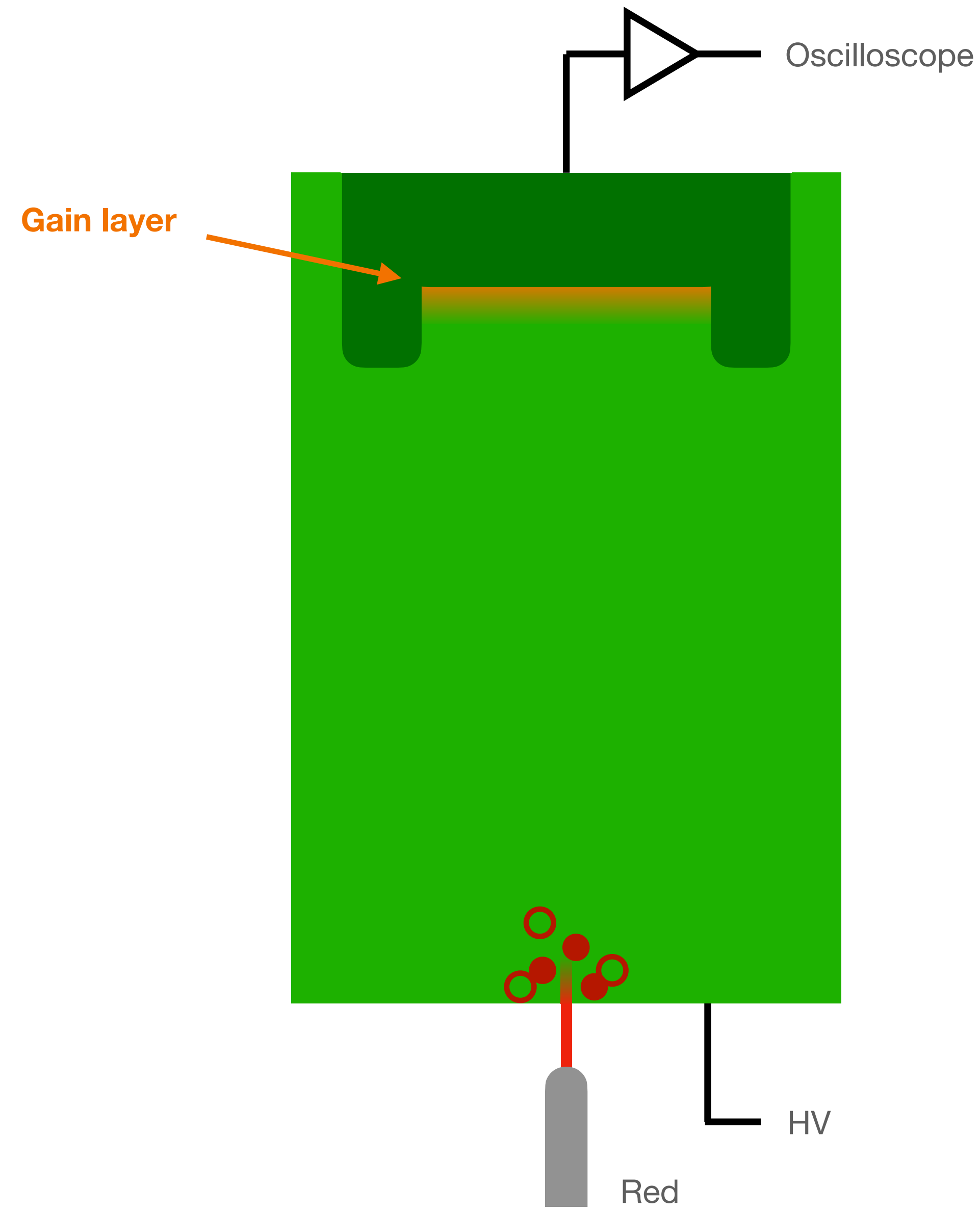
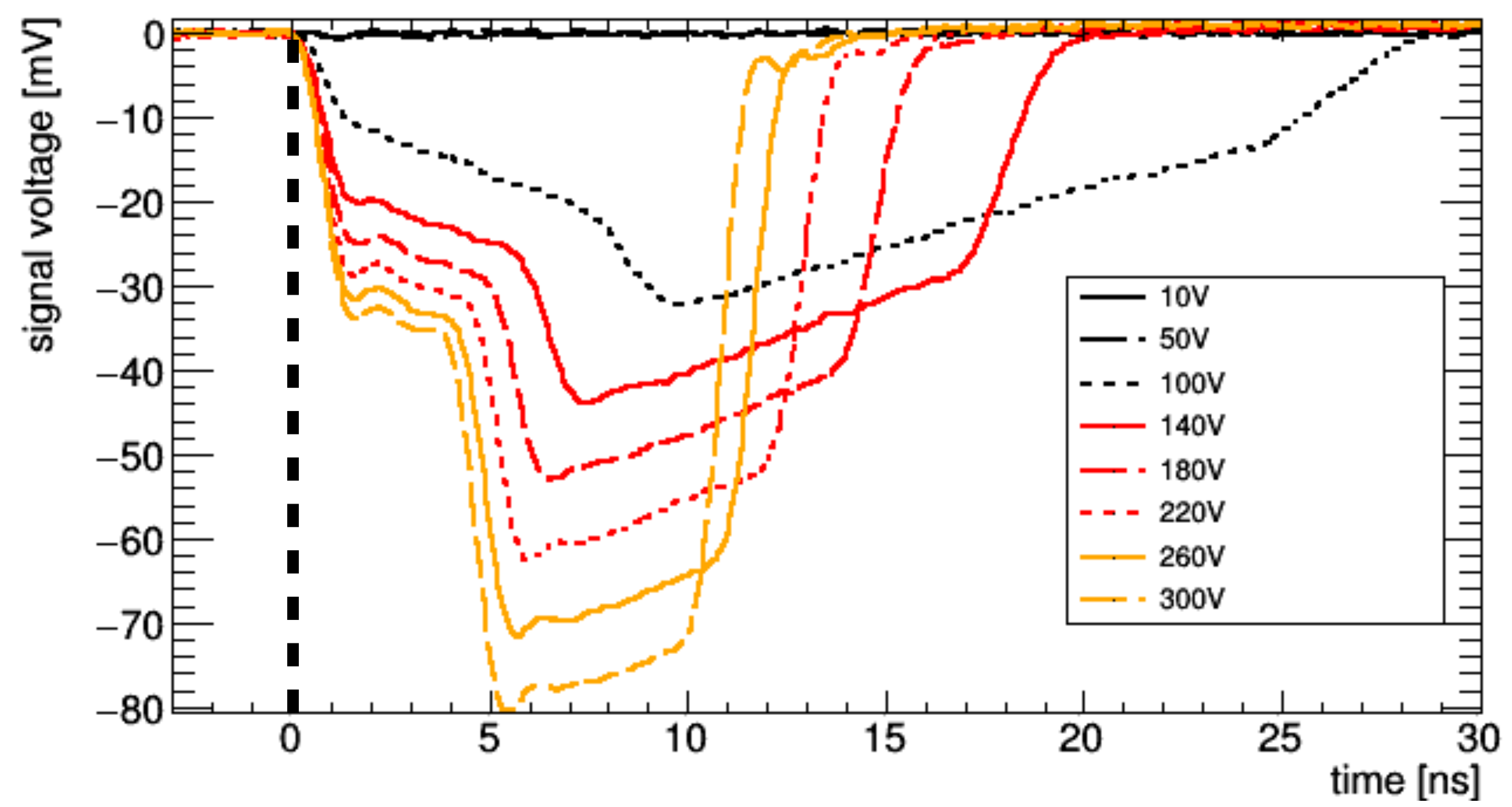

More interesting TCT - LGADs

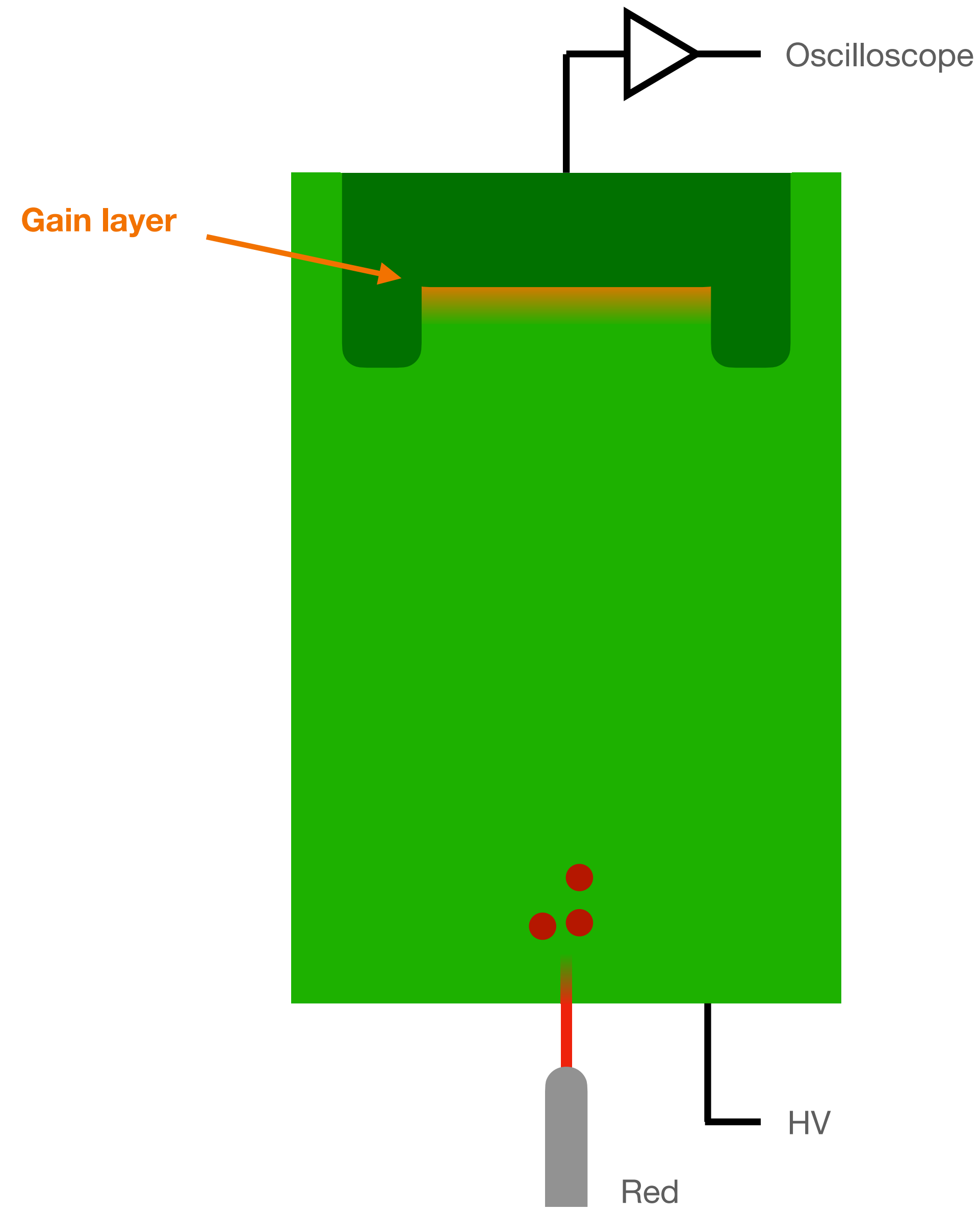
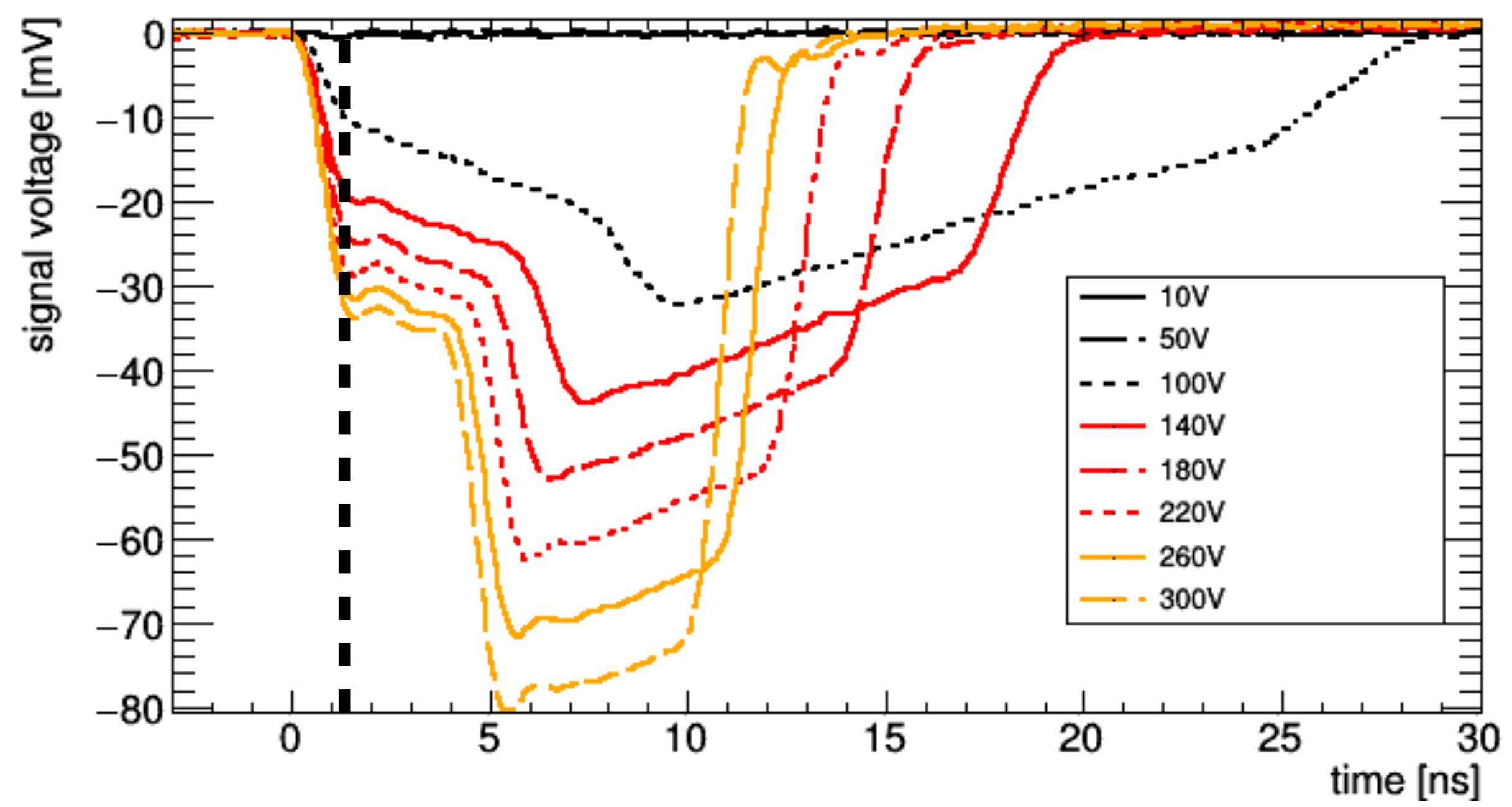

More interesting TCT - LGADs

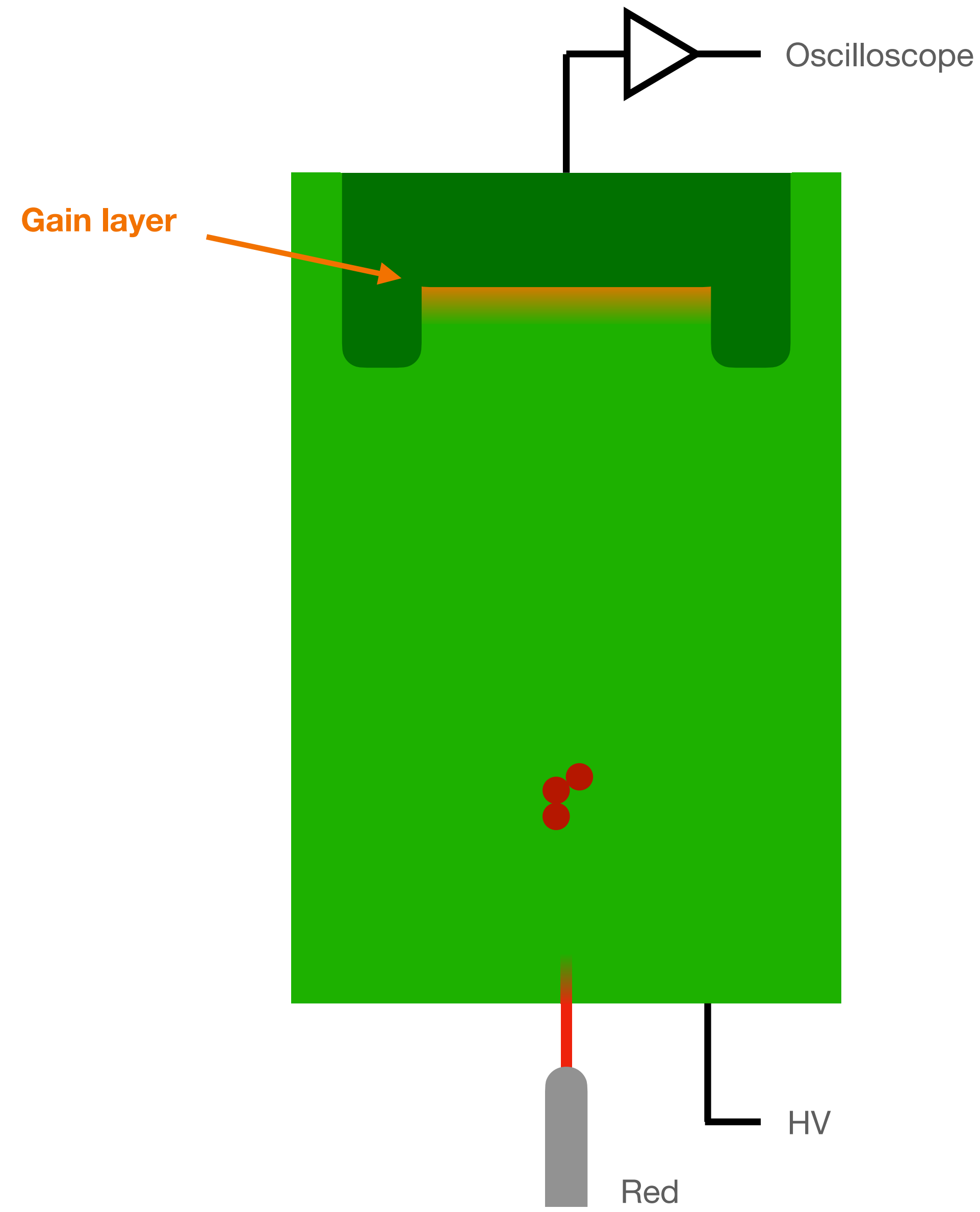
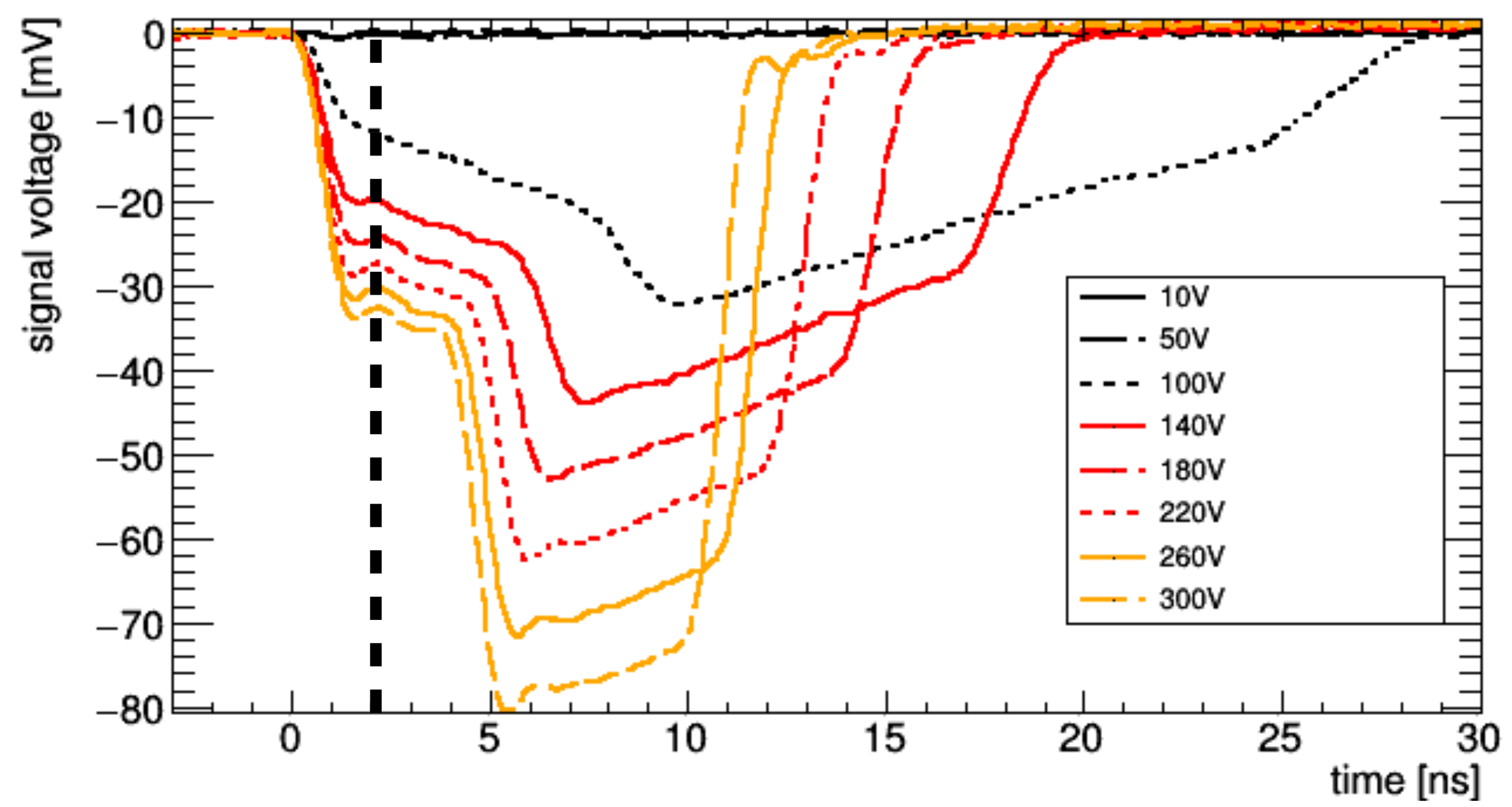

More interesting TCT - LGADs

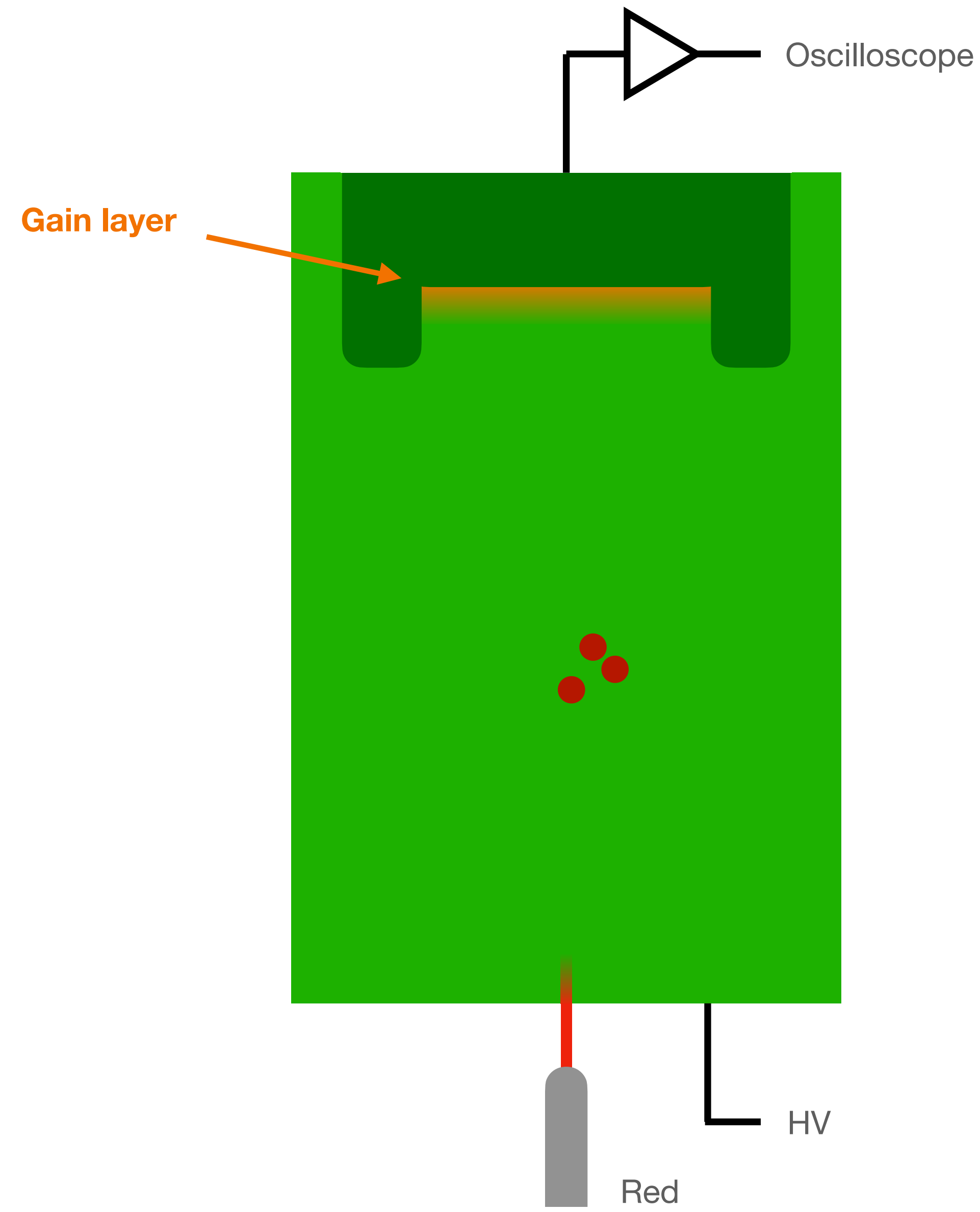
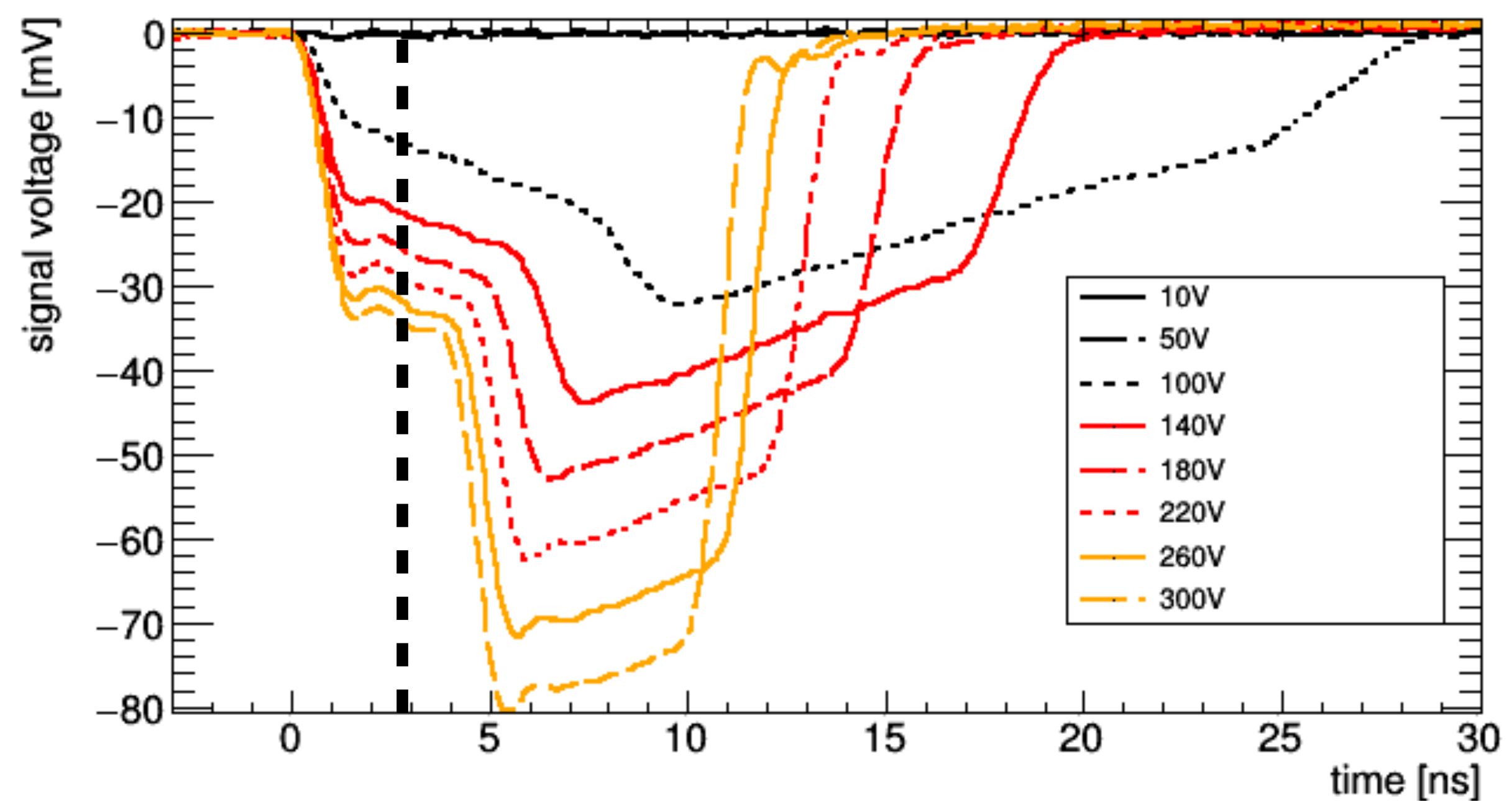

More interesting TCT - LGADs

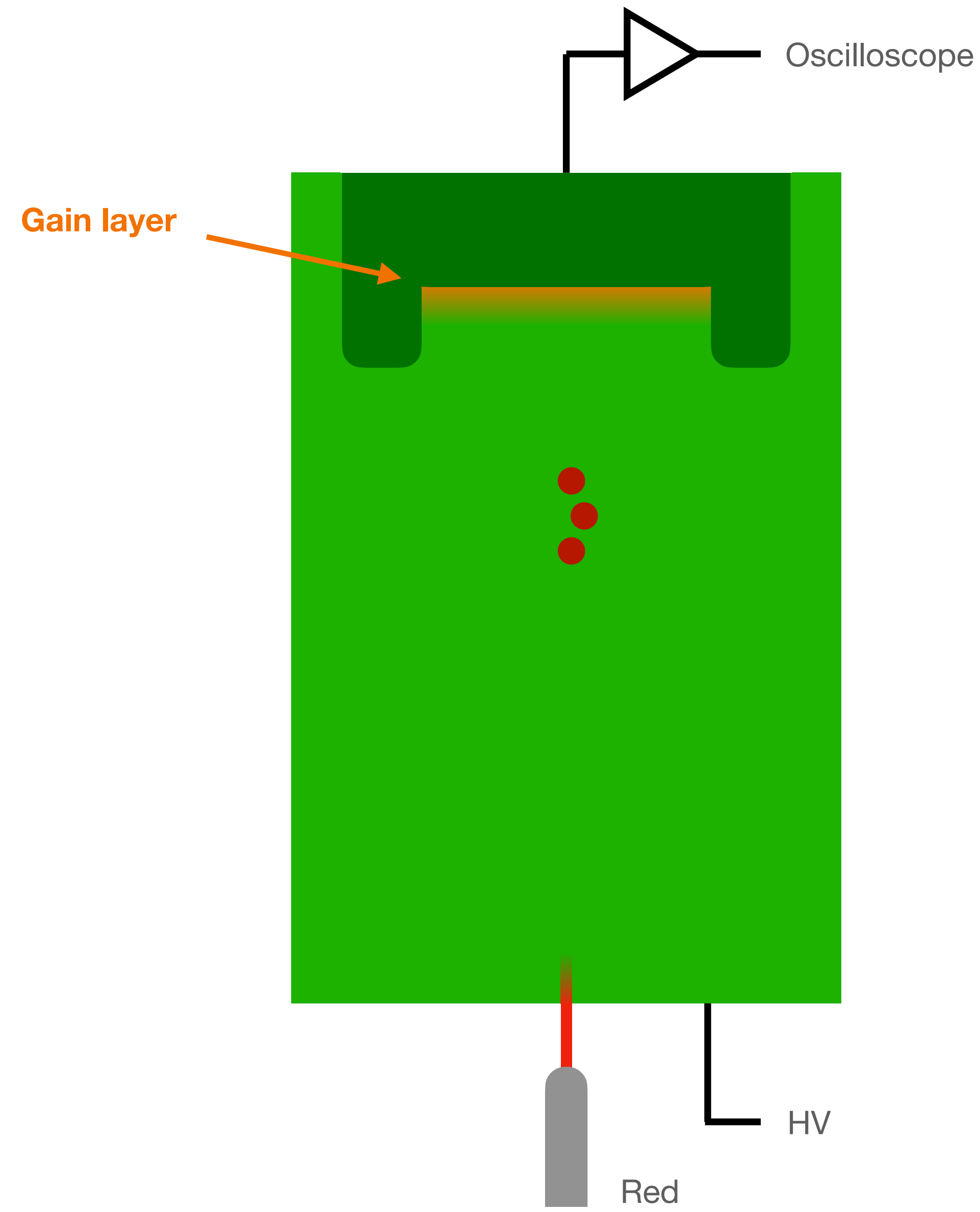
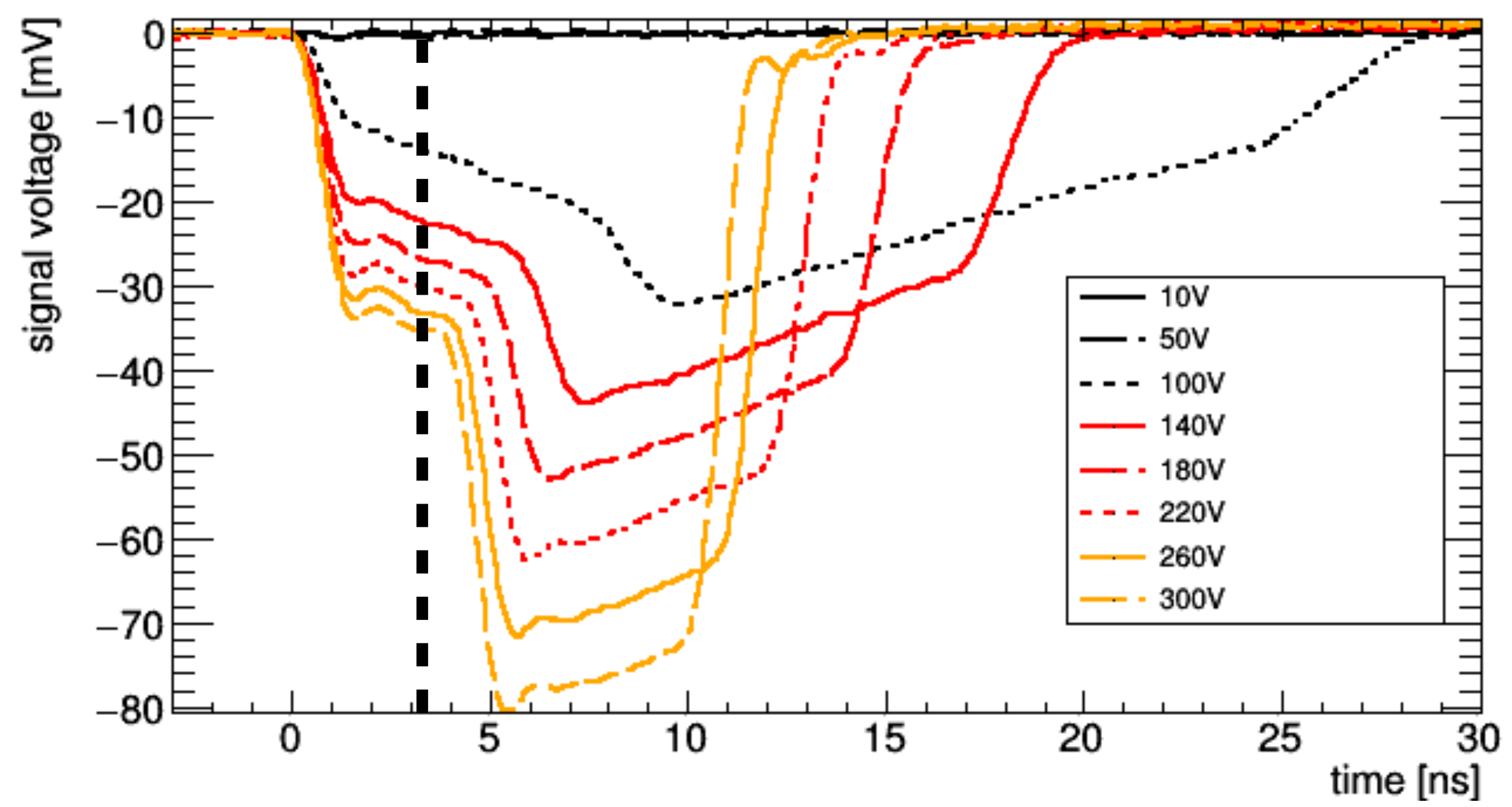

More interesting TCT - LGADs

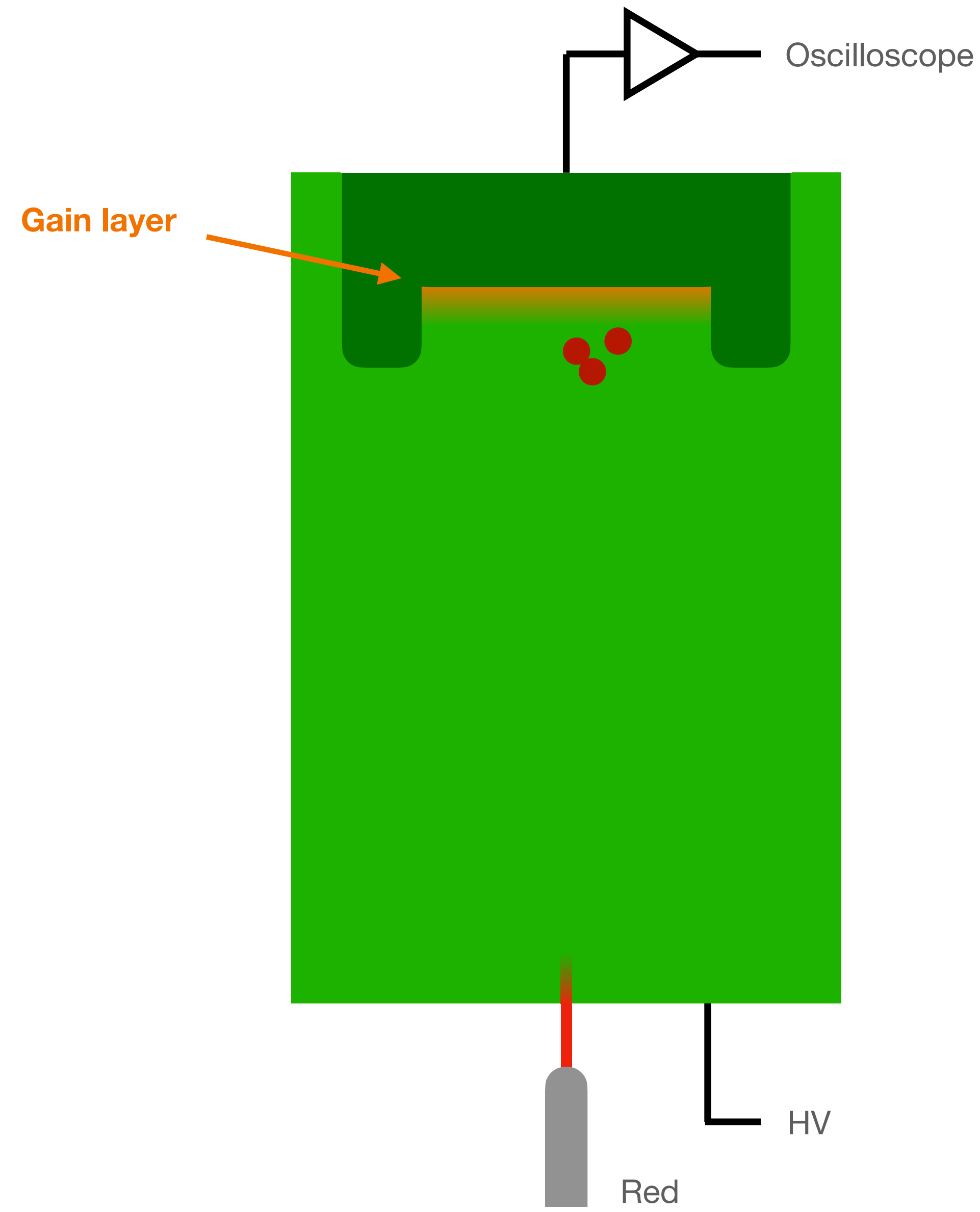
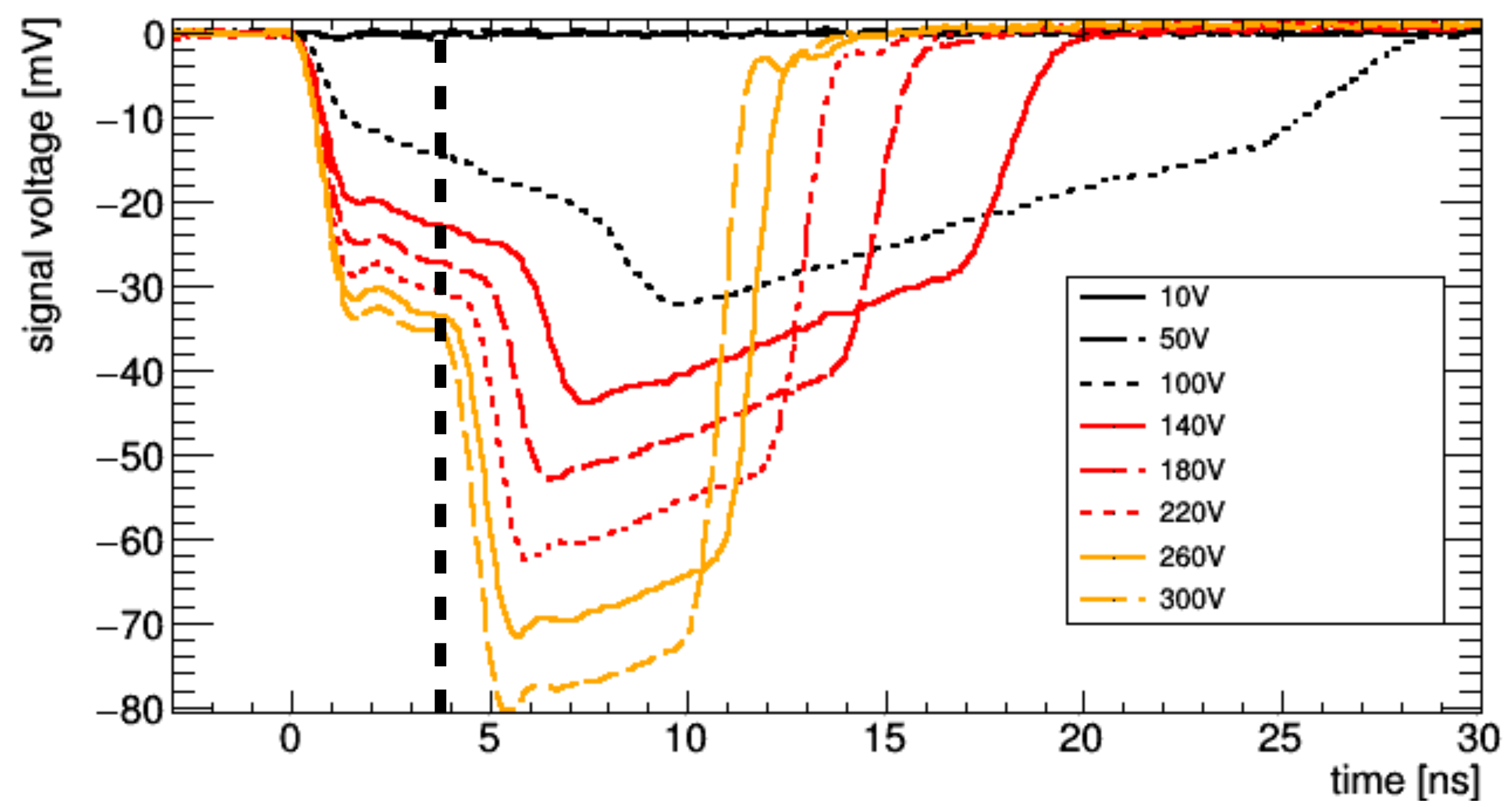

More interesting TCT - LGADs

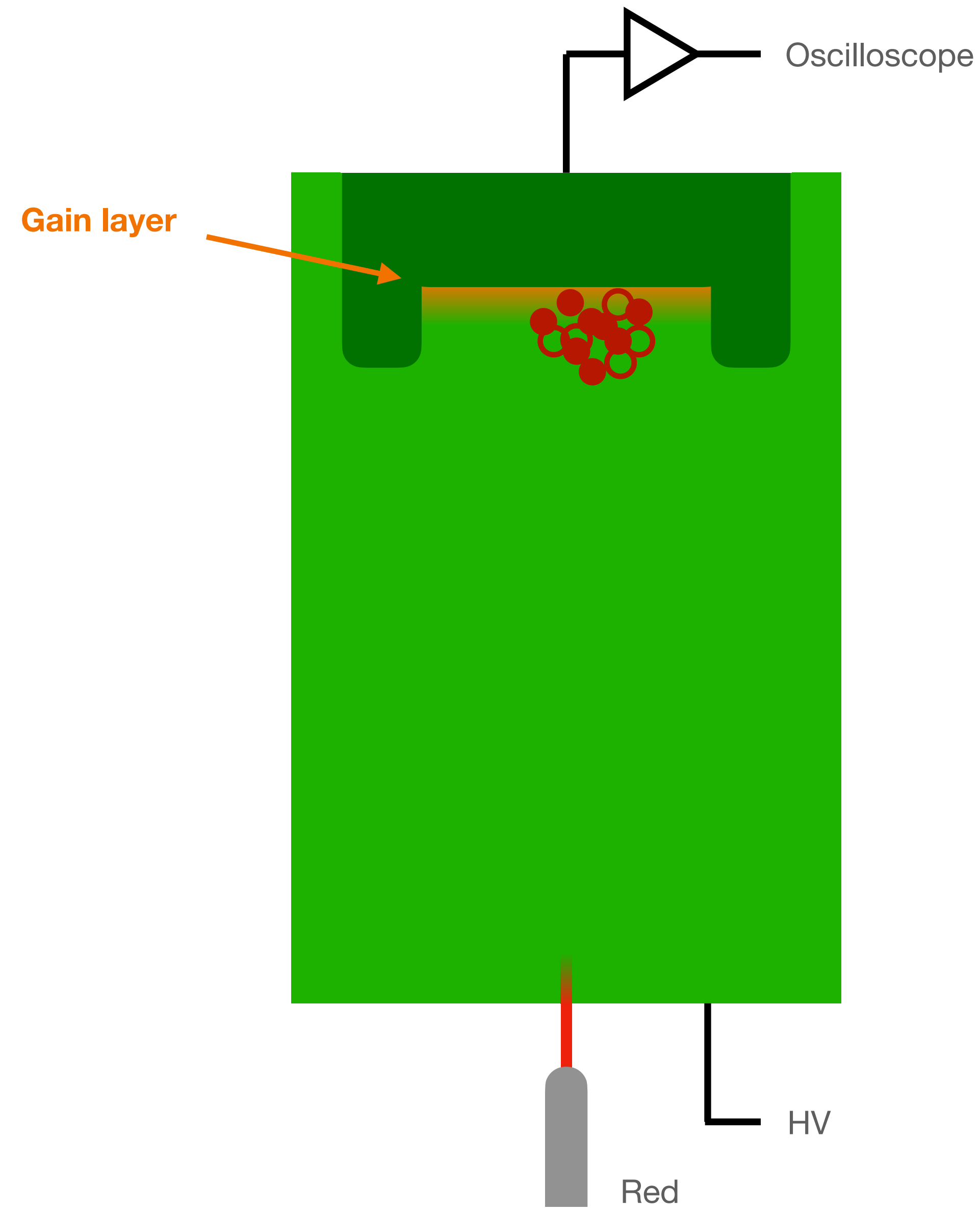
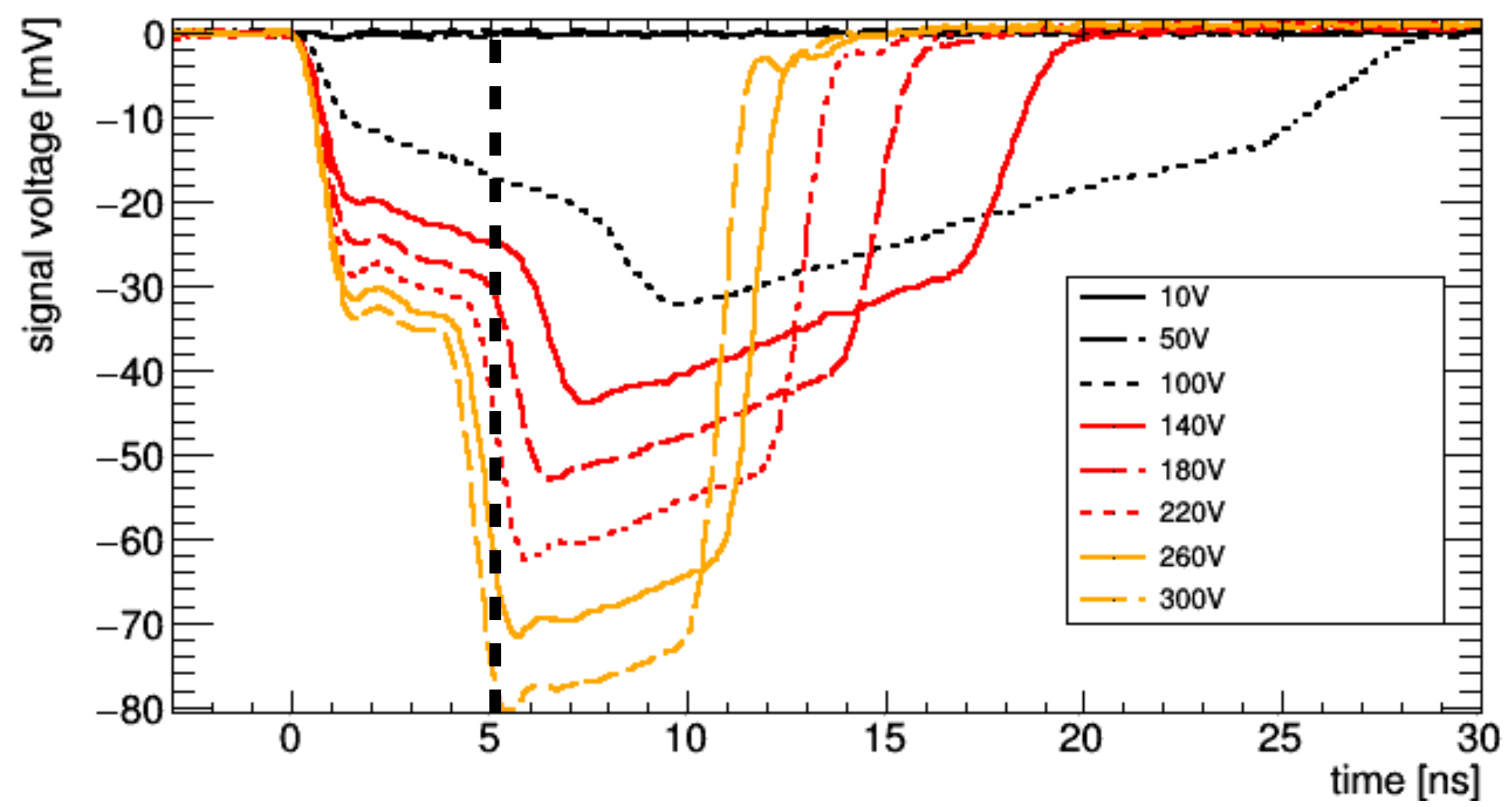

More interesting TCT - LGADs

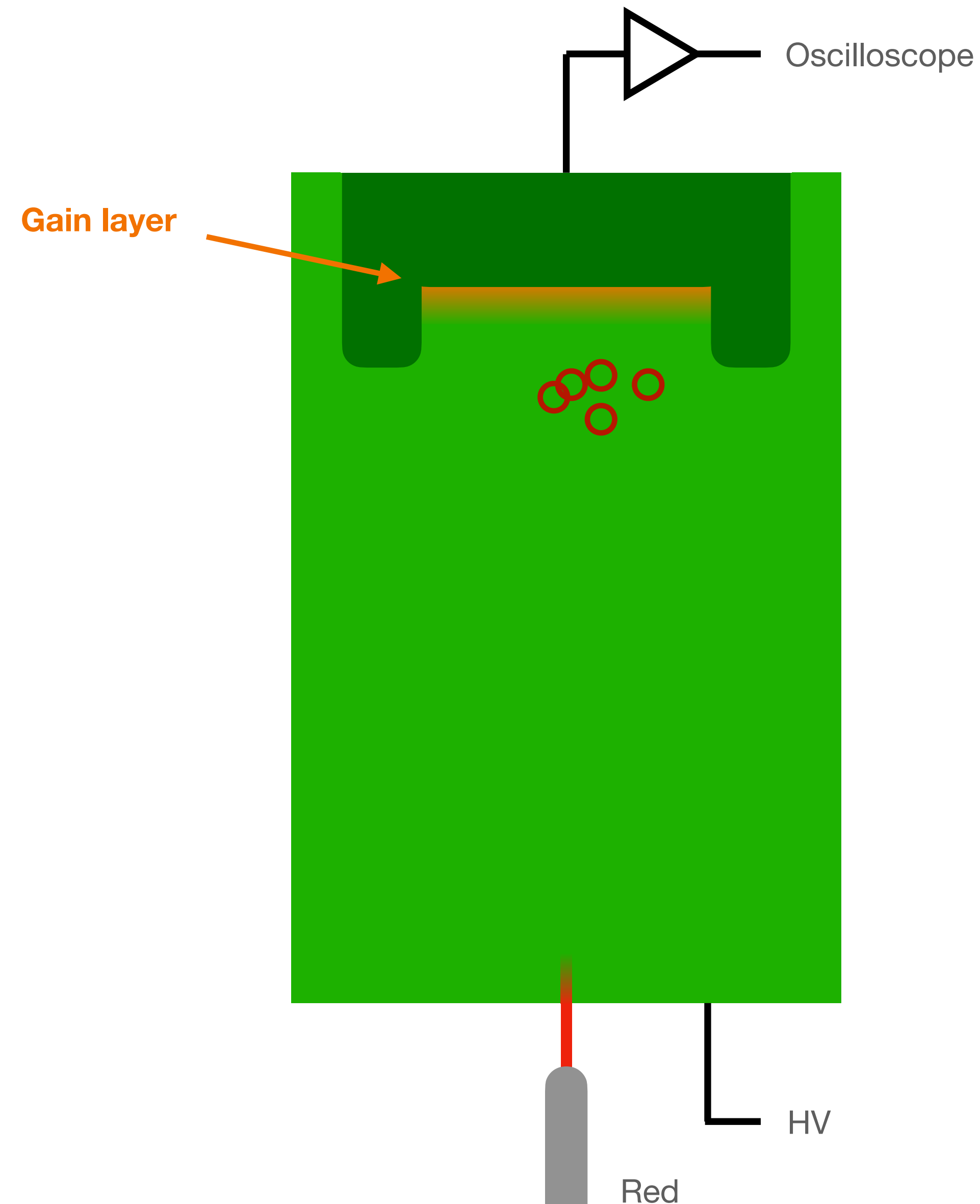
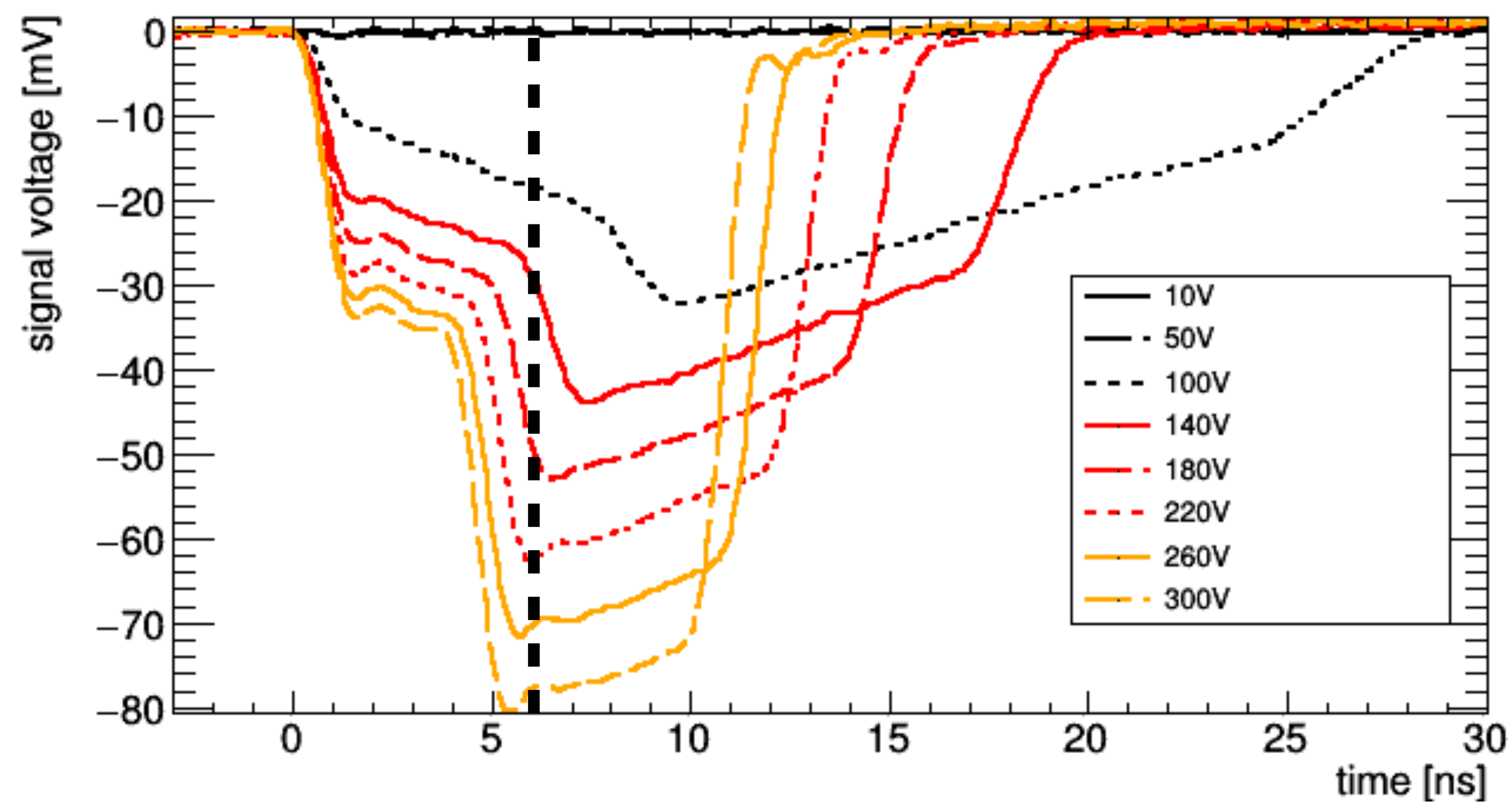

More interesting TCT - LGADs

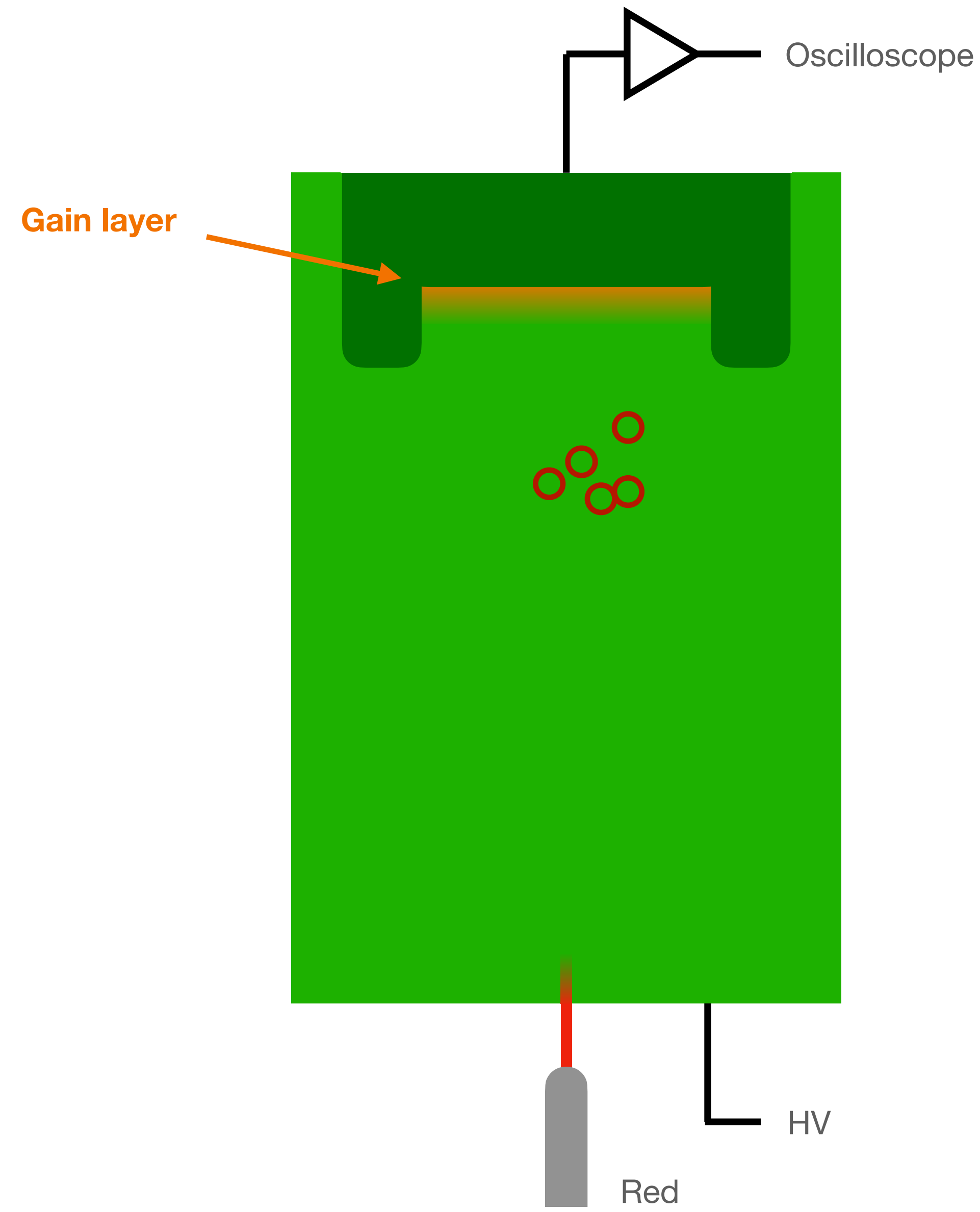
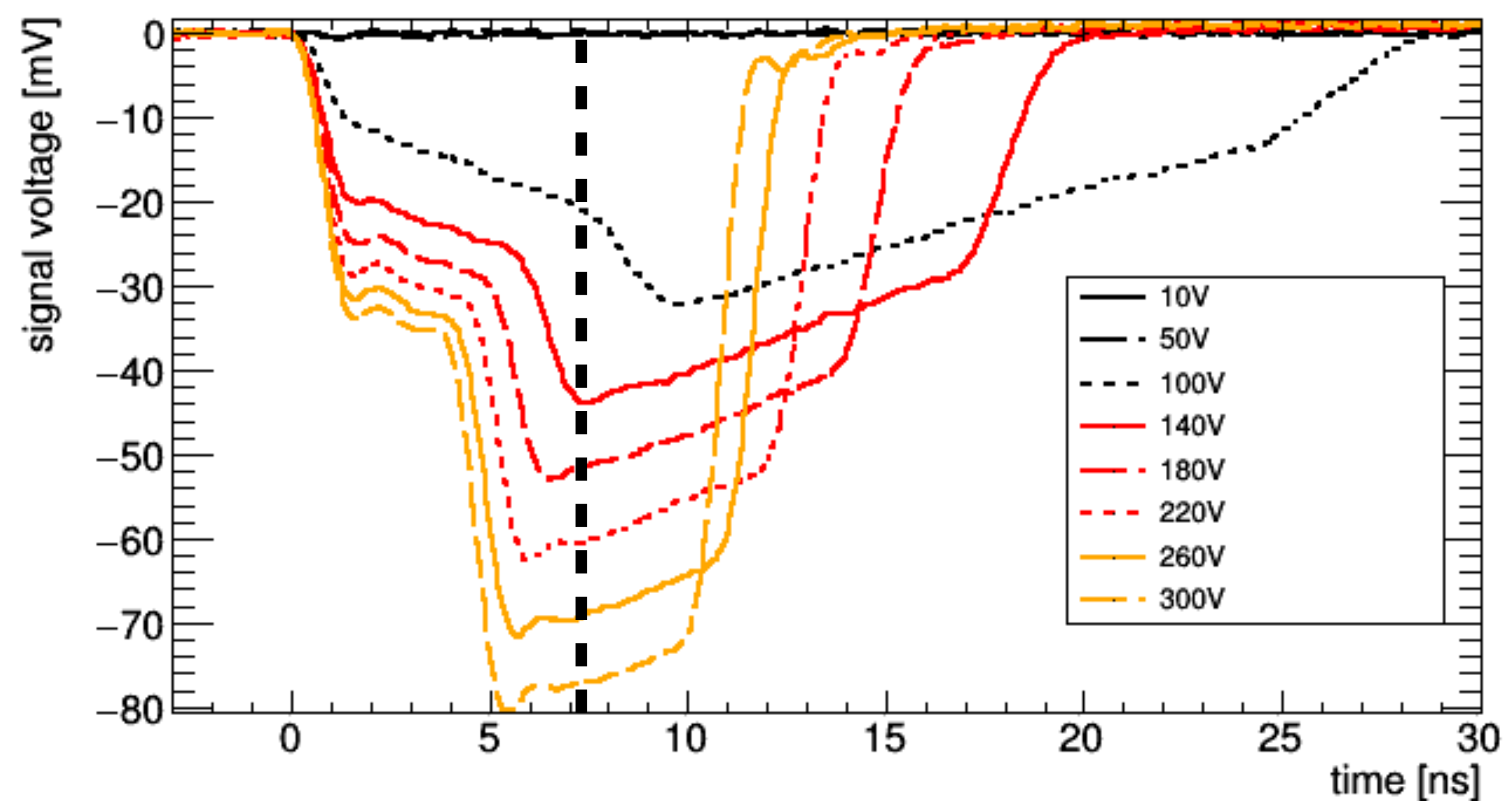

More interesting TCT - LGADs

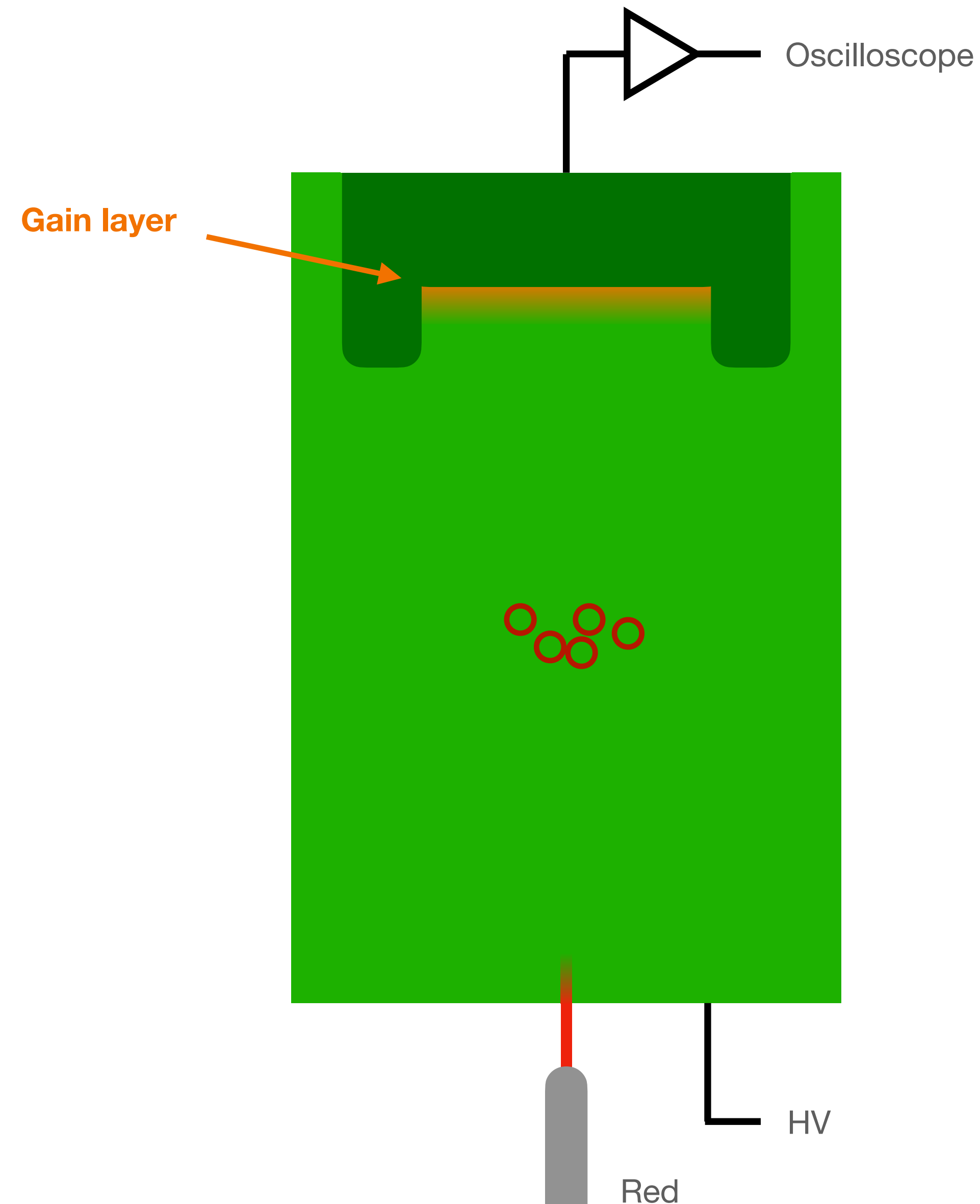
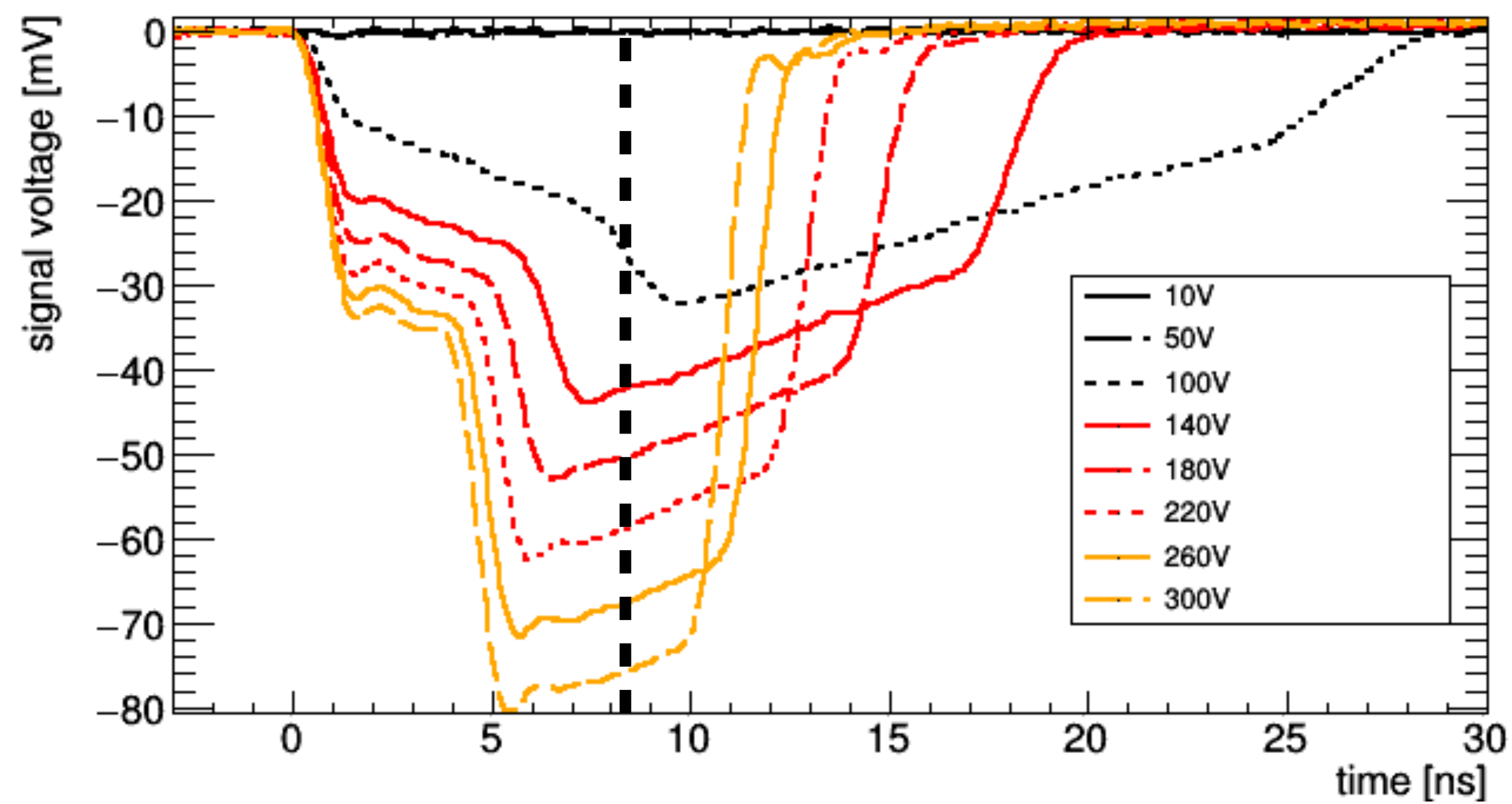

More interesting TCT - LGADs

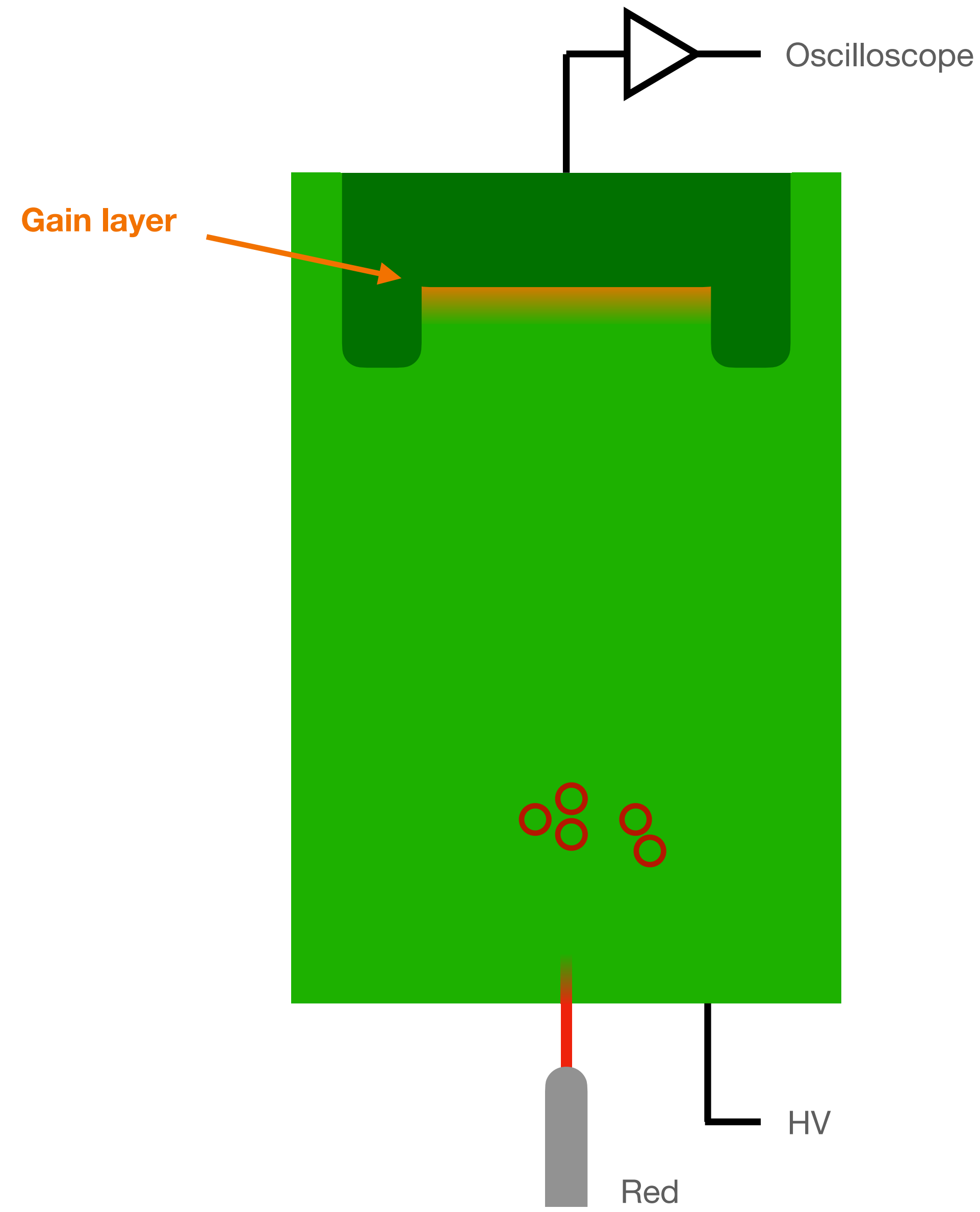
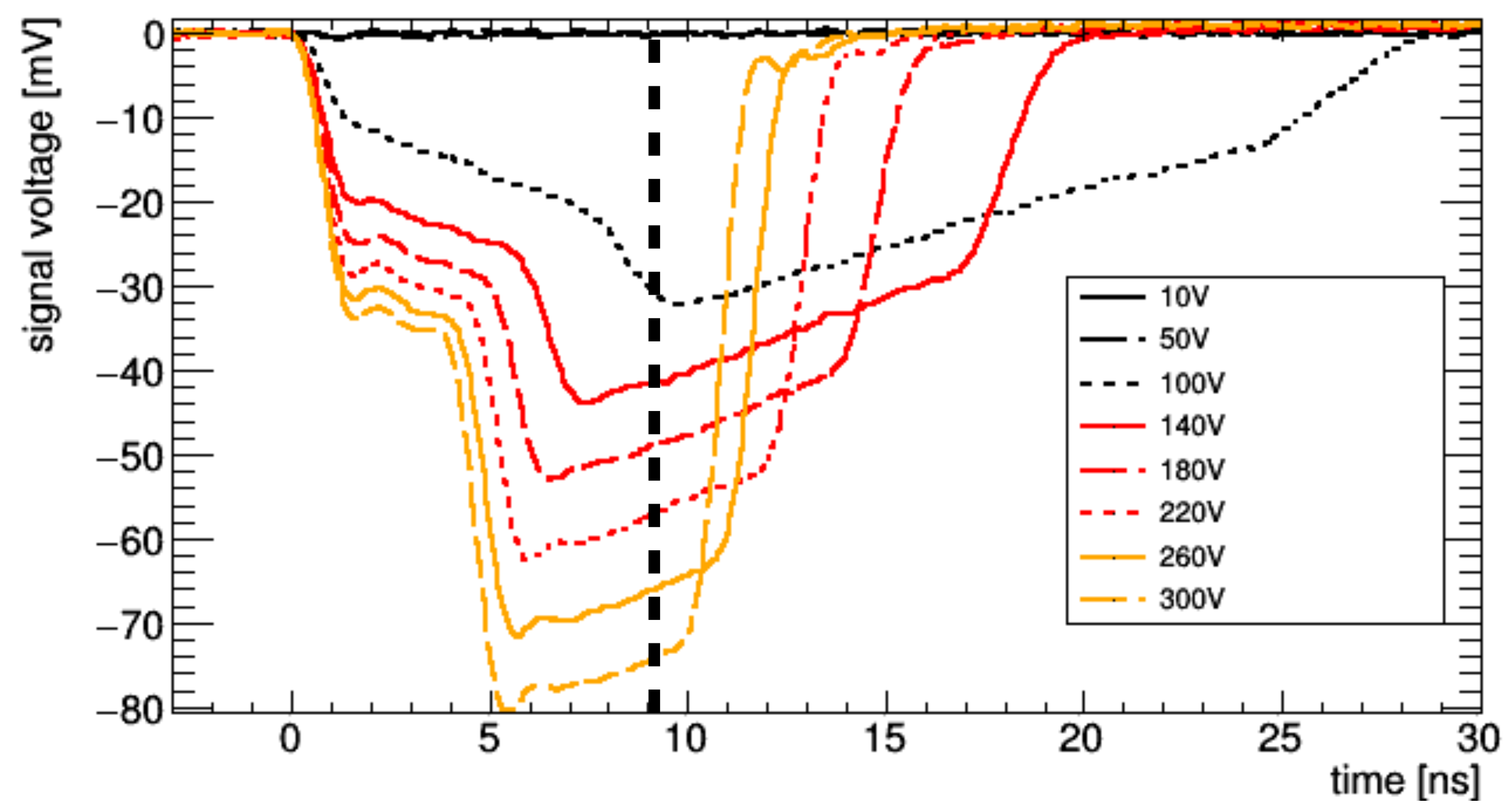

More interesting TCT - LGADs

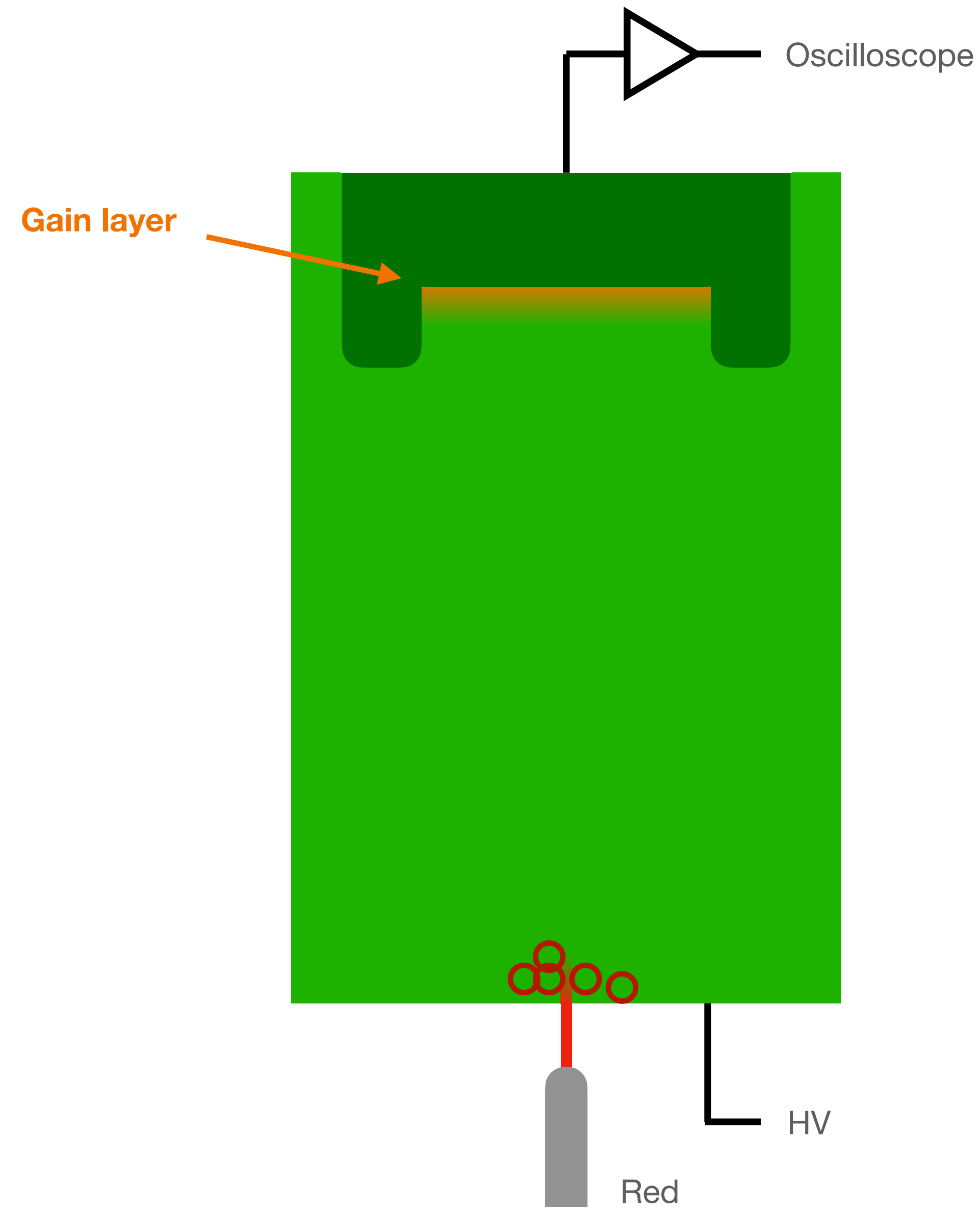
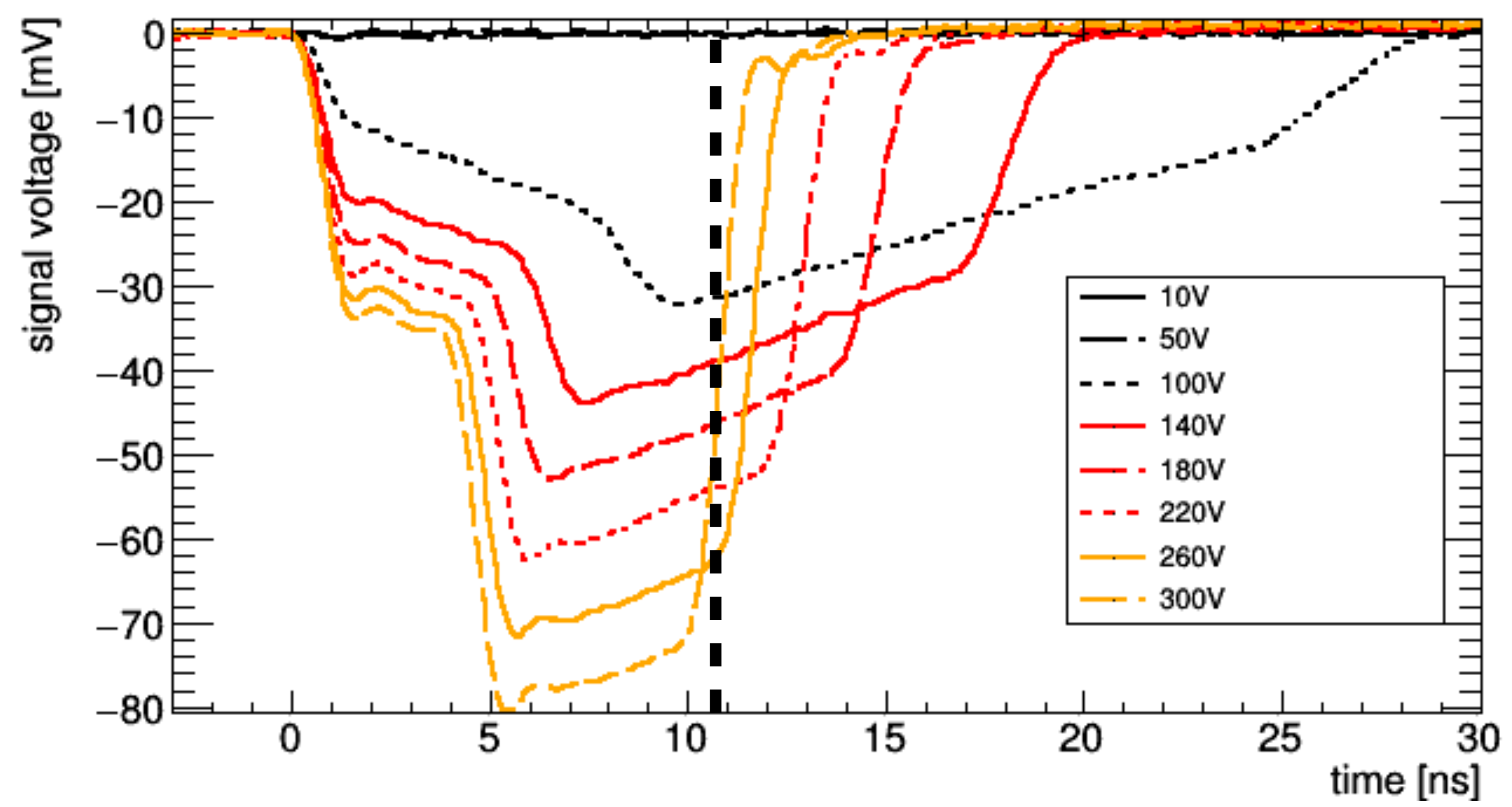

More interesting TCT - irradiated LGADs

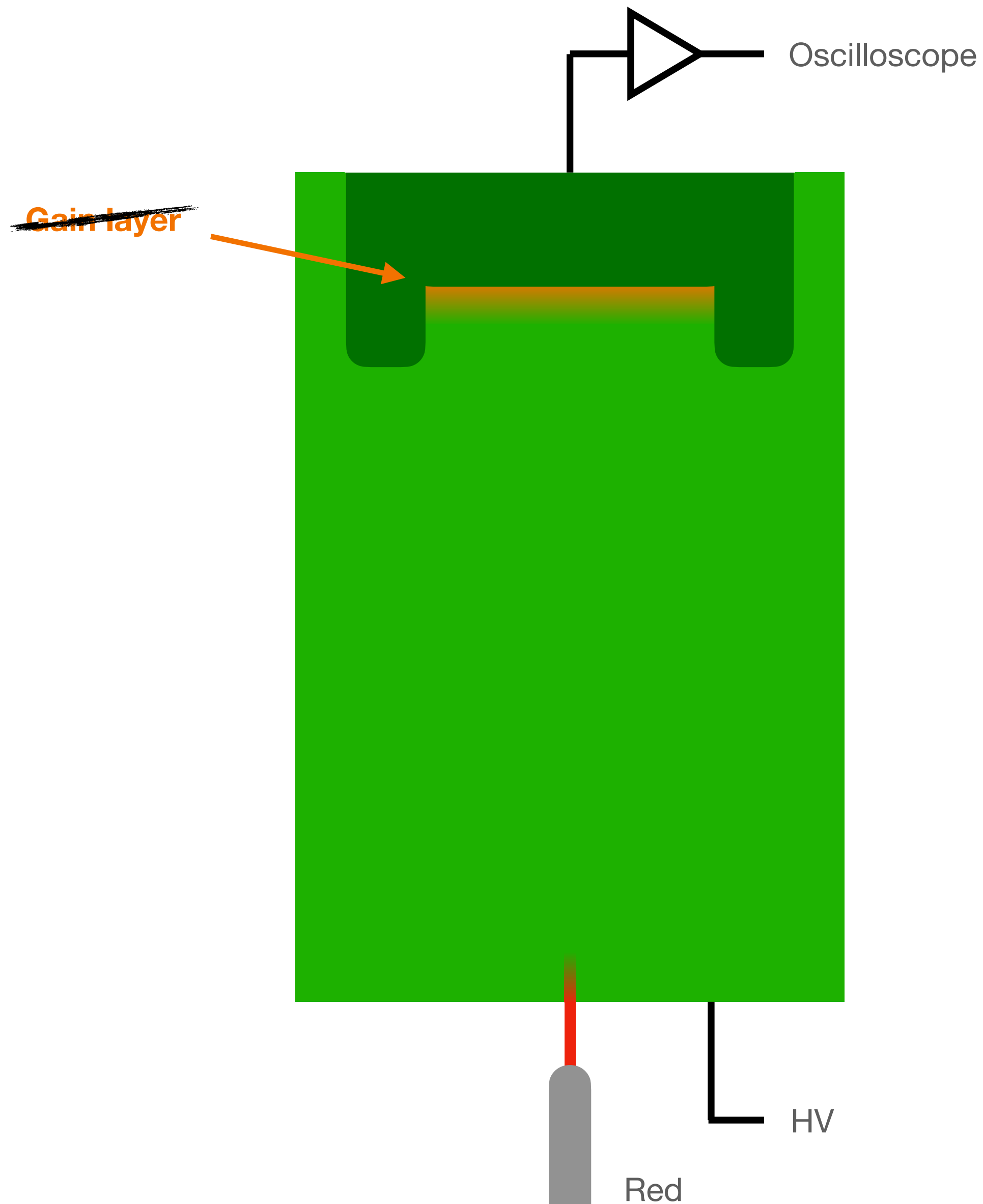
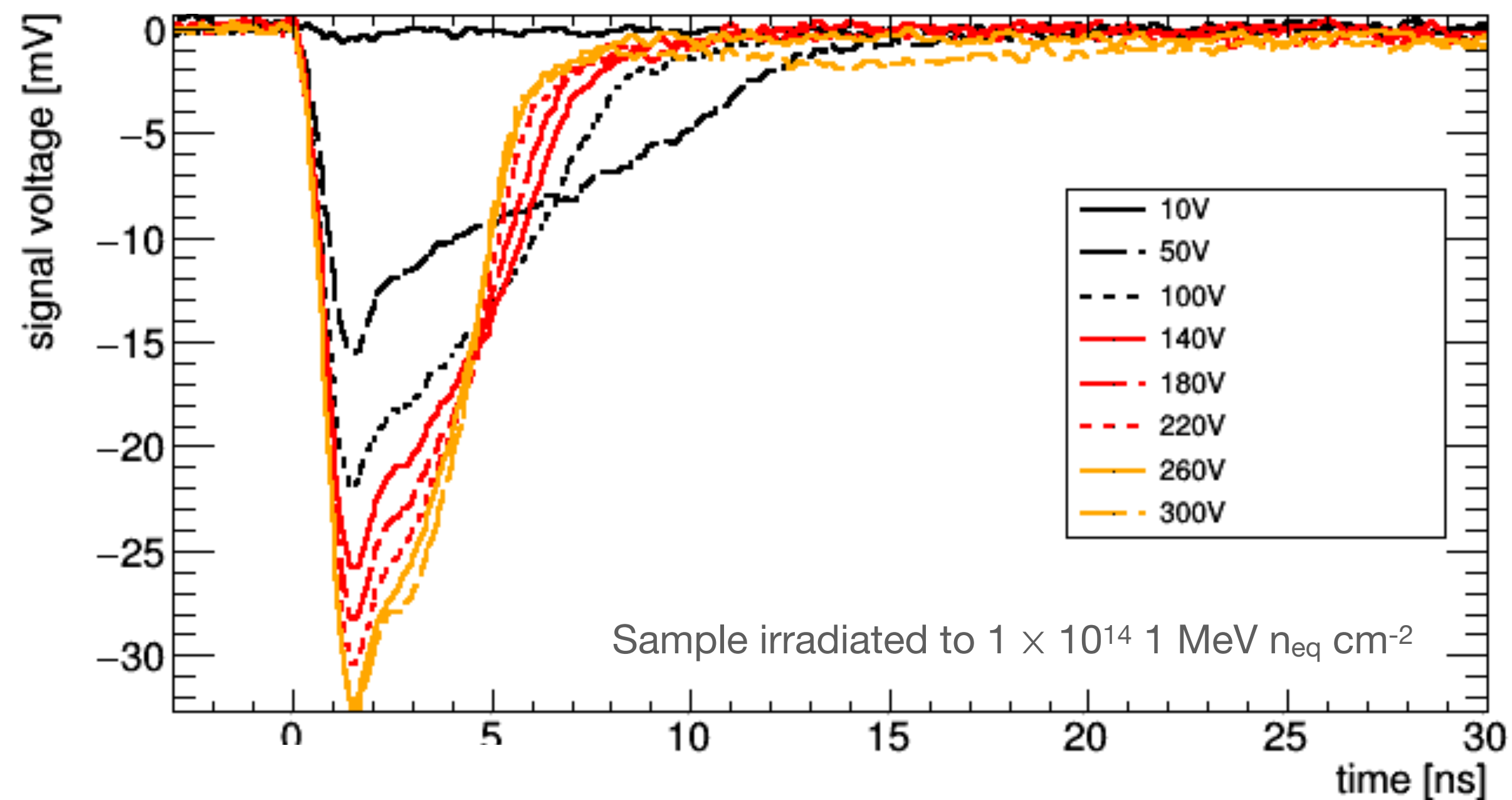

Space charge effects

Note that when we starting multiplying the number of charge carriers, the assumption that they are independent starts to fail

- Space charge from generated carriers can start to distort the local electric field, suppressing further multiplication
- Full details: <https://arxiv.org/abs/2107.10022>

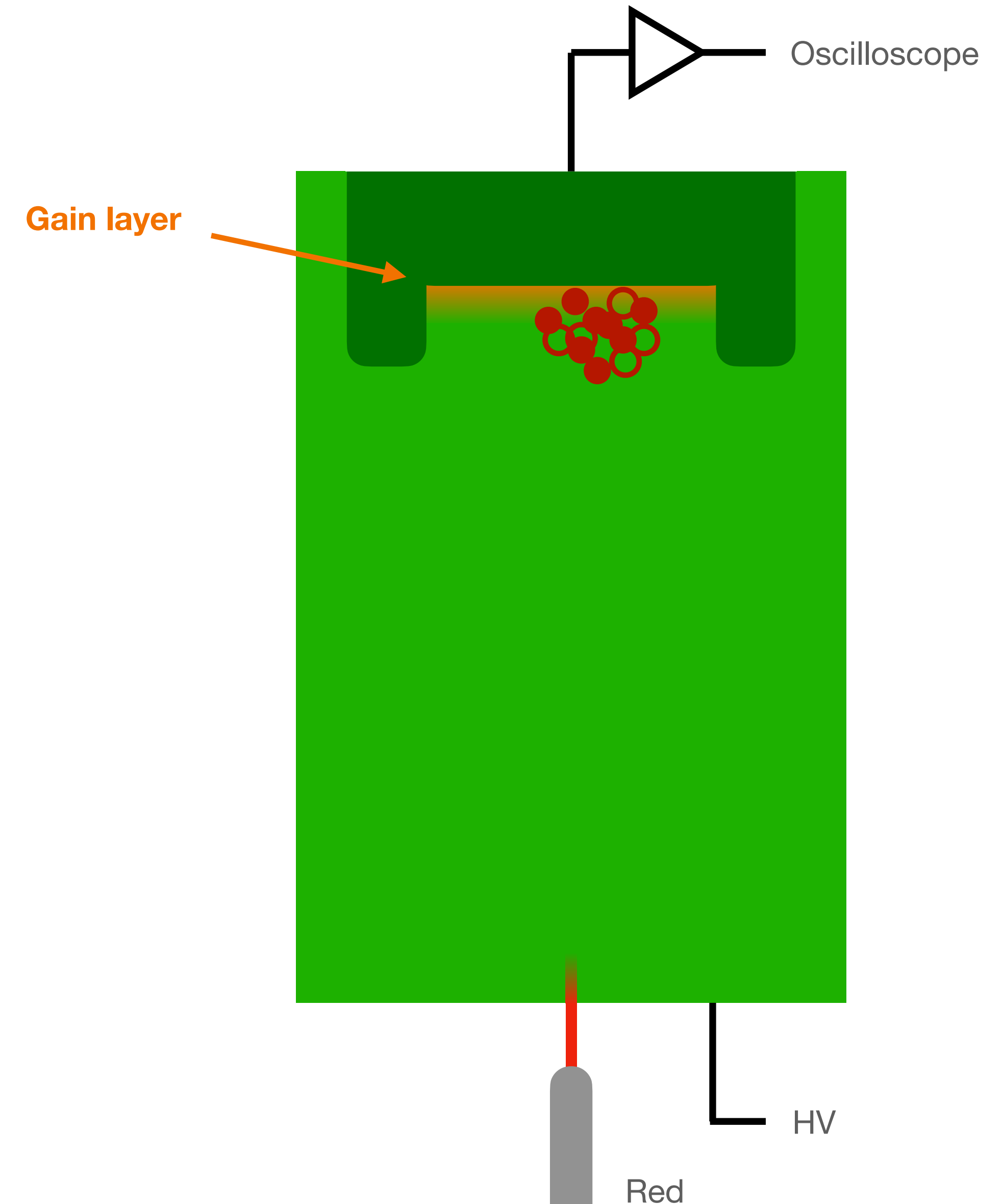
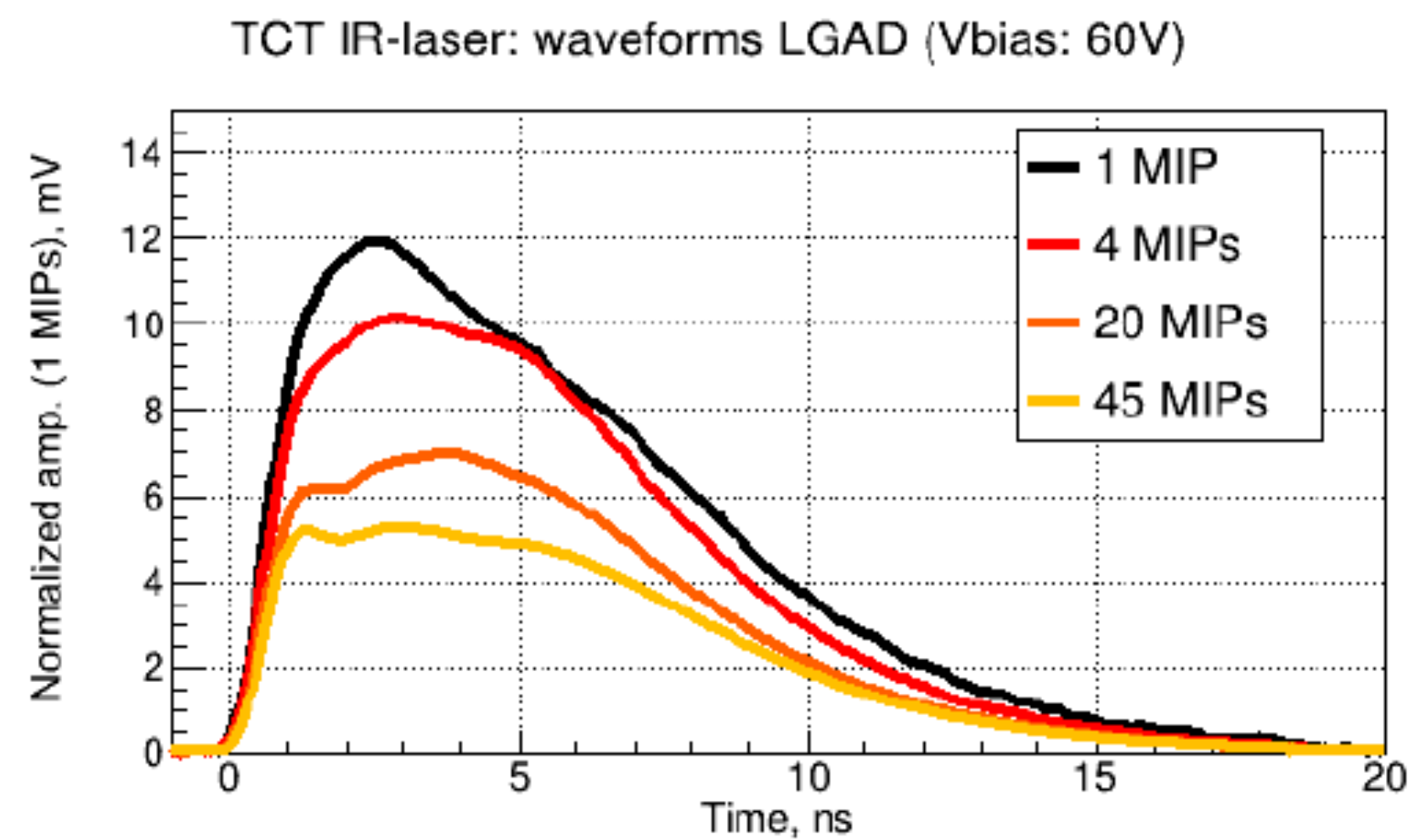

TCT in the flesh

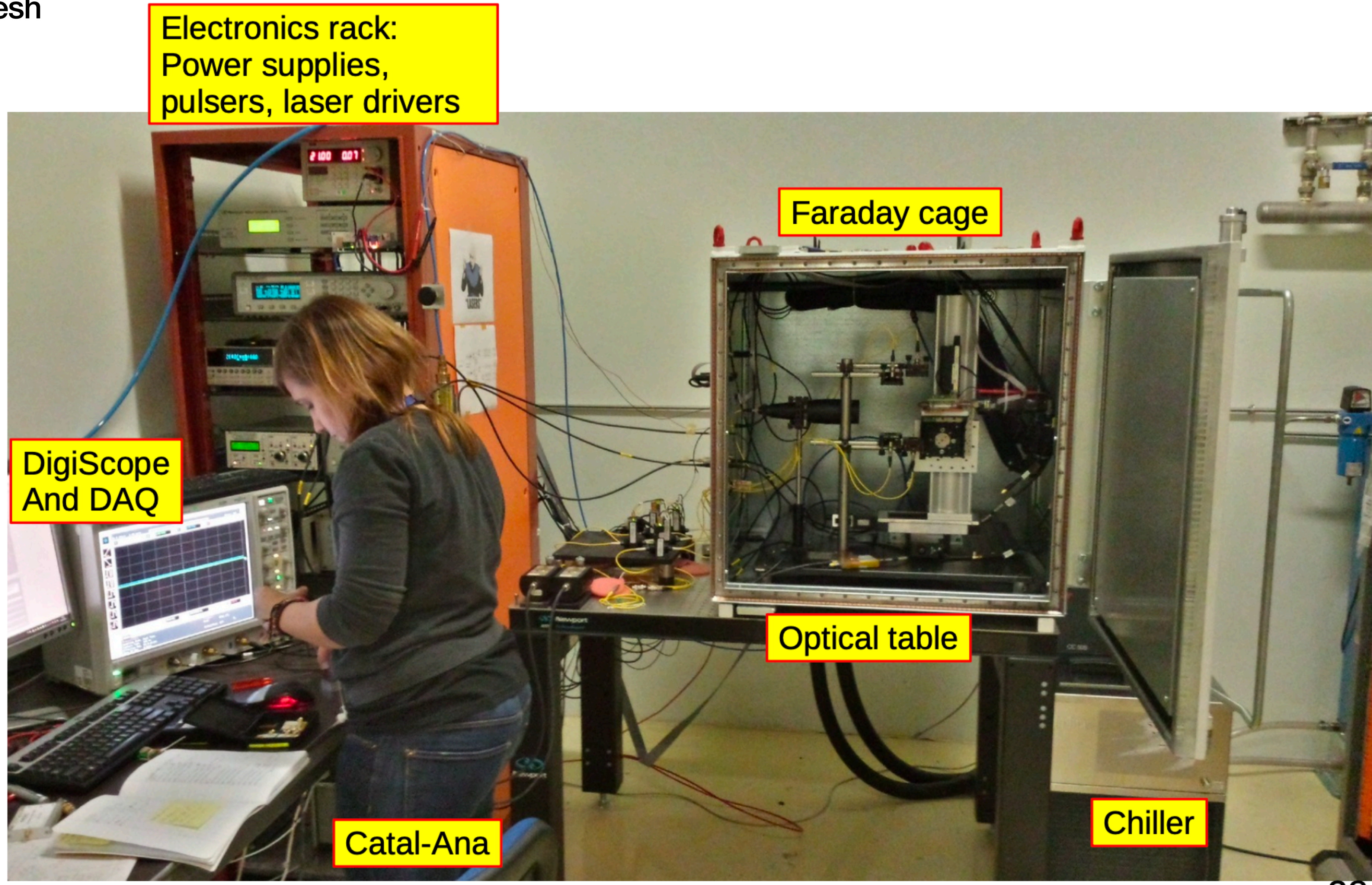

TCT in the flesh

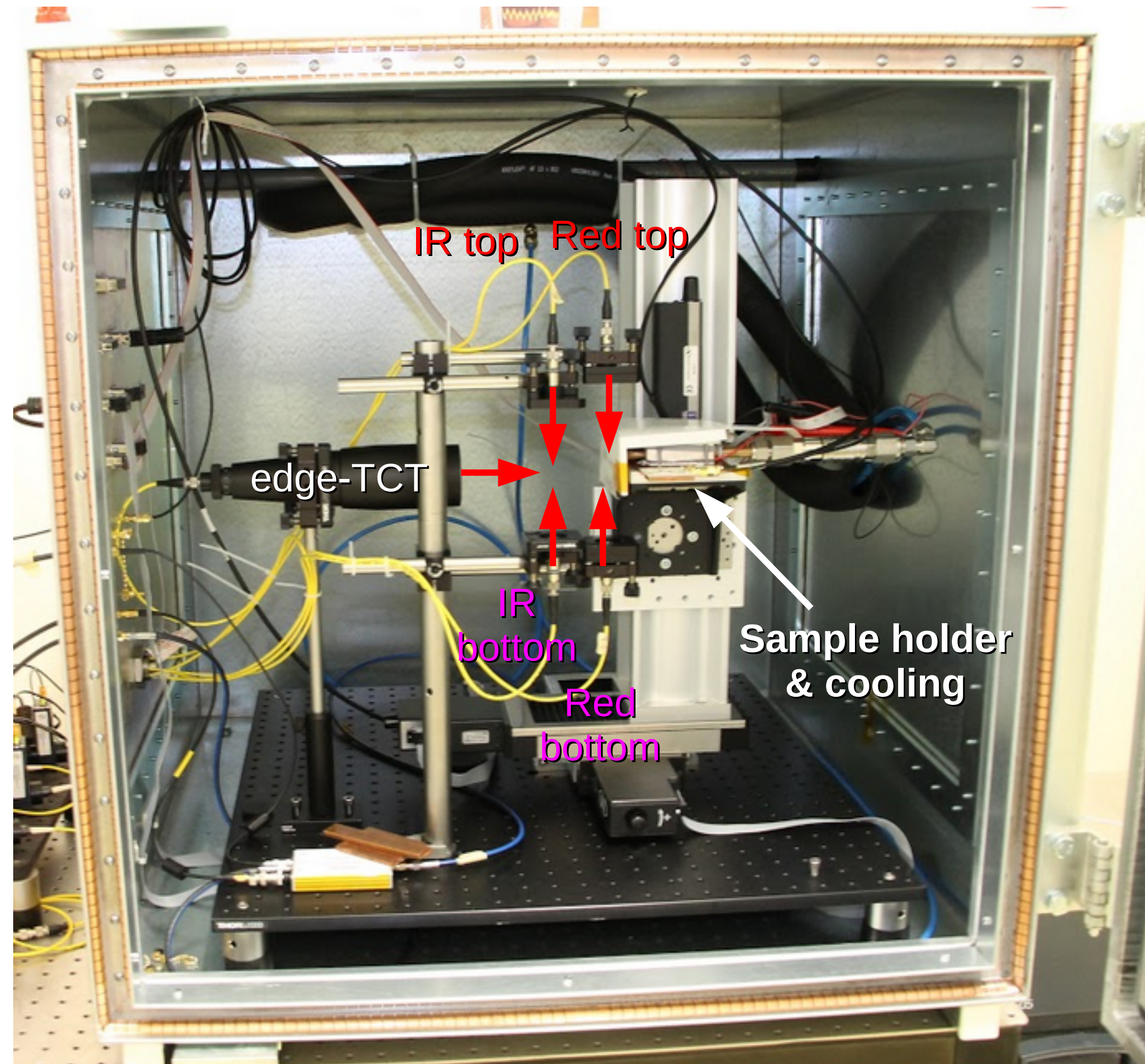

Two Photon Absorption

Plots taken from M. Wiehe et al, IEEE Transactions on Nuclear Science, Vol. 68, No. 2, Feb 2021

Issue with 3D mapping inside silicon detectors for complex geometries

- Photon interactions either generate charge carriers close to surface or in a straight line along the laser path (Red vs. IR)
- Solution? Photons with energy below the pair creation energy! Rare two-photon processes may occur at focal point

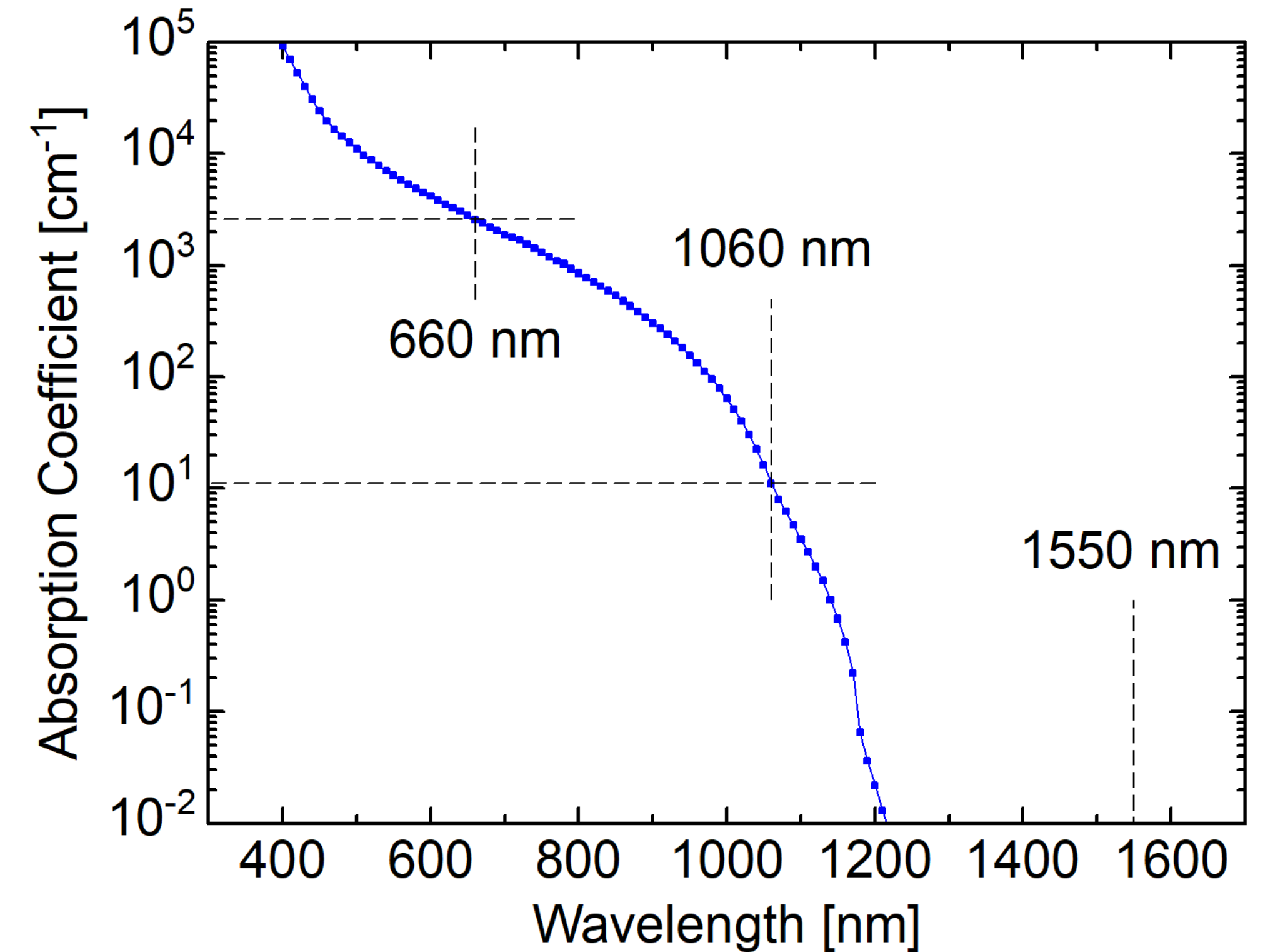

Two Photon Absorption

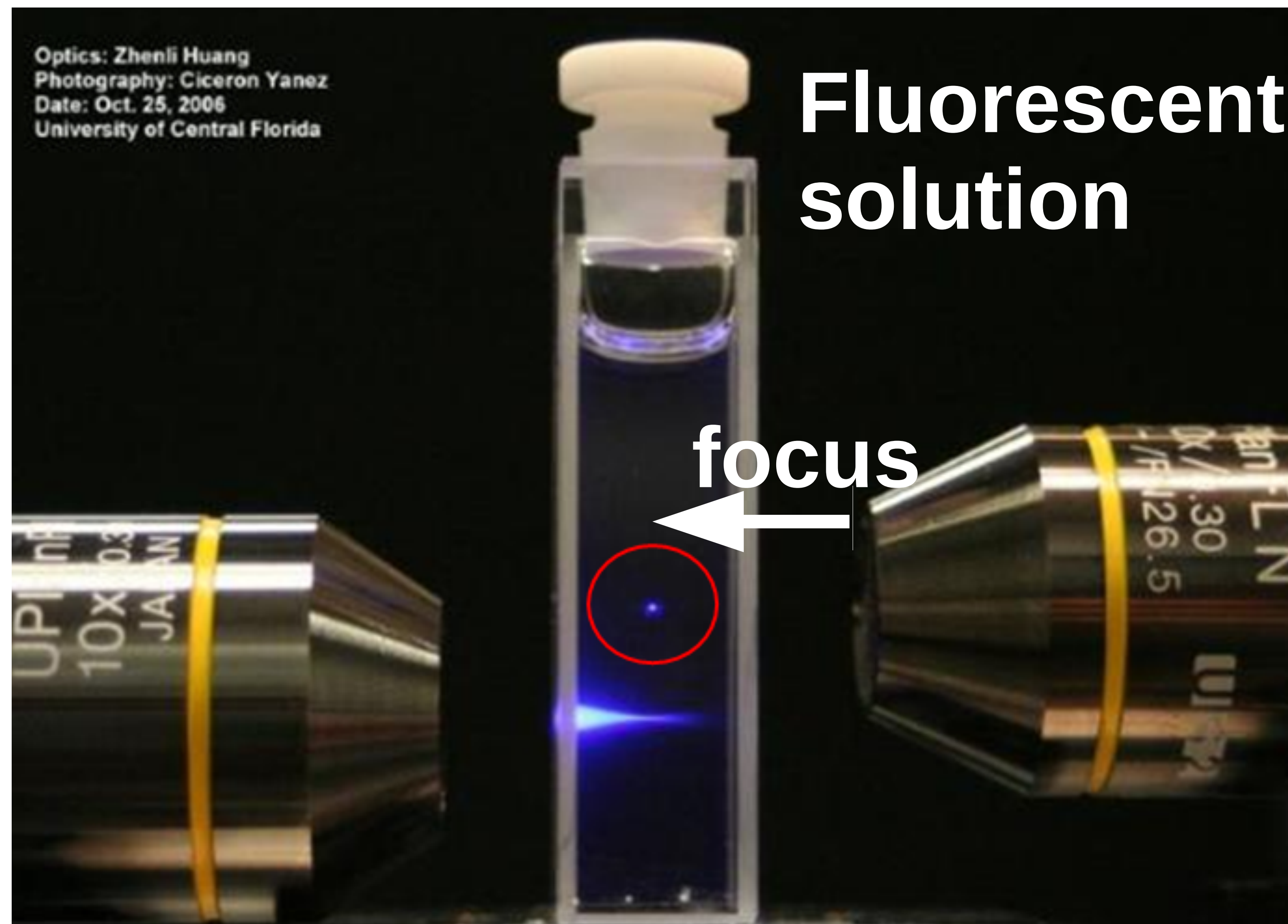

Two Photon Absorption

Lasers for TPA-TCT have to be sharply pulsed in order to generate enough photons at the focal point to lead to appreciable charge carrier generation

- But the 3D precision can be excellent, ~few cubic microns!

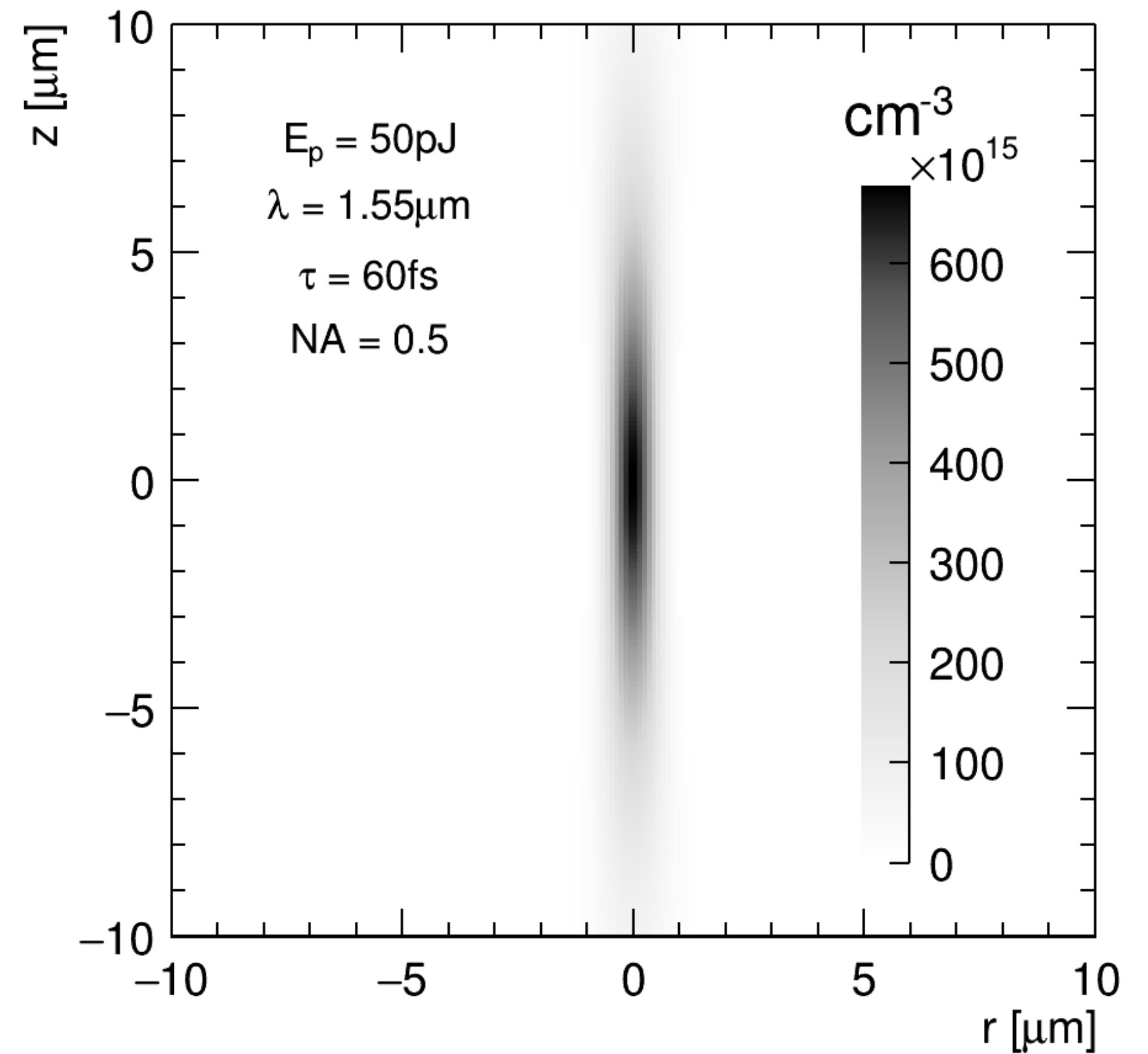

Two Photon Absorption

Lasers for TPA-TCT have to be sharply pulsed in order to generate enough photons at the focal point to lead to appreciable charge carrier generation

- But the 3D precision can be excellent, ~few cubic microns!
- However, the laser systems are considerably more complicated and have some fundamental limits in terms of pulse widths travelling through silicon...

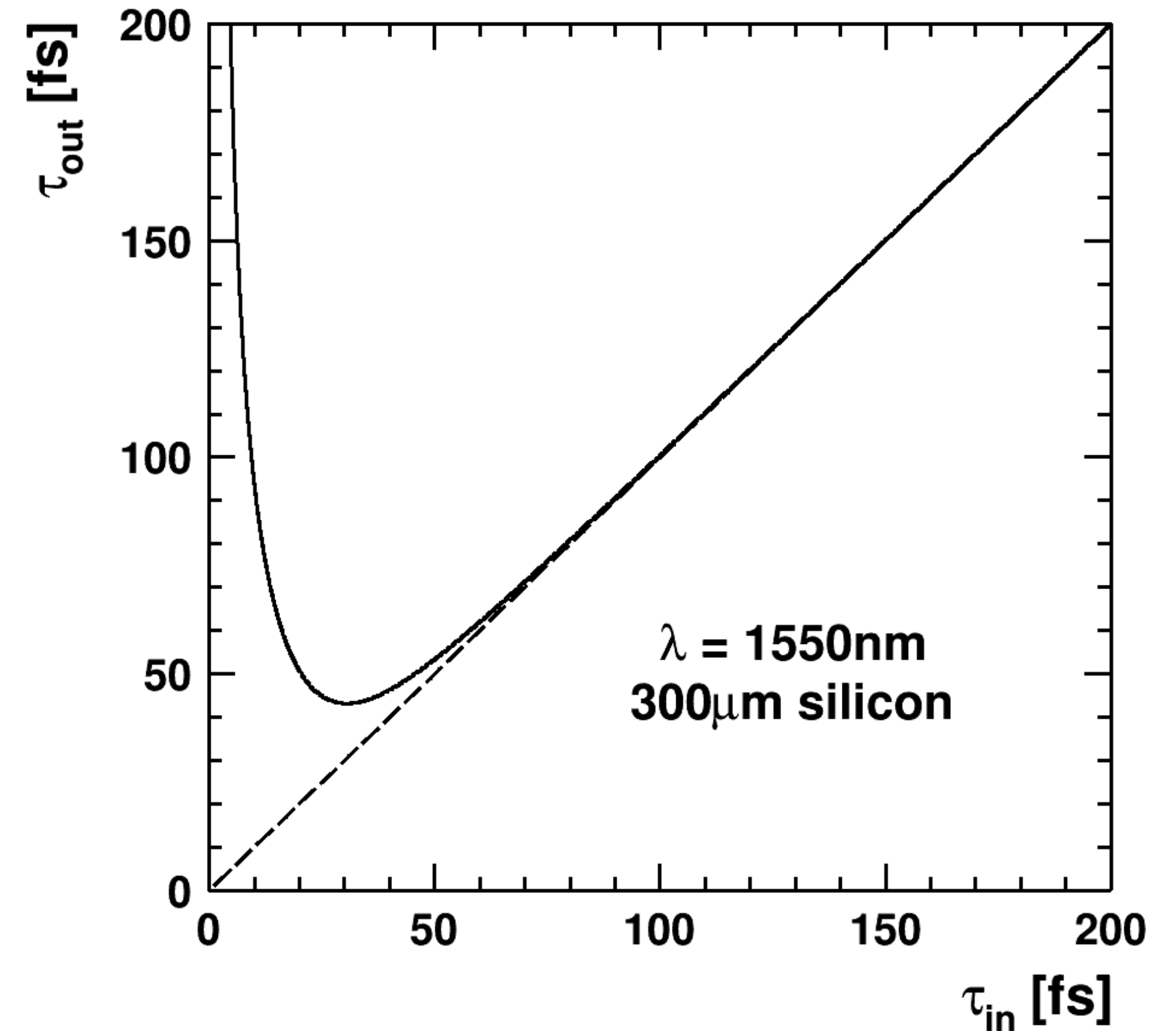

Two Photon Absorption laser systems

Industrial collaboration with CERN and laser producers

FYLA

- Laser Source (LS): 10 MHz, 1550 nm, < 300 fs
- Laser Pulse Management (LPM): 10 pJ to 10 nJ, 10 MHz to single shot
- Dispersion Management (DM): 300 - 600 fs, pulse characterisation
- Taken from M. Moll, AIDAInnova 1st annual meeting, WP4.4

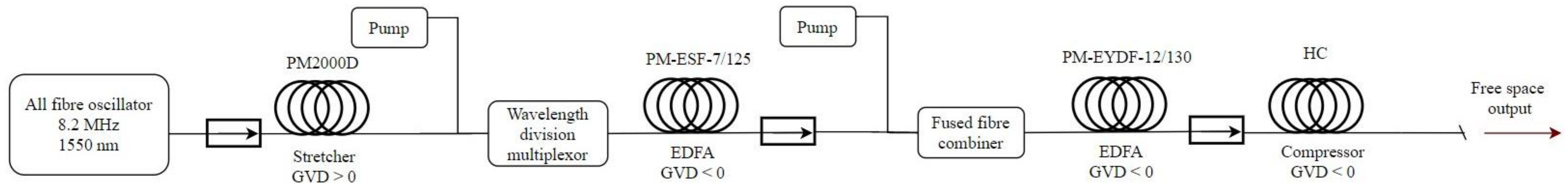
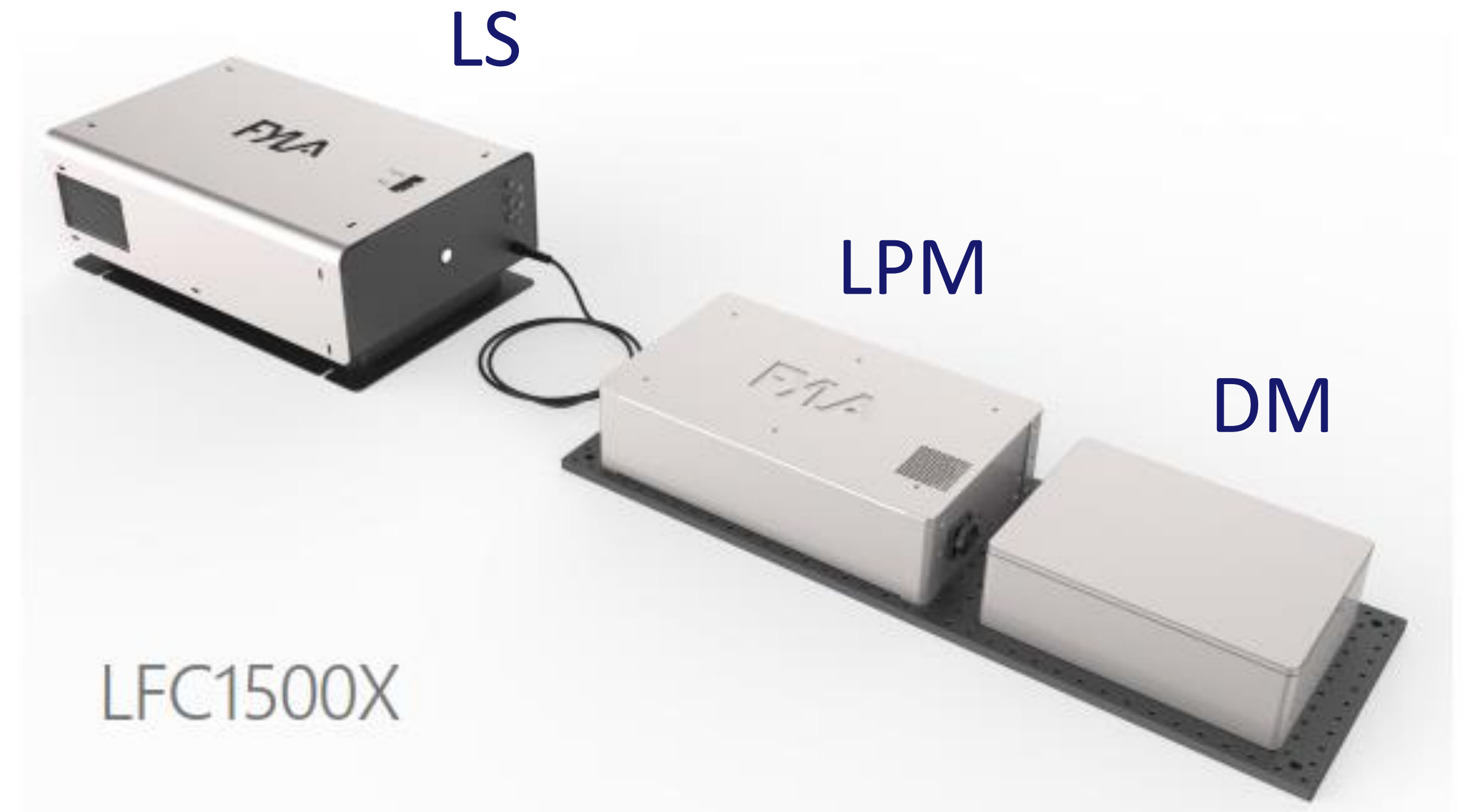

Measurements with TPA-TCT

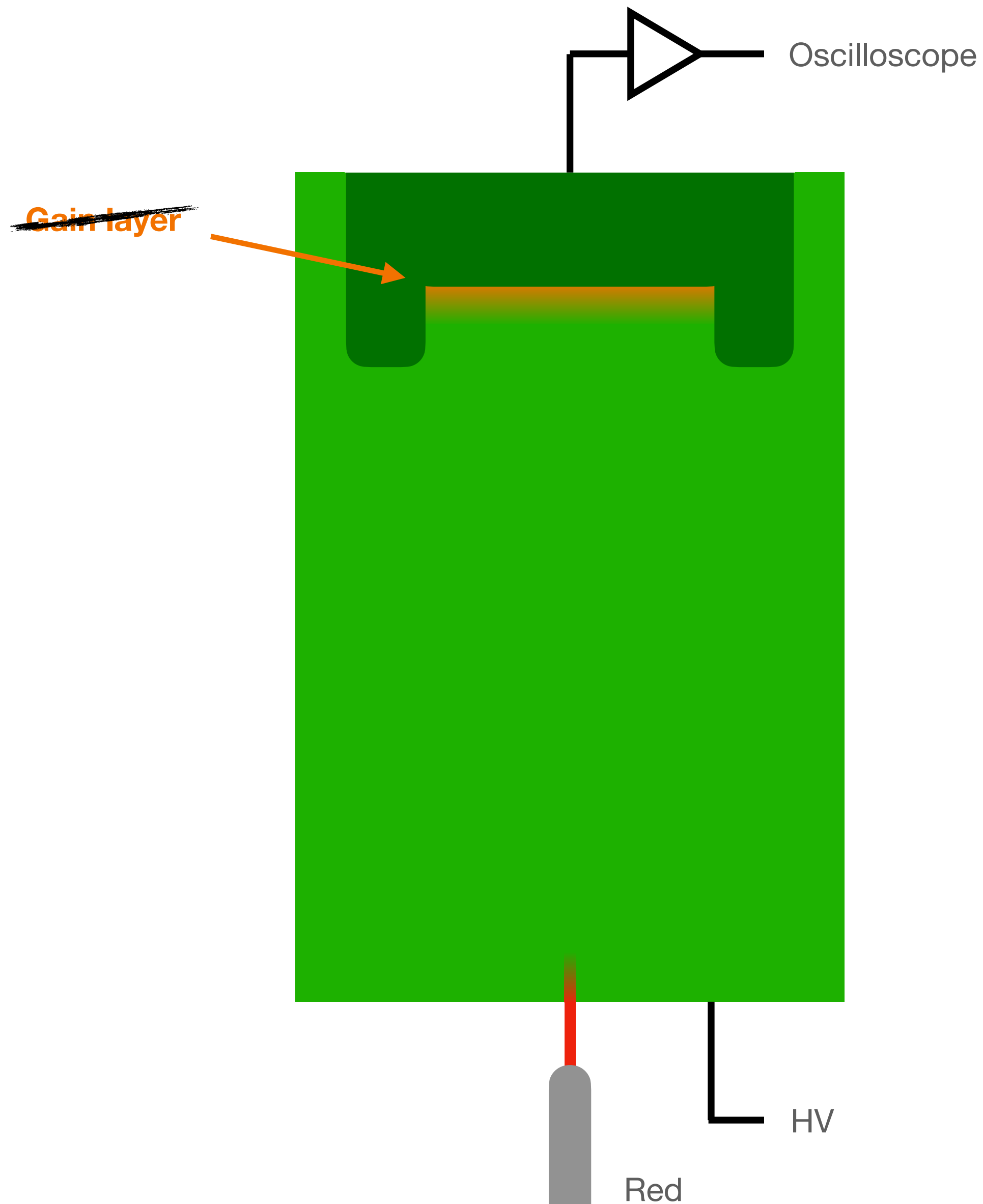
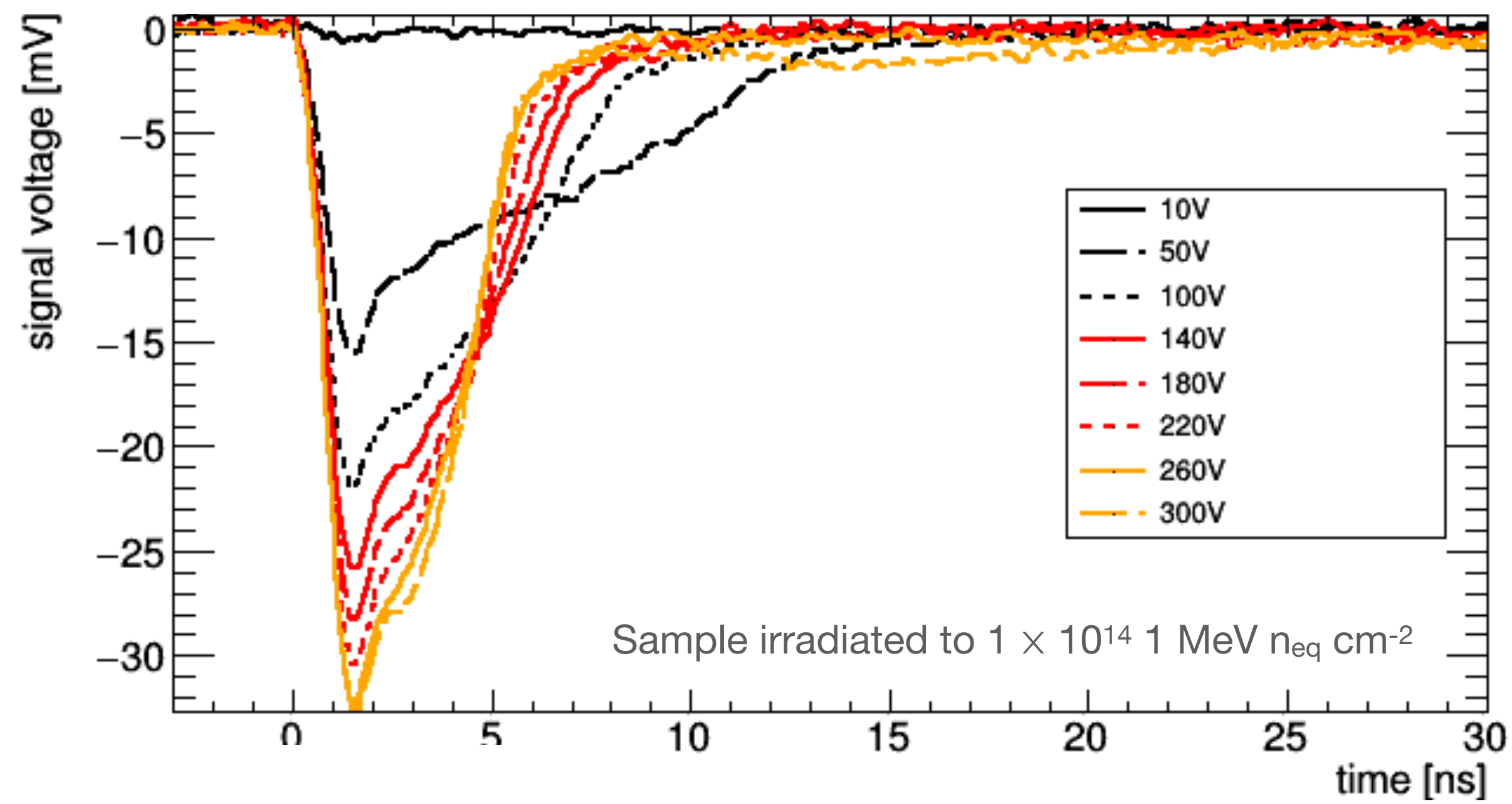

Measurements with TPA-TCT

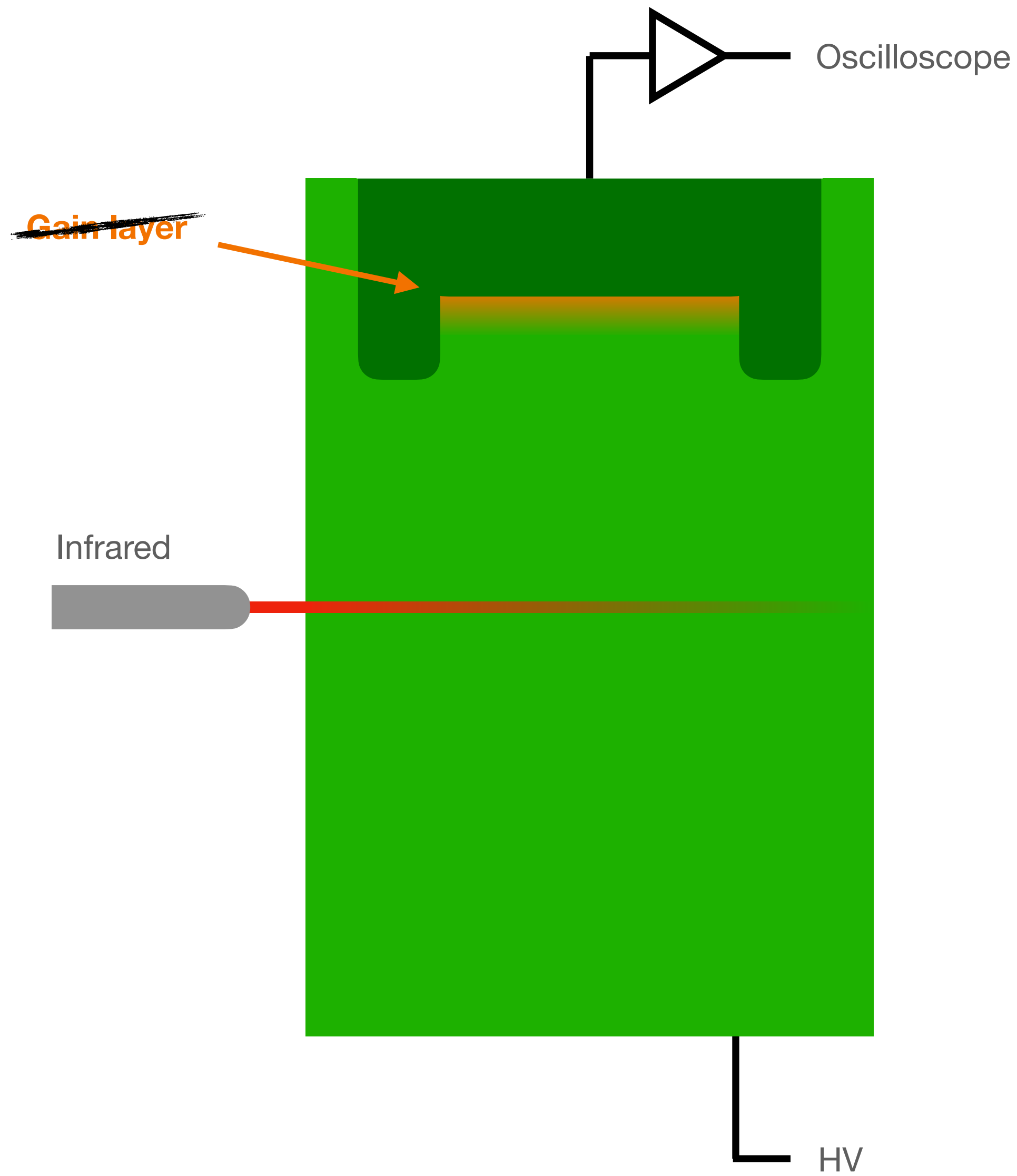
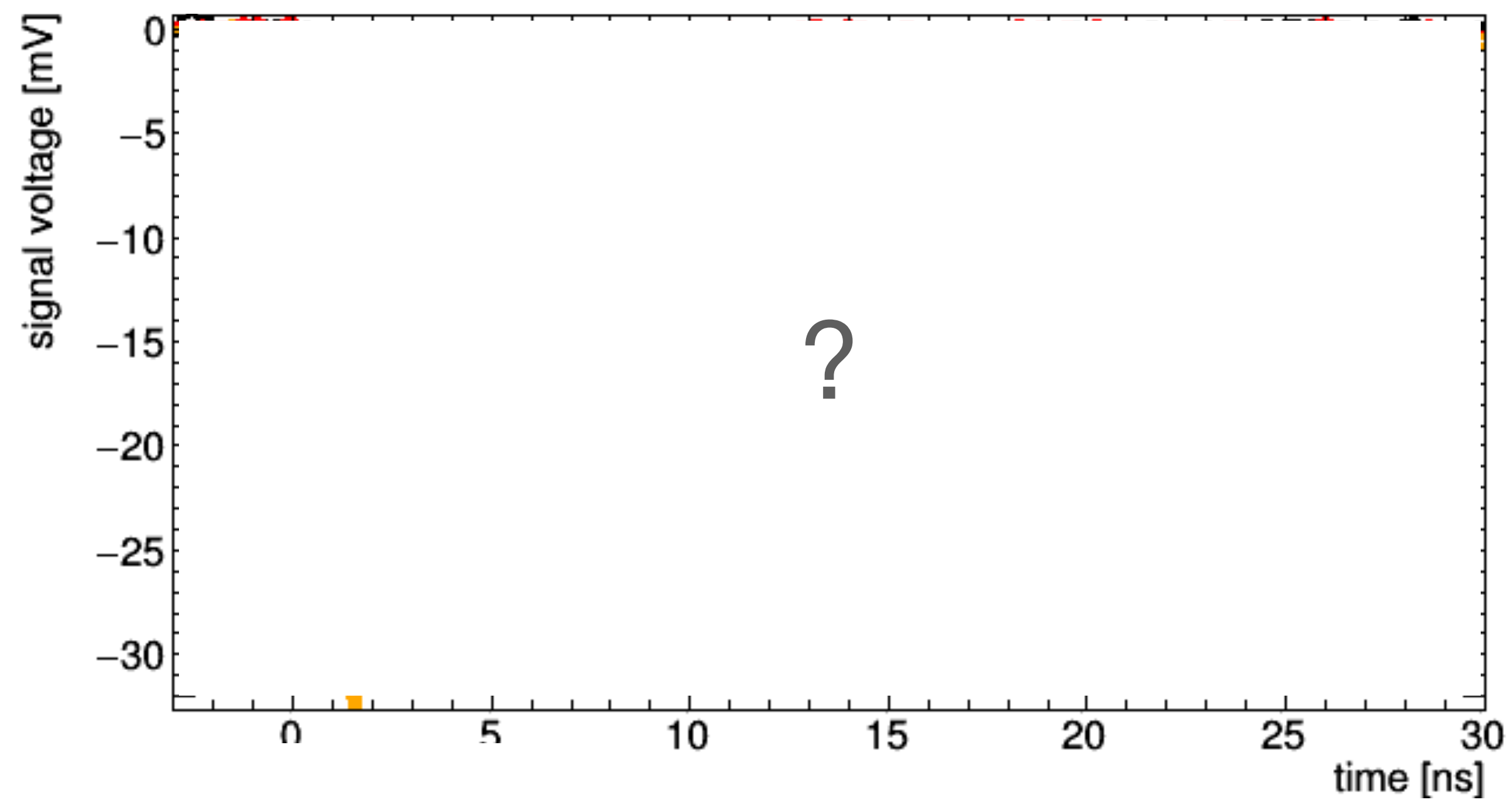

Measurements with TPA-TCT

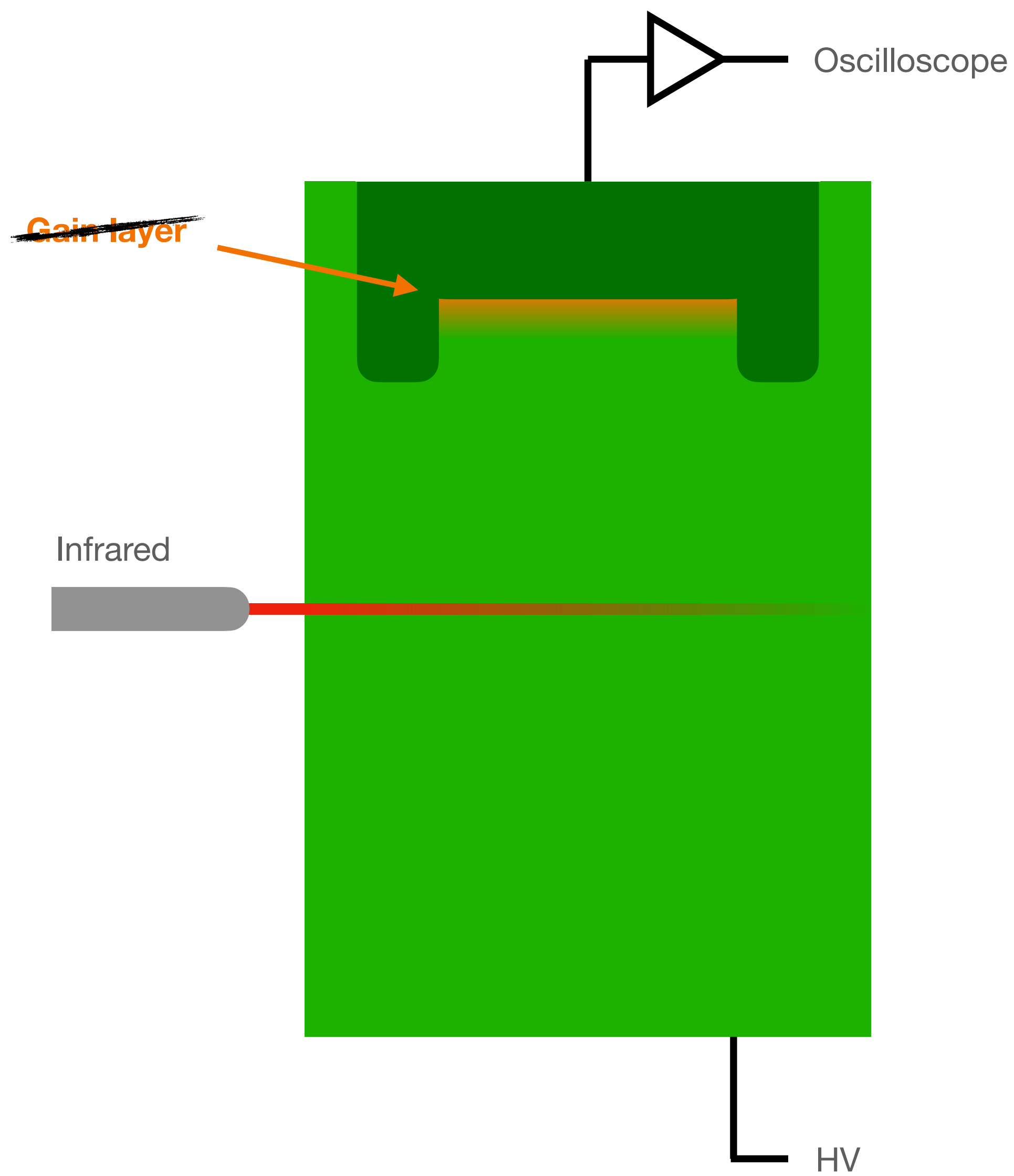
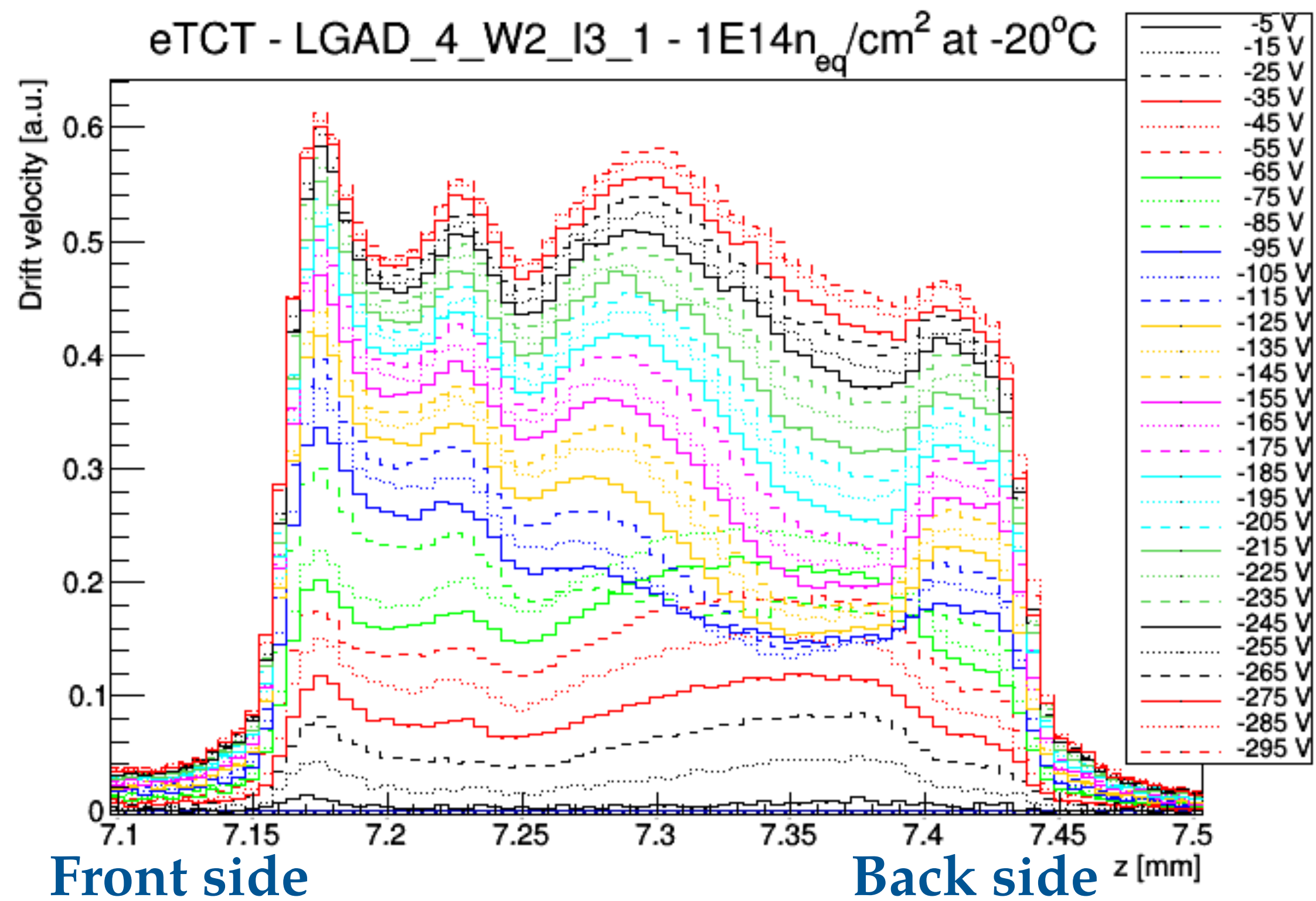

Measurements with TPA-TCT

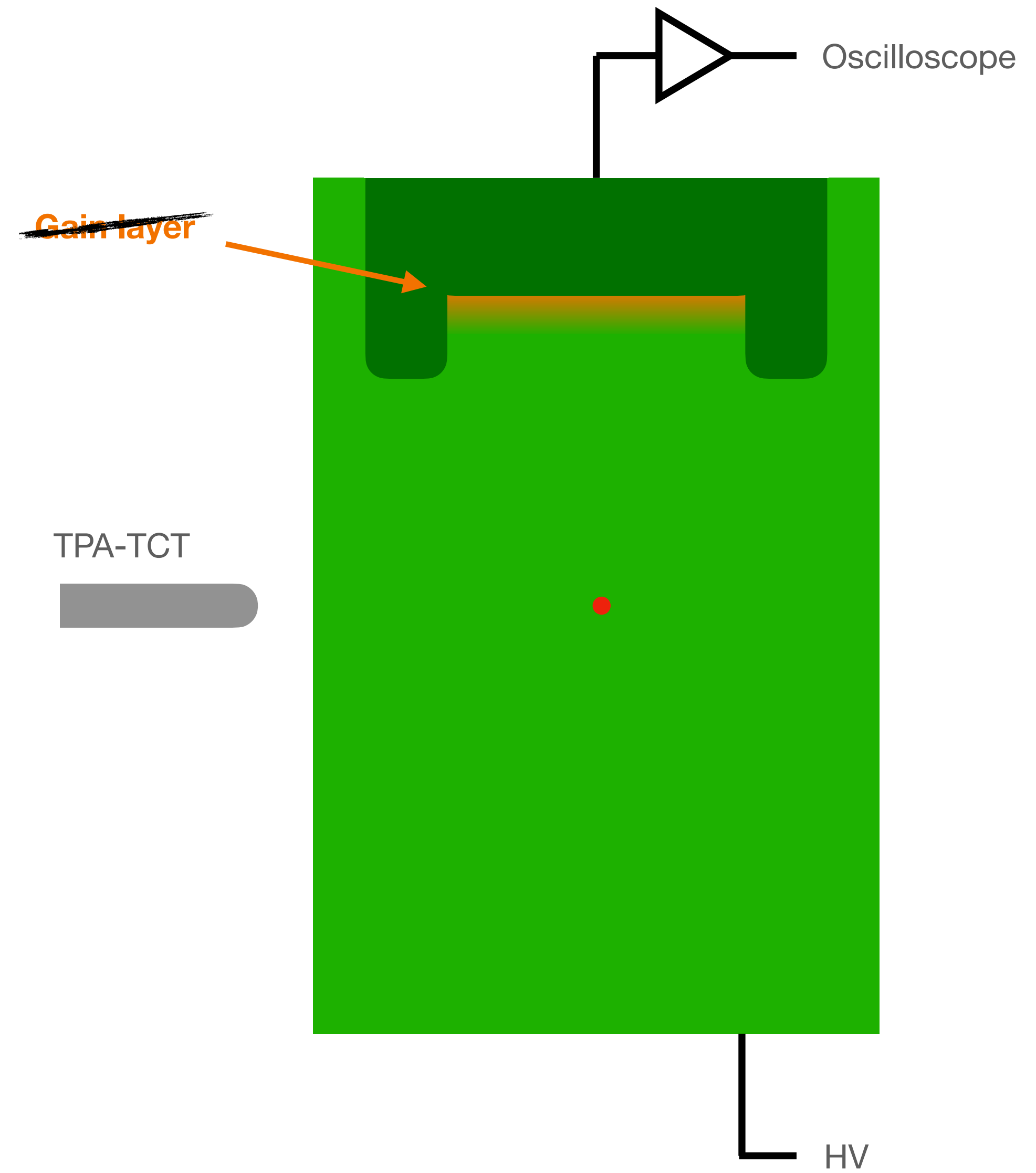
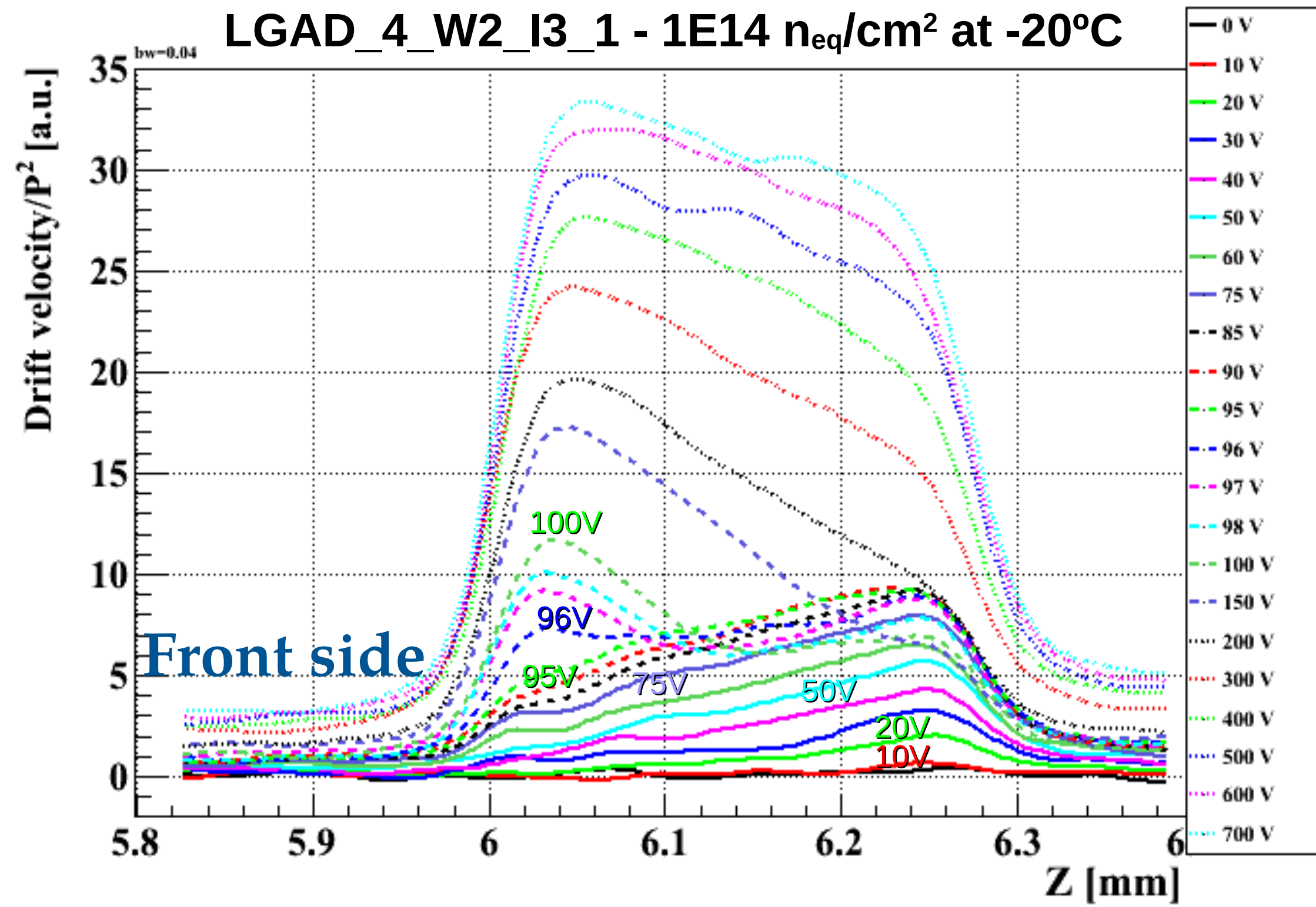

Summary

TCT is a powerful technique for measuring the electric field profile of solid-state detectors

- However, the devil is in the detail (as always) - particularly the weighting field
- It has been instrumental in our understanding of complex irradiated devices, giving us a handle on the appearance of space charge regions and double junctions
- TPA-TCT promises even more power to probe in 3D

Recent DT seminar for TCT:

- <https://indico.cern.ch/event/1292246/>

