

Water Cherenkov Test Experiment Status

Mark Hartz for the WCTE Collaboration

SPSC Meeting, May 7, 2024

What is the WCTE?

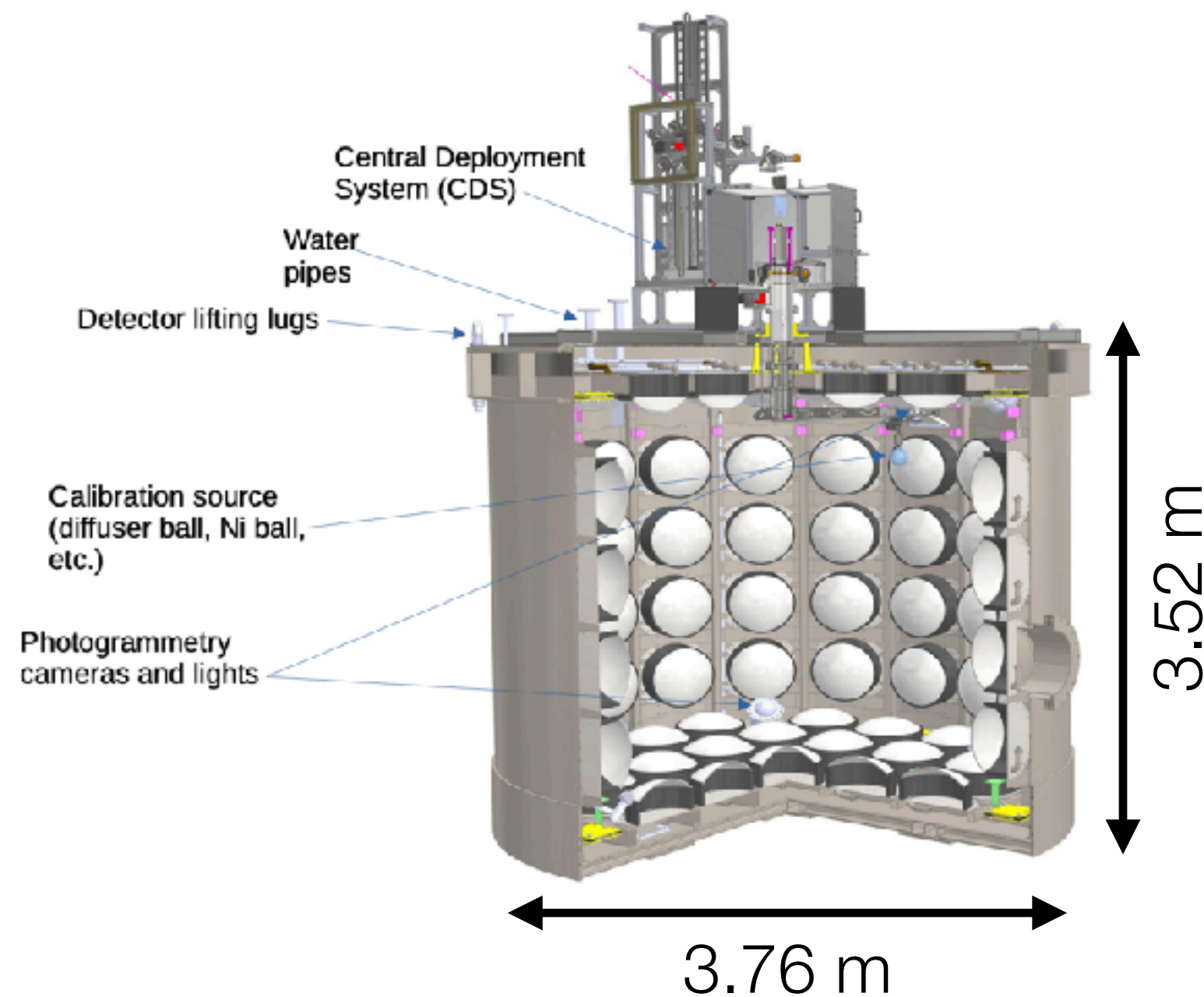
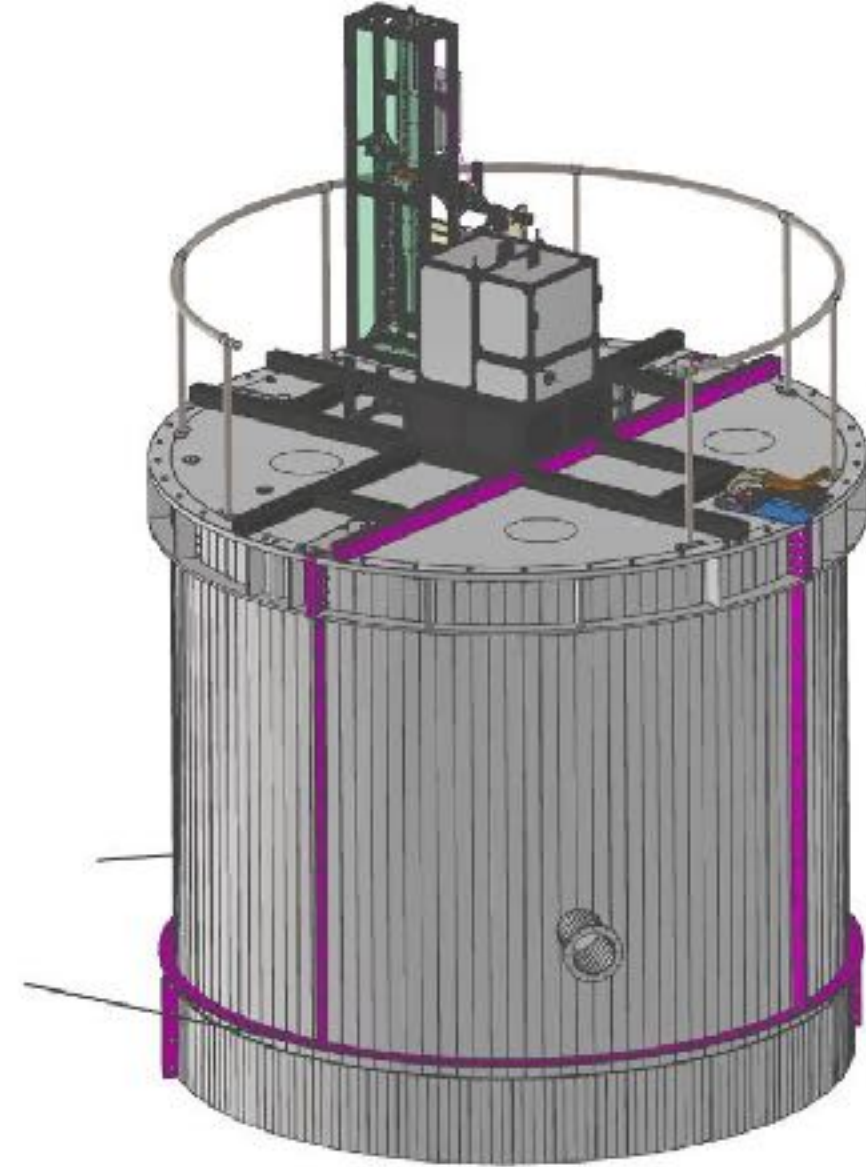

- 40-ton water Cherenkov Detector
- Operate in the T9 beam line in East Hall
- Particle fluxes of e^\pm , μ^\pm , π^\pm , p and γ in the 200 MeV/c to 1000 MeV/c range
- Operating phase with $Gd_2(SO_4)_3$ loading to allow for neutron detection
- Primary photon detection system is 103 multi-PMT photosensors mounted on inside of detector
- Test of new detector systems, calibration and event reconstruction techniques for water Cherenkov detectors
- Proposal document: SPSC-P-365

WCTE Physics

- Pions of ~ 500 MeV/c or less are produced in neutrino interactions
- Modeling of their hadronic interactions in water and their reconstruction is challenging
- WCTE data will be used to study pion reconstruction in water Cherenkov detectors and measure interaction cross sections

Pion production in neutrino interaction

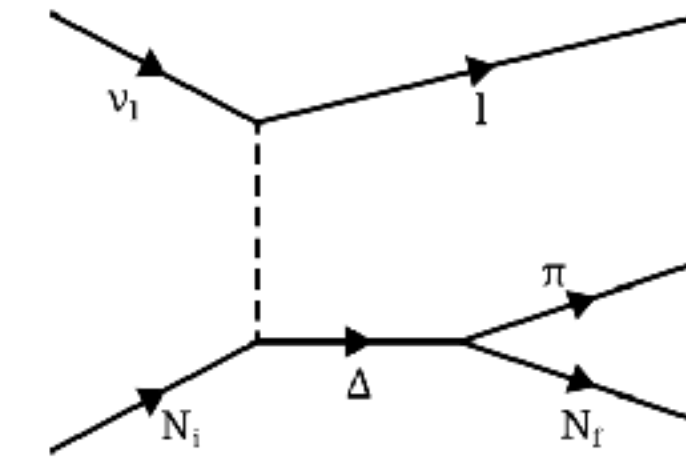

Pion scattering in water

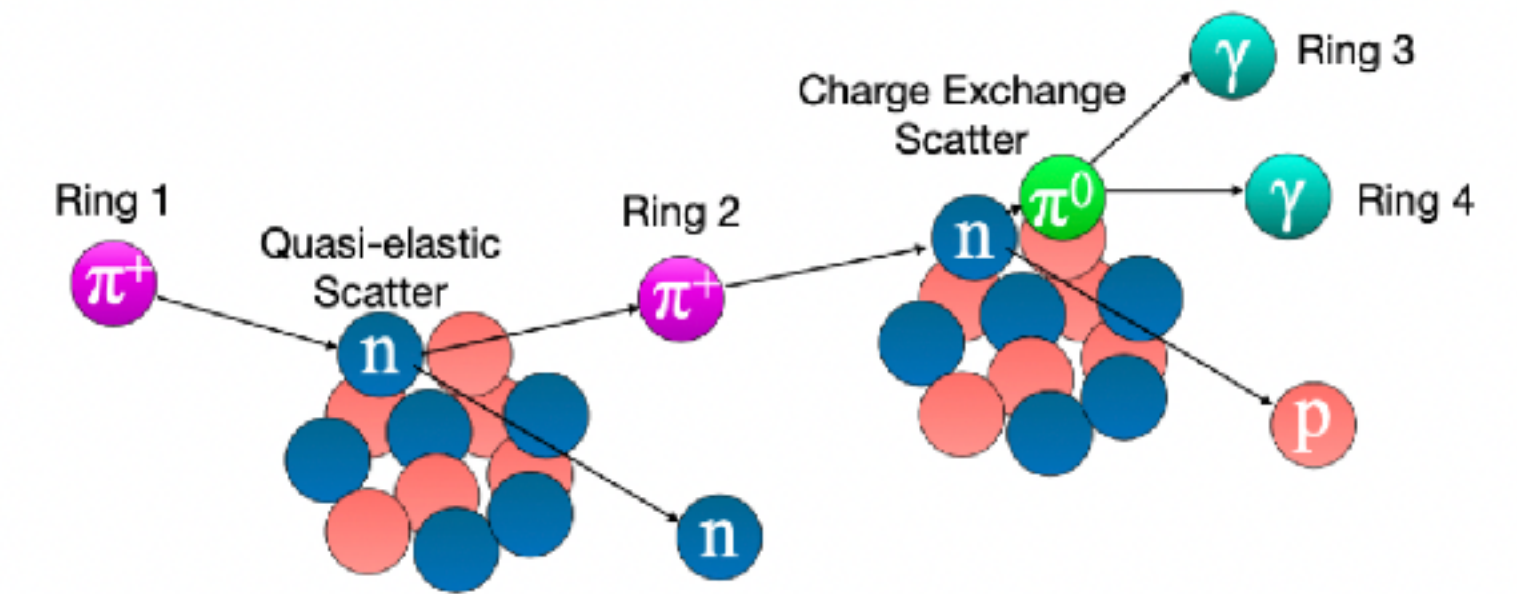

Neutron production in neutrino interactions

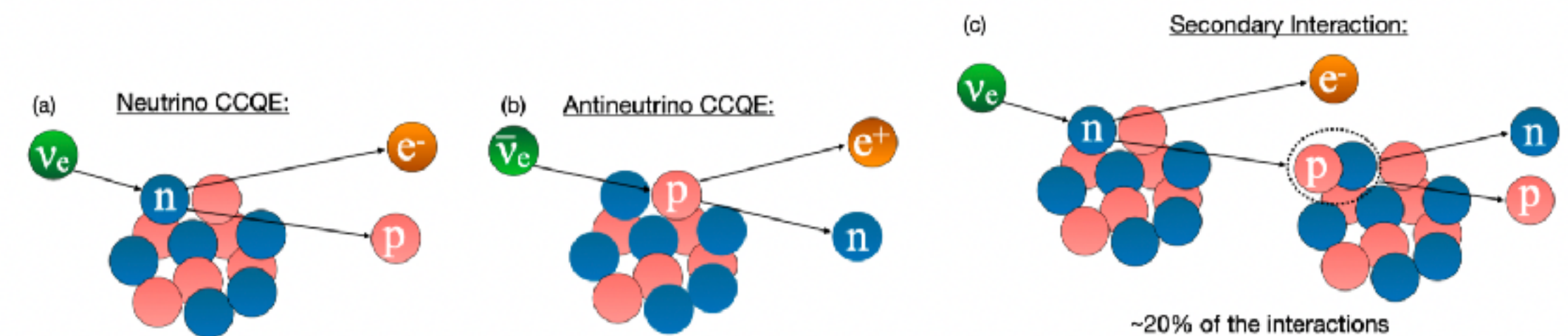

- Antineutrino interactions tend to produce neutrons, while neutrinos tend to produce protons
- Capability to tag antineutrinos vs. neutrinos with neutron detection is limited by secondary production of neutrons (right)
- WCTE will measure secondary neutron production

WCTE Physics

- Neutrino-nucleus scattering involves difficult to model effects such as multi-nucleon scattering (right)
- We can study the related processes of electron and muon scattering on nuclei in WCTE in order to constrain nuclear models
- Alternative approach to experiments with thin targets

Neutrino-nucleus scattering

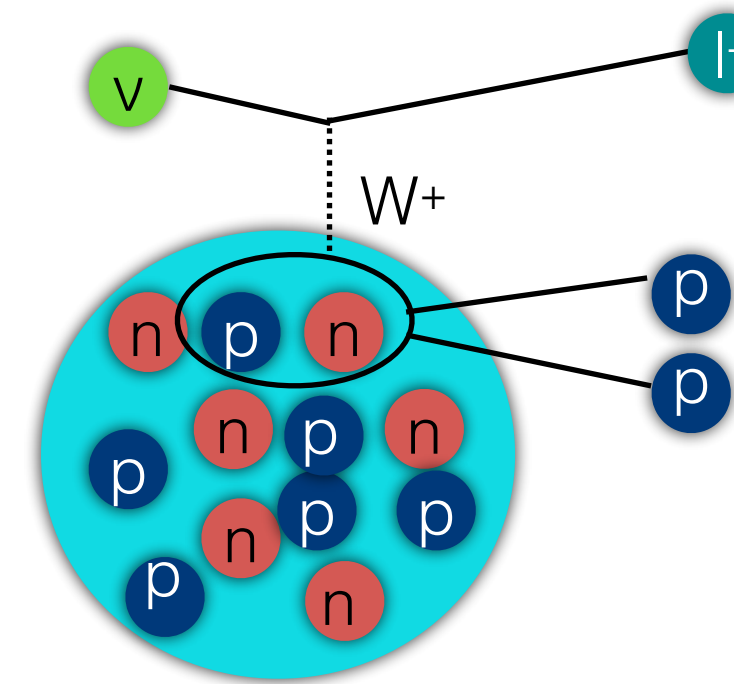

Electron/muon-nucleus scattering

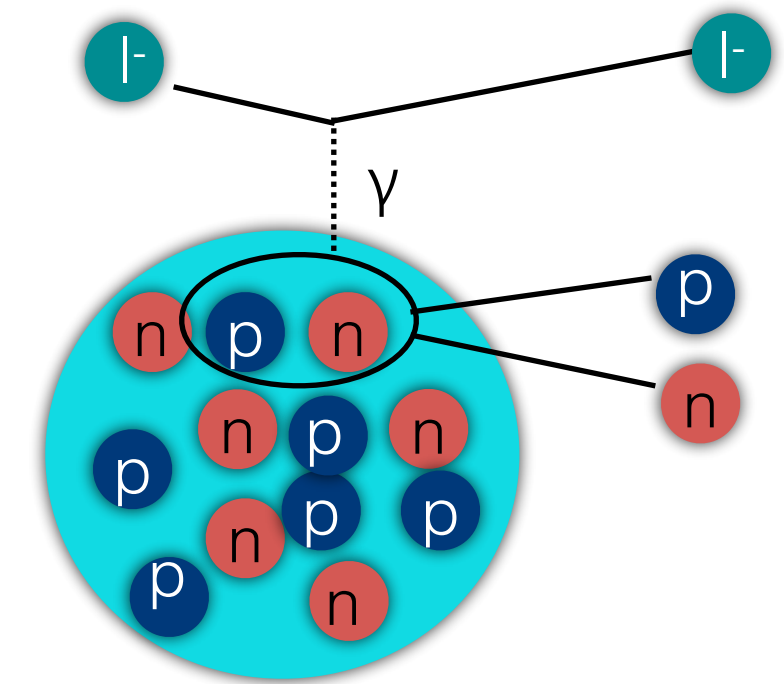

-
- Electrons are identified as “fuzzy” rings in WC detectors due to EM shower
 - High energy gammas can fake electron
 - WCTE will study capability to tag gammas by additional light produced by e+e- pair at beginning of shower
 - Gammas can also be used to study pion photoproduction, which is important for understanding gamma production through pion production in neutrino interactions
 - Requires tagged photon beam

Example electron ring in Super-K

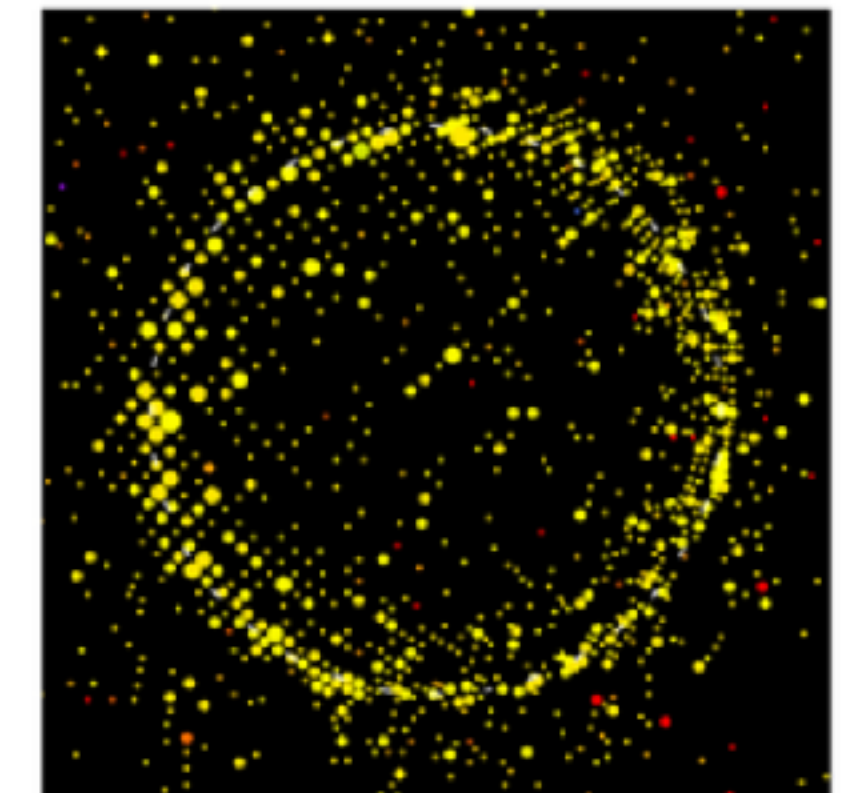

Tagged Gamma Test in 2023

- Source of gammas is Bremsstrahlung of beam positrons in scintillator T2
- Positrons deflected in 0.2 Tm magnetic field from Halbach array permanent magnet and detected in hodoscope
- Gamma energy inferred from positron energy loss
- Gammas detected in lead glass calorimeter
- Linear relationship of lead glass signal (gamma energy) and inferred gamma energy from positron deflection measured by hodoscope confirmed
- Independent check of gamma energy inference being prepared:
 - Measurement of positron momentum with magnet/hodoscope checked with low momentum beam
 - Measurement of lead glass calorimeter energy scale with electron and positron beams
- Paper under preparation

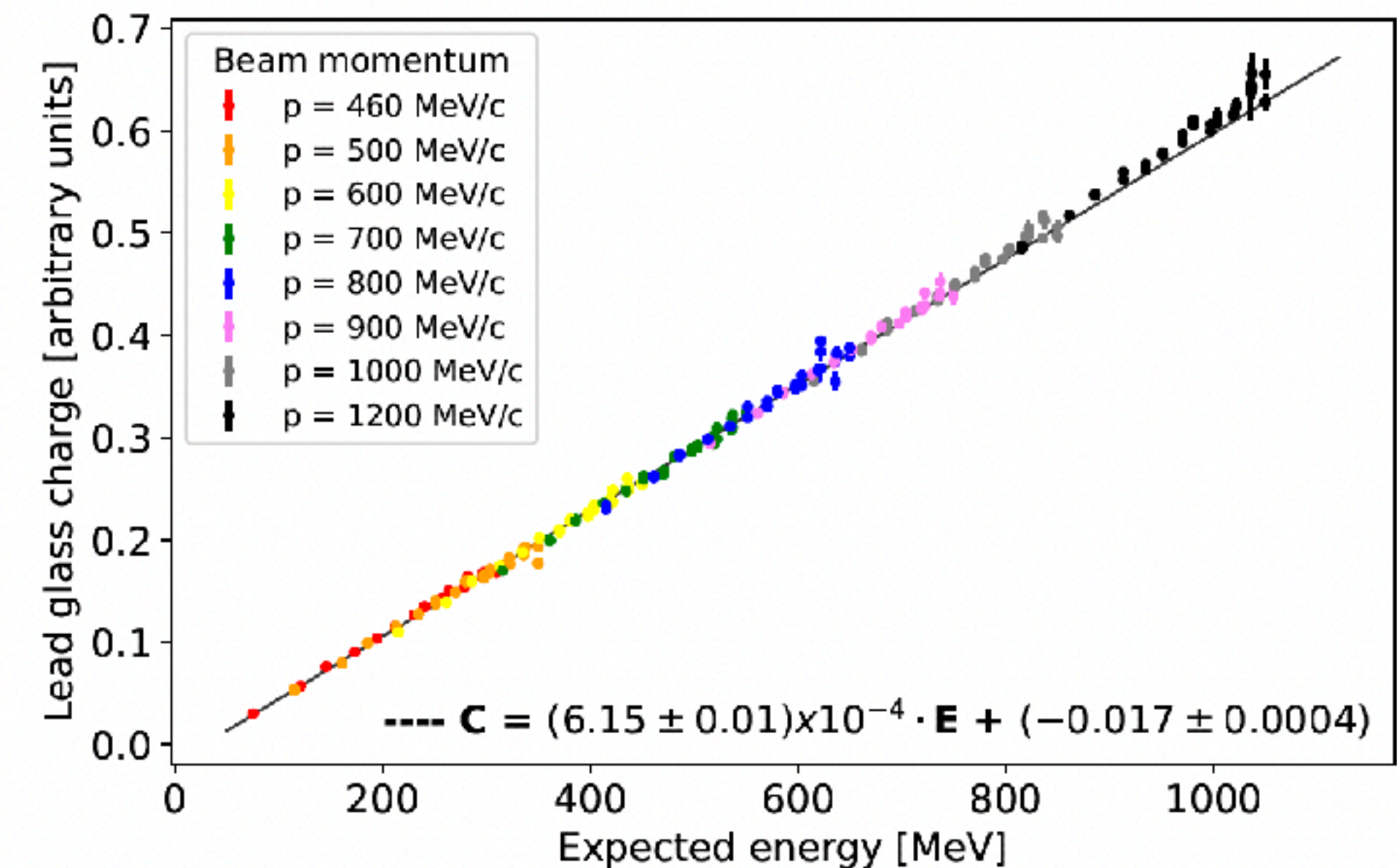
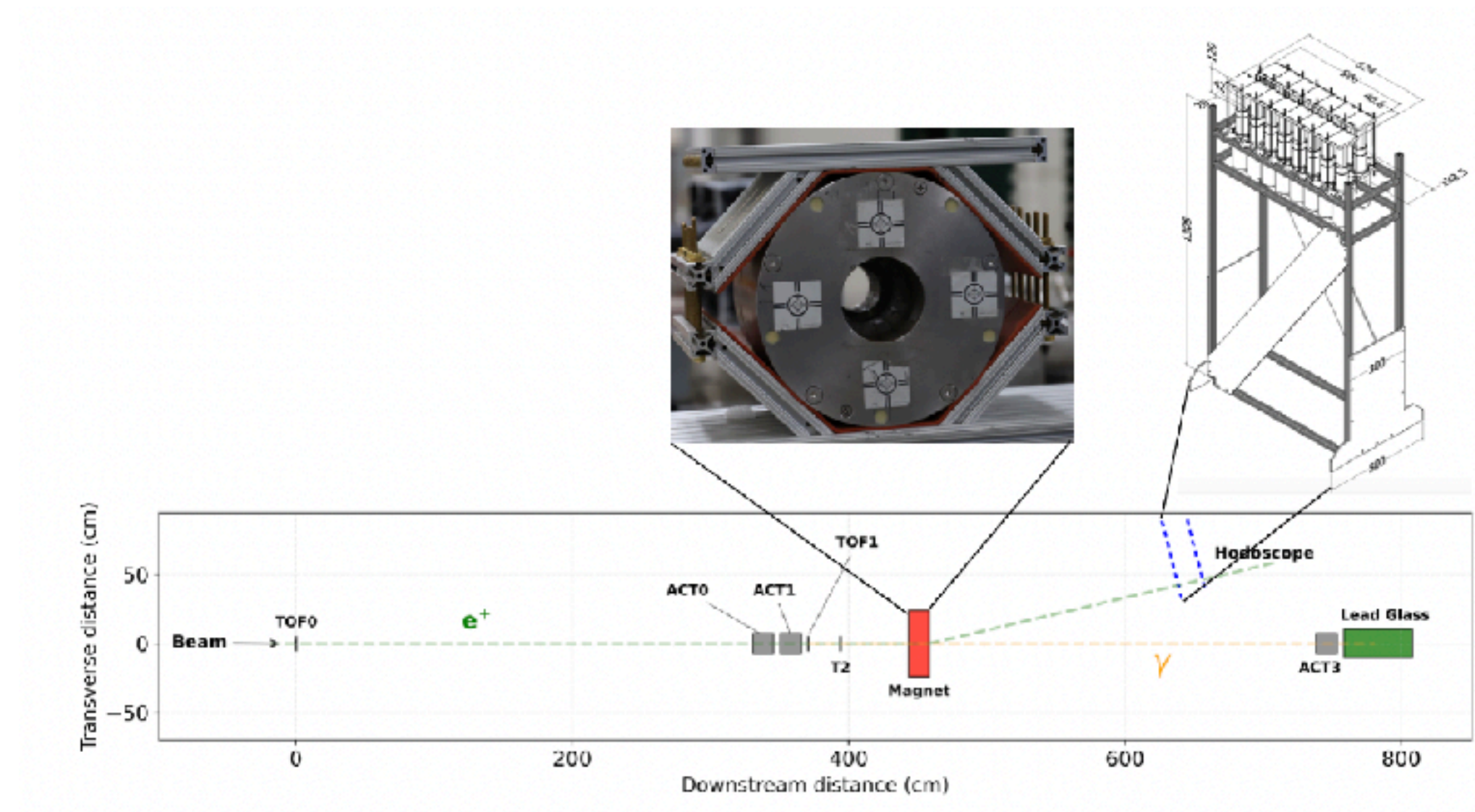

Charged Particle Data in 2023

- Upgraded Aerogel Cherenkov Threshold (ACT) detectors with two PMTs and improved photon collection used
- Good separation of particle populations observed at low momentum, but improvements are possible
- Found that below threshold particles producing some light in ACT proportional to dE/dx
 - Identified as scintillation in 3M ESR reflective material used (confirmed with timing distribution)
 - Being replaced with aluminized mylar
- Papers on beam monitor performance and particle rates being prepared

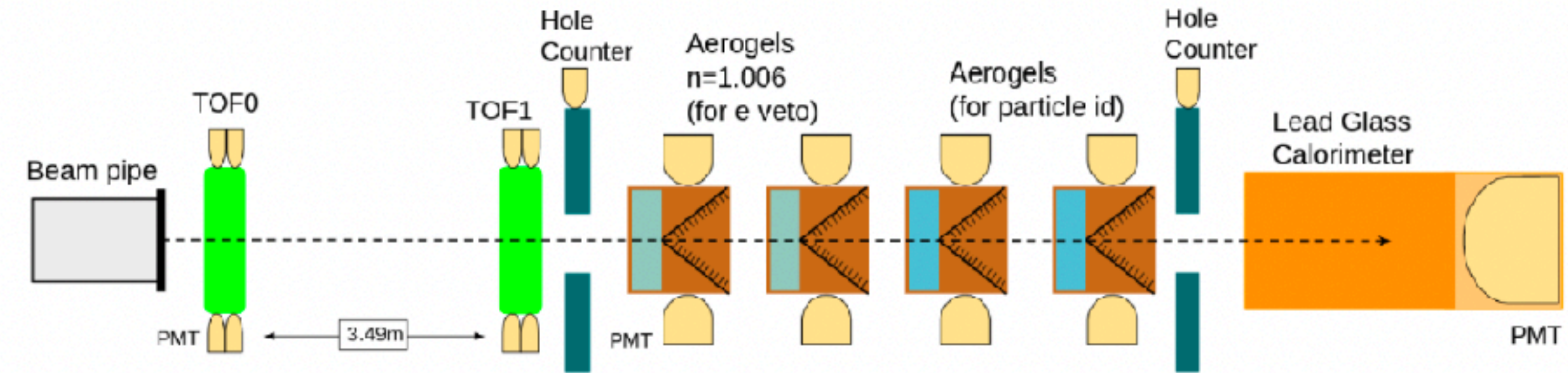

New ACT:

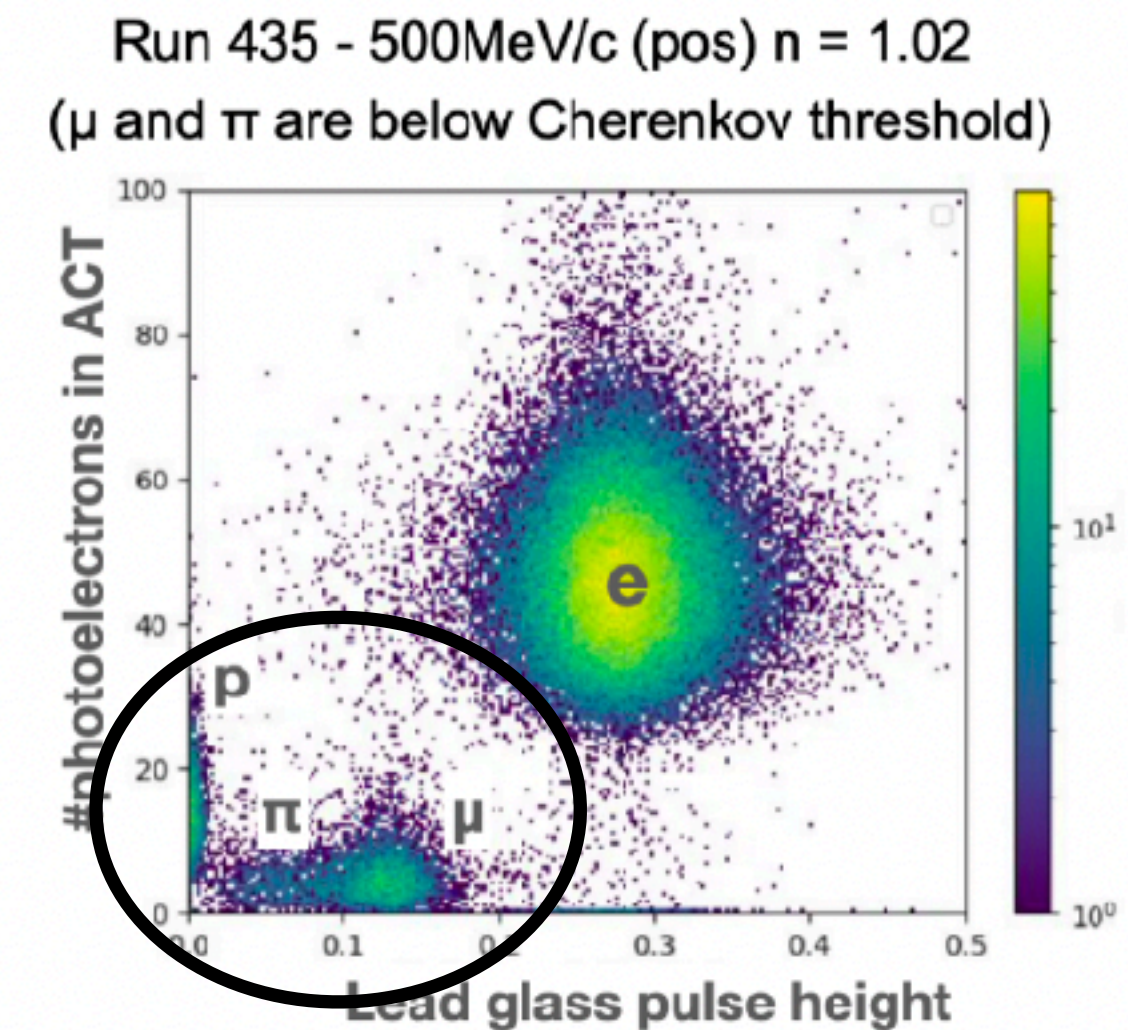
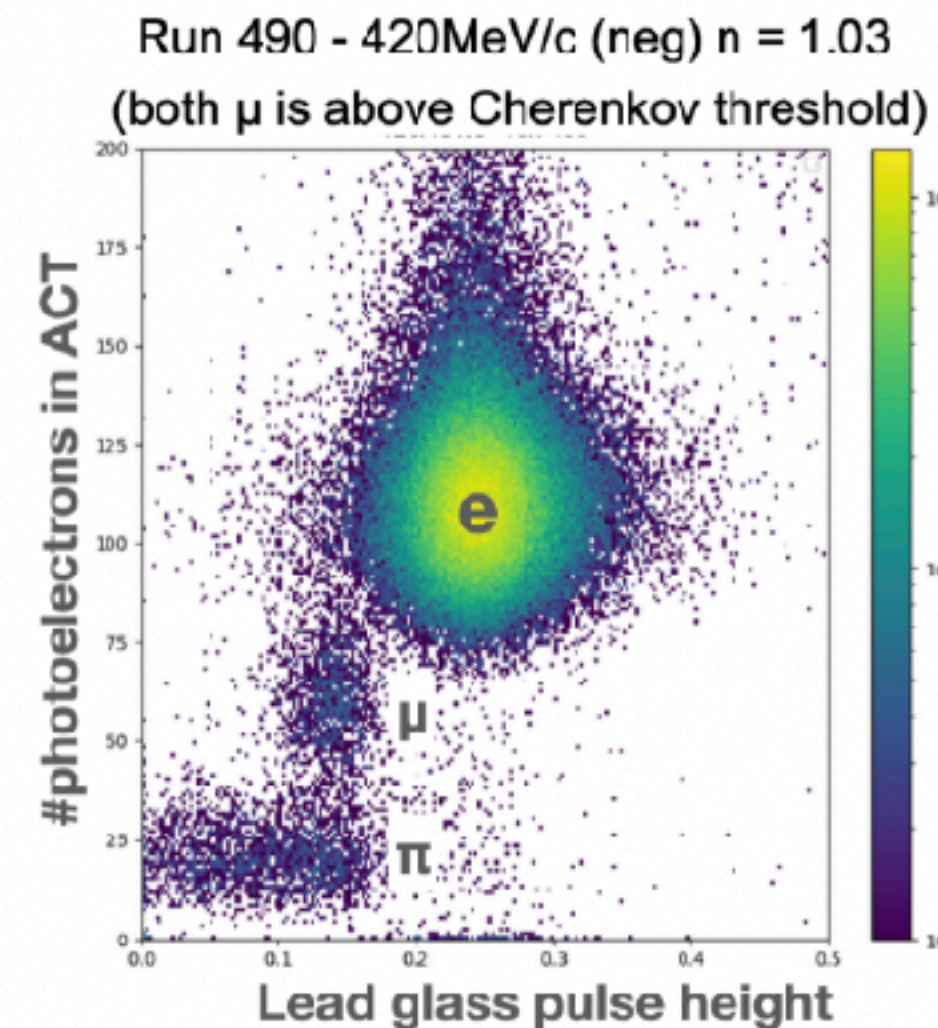
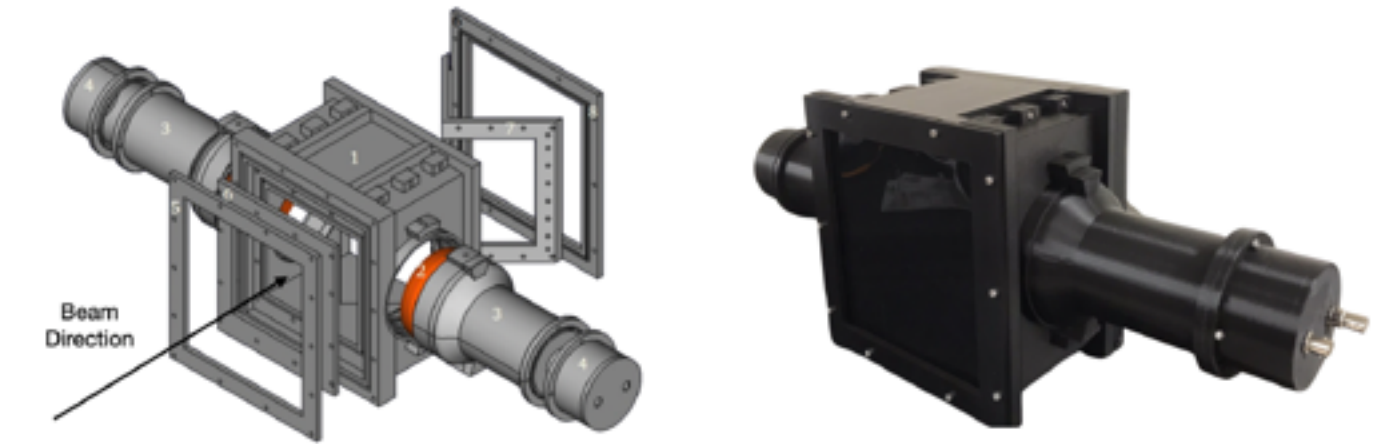

2024 Beam Monitor Plan

- Will replace ACT reflector as previously discussed
- Number of ACT for each aerogel index increased from 2 to 3 to increase light detection
- Radiator and magnet will be placed on stand (upper right) so we can switch between tagged gamma and charged particle configurations by raising/lowering DESY table
- New time-of-flight (TOF) scintillator detectors with light detection by 16 SiPMs are being built
 - Expected timing resolution improvement to 100 ps

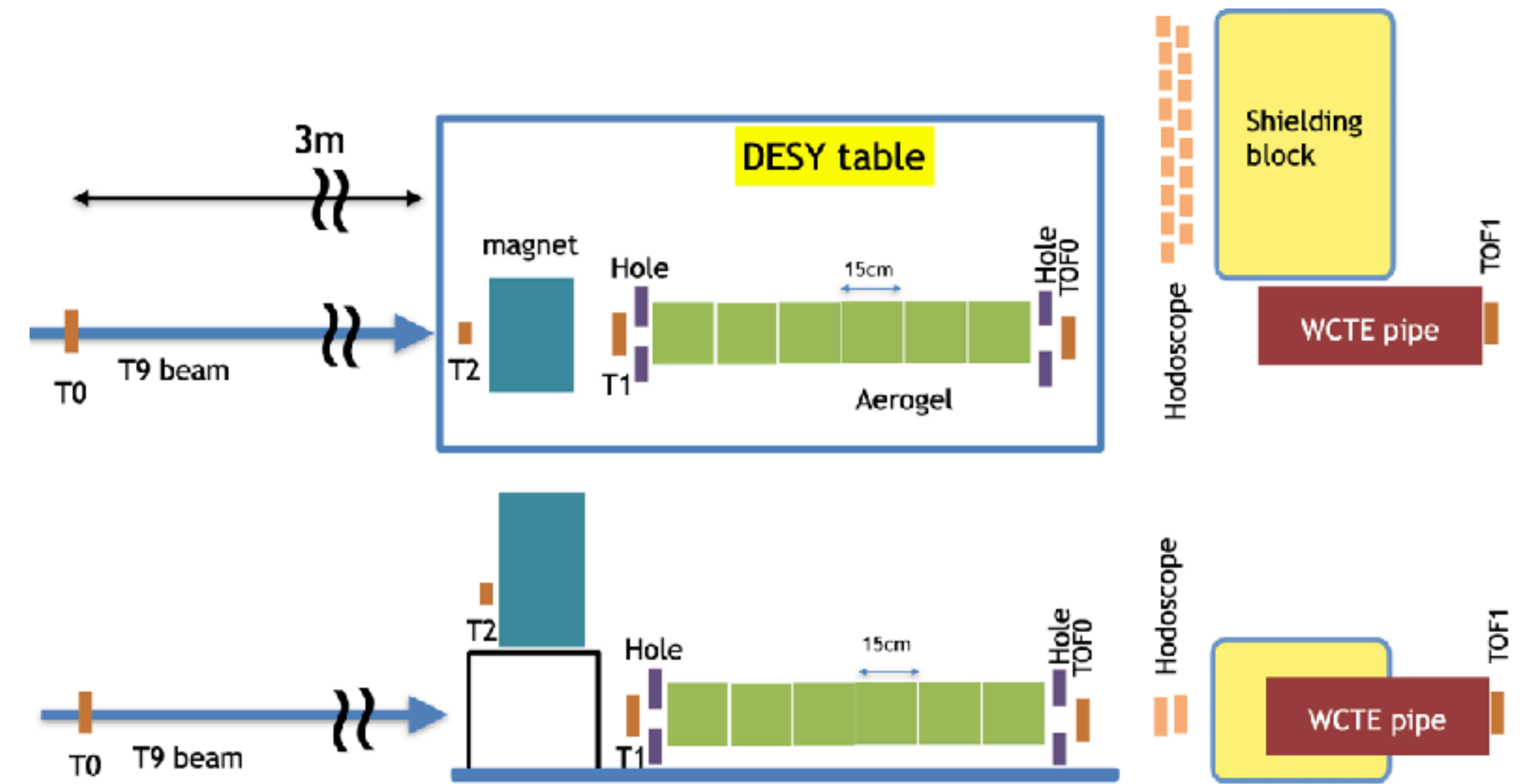

TOF detector:

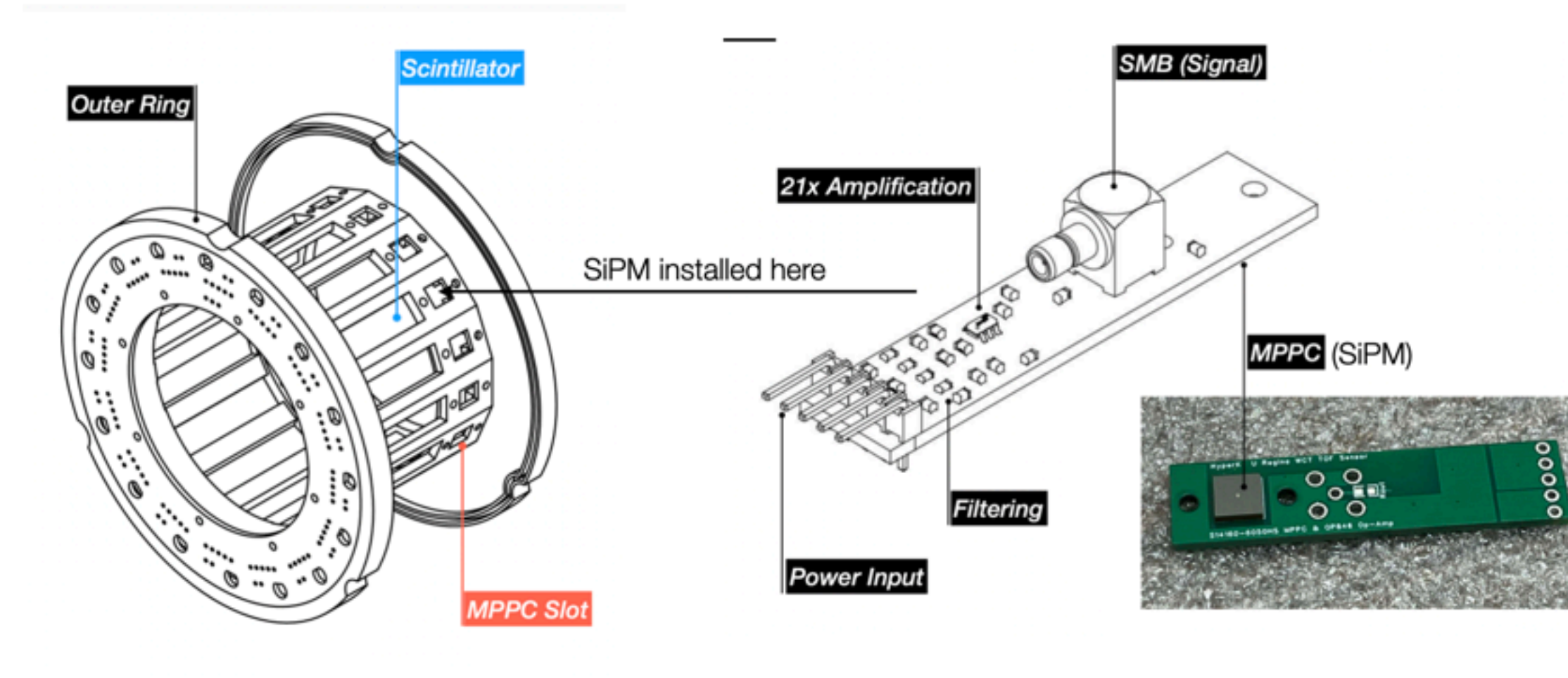

Tank and Support Structure Status

- The WCTE tank is being built by Laboratorio Subterráneo de Canfranc (LCS)
- There were some delays to update the tank design so that it could be used in the Canfranc mine
- The design is now updated and with CERN mechanical safety sign-off to go to tender
- Tender process is ongoing with expected delivery by week 37 (Sept 11)
- Fabrication of the support structure is started
- Expected delivery of support structure at the end of May

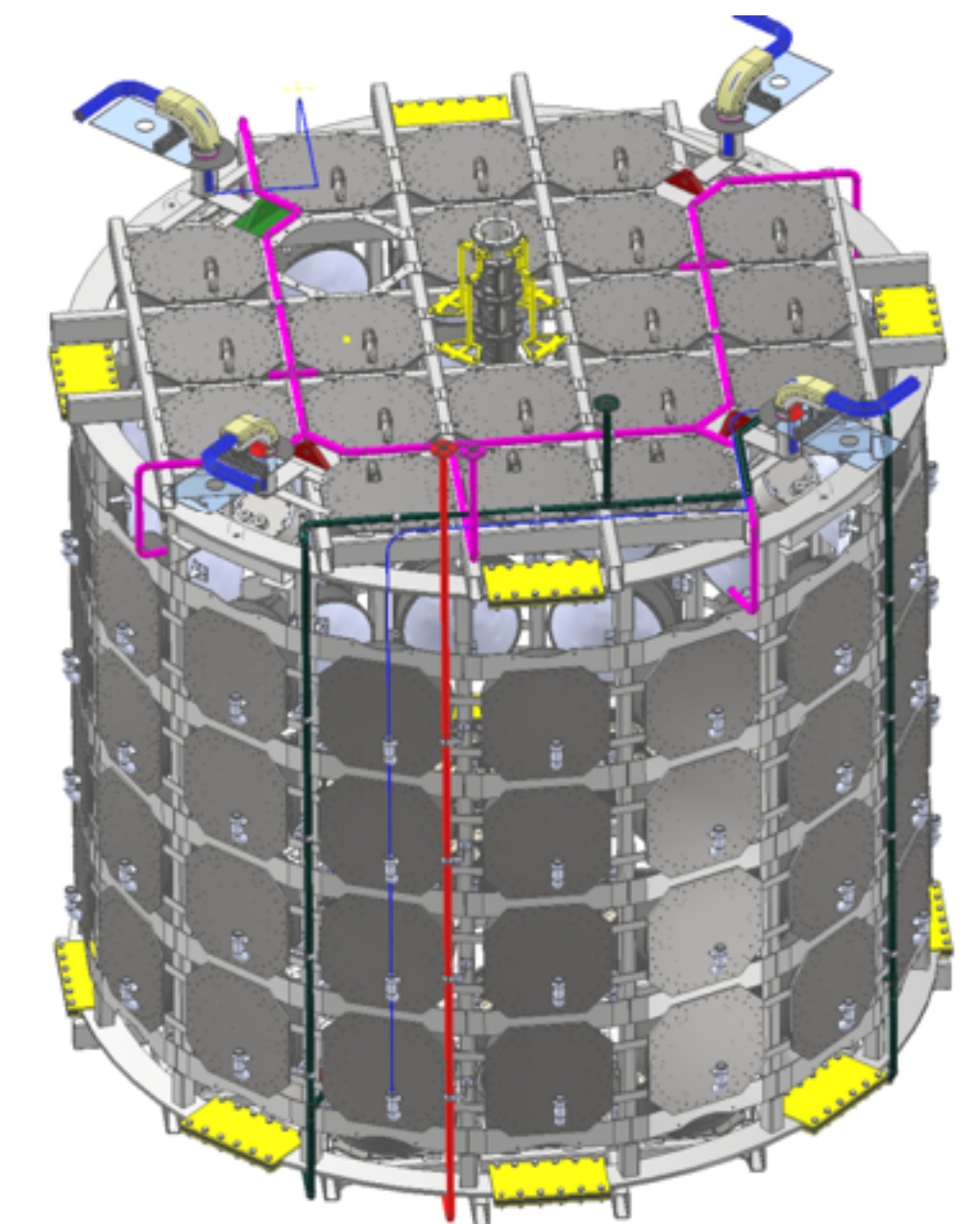
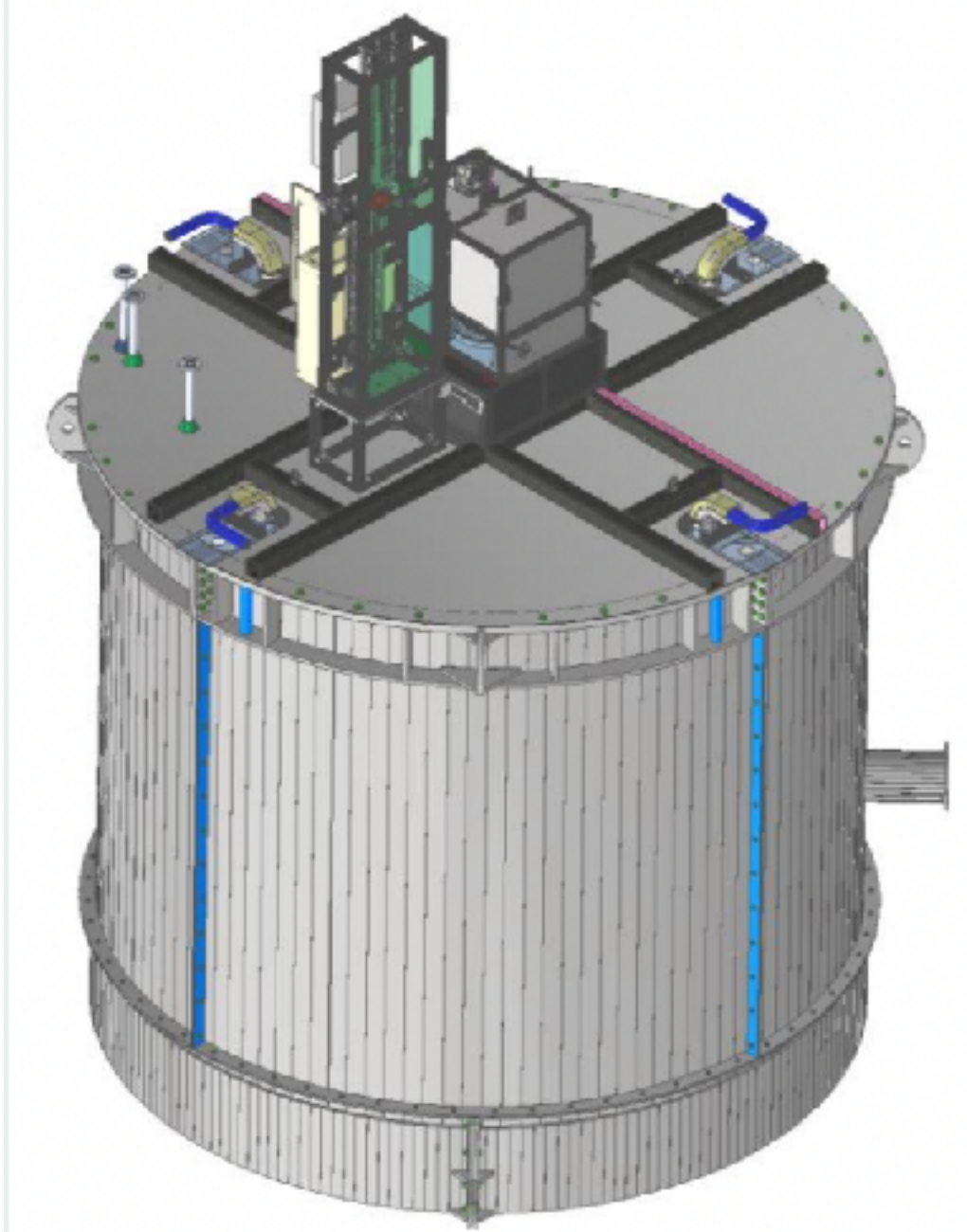

Beam Pipe Status

- Allows for transport through air of the beam particles into the active area of the detector
- Second TOF detector will be inserted into the beam pipe
- Beam pipe is being fabricated by Donostia International Physics Center (DIPC)
- Two designs for the end of the beam pipe have been considered, including one with a machined curved edge between window and pipe
- Buckling analysis and steady-state structural analysis done and results being reviewed
- Expect design decision within this week

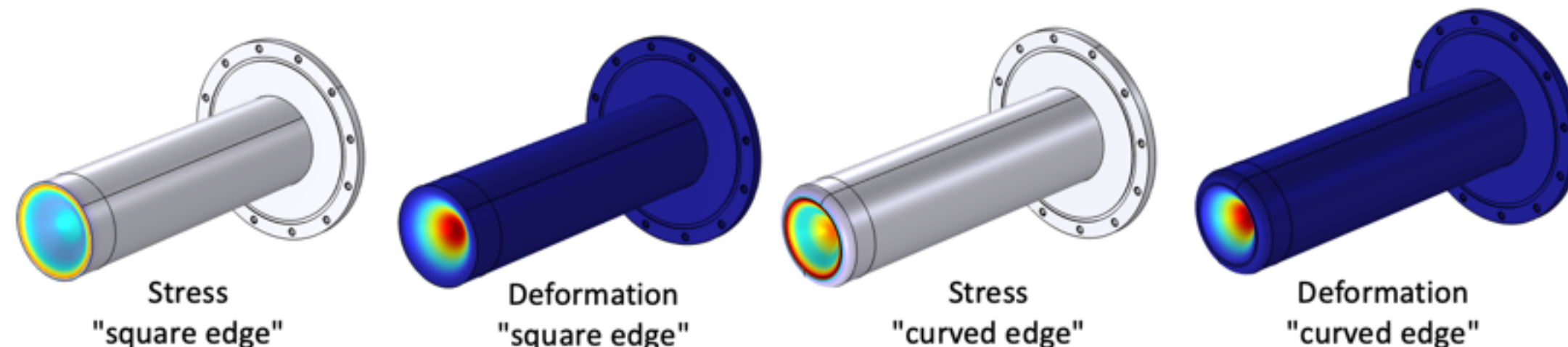
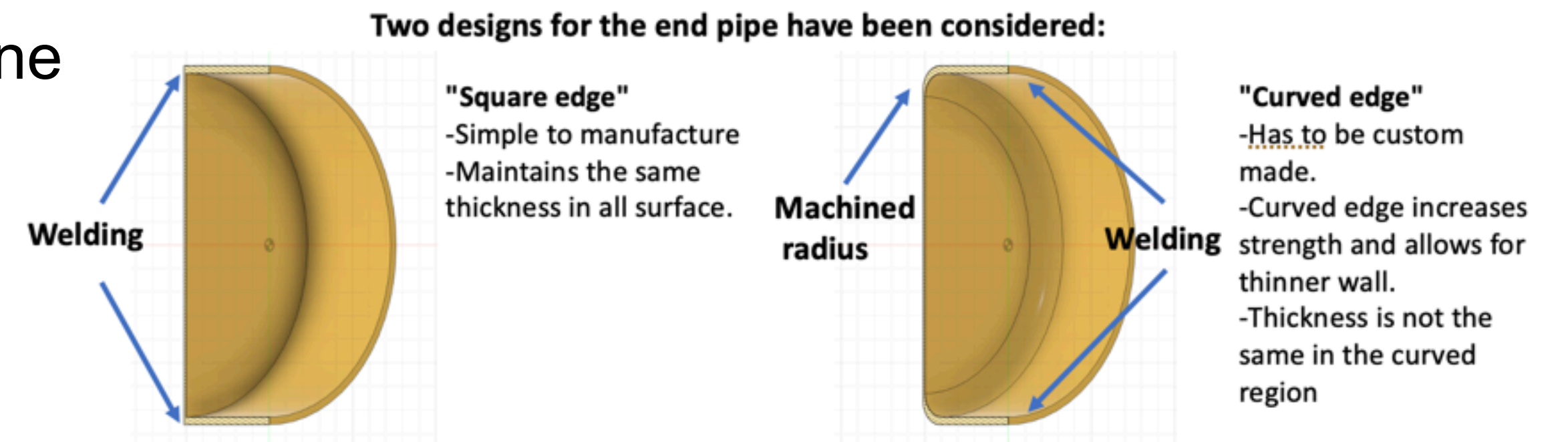
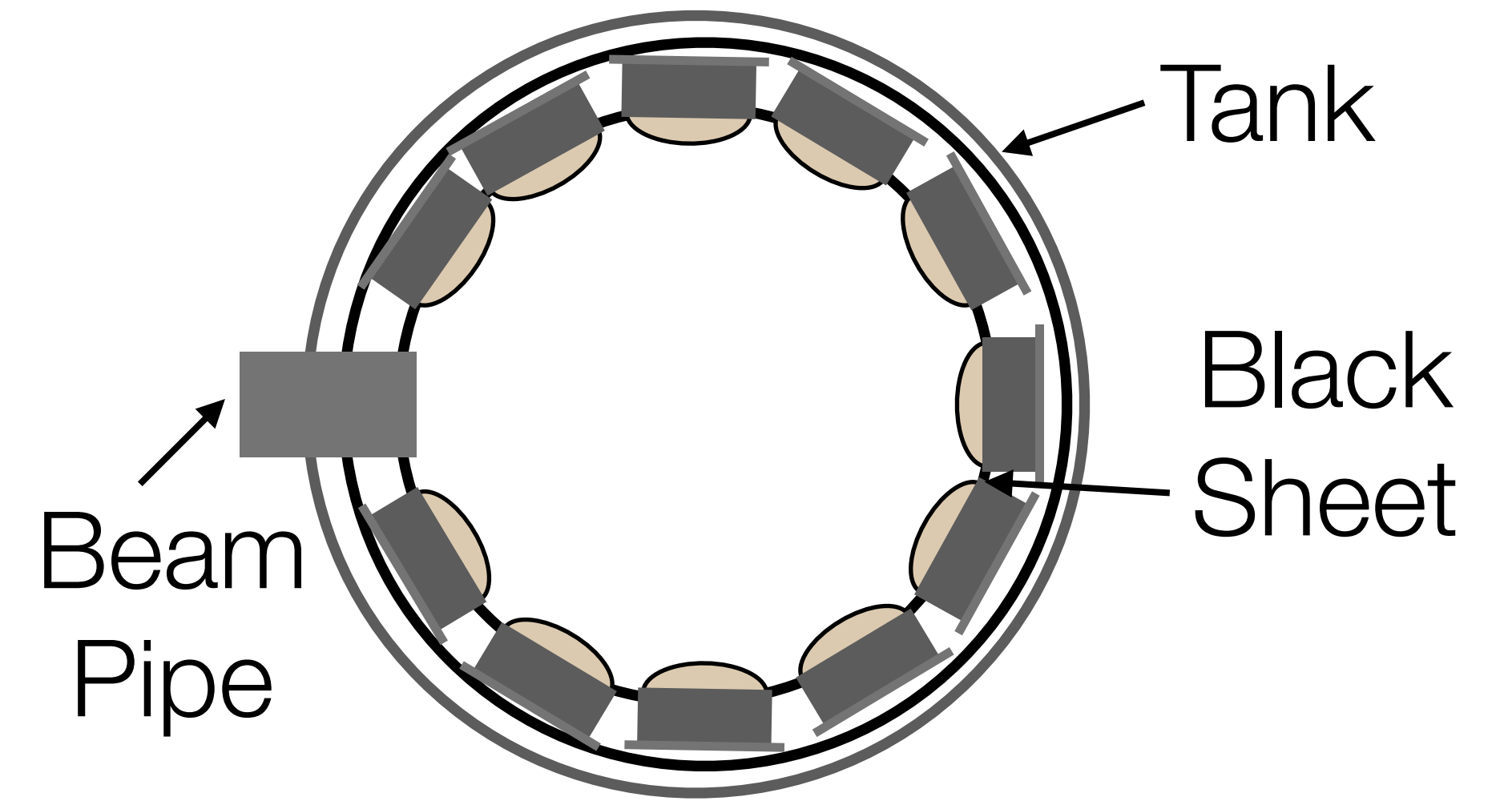

Multi-PMT Status

- Multi-PMT production for WCTE is proceeding with two assembly methods shown on right
 - Valuable experience being gained that will be applied to IWCD/Hyper-K
- 54 produced and 34 have passed QC
 - Most that haven't are in the process of being tested
 - 2 failed QC due to one bad channel (may use as is)

Ex-situ Gelling Assembly

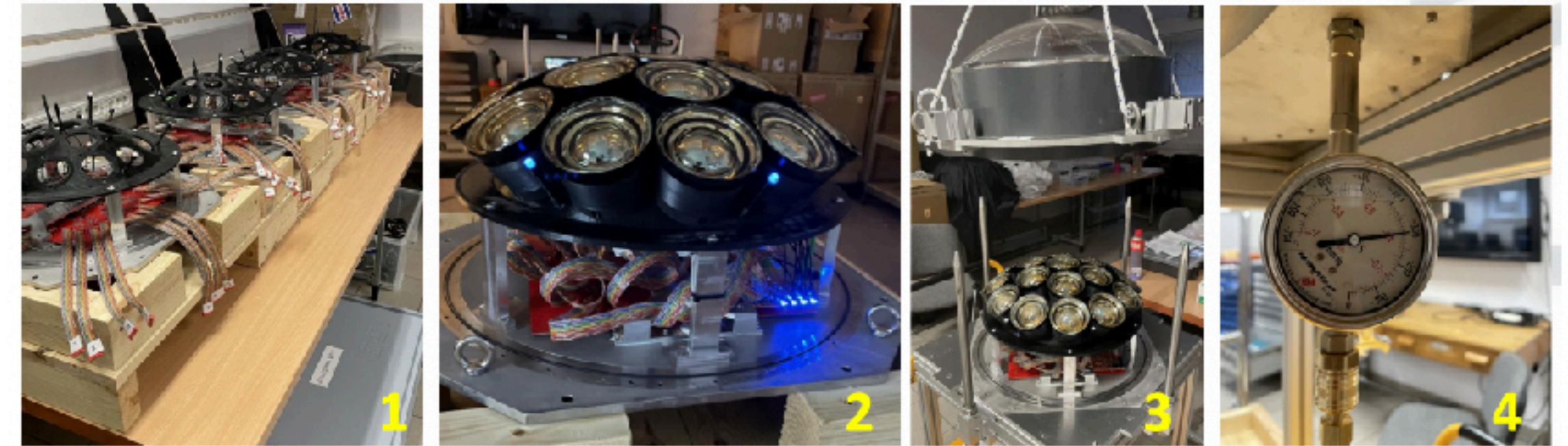

In-situ Gelling Assembly

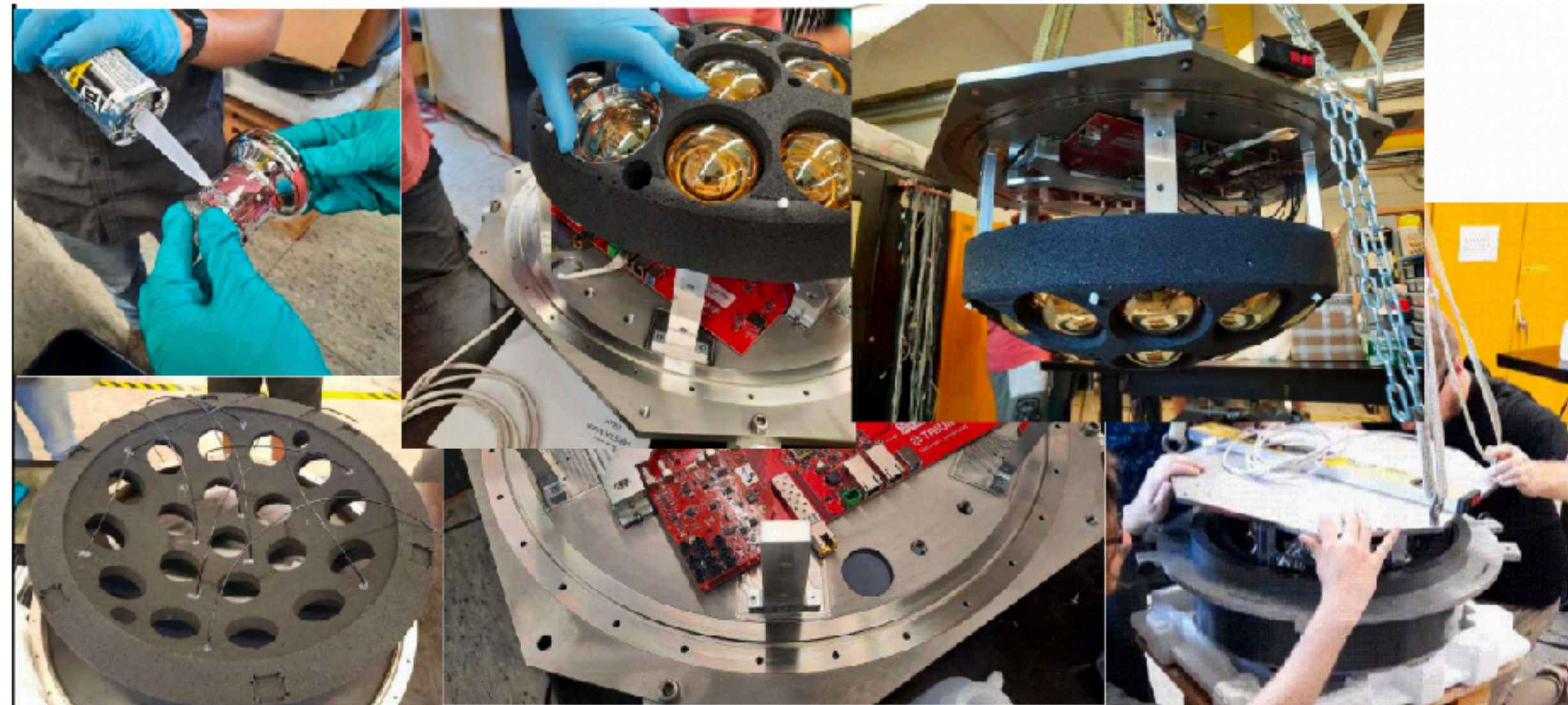

Status of Production (WUT+TRIUMF)

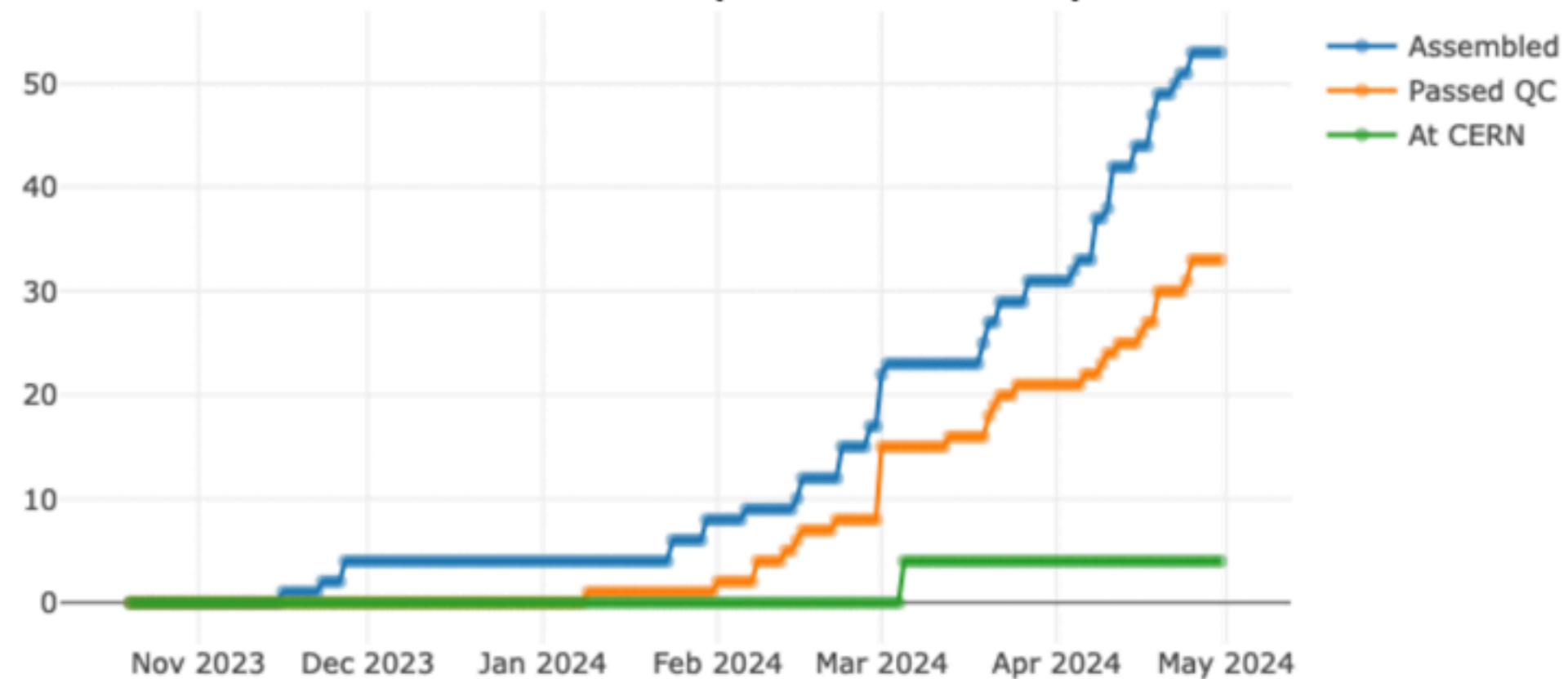

Data Acquisition

- Beam monitors, multi-PMTs and slow control will be integrated into a single DAQ system based on ToolDAQ software
- Computers and switches for DAQ are ready
- Integration tests of mPMTs with DAQ in Poland and Canada are started and planned respectively
- Testing of beam monitor digitization and triggering has started
- MCC board (interface to mPMTs) design is fixed, prototypes have been produced.
- Firmware development is proceeding and we expect to be able to test the MCC by the end of May.

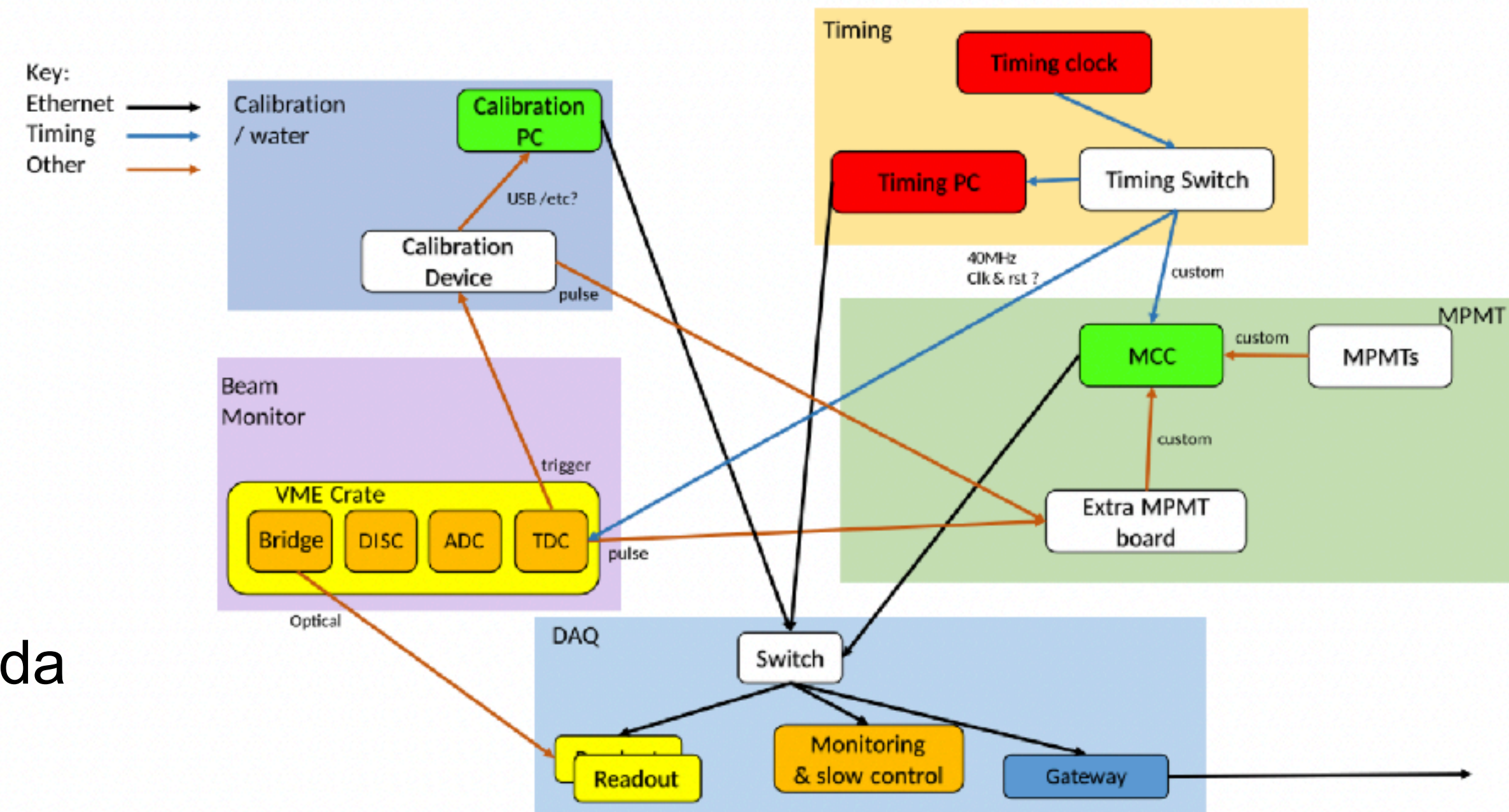

Water System and Assembly Plan

Three main sections concerned:

1. Staging Area, 157-R-H30 (yellow fenced)
 - a. **Purification system (PUR):** Delivered on **April 8, 2024**
 - Control panel delayed to **early May**; followed by CERN electrical inspection
 - b. **Chiller:** CERN EN-CV investigating rental options vs US company, to be delivered by **~September 2024**
 - c. **Gd removal and mixing tanks:** Delivered and tested **August 2023**
2. Water transport piping
 - a. Piping between PUR and Gd tanks planned with **CERN EN-CV** on March 28, 2024, **to be completed in ~May**
 - b. Piping from Staging Area to detector in T9 Beam Area, **to be completed by CERN EN-CV soon**
3. Detector piping and instrumentation
 - a. Piping design finalized by WCTE collaboration; **EN-CV** expressed possibility to fabricate and assemble; need to integrate and coordinate with detector assembly **during summer 2024**

1a) Purification System



2) Transport Piping

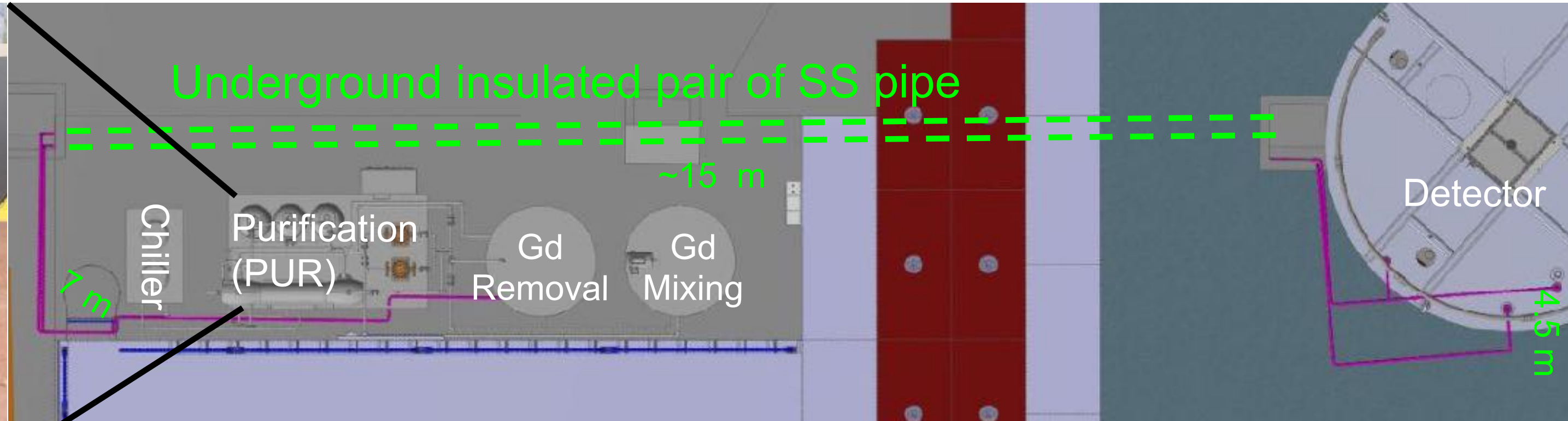

3) Detector

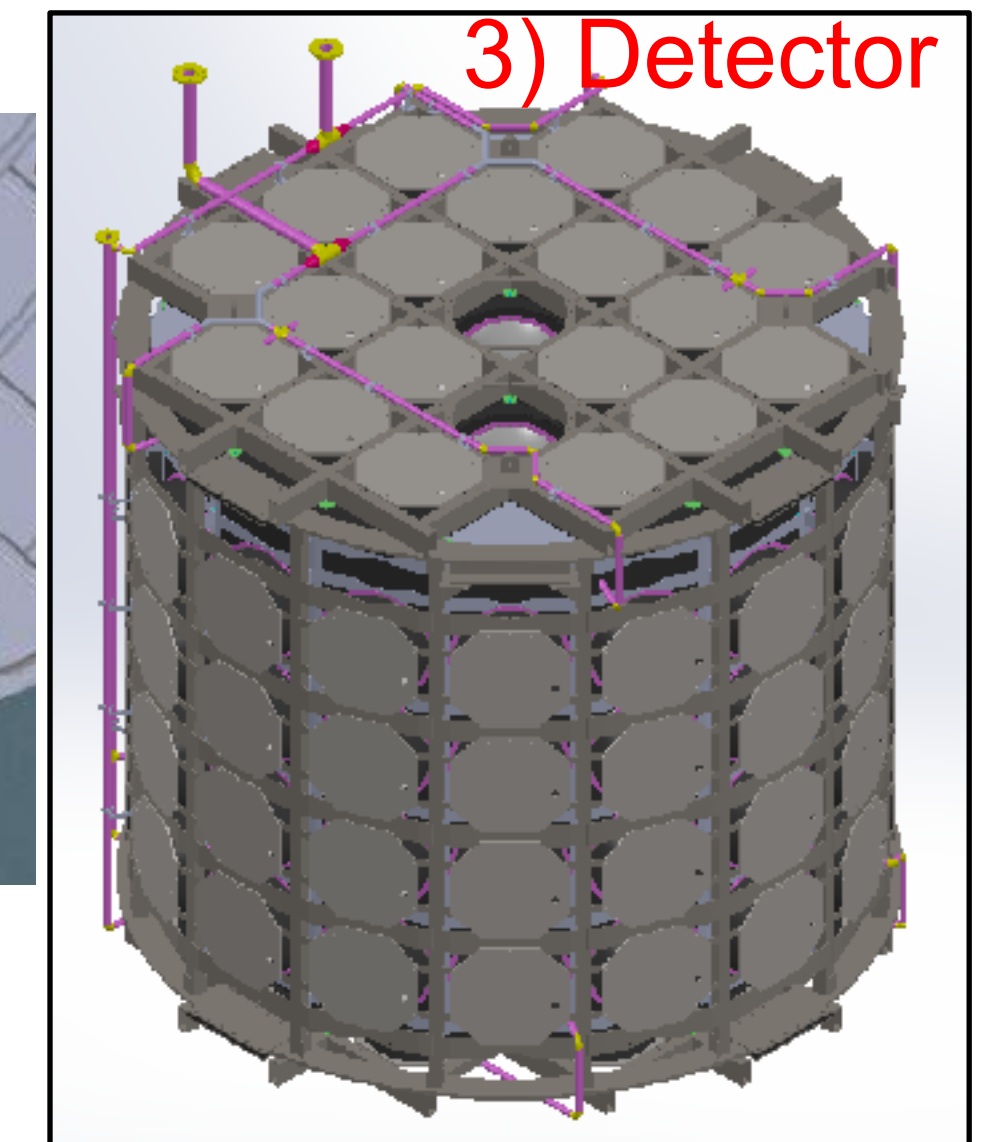

Calibration

- CDS was tested full scale between Feb 7th and April 10th 2024 in B157 (East Hall)
- To be rebuilt and tested at Imperial over the next month
 - Further work on software
 - Reproducibility tests
- Implement some electronics changes requested by CERN safety team
 - Ensure all relevant components are IP2X protected e.g. heat shrink all wired connections where possible
 - Install an isolator as well as the (already existing) e-stop
- Photogrammetry camera assemblies nearly complete
- NiCf source Ni-epoxy ball being machined and Cf source ordered
- Water quality monitor being tested at TRIUMF

CDS Test East Hall

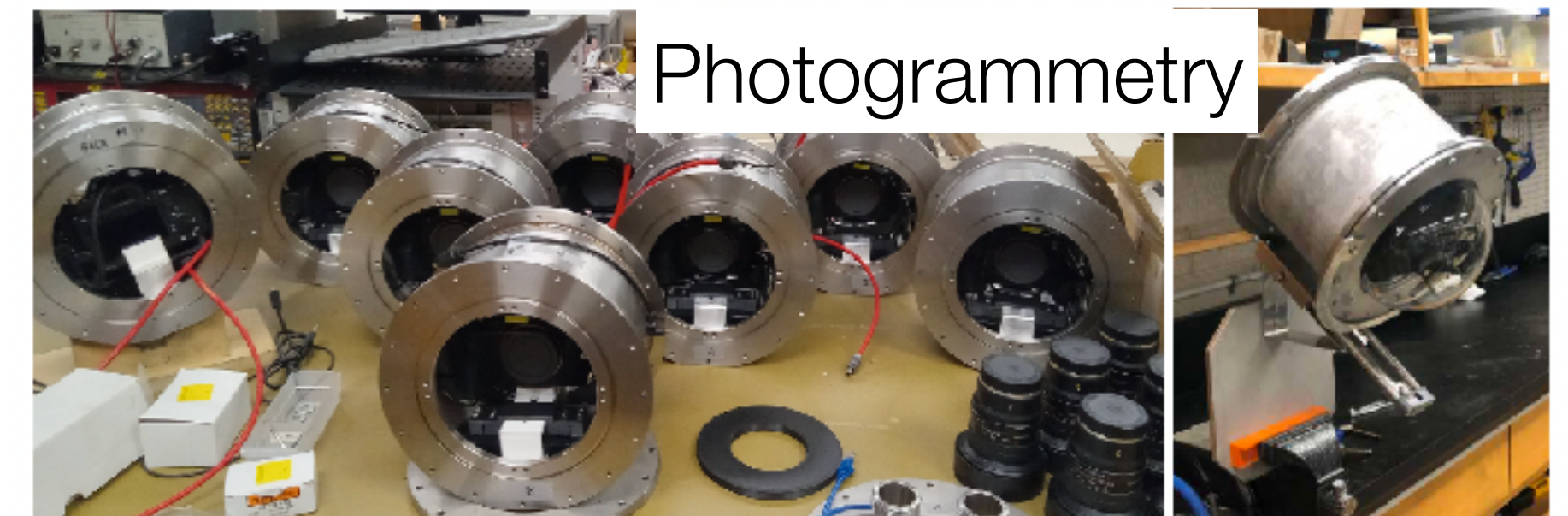

Ni-Epoxy Ball



Water Quality Monitor

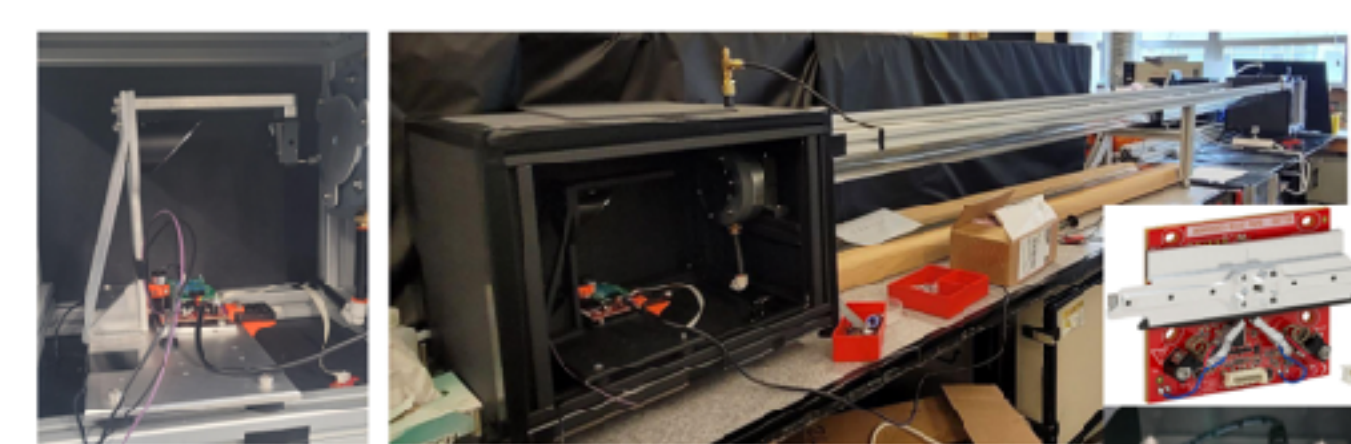

Schedule Modification Proposal

- WCTE installation proposed for week 38, followed by 3 weeks of parasitic operation
- WCTE has proposed schedule modification based on two main factors:
 - Expected delivery of tank in week 37 leaves no contingency or time for acceptance tests
 - Risk that installation in T9 not completed in 1 week, making parasitic operation period ineffective
- HIKE, NANOCAL and STRAW TRACKER move 1 week forward, back to the weeks where they were originally scheduled
- WCTE installation is moved to week 41 and we go directly from installation into the WCTE beam period, which will include some commissioning activities

[DRAFT] Schedule Runs PS / East Area 2.0.0 :: Status 2024-04-29 17:00 (UTC)

Calendar Months /		March			April			May			June			July			August			September			October			November																			
Weeks (Mon-Mon)		CW 12	CW 13	CW 14	CW 15	CW 16	CW 17	CW 18	CW 19	CW 20	CW 21	CW 22	CW 23	CW 24	CW 25	CW 26	CW 27	CW 28	CW 29	CW 30	CW 31	CW 32	CW 33	CW 34	CW 35	CW 36	CW 37	CW 38	CW 39	CW 40	CW 41	CW 42	CW 43	CW 44	CW 45	CW 46	CW 47	CW 48							
Weeks (Wed-Wed)		Week 12	Week 13	Week 14	Week 15	Week 16	Week 17	Week 18	Week 19	Week 20	Week 21	Week 22	Week 23	Week 24	Week 25	Week 26	Week 27	Week 28	Week 29	Week 30	Week 31	Week 32	Week 33	Week 34	Week 35	Week 36	Week 37	Week 38	Week 39	Week 40	Week 41	Week 42	Week 43	Week 44	Week 45	Week 46	Week 47	Week 48							
PS(EA)	T8	IRRAD CHARM 234d																																				CHIMERA DRAFT 21d							
	T9	Main	SHIP 19d	CMS BRIL 7d	LHCB ECAL 7d	PAN 14d	STRAW TRACKER RD 7d	RE44 HERD 7d	VLAST 14d	E+BOOST 14d	OREO 7d	CALICE SCW AHCAL 14d	MPGDCA 7d	CMS BRIL 7d	STCF ECAL & PID 14d	NP06 ENUBET DRAFT 14d	EIC ePIC DRAFT 7d	SHIP DRAFT 7d	SHIP DRAFT 7d	HIKE SAC DRAFT 7d	NANOCAL DRAFT 7d	STRAW TRACKER RD DRAFT 7d	WCTE DRAFT 42d																						
		No Beam	TS1																																										
	T10	Main	ALICE ITS3 5d	ALICE ITS3 14d	ALICE ITS3 7d	ALICE TOF 7d	ALICE TIMING 7d	MEDIPIX 7d	ALICE ITS3 7d	EIC DRICH 14d	ALICE ITS3 7d	ALICE TOF 10d	ALICE TIMING 14d	IDEA CC 14d	BL4S 7d	ALICE ITS3 7d	ALICE ITS3 DRAFT 7d	ALICE ITS3 DRAFT 7d	BL4S DRAFT 14d	ALICE RICH DRAFT 14d	ALICE TIMING DRAFT 14d	ALICE MUON ID DRAFT 7d	NP07 HATPC DRAFT 14d	LHCB DRAFT 14d																					
	Parallel	ALICE FOCAL 5d	ALICE FOCAL 7d																																		ALICE FOCAL 7d	TS1	ALICE FOCAL 7d	ALICE FOCAL 7d	ALICE FOCAL DRAFT 7d	ALICE FOCAL DRAFT 7d	ALICE FOCAL DRAFT 7d	RE7 GAMMA MEV DRAFT 14d	ALICE MUON ID DRAFT 7d
T11	Main	P349 7d																																		CLOUD 42d									
No Beam	TS1																																												
PS(NTOP)	TT42	n TOF 245d																																											

WCTE Operation During Beam Time

Water Type	Beam Type	Beam Momentum	Key Measurement	Days
Pure	Charged Particle	Low	Particle discrimination	26
Pure	Charged Particle	High	Lepton scattering	10
Pure	Tagged Gamma	—	Electron/gamma discrimination	2
Gd loaded	Charged Particle	Full Range	Neutron production	7
Gd loaded	Tagged Gamma	—	Photo-nuclear π^0 production	14

- Plan pure-water operation in 2024
- Some time will be needed for commissioning and confirming detector operation
- Will carry out as much of the pure water program as possible in 2024
- Plan beam request for 2025 based on results from 2024
 - Will likely request first beam slot so WCTE can remain in T9

Layout in East Hall for Installation

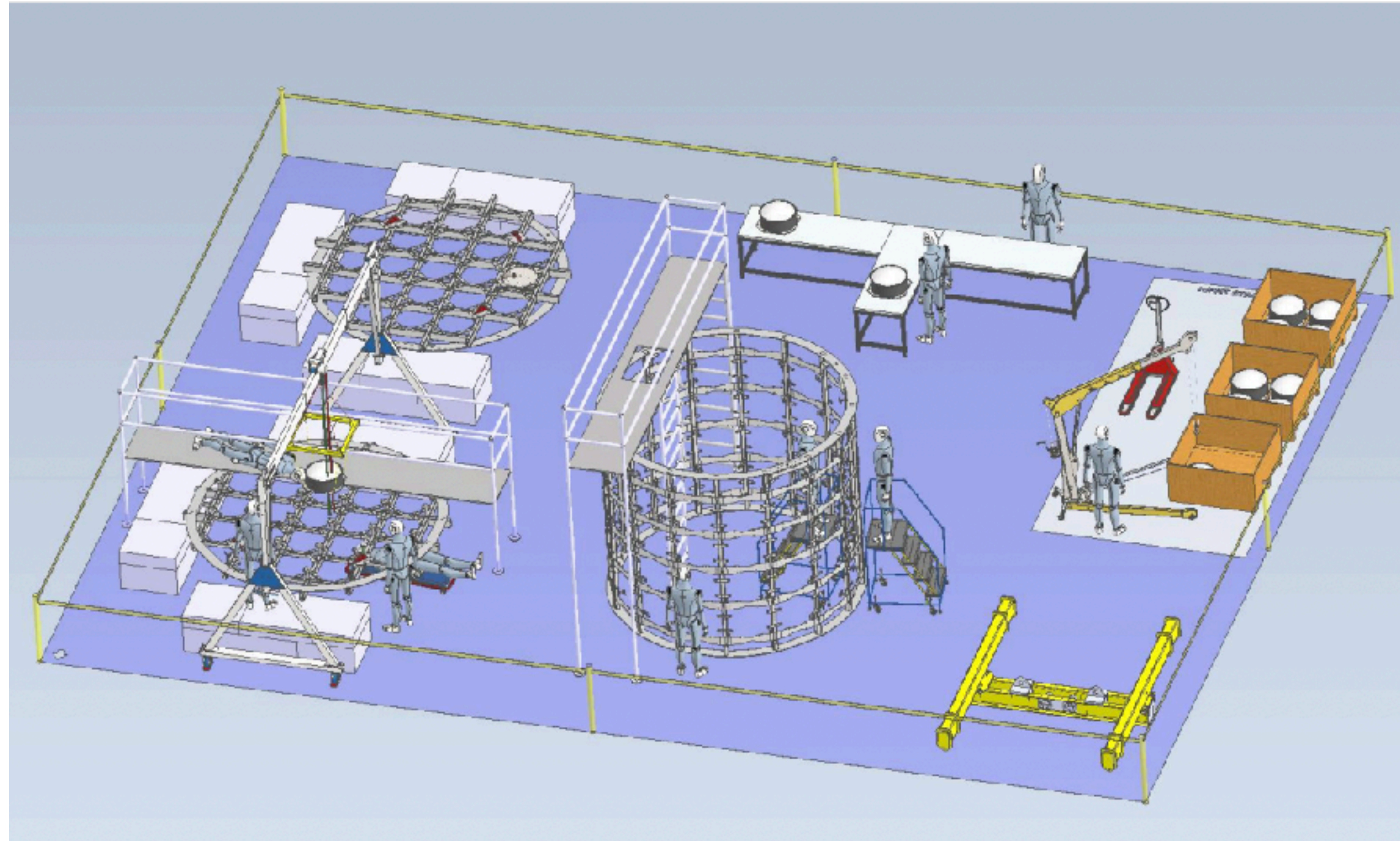

- WCTE will be assembled in the East Hall
- This layout shows manual A-frame crane, but we now plan to use overhead crane in East Hall to lift mPMTs and install them on structure
- 4 people working together will be required for the for the mPMT installation
- Detailed assembly plan document is being written and we expect to release by week of May 13

WCTE Assembly Schedule

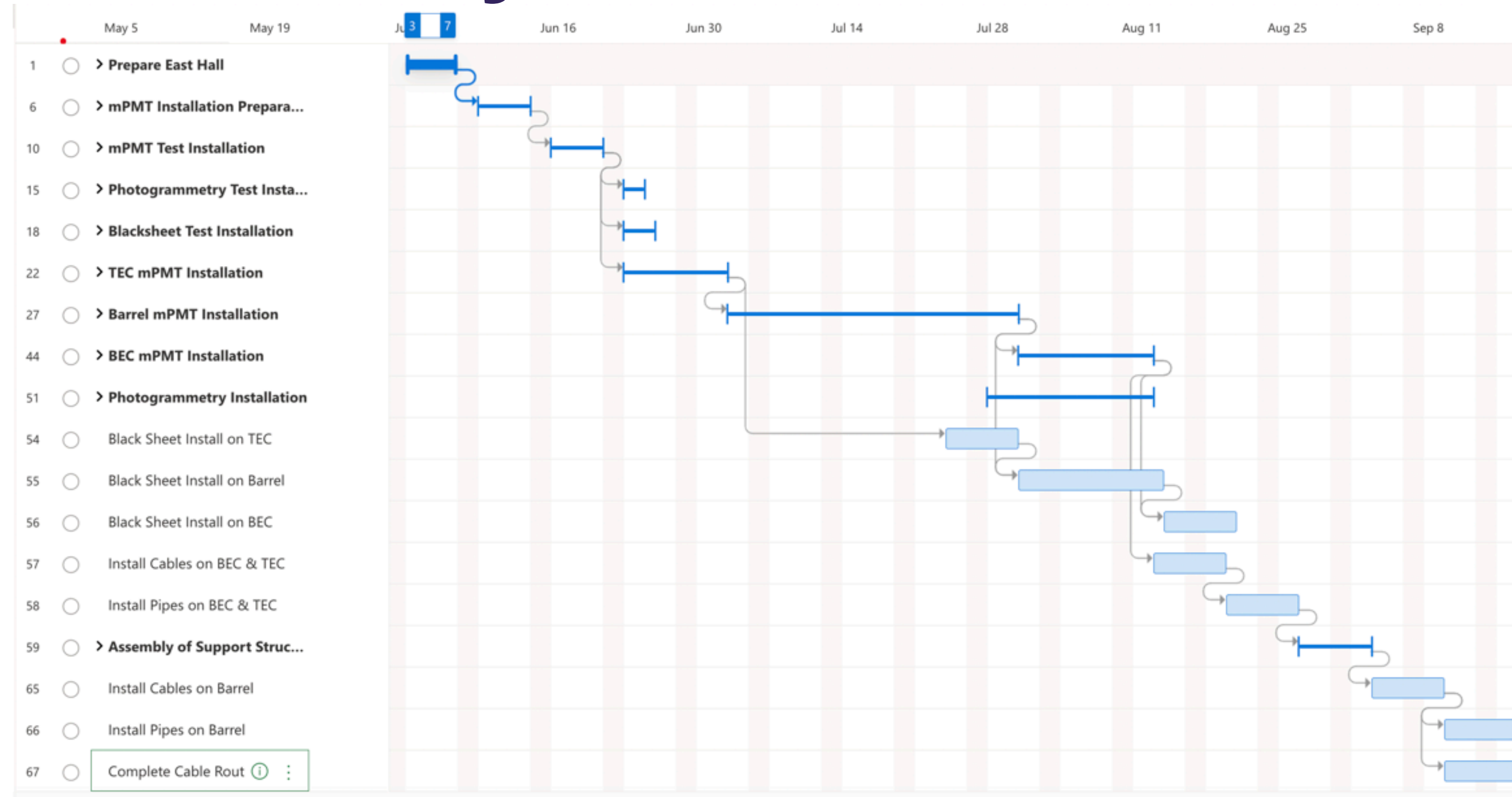

- Plan to finalize the assembly schedule soon, making conservative estimates of time to complete tasks
- Installation of mPMTs on structure starts in Mid-June and completed by Mid-August
- Completion of the structure assembly with all piping and cable routing by September 17 (could be finished earlier with careful planning of parallel tasks)
 - Would be ready for installation in T9 in week 41 (Oct. 9)

Conclusion

- WCTE collaboration has carried out valuable measurements with beam monitors in 2023 and will publish results soon
- WCTE collaboration is in the progress of completing the production/fabrication of all detector components
- Assembly plan documentation and schedule is in preparation and will be released soon
- Critical path items are being closely monitored and issues are being addressed ASAP
- Have proposed modification to draft beam schedule so that WCTE installation is in week 41
 - Consistent with expected delivery of the WCTE tank while allowing for some contingency
- WCTE plans pure water operation in 2024
- Plan request for beam time in 2025 that includes Gd loaded operation

Thank You

Updated Draft Schedule

[DRAFT] Schedule Runs PS / East Area 2.0.0 :: Status 2024-04-29 17:00 (UTC)

Calendar Months /		March			April				May				June				July				August				September				October				November					
Weeks (Mon-Mon)		CW 12	CW 13	CW 14	CW 15	CW 16	CW 17	CW 18	CW 19	CW 20	CW 21	CW 22	CW 23	CW 24	CW 25	CW 26	CW 27	CW 28	CW 29	CW 30	CW 31	CW 32	CW 33	CW 34	CW 35	CW 36	CW 37	CW 38	CW 39	CW 40	CW 41	CW 42	CW 43	CW 44	CW 45	CW 46	CW 47	CW 48
Weeks (Wed-Wed)		Week 12	Week 13	Week 14	Week 15	Week 16	Week 17	Week 18	Week 19	Week 20	Week 21	Week 22	Week 23	Week 24	Week 25	Week 26	Week 27	Week 28	Week 29	Week 30	Week 31	Week 32	Week 33	Week 34	Week 35	Week 36	Week 37	Week 38	Week 39	Week 40	Week 41	Week 42	Week 43	Week 44	Week 45	Week 46	Week 47	Week 48
PS[TOF PSIEA]	T8	T8	Main	IRRAD CHARM 234d																																		CHIMERA DRAFT 21d
	T9	Main	SHIP 19d	CMS BRIL 7d	LHCB ECAL 7d	PAN 14d	STRAW TRACKER RD 7d	RE44 HERD 7d	VLAST 14d	E+BOOST 14d	OREO 7d	CALICE SCW AHCAL 14d		MPGDCA 7d	CMS BRIL 7d	STCF ECAL & PID 14d	NP06 ENUBET DRAFT 14d	EIC ePIC DRAFT 7d	SHIP DRAFT 7d	SHIP DRAFT 7d		HIKE SAC DRAFT 7d	NANOCA DRAFT 7d	STRAW TRACKER RD DRAFT 7d	WCTE DRAFT 42d													
		Parasitic																										WCTE DRAFT 21d										
	T10	Main	ALICE ITS3 5d	ALICE ITS3 14d	ALICE ITS3 7d	ALICE TOF 7d	ALICE TIMING 7d	MEDIPIX 7d	ALICE ITS3 7d		EIC DRICH 14d	ALICE ITS3 7d		ALICE TOF 10d	ALICE TIMING 14d	IDEA CC 14d	BL4S 7d	ALICE ITS3 7d			ALICE ITS3 DRAFT 7d		ALICE ITS3 DRAFT 7d	BL4S DRAFT 14d	ALICE RICH DRAFT 14d	ALICE TIMING DRAFT 14d	ALICE MUON ID DRAFT 7d	NP07 HATPC DRAFT 14d	LHCB DRAFT 14d									
		Parallel	ALICE FOCAL 5d						ALICE FOCAL 7d					ALICE FOCAL 7d	TS1				ALICE FOCAL 7d			ALICE FOCAL DRAFT 7d		ALICE FOCAL DRAFT 7d		RE7 GAMMA MEV DRAFT 14d		ALICE MUON ID DRAFT 7d	ALICE ITS3 DRAFT 7d									
T11	Main																					P349 7d				CLOUD 42d												
	No Beam																																					
T12	T12	Main	n TOF 245d																																			

- New draft beam schedule accounting for 5 week extension of proton beam circulated on Tuesday
- WCTE installation is pushed back by 1 week
- Amount of dedicated WCTE beam time is increased from 19 to 42 days compared to preliminary schedule

Delivery of Water System

Many thanks to CERN Reception, Transport Team, and East Hall Team for the safe and fast delivery to the final position!



Calibration

- Photogrammetry camera assemblies are nearly finished and will be shipped to CERN in May and June
- Ni+epoxy spheres for NiCf source have been sent for machining
- BGO crystals for AmBe source are ordered
- AmBe container design iteration with leak tests
 - AmBe source needed in 2025 with Gd operation
- Sources for NiCf and AmBe are ordered through CERN
- Water monitor system system being tested in Canada
- Safety requirements for water monitor system being discussed and concerns addressed

Photogrammetry cameras & housings



Ni ball and container for AmBe source



Water monitor system

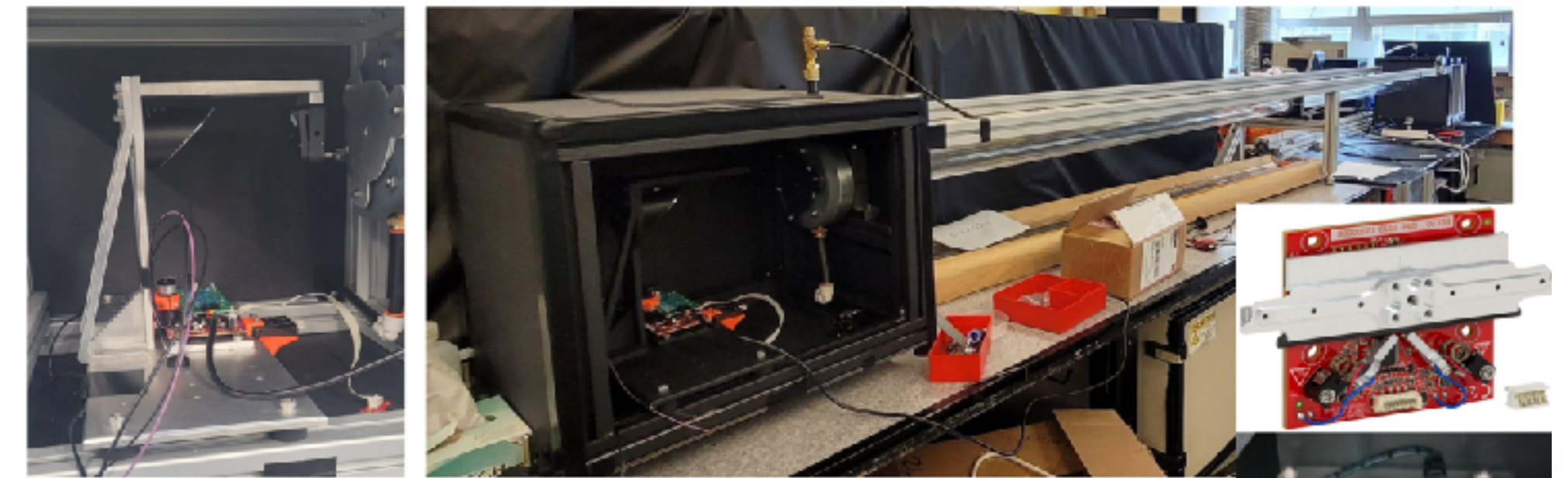

Aerogel $n=1.11$: $P_{th}(\pi)=0.286\text{GeV}/c$, $P_{th}(\mu)=0.219\text{GeV}/c$

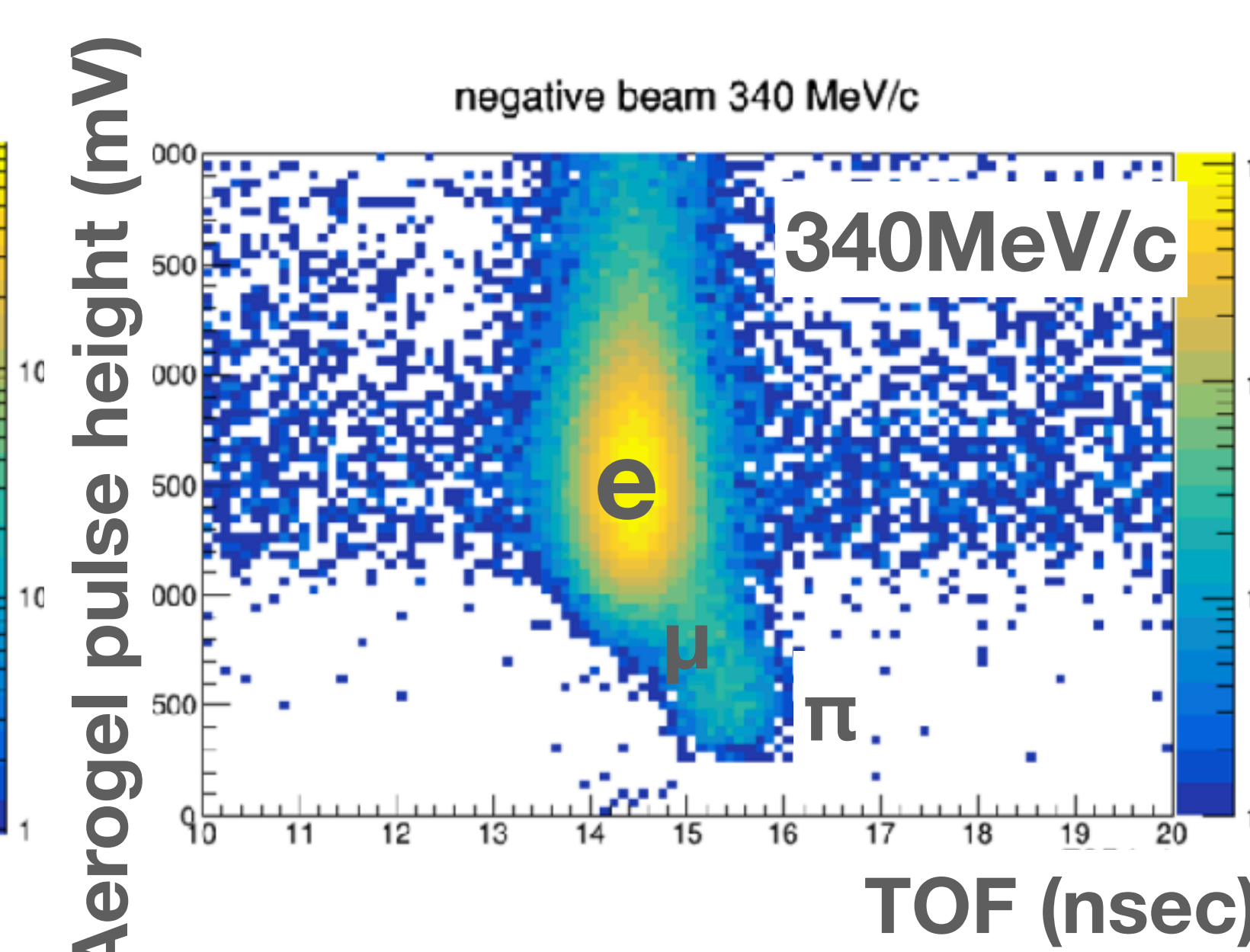
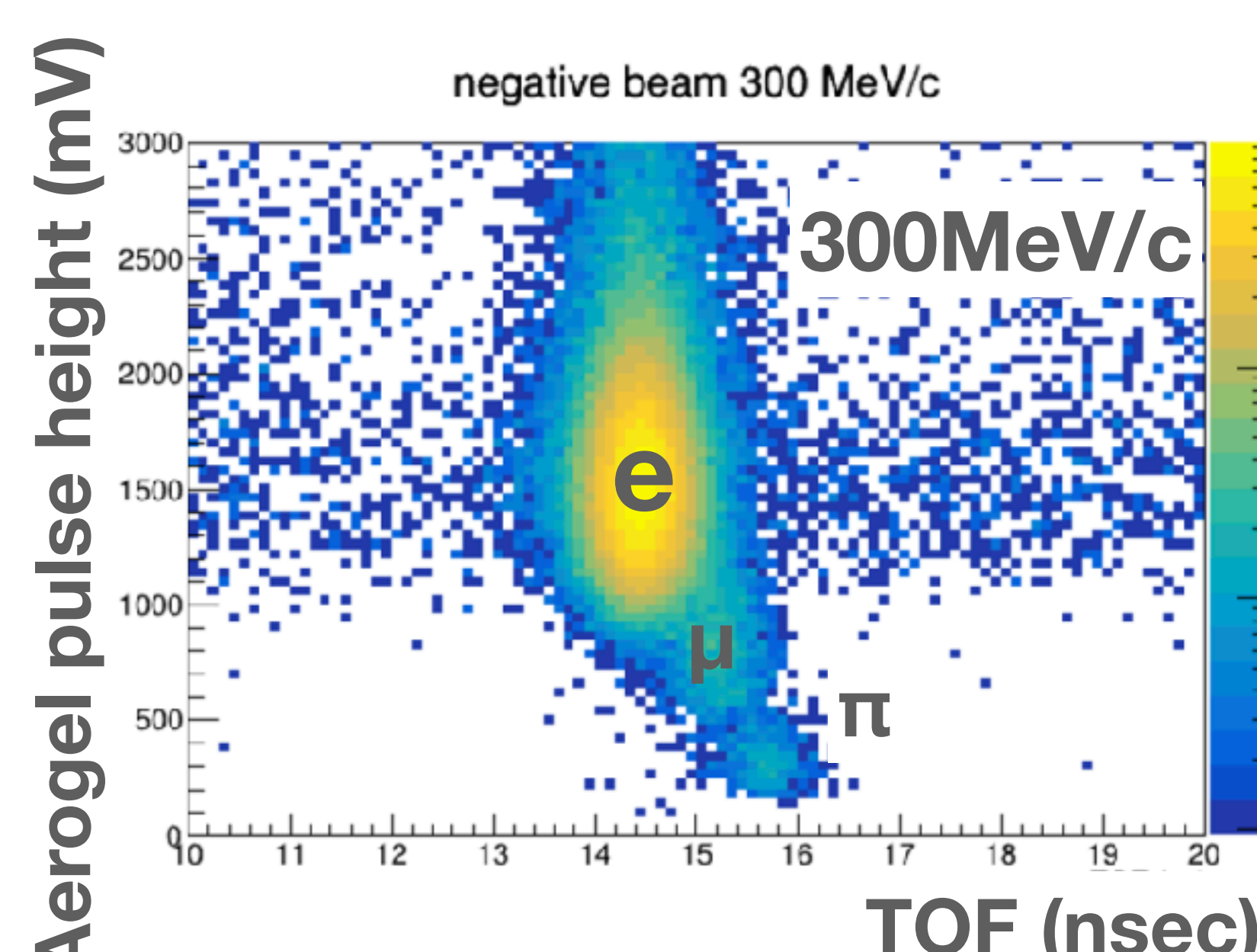
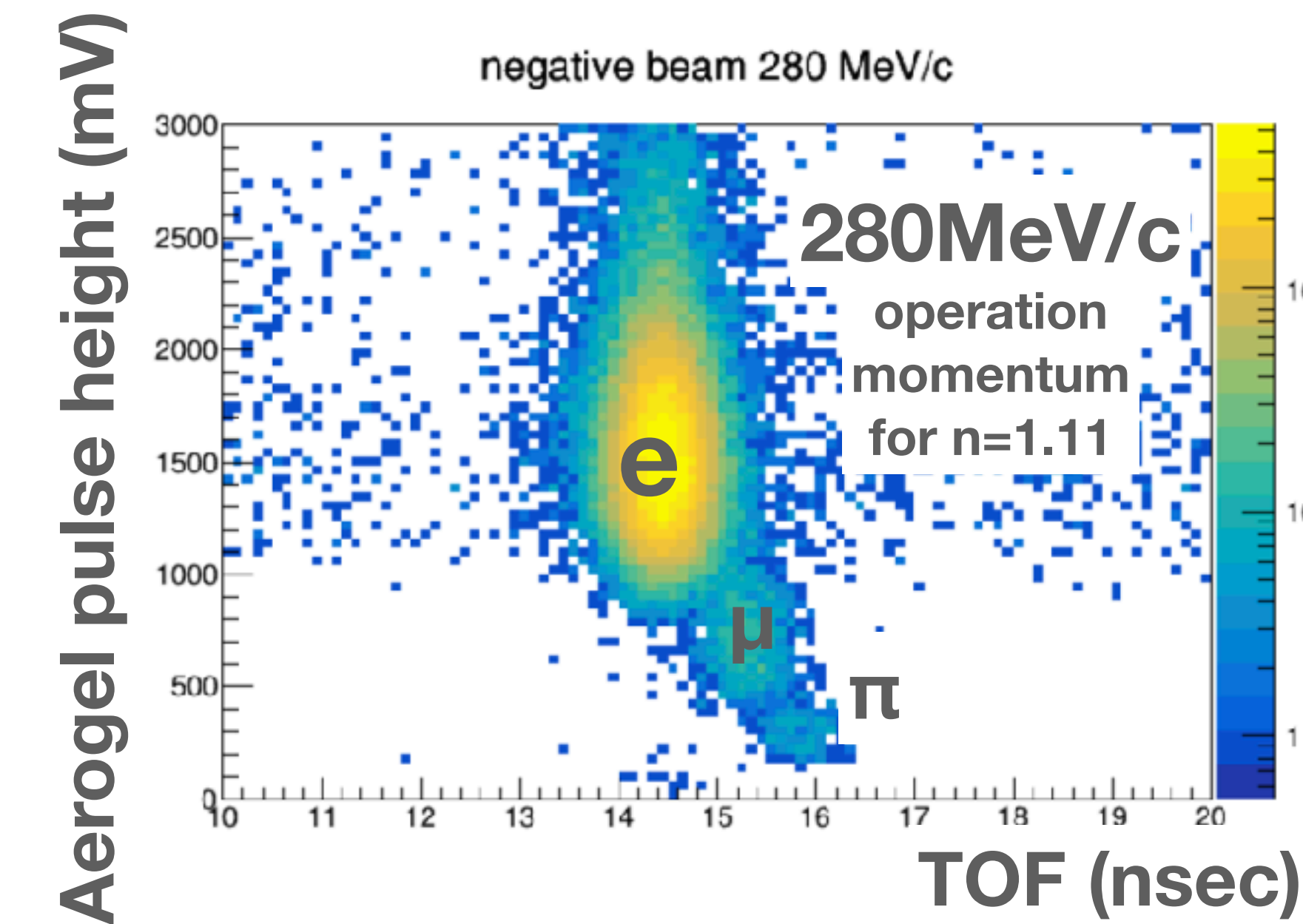
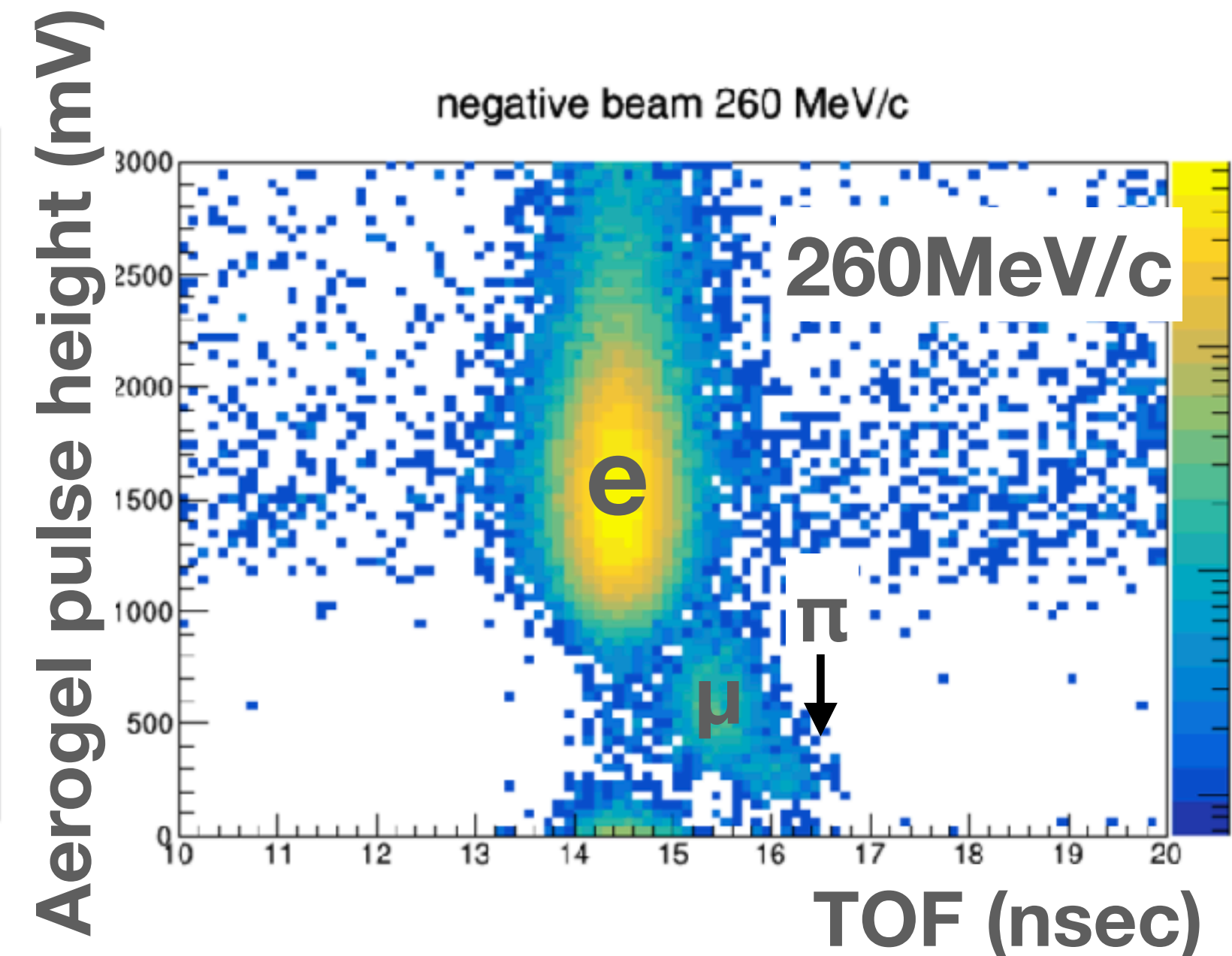
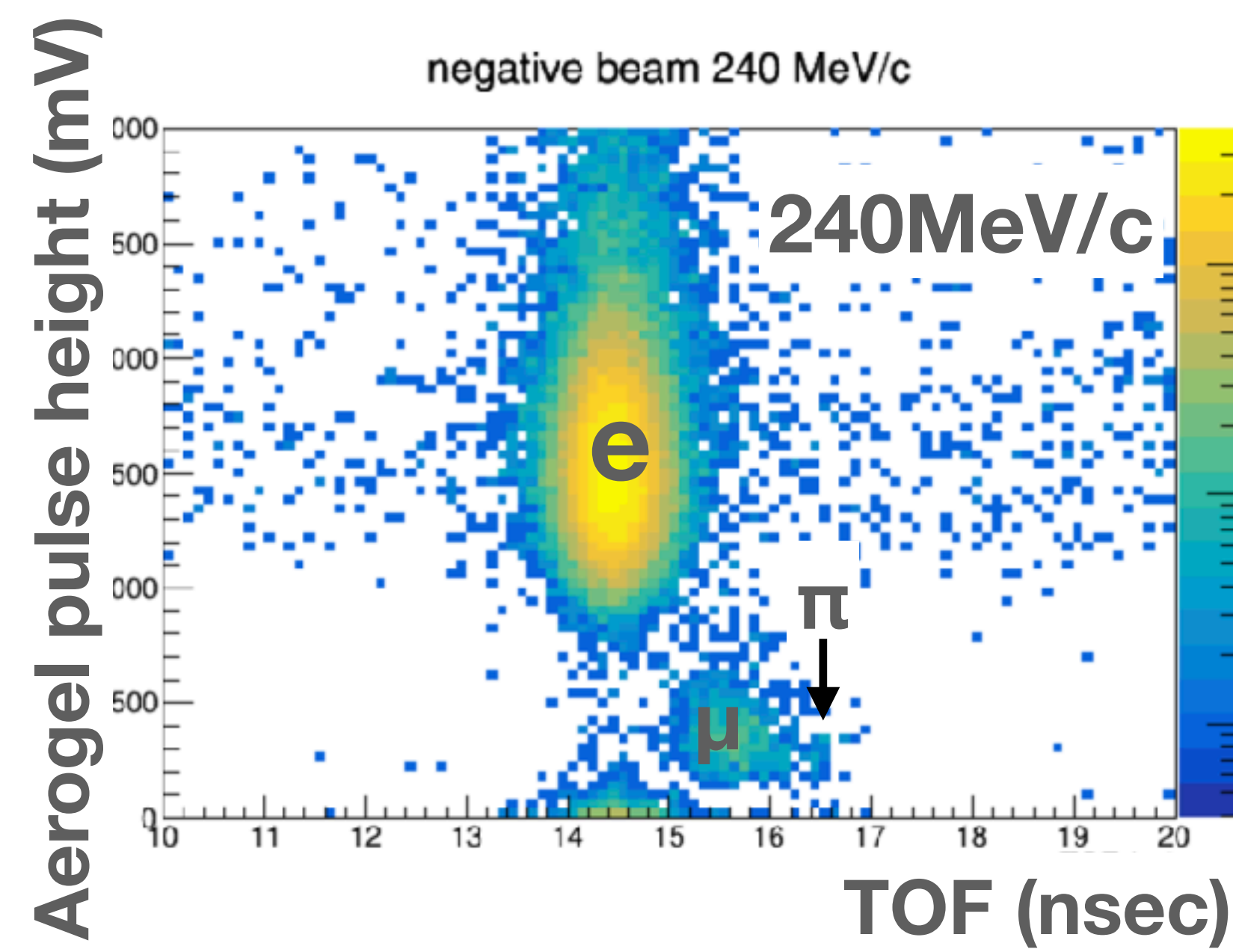
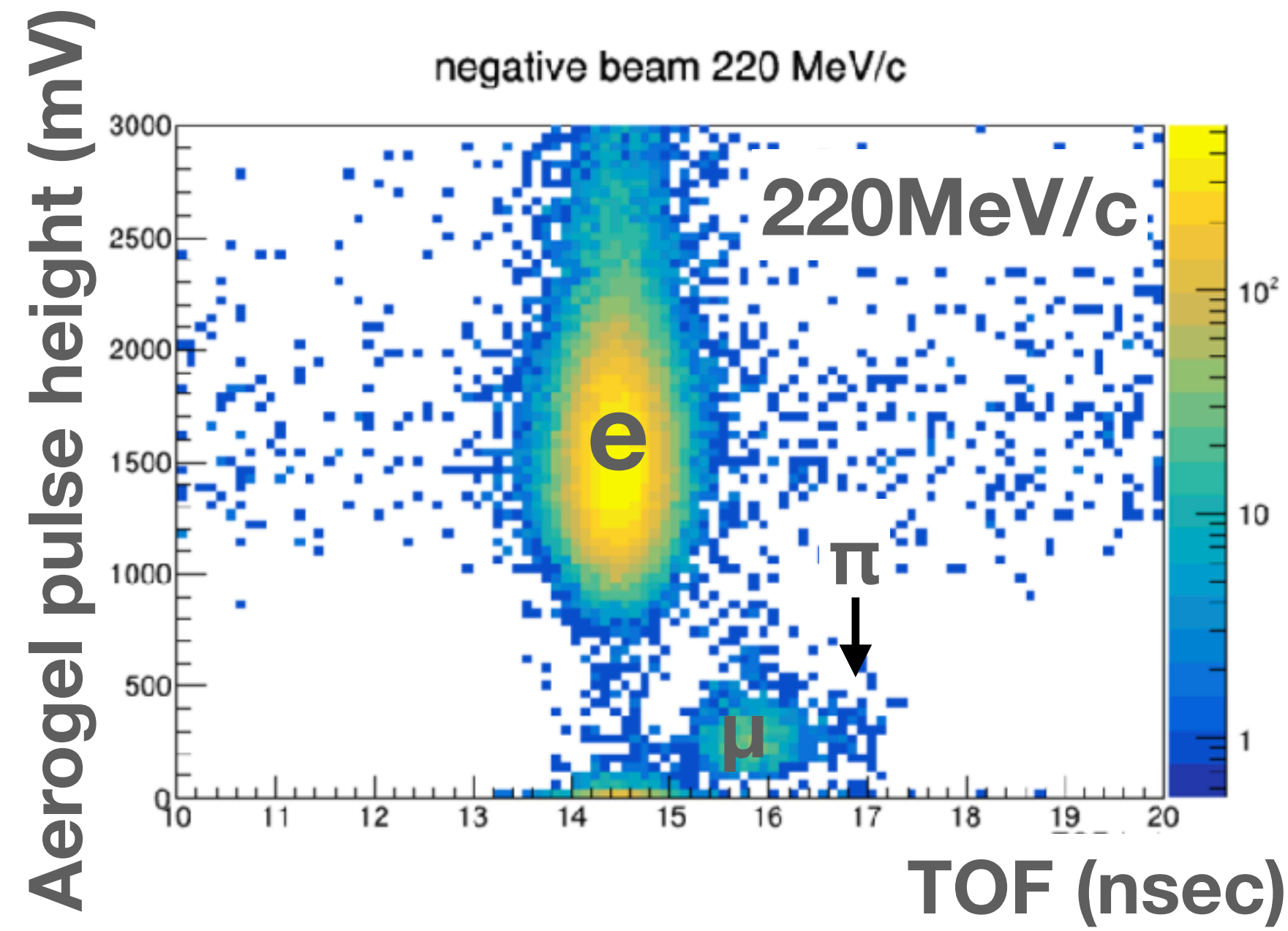

T9 Staging Area Piping (April/May)

- All piping planned with CERN EN-CV during week of March 25, 2024
- Connections to existing CERN DI source for filling and gallery drain
- Connections for testing WMS and detector tank in assembly area

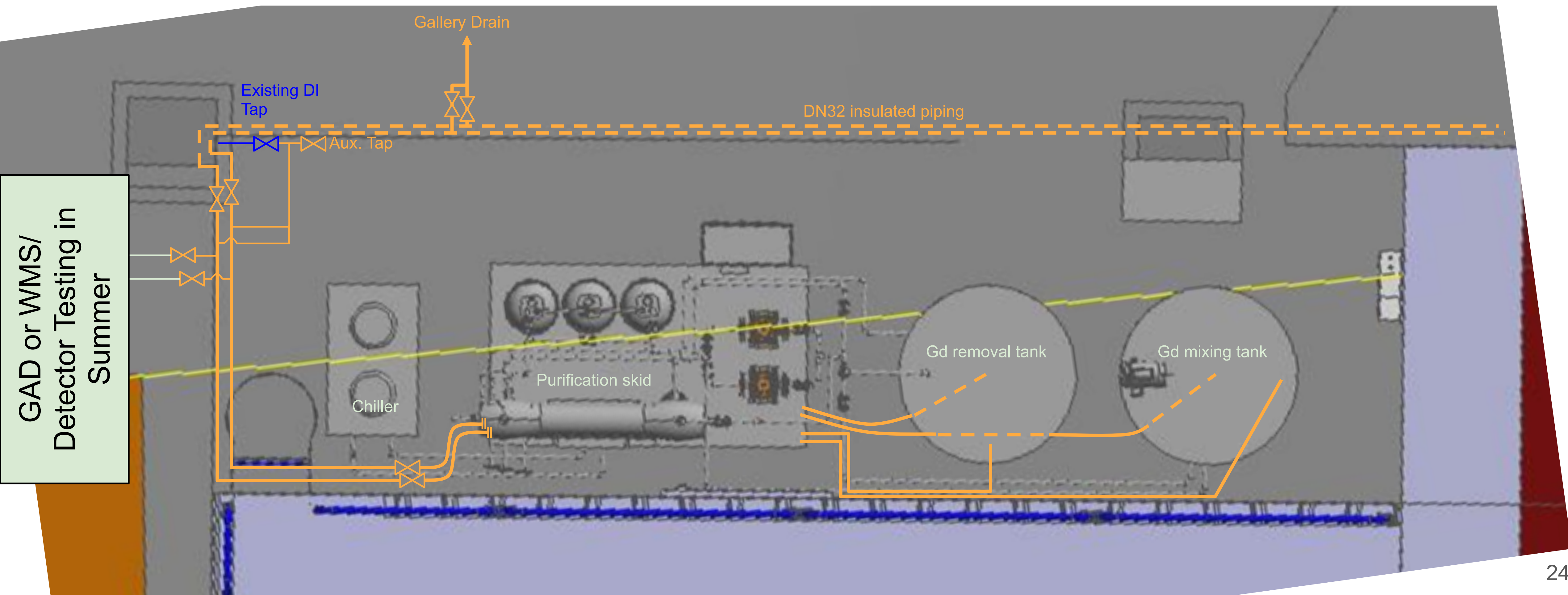

T9 Beam Area (~Oct.) and Detector Piping (summer)

- Preliminary version of detector piping design shown to EN-CV, who expressed possibility to fabricate and assemble
- Piping from gallery to detector and WMS also can be done by EN-CV

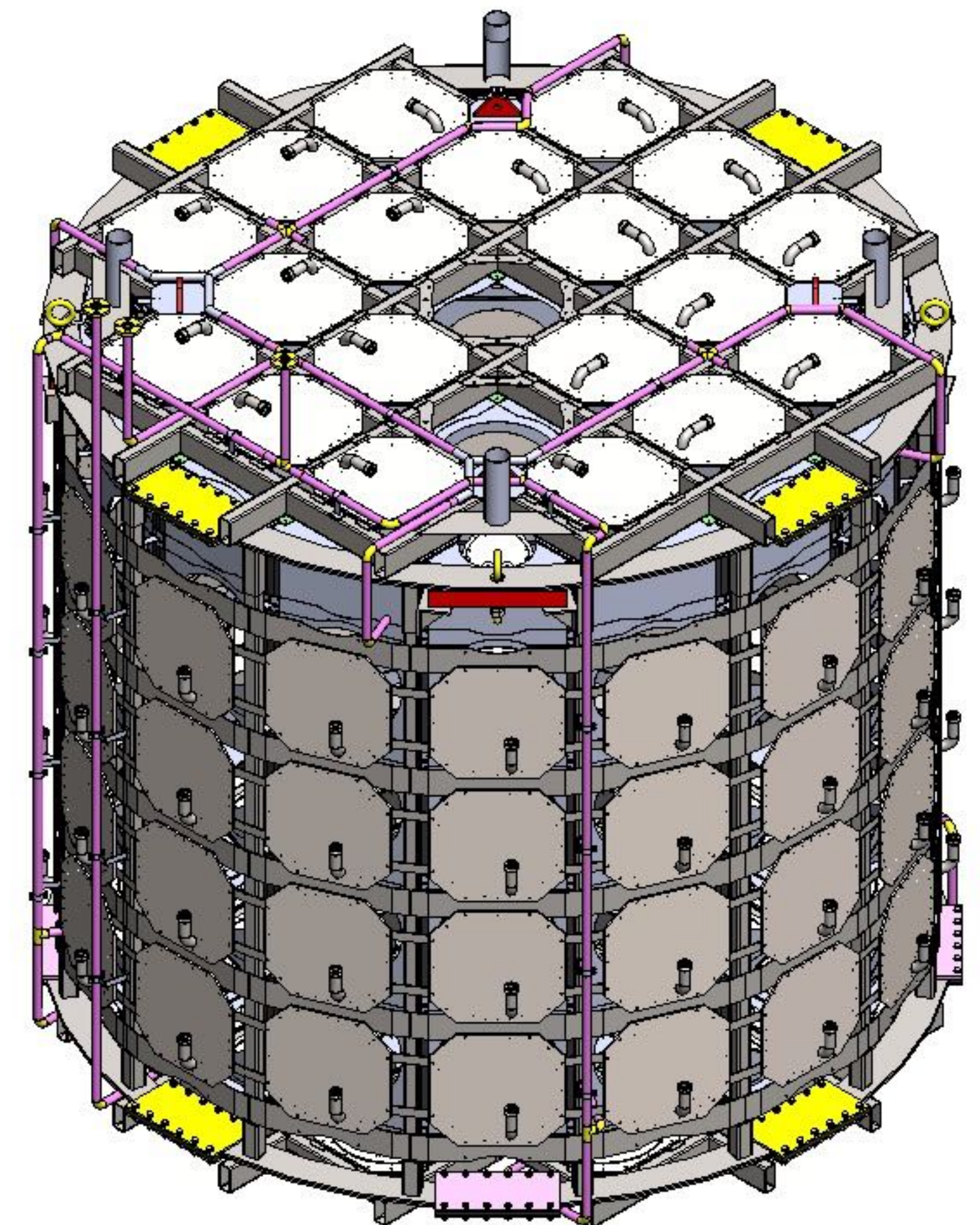
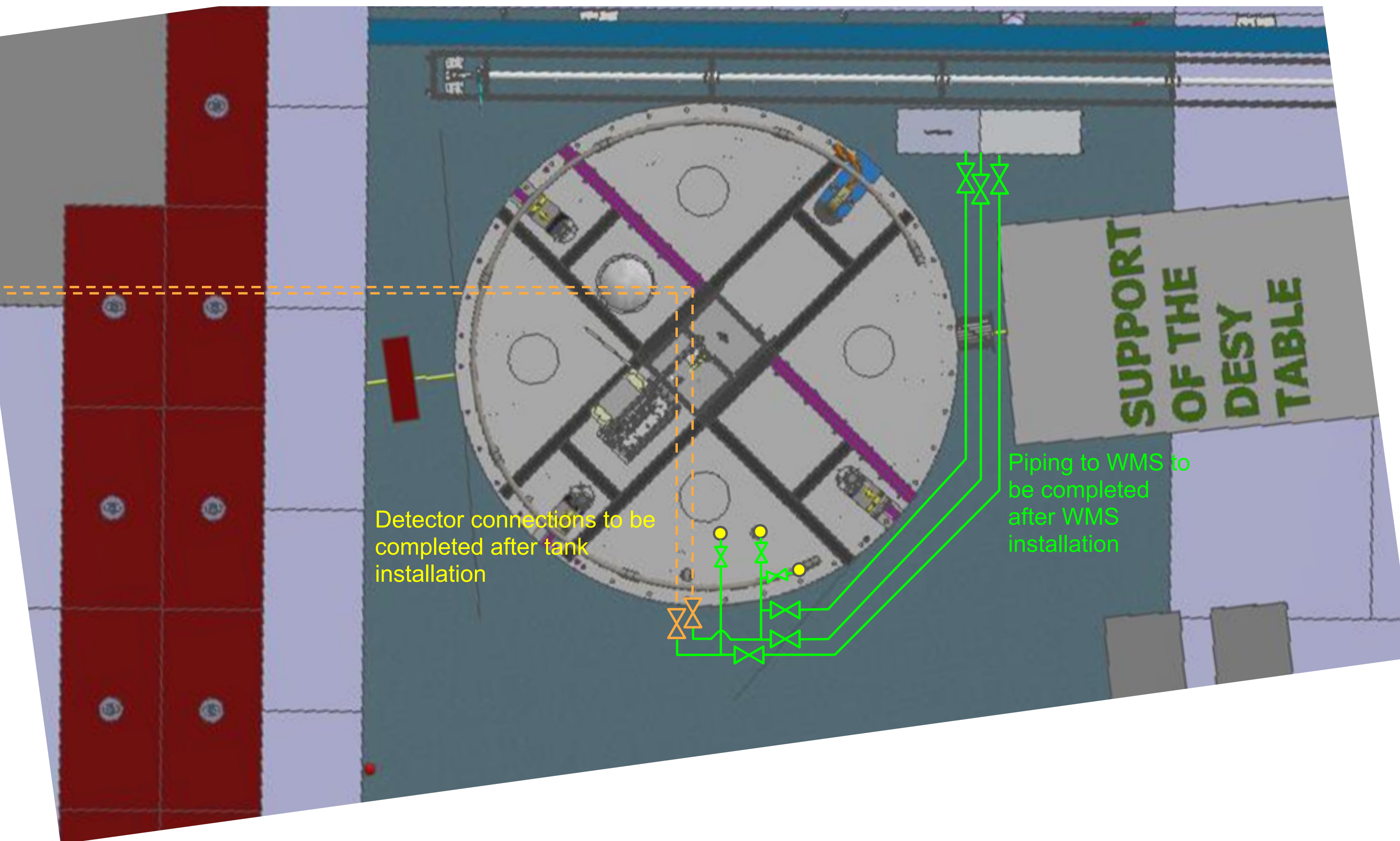

Software, Analysis & Reconstruction

Ex-situ mPMT model

- Developed a GEANT4 simulation of the detector using the WCSim package
- Ongoing work implementing accurate detector and photosensor geometries and properties into the simulation
- Major milestones:
 - Full history of Cherenkov photon trajectories saved to study reflections in the detector
 - Accurate placement of the mPMT photosensors in the detector to reflect the WCTE design
 - CDS geometry modelled and placed in the detector
- Traditional likelihood and machine learning based reconstruction algorithms have been developed and will be used in parallel
- Acceptable reconstruction performance is achieved based on initial simulations
 - Work is underway to tune to finalised detector simulations with improved performance expected ready for use by the time WCTE is taking data

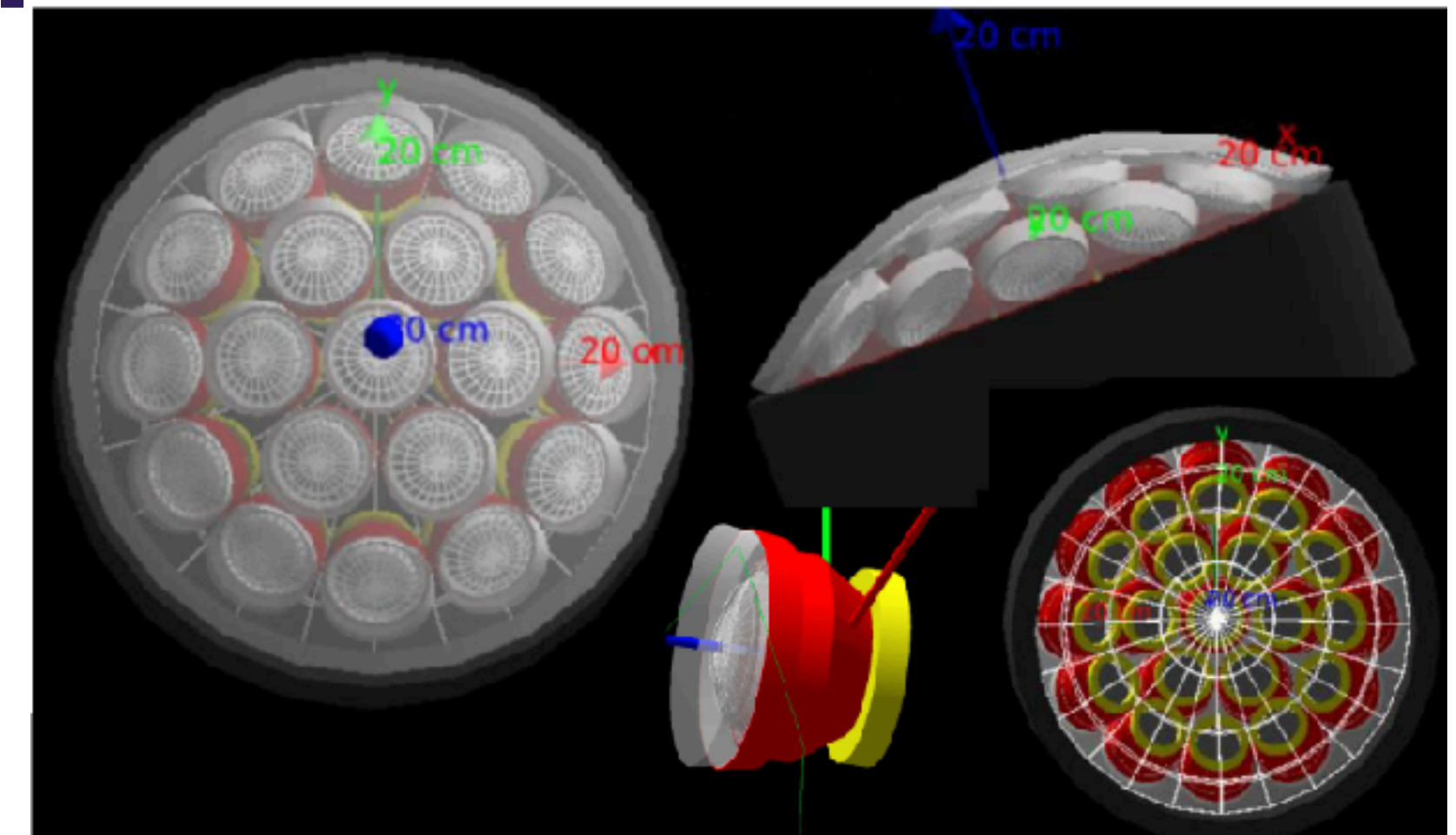

CDS inside WCTE tank

