

# Simulating monolithic active pixel sensors

A technology-independent approach using generic doping profiles

H. Wennlöf

for the Tangerine collaboration

20/6 -24

The Tangerine collaboration at DESY: A. Chauhan, M. Del Rio Viera, J. Dilg, D. Eckstein, F. Feindt, I.-M. Gregor, Y. He, K. Hansen, L. Huth, S. Lachnit, L. Mendes, B. Mulyanto, D. Rastorguev, C. Reckleben, S. Ruiz Daza, J. Schlaadt, P. Schütze, A. Simancas, S. Spannagel, M. Stanitzki, A. Velyka, G. Vignola, H. Wennlöf

# Outline

- Motivation
  - Why simulations?
- Simulation tools
  - TCAD
  - Allpix Squared
- Simulation procedure
  - Examples from the [Tangerine project](#)
    - Procedure applicable in many cases, however
- Example results
- Conclusions and outlook

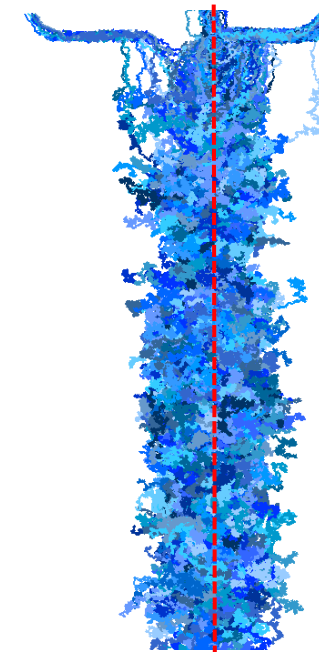
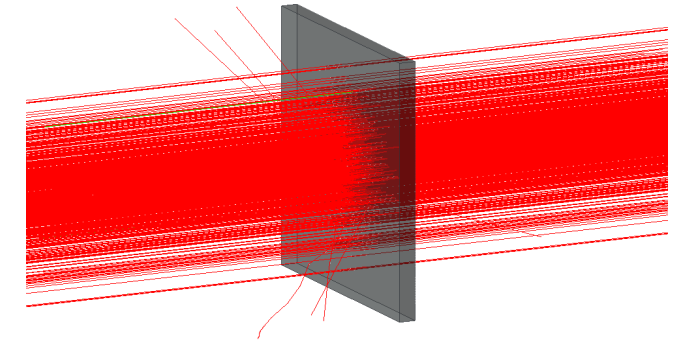
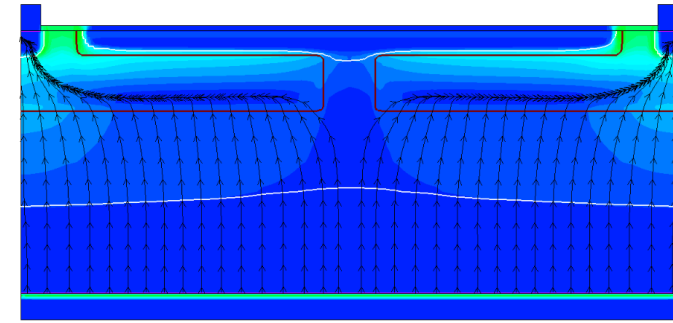

# Silicon sensor simulations

- **Goal:** Accurate simulation of the **charge collection behaviour** in the sensitive volume
  - Enables **understanding and prediction of sensor performance** (e.g. resolution, efficiency)
  - Done by simulating the **movement of electron-hole pairs** created by an interacting particle
- **Issue:** The access to manufacturing process information may be **very limited**
  - The Tangerine project for example utilises a commercial CMOS imaging process - detailed process information is **proprietary**
- **Solution:** development of a **technology-independent simulation approach using generic doping profiles**
  - Currently writing a **paper** describing the approach, serving as a **toolbox** for such simulations

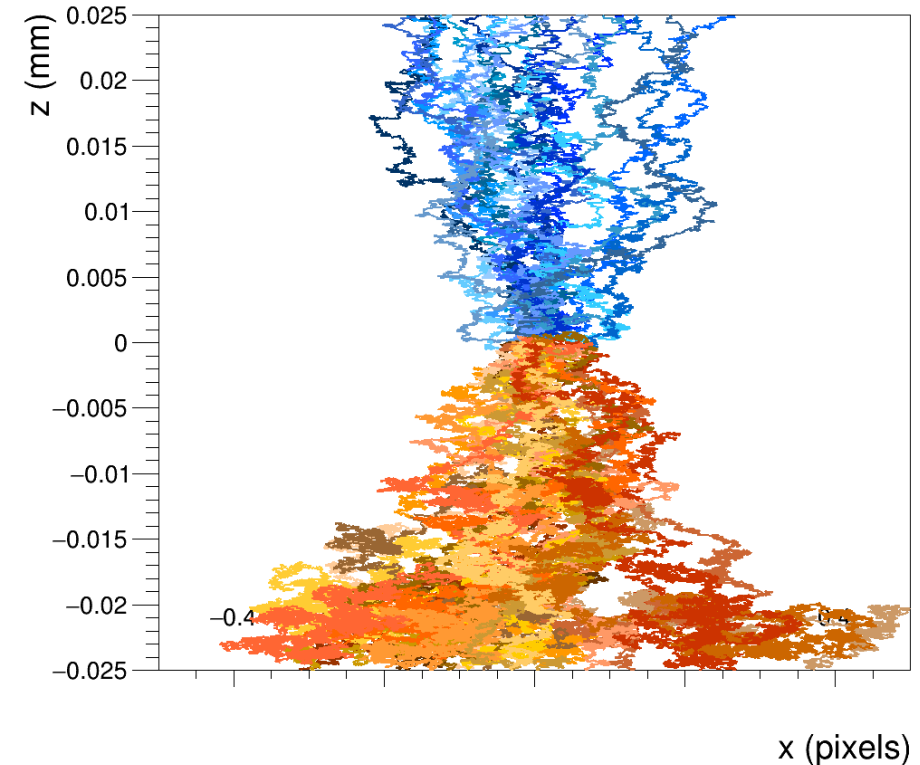

Simulated motion of individual **electrons** and **holes** deposited in the centre of a silicon sensor with a linear electric field

Simulating Monolithic Active Pixel Sensors:  
A Technology-Independent Approach Using Generic Doping Profiles

Håkan Wennlöf<sup>a,\*</sup>, Dominik Dannheim<sup>b</sup>, Manuel Del Rio Viera<sup>a,1</sup>, Katharina Dort<sup>b,1</sup>, Doris Eckstein<sup>a</sup>, Finn Feindt<sup>a</sup>, Ingrid-Maria Gregor<sup>a</sup>, Lennart Huth<sup>a</sup>, Stephan Lachnit<sup>a,1</sup>, Larissa Mendes<sup>a,1</sup>, Daniil Rastorguev<sup>a,1</sup>, Sara Ruiz Daza<sup>a,1</sup>, Paul Schütze<sup>a</sup>, Adriana Simancas<sup>a,1</sup>, Walter Snoeys<sup>b</sup>, Simon Spannagel<sup>a</sup>, Marcel Stanitzki<sup>a</sup>, Alessandra Tomal<sup>c</sup>, Anastasiia Velyka<sup>a</sup>, Gianpiero Vignola<sup>a,1</sup>

<sup>a</sup>Deutsches Elektronen-Synchrotron DESY, Notkestr. 85, 22607 Hamburg, Germany

<sup>b</sup>CERN, Geneva, Switzerland

<sup>c</sup>University of Campinas, Cidade Universitaria Zeferino Vaz, 13083-970, Campinas, Brazil

# Tools used in the simulation approach



- Models semiconductor devices using **finite element methods**
- Calculates realistic and accurate **electric fields and potentials** from doping concentrations

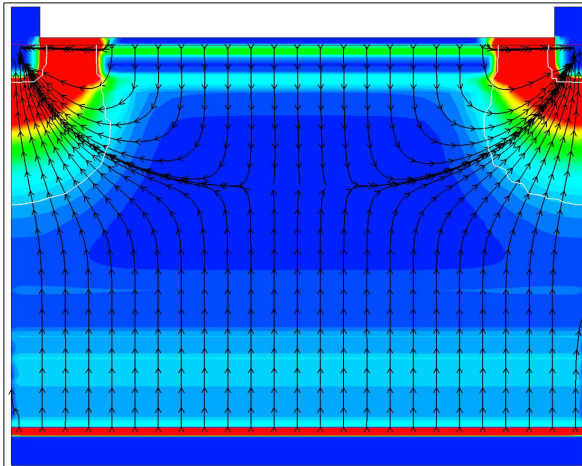

Example electric field in TCAD

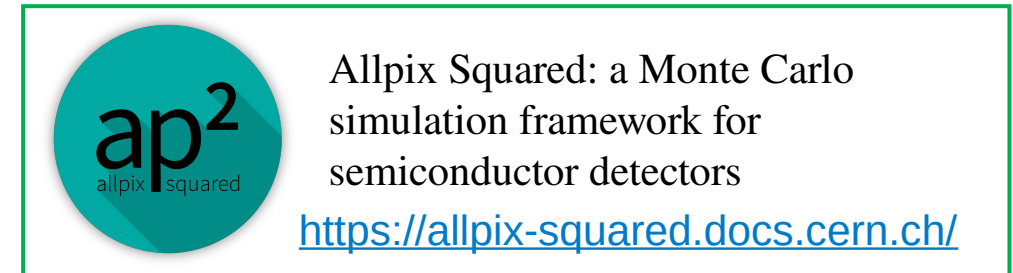

- Simulates **full detector chain**, from energy deposition through charge carrier propagation to signal digitisation
  - Interfaces to **Geant4** and **TCAD**
- Simulation performed **quickly** - allows for **high-statistics** data samples across a full detector

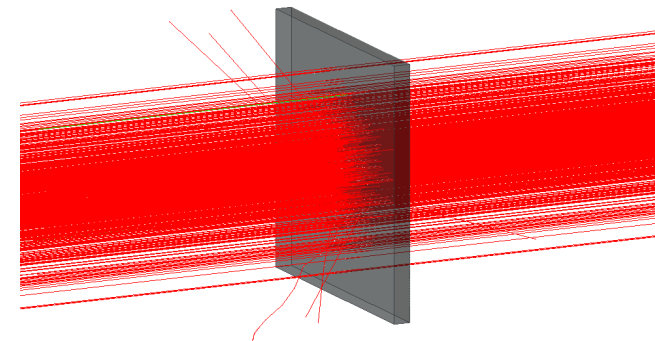

Particle beam passing through a single sensor in Allpix<sup>2</sup>

# TCAD

## Technology computer-aided design

- Models **semiconductor devices** in 2D or 3D, and numerically solves equations using provided information
  - By providing doping information, e.g. **electric fields** and **weighting potentials** can be simulated
  - Capacitances, I-V and C-V curves, and transient properties can be extracted
- **Fabrication steps** in semiconductor manufacturing can be simulated
- Different pixel geometries and layouts can be simulated in **great detail**
- Some example resulting electric fields shown on the right

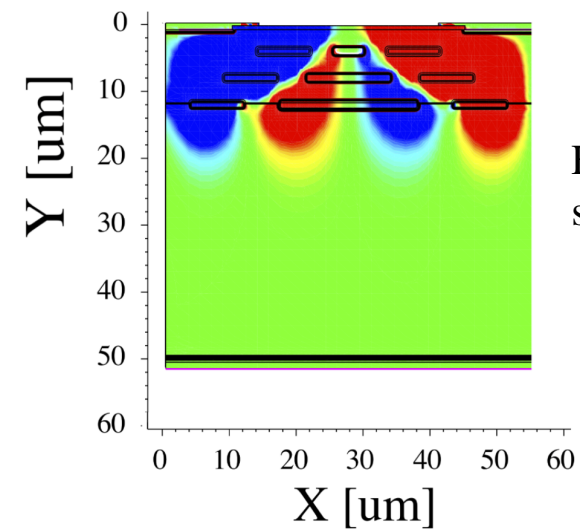

Enhanced Lateral Drift sensor simulation, [A. Velyka](#)

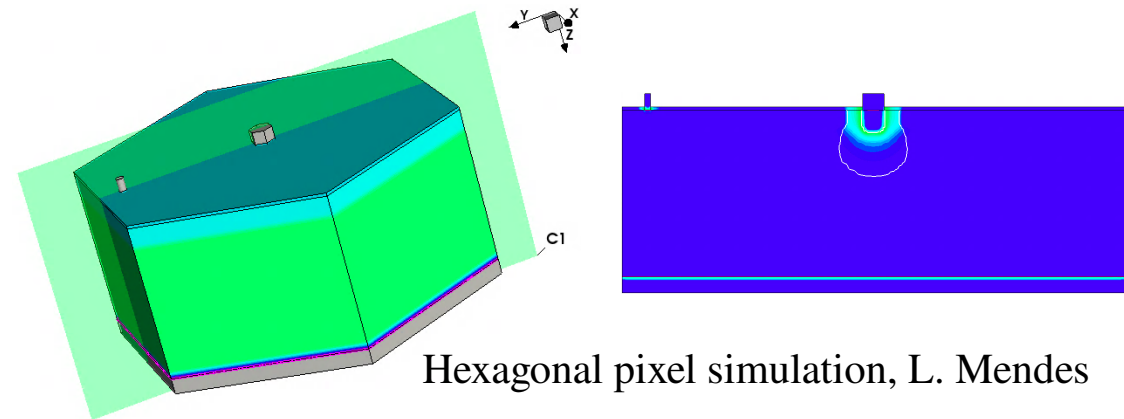

Hexagonal pixel simulation, L. Mendes

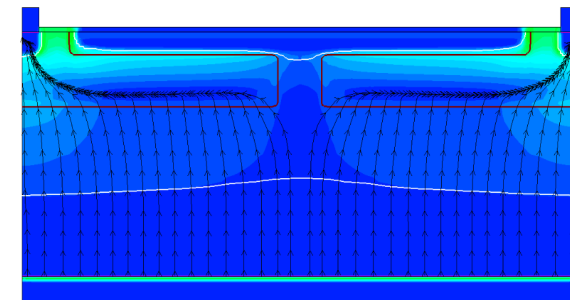

Rectangular pixel simulation, [A. Simancas](#)

# Allpix Squared

## A Monte Carlo simulation framework for semiconductor detectors

- Simulates **charge carrier motion** in semiconductors, using **well-tested** and **validated** algorithms
  - Includes different models for e.g. charge carrier mobility, lifetime and recombination, trapping and detrapping
  - Support for several semiconductor materials and pixel and sensor geometries
- Provides a **low entry barrier** for new users
  - Simulations are set up via **human-readable configuration files**
- **Steady development** over many years
  - Framework is **easily extendable** and **widely used**
  - **Open-source**, and written in **modern C++**
  - Version 3.1.0 released on May 17th of this year
- [User workshop](#) presentations hold many example applications



Website and documentation:  
<https://allpix-squared.docs.cern.ch/>

```
[AllPix]
number_of_events = 10000
detectors_file = "telescope.conf"
```

```
[GeometryBuilderGeant4]
world_material = "air"
```

```
[DepositionGeant4]
particle_type = "Pi+"
number_of_particles = 1
source_position = 0um 0um -200mm
source_type = "beam"
beam_size = 1mm
beam_direction = 0 0 1
```

```
[ProjectionPropagation]
```

```
[SimpleTransfer]
```

```
[DefaultDigitizer]
```

Minimal simulation configuration  
example

# Silicon simulation layout and assumptions

## Using the [Tangerine project](#) as an example

- High-resistivity **epitaxial layer** grown on low-resistivity **substrate**
- Approximate doping concentrations can be found in **published papers** and theses, that have been approved by the foundry
  - The **exact values are proprietary information**, however (but we do not need them to model the sensor behaviour)
- Doping wells are simulated **without internal structure** and as flat profiles
  - Small collection n-well in the centre of the pixel
  - Deep p-well holding the in-pixel CMOS electronics
- **3D geometry** simulated, including **metal bias contacts** and **Ohmic contact regions** in the silicon

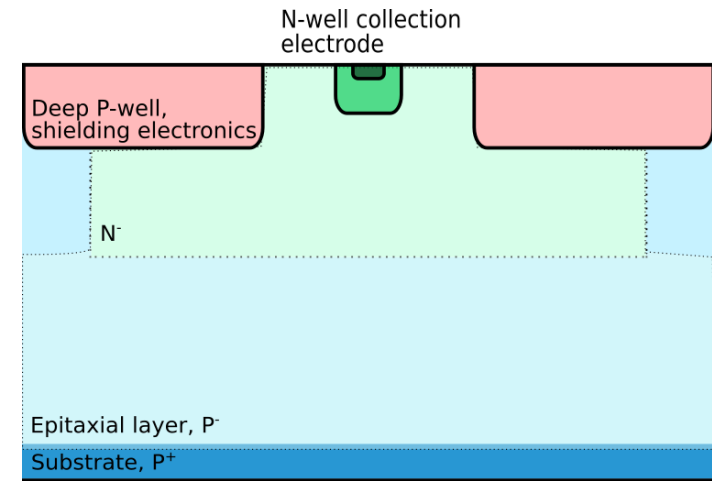

“N-gap layout”, M. Munker et al 2019 JINST 14 C0501

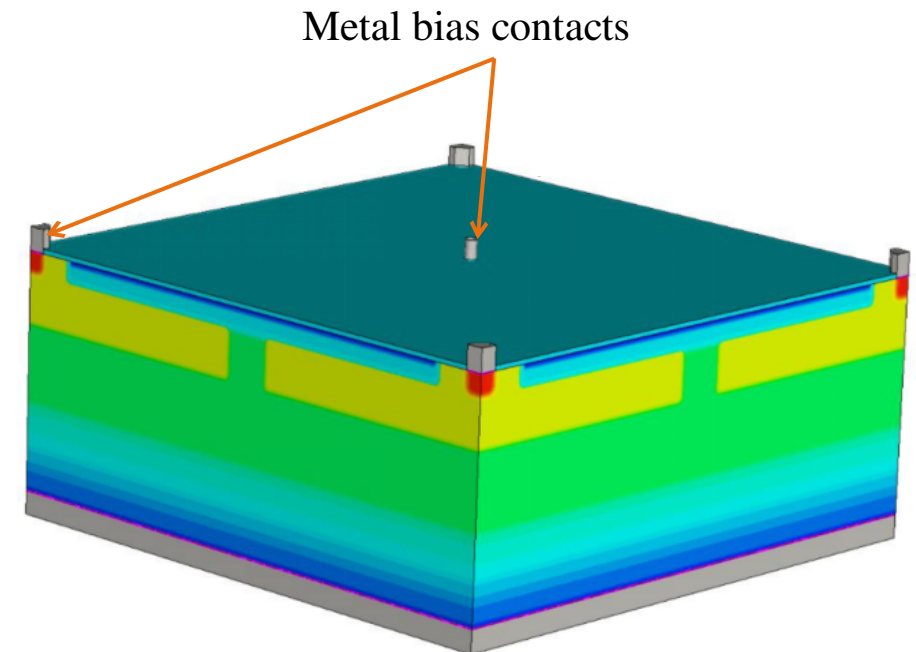

# Finite element method simulations using TCAD

## Using the [Tangerine project](#) as an example

- Using TCAD, **doping profiles** and **electric fields** are simulated
  - Studies are made observing the **impact of varying different parameters**, e.g. mask geometries
- Starting by creating the **geometry and doping regions**
  - Doping distribution is **further refined** by simulating diffusion between regions at reasonable **sensor production process temperatures**
    - Gives a continuous interface between epi and substrate
- Device simulations used to simulate **electric fields**, **electrostatic potentials**, **capacitances**, and performing **transient simulations**

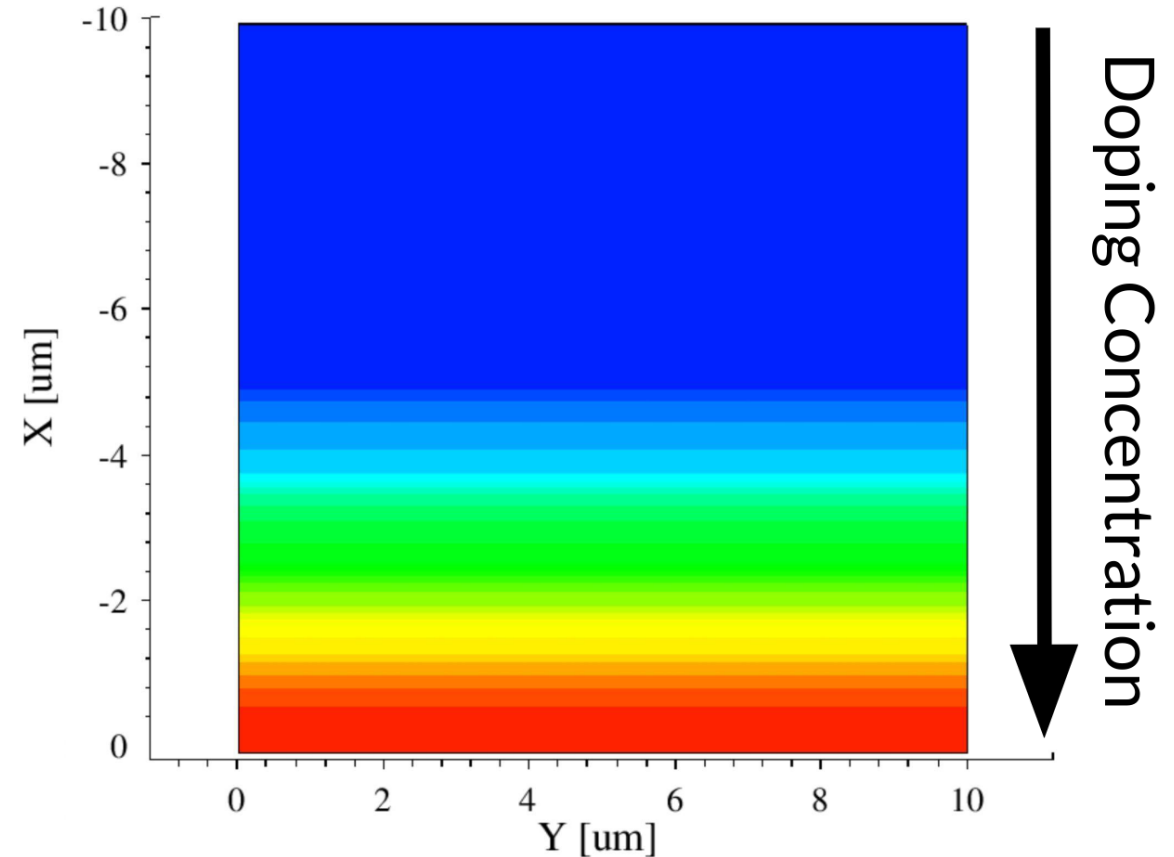

Process simulation result, showing dopant diffusion between substrate and epitaxial layer



# Finite element method simulations using TCAD

## Example study: impact of n-gap size on electric field

- The gap in the n-gap layout is introduced to give a **lateral electric field at pixel edges**
- The magnitude of the field depends on the **size of the gap**
  - Too small gap: the lateral field components **cancel out**
  - Too large gap: **low-field region** between pixels (i.e. in the gap)
- Figures show simulation results for the **lateral electric field** (red and blue) for different gap sizes

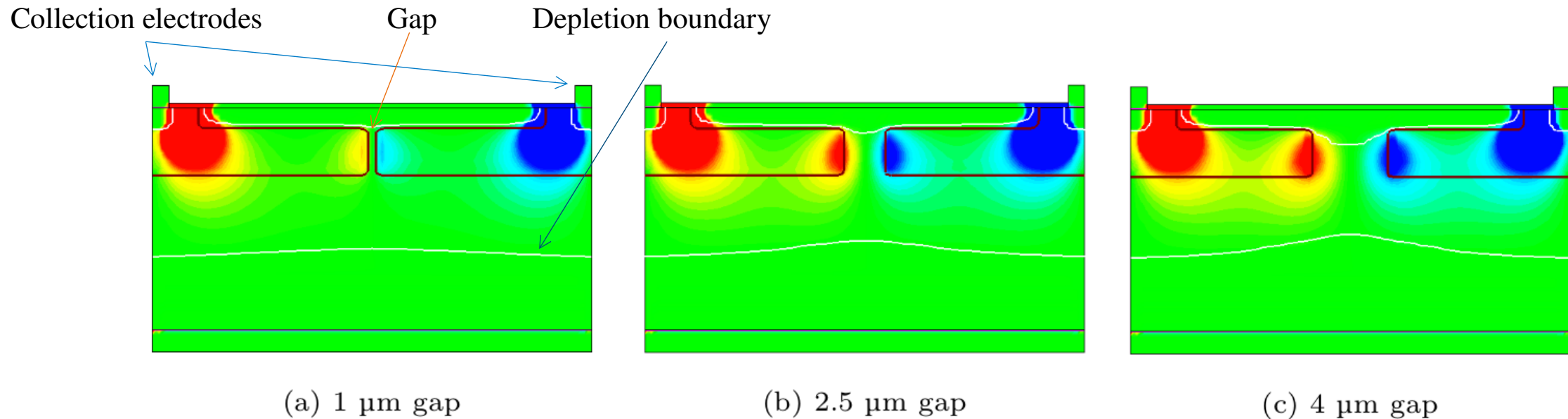

# Finite element method simulations using TCAD

## Transient simulations

- Extracting the **time-dependent induced signal** on the collection electrodes, from traversal of a MIP
- Investigating both **pixel corner** incidence and **pixel centre** incidence
  - Gives indication of “worst case” and “best case” particle hit scenarios

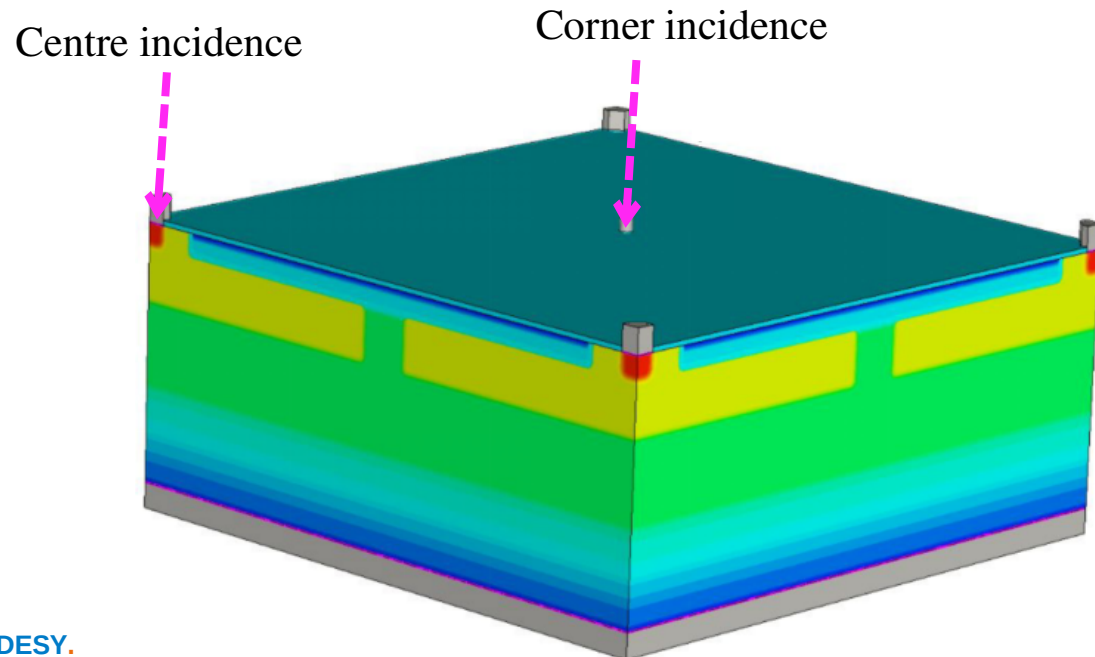

Square pixels,  $20 \times 20 \mu\text{m}^2$ , n-gap layout

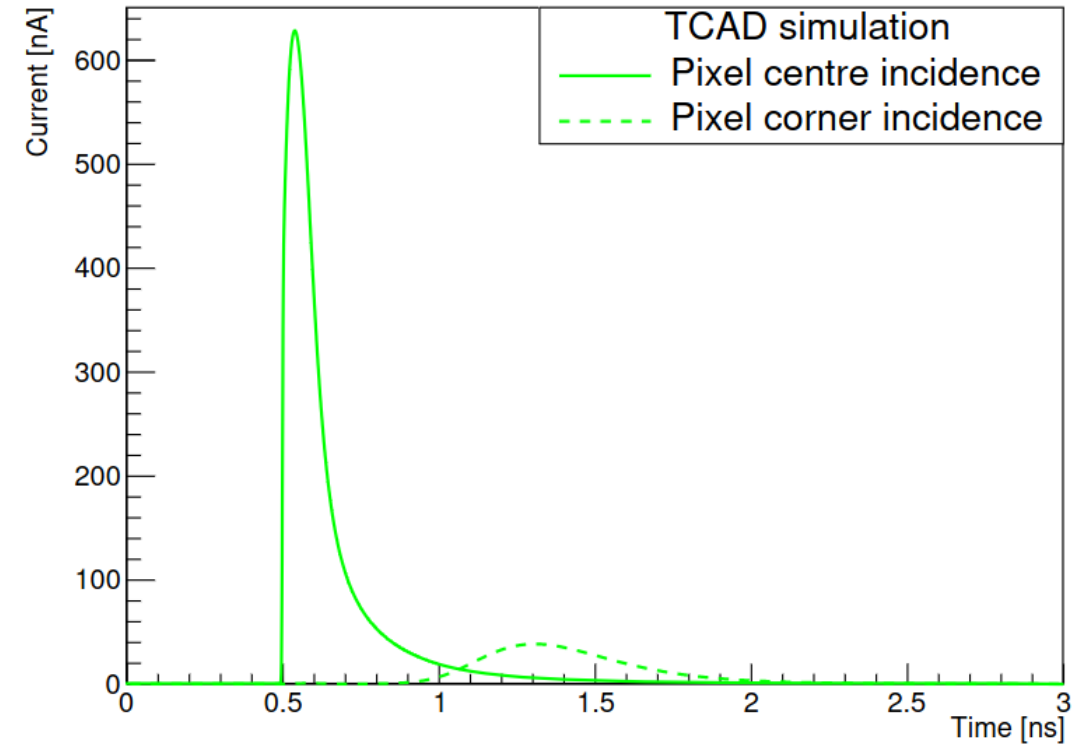

Transient pulses for pixel centre and corner incidence

# Monte Carlo simulations using Allpix<sup>2</sup>

- **Flexible** and **modular** framework, describing each part of **semiconductor signal generation and propagation**
- Allows import of **TCAD fields and doping profiles**
  - Allpix<sup>2</sup> and TCAD make a **powerful combination**; fast and detailed simulations possible, allowing high statistics

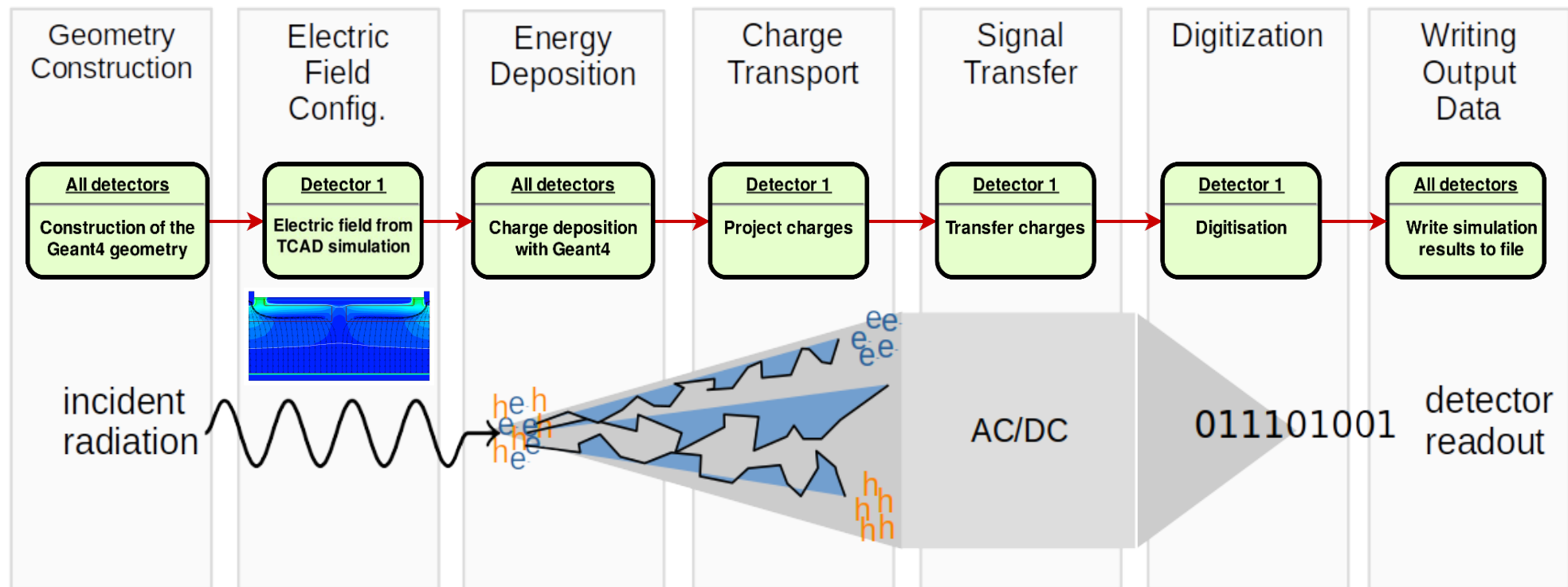

# Monte Carlo simulations using Allpix<sup>2</sup>

## Impact of mobility model

- Physical parameters and models can easily be **exchanged**
- Example: **mobility models** in silicon
  - Jacoboni-Canali model is **doping-independent**
    - Sufficient for describing charge propagation in low-doped regions
    - In high-doped regions (e.g. substrate) diffusion is unphysically large
  - Extended Canali model (including the Masetti model) is **doping-dependent**
    - Describes charge carrier motion well also in highly-doped regions
- Linegraphs show the **propagation paths of individual charge carriers**
  - Each blue line is the path of a single electron

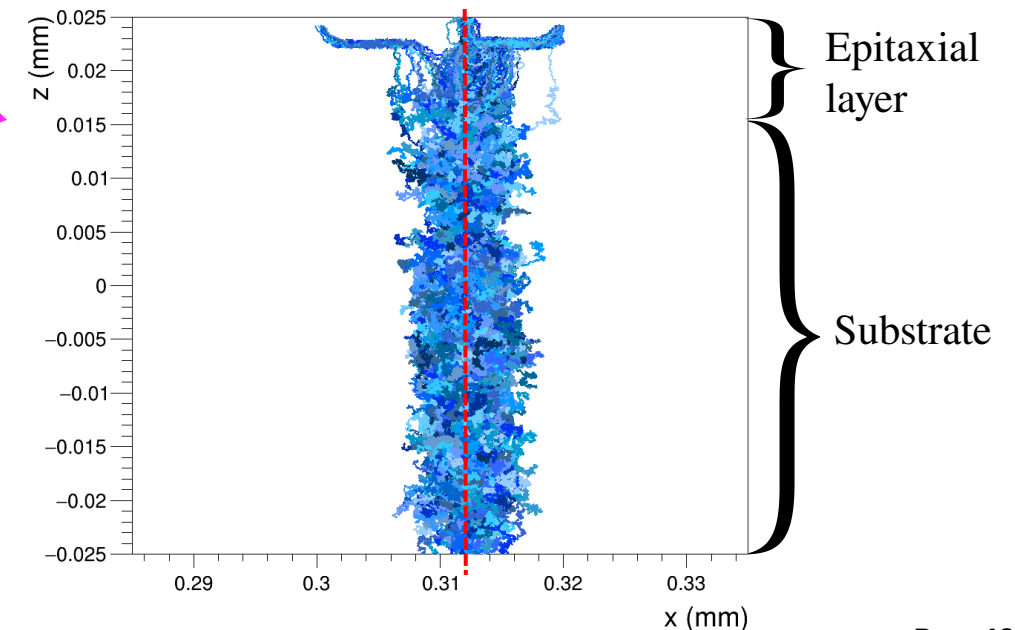
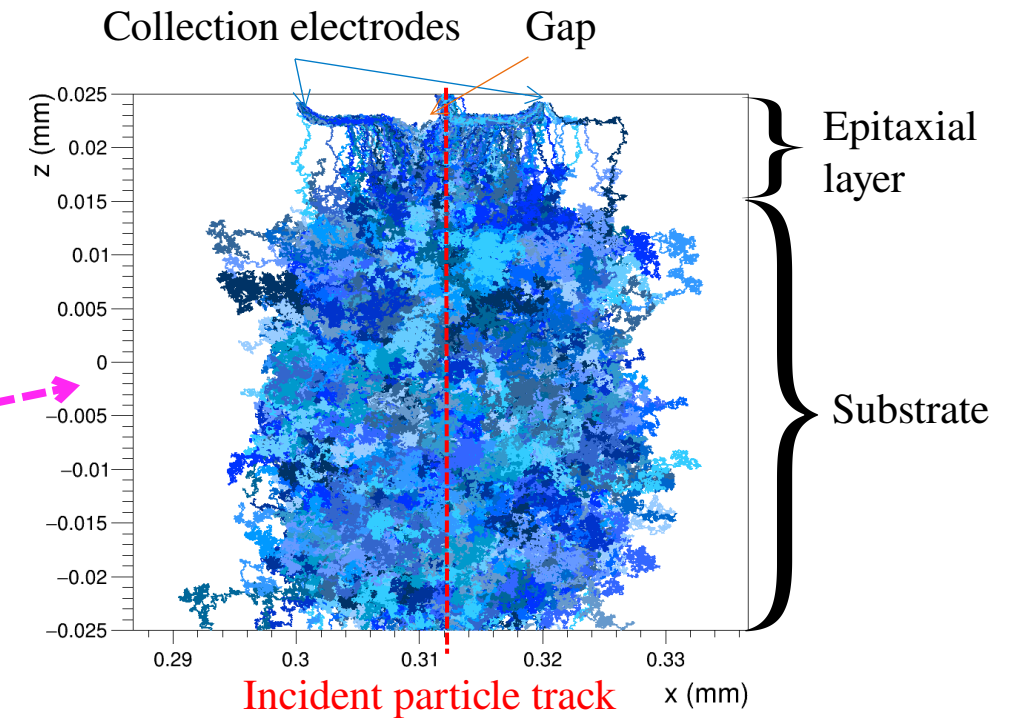

# Allpix<sup>2</sup> combined with TCAD

## Example result from the [Tangerine project](#)

- High-statistics simulations allow extraction of observables such as cluster size, resolution, efficiency
- Sensor **mean efficiency versus detection threshold**, for different bias voltage
  - Simulation carried out with a DESY II-like beam of electrons; many events (500 000), so statistical error bars are small
- The trend is as expected:
  - Efficiency **decreases as threshold increases**
  - The sensor reaches its **full efficiency** potential already at -1.2 V
- 0 V deviates from the others by being less efficient as threshold increases, most likely due to **incomplete depletion**

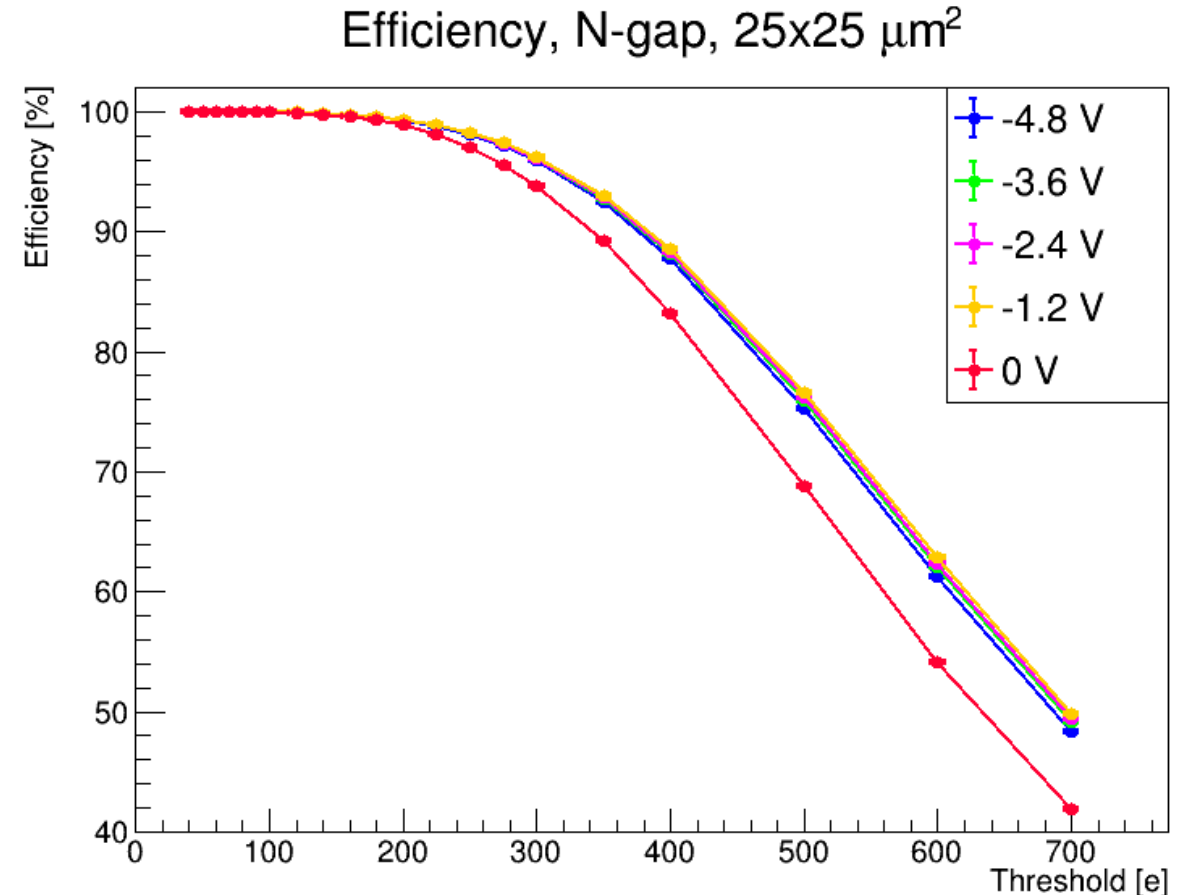

# Simulations compared to data

Does the procedure *actually* work?

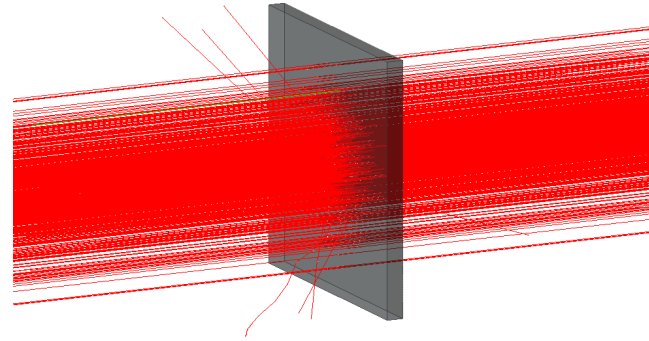
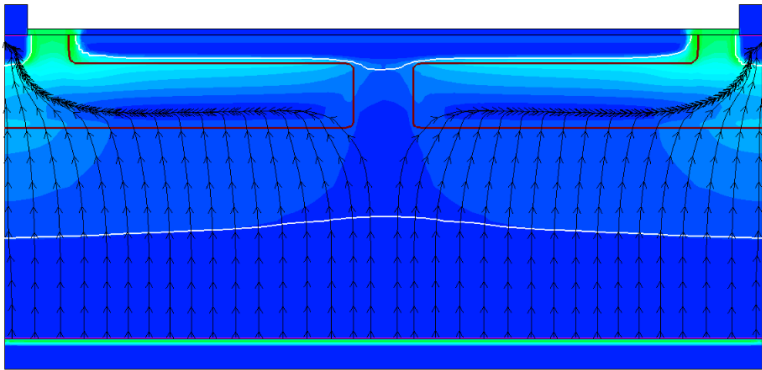

# Allpix<sup>2</sup> combined with TCAD - Preliminary comparison to data

## Example result from the [Tangerine project](#)

- Testbeams have been carried out at DESY, and comparisons made to simulations
- Results from the “Analog Pixel Test Structure” ([APTS](#))
  - N-gap layout
  - 25x25 μm<sup>2</sup> pixel size
  - 4x4 pixel matrix
  - -4.8 V bias voltage
- The trend between simulations and data **matches well**

## Cluster charge distribution

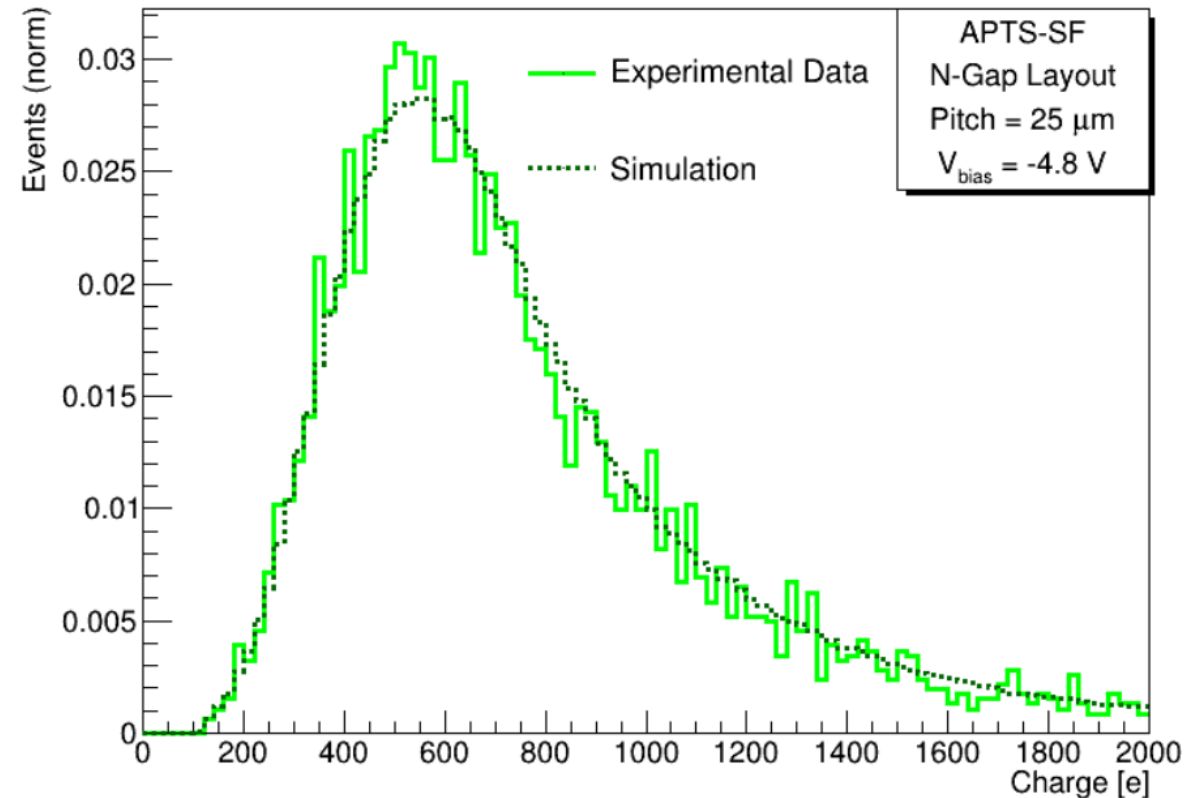

<https://doi.org/10.1016/j.nima.2024.169414>

# Allpix<sup>2</sup> combined with TCAD - Preliminary comparison to data

## Example result from the [Tangerine project](#)

- Testbeams have been carried out at DESY, and comparisons made to simulations
- Results from the “Analog Pixel Test Structure” ([APTS](#))
  - N-gap layout
  - 25x25  $\mu\text{m}^2$  pixel size
  - 4x4 pixel matrix
  - -4.8 V bias voltage
- The trend between simulations and data **matches well**
  - Error bars on the simulated results are purely statistical here
- In conclusion, the developed **simulation procedure works well**, without any proprietary information

## Mean efficiency vs threshold

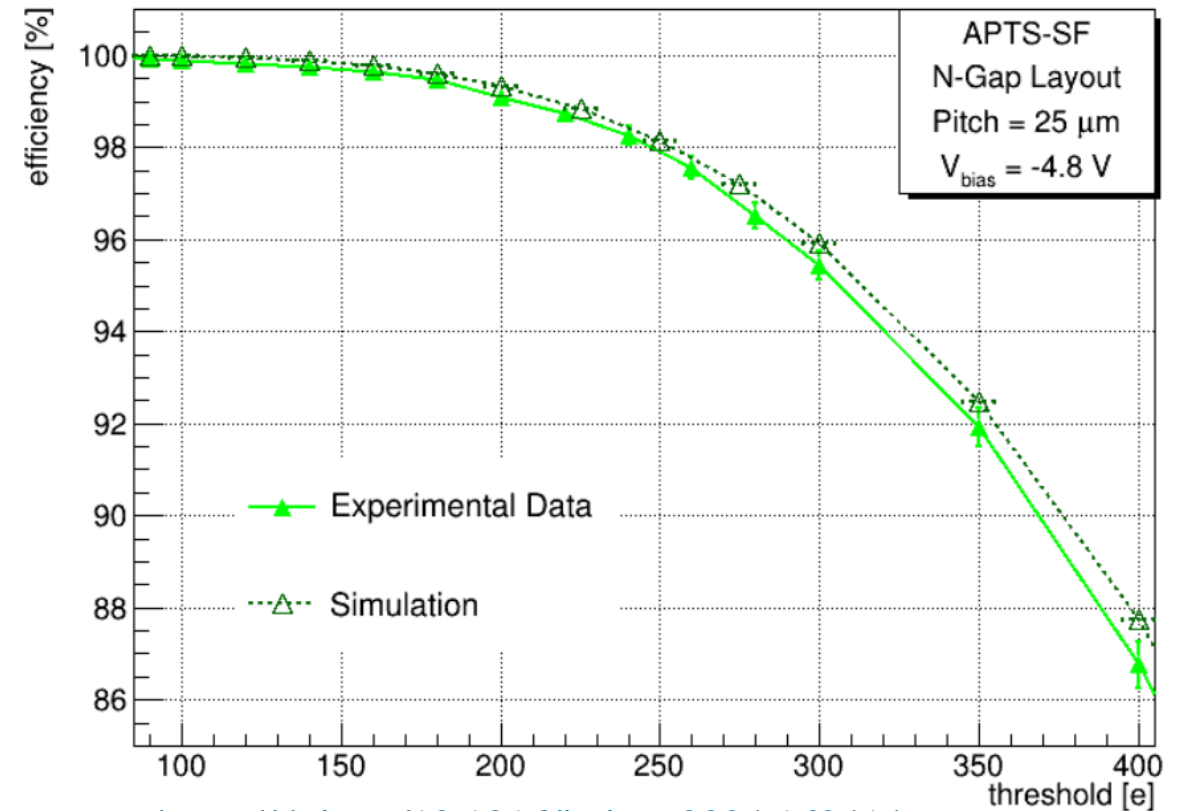

<https://doi.org/10.1016/j.nima.2024.169414>



# Conclusions and outlook

- Simulations are a **powerful tool** for sensor understanding and development
- A technology-independent approach using generic doping profiles has been developed for silicon sensor simulations; a **generic toolbox**, free from proprietary information
- Next steps for **simulations** in the Tangerine project:
  - Properly define the **uncertainties of the simulation results**, by varying parameters and quantifying their impacts
    - So far, error bars are purely statistical
  - **Compare to data** from testbeams carried out on test chips
    - This will allow for **validation of the predictive power** of the simulations
- Accurate simulations will **guide the way** to future sensor submissions

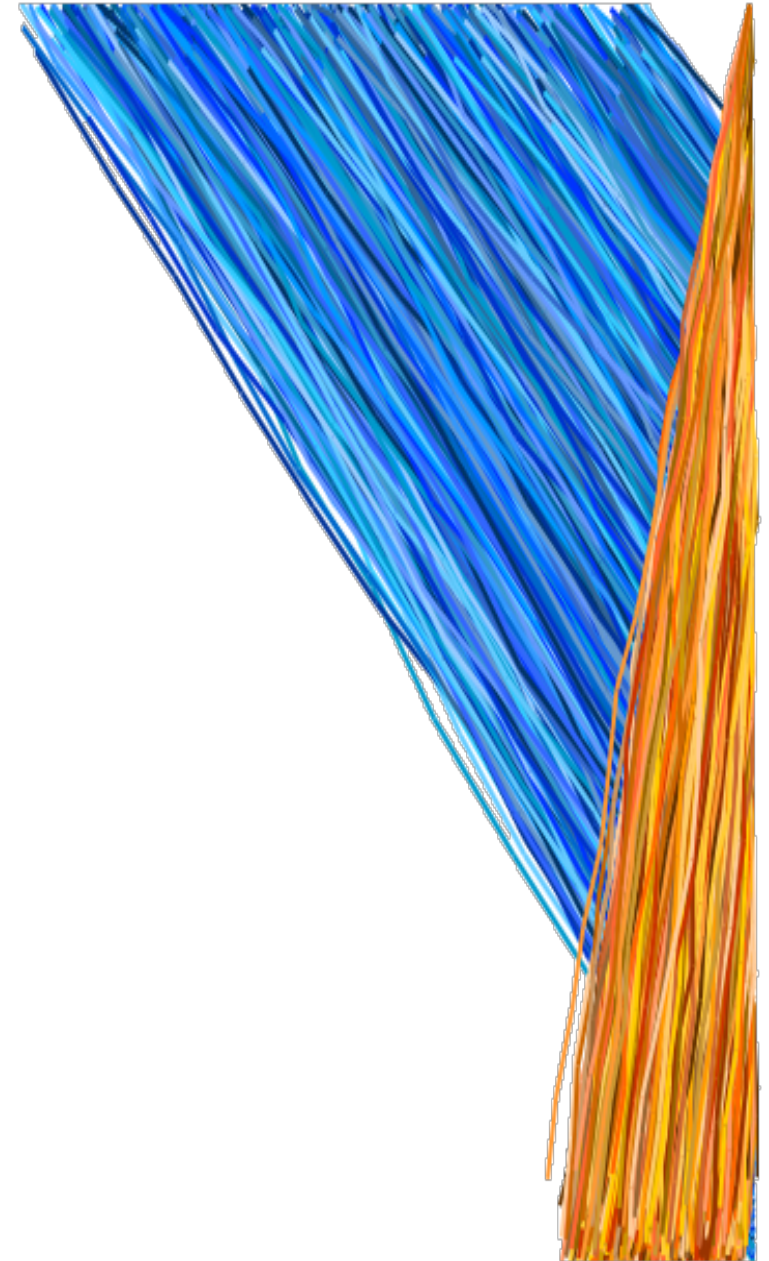

# Backup slides

# Rules followed in determining sensible sensor parameters

- The doping concentrations in the interfaces between different doping structures (n- and p-wells, epitaxial layer/substrate) should be diffused to avoid unphysical effects, such as abrupt changes in doping concentration and the corresponding electric field.
- The p-well must shield its content from the electric field in the active sensor area; the doping must thus be sufficient for it to only be depleted very near its boundaries.
- The charge carriers generated in the sensor volume have to reach the collection electrode.
- There should be no conductive channel between different biased structures, i.e. punch-through in the sensor should be avoided.
- The limitations on the operating voltages of the transistors in the readout electronics should be respected.

# Sensor design

- The sensor design comprises both sensitive volume and electronics design
- For the sensitive volume design, there are three available layouts (all with a **small collection electrode**) originally designed for a 180 nm CMOS imaging process:

- Standard layout
  - ALPIDE-like

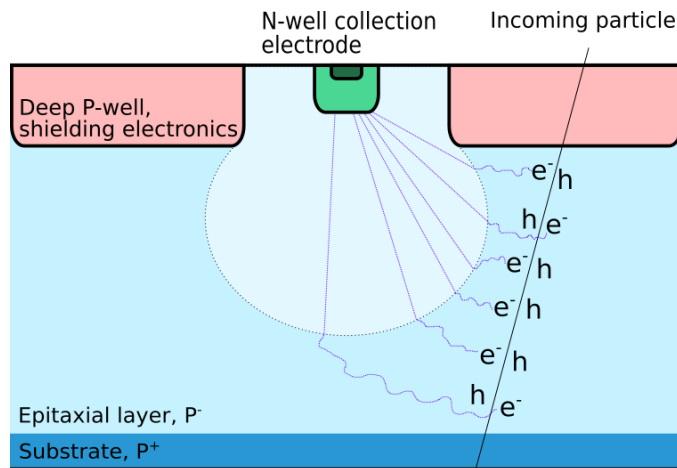

S. Senyukov et al. doi:10.1016/j.nima.2013.03.017

- N-blanket layout
  - Blanket layer of n-doped silicon, creating a **deep planar junction**

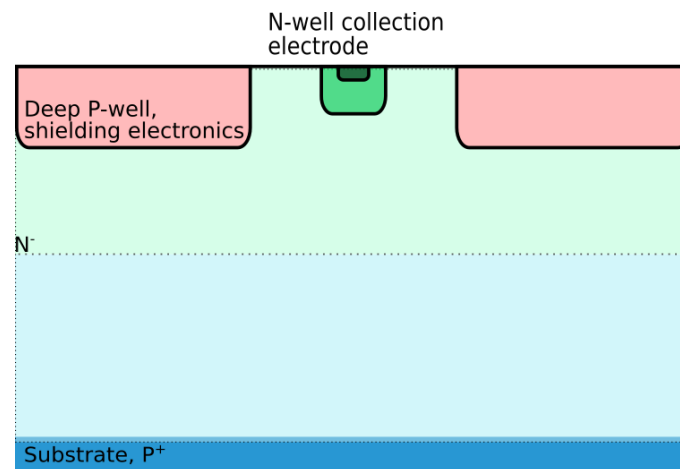

W. Snoeys et al. doi:10.1016/j.nima.2017.07.046

- N-gap layout
  - Blanket n-layer **with gaps at pixel edges**

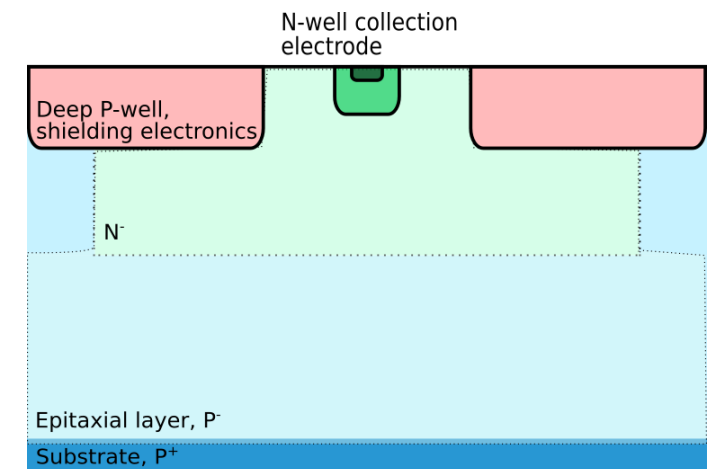

M. Munker et al 2019 JINST 14 C05013

# Monte Carlo simulations using Allpix<sup>2</sup>

## Impact of dopant diffusion simulation

- Linegraphs to demonstrate charge carrier movement
- Without simulated dopant diffusion, a **significant electric field appears** in the epitaxial layer-substrate interface
  - This is **unphysical**
- With simulated dopant diffusion (see slide 9), there is a **smooth transition region** rather than a step function
  - More natural, and provides a better match to data

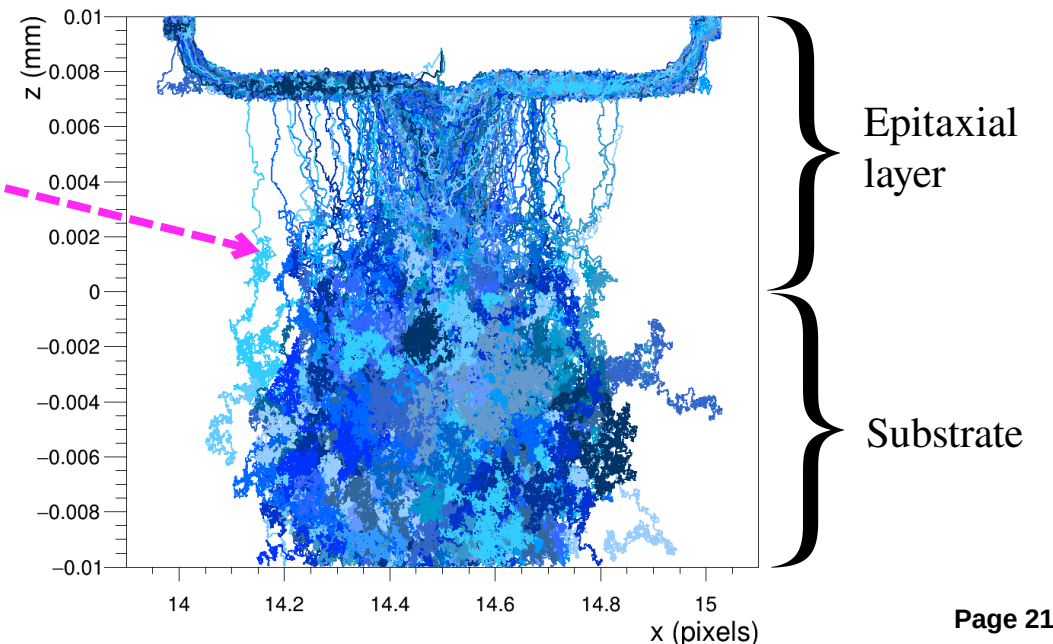
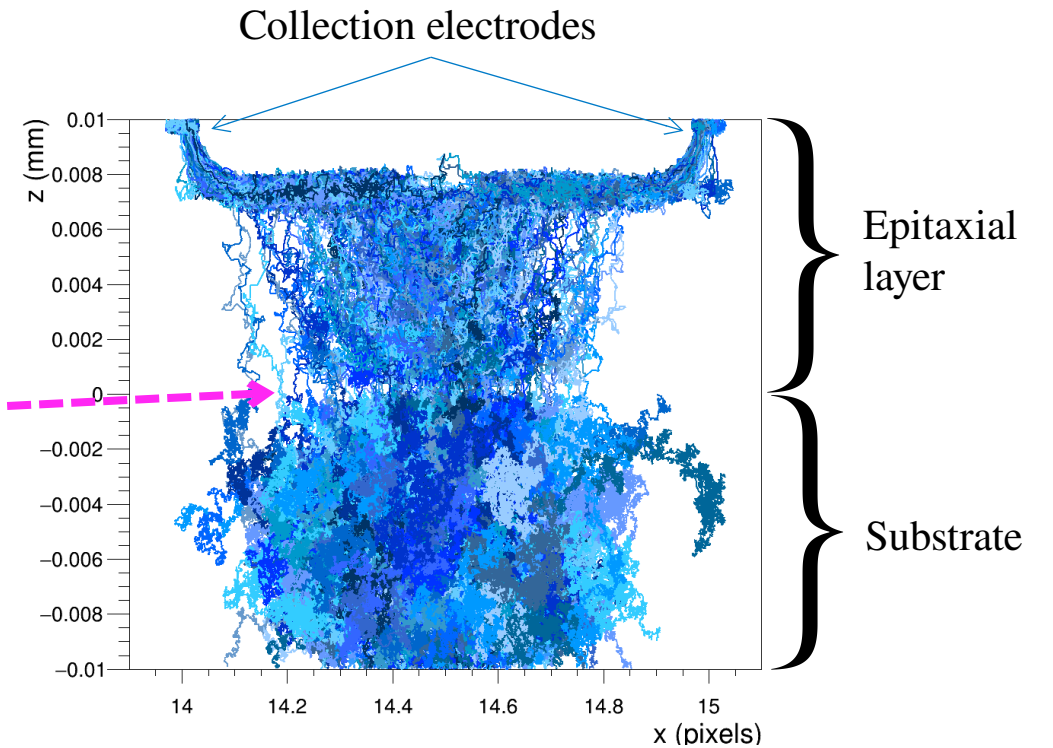

# Transient simulations, comparing TCAD and Allpix<sup>2</sup>

- Generating weighting potentials for use in Allpix<sup>2</sup>, from the electrostatic potentials from TCAD
  - Using Allpix<sup>2</sup> for the transient simulations gives a **lower computational cost**, and allows use of **Geant4 energy deposition**
- First step: compare Allpix<sup>2</sup> results to TCAD results
  - Allpix<sup>2</sup> results are the average of 10 000 events, TCAD is a single event
  - Same settings are used for charge carrier creation and mobility
  - Results in general agreement
- Allows for simulation of sensor **time response** and further **front-end electronics** simulations

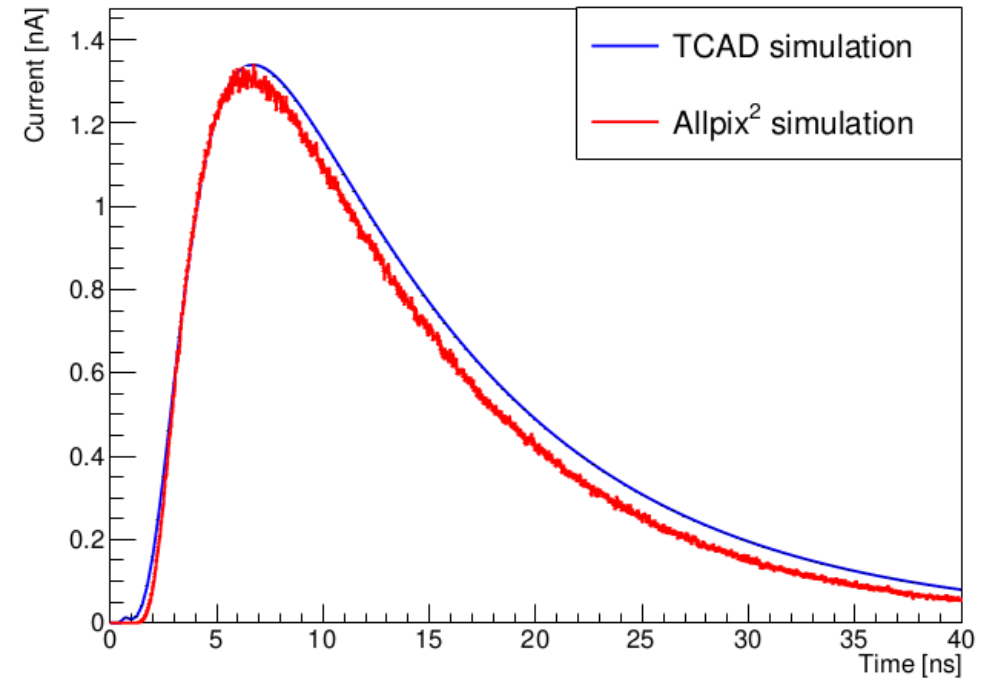

(a) *Standard layout*

# Example observables for sensor characterisation

## Cluster size

- **Number of pixels that register hits for a single incident particle** (charge sharing)
- This will depend on the position of the incident particle, but with a **large number of particles** a mean value can be found, as well as the cluster size versus hit position
- Varies with threshold value

## Efficiency

- Denotes the **fraction of particles incident on the sensor that produce a signal in the sensor**
- Goes between 0 and 1
  - If all particles traversing the sensor produce a signal, the sensor is 100% efficient
  - Desirable to have **as high as possible**
- Strongly related to threshold value
- Can find mean efficiency across the sensor, and look at efficiency versus hit position

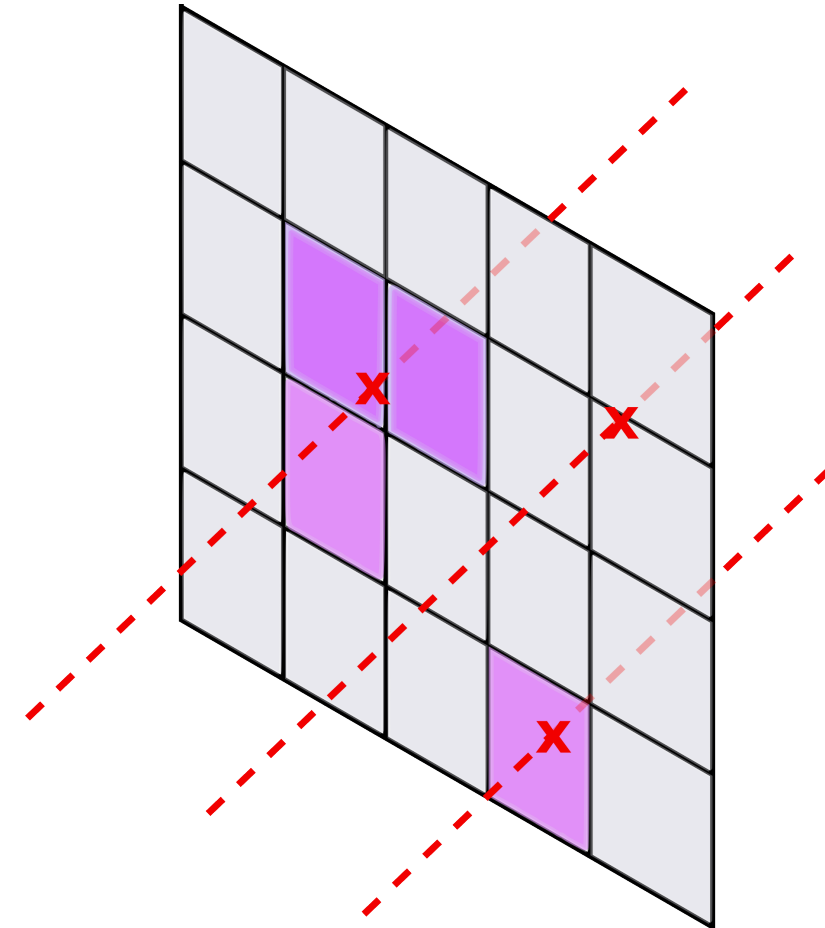
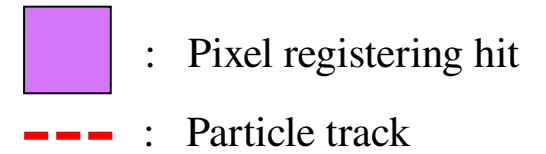

# Monte Carlo simulations using Allpix<sup>2</sup>

## Impact of mobility model

- Mobility model also impacts **final observables**
- High-statistics simulations allow extraction of observables such as cluster size, resolution, efficiency
- Figure shows **sensor efficiency vs detection threshold**, for two different mobility models
  - Simulation carried out with a DESY II-like beam of electrons
  - Each point corresponds to 500 000 events, so the statistical error bars are very small
- The doping-independent mobility model **overestimates efficiency**, due to an excess of charge collected from the highly-doped substrate

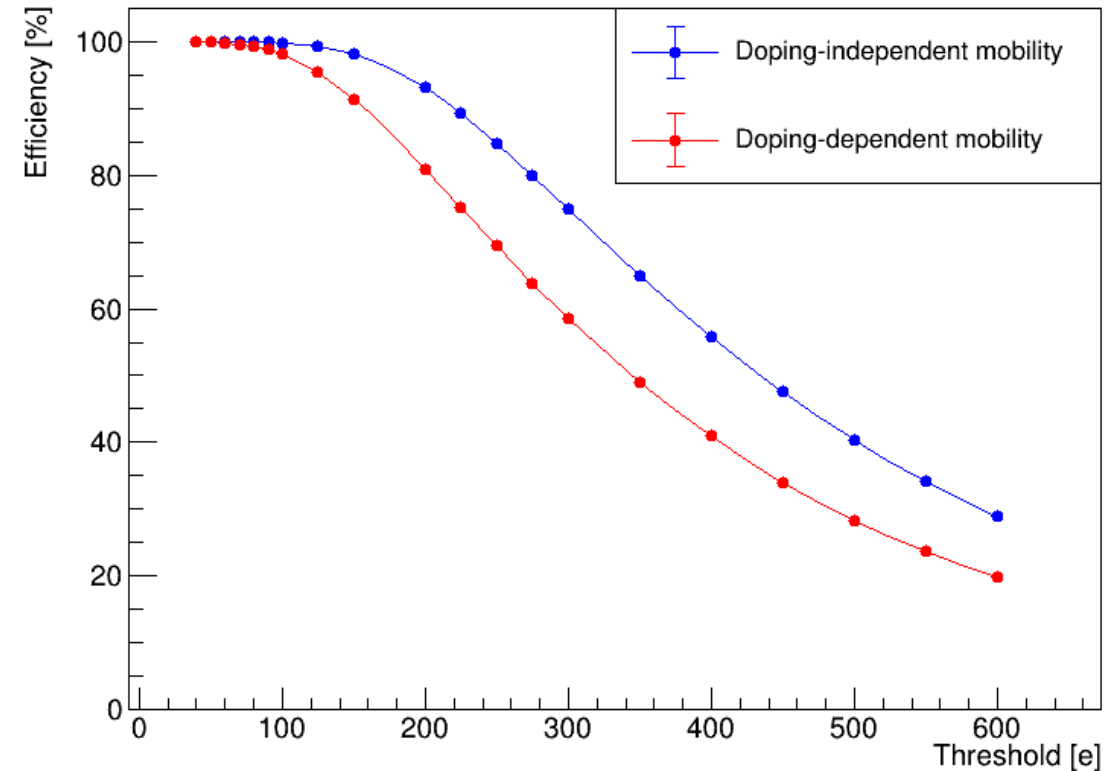

Sensor efficiency vs threshold for two different mobility models



# Allpix<sup>2</sup> combined with TCAD - different pixel geometries □ ⬡

## Example result from the [Tangerine project](#)

- Simulations allow for comparison of the performance of different sensor geometries
- A hexagonal layout leads to **reduced charge sharing in pixel corners** and a reduced distance from pixel boundary to pixel centre
  - May allow efficient operation at higher thresholds, and possibly better spatial resolution
- Tests have been performed comparing square pixels and hexagonal pixels, **maintaining the pixel area**
  - The space available for readout electronics thus remains the same per pixel
- Figure compares hexagonal pixels 18  $\mu\text{m}$  corner-to-corner, and 15x15  $\mu\text{m}^2$  square pixels, in an ALPIDE-like layout

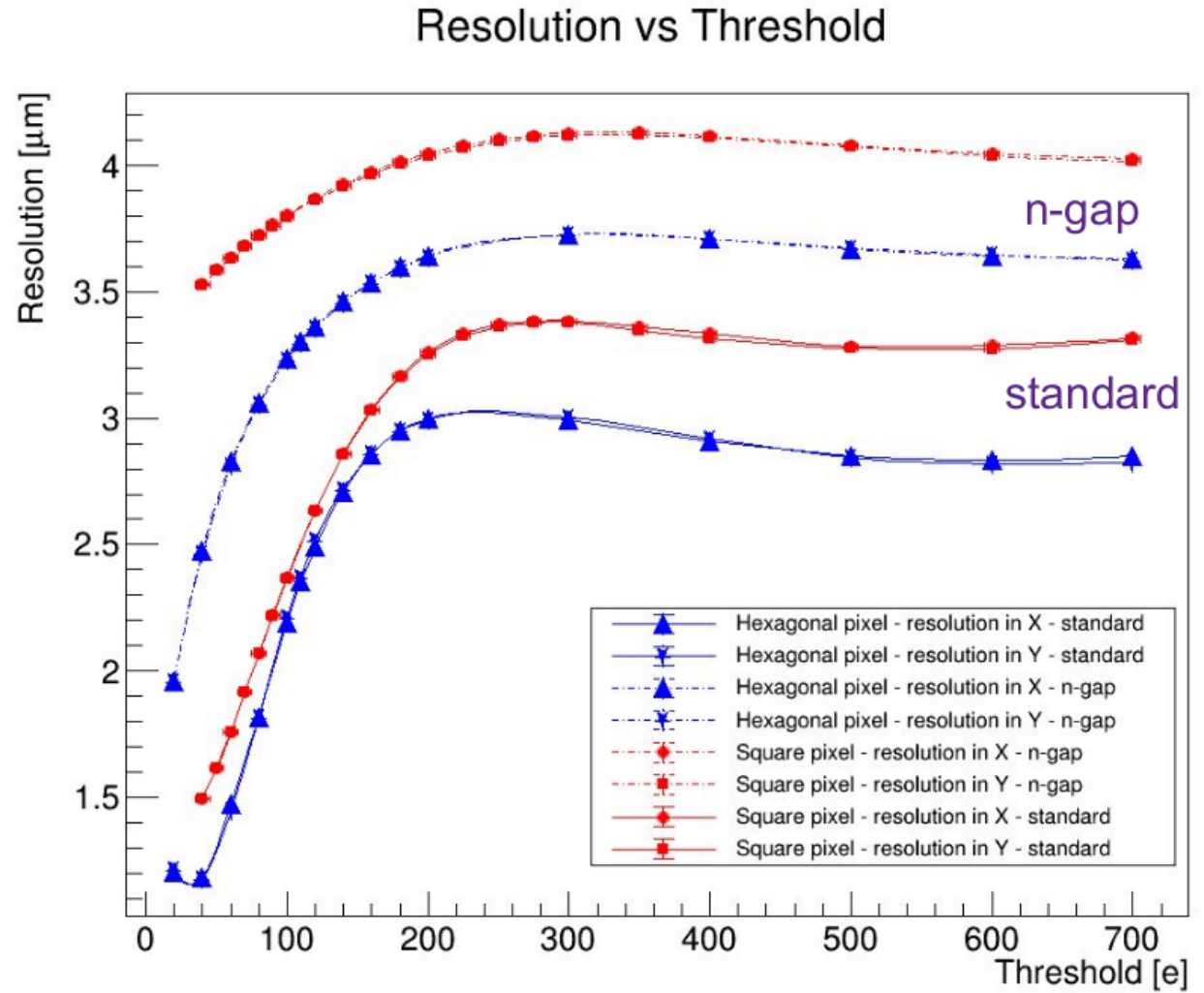

# Allpix<sup>2</sup> combined with TCAD - Charge collection time of DESY ER1

## Example result from the [Tangerine project](#)

- DESY ER1 prototype sensor
- 2x2 matrix with **rectangular pixels** of size 35x25  $\mu\text{m}^2$
- Tests with **iron-55**
  - Signal amplitude results are **unexpected!**
  - Two-peak structure, but **not**  $K_\alpha$  and  $K_\beta$
- Theory: deposits far from pixel centre get **collected slowly**, so some charge **drains away before peaking**
- Higher Krummenacher current (i.e. faster return to baseline) leads to **two-peak structure** of single-energy x-ray

Amplitude histogram:

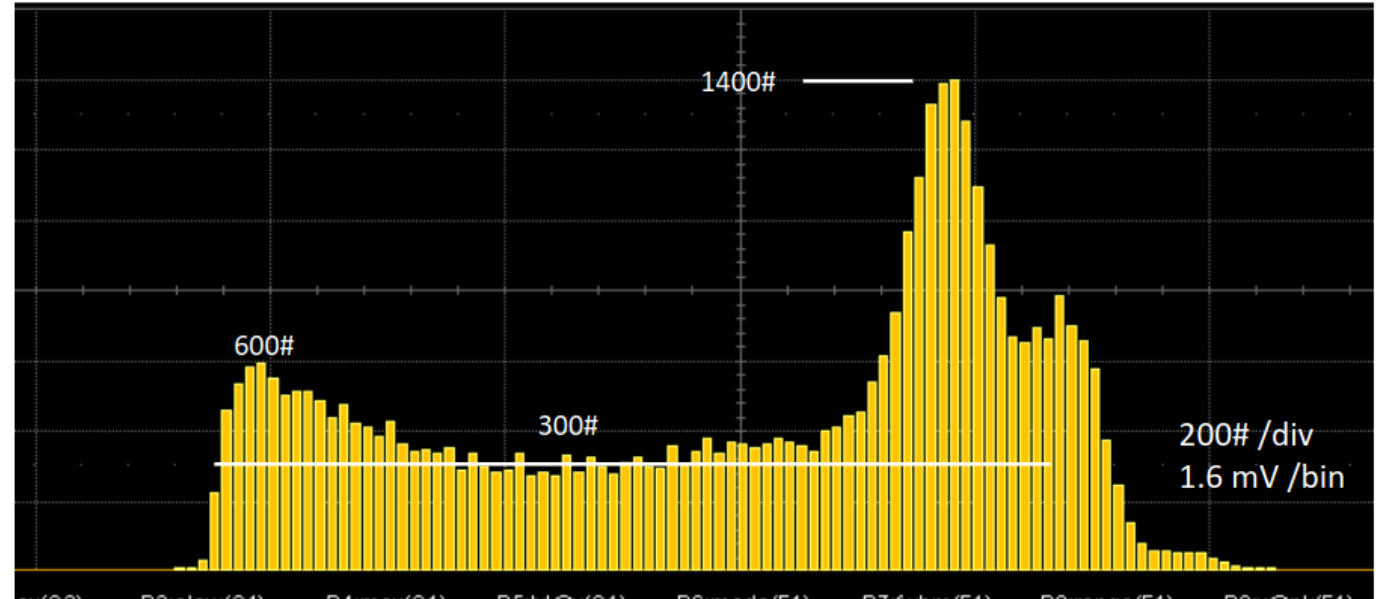

<https://indico.desy.de/event/43834/contributions/167831>

# Allpix<sup>2</sup> combined with TCAD - Charge collection time of DESY ER1

## Example result from the [Tangerine project](#)

- Charge deposition simulated over a full pixel, with 1640 electrons in each point
- Plot shows time taken to collect 1600 electrons
- There are **clear regions of different collection time**
- This can explain the two-peak structure seen in lab tests
  - Slower collection means that **more charge drains away** before peaking, leading to a **lower maximum amplitude**

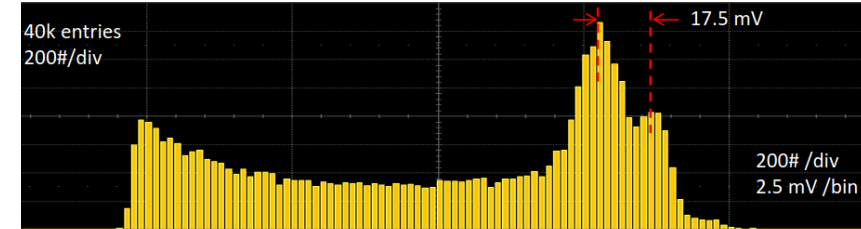

Average time to reach 1600 electrons

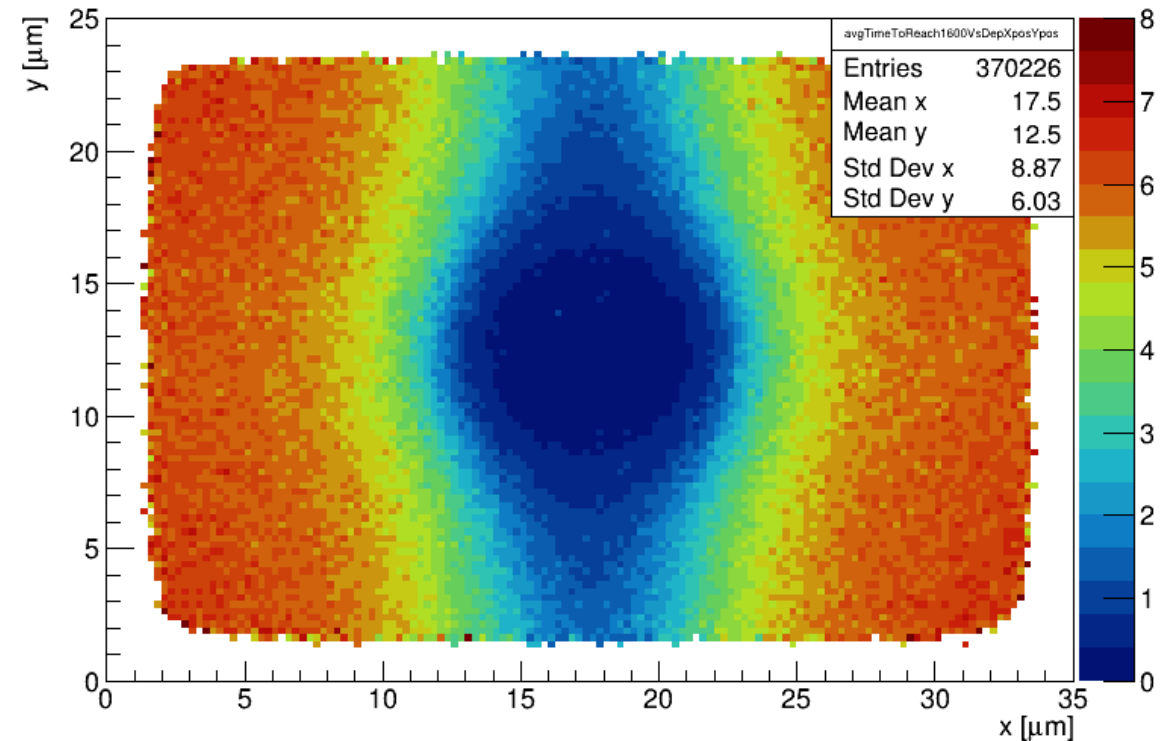

# Allpix<sup>2</sup> combined with TCAD - Charge collection time of DESY ER1

## Example result from the [Tangerine project](#)

- Charge deposition simulated over a full pixel, with 1640 electrons in each point
- Plot shows time taken to collect 1600 electrons
- There are **clear regions of different collection time**
- This can explain the two-peak structure seen in lab tests
  - Slower collection means that **more charge drains away** before peaking, leading to a **lower maximum amplitude**

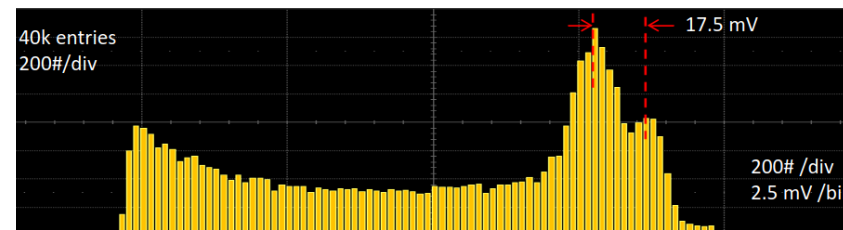

Average time to reach 1600 electrons

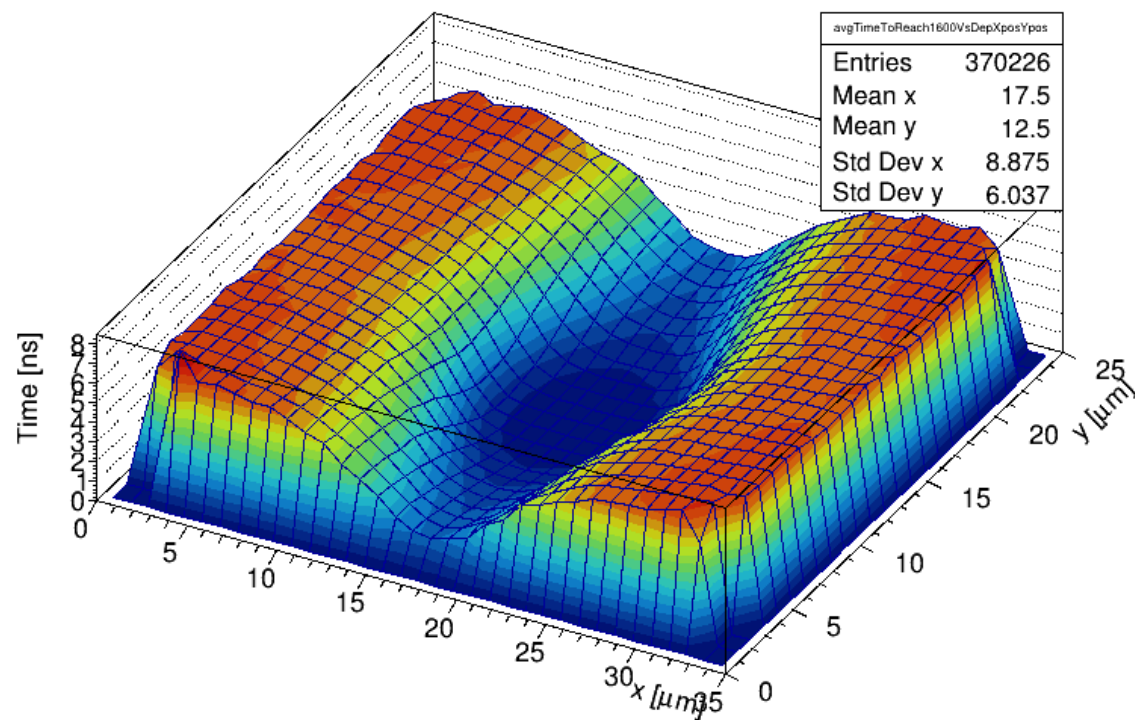

# Allpix<sup>2</sup> combined with TCAD - Charge collection time of DESY ER1

## Example result from the [Tangerine project](#)

- Lateral electric field magnitude
- In x, we have a **region with low field** between gap and collection electrode
- This is also in y, but **much smaller due to the smaller distance** - we never go as low as in x
- This leads to overall faster charge collection, as charges are **constantly pushed** towards the collection electrode
- Simulations are a **powerful tool** for providing **understanding** of results

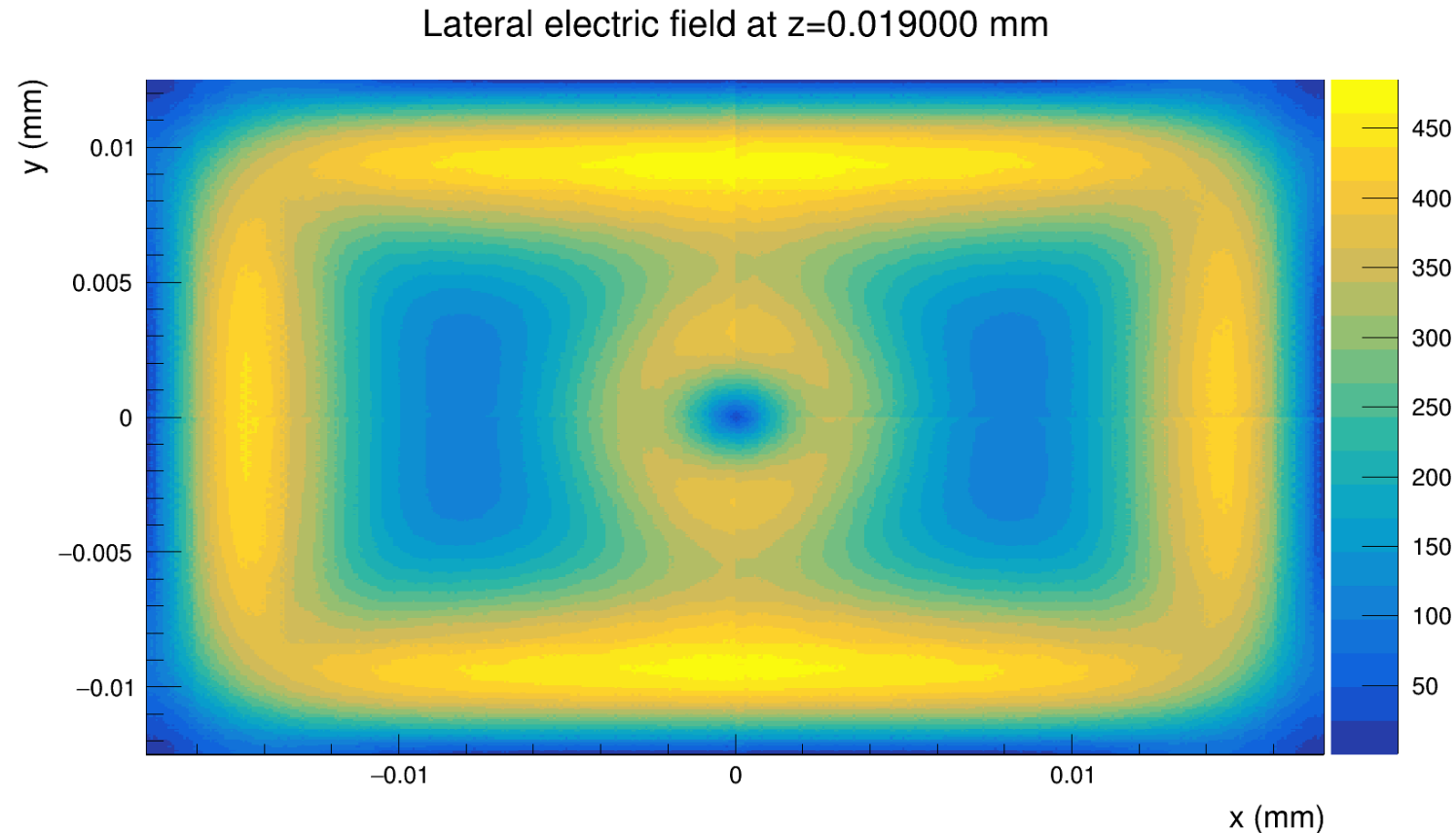

# Transient simulations, comparing linear energy deposition to Geant4

- Using the n-blanket layout
- Each signal is the average of 10 000 events, incident in the pixel corner
- Geant4 energy deposition includes stochastic effects, while linear deposit generates 63 electron-hole pairs per  $\mu\text{m}$

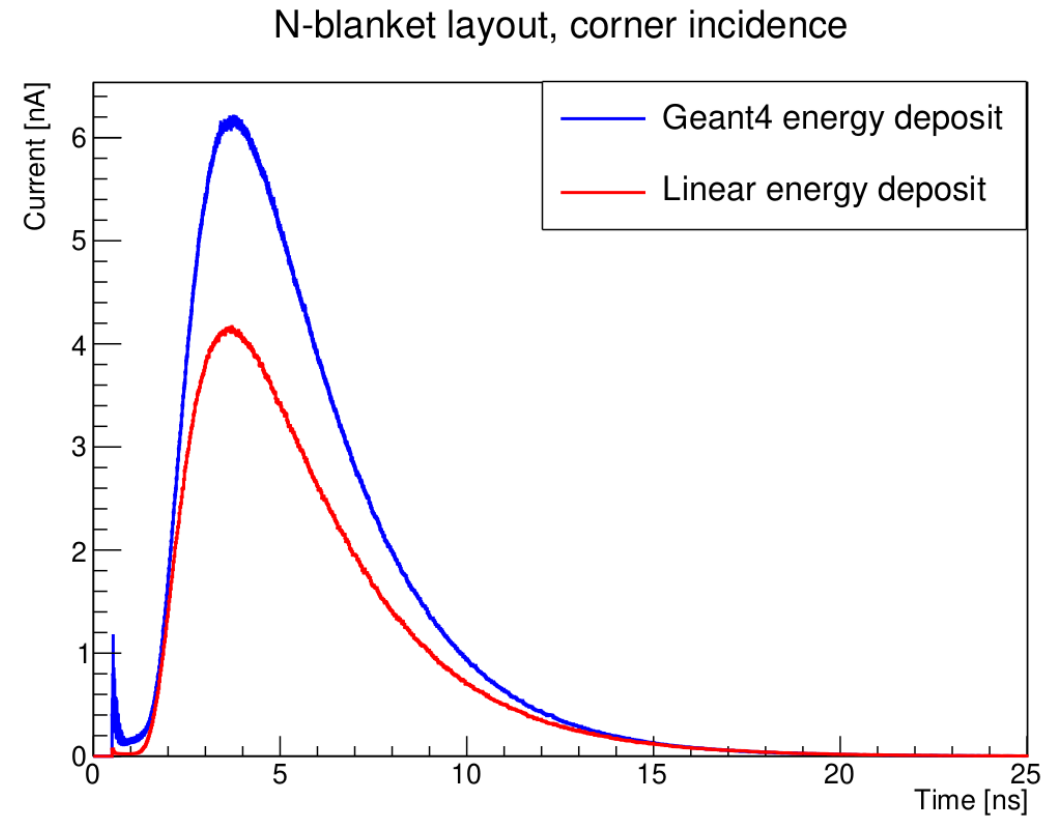

# The Tangerine project: published references

- The Tangerine project: Development of high-resolution 65 nm silicon MAPS
  - <https://doi.org/10.1016/j.nima.2022.167025>
- Towards a new generation of Monolithic Active Pixel Sensors
  - <https://doi.org/10.1016/j.nima.2022.167821>
- Developing a Monolithic Silicon Sensor in a 65 nm CMOS Imaging Technology for Future Lepton Collider Vertex Detectors
  - <https://doi.org/10.1109/NSS/MIC44845.2022.10398964>
- Simulations and performance studies of a MAPS in 65 nm CMOS imaging technology
  - <https://doi.org/10.1016/j.nima.2024.169414>

