

FCC Feasibility Study Status

FCC Week, 10 June 2024

Michael Benedikt, Frank Zimmermann, CERN
on behalf of FCC collaboration & FCCIS DS team



Swiss Accelerator
Research and
Technology

<http://cern.ch/fcc>



Work supported by the **European Commission** under the **HORIZON 2020** projects **EuroCirCol**, grant agreement 654305; **EASITrain**, grant agreement no. 764879; **iFAST**, grant agreement 101004730, **FCCIS**, grant agreement 951754; **E-JADE**, contract no. 645479; **EAJADE**, contract number 101086276; and by the Swiss **CHART** program



European
Commission

Horizon 2020
European Union funding
for Research & Innovation

photo: J. Wenninger

FCC integrated program

comprehensive long-term program maximizing physics opportunities

- stage 1: FCC-ee (Z, W, H, $t\bar{t}$) as Higgs factory, electroweak & top factory at highest luminosities
- stage 2: FCC-hh (~100 TeV) as natural continuation at energy frontier, pp & AA collisions; e-h option
- highly synergetic and complementary programme boosting the physics reach of both colliders
- common civil engineering and technical infrastructures, building on and reusing CERN's existing infrastructure
- FCC integrated project allows the start of a new, major facility at CERN within a few years of the end of HL-LHC

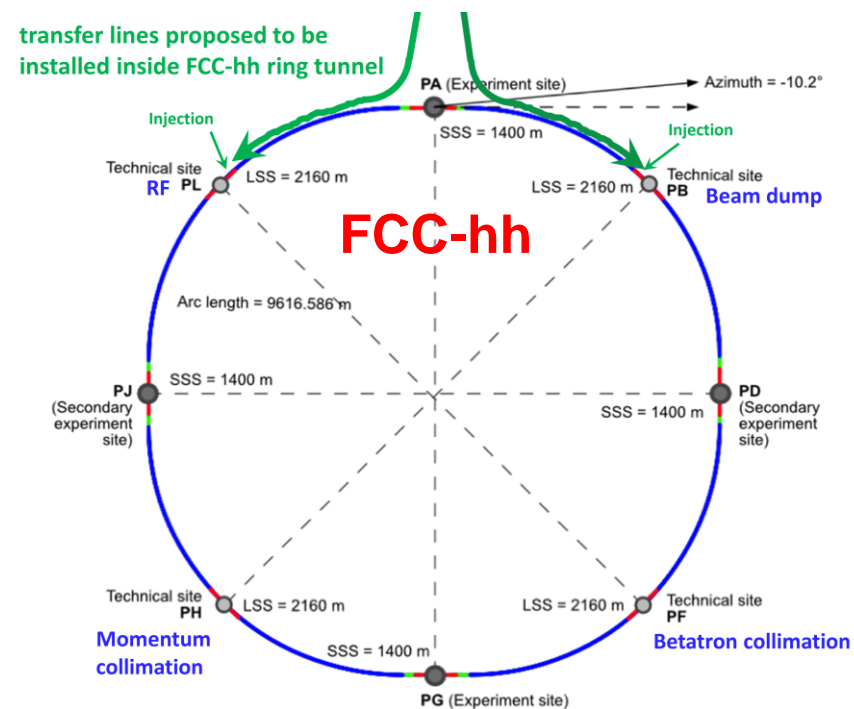
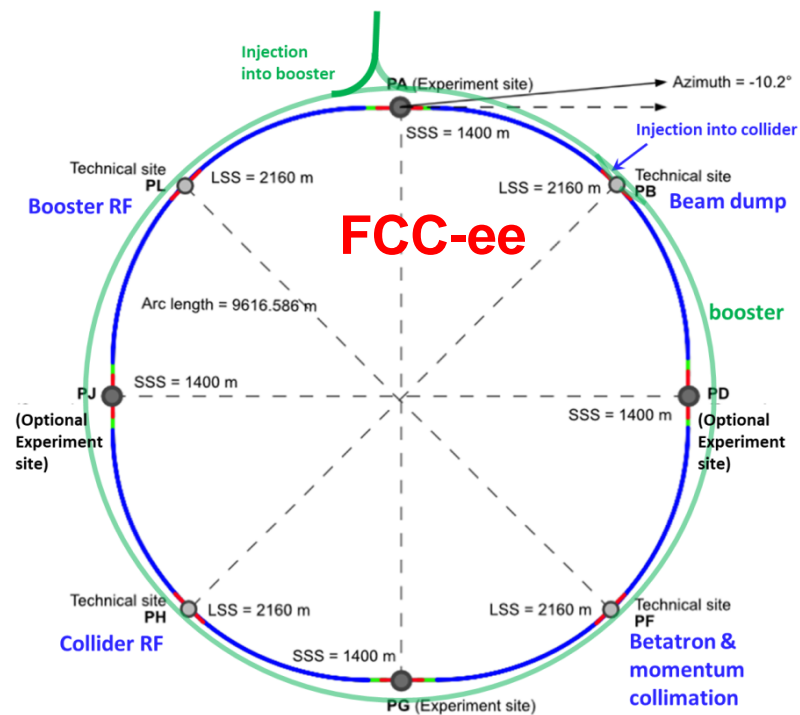
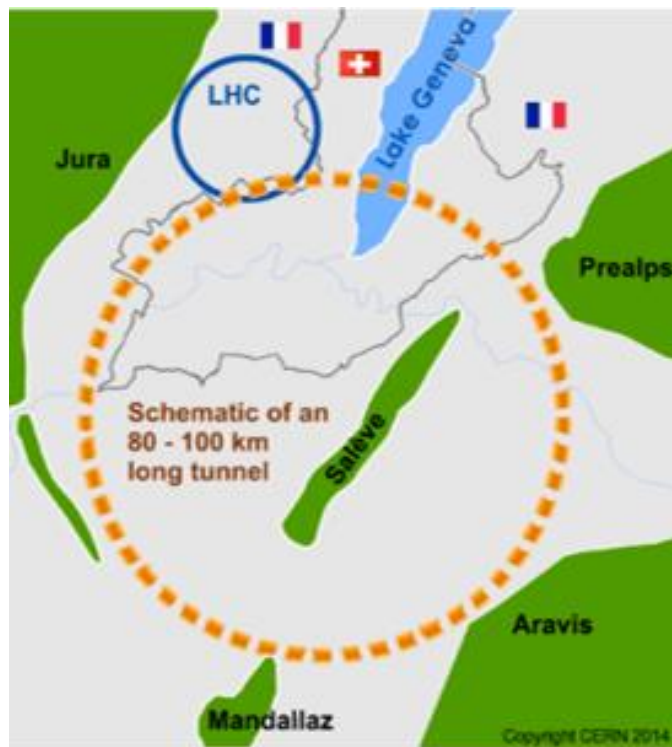

- ❑ demonstration of the geological, technical, environmental and administrative feasibility of the tunnel and surface areas and optimisation of placement and layout of the ring and related infrastructure;
- ❑ pursuit, together with the Host States, of the preparatory administrative processes required for a potential project approval to identify and remove any showstopper;
- ❑ optimisation of the design of the colliders and their injector chains, supported by R&D to develop the needed key technologies;
- ❑ elaboration of a sustainable operational model for the colliders and experiments in terms of human and financial resource needs, as well as environmental aspects and energy efficiency;
- ❑ development of a consolidated cost estimate, as well as the funding and organisational models needed to enable the project's technical design completion, implementation and operation;
- ❑ identification of substantial resources from outside CERN's budget for the implementation of the first stage of a possible future project (tunnel and FCC-ee);
- ❑ consolidation of the physics case and detector concepts for both colliders.

Results will be summarised in a Feasibility Study Report to be released by March 2025

Feasibility Study Mid-Term Review passed !

The goal of the FCC FS mid-term review is to assess the progress of the Study towards the final report.

Deliverables approved by the Council in September 2022:

https://indico.cern.ch/event/1197445/contributions/5034859/attachments/2510649/4315140/spc-e-1183-Rev2-c-e-3654-Rev2_FCC_Mid_Term_Review.pdf

Deliverables:

- D1 : Definition of the baseline scenario
- D2 : Civil engineering
- D3 : Processes and implementation studies with the Host States
- D4 : Technical infrastructure
- D5 : FCC-ee accelerator
- D6: FCC-hh accelerator
- D7: Project cost and financial feasibility
- D8: Physics, experiments and detectors

Future Circular Collider Midterm Report

February 2024

Edited by:

B. Auchmann, W. Bartmann, M. Benedikt, J.P. Burnet, P. Craievich,
M. Giovannozzi, C. Grojean, J. Gutleber, K. Hanke, P. Janot, M. Mangano,
J. Osborne, J. Poole, T. Raubenheimer, T. Watson, F. Zimmermann

 This project has received funding under the European Union's
Horizon 2020 research and innovation programme under grant
agreement No 951754.

This document has been produced by the organisations participating in the
FCC feasibility study. The studies and technical concepts presented here
do not represent an agreement or commitment of any of CERN's Member
States or of the European Union for the construction and operation of an
extension to CERN's existing research infrastructures.
The midterm report of the FCC Feasibility Study reflects work in progress
and should therefore not be propagated to people who do not have direct
access to this document.

Full Report

- 8 Chapters/Deliverables
- ~ 700pp document
- ~ 16 editors
- ~ 500 contributors

Many thanks to the SAC,
CRP, SPC, FC and the
Council for the very useful
reviews!

Documents:

- Mid-term report (all deliverables except D7)
- Executive Summary of mid-term report
- Updated cost assessment (D7)
- Funding model (D7)

Review process:

- Oct 2023: Scientific Advisory Committee (scientific and technical aspects)
and Cost Review Panel (ad hoc committee; cost and financial aspects)
- Nov 2023: SPC and FC
- 2 Feb 2024: Council

All deliverables met, no technical showstoppers

→70-80 recommendations

- **Completion of technical work for Feasibility Study until end 2024**
 - Implementation of recommendations of the mid-term review
 - Focus on “feasibility items” and items with important impact on cost/performance
 - Develop a risk register
 - Update cost estimate to reach cat 3 level on cost uncertainty (-20% / +30%).
 - Further develop the funding model based on discussions with CERN Council
- **Complete FS by March 2025 as input for ESPP update.**
- **In parallel, continue work with host states on project definition and responsibilities, authorization procedures, excavation material strategy and regional implementation development.**

Structure: 3 Volumes

- **Vol. 1:** *Physics, Experiments and Detectors (~200 pages)*
- **Vol. 2:** *Accelerators, Technical Infrastructures, Safety Concepts (~370 pages)*
- **Vol. 3:** *Civil Engineering, Implementation & Sustainability (~200 pages)*

Input for Update of European Strategy for Particle Physics

to be prepared with Overleaf & published by EPJ (Springer-Nature) – FCCIS members



In addition documentation on Cost Estimate – Funding Models

Main goal is to provide all information to Council to allow taking a decision on the project **by end of 2027 or early 2028**

- Further develop the civil engineering and the technical design of all major systems and components, so as to provide a **more detailed cost estimate** with reduced uncertainties
 - Continuation of **technical R&D activities**
 - Work with host states on **regional implementation development and authorization process definition to enable launch of environmental impact study in 2026**
 - Continuation of site investigations and perform an **overall integration study to specify requirements of technical infrastructure, accelerators and detectors**
 - **Provision of input for civil engineering design if the project goes ahead.**
- Work with international partners to define roles and work packages

Expected time line till start of construction

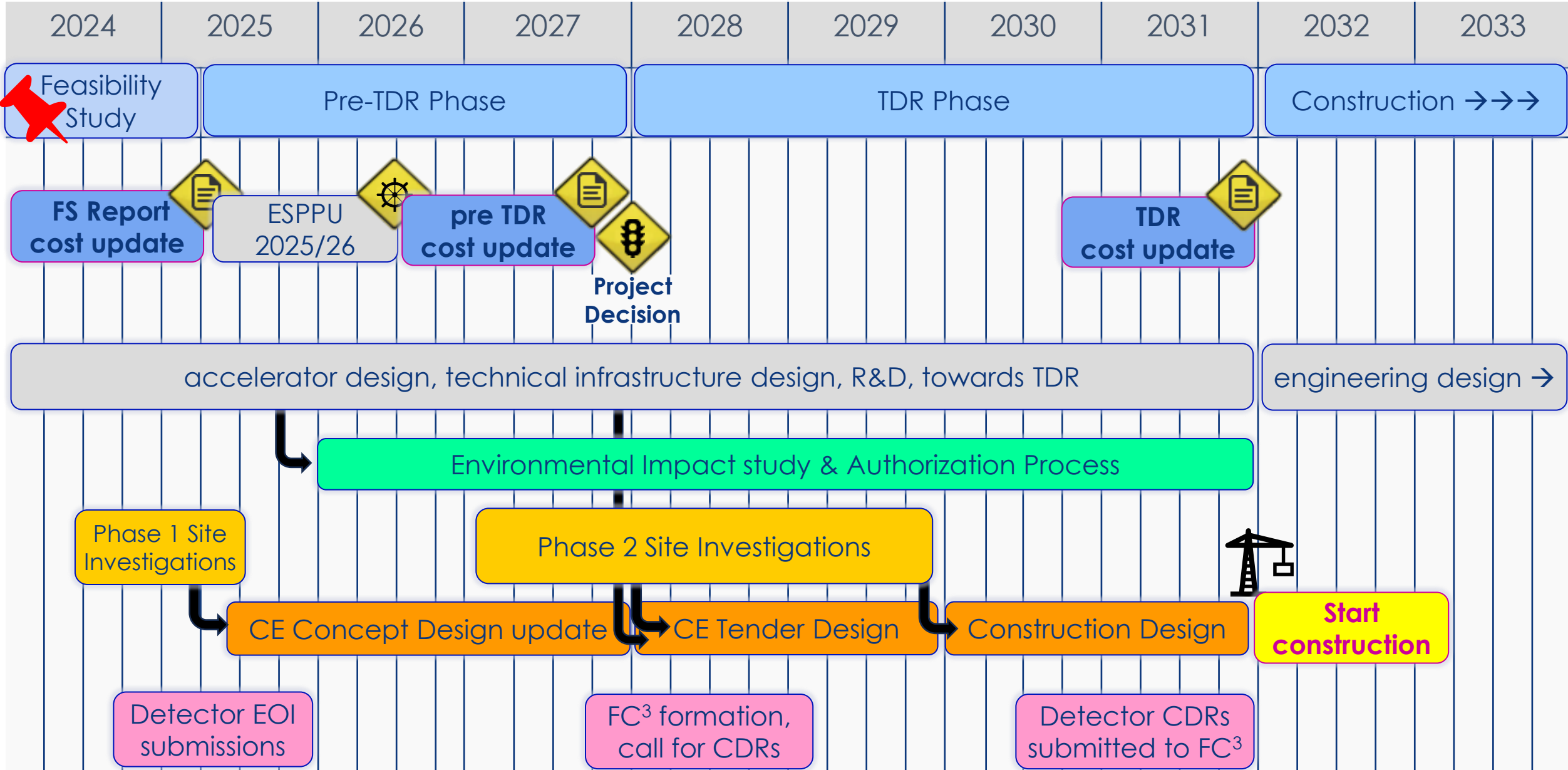

Reference layout and implementation: PA31 - 90.7 km

Layout chosen out of ~ 100 initial variants, based on **geology** and **surface constraints** (land availability, access to roads, etc.), **environment**, (protected zones), **infrastructure** (water, electricity, transport), **machine performance** etc.

“Avoid-reduce-compensate” principle of EU and French regulations

Overall lowest-risk baseline: 90.7 km ring, 8 surface points, 4-fold symmetry

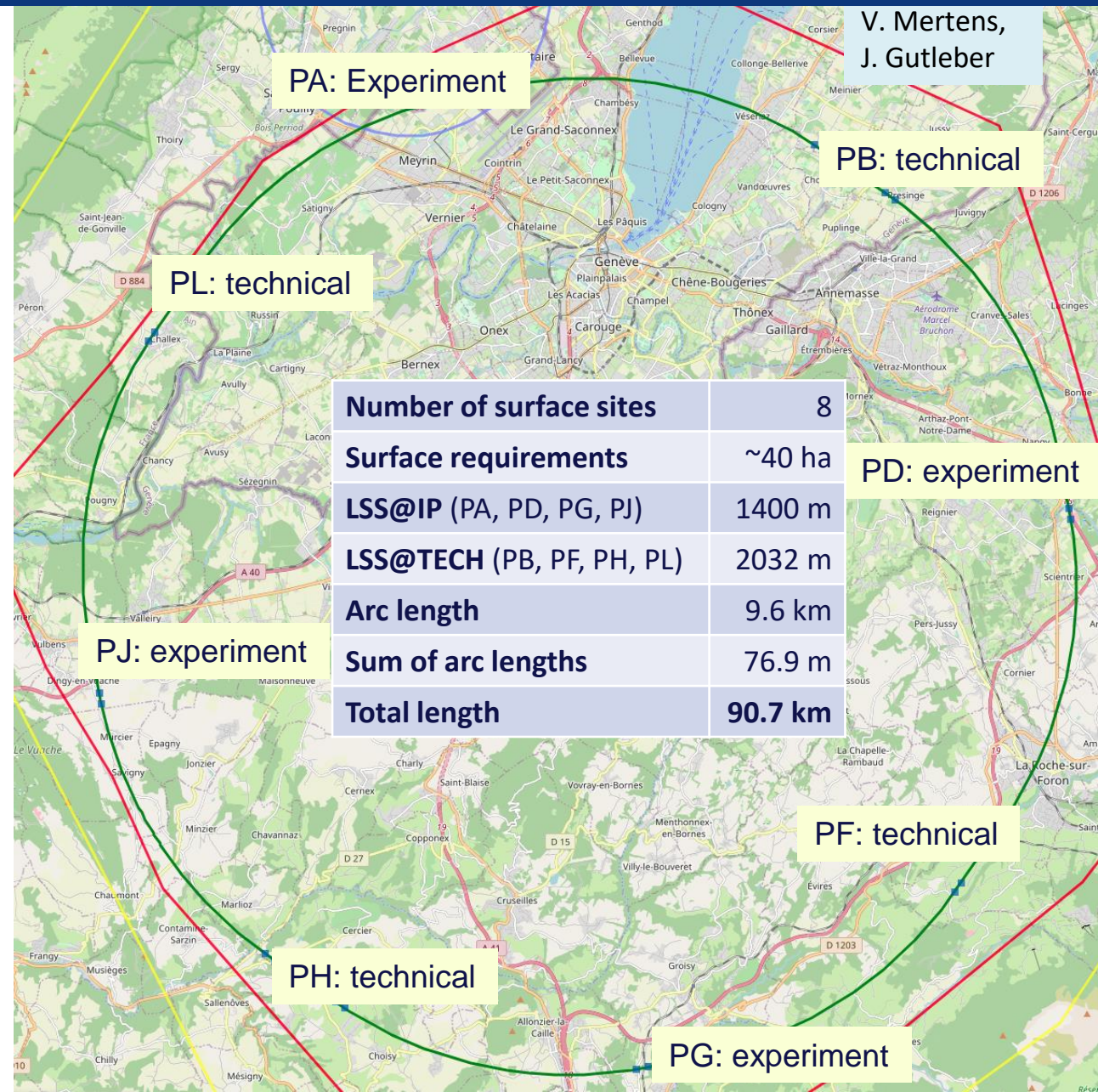
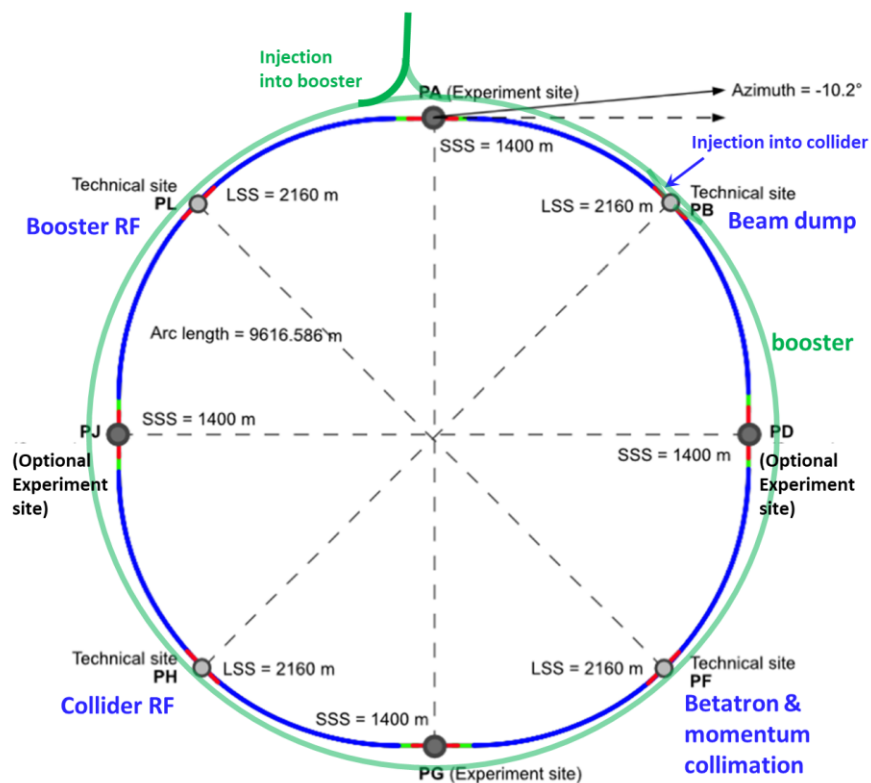

Number of surface sites	8
Surface requirements	~40 ha
LSS@IP (PA, PD, PG, PJ)	1400 m
LSS@TECH (PB, PF, PH, PL)	2032 m
Arc length	9.6 km
Sum of arc lengths	76.9 m
Total length	90.7 km

V. Mertens,
J. Gutleber

Meetings with municipalities concerned in France (31) and Switzerland (10)

PA – Ferney Voltaire (FR) – experiment site

PB – Présinge/Choulex (CH) – technical site

PD – Nangy (FR) – experiment site

PF – Roche sur Foron/Etaux (FR) – technical site

PG – Charvonnex/Groisy (FR) – experiment site

PH – Cercier (FR) – technical site

PJ – Vulbens/Dingy en Vuache (FR) experiment site

PL – Challex (FR) – technical site

Detailed work with municipalities and host states

- identify land plots for surface sites
- understand specific aspects for design
- identify opportunities (waste heat, tec.)
- reserve land plots until project decision

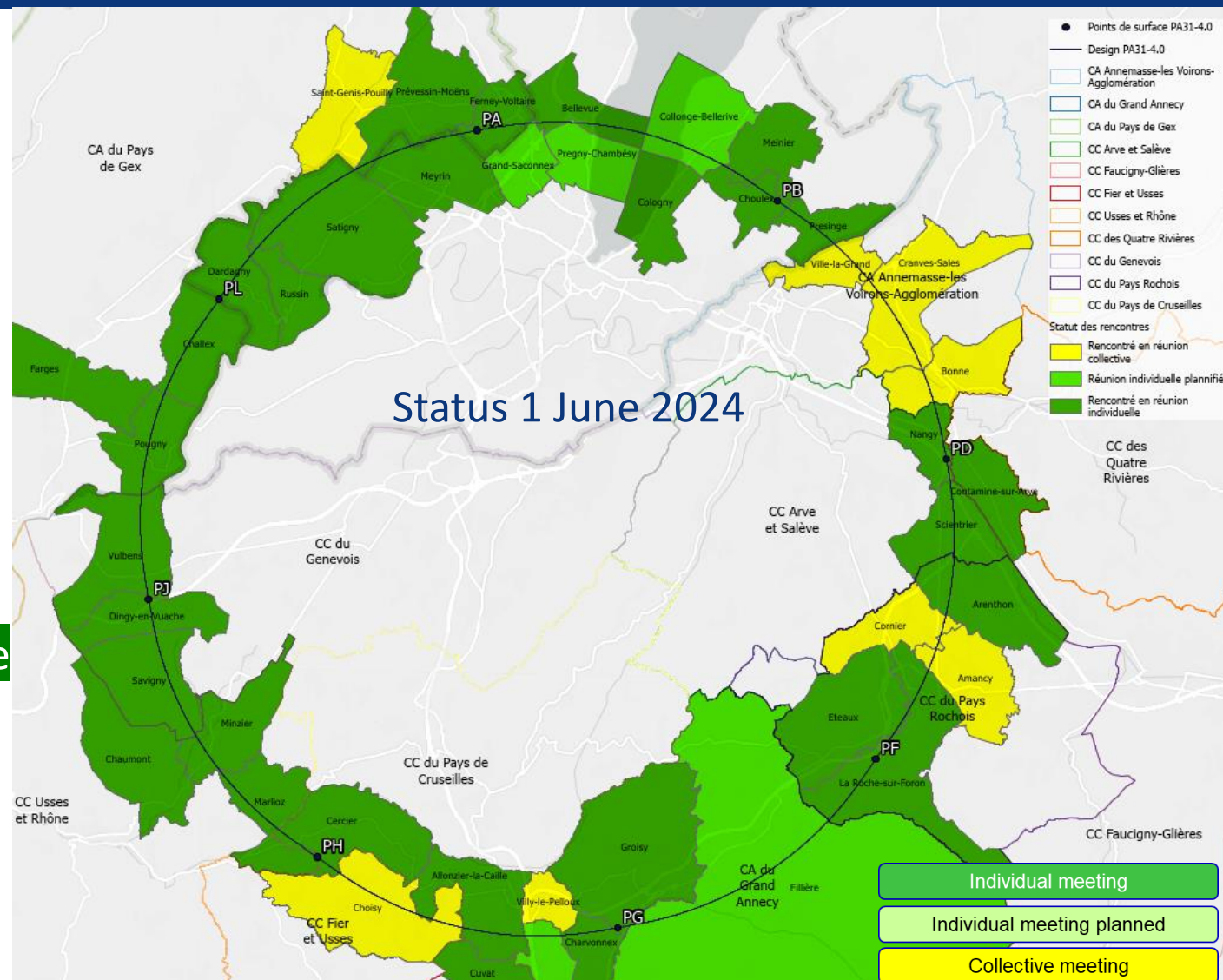

The support of the host states is greatly appreciated and essential for the study progress!

First series of site investigations

Site investigations to identify exact location of geological interfaces:

- Molasse layer vs moraines/limestone
- ~30 drillings and ~100 km seismic lines
- Start in July 2024

→ Vertical position and inclination of tunnel

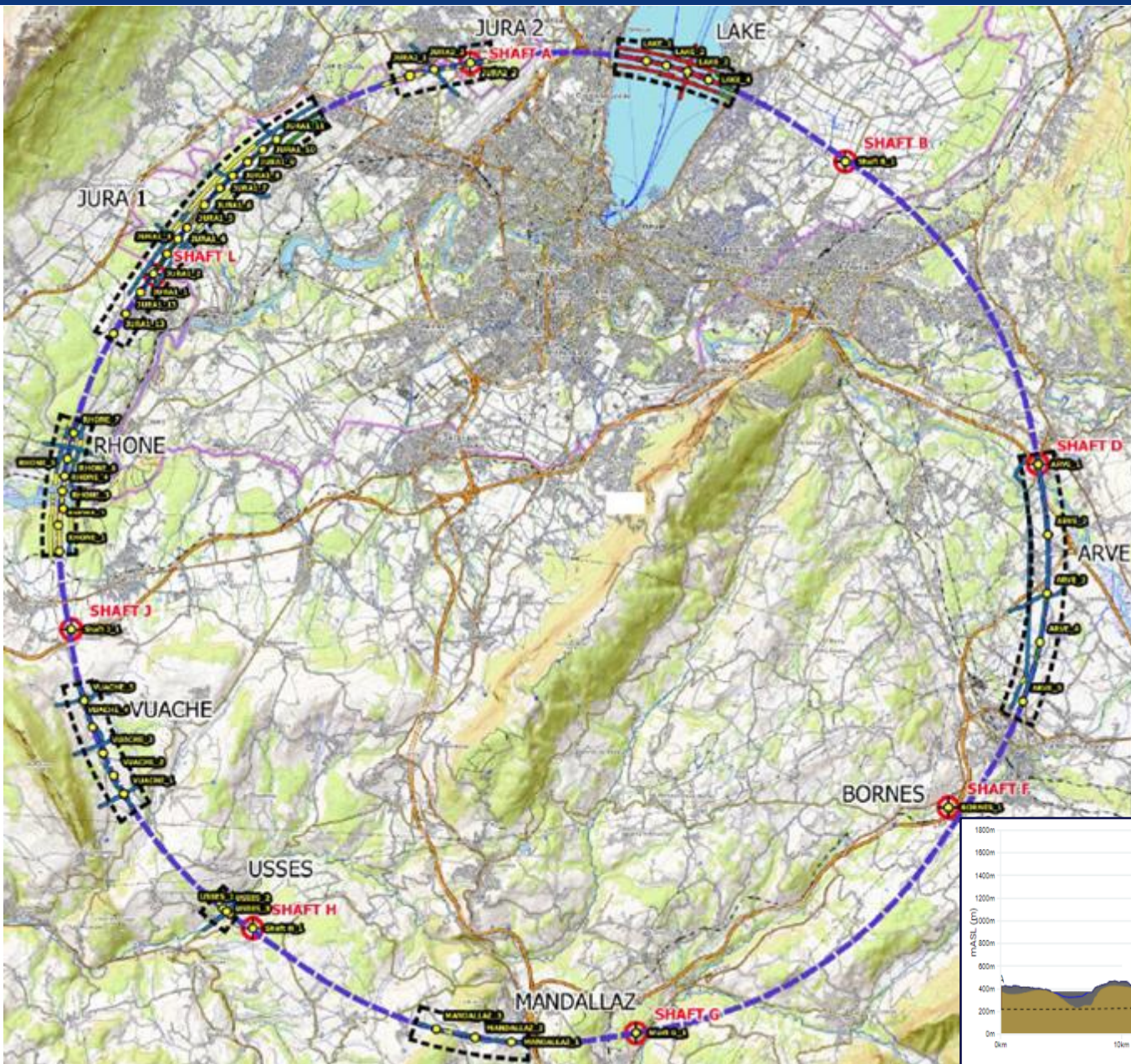

Sondage A89 (2007) incliné de 45° de 125 ml (surface plateforme estimée : 12 x 12 m soit environ 150 m²)



Drilling works on the lake

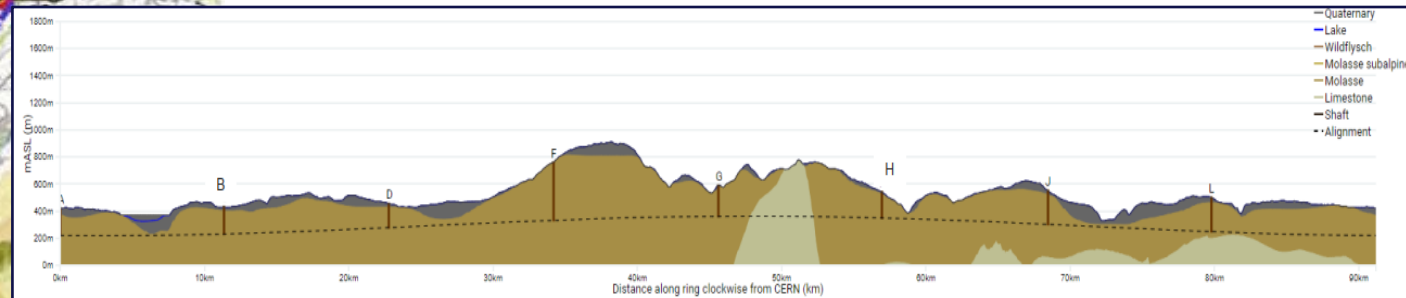

Start of public information & engagement sessions

First public information and discussion meeting at the Science Gateway on the 24th April at CERN.



The meeting was organised for the local community of our Host States, France and Switzerland, in the Science Gateway. The "Progress of the feasibility study of the Future FCC circular collider" was followed by a discussion with the participants.

La Roche-sur-Foron - Haute Savoie international fare April 27 to May 6



CERN's participation in the International Fair of Haute-Savoie/Mont Blanc, enhanced by the valuable help of volunteers from the FCC team, resulted in meaningful discussions with more than 2000 members of the local community on topics ranging from the required technological advancements to sustainability measures.

On 15 May, RTS (Radio Télévision Suisse) broadcasted a special program celebrating CERN's 70th anniversary and hosted at CERN's Science Gateway.



The event featured a comprehensive look at CERN's illustrious history, groundbreaking achievements, and future ambitions, including the prominently featured Future Circular Collider (FCC) project with study experts interacting with the audience.

Integration with regional infrastructures

- Road accesses developed for all 8 surface sites
- Four possible highway connections defined
- **Less than 4 km of new roads required**

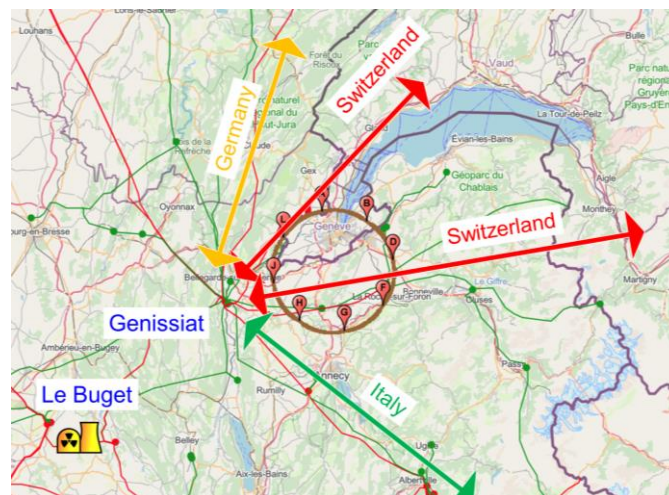
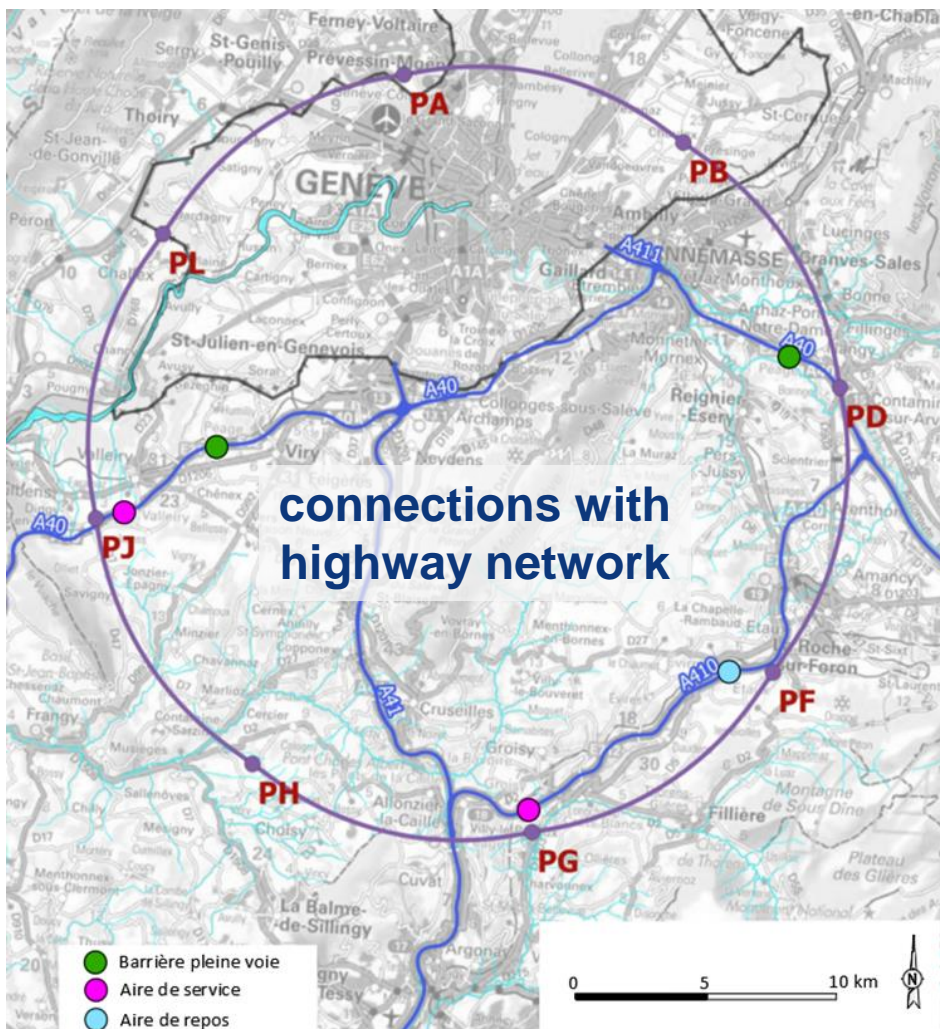

Connections to French electricity grid

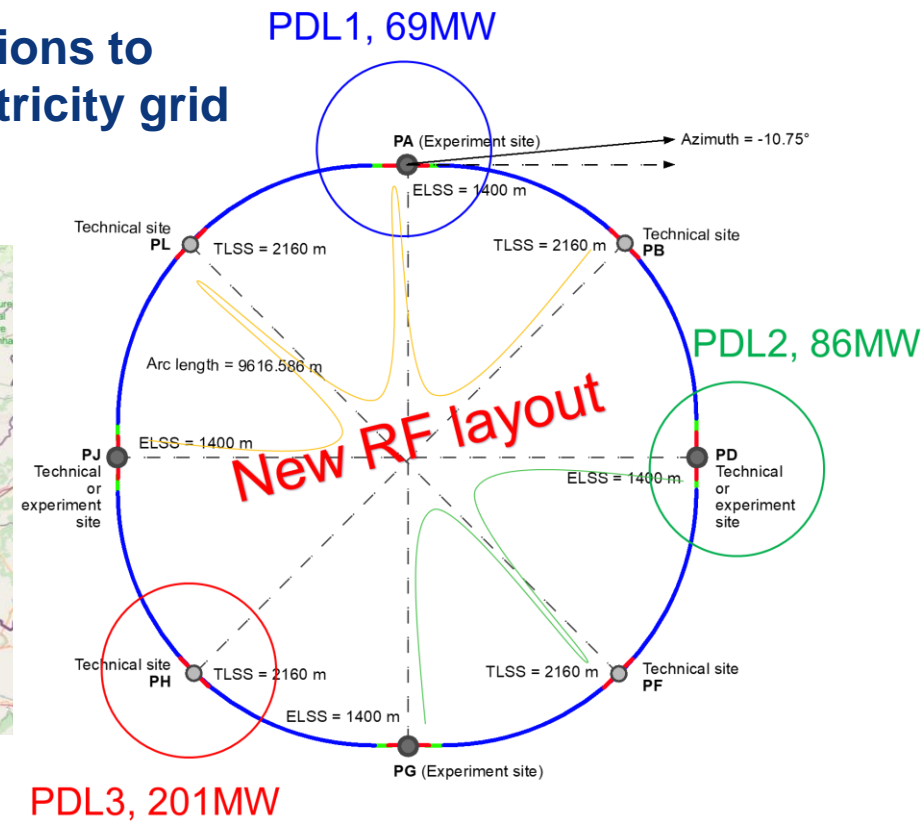

- Electrical connection concept developed with RTE (French electricity grid operator)
- Three HV supply points, two new stations & CERN Preveessin
→ **requested loads have no significant impact on grid**
- R&D efforts aiming at reduction of the energy consumption of FCC-ee and FCC-hh

FCC-ee main machine parameters

Parameter	Z	WW	H (ZH)	ttbar
beam energy [GeV]	45.6	80	120	182.5
beam current [mA]	1270	137	26.7	4.9
number bunches/beam	11200	1780	440	60
bunch intensity [10^{11}]	2.14	1.45	1.15	1.55
SR energy loss / turn [GeV]	0.0394	0.374	1.89	10.4
total RF voltage 400/800 MHz [GV]	0.120/0	1.0/0	2.1/0	2.1/9.4
long. damping time [turns]	1158	215	64	18
horizontal beta* [m]	0.11	0.2	0.24	1.0
vertical beta* [mm]	0.7	1.0	1.0	1.6
horizontal geometric emittance [nm]	0.71	2.17	0.71	1.59
vertical geom. emittance [pm]	1.9	2.2	1.4	1.6
vertical rms IP spot size [nm]	36	47	40	51
beam-beam parameter ξ_x / ξ_y	0.002/0.0973	0.013/0.128	0.010/0.088	0.073/0.134
rms bunch length with SR / BS [mm]	5.6 / 15.5	3.5 / 5.4	3.4 / 4.7	1.8 / 2.2
luminosity per IP [$10^{34} \text{ cm}^{-2}\text{s}^{-1}$]	140	20	≥ 5.0	1.25
total integrated luminosity / IP / year [ab^{-1}/yr]	17	2.4	0.6	0.15
beam lifetime rad Bhabha + BS [min]	15	12	12	11

4 years
 $5 \times 10^{12} \text{ Z}$
 $\text{LEP} \times 10^5$

2 years
 $> 10^8 \text{ WW}$
 $\text{LEP} \times 10^4$

3 years
 $2 \times 10^6 \text{ H}$

5 years
 $2 \times 10^6 \text{ tt pairs}$

Design and parameters to maximise luminosity at all working points:

- allow for 50 MW synchrotron radiation per beam.
- Independent vacuum systems for electrons and positrons
- full energy booster ring with top-up injection, collider permanent in collision mode

- x 10-50 improvements on all EW observables
- up to x 10 improvement on Higgs coupling (model-indep.) measurements over HL-LHC
- x10 Belle II statistics for b, c, τ
- indirect discovery potential up to $\sim 70 \text{ TeV}$
- direct discovery potential for feebly-interacting particles over 5-100 GeV mass range

Up to 4 interaction points \rightarrow robustness, statistics, possibility of specialised detectors to maximise physics output

Collider and Booster design

Complete accelerator design and layout

- consolidated beam parameters throughout entire chain & different operation modes
- definitive collider and booster and optics and layout
- beam-based alignment procedures, tolerances and requirements
- complete impedance models for booster and collider rings

→ specifications for design of components and technical infrastructure

→ full inventory for integration studies and requirements for civil engineering

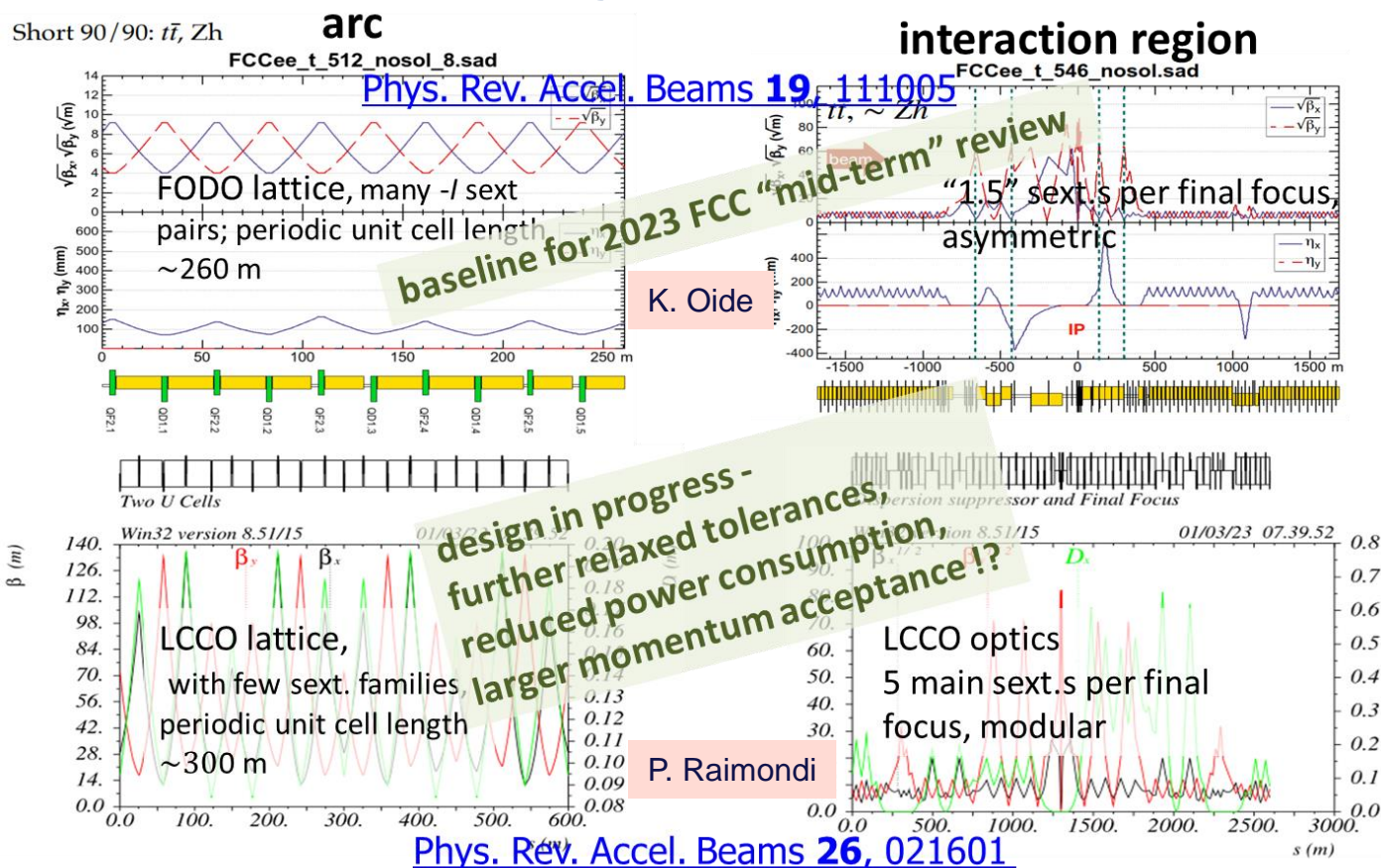

FCC-ee SRF system

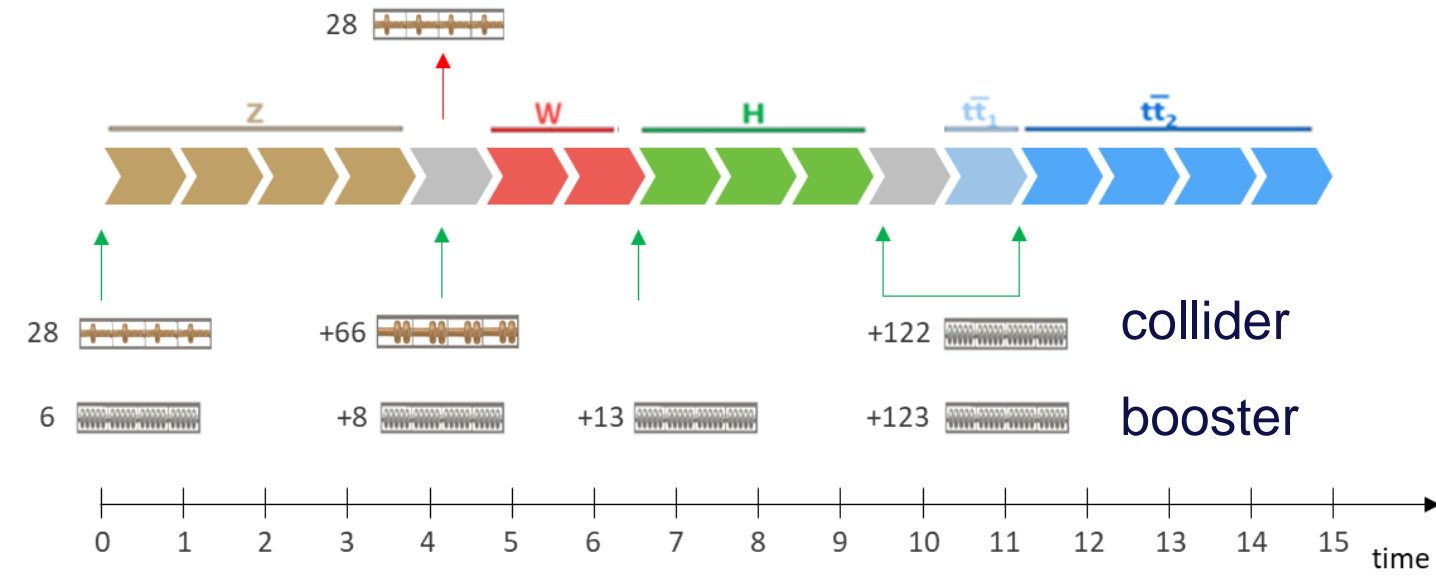

	Energy (GeV)	Current (mA)	RF voltage (GV)
Z	45.6	1280	0.08
W	80	135	1
H	120	26.7	2.08
ttb	182.5	5	11.67

O. Brunner, F. Peauger

Key technologies:

- **400 MHz Nb/Cu** for collider Z, WW, (Z)H working points
- **800 MHz bulk Nb** for booster & ttbar collider
- quasi-continuous evolution of machine configurations
- long-term R&D program with international partners
 - high Q cavities, thin film coatings (incl. Nb₃Sn), cryomodules, efficient RF power sources

ttbar, booster
5-cell
800 MHz,
bulk Nb



Jefferson Lab

Z
1-cell
400 MHz,
Nb/Cu

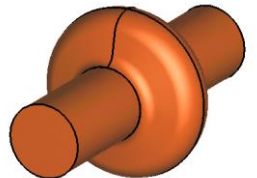

W, H
2-cell
400 MHz,
Nb/Cu

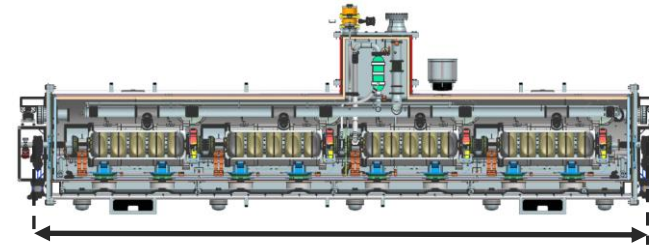
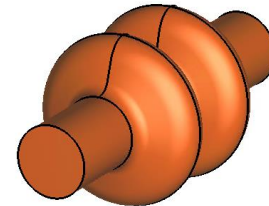

Fermilab ~7 m

effort to use 2-cell cavities also for Z running to raise operational efficiency

I. Karpov

Arc cell optimisation – 80 km total length, dedicated working group active.

- Including support, girder and alignment systems, shielding systems
- vacuum system with antechamber + pumps, dipole, quadrupole + sext. magnets, BPMs,
- cabling, cooling & technical infrastructure interfaces.
- Safety aspects, access and transport concept,

→ Confirmation of tunnel diameter

FCC-ee arc half-cell mock up

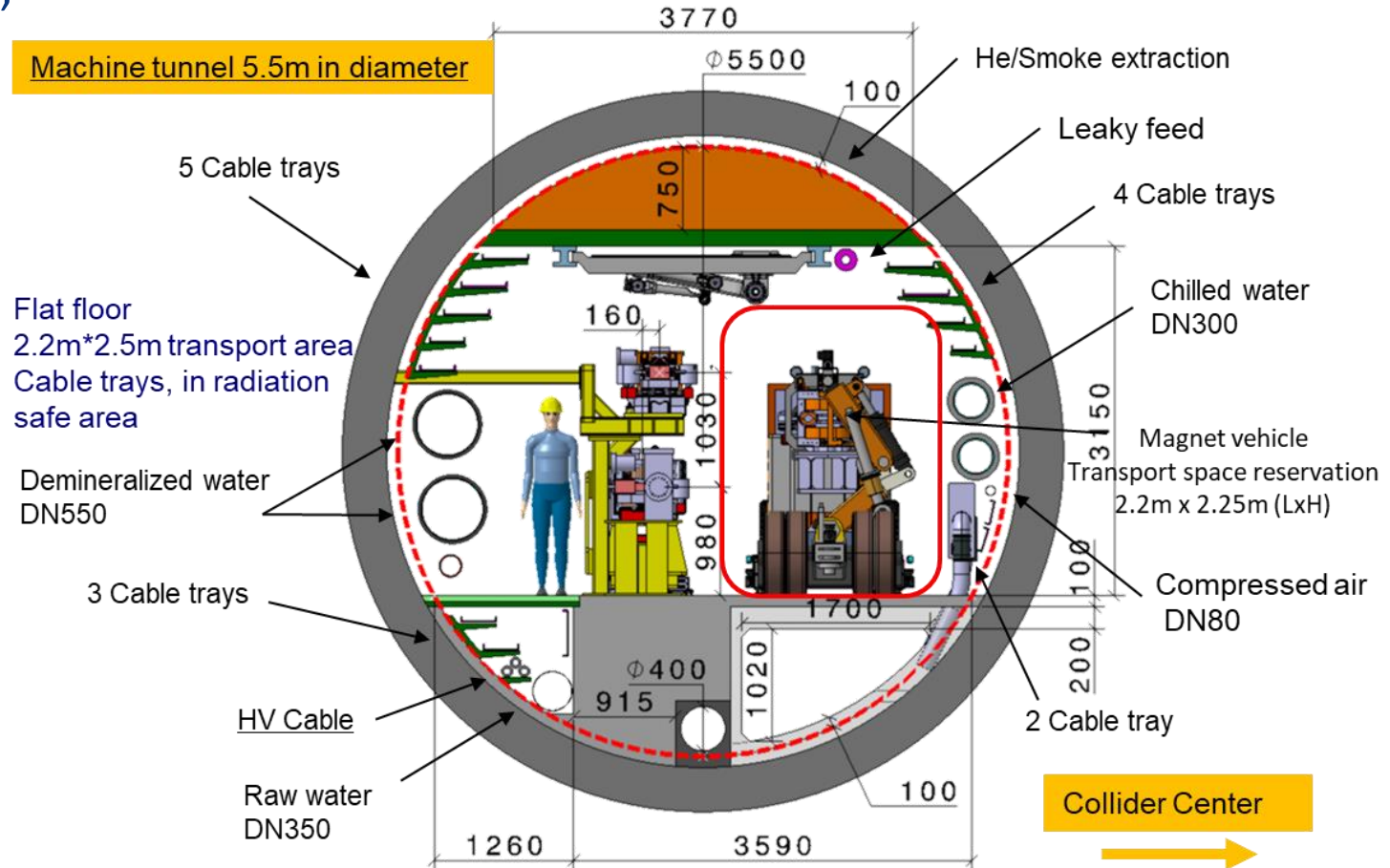
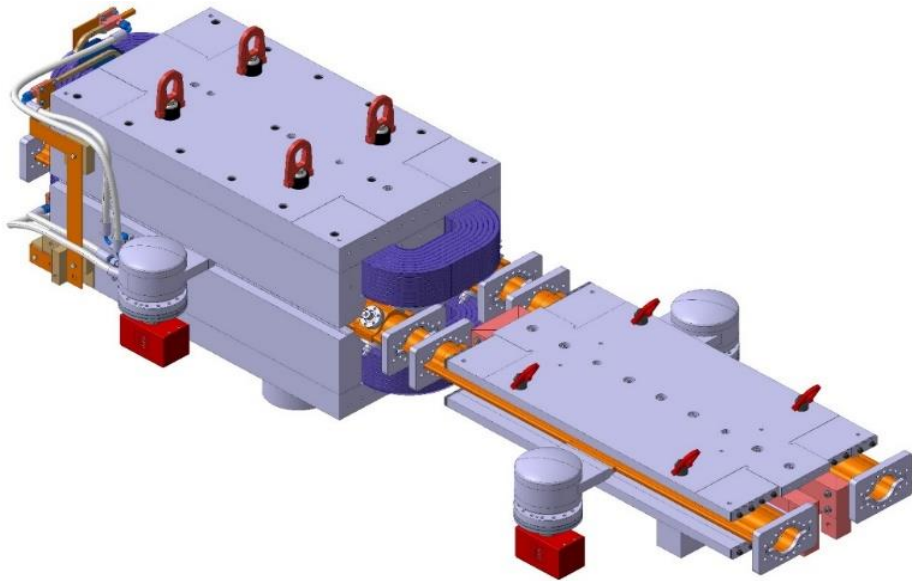

Overall injector parameter optimisation, following mid-term review recommendations

- Operation frequency, operation gradient vs number of structures/overall length
- Positron production energy, damping ring energy

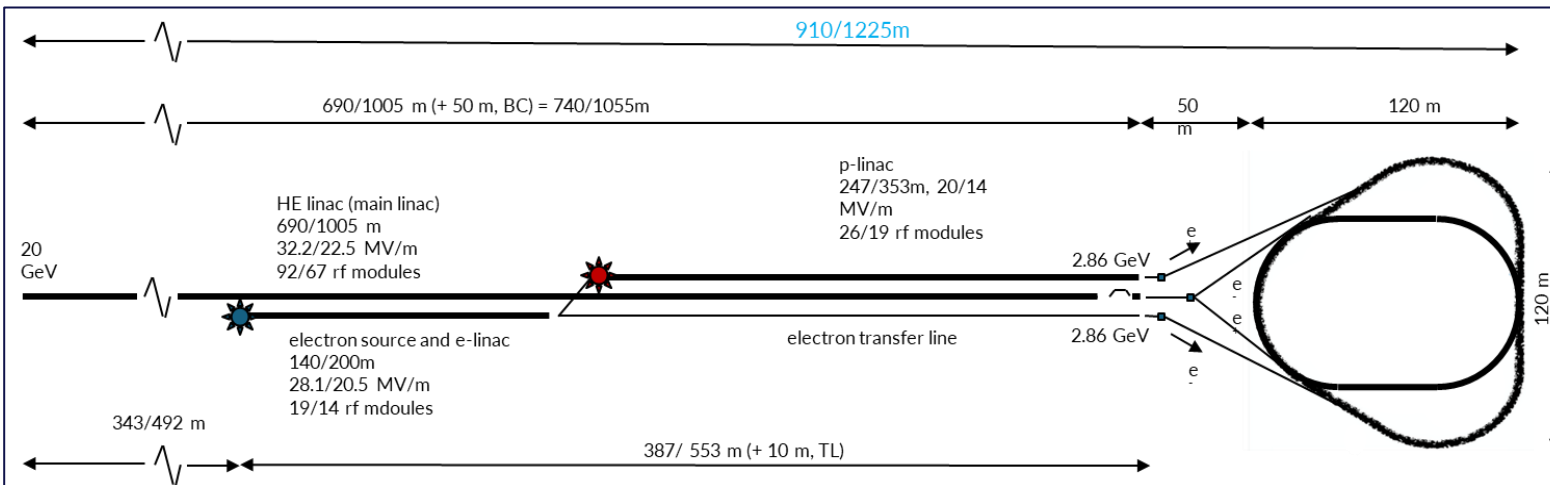

Injector layout and implementation study on CERN Preveessin Site

- Technical infrastructure pre-design & integration with services at Preveessin site
- Injector cost estimate update

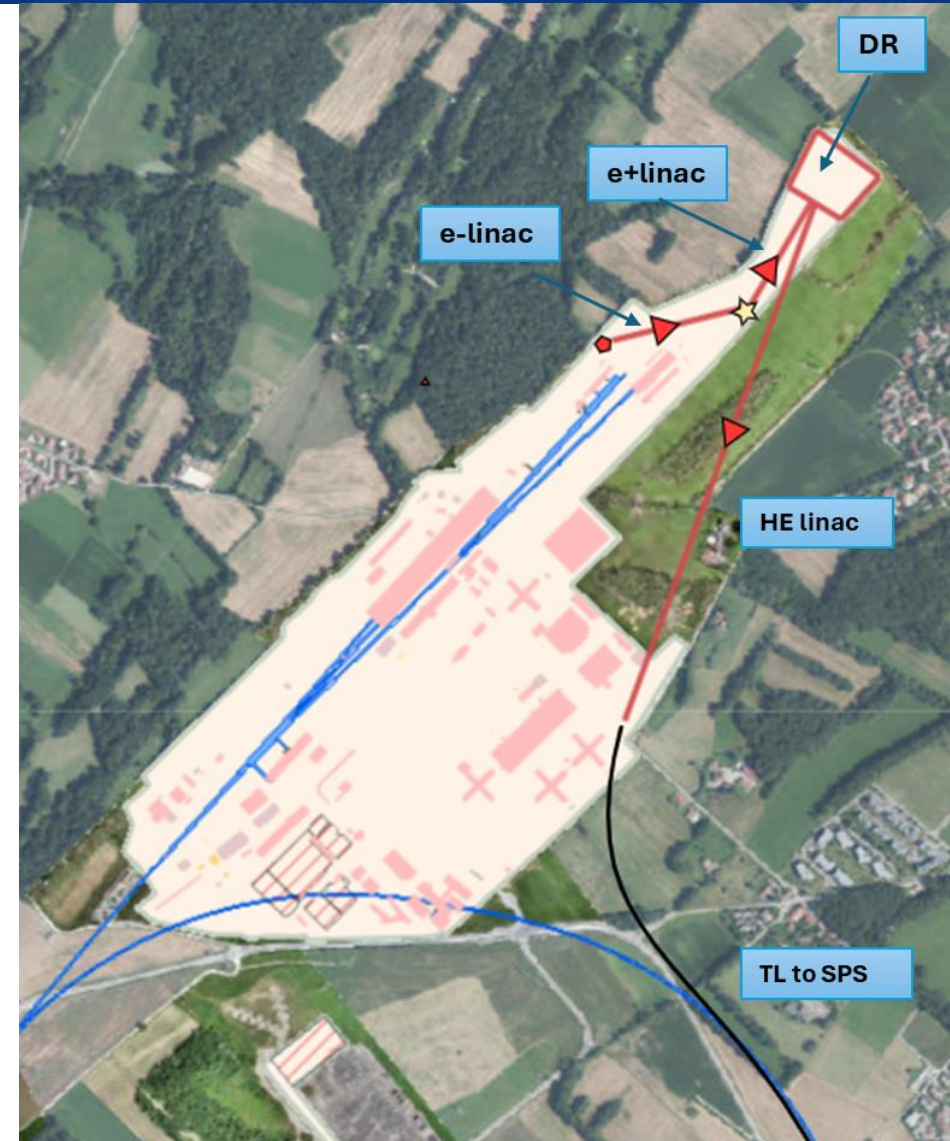

P. Craievich, W. Bartmann,
Y. Papaphilippou, C. Milardi

FCC-hh main machine parameters

parameter	FCC-hh	HL-LHC	LHC
collision energy cms [TeV]	81 - 115		14
dipole field [T]	14 - 20		8.33
circumference [km]	90.7		26.7
arc length [km]	76.9		22.5
beam current [A]	0.5	1.1	0.58
bunch intensity [10^{11}]	1	2.2	1.15
bunch spacing [ns]	25		25
synchr. rad. power / ring [kW]	1020 - 4250	7.3	3.6
SR power / length [W/m/ap.]	13 - 54	0.33	0.17
long. emit. damping time [h]	0.77 - 0.26		12.9
peak luminosity [$10^{34} \text{ cm}^{-2}\text{s}^{-1}$]	~30	5 (lev.)	1
events/bunch crossing	~1000	132	27
stored energy/beam [GJ]	6.1 - 8.9	0.7	0.36
Integrated luminosity/main IP [fb^{-1}]	20000	3000	300

With FCC-hh after FCC-ee: significant amount of time for high-field magnet R&D, aiming at highest possible collision energies

- Target field range for cryo-magnet R&D

Formidable challenges:

- ❑ **high-field superconducting magnets: 14 - 20 T**
- ❑ **power load** in arcs from **synchrotron radiation: 4 MW** → cryogenics, vacuum
- ❑ **stored beam energy: ~ 9 GJ** → machine protection
- ❑ **pile-up** in the detectors: **~1000 events/xing**
- ❑ **optimization of energy consumption:** → R&D on cryo, HTS, beam current, ...

Formidable physics reach, including:

- ❑ **Direct discovery potential up to ~ 40 TeV**
- ❑ Measurement of Higgs self to ~ 5% and ttH to ~ 1%
- ❑ **High-precision and model-indep** (with FCC-ee input) **measurements of rare Higgs decays ($\gamma\gamma, Z\gamma, \mu\mu$)**
- ❑ **Final word about WIMP dark matter**



Optics design activities:

- adaptation to new layout and geometry
- shrink β collimation & extraction by ~30%
- optics optimisation (filling factor etc.)

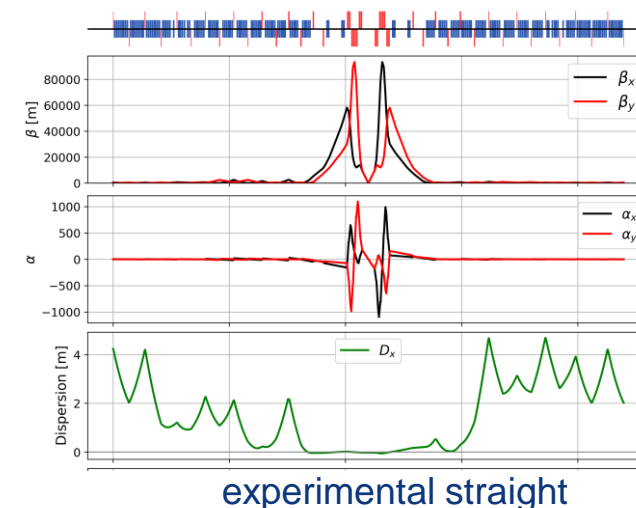
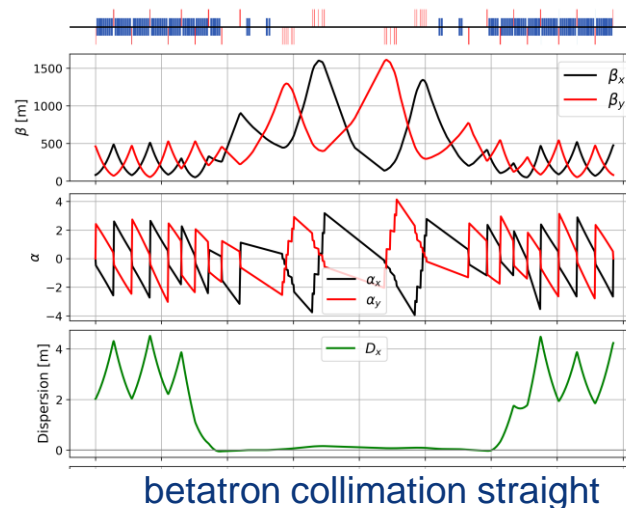
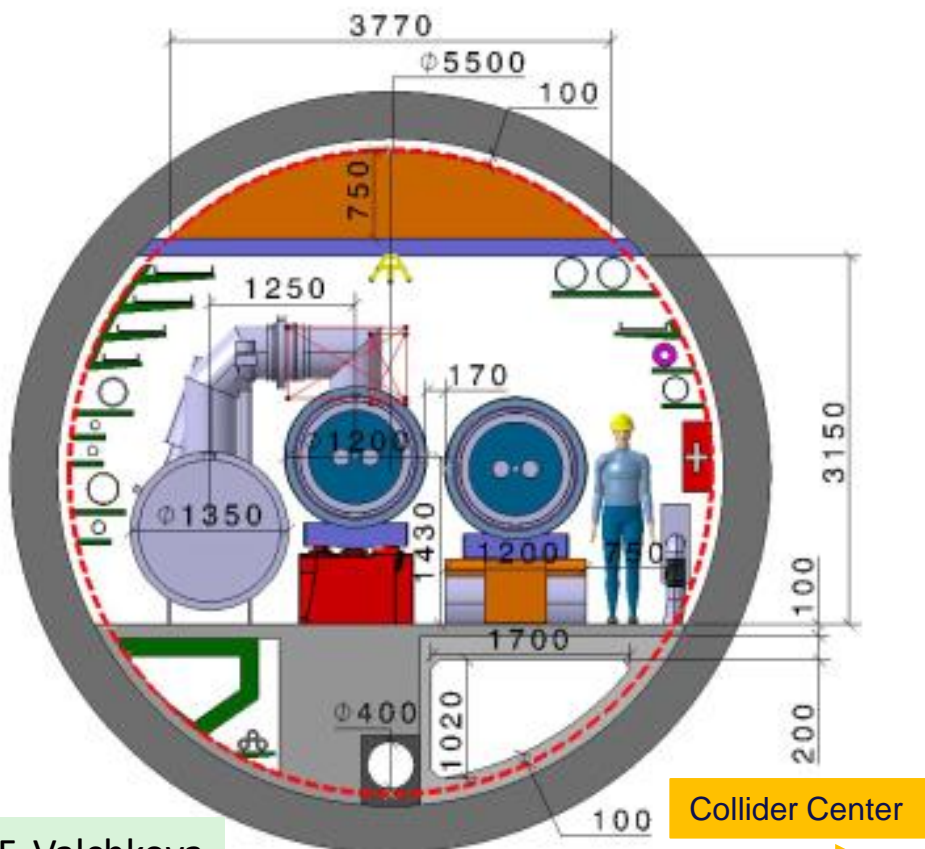

M. Giovannozzi. G. Perez, T. Risselada

High-field cryo-magnet system design

- Conceptual study of cryogenics concept and temperature layout for LTS and HTS based magnets, in view of electrical consumption.
- Update of integration study for the ongoing HFM designs and scaling to preliminary HTS design.
 → **Confirmation of tunnel diameter!**
- HFM R&D (LTS and HTS) on technology and magnet design, aiming also at bridging the TRL gap between HTS and Nb_3Sn .

Status of FCC global collaboration

Increasing international collaboration as a prerequisite for success:

→ links with **science, research & development** and **high-tech industry** will be essential to further advance and prepare the implementation of FCC

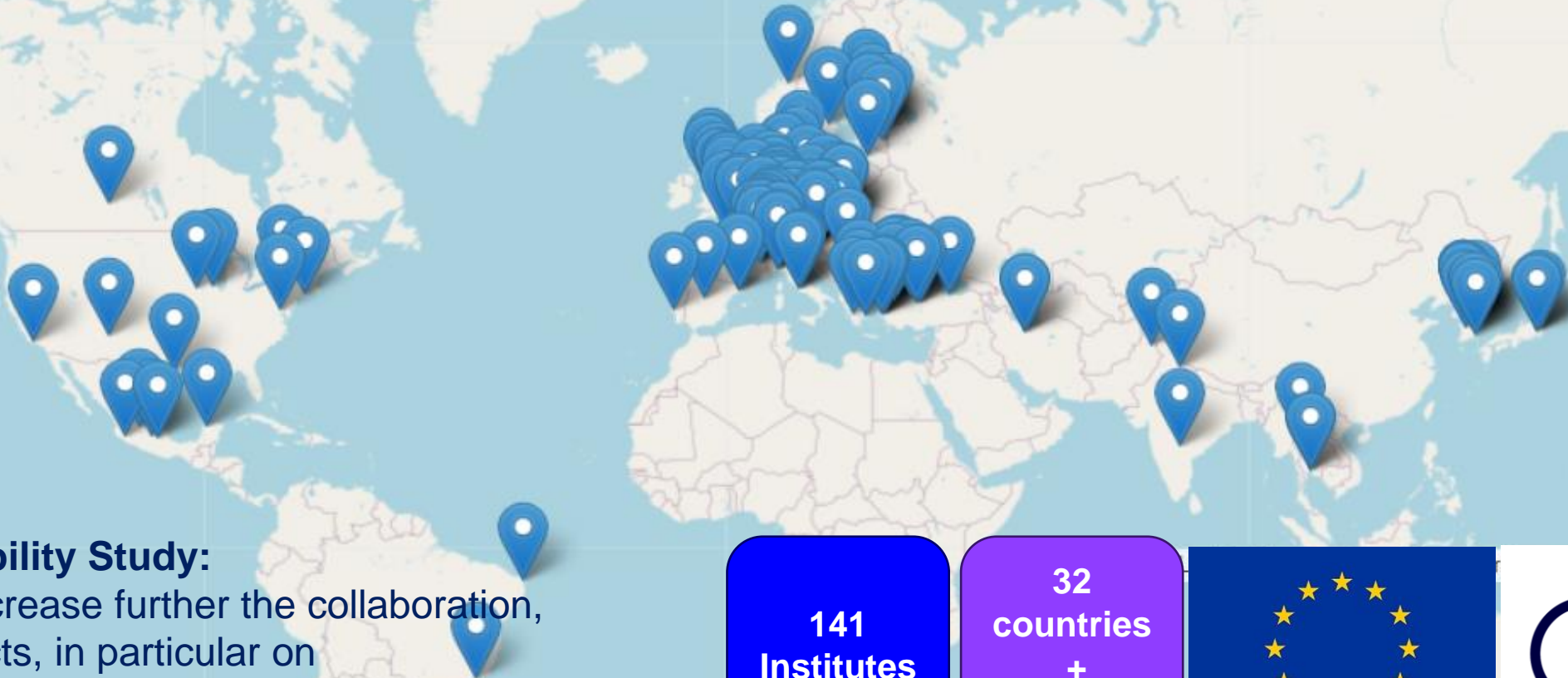

FCC Feasibility Study:

Aim is to increase further the collaboration, on all aspects, in particular on Accelerator and Particle/Experiments/Detectors

141
Institutes

32
countries
+
CERN



- **The first part of the FCC Feasibility Study has been concluded with the mid-term review**
- **Next milestone: completion of the FCC Feasibility Study by March 2025**
- **By 2027-2028, possible FCC project approval, start of CE design contract:**
 - specifications to enable CE tender design by 2028
 - refined input for environmental evaluation and project authorisation process
 - requires overall integration study and designs based on technical pre-design of accelerators, technical infrastructure and detectors
- **By 2031-32, possible start of CE construction:**
 - CE groundbreaking
 - TDR to enable prototyping, industrialization towards component production
- **Strong collaboration with US and further international partners is essential for success!**