

Exotic states production in nuclear collisions at the LHC energies with PACIAE model

Zhi-Lei She (佘智磊)

Wuhan Textile University

Oct. 24th 2024

on behalf of

A. K. Lei, Y. L. Yan, D. M. Zhou, W. C. Zhang, H. Zheng, J. Cao, L. Zheng, Y. L. Xie, G. Chen, B. H. Sa,...

Mainly based on papers :

PRC 108, 064909 (2023), PRC 110, 014910 (2024), PRD 110 054046 (2024)

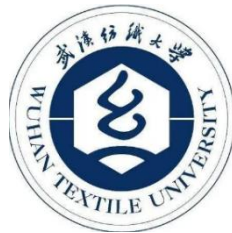

Outline

- Introduction of exotic states
- PACIAE model studying X(3872)
- PACIAE model studying X(2370)
- Summary and Outlook

Exotics in the quark model



Volume 8, number 3 PHYSICS LETTERS 1 February 1964

A SCHEMATIC MODEL OF BARYONS AND MESONS *

M. GELL-MANN
California Institute of Technology, Pasadena, California

Received 4 January 1964

...
 A simpler and more elegant scheme can be constructed if we allow non-integral values for the charges. We can dispense entirely with the basic baryon Λ if we assign to the triplet t the following properties: spin $\frac{1}{2}$, $z = -\frac{1}{3}$, and baryon number $\frac{1}{3}$. We then refer to the members $u^{\frac{1}{3}}$, $d^{-\frac{1}{3}}$, and $s^{-\frac{1}{3}}$ of the triplet as "quarks" q and the members of the anti-triplet as anti-quarks \bar{q} . Baryons can now be constructed from quarks by using the combinations (qqq) , $(qqq\bar{q})$ etc., while mesons are made out of $(q\bar{q})$, $(qq\bar{q}\bar{q})$, etc. It is assumed that the lowest baryon configuration (qqq) gives just the representations 1, 8, and 10 that have been observed, while

8419/TH.412
 21 February 1964

AN SU_3 MODEL FOR STRONG INTERACTION SYMMETRY AND ITS BREAKING

II *)

G. Zweig
 CERN---Geneva

*) Version I is CERN preprint 8182/TH.401, Jan. 17, 1964.

6) In general, we would expect that baryons are built not only from the product of three aces, AAA , but also from $\bar{A}AAAA$, $\bar{A}AAAAA$, etc., where \bar{A} denotes an anti-ace. Similarly, mesons could be formed from $\bar{A}A$, $\bar{A}AAA$ etc. For the low mass mesons and baryons we will assume the simplest possibilities, $\bar{A}A$ and AAA , that is, "deuces and treys".

Phys. Lett. 8, 214 (1964)

Exotic multiquark hadrons, e.g.,

'tetraquarks' with minimal four-quark content $qq\bar{q}\bar{q}$;

'pentaquarks' with minimal five-quark content $qqqq\bar{q}$;

...

Exotic Hadrons

Conventional Quark Model

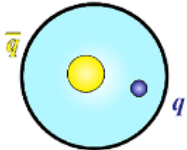

(a) meson

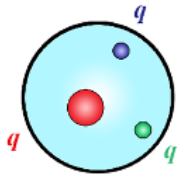

(b) baryon

Exotic hadron

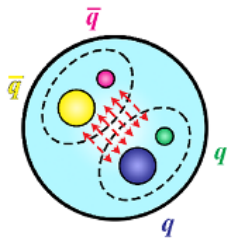

(c) compact tetraquark

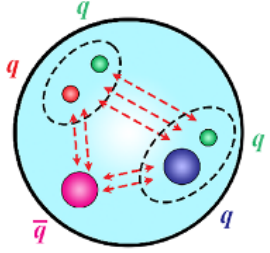

(d) compact pentaquark



(e) two- and three-gluon glueballs

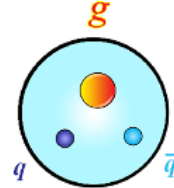

(f) hybrid state

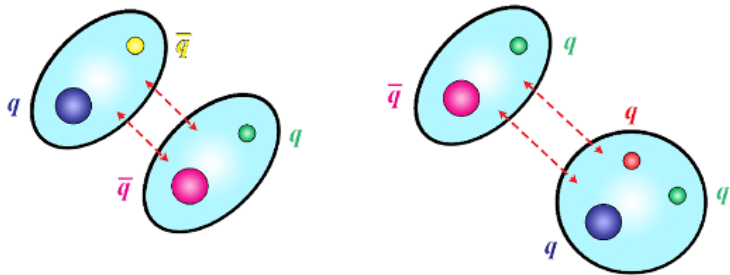

(g) weakly-bound hadronic molecules

made by H.X Chen from Rept. Prog. Phys. 86, 026201 (2023)

More review papers: [Phys. Rep. 668, 1 \(2017\)](#); [Rev. Mod. Phys. 90, 015004 \(2018\)](#); [Phys. Rep. 873, 1 \(2020\)](#); [Phys. Rept. 1001, 1 \(2023\)](#); [Phys. Rept. 1001, 1 \(2023\)](#) ...

First exotic candidate X(3872)

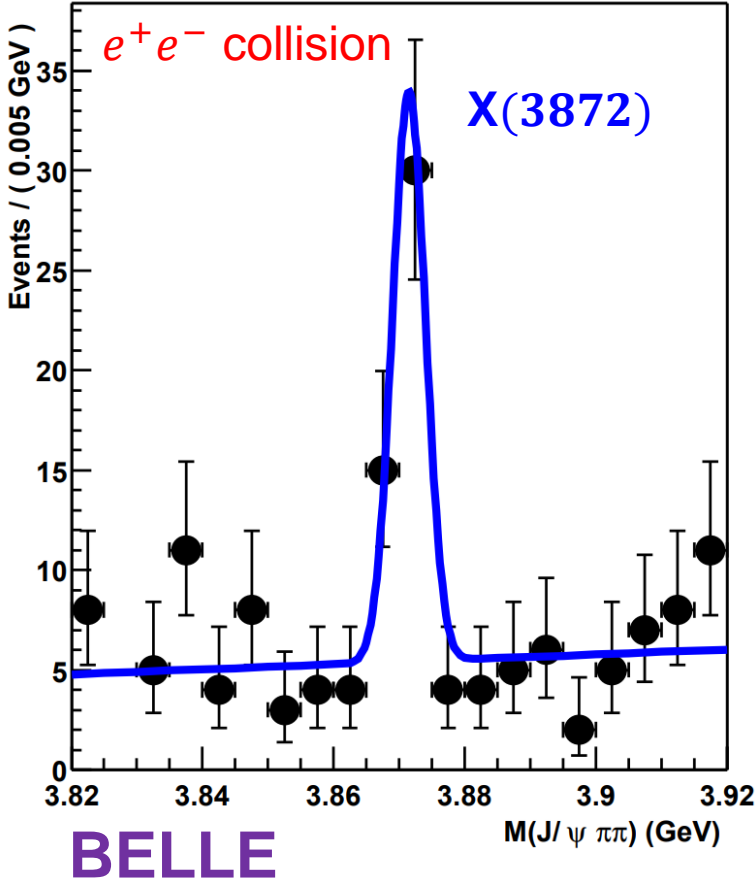

PRL 91, 262001 (2003)

Later, more experiments have confirmed its existence and have measured its properties in both pp and Pb-Pb collisions.

PRL 110, 222001 (2013); JHEP 04, 154 (2013); JHEP 01, 117 (2017); PRL 126, 092001 (2021); PRL 128, 032001 (2022) ...

Interpretations of X(3872)

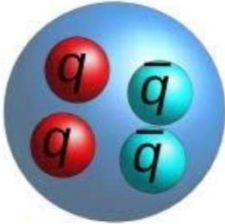

Tetraquark

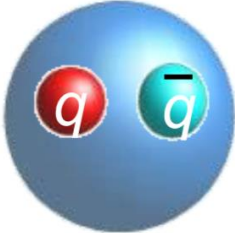

Charmonium

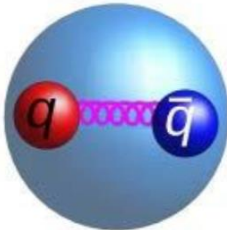

Hybrid

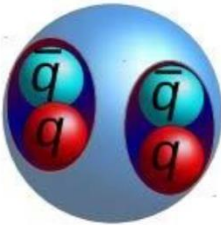

Hadronic molecule

...

However, the exact nature of X(3872) is still unclear.

The loose molecule state and compact tetraquark state are of most interest.

Existed observables to distinguish X(3872)

Yield ratio in coalescence model to statistical model (N^{coal}/N^{stat}), [PRL 106, 212001 \(2011\)](#)

Spatial structure parameter (R_0), [Phys. Rep. 639, 1 \(2016\)](#); [EPJC 81, 784 \(2021\)](#) ...

Rapidity distribution (dN/dy), [PRL 126, 012301 \(2021\)](#); [EPJA 57, 122 \(2021\)](#); [PRC 105, 054901 \(2022\)](#) ...

Transverse momentum spectrum (dN/dp_T), [PRL 126, 012301 \(2021\)](#); [PRC 105, 054901 \(2022\)](#) ...

Cross-section ratio ($X(3872)/\psi(2S)$) [EPJC 81, 669 \(2021\)](#); [PRL 126, 092001 \(2021\)](#); [PRL 128, 032001 \(2022\)](#)

Radiative decay ratio ($X \rightarrow \psi'(2S)\gamma)/(X \rightarrow \psi(1S)\gamma)$... [2401.11623](#) ...

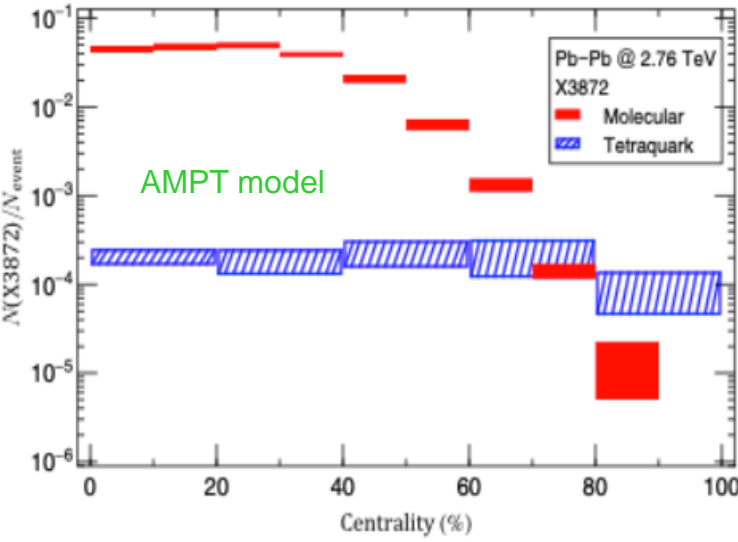

[PRL 136, 012301 \(2021\)](#)

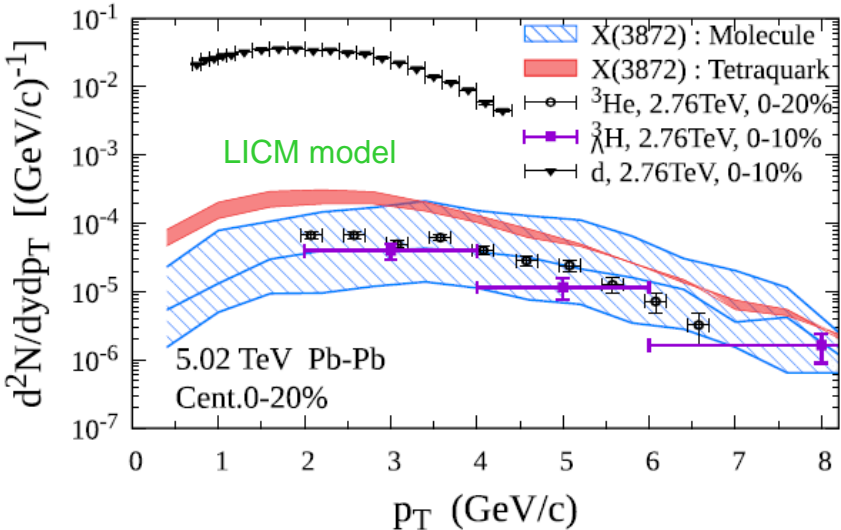

[PRC 105, 054901 \(2022\)](#)

PACIAE model studying X(3872)

PACIAE Model

◆ Successes obtained and improvement introduced

PACIAE+DCPC model has successfully described **exotics** production ($X(3872)$, $Z_c(3900)$, P_c states, and $\chi_{c1}(3872)/\psi(2S)$, etc.) in high energy collisions at LHC energies.

EPJC 81, 784 (2021); EPJC 81,198 (2021); PRD 105, 054013 (2022); PRD 107,114022 (2023) ...

● Previous work

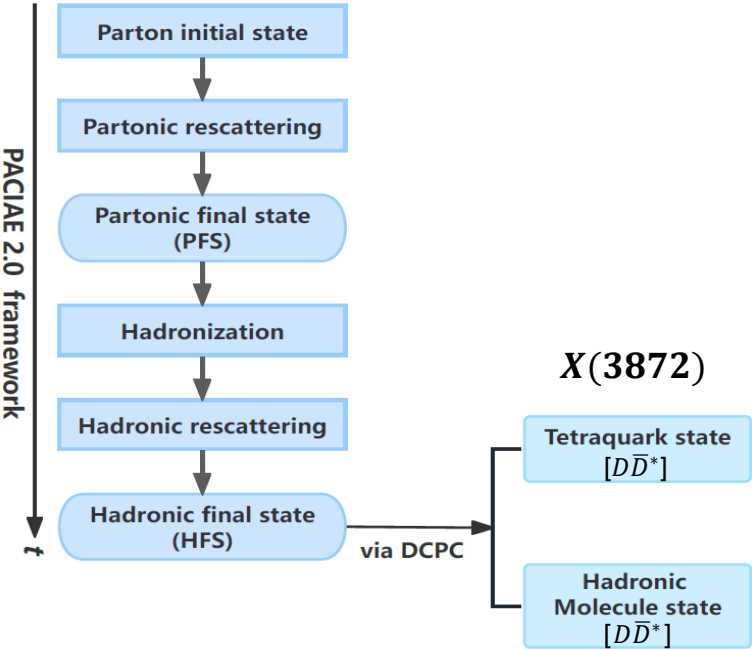

Key: spatial structure parameter (R_0)

● Present work

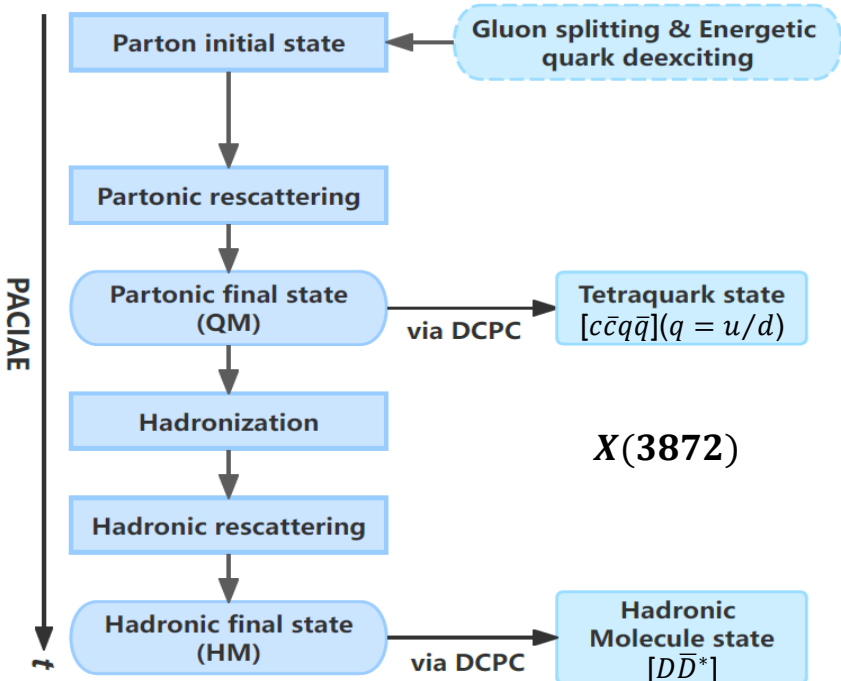

PACIAE Model

Parton and hadron cascade (PACIAE) model, based on PYTHIA model, is a Monte-Carlo event generator in elementary particles and nuclear collisions.

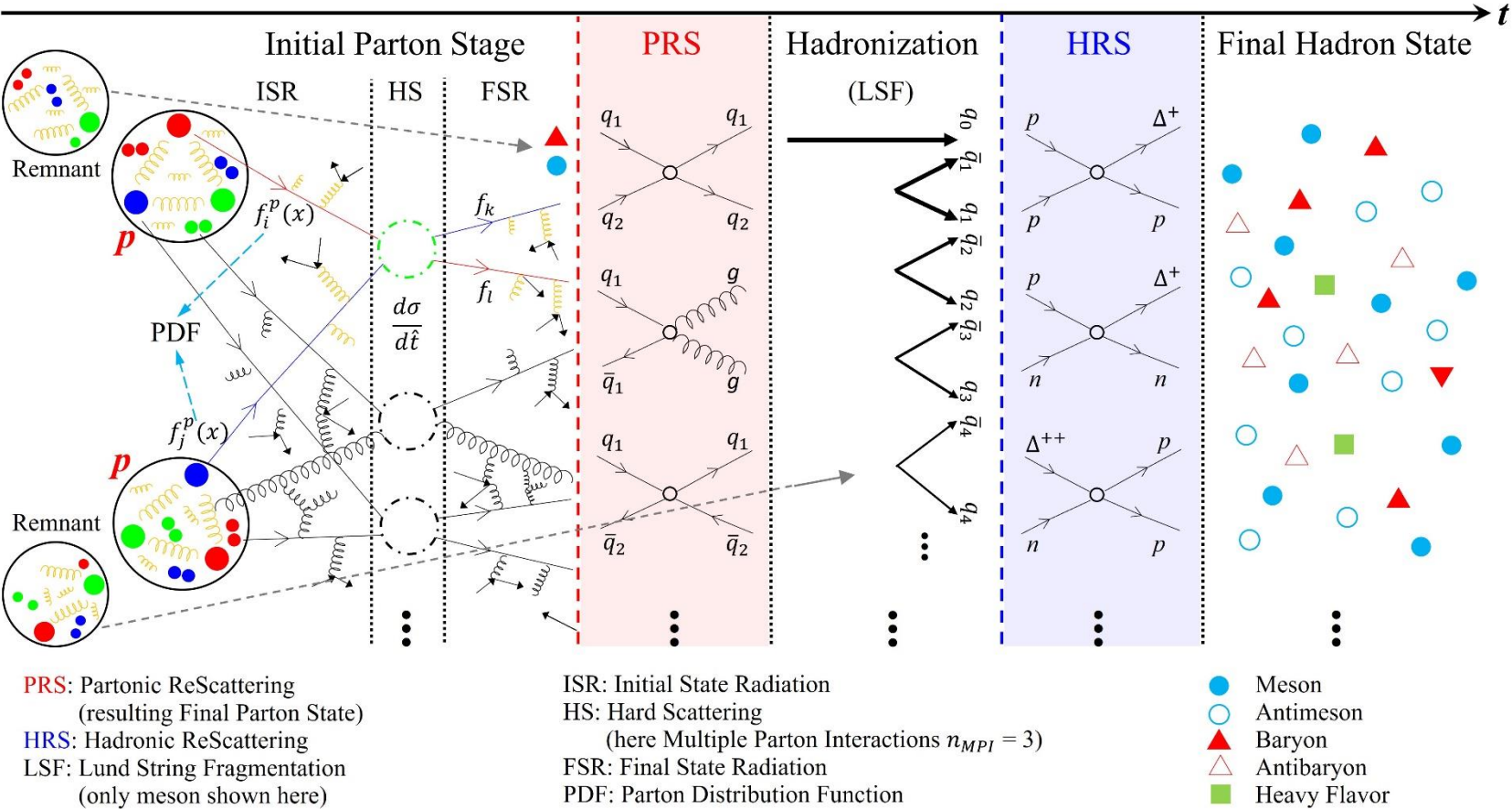

A sketch for physical routines in a high energy pp simulation

PACIAE Model

Compact tetraquark-state and loose hadronic molecule-state of X(3872) are assumed to be coalesced in PFS and HFS, respectively.

PRC 110, 014910 (2024)

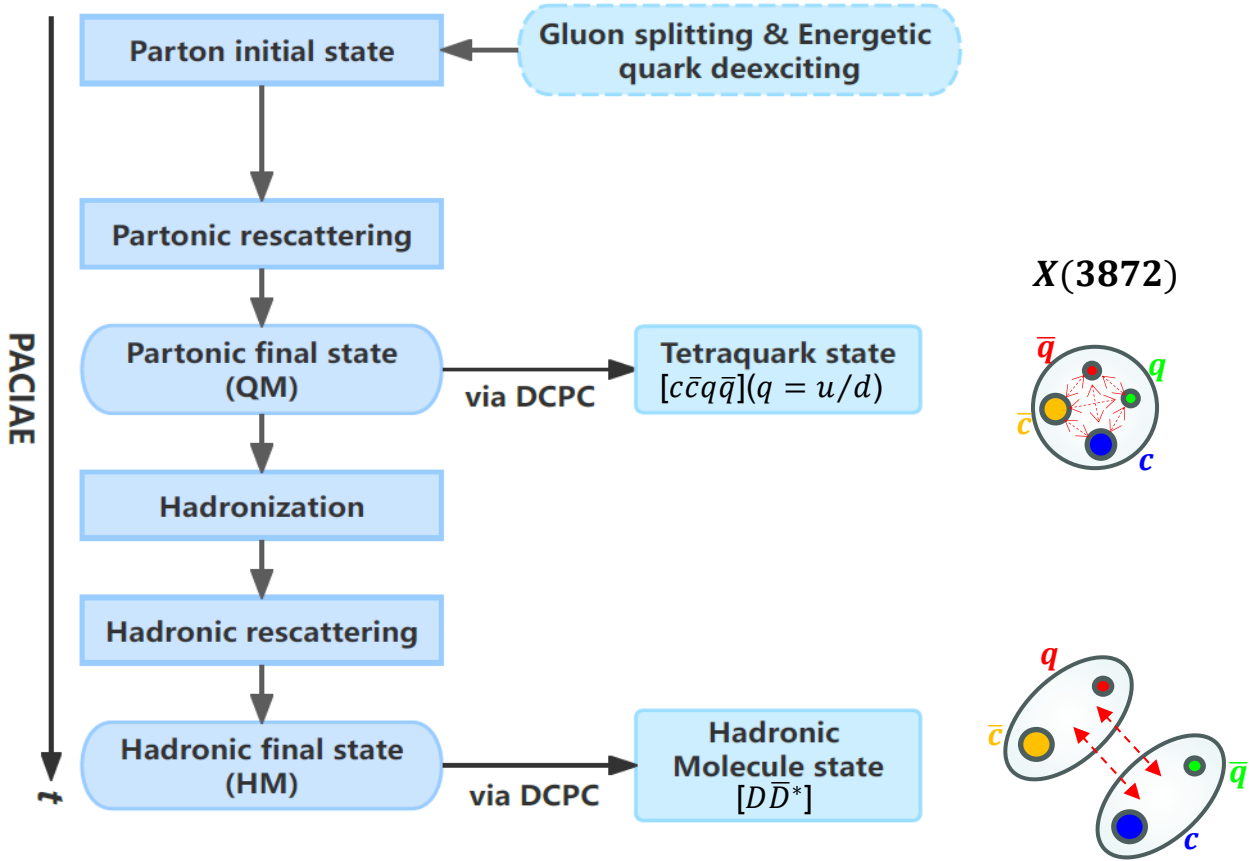

PACIAE Model

- DCPC model

In quantum statistical mechanics, the yield of N-particle cluster in six-dimensional phase space can be estimated by

$$Y_N = \int \cdots \int \frac{d\vec{q}_1 d\vec{p}_1 \cdots d\vec{q}_N d\vec{p}_N}{h^{3N}}$$

We assumed that if the cluster is possible to exist naturally, four-particle cluster of $c\bar{c}u\bar{u}$ for instance, should be calculated by

$$Y_{cluster} = \int \cdots \int \delta_{1234} \frac{\prod_{i=1}^{i=4} d\vec{q}_i d\vec{p}_i}{h^{12}}$$

with constraints:

component constraint if [$1 \equiv c, 2 \equiv \bar{c}, 3 \equiv u, 4 \equiv \bar{u}$], $\delta_{1234} = 1$; otherwise $\delta_{1234} = 0$

spatial coordinate constraint $|\vec{q}_{ij}| = |\vec{q}_i - \vec{q}_j| \leq R_0, (i \neq j; i, j = 1, 2, \dots, 4)$

Momentum constraint $m_0 - \Delta m \leq m_{inv} \leq m_0 + \Delta m$, where $m_{inv} = \sqrt{(\sum_{i=1}^{i=4} E_i)^2 - (\sum_{i=1}^{i=4} \vec{p}_i)^2}$

PACIAE Model

- Framework

- Tetraquark state

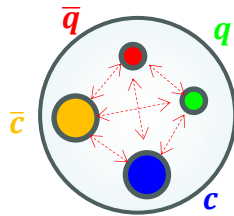

component: c, \bar{c}, q, \bar{q} ($q = u/d$)

mass: $m_{X(3872)} = 3666 \text{ MeV}/c^2$

free parameter: $\Delta m = 1.95 \text{ MeV}/c^2$

spatial structure parameter: $R_0 < 1 \text{ fm}$

- Hadronic molecule state

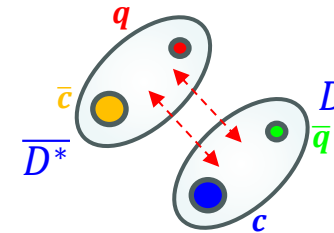

D, \bar{D}^* ($D = D^0, \bar{D}^0, D^+, D^-$)

$m_{X(3872)} = 3871.69 \text{ MeV}/c^2$

$\Delta m = 142 \text{ MeV}/c^2$ ($2m_D \leq m_{X(3872)} \leq 2m_{D^*}$)

$1 < R_0 < 10 \text{ fm}$

Proposed identifying criteria(1)

1, Discrepancy in formation times of two states:

Two formation times of multiquark- and molecule- state are suggested as a criterion and to be measured experimentally.

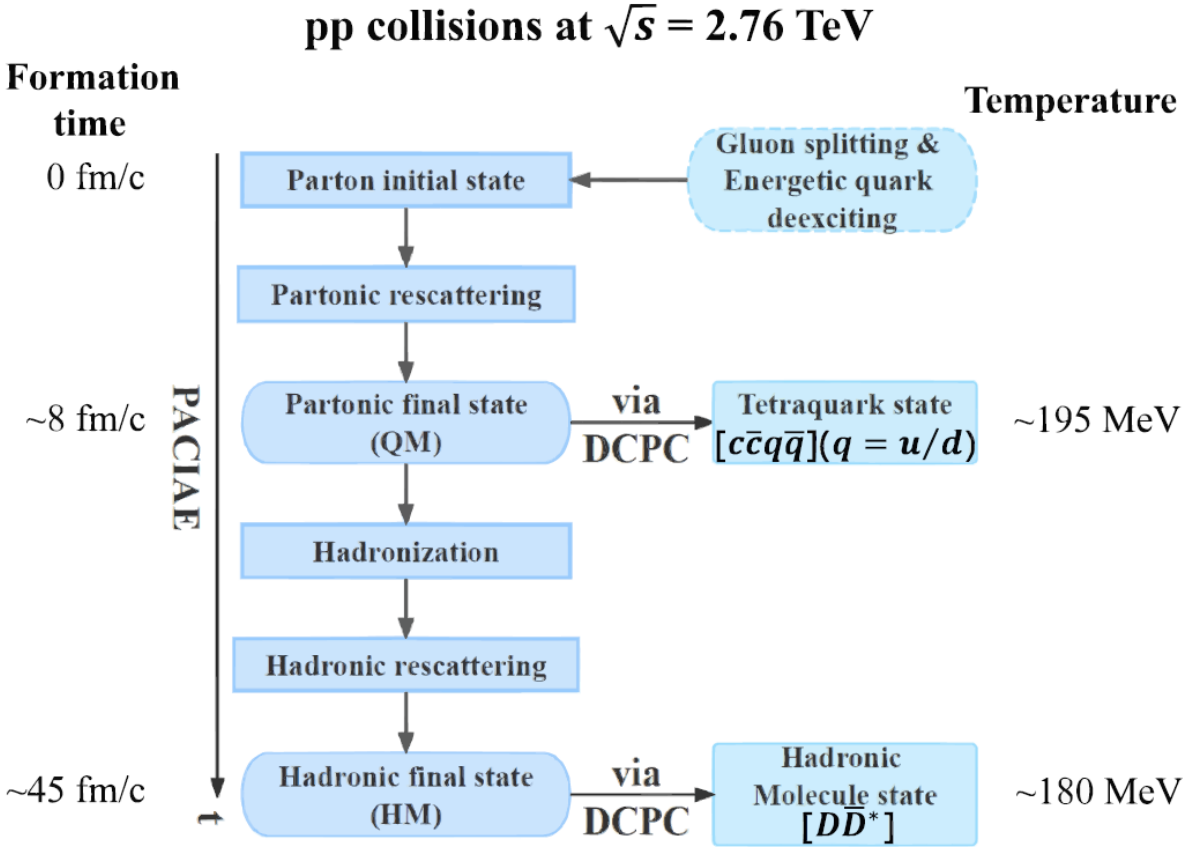

Proposed identifying criteria(2)

2, Discrepancy in apparent hadronization temperature of two states:

Preliminary fitted temperature by Shannon entropy with Hagedorn distribution :

$$\mathcal{H}_{Hag} = \frac{m}{m-1} + \ln\left(\frac{m}{m-1}\right) + \ln(T_{Hag})$$

$$dN/dp_T^2 \propto (p_0/(p_0 + p_T))^m$$

[Phys. Rev. C 109, 034915 \(2024\)](#)

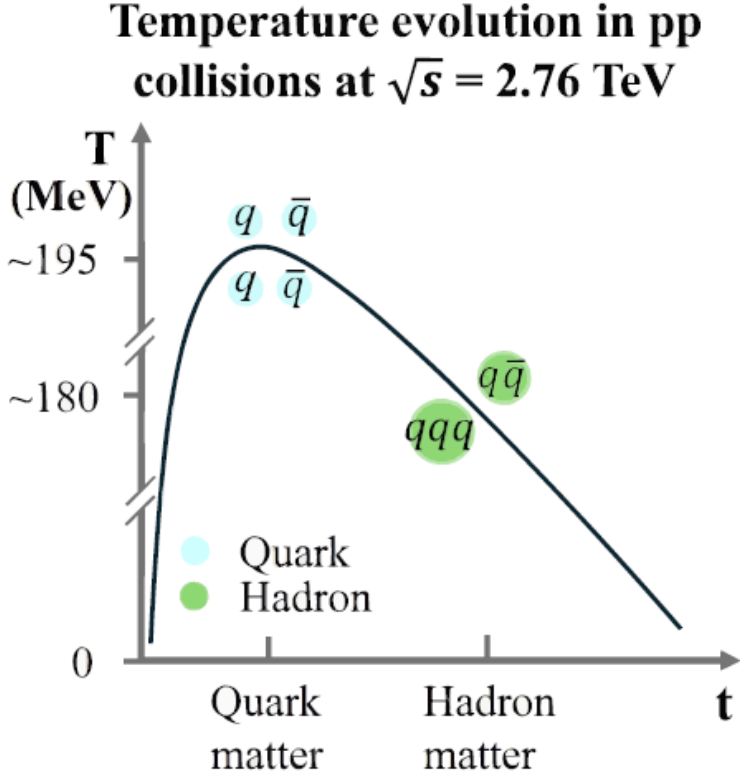

Partonic matter: $T_{PFS} = 0.195$ GeV/c

Hadronic matter: $T_{HFS} = 0.180$ GeV/c

i.e., between multiquark- and molecule-state.

Confirmed the criteria of usual observables(3):

3.1, Discrepancy in y single differential distribution:

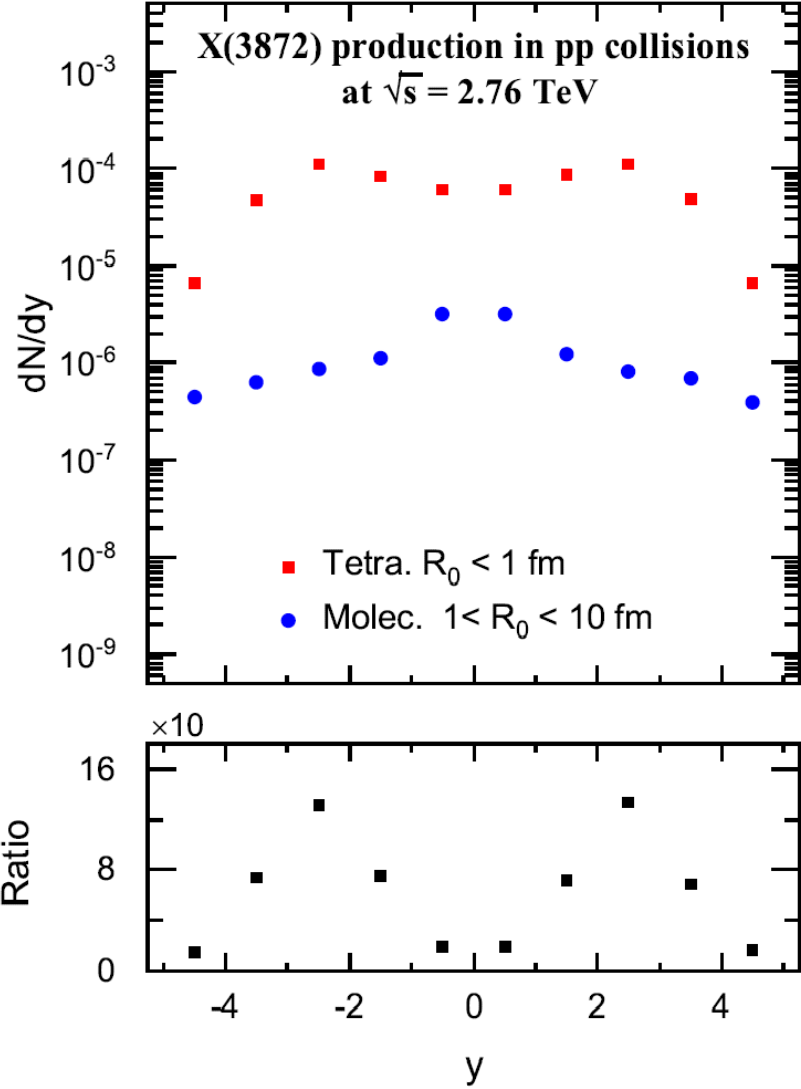

Confirmed the criteria of usual observables(3):

3.2, Discrepancy in p_T single differential distribution:

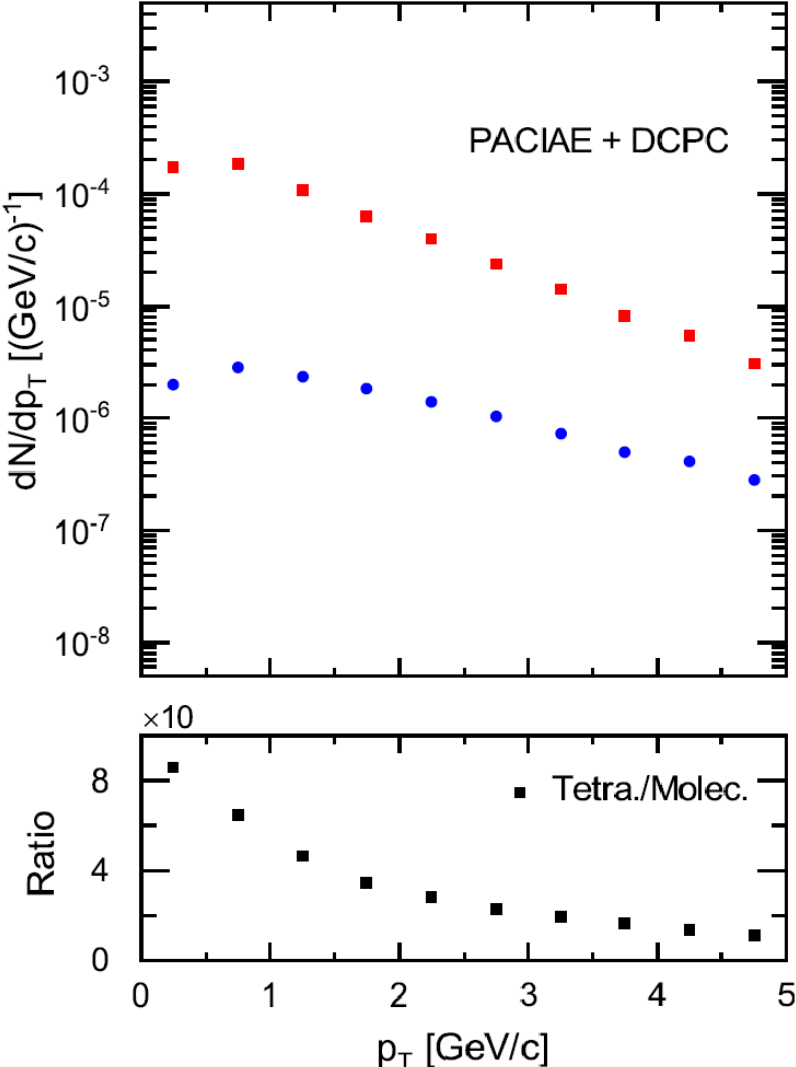

Confirmed the criteria of usual observables(3):

3.3, Discrepancy in transverse momentum spectrum:

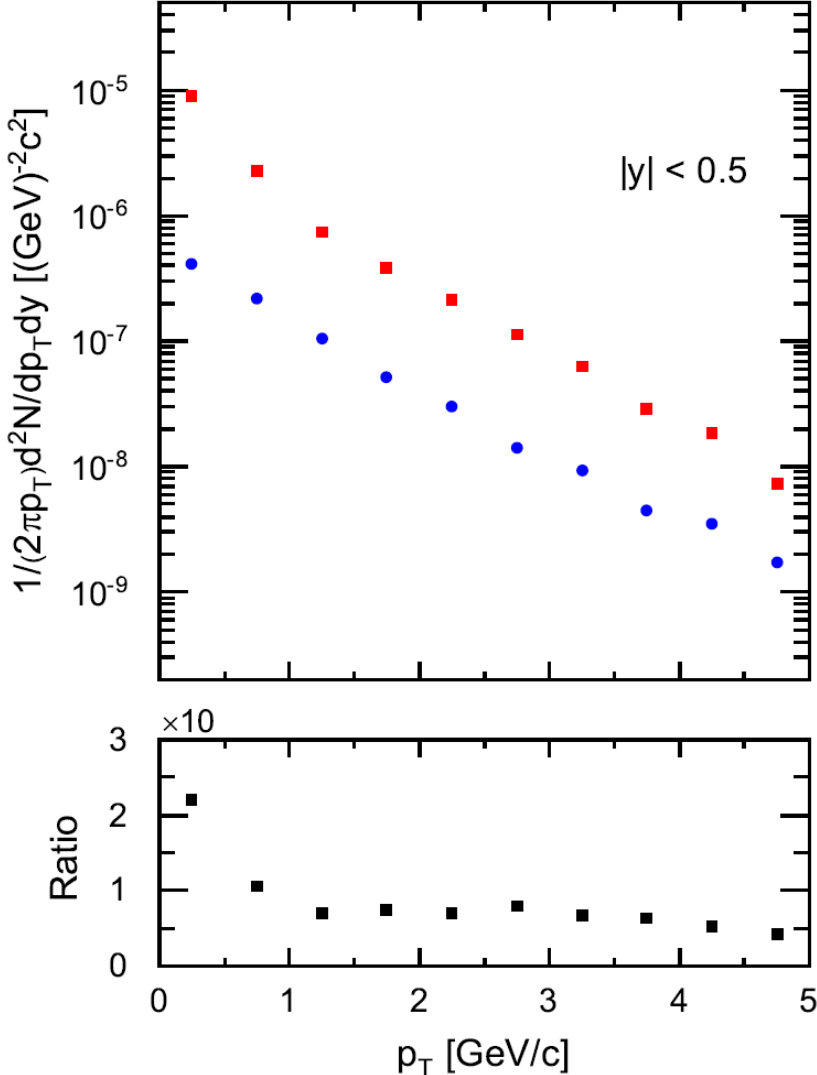

PACIAE model studying X(2370)

X(2370) at BESIII recently

PHYSICAL REVIEW LETTERS **132**, 181901 (2024)

Editors' Suggestion

Determination of Spin-Parity Quantum Numbers of X(2370) as 0^{-+} from $J/\psi \rightarrow \gamma K_S^0 K_S^0 \eta'$

M. Ablikim *et al.**
(BESIII Collaboration)

(Received 8 December 2023; revised 5 March 2024; accepted 28 March 2024; published 2 May 2024)

Based on $(10087 \pm 44) \times 10^6$ J/ψ events collected with the BESIII detector, a partial wave analysis of the decay $J/\psi \rightarrow \gamma K_S^0 K_S^0 \eta'$ is performed. The mass and width of the X(2370) are measured to be $2395 \pm 11(\text{stat})_{-94}^{+26}(\text{syst})$ MeV/ c^2 and $188_{-17}^{+18}(\text{stat})_{-33}^{+124}(\text{syst})$ MeV, respectively. The corresponding product branching fraction is $\mathcal{B}[J/\psi \rightarrow \gamma X(2370)] \times \mathcal{B}[X(2370) \rightarrow f_0(980)\eta'] \times \mathcal{B}[f_0(980) \rightarrow K_S^0 K_S^0] = (1.31 \pm 0.22(\text{stat})_{-0.84}^{+2.85}(\text{syst})) \times 10^{-5}$. The statistical significance of the X(2370) is greater than 11.7σ and the spin parity is determined to be 0^{-+} for the first time. **The measured mass and spin parity of the X(2370) are consistent with the predictions of the lightest pseudoscalar glueball.**

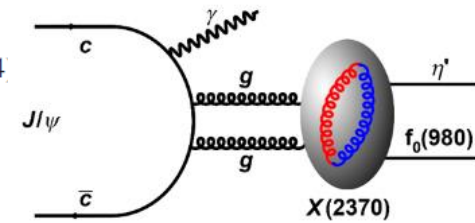

PRL 132, 181901 (2024)

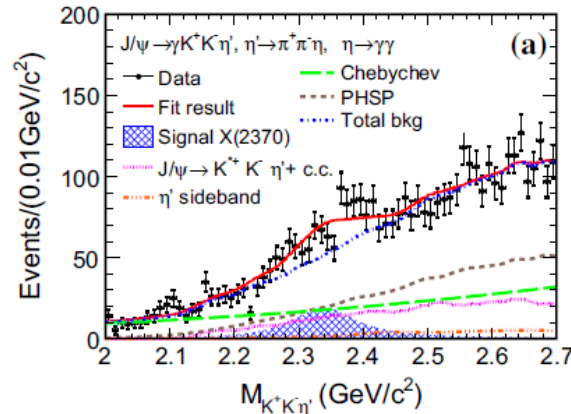
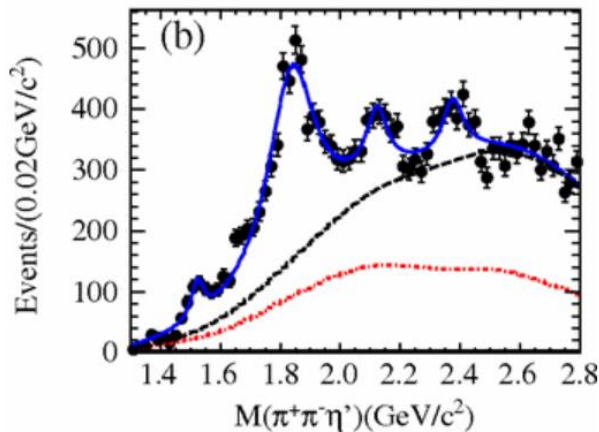

EPJC (2020) 80:746

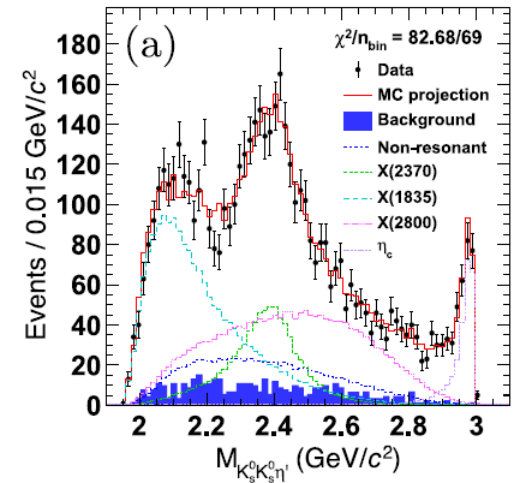

PRL 106, 072002 (2011)

Glueball-like particle X(2370) production

Glueball state, tetraquark state and molecular state of X(2370) are assumed to be coalesced in PFS and HFS, respectively.

PRD 110, 054046 (2024)

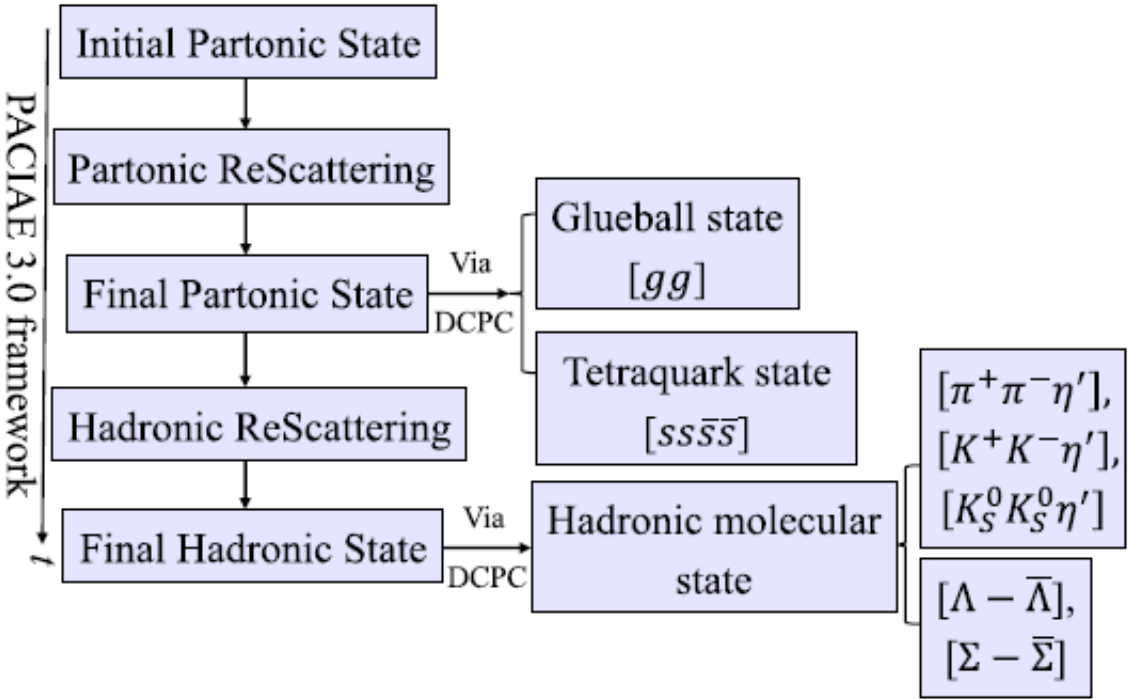

The parameters of X(2370) in DCPC model:

	Glueball	Tetraquark	Molecular	
			$B-\bar{B}$	3-mesons
Δm (MeV/c ²)	94	94	94	94
R_0 (fm)	1.0	1.0	1.0–2.0 ^a	1.0–2.0 ^b

X(2370) production in e^+e^- collisions

Discrepancy in different distributions:

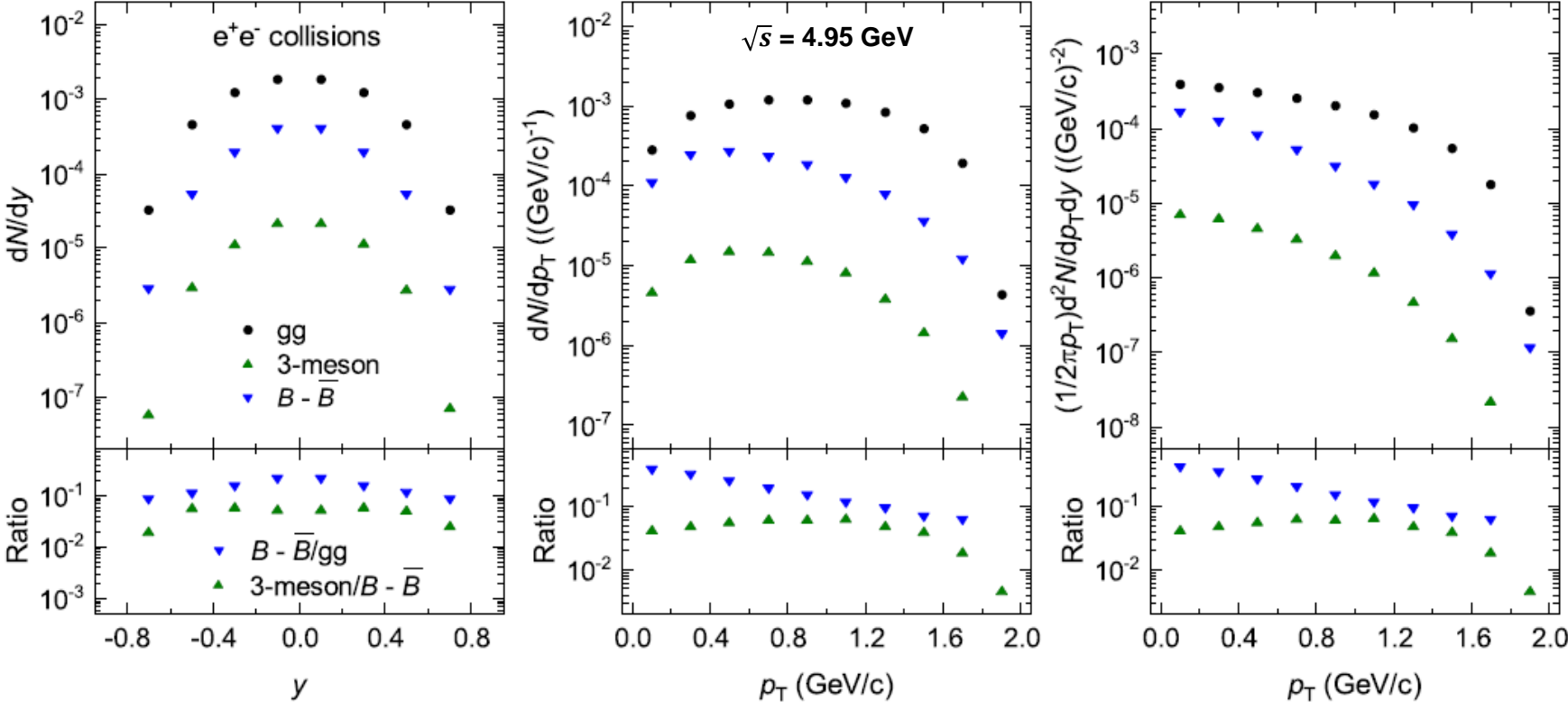

X(2370) production in pp collisions

Discrepancy in different distributions:

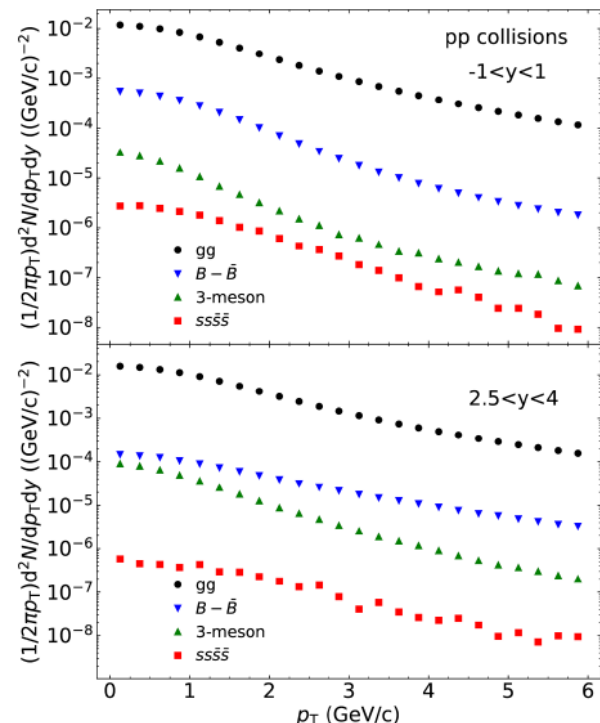
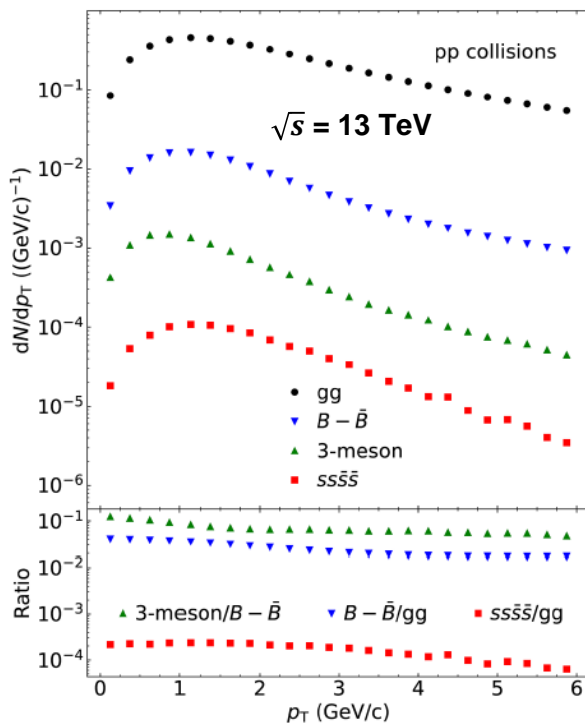
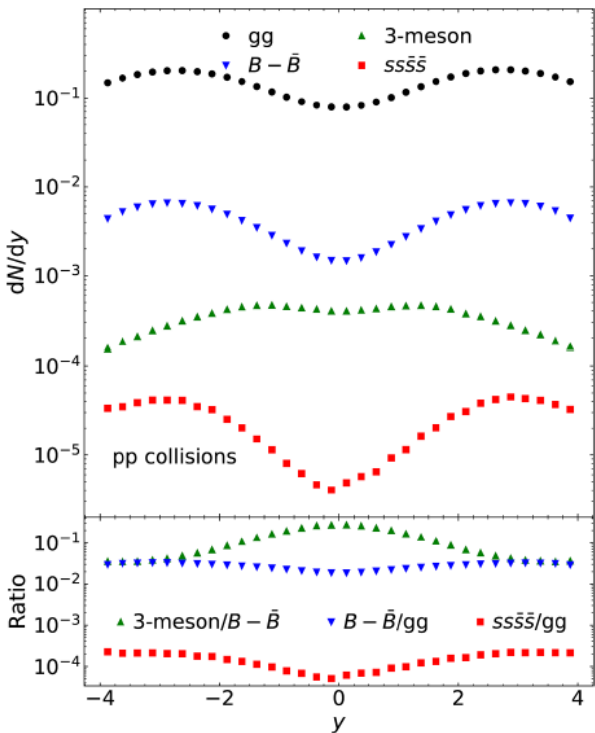

Summary & Outlook

- ✓ PACIAE model identifies the exotic hadron $X(3872)$ compact multiquark-state or loose molecule-state successfully.
- ✓ Discrepancy in formation times and apparent hadronization temperatures between two states.
- ✓ The discrepancy between multiquark- and molecule-state in basic observables (yield, rapidity distribution, p_T spectrum, etc.). Each of them may serve as a distinguishing criterion.
- ✓ Besides, the production of glueball-like particle $X(2370)$ glueball state, tetraquark state and molecular state is shown with PACIAE model.
- ✓ Next studies:
 - pp, p-Pb, Pb-Pb collisions at different energies;
 - Other tetraquarks, pentaquarks, dibaryons, etc., like T_{cc} ...
- ✓ These results are important for future experimental searches and enrich theoretical estimates in the exotics sector.

Thank you for your attention!
