

UPC and far-forward detection

Ronan McNulty
Quarkonia as Tools, Aussois,
Jan 6-10 2024



Overview

- Introduction to UPC
- (Comments on Odderon at LHC)
- Search for saturation
- Far-forward detection in UPC

pp collision

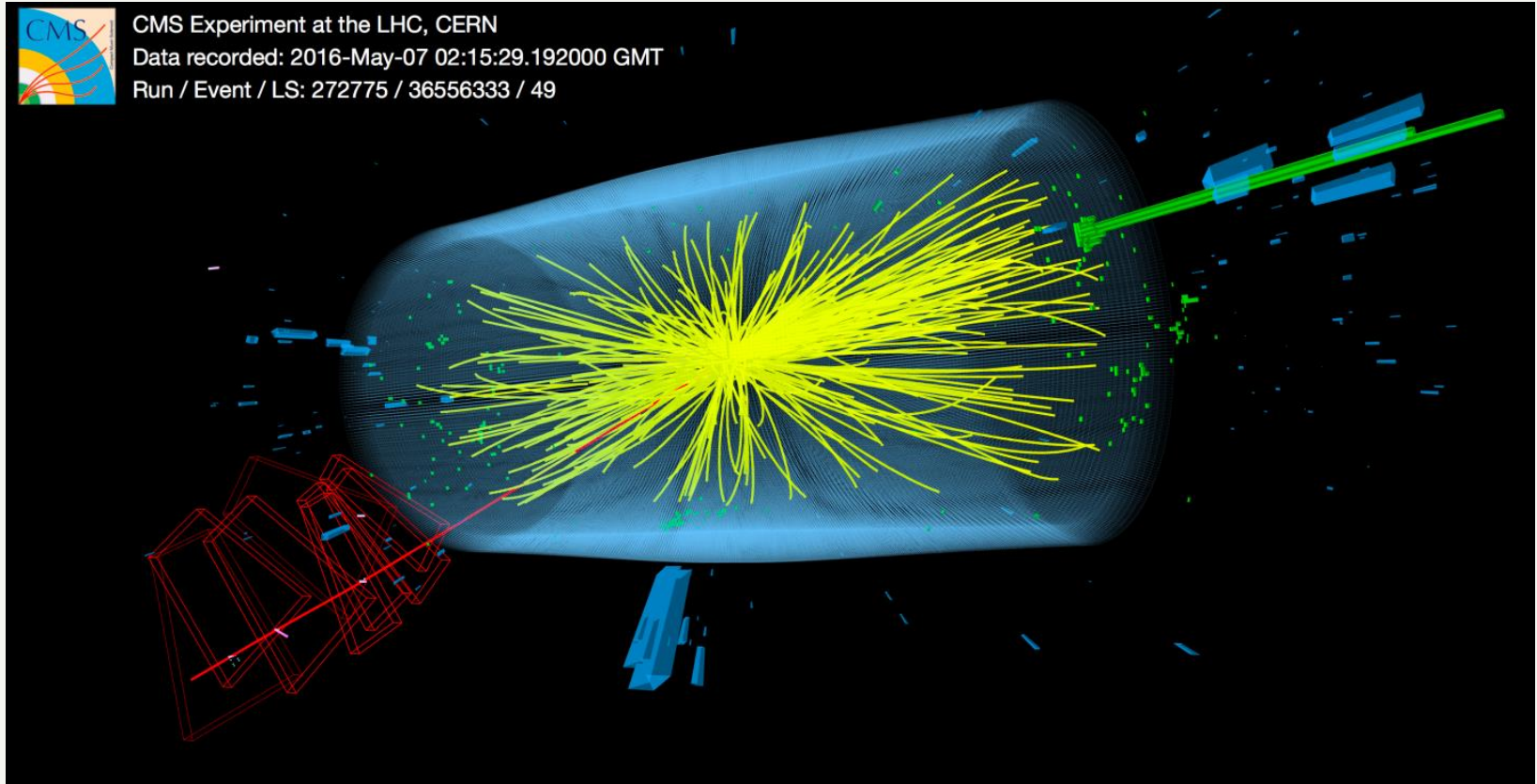

Most collisions at the LHC, pp, pA, AA have enormous multiplicities due to colour flow. However, when colourless propagators are involved, multiplicities are low and events have large **rapidity gaps**.

UPC J/ψ at forward rapidity in ALICE PbPb data

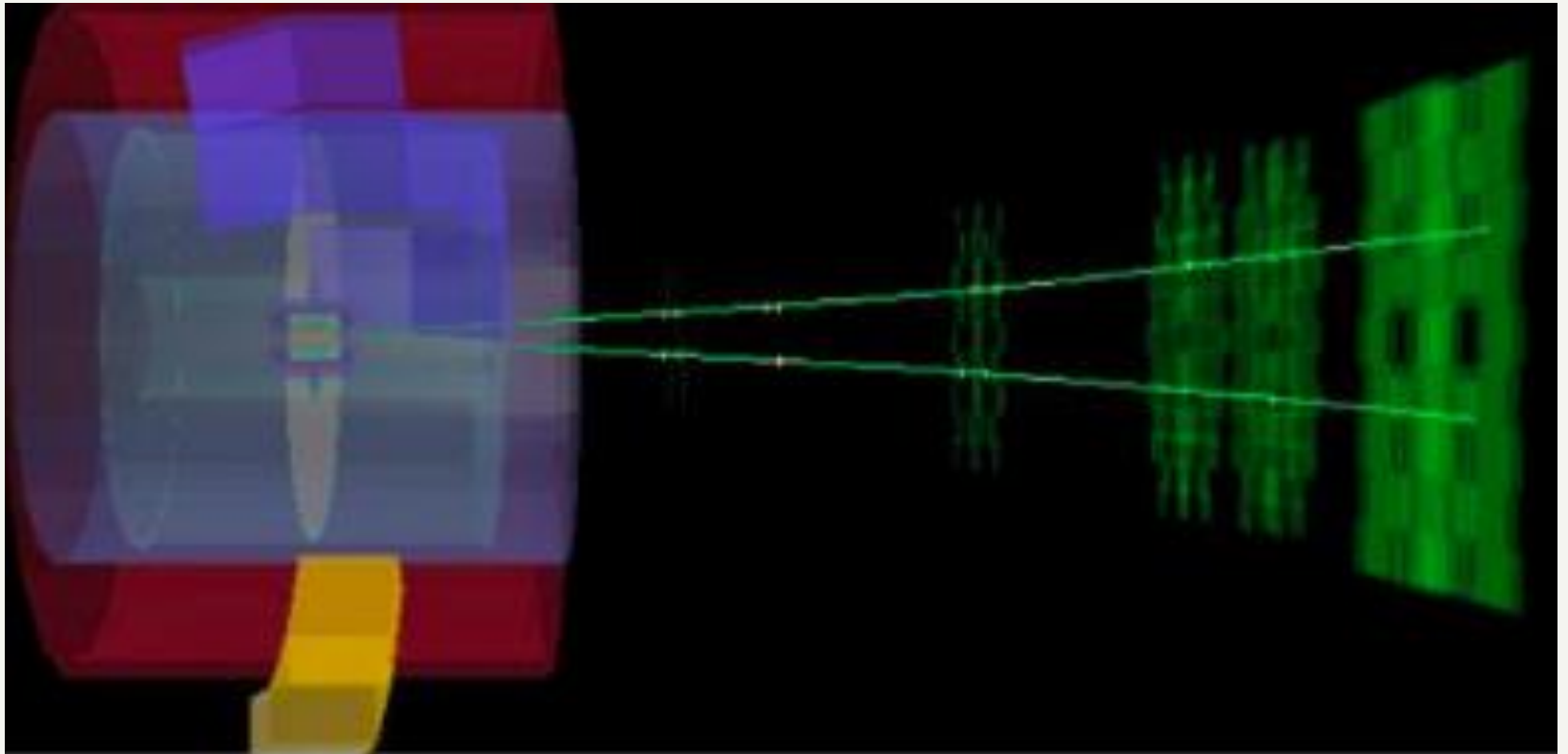

(from Evgeny Kryshen talk at INT workshop)

Physics of the Vacuum

Elastic scattering

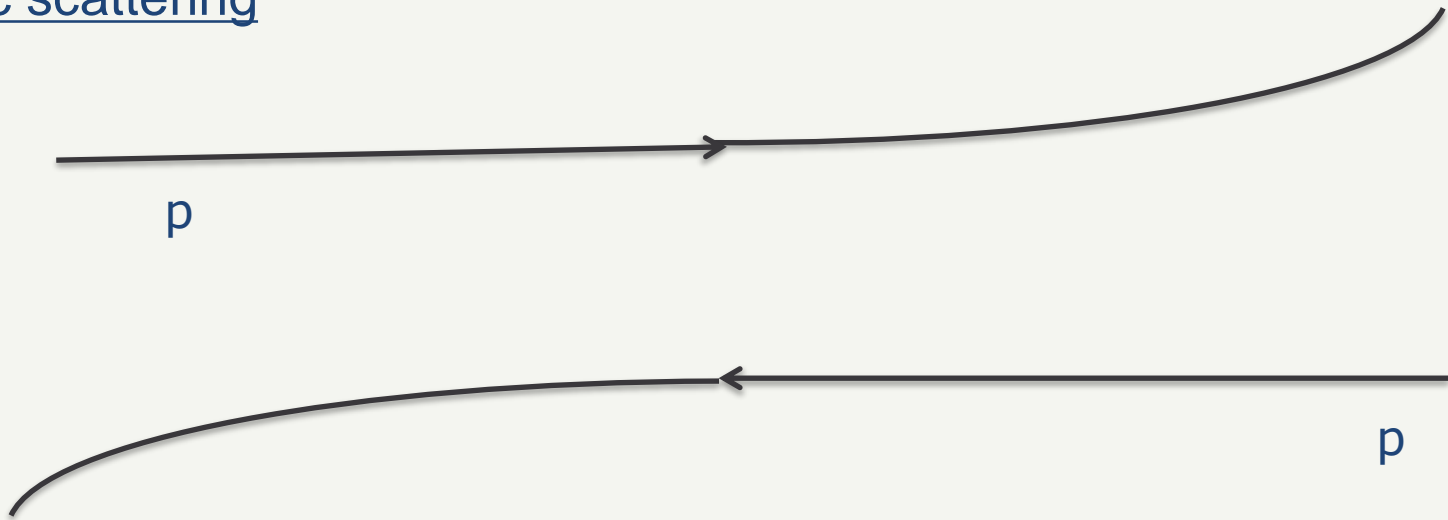

It's QCD – but not as we normally see it. It's colour-free

σ_{elastic}	$\approx 40\text{mb}$	←
$\sigma_{\text{diffractive}}$	$\approx 10\text{mb}$	
$\sigma_{\text{inelastic}}$	$\approx 60\text{mb}$	

Physics of the Vacuum

Elastic scattering

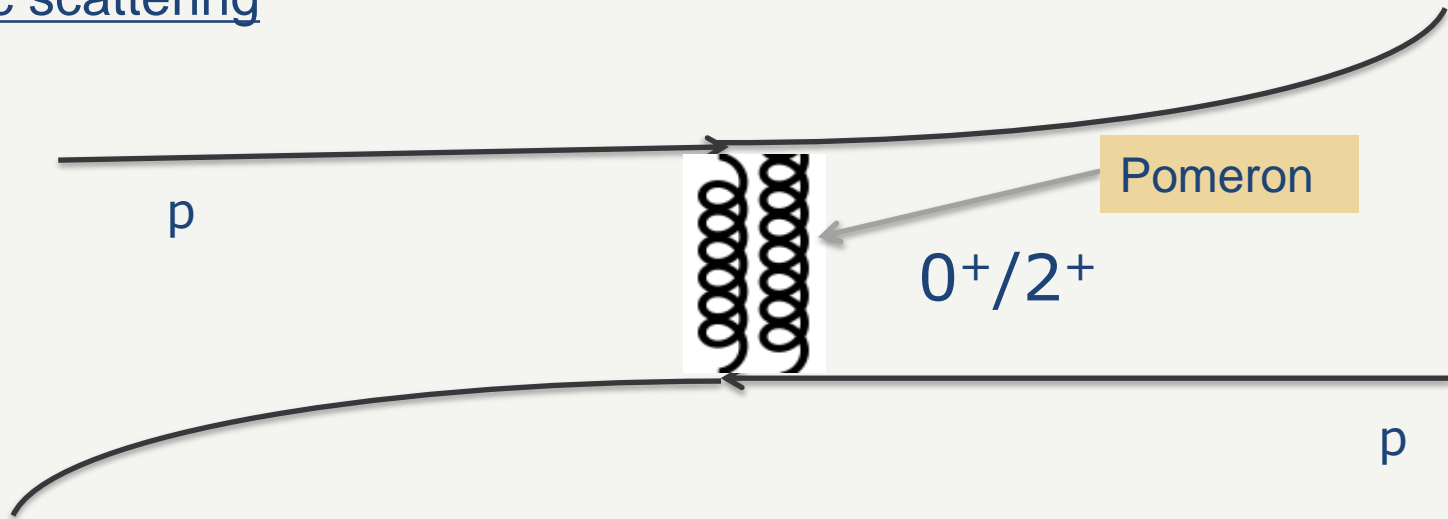

It's QCD – but not as we normally see it. It's colour-free

$\sigma_{\text{elastic}} \approx 40\text{mb}$ ←
 $\sigma_{\text{diffractive}} \approx 10\text{mb}$
 $\sigma_{\text{inelastic}} \approx 60\text{mb}$

Physics of the Vacuum

Elastic scattering

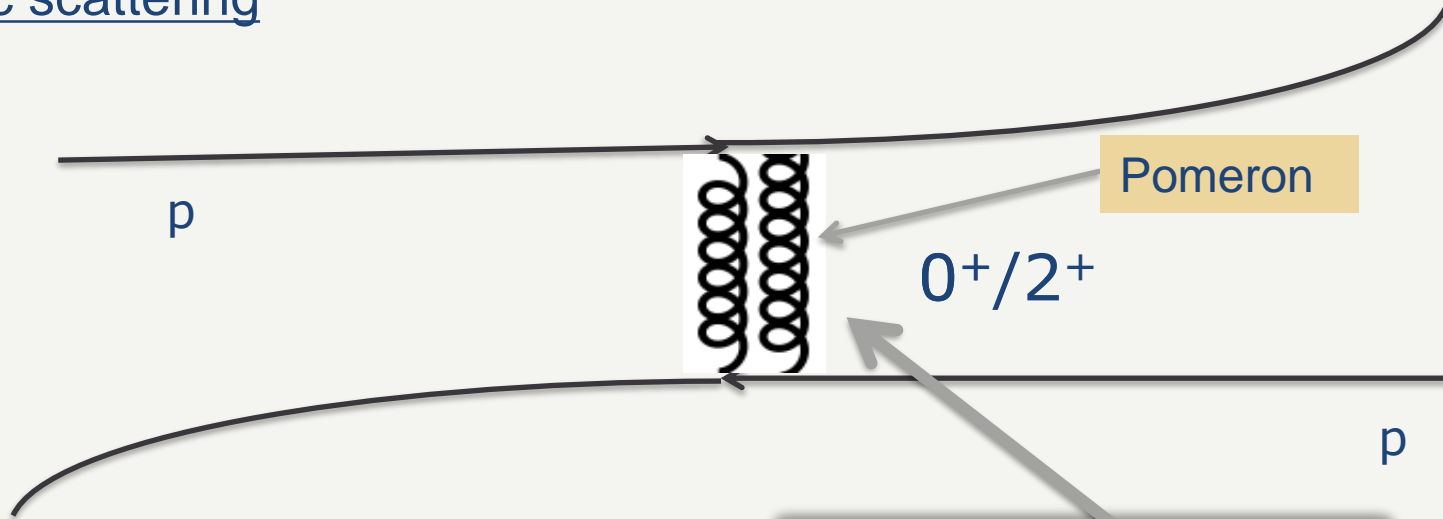

At high energy: $A(s,t)=s^{\alpha(t)}$
 $\alpha_P(t)=\alpha_P(0)+\alpha't$

$\sigma_{\text{elastic}} \approx 40\text{mb}$ ←
 $\sigma_{\text{diffractive}} \approx 10\text{mb}$
 $\sigma_{\text{inelastic}} \approx 60\text{mb}$

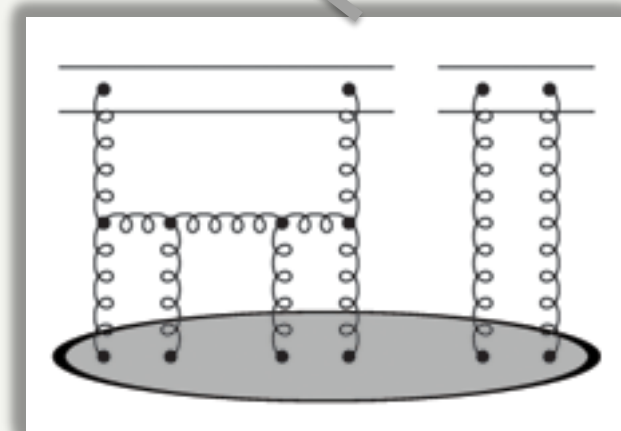

Physics of the Vacuum

Diffractive

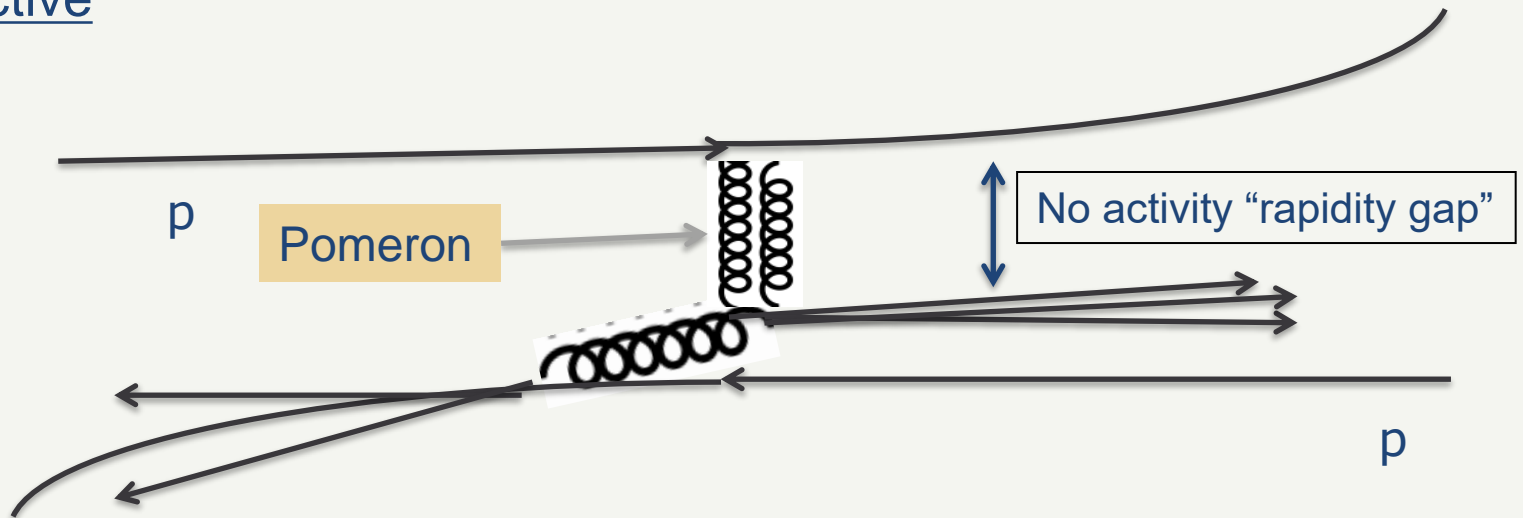

Experimental working definition of diffraction is presence of rapidity gap

$\sigma_{\text{elastic}} \approx 40\text{mb}$
 $\sigma_{\text{diffractive}} \approx 10\text{mb}$ ←
 $\sigma_{\text{inelastic}} \approx 60\text{mb}$

Physics of the Vacuum

Central Exclusive Production

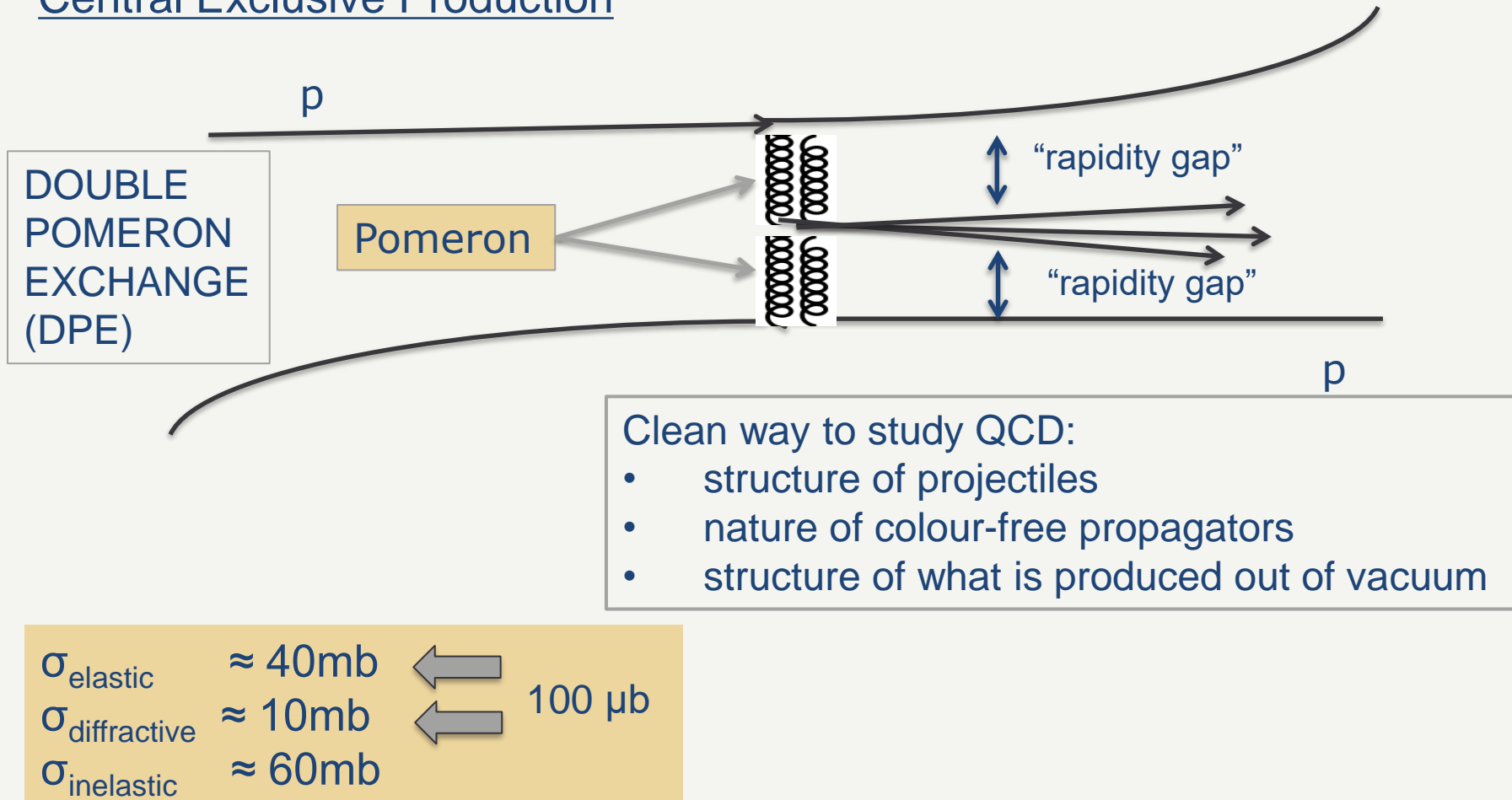

Physics of the Vacuum

Central Exclusive Production

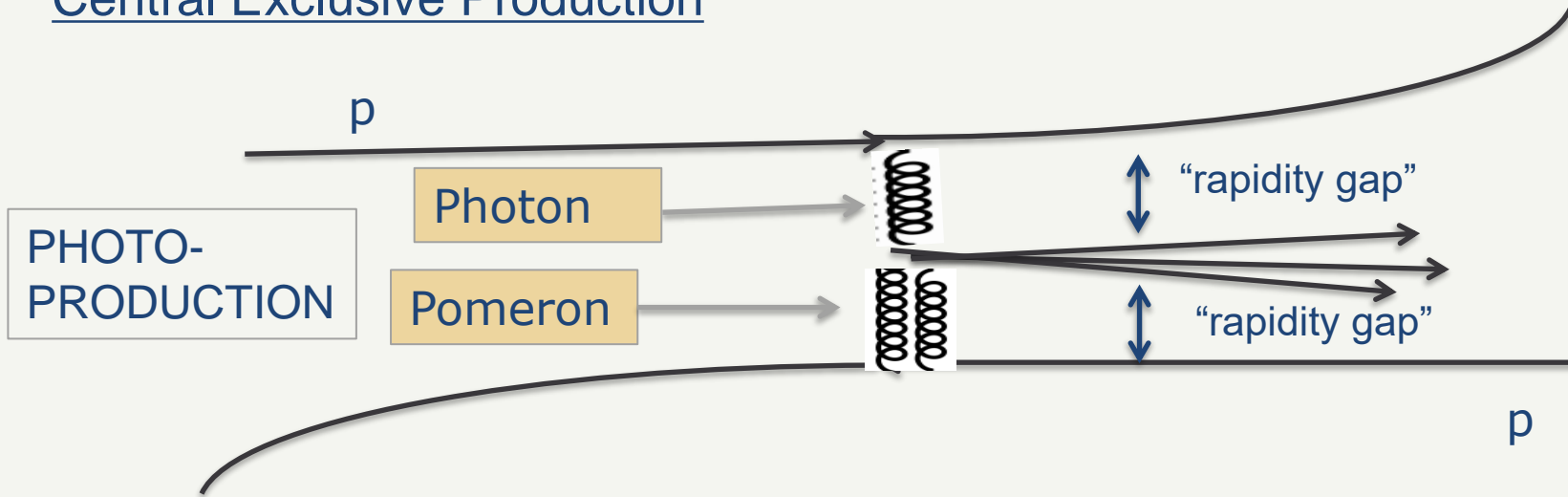

σ_{elastic}	$\approx 40\text{mb}$	\leftarrow	100 μb
$\sigma_{\text{diffractive}}$	$\approx 10\text{mb}$	\leftarrow	
$\sigma_{\text{inelastic}}$	$\approx 60\text{mb}$		

Physics of the Vacuum

Central Exclusive Production

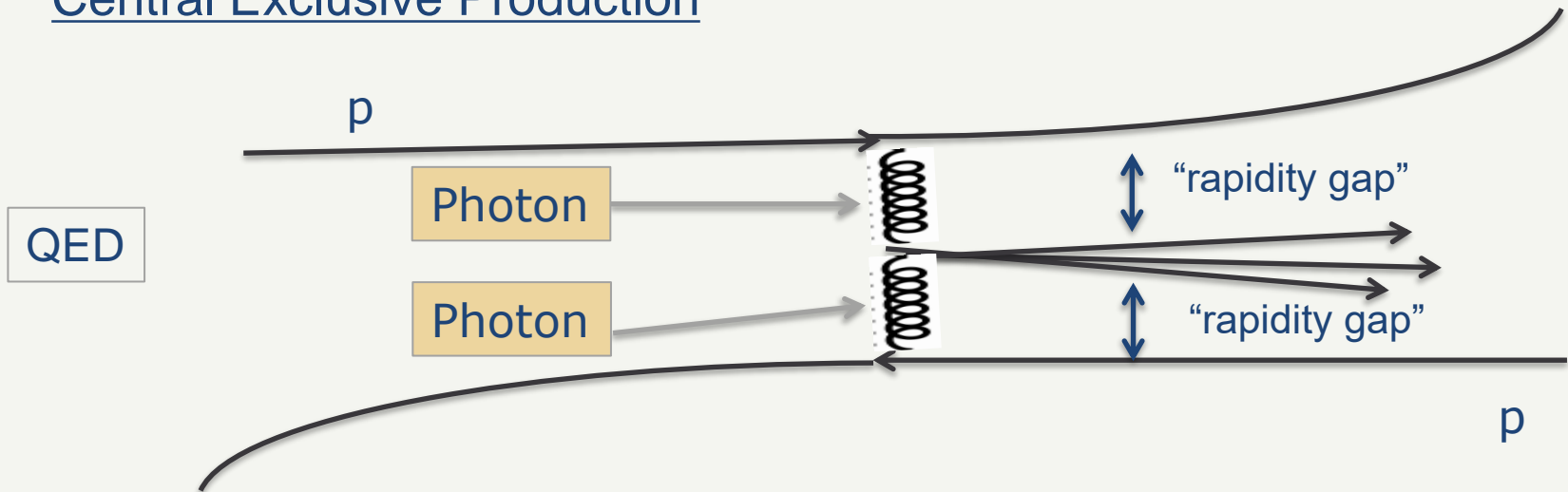

CEP is characterised by a rapidity gap all the way to the proton

Detect as large a gap as possible...

σ_{elastic}	$\approx 40\text{mb}$	\leftarrow	100 pb
$\sigma_{\text{diffractive}}$	$\approx 10\text{mb}$	\leftarrow	
$\sigma_{\text{inelastic}}$	$\approx 60\text{mb}$		

Colourless propagators

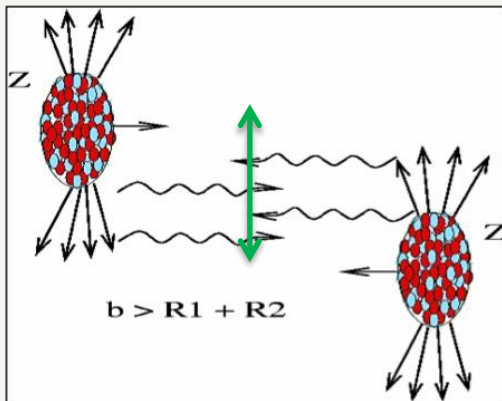
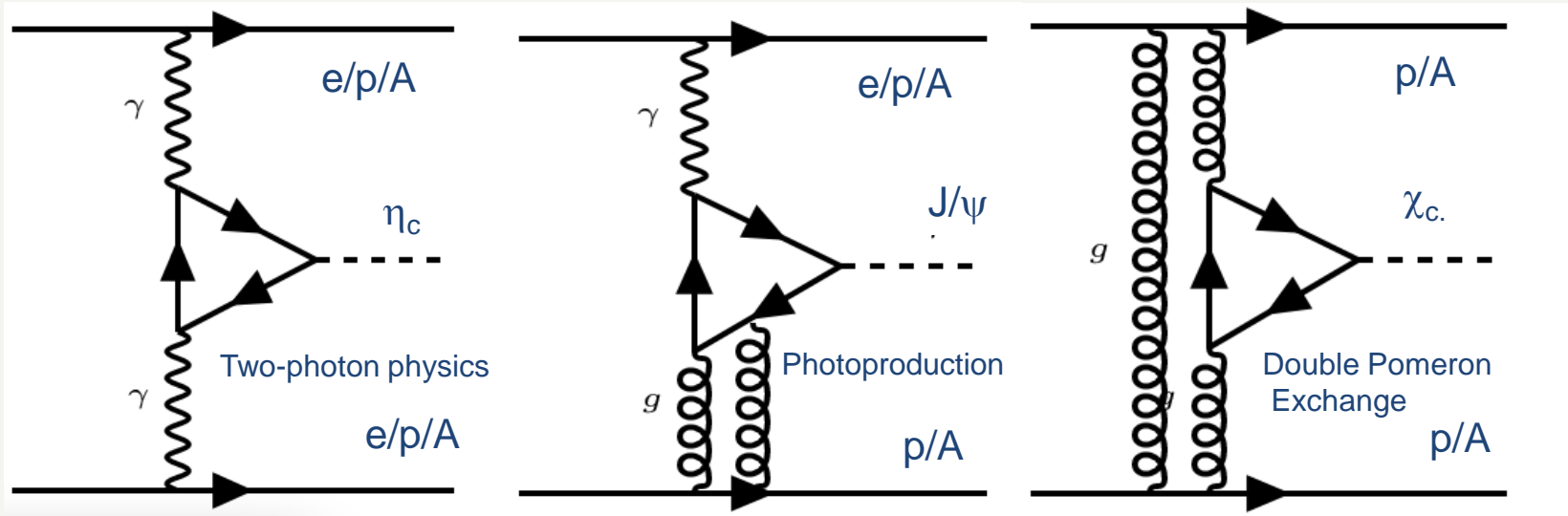

Hadron colliders:

Generally, to ensure no (colourful) QCD interaction, $d > R_1 + R_2$ (1.5 - 6 fm).

Large impact parameter \leftrightarrow Small p_T

Electron-hadron collider:

$\sim 70\%$ of total cross-section is diffractive

Odderon search: partner of pomeron

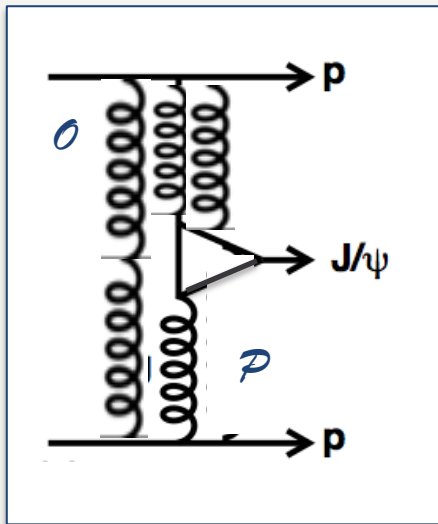

C-odd
meson

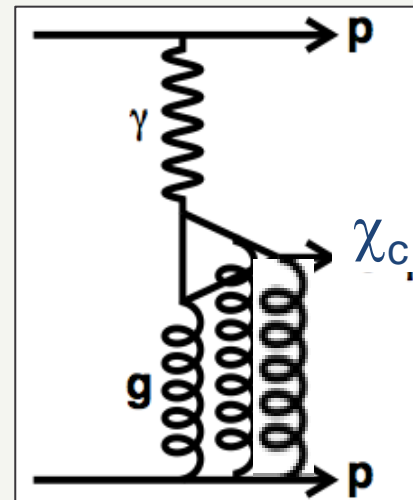

C-even
meson

Method 1: High p_T exclusive C- production

Replace γ with ϕ

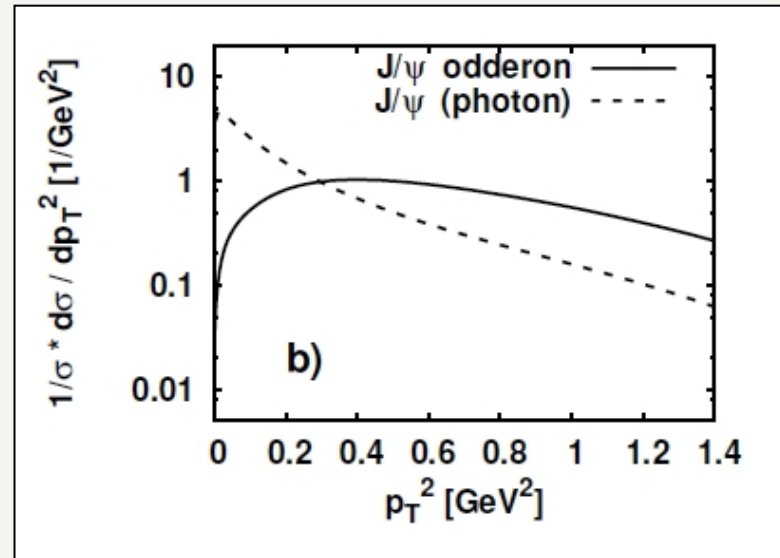
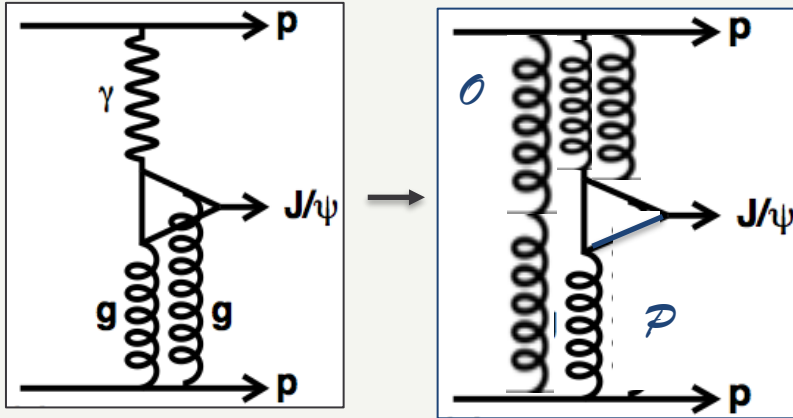

Bzdak, Motyka, Szymanowski, Cudell PRD 75 (2007) 094023

$$\frac{dS}{dt} \sim e^{bt}$$

Photoproduction: $b \sim 6 \text{ GeV}^{-2}$
 Proton dissociation $b \sim 1 \text{ GeV}^{-2}$
 Odderon b small

$d\sigma^{\text{corr}}/dy$	J/ψ	
	odderon	photon
Tevatron	0.3–1.3–5 nb	0.8–5–9 nb
LHC	0.3–0.9–4 nb	2.4–15–27 nb

Odderon contribution might be 1-10% at LHC and would dominate at high p_T
 but experimentally **this is difficult to see**

Angular distribution of muons due to polarisation may also differ (R. Schnicker)

Method 2: Photoproduction of C+

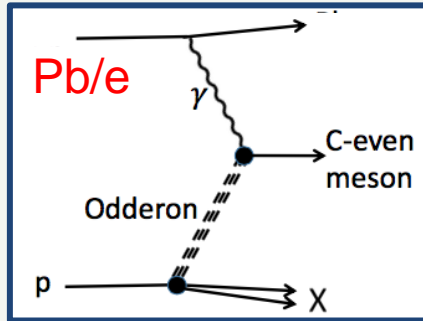

Czyzewski, Kwiecinski, Motyka, PLB398 (1997) 400.
 Berger, Donnachie, Dosch, Kilian, Nachtmann, EPJ C9 (1999) 491.
 Ryskin EPJ C2 (1998) 339.
 Kilian & Nachtmann, EPJ C5 (1998) 317.
 Harland-Lang, Khoze, Martin, Ryskin PRD 99 (2019) 3, 034011

Acta Phys. Polon. B33, 3499 (2002). (Conference proceeding.)

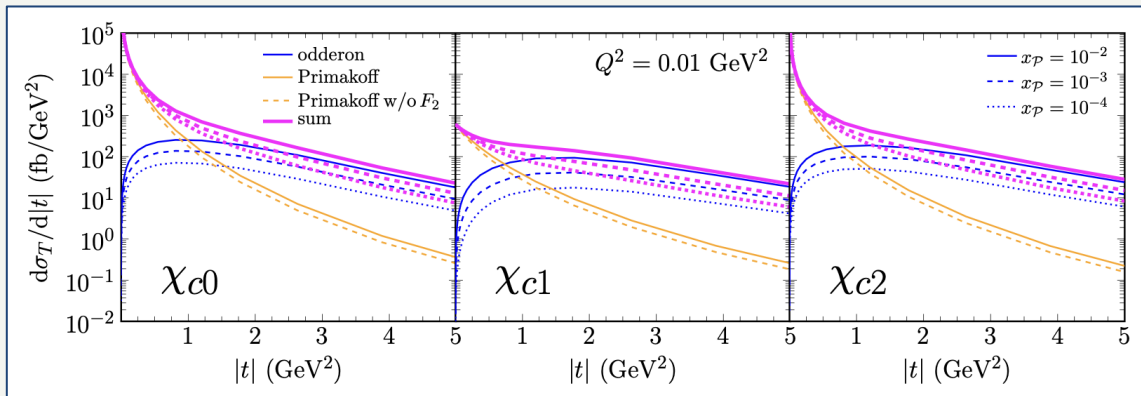
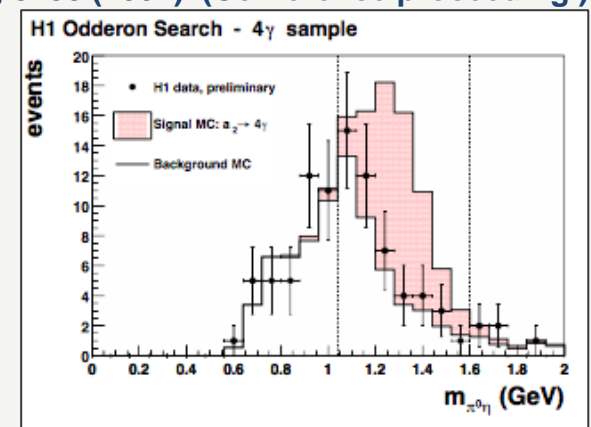
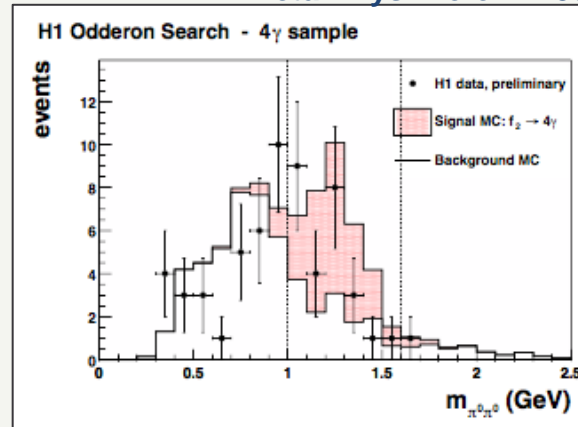
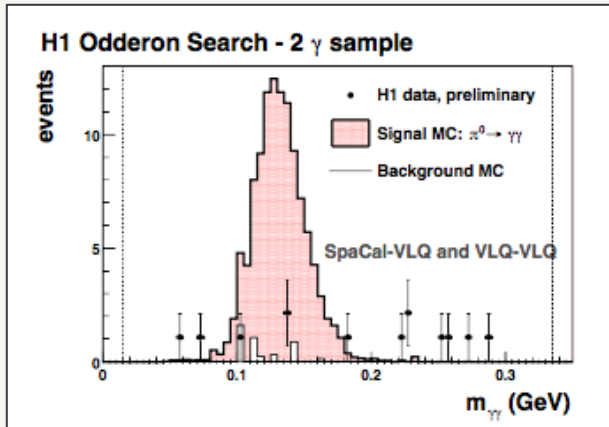

Phys.Rev.D 110 (2024) 1, 014025

Might be seen forward in p-Pb / PbPb

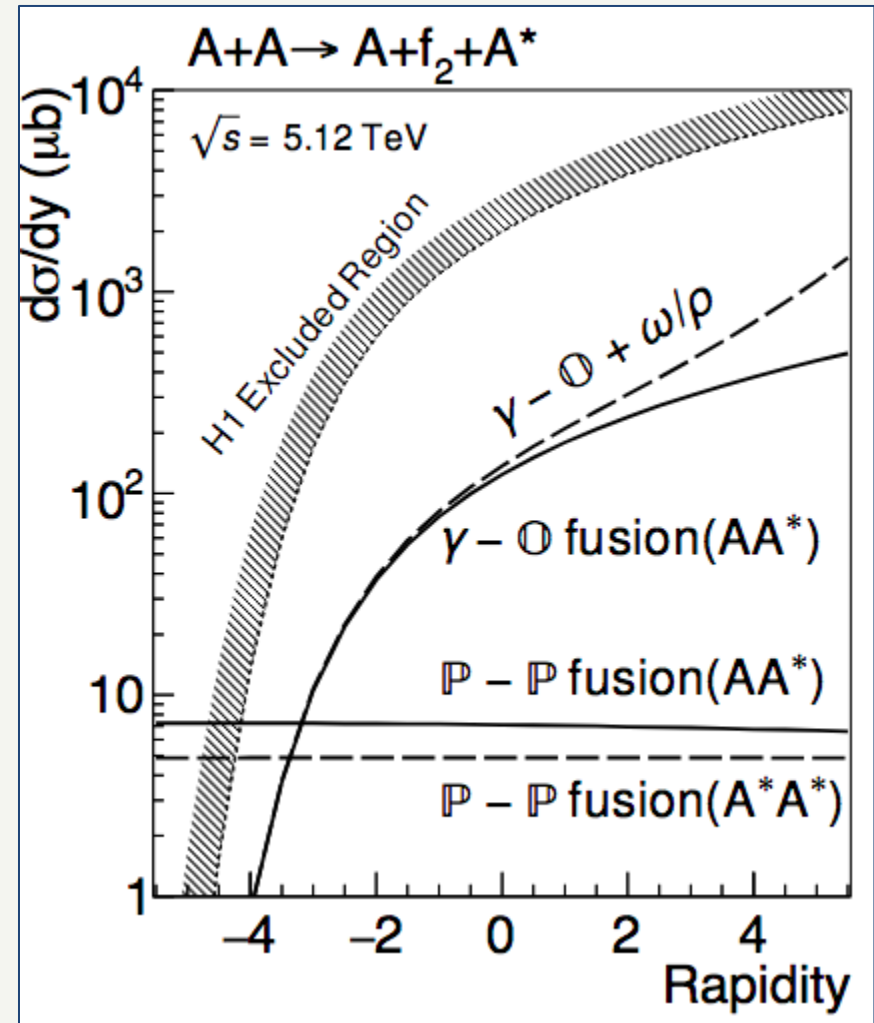
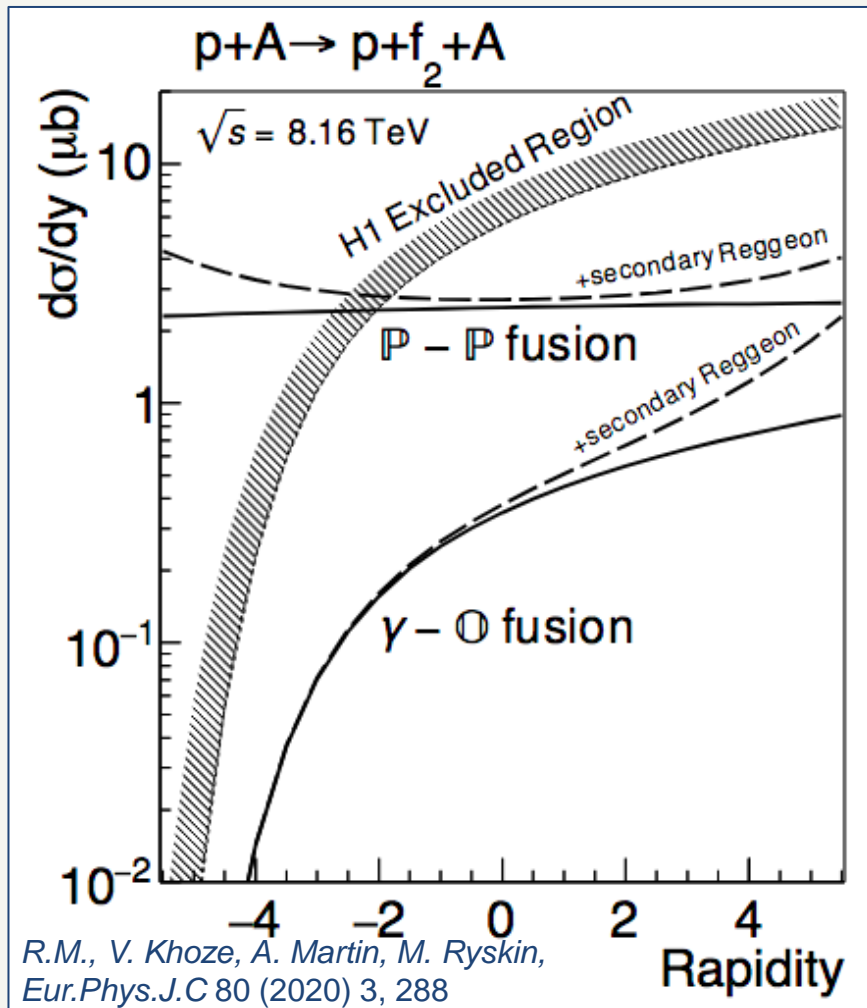

(Role of survival factors and nuclear break-up important here)

Photoproduction

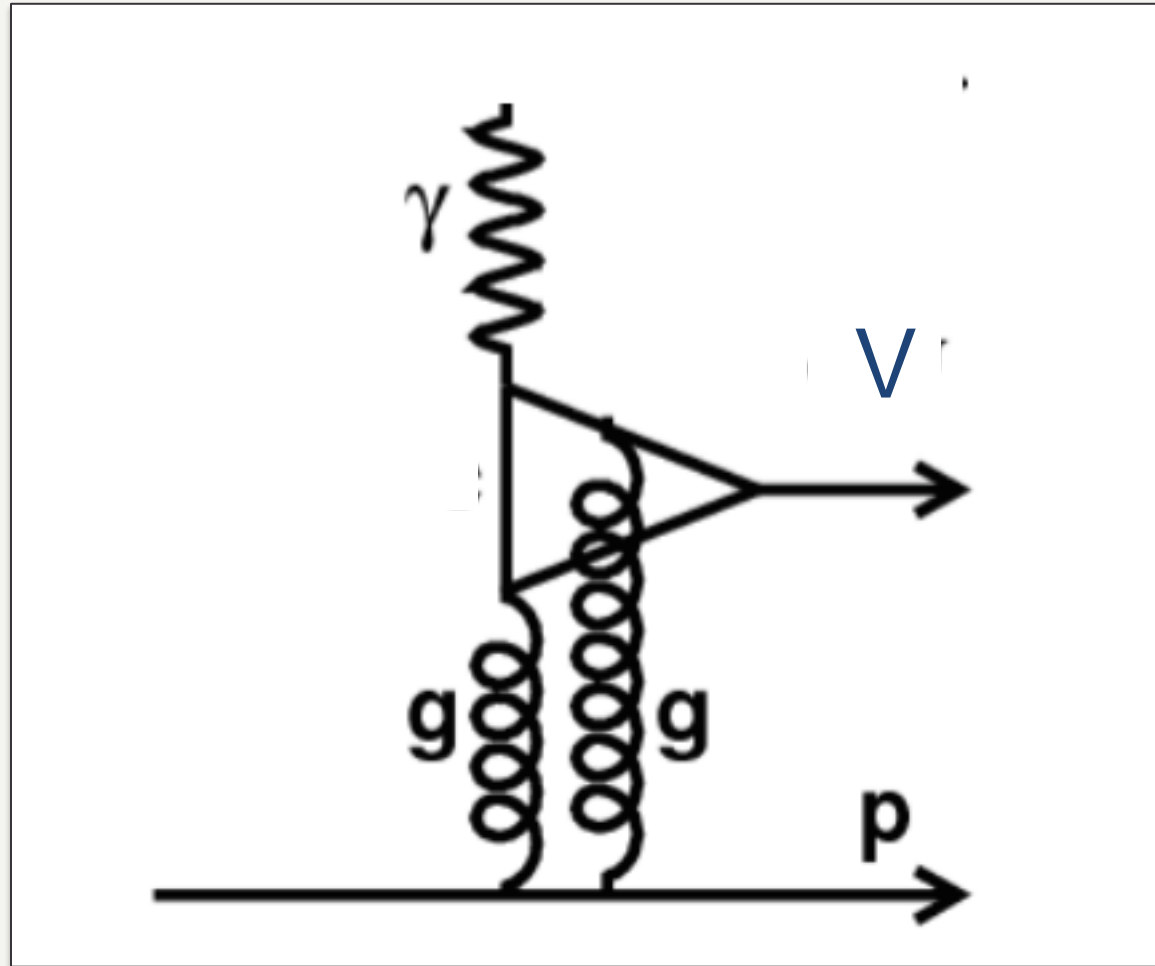

Understanding structure of hadrons

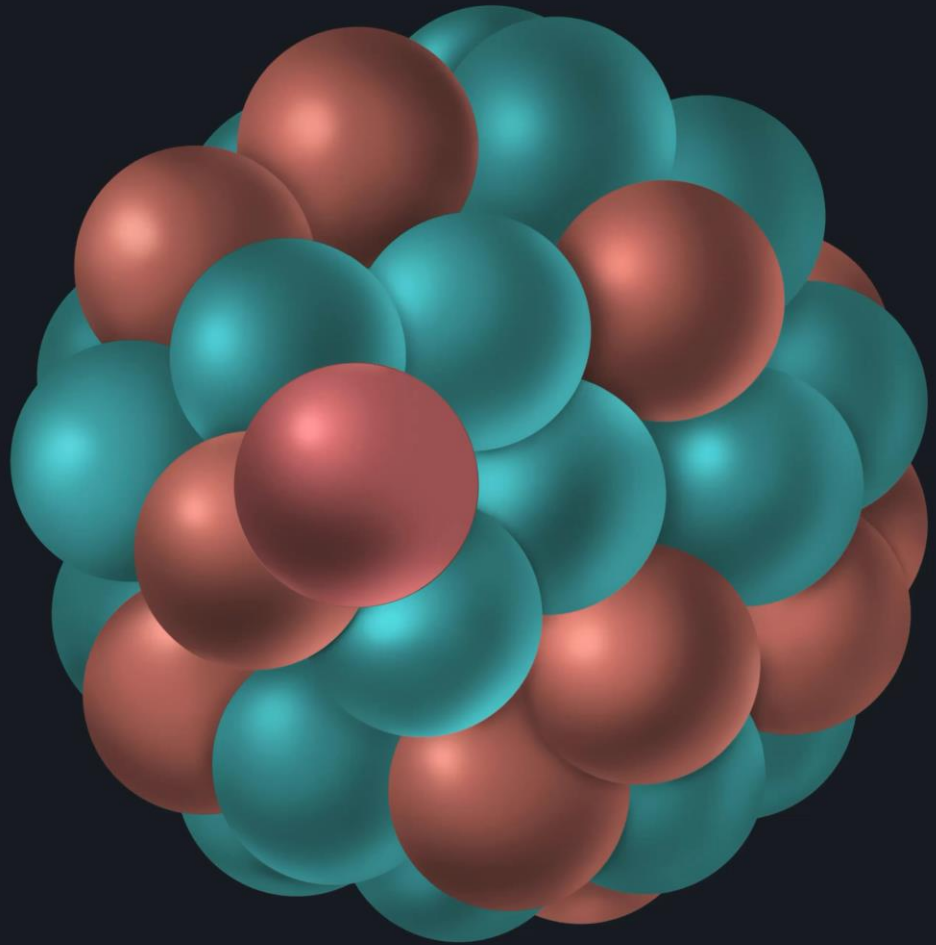

Ridzikova Alexandra
FNSPE CTU PRAGUE

Understanding structure of hadrons

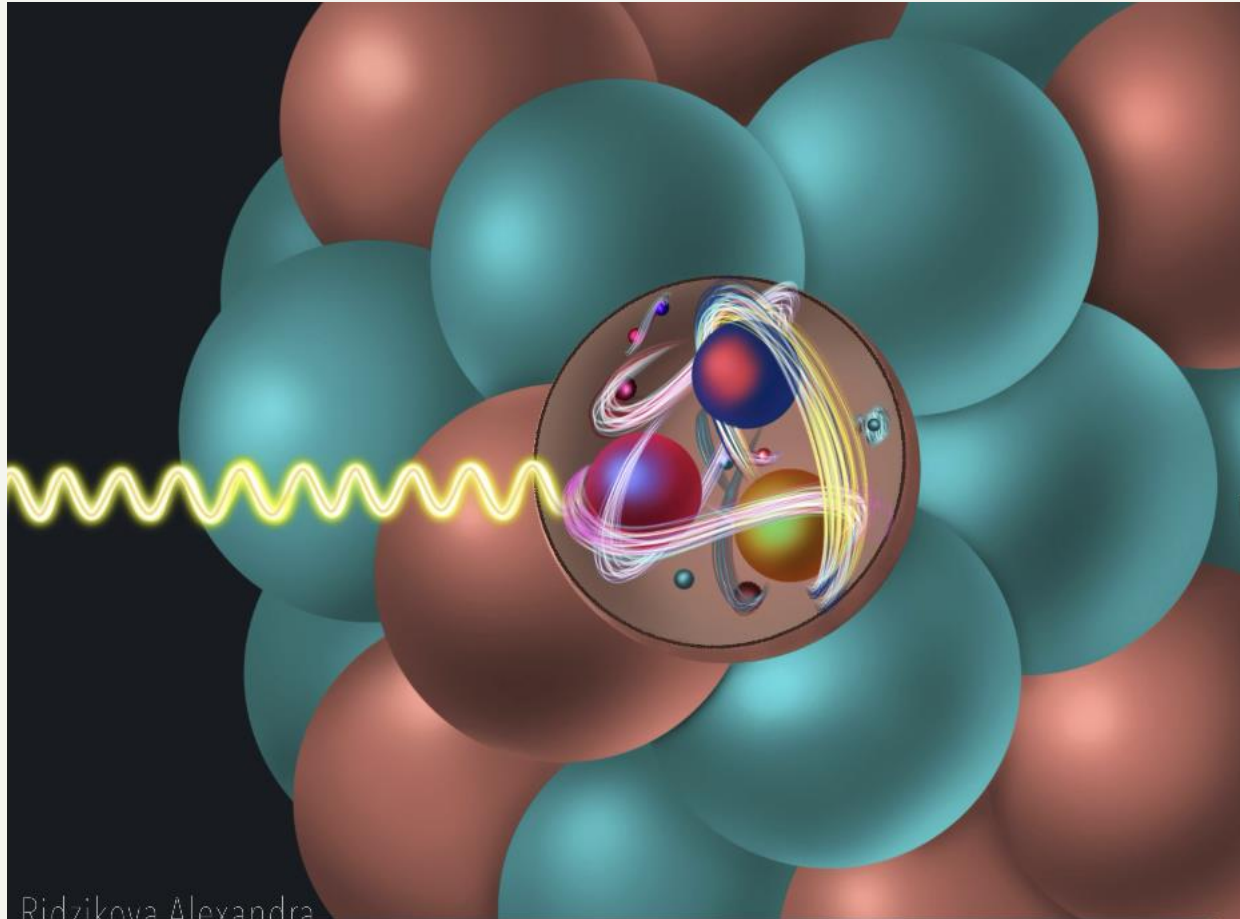

Gluon recombination (saturation)

Fractional
momentum
of the parton



Energy Scale



Ridzikova Alexandra FNSPE CTU PRAGUE

Gluon recombination (saturation)

Fractional momentum of the parton

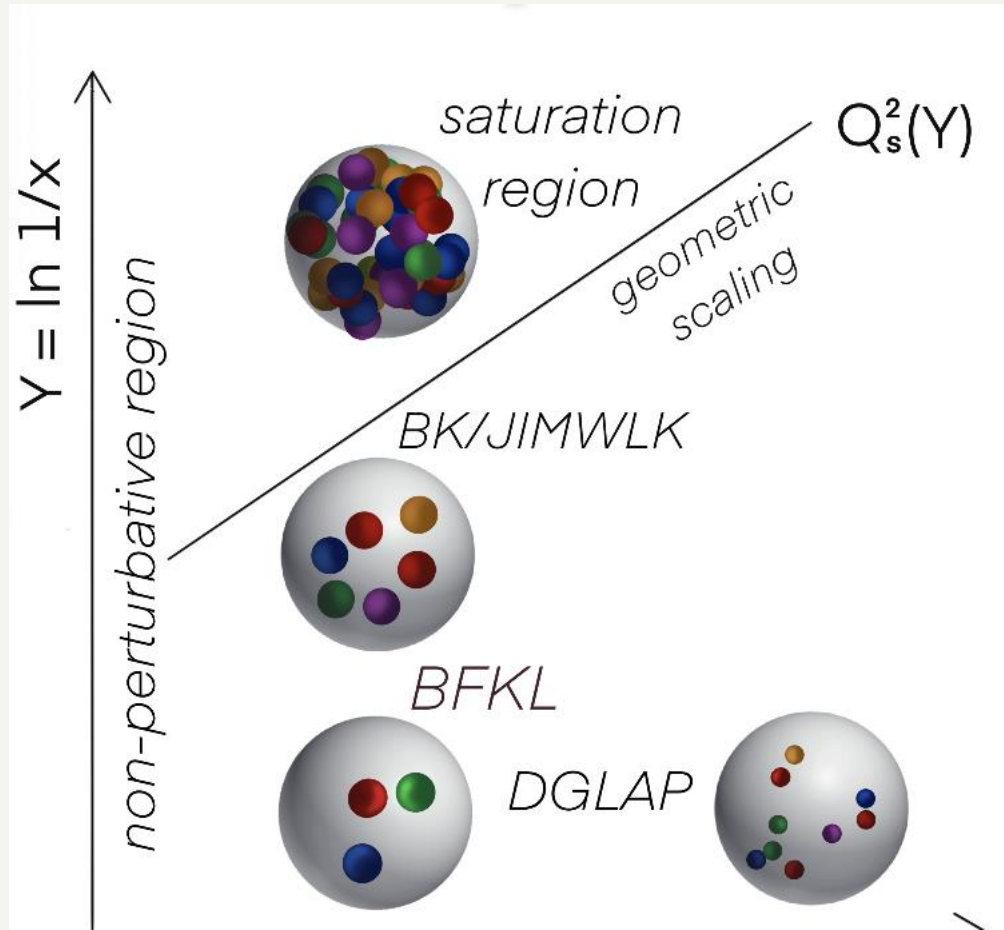

Energy Scale



Photoproduction

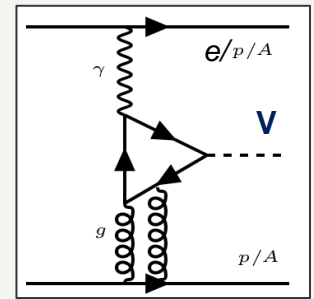

- Rise in σ related to Pomeron intercept
 - $\sigma \sim W^\delta$
 - $\delta = 4(\alpha_P(t) - 1)$
 - $\alpha_P(t) = \alpha_P(0) + \alpha' t$
- Compare slopes ρ, ω, ϕ to $J/\psi, \psi', \Upsilon$
- Extract $g(x, Q^2)$

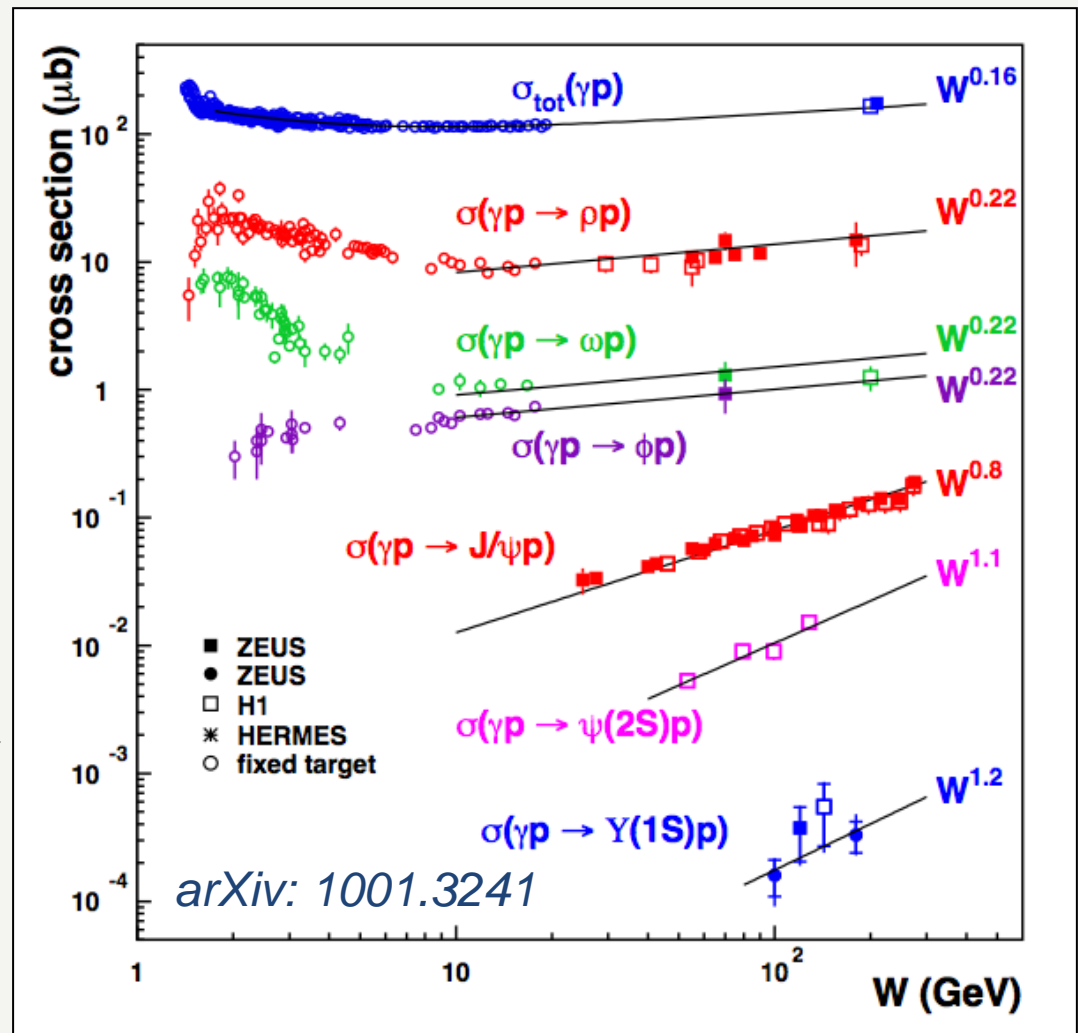

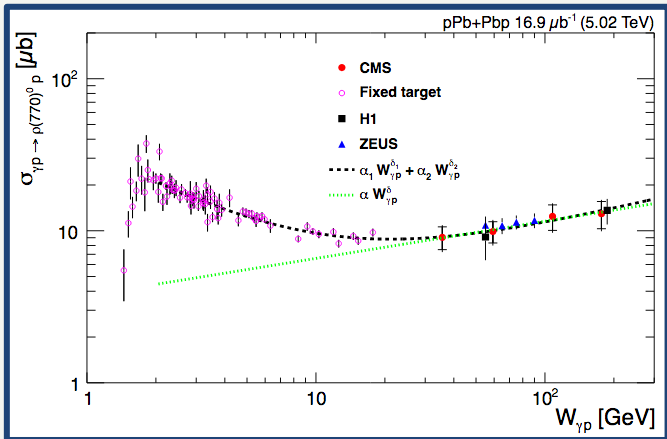

ALICE (pPb, PbPb)
LHCb (pp, PbPb)

Central region
 $W_{\text{LHC}} \sim W_{\text{HERA}}$
Forward
 $W_{\text{LHC}} \gg W_{\text{HERA}}$

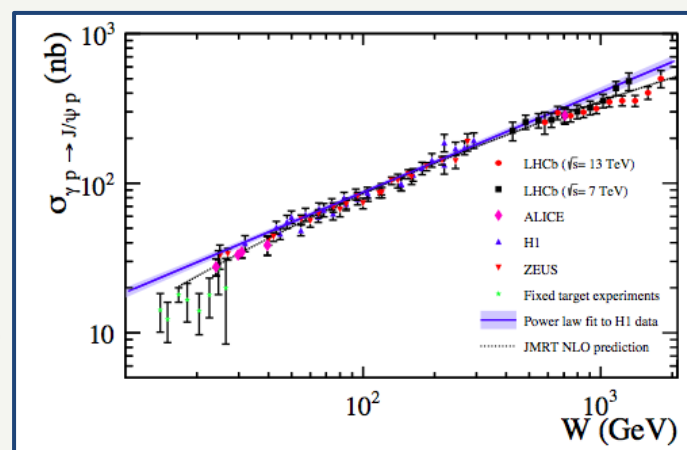

CMS (pPb) ALICE (XeXe, PbPb)

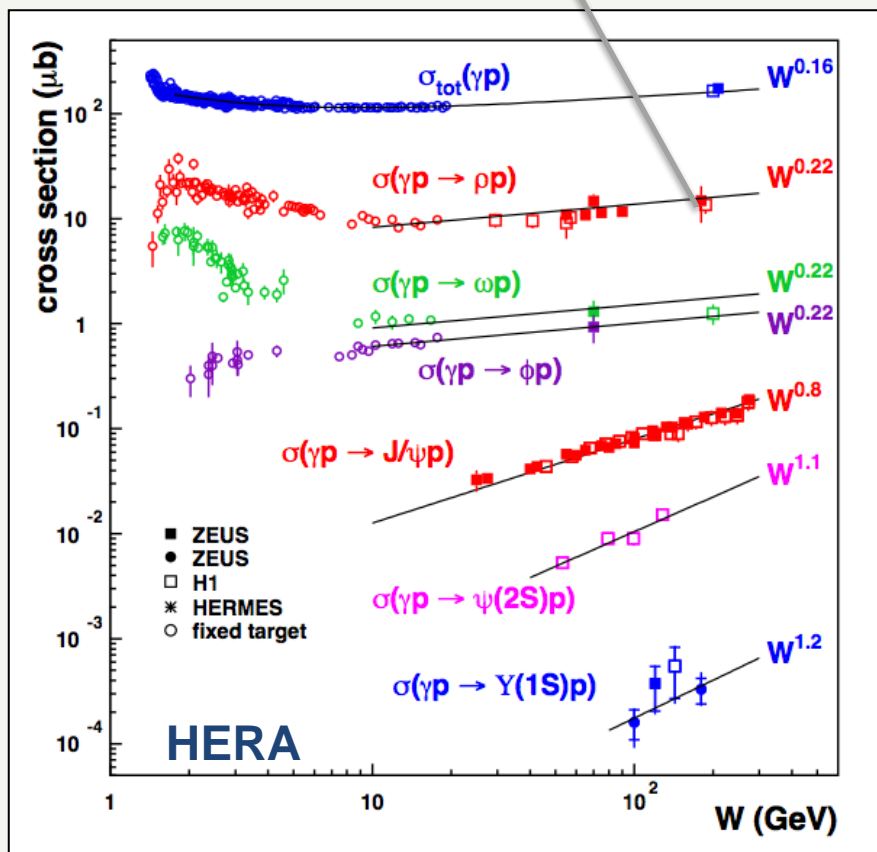

LHCb
(pp, PbPb)

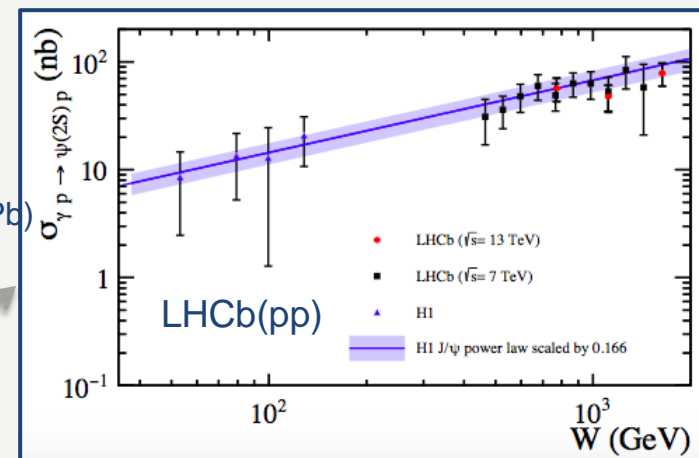

LHCb (pp)
CMS (pPb)

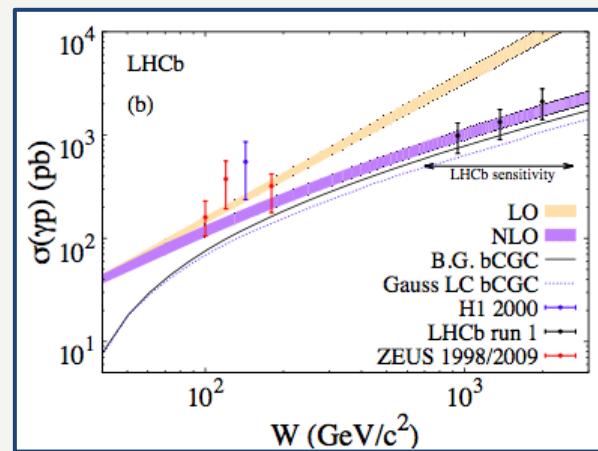

UPC and far-forward detection

Implications: GPDs and PDF

Ryskin, Z. Phys. C 57 (1993) 89

$$\frac{d\sigma}{dt} (\gamma^* p \rightarrow J/\psi p) \Big|_{t=0} = \frac{\Gamma_{ee} M_{J/\psi}^3 \pi^3}{48\alpha} \left[\frac{\alpha_s(\bar{Q}^2)}{\bar{Q}^4} xg(x, \bar{Q}^2) \right]^2 \left(1 + \frac{Q^2}{M_{J/\psi}^2} \right)$$

Flett, Martin, Ryskin, Teubner. Phys.Rev.D 102 (2020) 114021

Flett, Jones, Martin, Ryskin, Teubner. Phys.Rev.D 101 (2020) 9, 094011

low-x

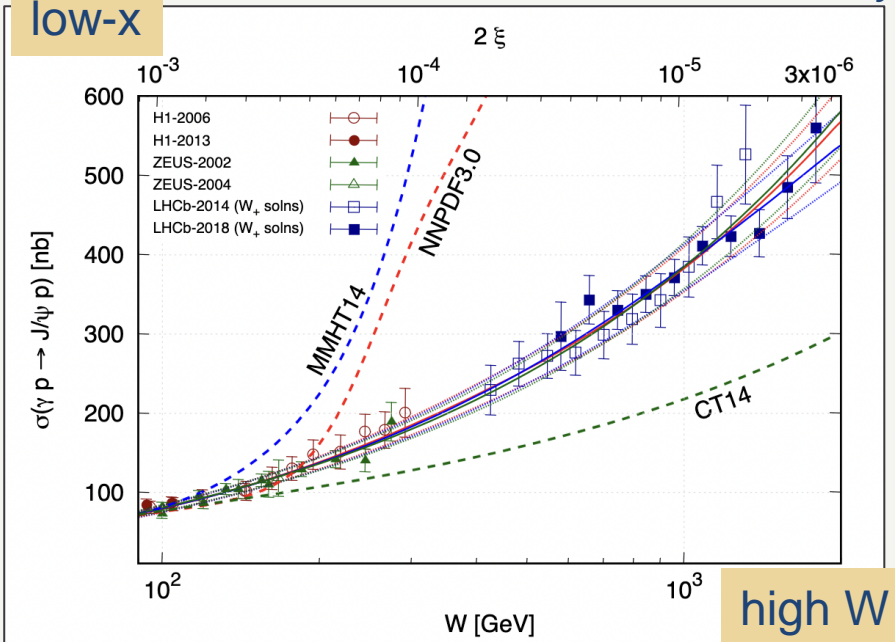

high W

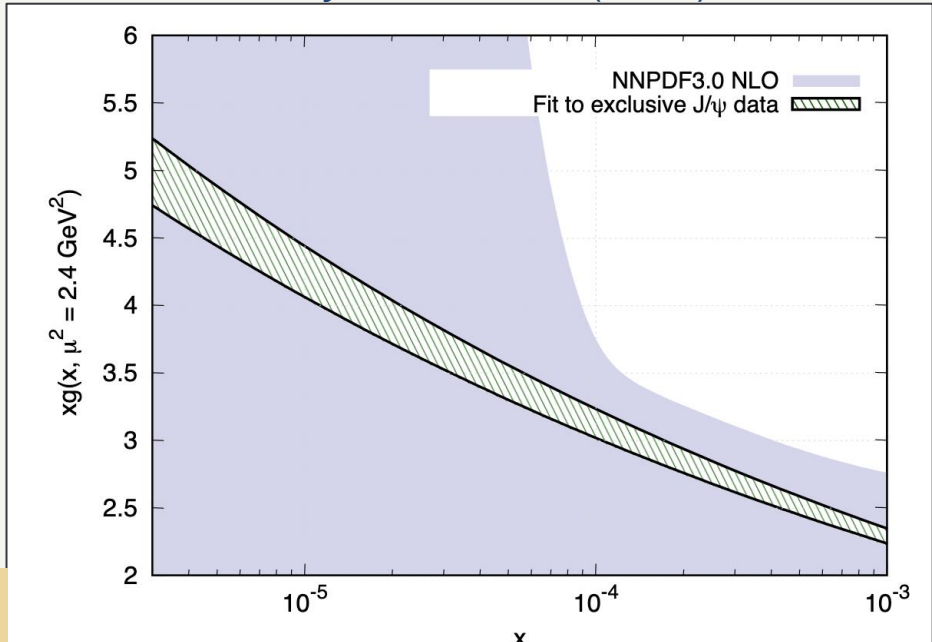

makes use of Shuvaev transform to relate GPDs and PDFs

$$H_q(X, \xi) = \int_{-1}^1 dx' \left[\frac{2}{\pi} \text{Im} \int_0^1 \frac{ds}{y(s)\sqrt{1-y(s)x'}} \right] \frac{d}{dx'} \left(\frac{q(x')}{|x'|} \right),$$

$$H_g(X, \xi) = \int_{-1}^1 dx' \left[\frac{2}{\pi} \text{Im} \int_0^1 \frac{ds (X + \xi(1-2s))}{y(s)\sqrt{1-y(s)x'}} \right] \frac{d}{dx'} \left(\frac{g(x')}{|x'|} \right),$$

where the transform kernel,

$$y(s) = \frac{4s(1-s)}{(X + \xi(1-2s))}.$$

Implications: Saturation

Saturation effects become visible at low-x.
 Onset of saturation expected to scale with nucleon density $\sim A^{1/3}$ so
may be easier to see in nuclear collisions

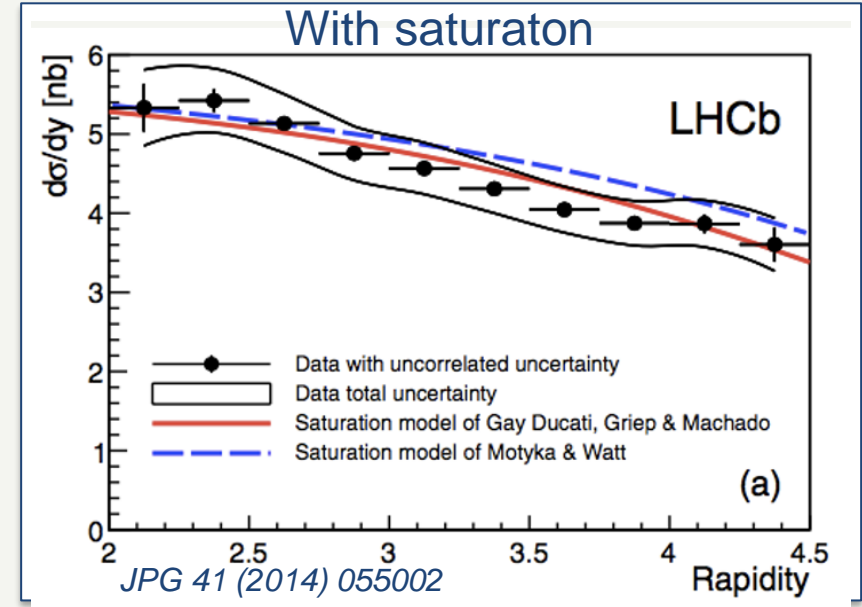
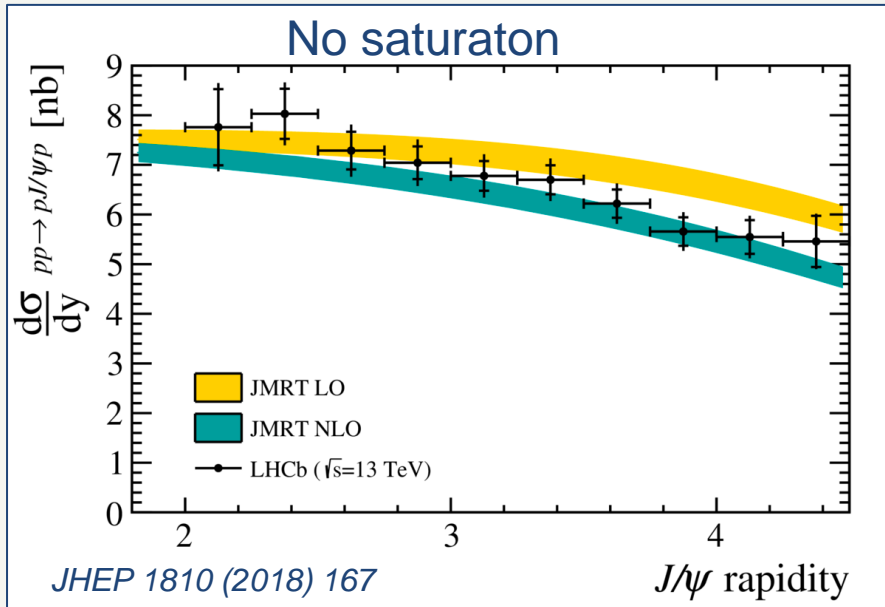
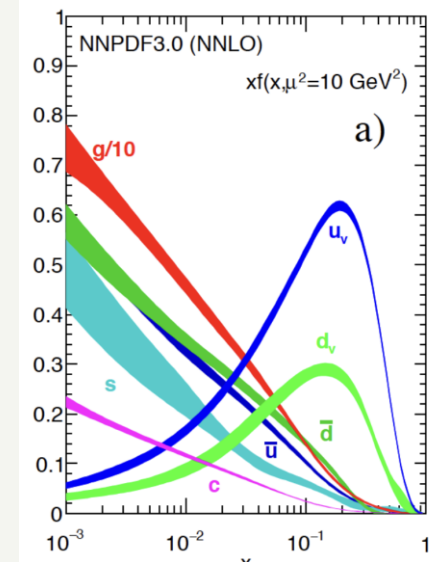

Saturation is not inconsistent with the data, but is also not required.

Looking for saturation in nuclear collisions

Coherent interaction: all nucleons behave as one.

- $b \sim 2R=13.2$ fm so $p_T \sim 15$ MeV
- nucleus remains intact*.

*additional EMD can excite or break nucleus

All things being equal, $\sigma_{\gamma A \rightarrow VA} = N_A \sigma_{\gamma p \rightarrow Vp}$

Saturation would decrease cross-section at high-W (low-x)

Nuclear suppression observed...

How much is due to saturation and how much to 'nuclear effects'?



$$\mathcal{A}_{pn}(b) = i(1 - e^{-\Omega(b)/2})$$

$$\Omega(b) = T_A(b)\sigma_{pn}\eta$$

Glauber eikonal approx.

Incoherent interaction with nucleon or parton

- p_T distribution follows $\exp(bt)$ b smaller than for coherent
- break-up is observed
- sensitive to smaller structures – saturation gives deviations from isotropy.

Coherent J/ψ in PbPb

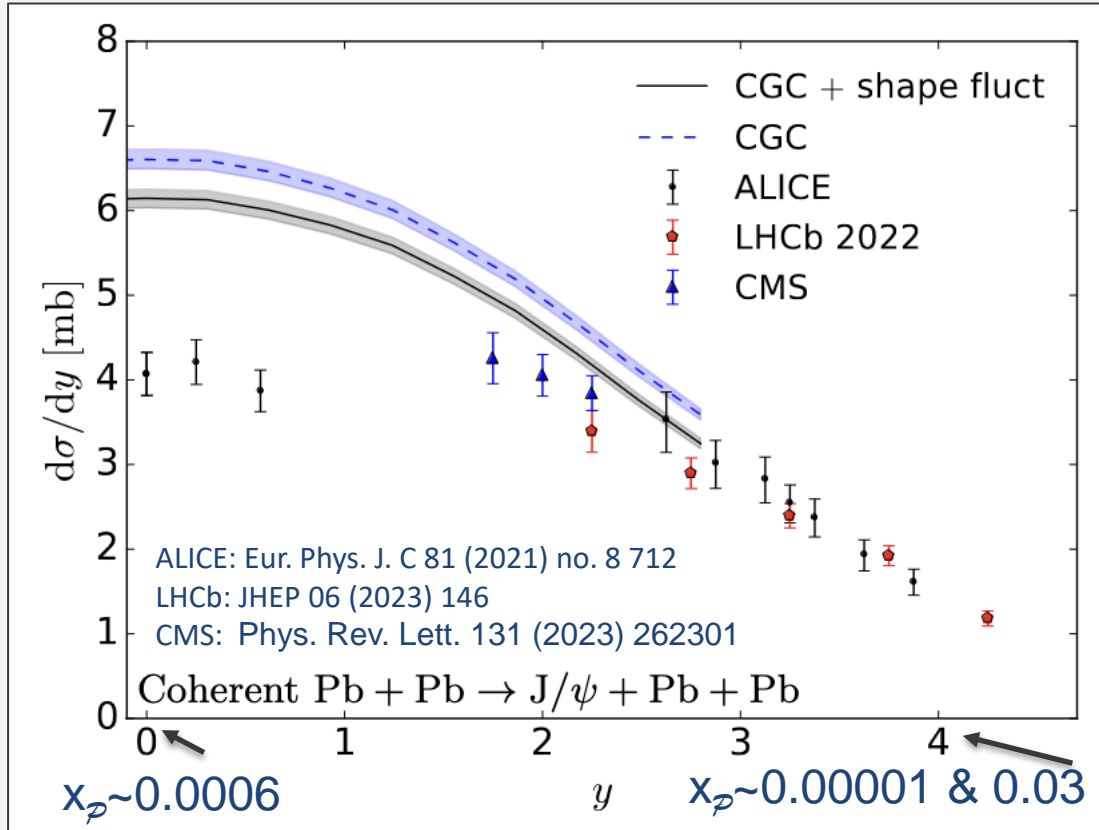

H. Mäntysaari, F. Salazar, B. Schenke:
Phys.Rev.D 109 (2024) 7, L071504

“We predict strong saturation-driven nuclear suppression at high energies, while LHC data prefers even stronger suppression.”

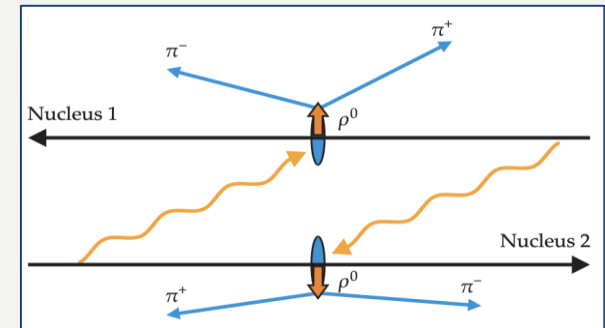

S. Klein, J. Nystrand, Physics Today 70, (2017) 40.

However, away from $y=0$, there is a two-fold ambiguity in the photon emitter and two-fold ambiguity in the value of W .

$$\frac{d\sigma_{PbPb \rightarrow Pb J/\psi Pb}}{dy} = \left(k \frac{dN_\gamma}{dk} \right)^+ \sigma_{\gamma Pb \rightarrow J/\psi Pb}(W^+) + \left(k \frac{dN_\gamma}{dk} \right)^- \sigma_{\gamma Pb \rightarrow J/\psi Pb}(W^-)$$

Electromagnetic 'pile-up' interactions

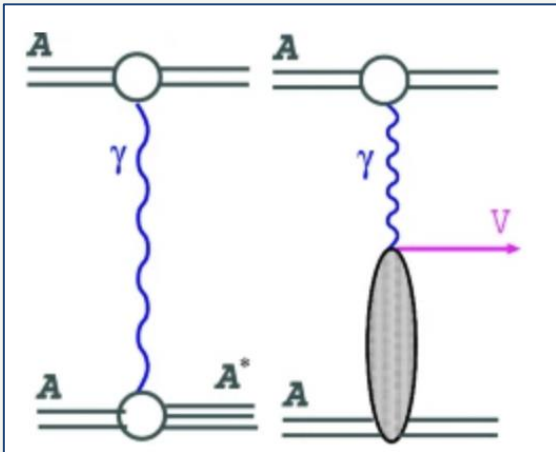

The electromagnetic field of the nucleus is so intense that long-range photon interactions often occur in addition to hadronic interactions.

Excites the nucleus.

Can lead to Electromagnetic Dissociation (EMD) of the nucleus.

This is more probable at low impact parameter, b , and photon flux depends on b

Emission of one or more neutrons

- Possibly proton emission too
- Nuclear break-up

Need far-forward detectors to see these.

ZDC calorimeters installed in CMS, ALICE, STAR

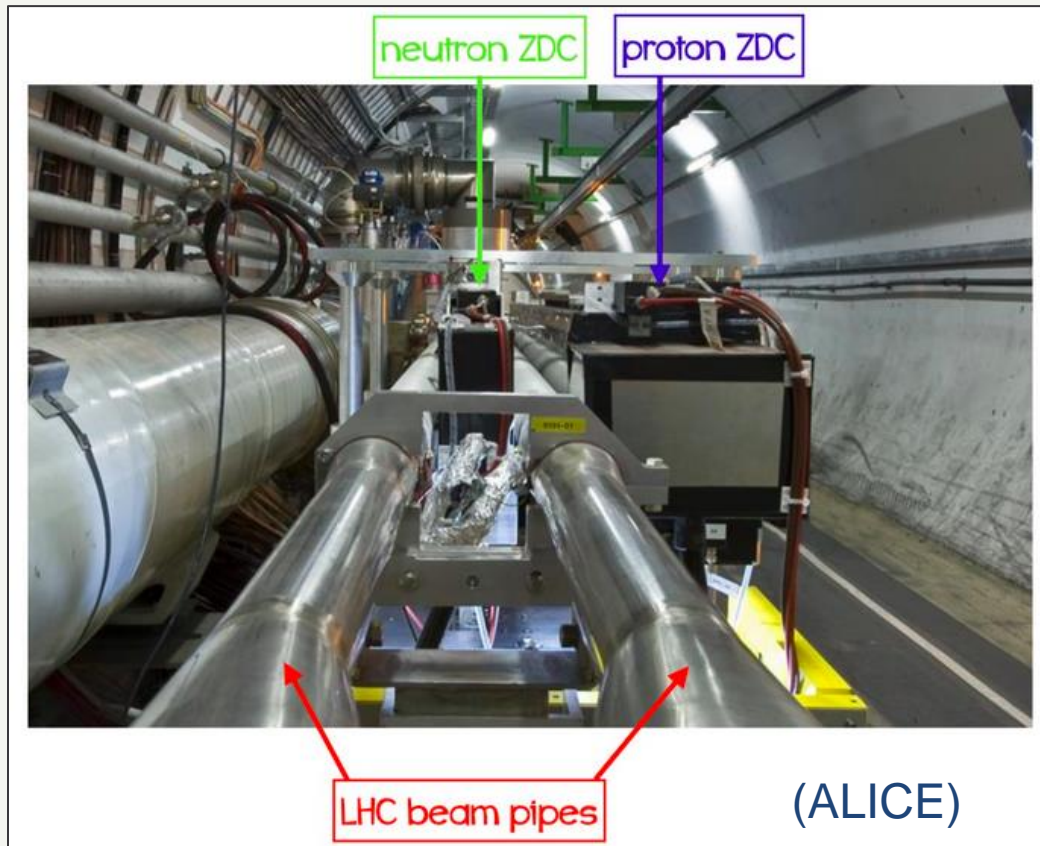

J. Phys.: Conf. Ser. 455 (2013) 012010

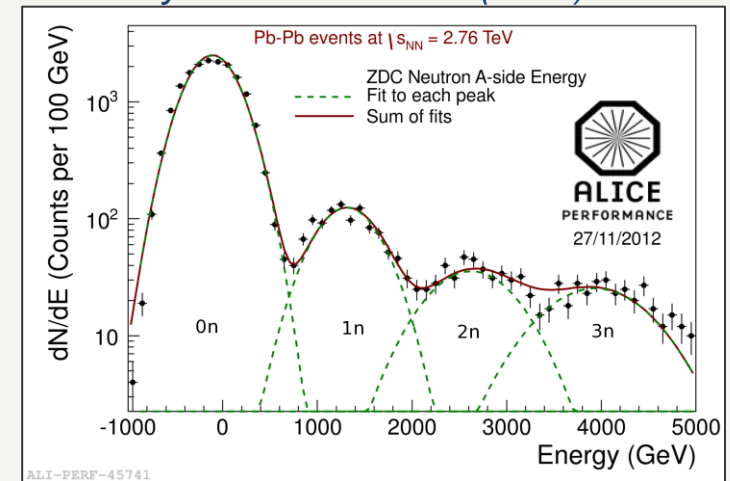

Detection of neutrons when ion breaks up allows identification of Electromagnetic Dissociation (EMD)

Resolving the two-fold ambiguity in PbPb

EMD is more likely at small impact parameters.
 So fluxes for 0n and (X>=1)n different.

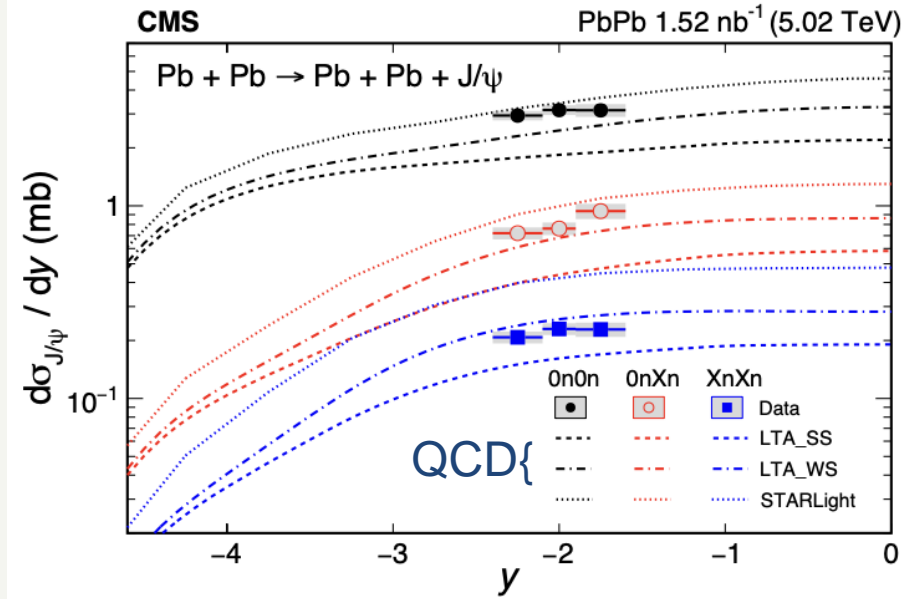

Phys. Rev. Lett. 131 (2023) 262301

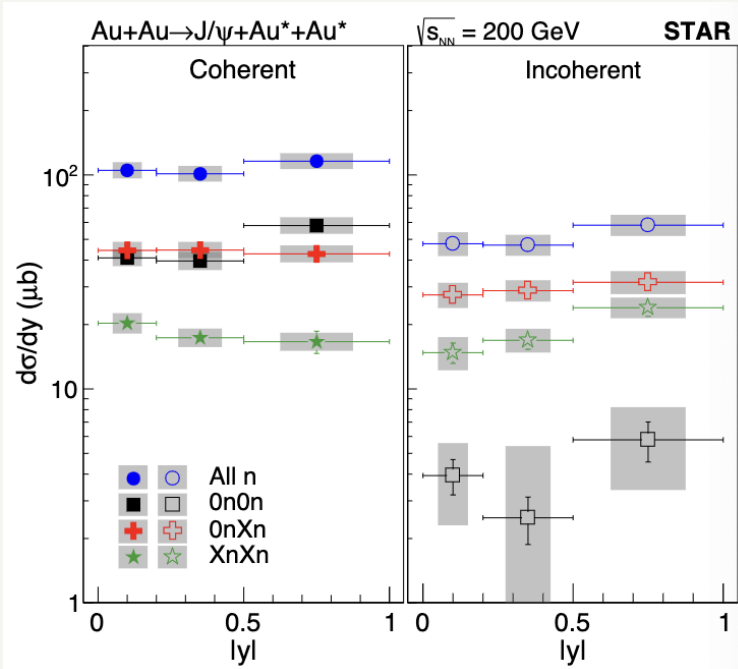

arXiv: 2311.13632

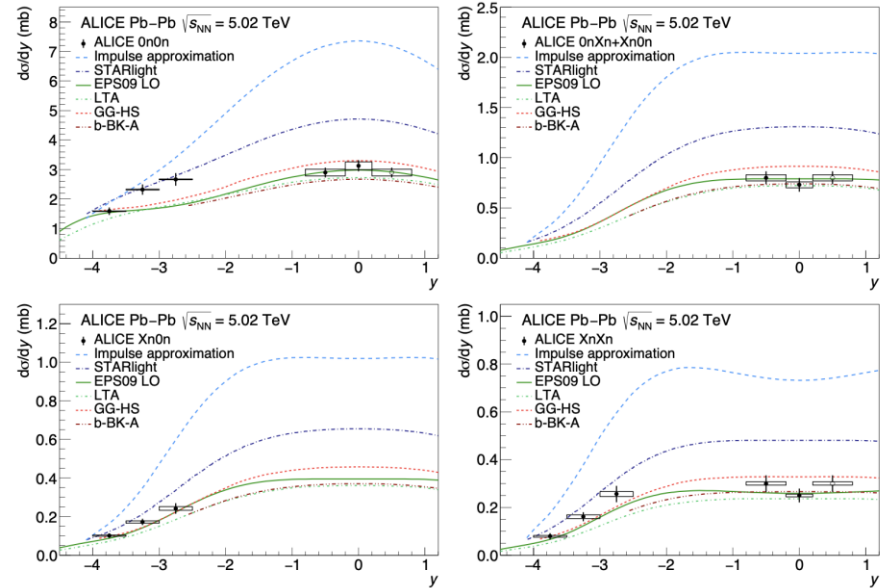

JHEP 10 (2023) 119

Re-expressed in terms of nuclear suppression factors

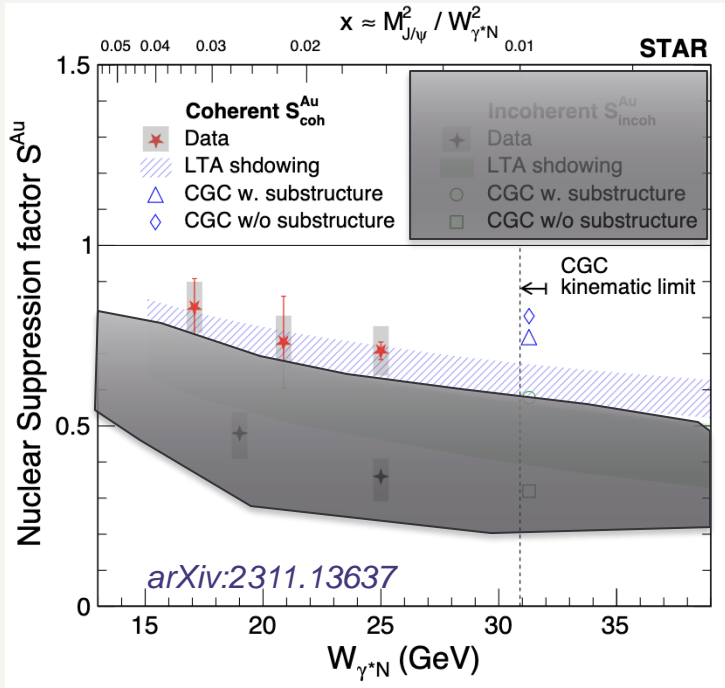

$$S_{coh} = \sqrt{\frac{\sigma_{\gamma A}}{\sigma_{IA}}}$$

IA is simple N_A scaling of $\sigma_{\gamma p}$

None of the models does a perfect job.
 QCD/Starlight not too bad.
 Models with saturation also reasonable

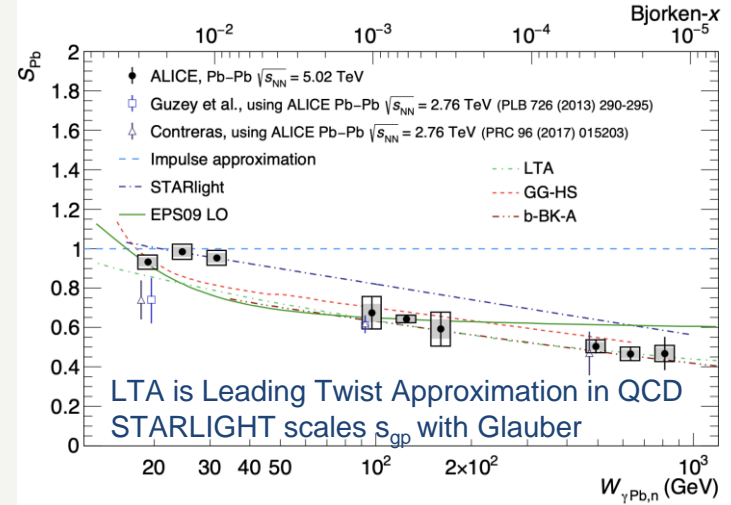
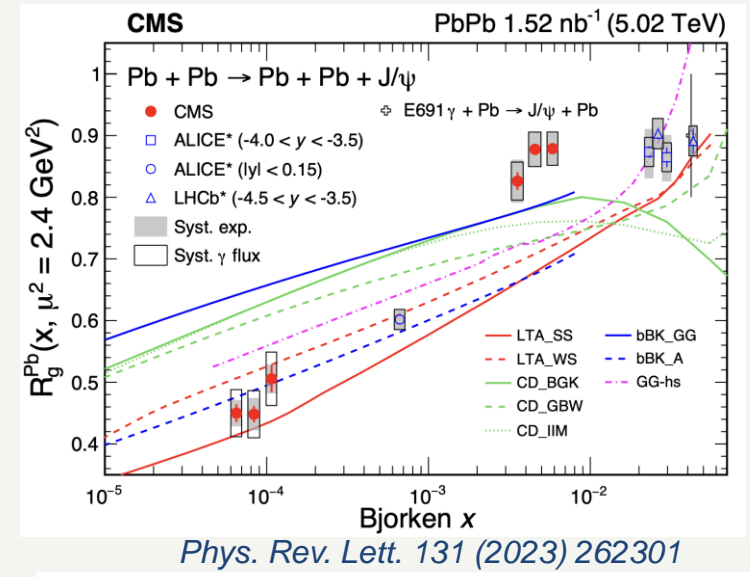

The case for saturation....

$$S_{\text{coh}} = \sqrt{\frac{\sigma^{\gamma A}}{\sigma^{\text{IA}}}}$$

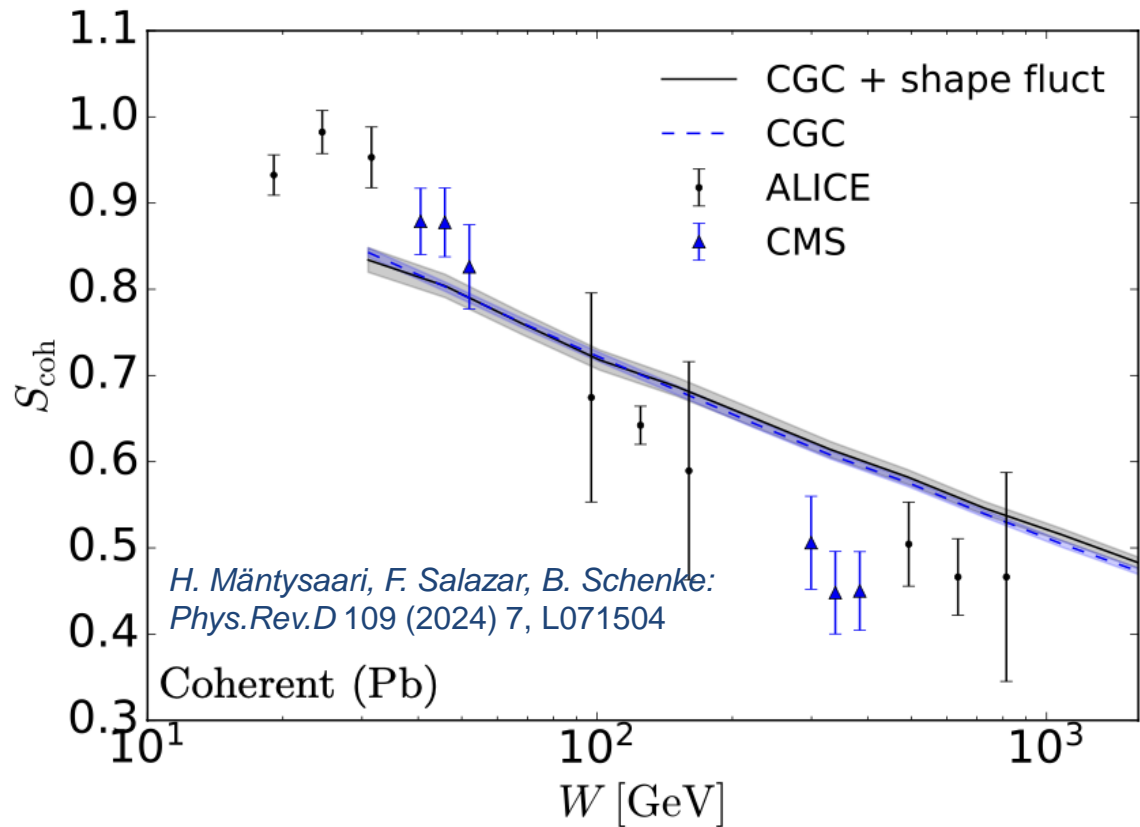

Comment: Would be nice to plot LTA too

Results may be similar, which begs the question about how to separate saturation from higher-order QCD effects.

Require precise photon fluxes for 0,1,2... neutron emissions

Calculated eg. in NooN generator *Comput.Phys.Commun.* 253 (2020) 107181

Mean number of
Coulomb excitations
emitting ≥ 1 neutron

$$P_{Xn}^1(b) = \int dk \frac{d^3 n(b, k)}{dk d^2 b} \sigma_{\gamma A \rightarrow A' + Xn}(k)$$

Photon flux at
energy k and
distance b

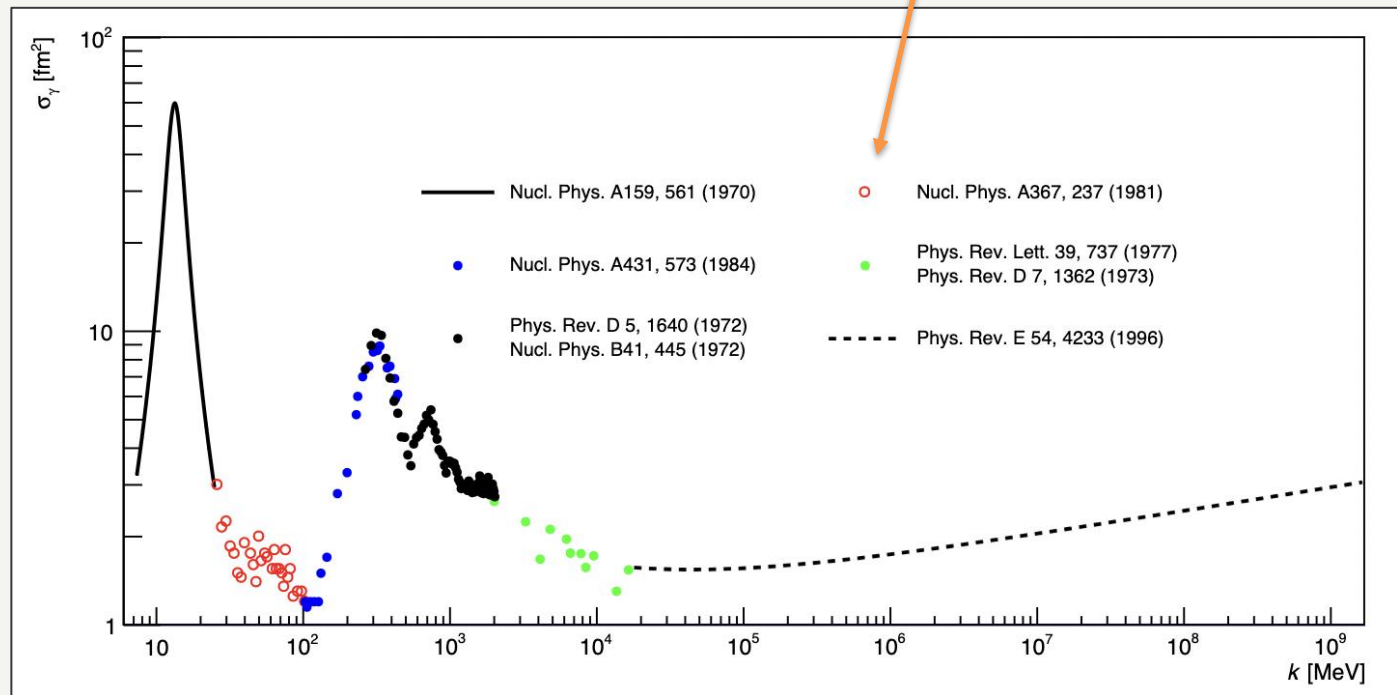

Emission of neutrons

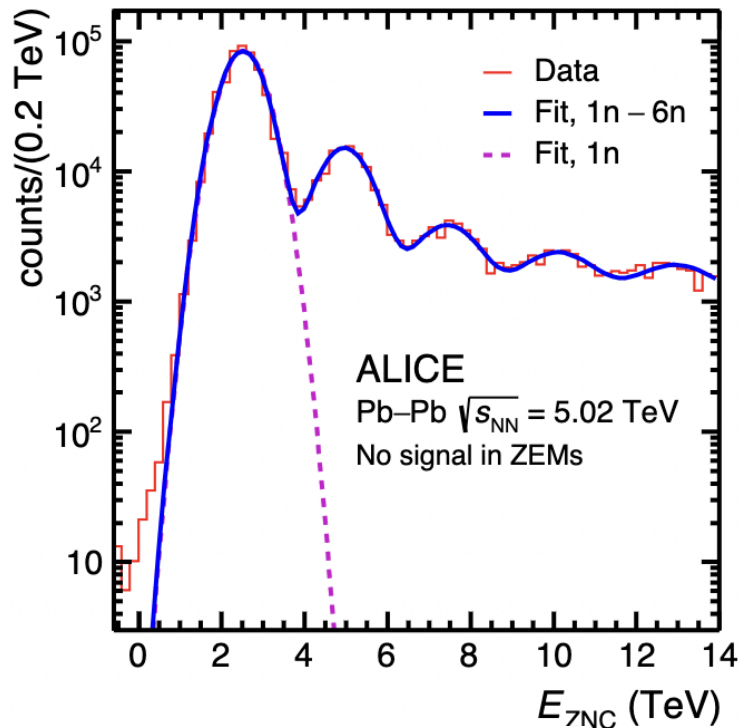

Phys.Rev.C 107 (2023) 6, 064902

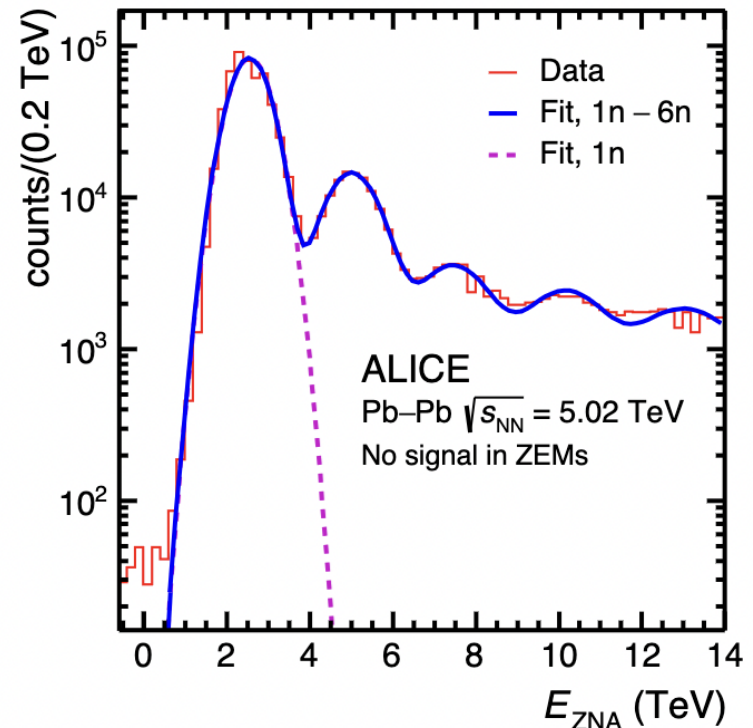

Analysis for rho photoproduction just considered 00, 0X, X0, XX emissions.

But you can count the number of neutrons on either side....

Cross-section for emission of just neutrons

Vetoing on the response in the proton ZDC....

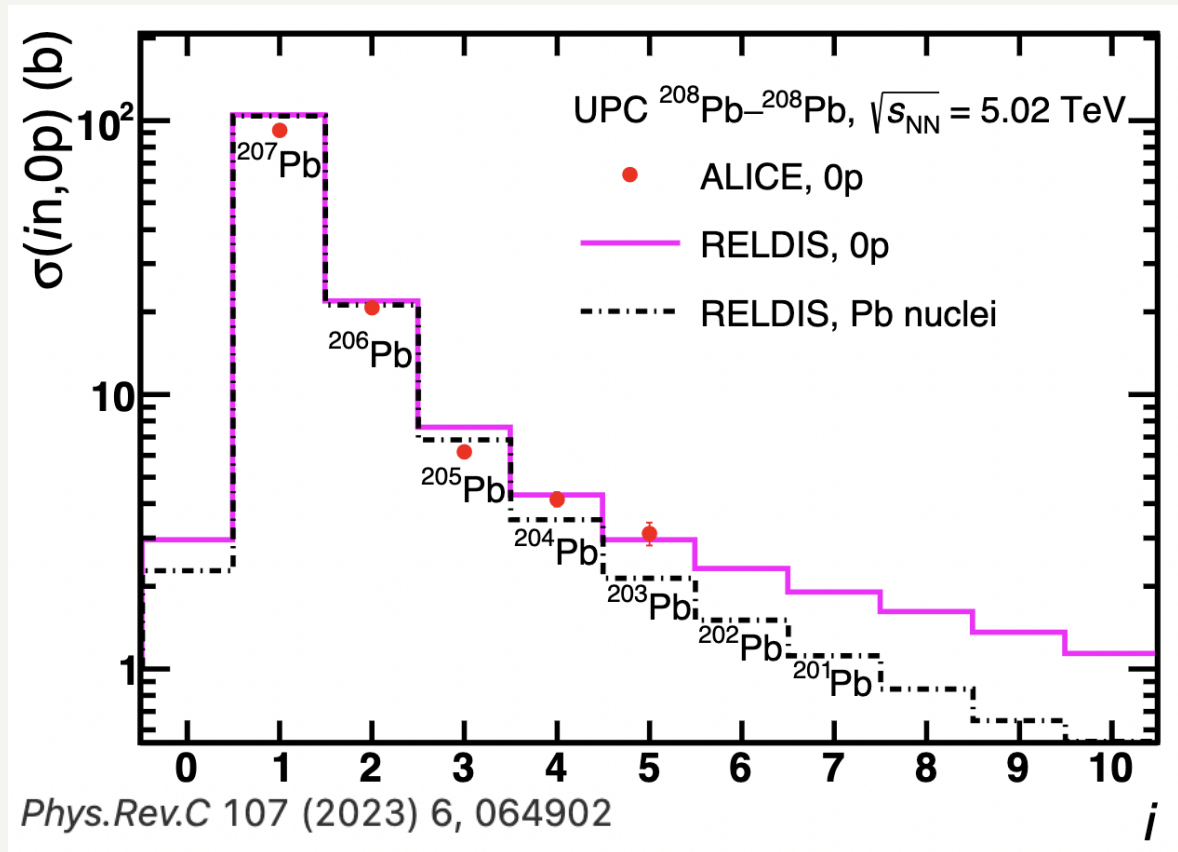

(Validation of the models used for the photoproduction analysis)

Emission of protons

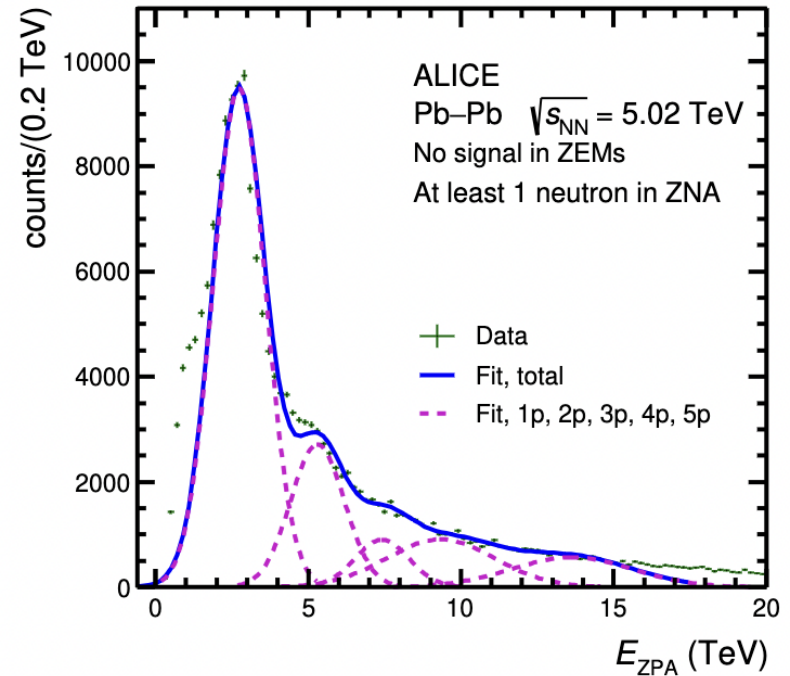
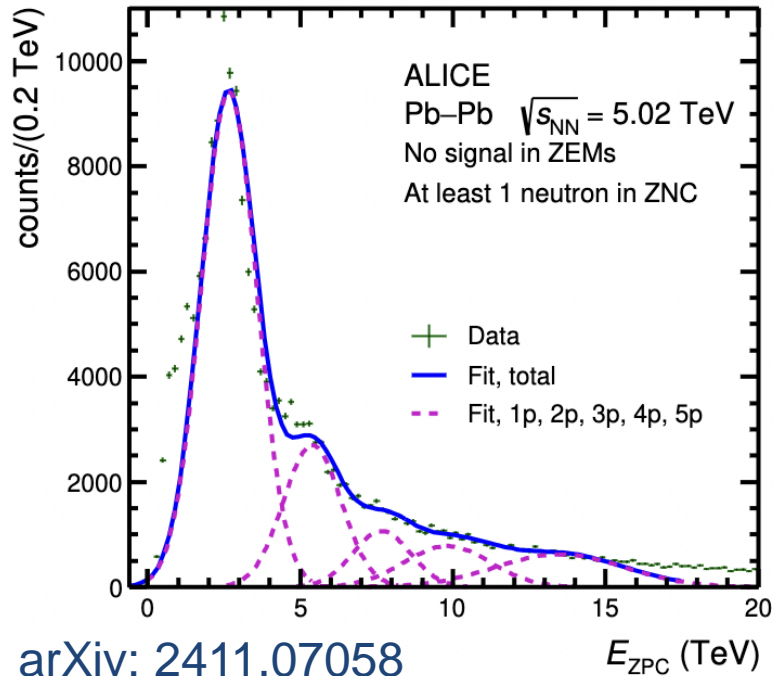

You can count the number of protons on either side....

Cross-section for emission of k protons and >0 neutrons

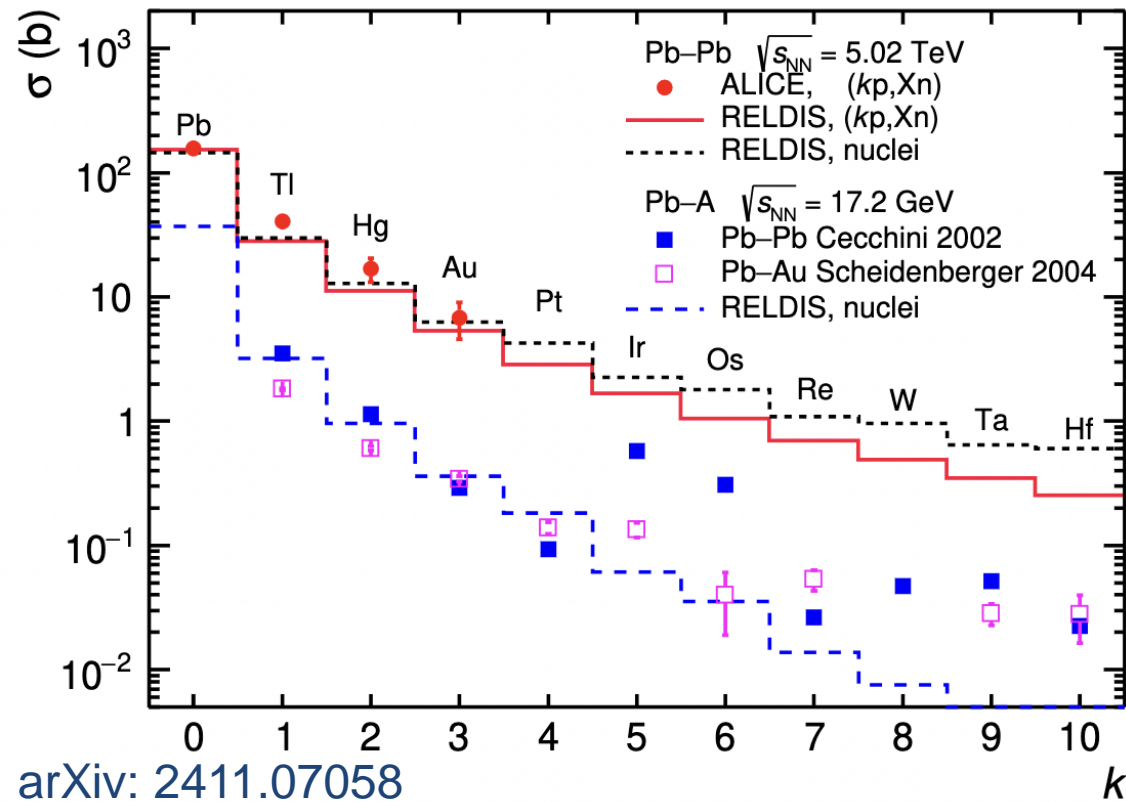

Cross-section for emission of k protons and >0 neutrons

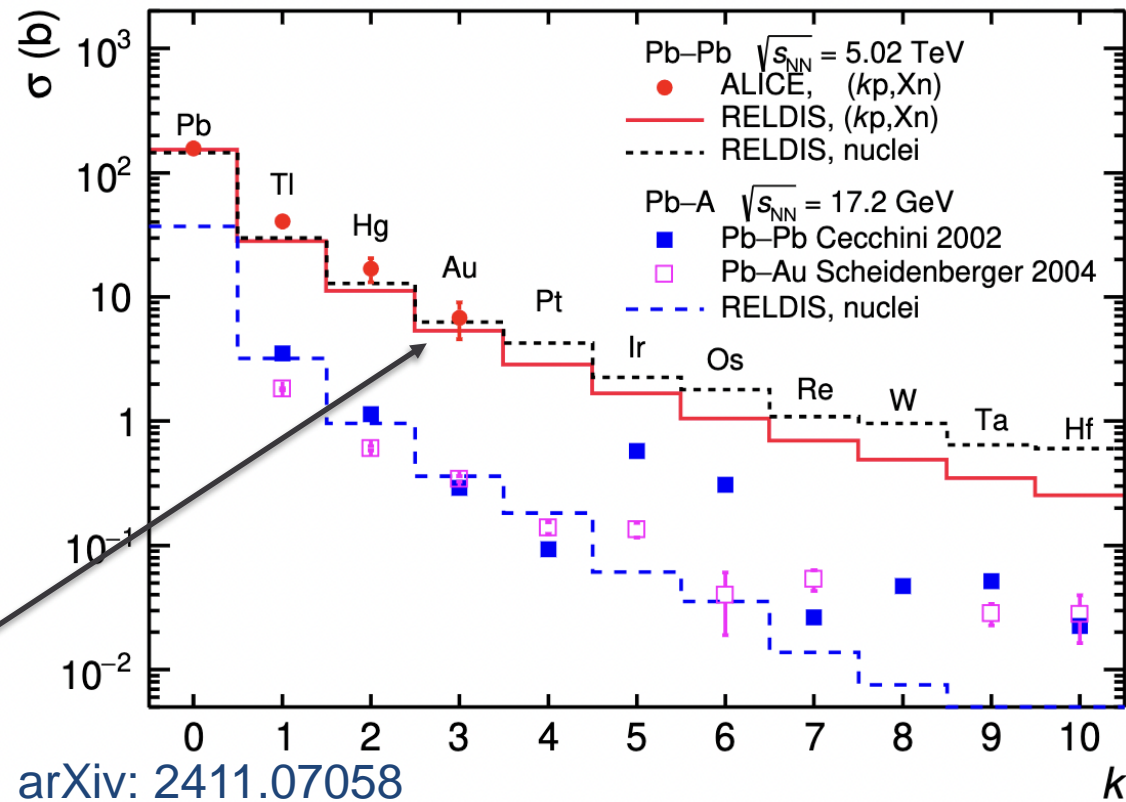

Thus turning lead into gold....



Conclusions

- Far forward detection at the LHC allows first measurements of EDM of Pb nuclei
- Can then be used as a tool to lift the two-fold ambiguity in symmetric collisions
- Relate photoproduction on the proton to photoproduction on the nucleus
-and search for saturation

backup

Incoherent scatters also interesting

Intact target: sensitive to **average** colour
 Breakup: sensitive to fluctuations (**rms**)

$$\frac{d\sigma^{\gamma^* p \rightarrow J/\Psi p}}{dt} = \frac{1}{16\pi} |\langle A(x_P, Q^2, \Delta) \rangle|^2$$

$$\frac{d\sigma^{\gamma^* N \rightarrow J/\Psi N^*}}{dt} = \frac{1}{16\pi} (\langle |A(x_P, Q^2, \Delta)|^2 \rangle - |\langle A(x_P, Q^2, \Delta) \rangle|^2)$$

Mäntysaari, Schenke, Phys. Rev. Lett. 117, 052301 (2016)

- Original model based on gluonic fluctuations around three hot-spots (valence quarks)
- Hot-spot evolution model (
- Energy-dependent hot-spots (J. Cepila, J. G. Contreras, J. D. Tapia Takaki Phys. Lett. B766 (2017) 186–191)
- The onset of saturation? (J. Cepilaa, J. G. Contrerasa, M. Matasa, A. Ridzikova, arXiv:2313.11320)

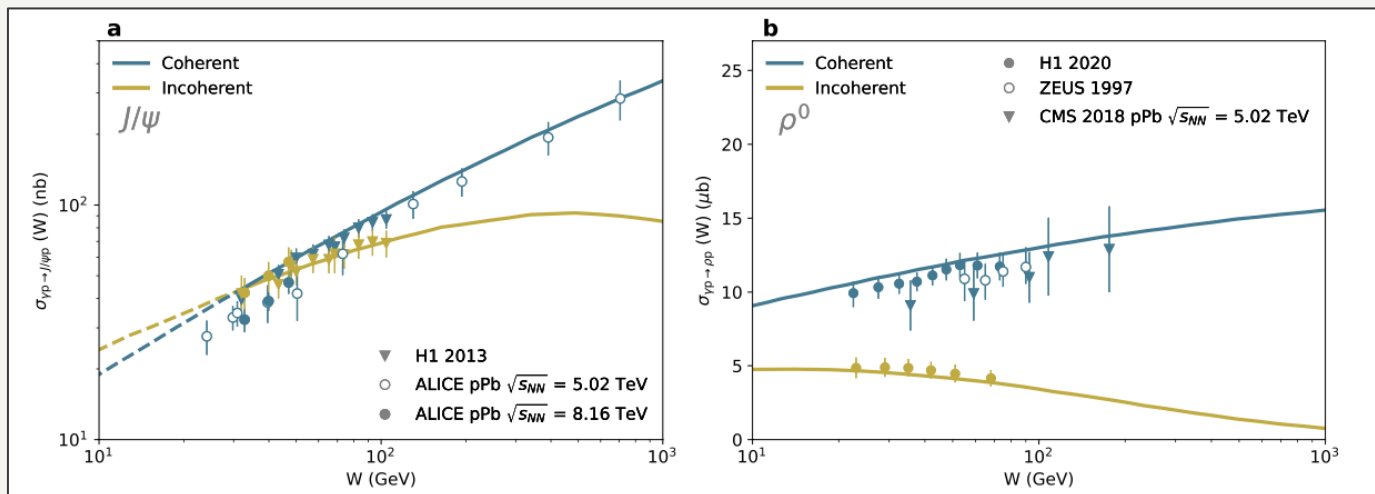

CMS-TOTEM: Simultaneous reconstruction of central system and protons

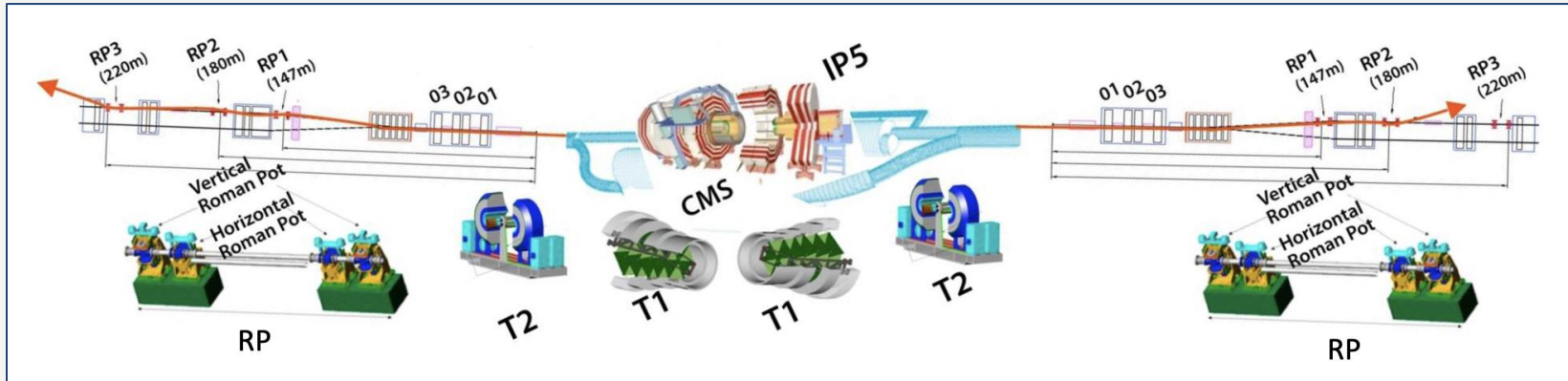

[arXiv:2401.14494](https://arxiv.org/abs/2401.14494)

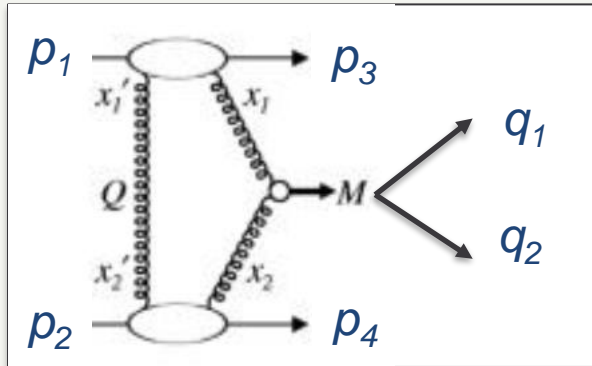

$$M^2 = (q_1^\mu + q_2^\mu)^2 = (p_1^\mu + p_2^\mu - p_3^\mu - p_4^\mu)^2$$

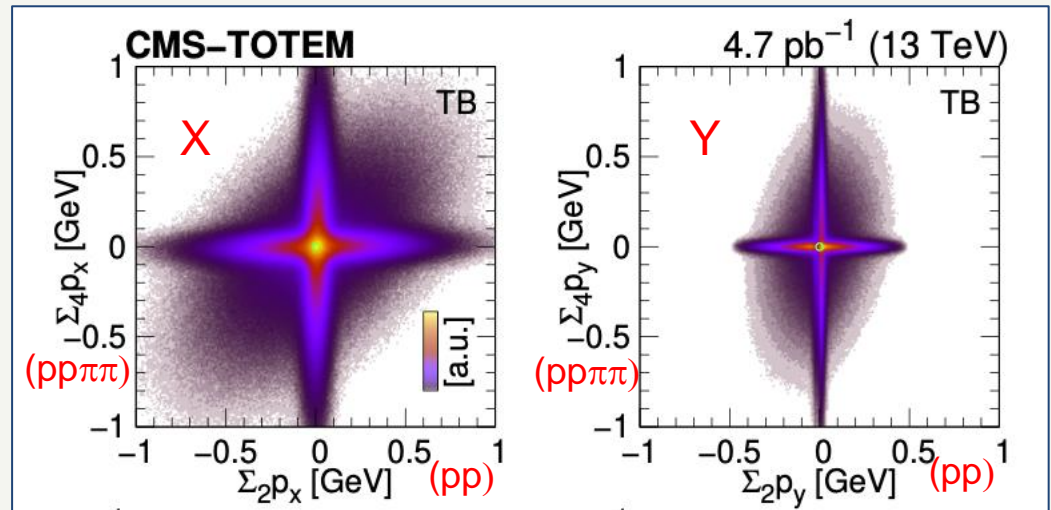

Precision determination of pomeron interactions

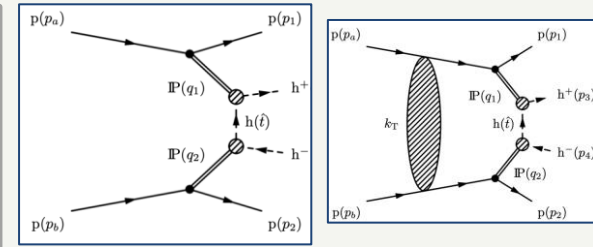

Phys.Rev.D 109 (2024) 11, 112013

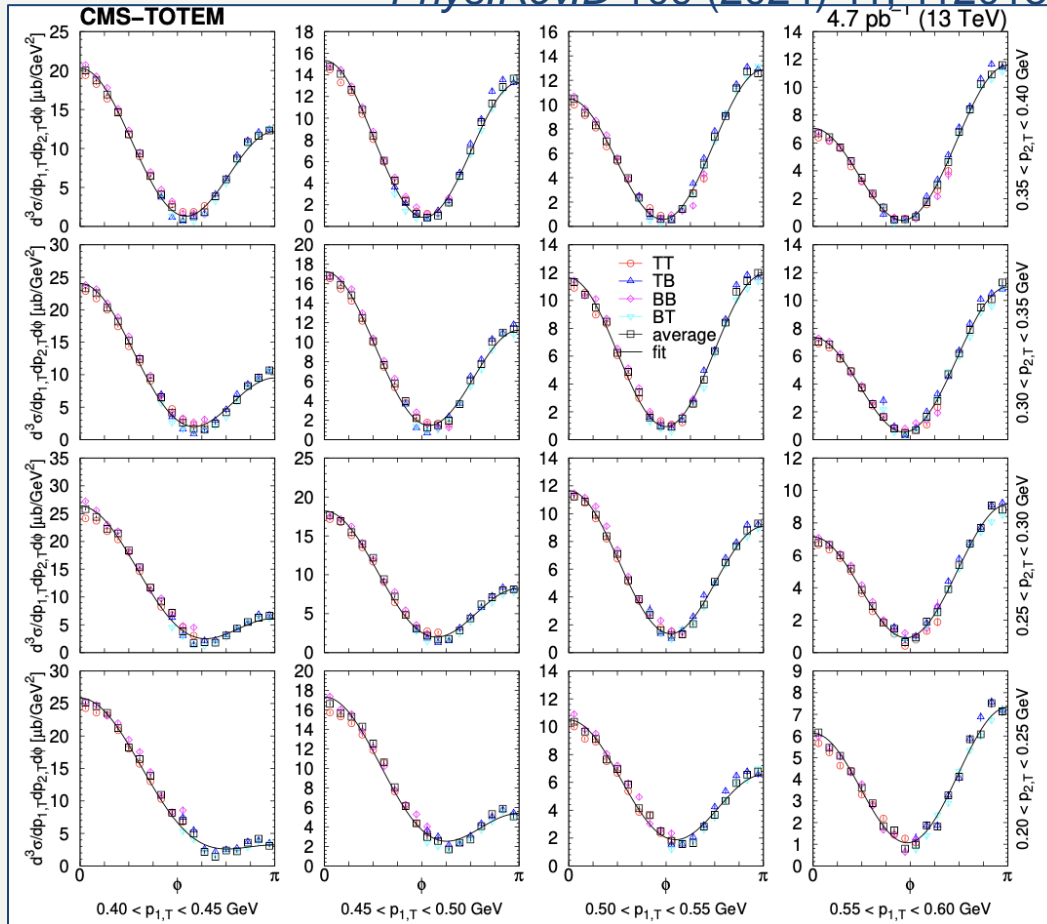

Shape distinctive of interference due to additional pomeron interactions

Measurements performed in non-resonant regions: ($<0.7, >1.8$ GeV).

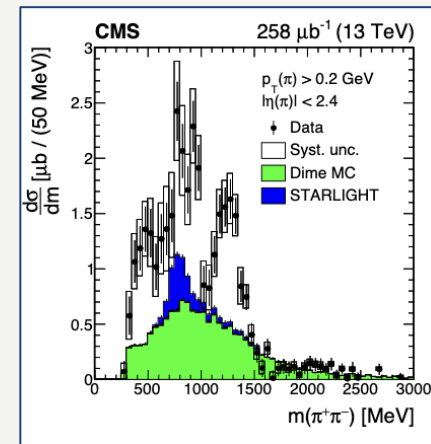

Eur. Phys. J. C 80 (2020) 718

Eagerly await compelling spectroscopy of the complicated resonance region:

- photoproduced $\rho, \omega, \rho', \rho''$
- DPE f_0, f_2, \dots , glueball candidates