

# Double parton scattering: theory review

Jonathan Gaunt



Workshop on Double Parton Scattering and the 3D  
structure of hadrons, Aussois, 12/01/25

# OUTLINE

- Double parton scattering: cross section formula and double parton distributions (DPDs).
- Why double scattering is important and interesting, with reference to specific processes and experimental measurements.
- Crudest phenomenological approach to DPS: 'the pocket formula'.
- Proper perturbative QCD framework for DPS, including perturbative correlations. Parton shower implementation of this approach. Effects on DPS cross sections from perturbative and other correlations.

# DOUBLE PARTON SCATTERING: BASICS

DPS = two separate hard parton-parton collisions in one proton-proton collision:

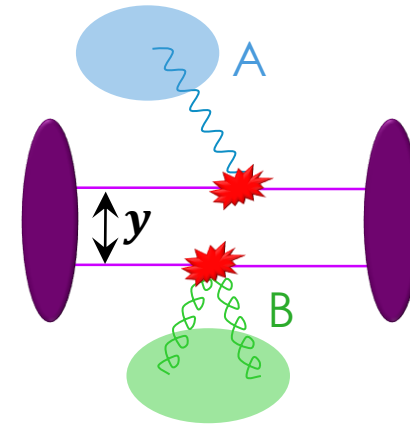

(Schematic) DPS factorisation formula:

$$\sigma_{DPS}^{(A,B)} = \int F_{ik}(x_1, x_2, \mathbf{y}) \otimes \hat{\sigma}_{ij}^A \hat{\sigma}_{kl}^B \otimes F_{jl}(x'_1, x'_2, \mathbf{y}) d^2\mathbf{y}$$

↑ Double parton density (DPD)

Formula obtained long ago in parton model (Paver, Treleani, Nuovo Cim. A70 (1982) 215. Mekhfi, Phys. Rev. D32 (1985) 2371).

Factorisation now proven for double colour-singlet production in QCD (Diehl, JG, Ostermeier, Plöb, Schafer, JHEP 1601 (2016) 076, Diehl, Ostermeier, Schafer, JHEP 1203 (2012) 089, Diehl, Nagar, JHEP 1904 (2019) 124, Vladimirov, JHEP 1804 (2018) 045)

# DOUBLE PARTON SCATTERING: BASICS

DPS = two separate hard parton-parton collisions in one proton-proton collision:

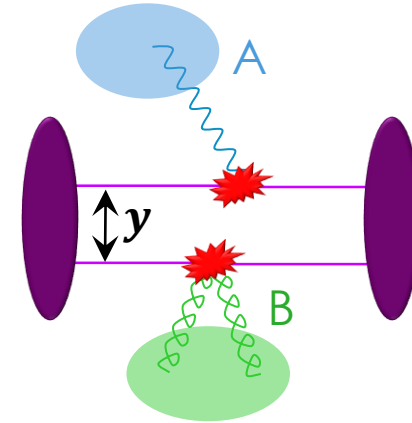

(Schematic) DPS factorisation formula:

$$\sigma_{DPS}^{(A,B)} = \int F_{ik}(x_1, x_2, \mathbf{y}) \otimes \hat{\sigma}_{ij}^A \hat{\sigma}_{kl}^B \otimes F_{jl}(x'_1, x'_2, \mathbf{y}) d^2\mathbf{y}$$

↑
↑
↑
 Double parton density (DPD)

Simple power counting analysis:  $\sigma_{DPS} \sim \sigma_{SPS} \frac{\Lambda_{QCD}^2}{Q^2}$

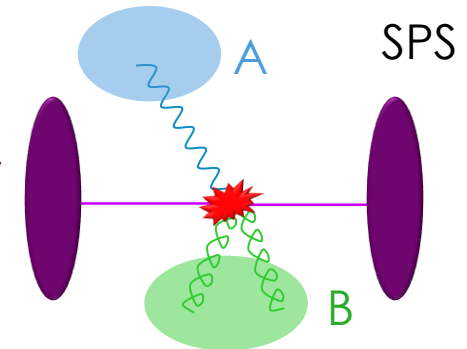

# MOTIVATIONS TO STUDY DPS

(1) DPS can be a significant background to processes suppressed by small/multiple coupling constants.

'Classic' SM example: same-sign WW production.

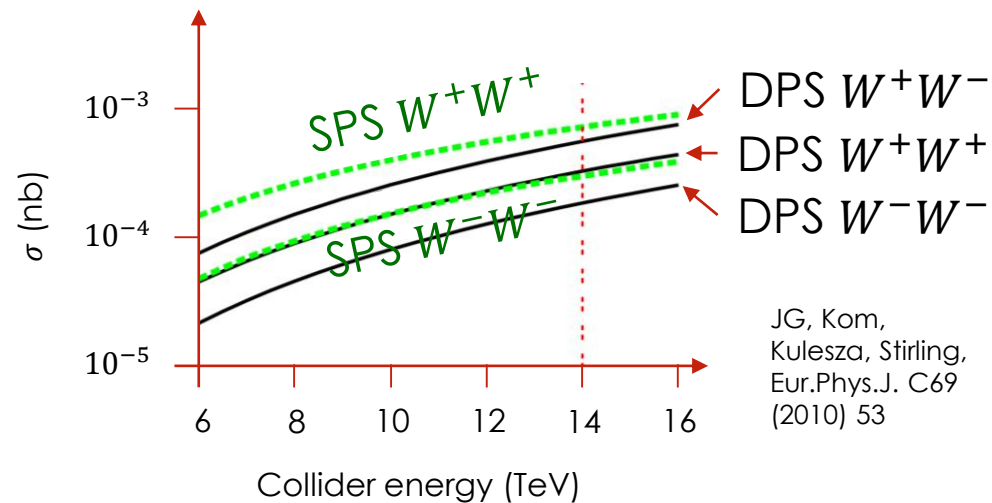
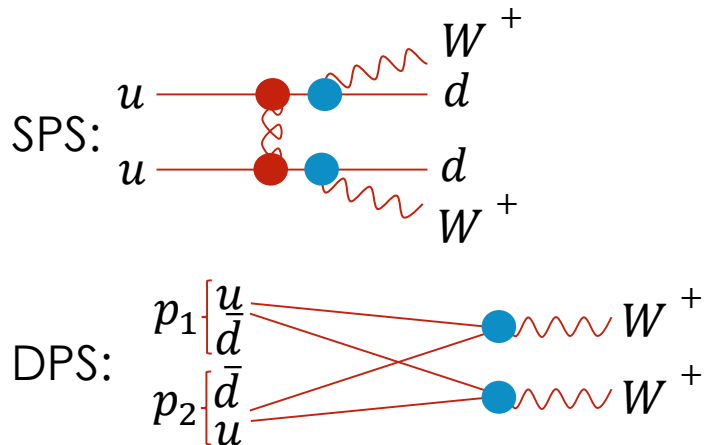

N.B. same-sign dilepton production an important channel for various new physics searches (doubly charged Higgs, SUSY,...)

# MOTIVATIONS TO STUDY DPS

(2) DPS grows faster than SPS as collider energy grows.

For a process with given scale, an increase in collider energy means a decrease in  $x$



Low  $x$       High  $x$   
 DPS probability increases

Growth particularly strong for low-scale processes

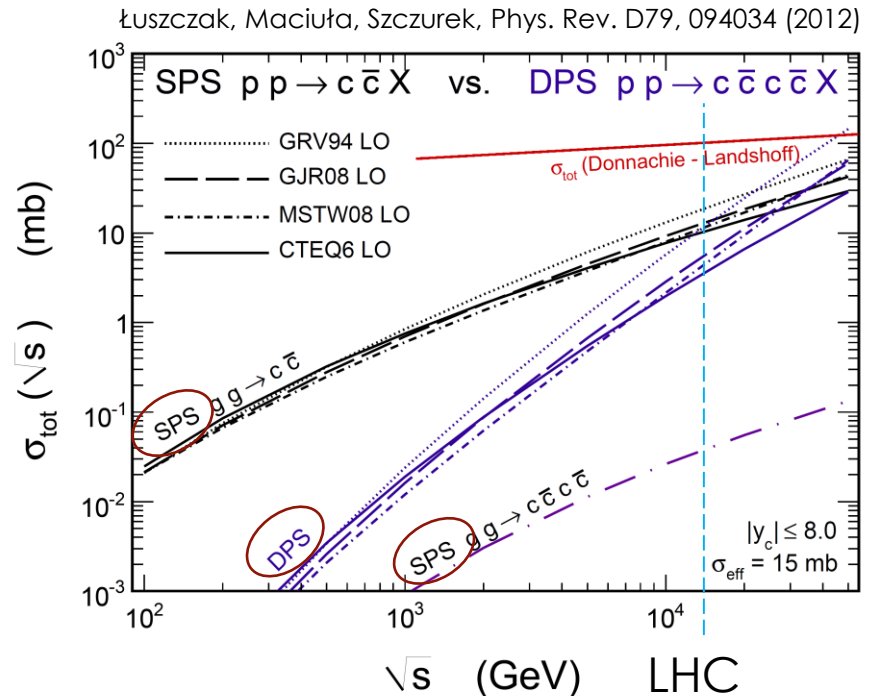

DPS particularly important for processes involving charm and bottom quarks. '10% of all "hard" events have an additional charm pair' v.

Belyaev, MPI@LHC 2017

# MOTIVATIONS TO STUDY DPS

(3) DPS populates phase space in a different way to SPS. Can compete with SPS in certain regions. Example : large rapidity separation of A&B

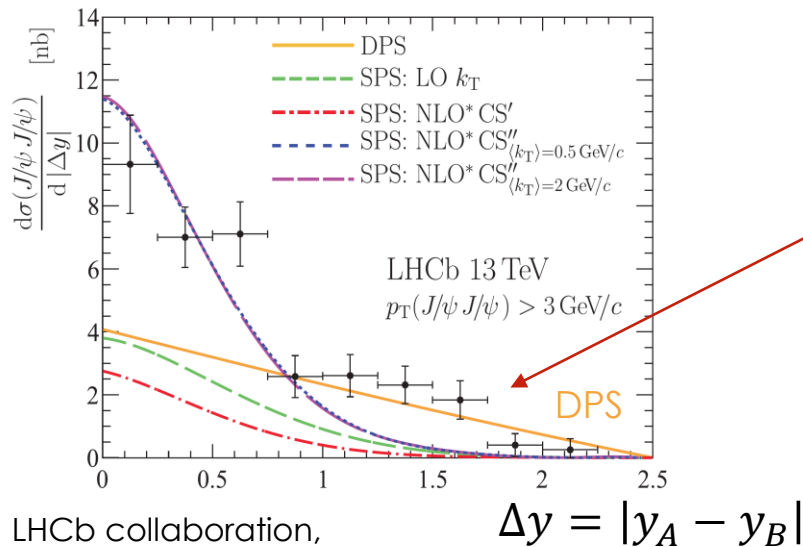

LHCb collaboration,  
JHEP 06 (2017) 047

LHCb study of  $J/\psi$  pair production .

Need DPS contribution at large  $\Delta y$  to explain data!

Updated results from LHCb for  
2023

LHCb collaboration, JHEP 2403 (2024) 088  
See talk by Jibo

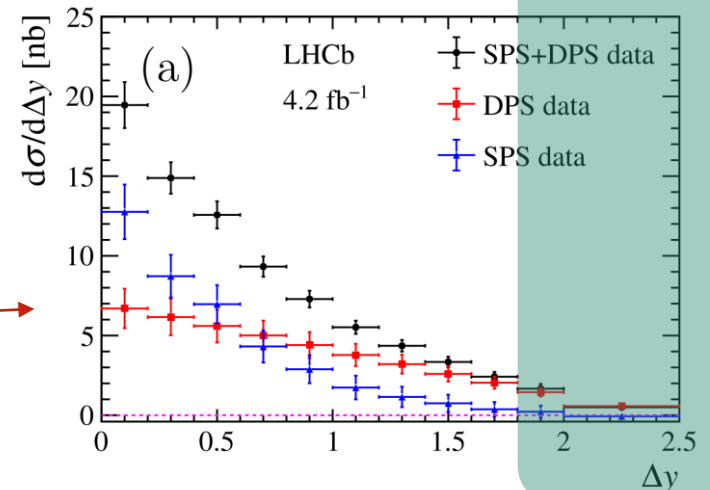

Another example: small  $p_{T,A}$  and/or  $p_{T,B}$  - see talk by Luca

# MOTIVATIONS TO STUDY DPS

(4) DPS gives us new information on hadron structure.

From current measurements, one-particle picture of proton:

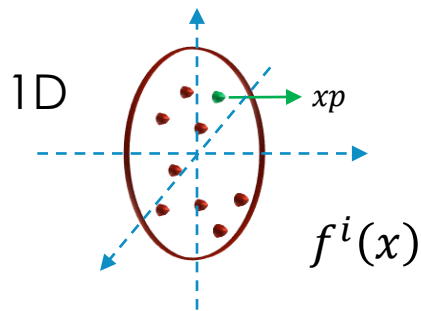

Parton densities (PDFs)

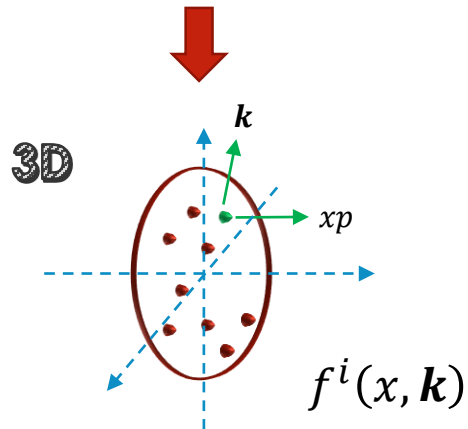

Transverse momentum densities (TMDs)

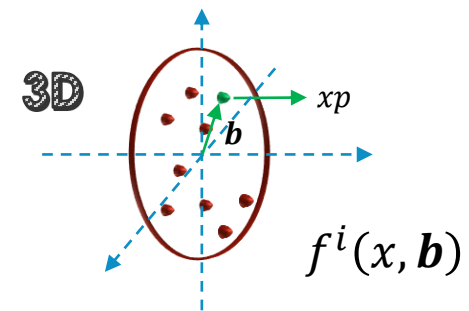

Generalised parton densities (GPDs)

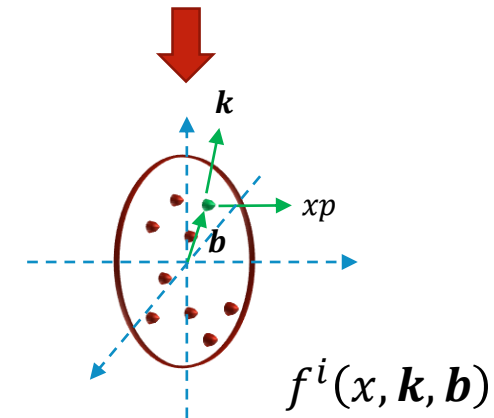

Generalised transverse momentum dependent densities (GTMDs)



# MOTIVATIONS TO STUDY DPS

Double parton scattering gives us information, for the first time, on correlation **between** partons!

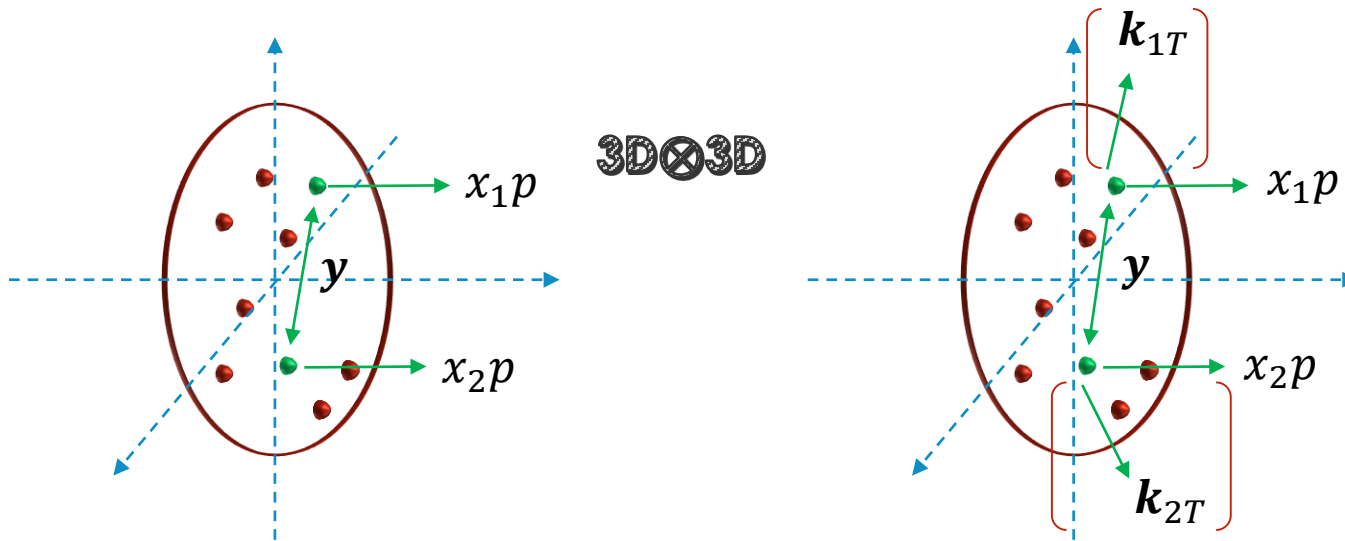

Double parton distributions  
(DPDs)

Double parton transverse  
momentum distributions  
(DTMDs)

# MEASURING CORRELATIONS

One observable to measure in detail the correlations:  $\mathcal{A}$  in  $W^\pm W^\pm \rightarrow l^\pm l^\pm \nu \nu$

$$\mathcal{A} = \frac{\text{Diagram 1} - \text{Diagram 2}}{\text{Diagram 3} + \text{Diagram 4}}$$

If no correlations:  $P \left[ \text{Diagram 1} \right] - P \left[ \text{Diagram 2} \right] = P \left[ \text{Diagram 3} \right] \left\{ P \left[ \text{Diagram 4} \right] - P \left[ \text{Diagram 5} \right] \right\} = 0$

$\mathcal{A} \neq 0$  implies correlations!  $\mathcal{A}$  values of  $\approx 0.1$  are measurable at hi-lumi LHC

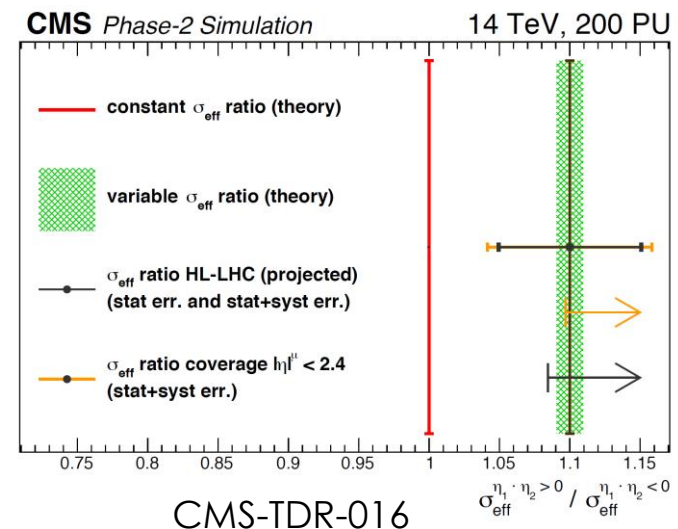

# DPS 'POCKET FORMULA'

DPD  $F_{ik}(x_1, x_2, \mathbf{y})$  is a complex object!

Historically several approximations, for rough estimates of DPS.

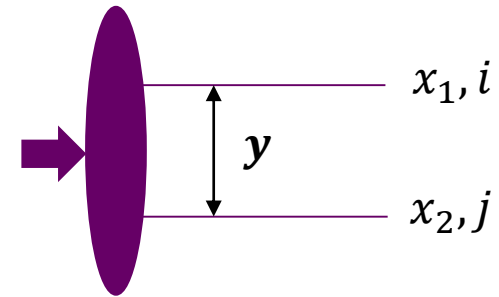

(1) Ignore correlations between partons

$$F^{ij}(x_1, x_2, \mathbf{y}) \rightarrow \int d^2\mathbf{b} f^i(x_1, \mathbf{b}) f^j(x_2, \mathbf{b} + \mathbf{y})$$

GPD @ zero skewness  
See Saad's talk

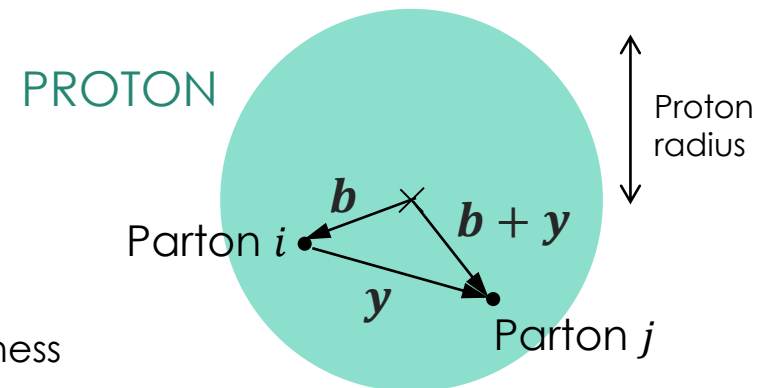

# DPS 'POCKET FORMULA'

(2) Assume GPD can be written as  $f^i(x_1, \mathbf{b}) = f^i(x_1)G(\mathbf{b})$

Then  $F^{ij}(x_1, x_2, \mathbf{y}) = f^i(x_1) f^j(x_2) \int d^2\mathbf{b} G(\mathbf{b}) G(\mathbf{b} + \mathbf{y})$

Inserting into  $\sigma_{DPS}^{(A,B)} = \int F_{ik}(x_1, x_2, \mathbf{y}) \otimes \hat{\sigma}_{ij}^A \hat{\sigma}_{kl}^B \otimes F_{jl}(x'_1, x'_2, \mathbf{y}) d^2\mathbf{y} \dots$



$$\sigma_D^{(A,B)} = \frac{\sigma_S^{(A)} \sigma_S^{(B)}}{\sigma_{\text{eff}}}$$
 "DPS pocket formula"

Most pheno estimates of DPS use this!

Extension of this approach to multiple scattering yields "eikonal model" of multiple scatters – basis for MPI models in MC generators  
See Seonagh's talk

# THE SIZE OF $\sigma_{eff}$

If pocket formula picture is the full story, the ratio  $\sigma_S^{(A)} \sigma_S^{(B)} / \sigma_D^{(A,B)}$  extracted from various DPS measurements should be universal and roughly the proton transverse area  $\sim 60$  mb.

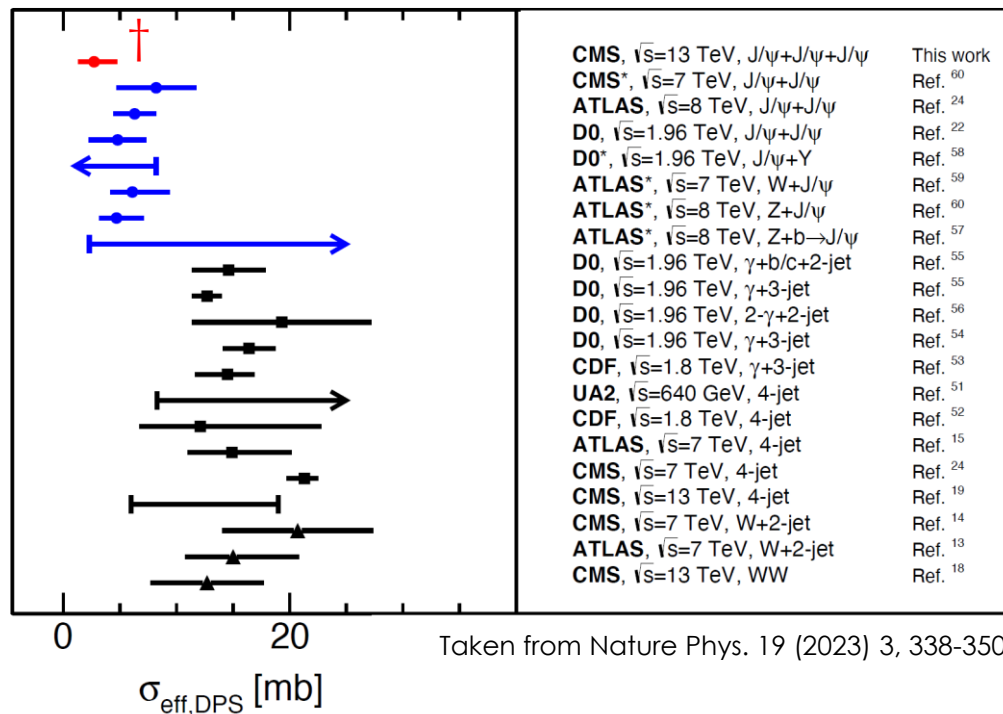

See talk by Stefanos, and all talks tomorrow!

$$\sigma_{eff,DPS} \ll 60\text{mb!}$$

$\sigma_{eff}$  with quarkonium  
 $< \sigma_{eff}$  with high- $p_T$  jets/EW bosons

†: Measurement in triple  $J/\psi$ . Process receives contributions from triple parton scattering (TPS)!

# QCD EVOLUTION EFFECTS IN DPS

How do we treat DPS properly in pQCD?

Going 'backwards' from the hard process, what can happen to the two partons?

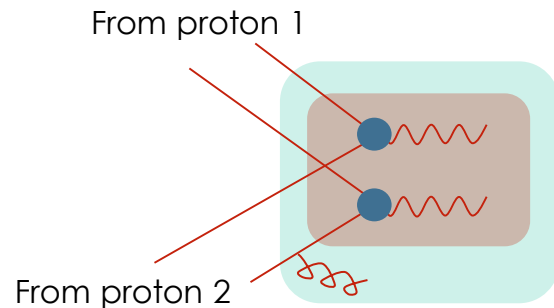

Emission from single leg. Familiar from single scattering.

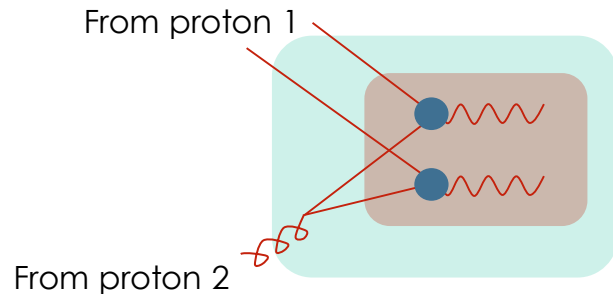

'1 $\rightarrow$ 2 splitting'. New effect!

# SPS-DPS DOUBLE COUNTING

Problem: if we have a splitting in both protons, process can be thought of either as a contribution to DPS or as a loop correction to SPS:

DPS picture:



SPS picture:

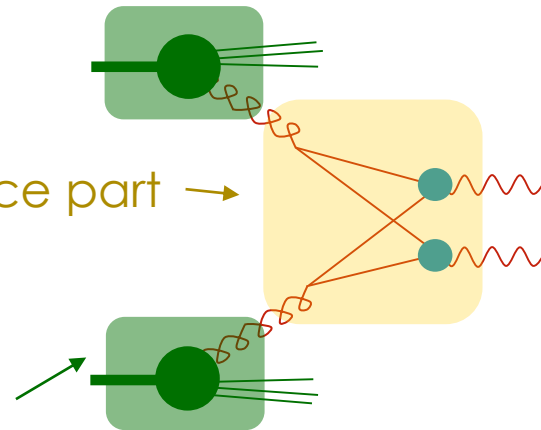

Double counting issue if splitting is included in a naïve way.

# SPS-DPS DOUBLE COUNTING

DPS description

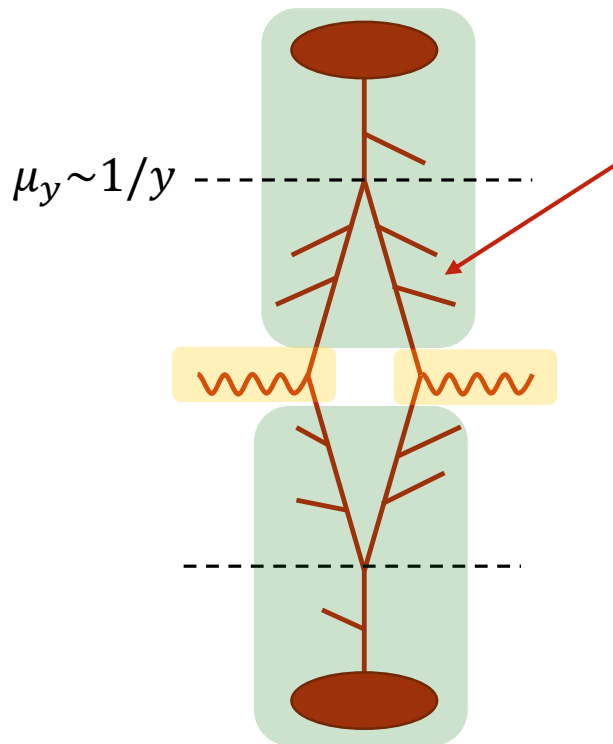

Treatment of loop in collinear approximation. Summation of arbitrary emissions inside loop.

SPS description

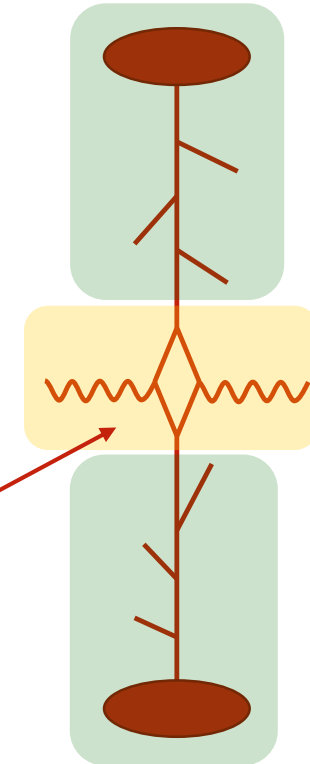

Full treatment of loop at fixed order

Most appropriate at large  $y$

Most appropriate at small  $y$

Want smooth transition from one description to the other as  $y$  varies





# DPS + SPS WITHOUT DOUBLE COUNTING

Achieve by taking away a subtraction term from the sum of SPS + DPS:

Diehl, JG, Schönwald JHEP 1706 (2017) 083

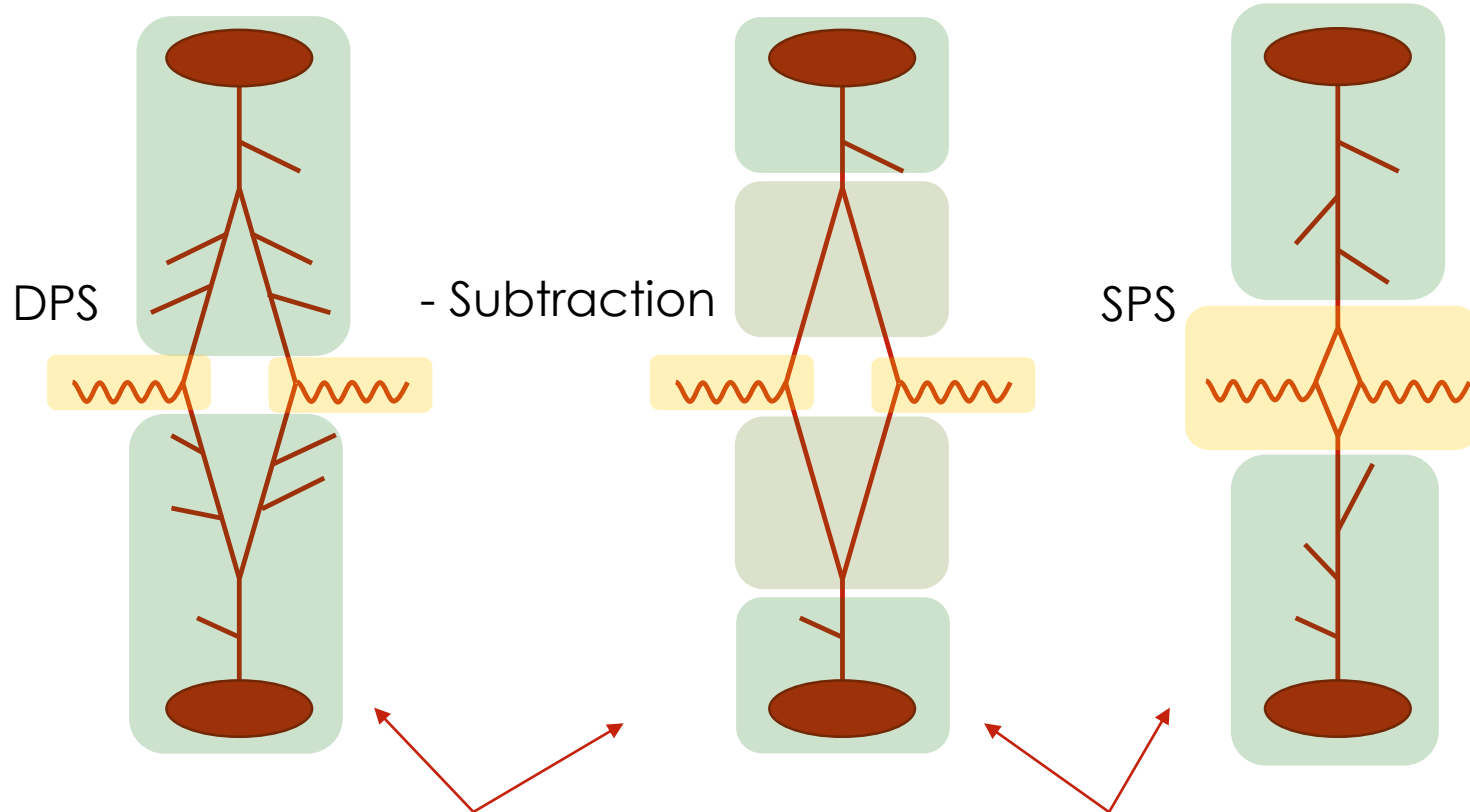

At small  $y \sim 1/Q$ , not much evolution space for DPS to emit inside loop. DPS  $\sim$  subtraction and we are left with SPS.

At large  $y$ , collinear approximation to loop works well. Subtraction  $\sim$  SPS and we are left with DPS.

# WHICH REGION IS DOMINANT?

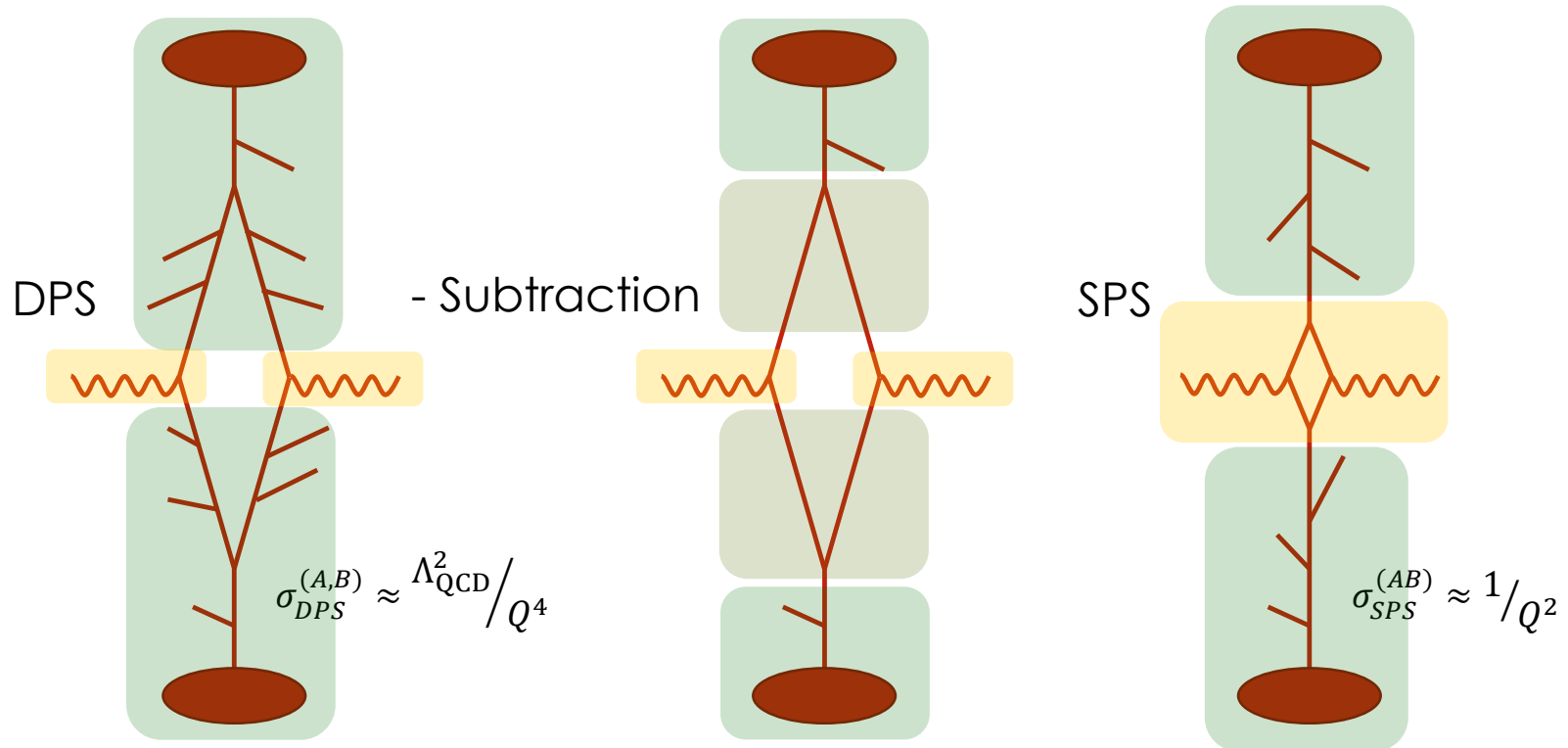

On power counting grounds, expect small  $y$  SPS region to be dominant - then  $DPS \ll SPS$ .

# WHICH REGION IS DOMINANT?

However there are various scenarios where it becomes preferable to have additional emissions in the loop, which compensates naïve power suppression:

- Small  $x$ : small  $x$  logs prefer earlier  $1 \rightarrow 2$  splitting, 2 legs to emit rather than 1!
- DY at large rapidity separation – preferable to produce one high  $x$  & one low  $x$  quark via
- Processes where leading order SPS loop is absent, like same-sign WW

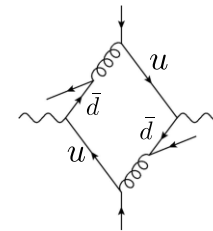
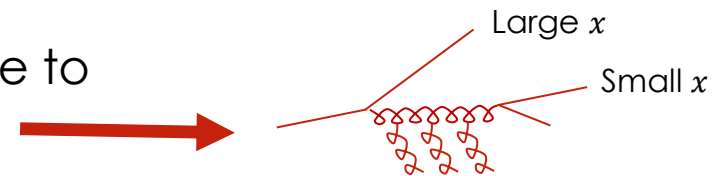
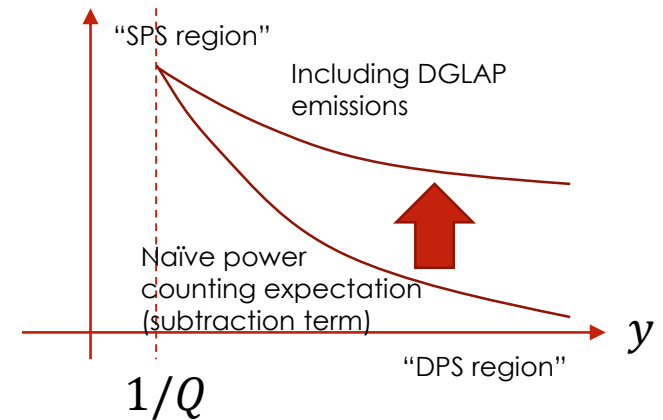

Here overlap with SPS is less important, or even numerically irrelevant. Can determine this by looking at  $y$  profile of DPS contribution.

# PHENO TOOLS FOR DPS

DPS theory developments have been rapid in recent years.  
Development of phenomenological tools has lagged behind.

Many experimental extractions of DPS use theoretical predictions of DPS shapes in multiple distributions ('templates').

Typically provided by Monte Carlo event generators.

11 variables in same-sign  $WW$ :

$$p_T^{l_1}, p_T^{l_2}, p_T^{miss}, \eta_1 \eta_2, |\eta_1 + \eta_2|, \\ m_{T(l_1, p_T^{miss})}, m_{T(l_1, l_2)}, |\Delta\phi_{(l_1, l_2)}|, \\ |\Delta\phi_{(l_2, p_T^{miss})}|, |\Delta\phi_{(ll, l_2)}|, m_{T2}^{ll}$$

CMS, PRL 131 (2023) 091803

Would be very useful to have a Monte Carlo event generator for DPS that includes latest theory developments!

# A DPS PARTON SHOWER

Motivated a parton shower implementation of full QCD framework for DPS: dShower. Cabouat, JG, Ostrolenk, JHEP 1911 (2019) 061

Brief summary of algorithm:

- Select  $x_i$  of initiating partons and separation  $y$  using full DPS formula. Involves use of some DPD set, can be specified by the user.
- Backward evolution from hard process with emissions from two legs. Angular ordered shower, as in Herwig.
- Shower evolution 'guided' by DPDs. Correlations encoded by these DPDs are fed into the shower

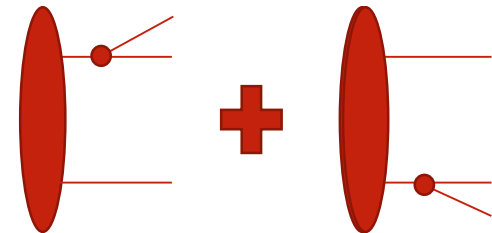

# A DPS PARTON SHOWER

- Allow possibility of 2→1 'mergings' in backward evolution at appropriate scale.

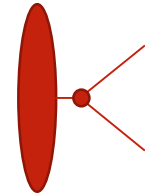

Intuitive picture:

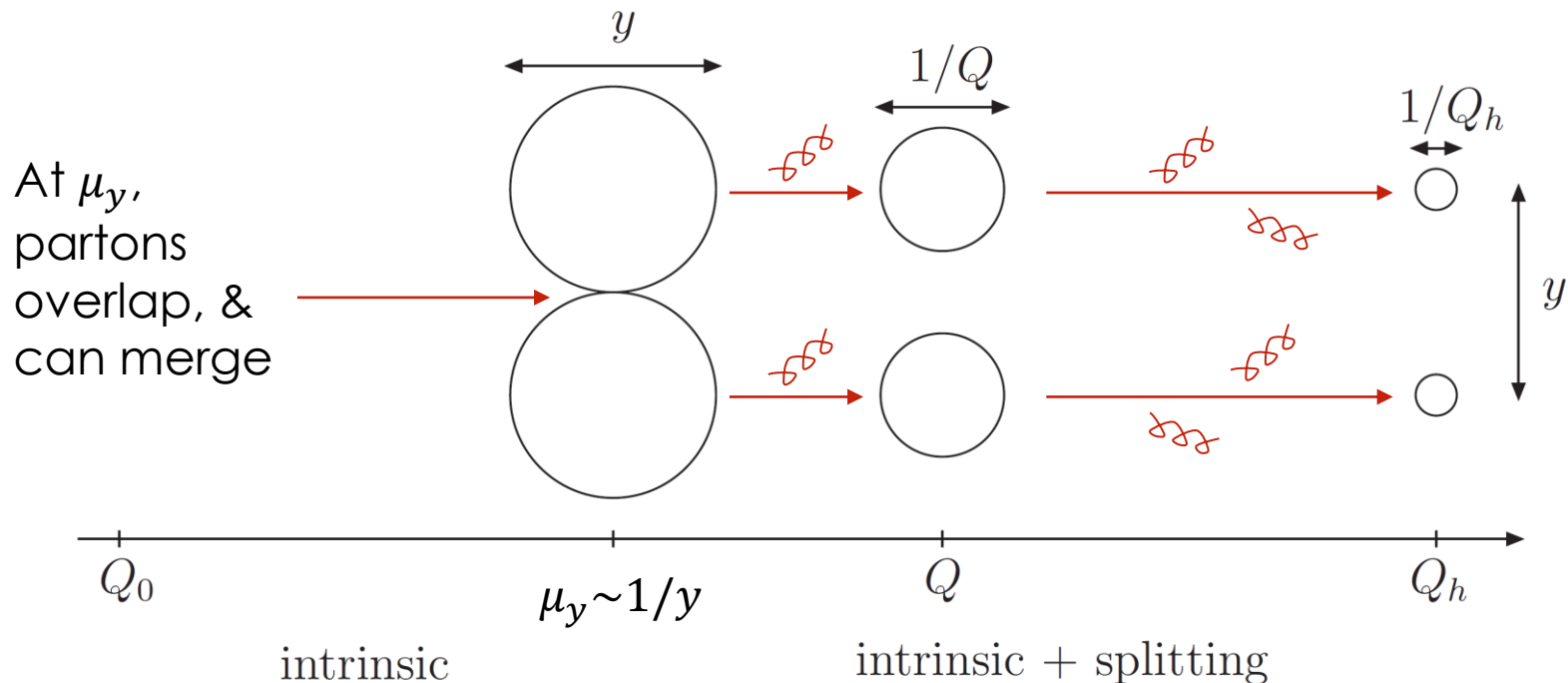

# EFFECTS OF CORRELATIONS

dShower predictions take account of correlations from  $1 \rightarrow 2$  splitting and also valence number and momentum constraints. These effects lie beyond the pocket formula.

Can we see the imprint of these in DPS predictions?

(see also Seonagh and Luca's talks!)

# WW ASYMMETRY

$$\mathcal{A} = \frac{\text{Diagram 1} - \text{Diagram 2}}{\text{Diagram 3} + \text{Diagram 4}}$$

Asymmetry  $\mathcal{A}$  as a function of  $\eta_{\min}$

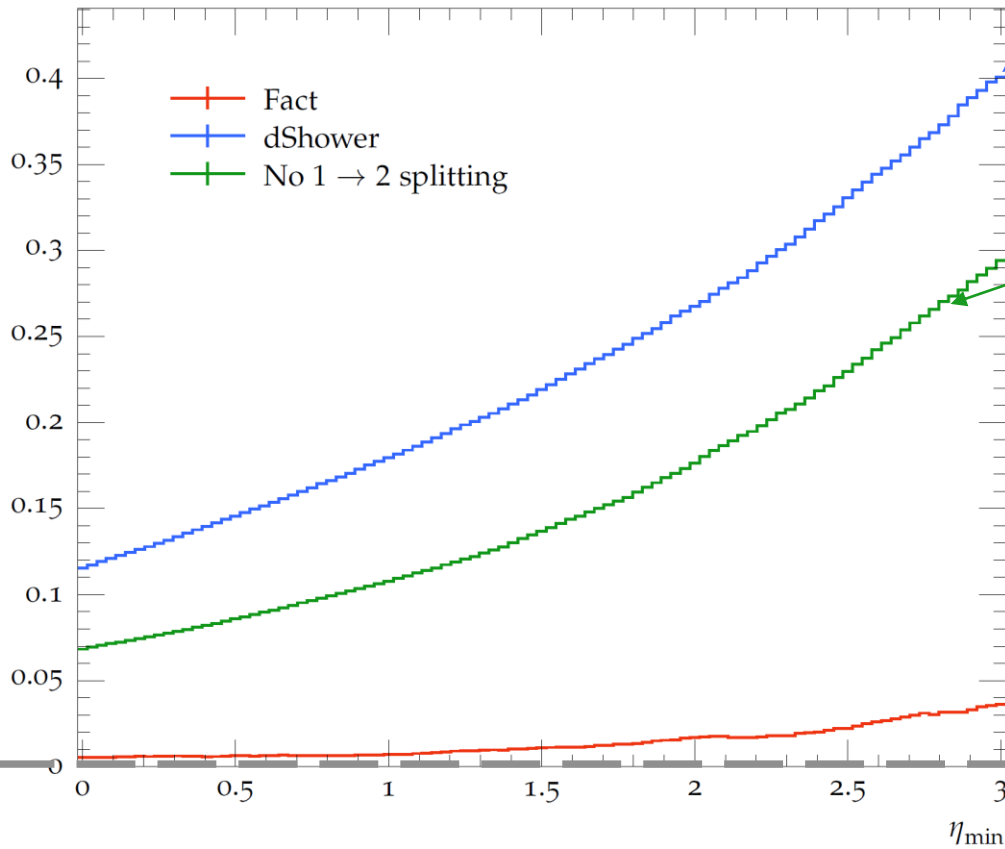

Includes 1  $\rightarrow$  2 splittings + valence number effects

Simple valence number effects

No parton-parton correlations



# WW TRANSVERSE MOMENTUM

WW  $p_T$  spectrum: dShower result skewed more towards larger  $p_T$

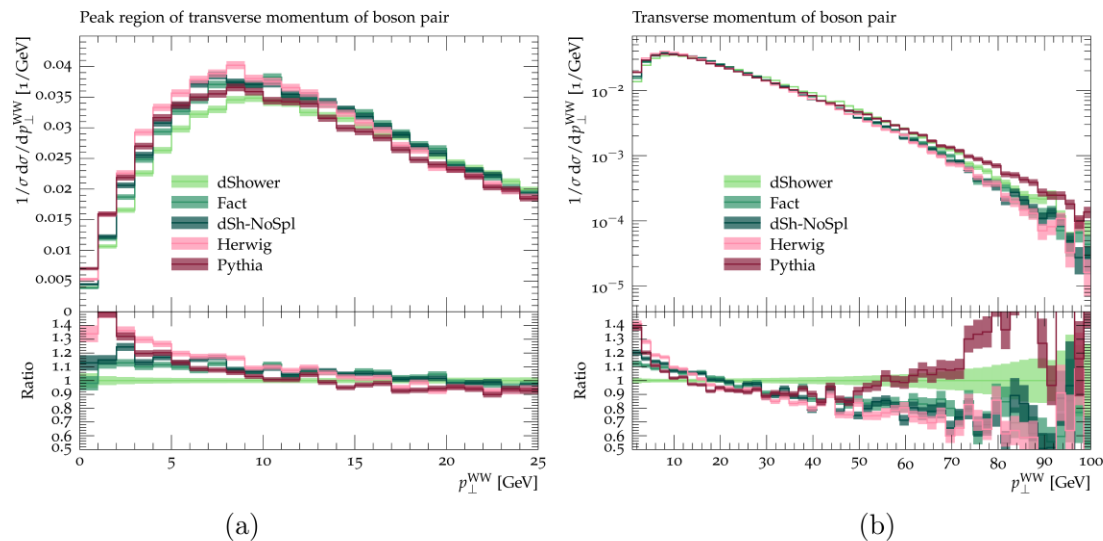

Explanation: larger  $qg$  distributions when including  $1 \rightarrow 2$  splitting effects, leads to greater chance of  $\tilde{q}g \rightarrow \tilde{q}q + \bar{q}$  and finite  $p_T$  of the  $\tilde{q}q$  system.

# SPIN CORRELATIONS

Other types of correlation possible in DPS – e.g. spin correlations

Mekhfi, Phys. Rev. D32 (1985) 2380  
 Diehl, Ostermeier and Schafer (JHEP 1203 (2012))  
 Manohar, Waalewijn, Phys.Rev. D85 (2012) 114009

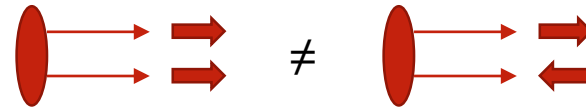

Spin correlations should be large at high  $x$ , but become less significant at smaller  $x$

Spin polarisation effects may have a measurable effect in same-sign

$WW$  [Cotogno, Kasemets, Myska, Phys.Rev. D100 (2019) 1, 011503, JHEP 10 (2020) 214]

Few percent effect on lepton pseudorapidity asymmetry, in scenario where 'initial' spin correlations are maximised.

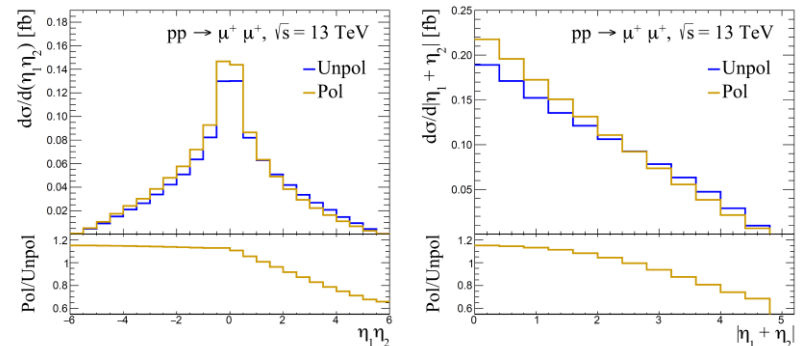

$ \eta_i $	$> 0$	$> 0.6$	$> 1.2$
$A$	0.07	0.11	0.16
$\sigma$ [fb]	0.51	0.29	0.13

# COLOUR CORRELATIONS

Can also have contributions to DPS associated with colour correlations

Colour correlations strongly (Sudakov) suppressed for large  $y \gg 1/Q$

Detailed study of size of colour correlations in Diehl, Fabry, PlöbI, JHEP 02 (2024) 229  
(see also Blok, Mehl, Int.J.Mod.Phys.A 39 (2024) 29, 2450111)

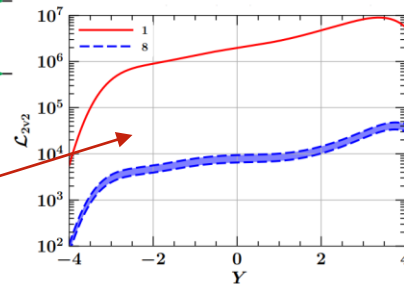
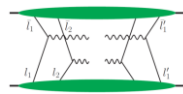

(a)  $2v2$  ( $u\bar{d}, \bar{d}u$ )

Dominated by large  $y$ , colour correlated contribution negligible

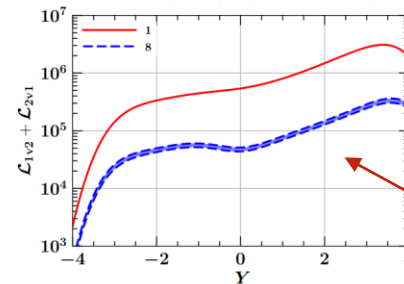

(b)  $1v2 + 2v1$  ( $u\bar{d}, \bar{d}u$ )

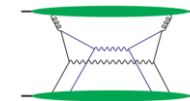

Dominated by smaller  $y$ , colour correlated contribution more relevant

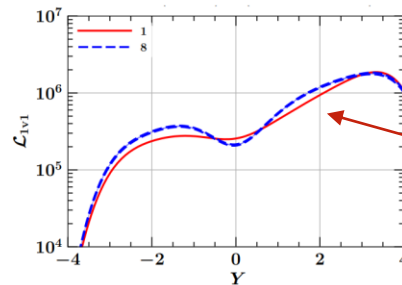

(c)  $1v1$  ( $u\bar{d}, \bar{d}u$ )

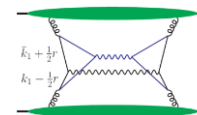

Dominated by even smaller  $y$ , colour correlated contribution as relevant as colour singlet!  
BUT: can compute in PT

DPS luminosity for a parton channel contributing to  $W^+W^+$

# SUMMARY

- DPS can compete with SPS for certain processes ( $W^\pm W^\pm$ , processes involving charm) and in certain kinematic regions. Relative importance grows with  $\sqrt{s}$ , and reveals new info on proton structure.
- Simplest approach: neglect correlations  $\rightarrow$  'pocket formula'. Seem to be some tensions between values of  $\sigma_{\text{eff}}$  extracted in different processes.
- Various effects/correlations beyond the pocket formula should exist: perturbative correlations ( $1 \rightarrow 2$  splittings), number & momentum constraints, spin and colour correlations. Can have an appreciable effect on DPS processes at the LHC.

Many other interesting topics I didn't discuss – e.g. DPS in pA/AA, NLO corrections in DPS predictions, computation of DPDs in lattice QCD,... Some discussed in other talks, see also backup slides!

# BACKUP SLIDES

# DPD OPERATOR DEFINITION

$$F_{ik}(x_1, x_2, \mathbf{y}, \mu_A, \mu_B) \propto \int dy^- dz_i^- e^{ix_i p^+ z_i^-} \langle p | \mathcal{O}_i(y + \frac{1}{2}z_1, y - \frac{1}{2}z_1) \mathcal{O}_j(\frac{1}{2}z_2, -\frac{1}{2}z_2) | p \rangle \Big|_{y^+=0, z_i^+=0, z_i=0},$$

$$\left[ \text{PDF: } f_i(x, \mu) \propto \int dz^- e^{ixp^+z^-} \langle p | \mathcal{O}_i(\frac{1}{2}z, -\frac{1}{2}z) | p \rangle \Big|_{z=0, z^+=0} \right]$$

# COMBINING SPS AND DPS WITHOUT DOUBLE COUNTING

# DPS WITHOUT DOUBLE COUNTING

I focus on SPS & 1v1 DPS overlap. Removal of overlap between 2v1 DPS & 3 particle collision is similar.

Step 1: insert cut-off function into DPS cross section formula

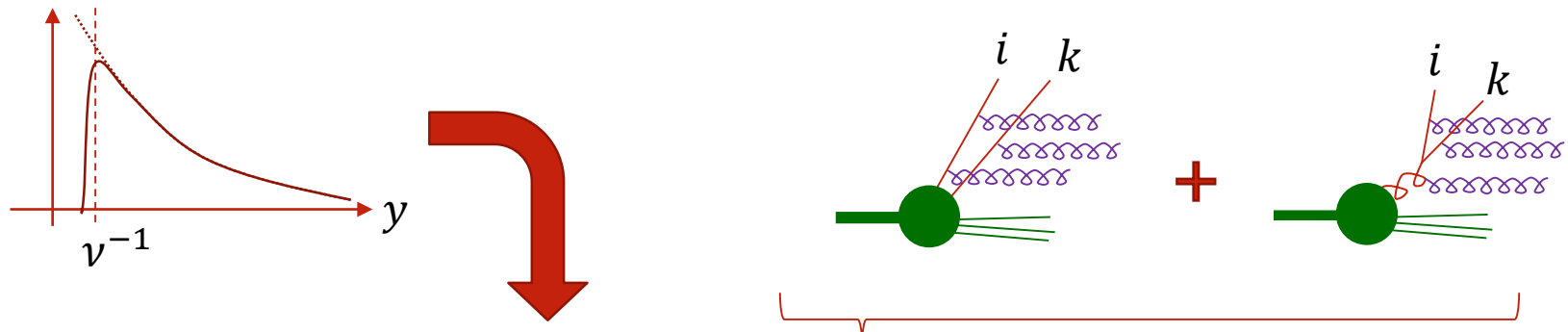

$$\sigma_{DPS}^{(A,B)} = \int dx_i dx'_i d^2 \mathbf{y} \Phi^2(y\nu) F_{ik}(x_1, x_2, \mathbf{y}, \mu_A, \mu_B) F_{jl}(x'_1, x'_2, \mathbf{y}, \mu_A, \mu_B) \times \hat{\sigma}_{ij}^A \hat{\sigma}_{kl}^B$$

Choose  $\nu \sim Q$  in practice.

Removed divergence. Double counting up to scale  $\nu$ .



# DPS WITHOUT DOUBLE COUNTING

Step 2: For total cross section for production of AB, include a subtraction term to remove double counting.

$$\sigma_{tot} = \sigma_{DPS} + \sigma_{SPS} - \sigma_{sub}$$

$\sigma_{sub}$ : DPS cross section with DPDs replaced by fixed order splitting expression – i.e. combining the approximations used to compute double splitting piece in two approaches.

$$F_{ij}(x_1, x_2, y, \mu^2) \rightarrow \frac{1}{\pi y^2} \frac{f_k(x_1 + x_2, \mu^2)}{x_1 + x_2} \frac{\alpha_s(\mu^2)}{2\pi} P_{k \rightarrow ij} \left( \frac{x_1}{x_1 + x_2} \right)$$

General subtraction philosophy used in many QCD calculations (proofs of factorisation, SCET, NLO + PS matching...)

# HOW THE SUBTRACTION WORKS

$$\sigma_{tot} = \sigma_{DPS} + \sigma_{SPS} - \sigma_{sub}$$

For small  $\mathbf{y}$  (of order  $1/Q$ ) the dominant contribution to  $\sigma_{DPS}$  comes from the (fixed order) perturbative expression  $\Rightarrow \sigma_{DPS} \approx \sigma_{sub}$   
 $\& \sigma_{tot} \approx \sigma_{SPS}$  ✓

Dependence on  $\nu$  cancels order-by-order between  $\sigma_{DPS}$  &  $\sigma_{sub}$

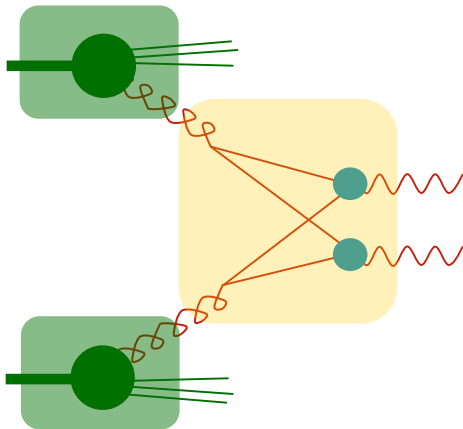

For large  $\mathbf{y}$  (much larger than  $1/Q$ ) the dominant contribution to  $\sigma_{SPS}$  is the region of the 'double splitting' loop where DPS approximations are valid

$$\Rightarrow \sigma_{SPS} \approx \sigma_{sub}$$

$$\& \sigma_{tot} \approx \sigma_{DPS}$$
 ✓

# CUTOFF DEPENDENCE

Important:  $\sigma_{DPS}$  is not really 'meaningful' on its own. Can only measure  $\sigma_{tot} = \sigma_{DPS} + \sigma_{SPS} - \sigma_{sub}$

Power counting:  $\propto \nu^2$

IN CERTAIN CASES:

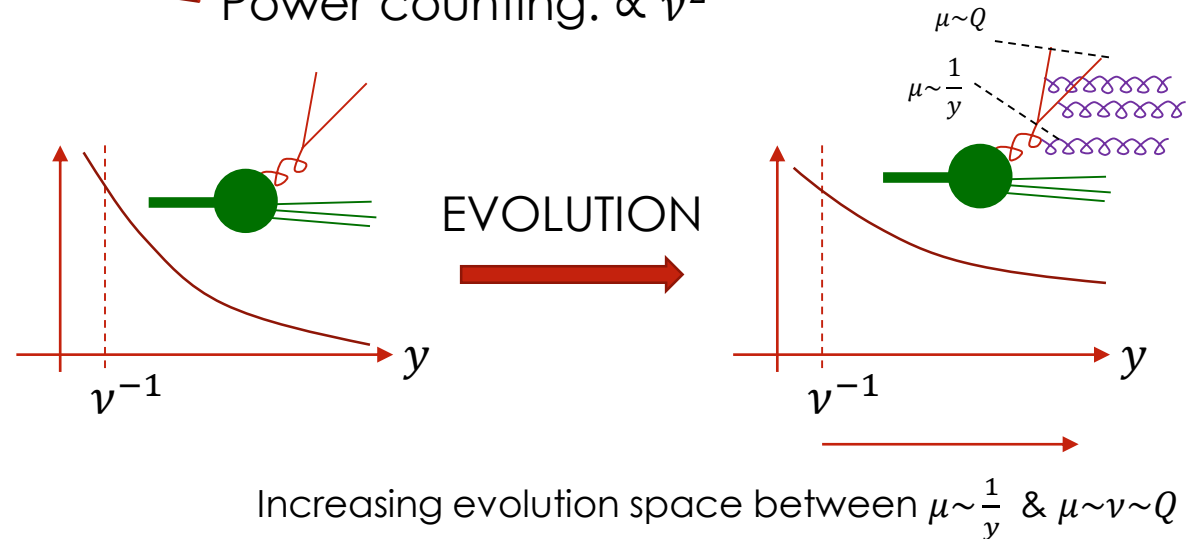

Bulk of  $\sigma_{DPS}$  shifts to large  $y$  where DPS approximations are valid. Small  $y$  is less important  $\rightarrow$  reduced  $\nu$  dependence,  $\sigma_{sub}$  and two-loop  $\sigma_{SPS}$  less important.

# REDUCED CUTOFF DEPENDENCE

Example: two systems widely separated in rapidity.

$$\mathcal{L} = \int \Phi(vy)^2 F_{u\bar{u}}(y) F_{\bar{u}u}(y)$$

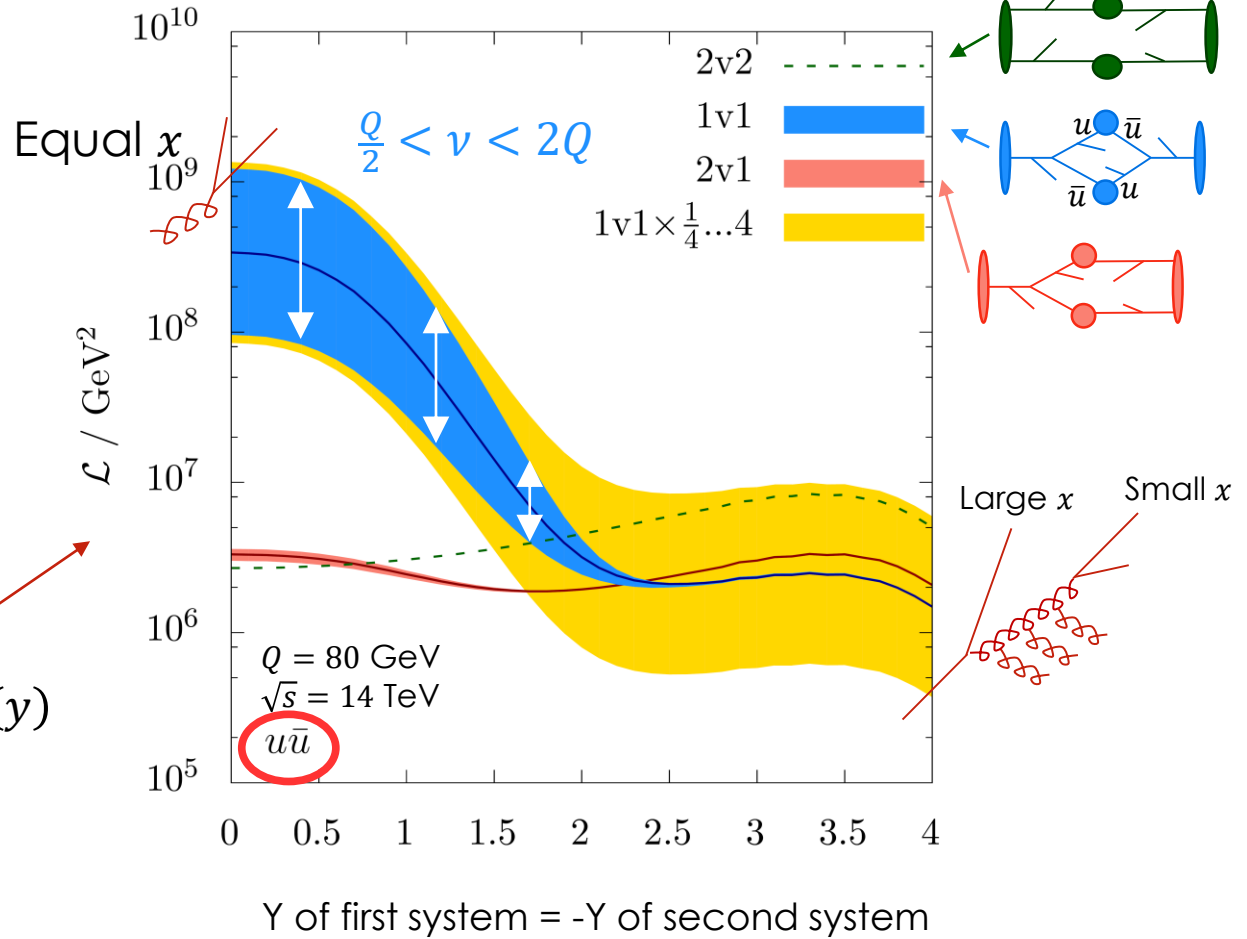
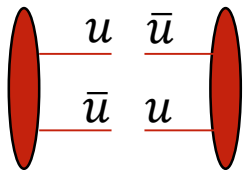

# REDUCED CUTOFF DEPENDENCE

Another example where overlap considerations are less important: processes with no two-loop box contribution

E.g. Same-sign WW production

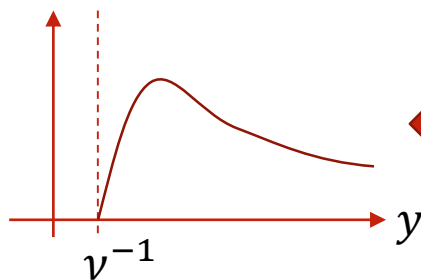
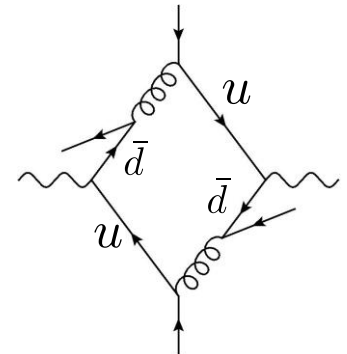

← Splitting DPD profile

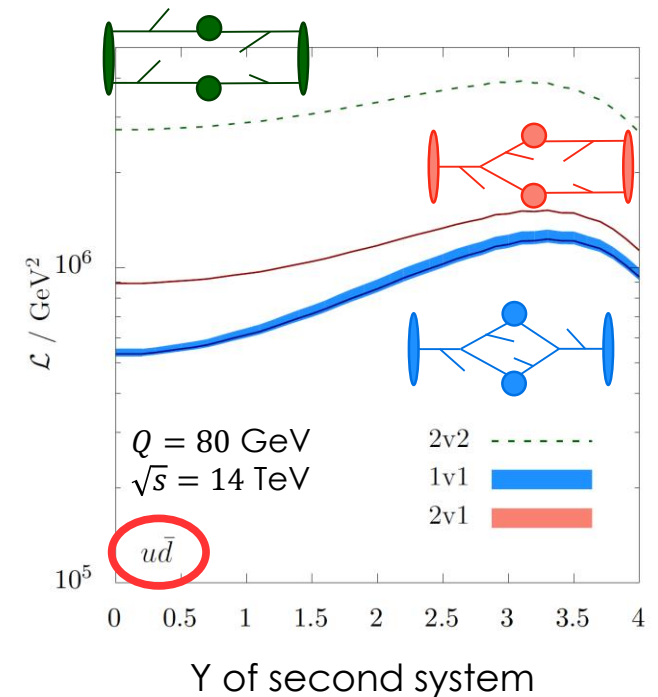

# FACTORISATION IN DPS

# FACTORISATION IN DPS

To prove factorisation for DPS inclusive cross section, need to show:

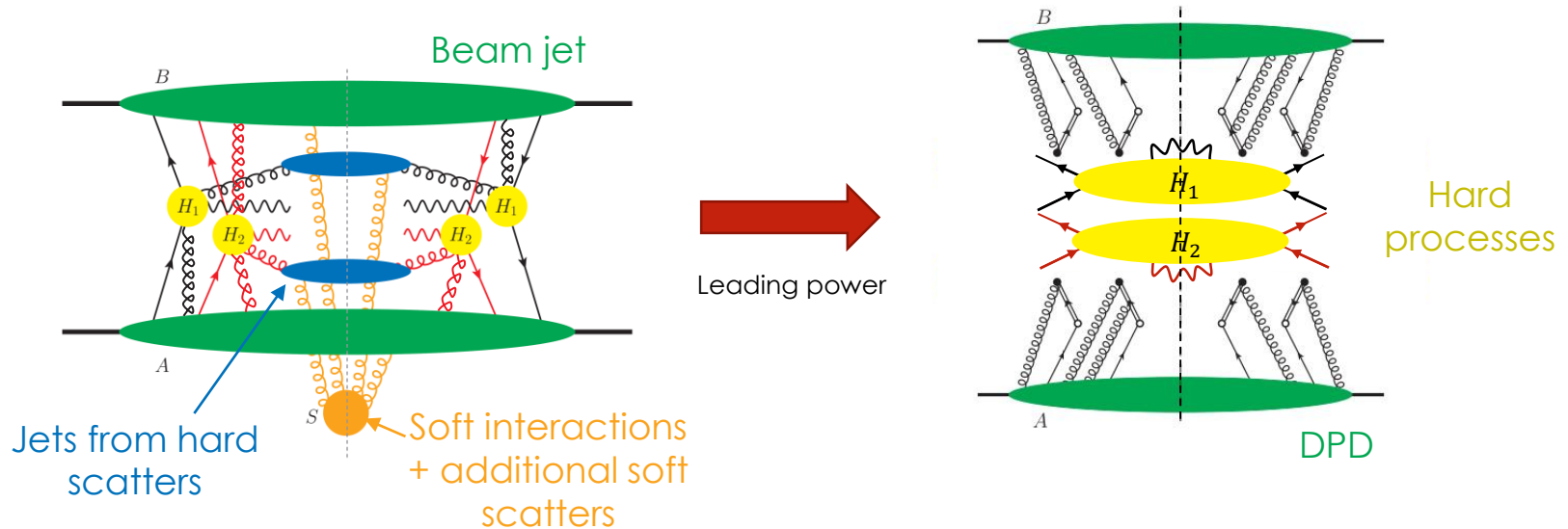

Key step: need to separate off all soft connections entangling beam and final state jets.

For 'normal' soft exchanges, this can be achieved via Ward identities:



# FACTORISATION: SOFT EXCHANGES

However, there is a particular type of soft exchange for which this doesn't work: **Glauber exchanges**.  
**Soft particles mediating forward scattering.**

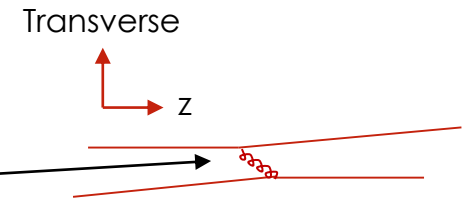

Treatment of Glauber exchanges is the trickiest part of a factorisation proof!

Single scattering production of colour singlet  $V$ : Collins, Soper, Sterman showed that **effect of Glauber exchanges cancels if we measure only properties of  $V$ , and sum over everything else!**

$$\left| \begin{array}{c} \text{Diagram 1} \\ + \\ \text{Diagram 2} \\ + \\ \text{Diagram 3} \end{array} \right|^2 = \left| \begin{array}{c} \text{Diagram 4} \end{array} \right|^2$$

The diagram shows three Feynman diagrams on the left, summed together and squared. The first diagram shows a hard scattering vertex (two red ovals) connected to a wavy line (representing a color singlet  $V$ ). The second diagram shows the same vertex with a wavy line and a yellow wavy line (representing a soft particle) connected to the vertex. The third diagram shows the same vertex with a wavy line and two yellow wavy lines (representing soft particles) connected to the vertex. On the right, a single diagram shows the vertex connected to a wavy line, representing the result after Glauber exchanges cancel out.

**If one starts measuring properties of radiation accompanying  $V$  (e.g. global event shape variables), this argument breaks down!**



# GLAUBER CANCELLATION IN DPS

In JHEP 1601 (2016) 076 (Diehl, JG, Schäfer, Ostermeier, Plöchl) we adapted the methodology of Collins, Soper, Sterman to show that **Glauber exchanges also cancel for DPS production of two colourless systems.**

Full proof is very technical, but can get some insight as to why it works by looking at **spacetime pictures** of single and double scattering:

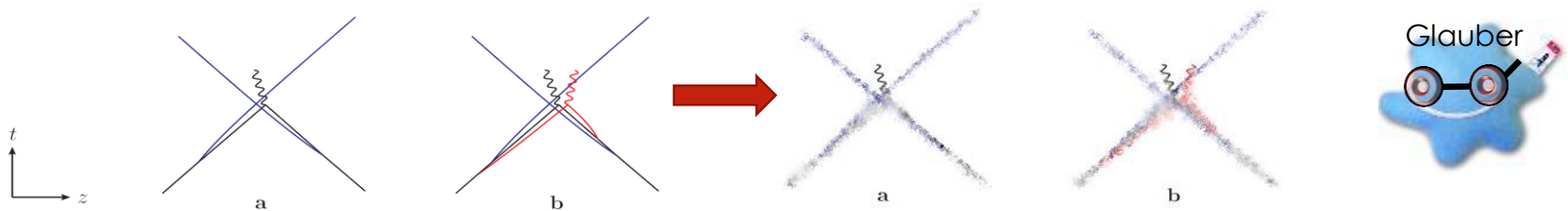

Other important steps towards factorisation proof made in Diehl, Ostermeier, Schafer, JHEP 1203 (2012) 089 Vladimirov, JHEP 1804 (2018) 045, Diehl, Nagar, arXiv:1812.09509.

# FACTORISATION IN DPS

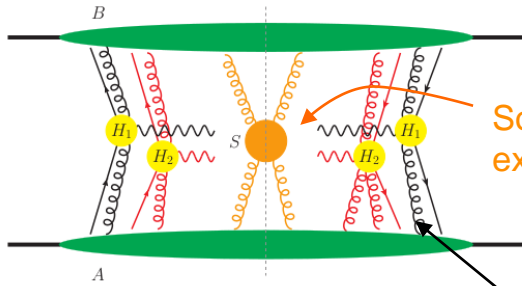

Diehl, JG, Ostermeier, Plöchl, Schafer, JHEP 1601 (2016) 076, Diehl, Ostermeier, Schafer, JHEP 1203 (2012) 089, Diehl, Nagar, JHEP 1904 (2019) 124.

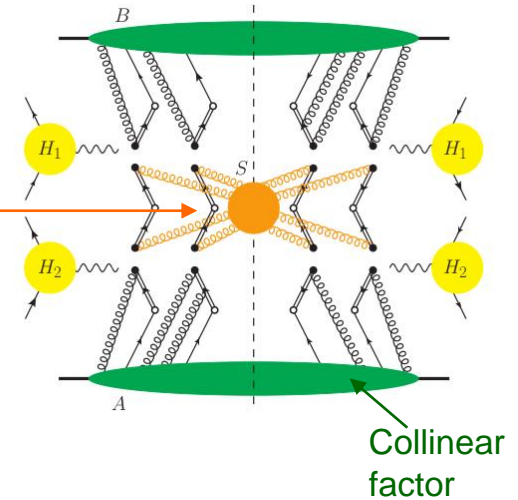

Vladimirov, JHEP 1804 (2018) 045

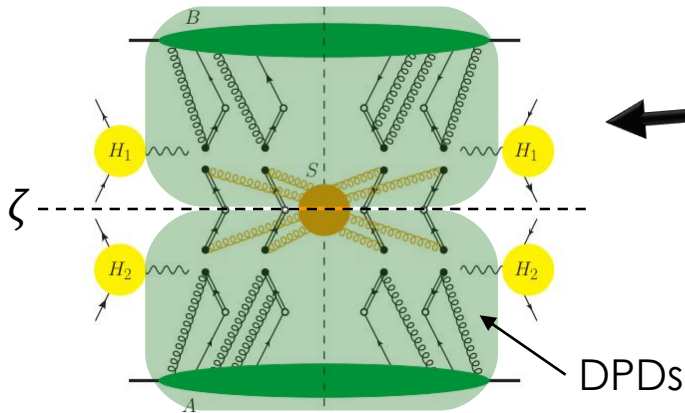

$$\sigma \sim F \otimes F \otimes \hat{\sigma} \otimes \hat{\sigma}$$

Proven, at least for double Drell-Yan production!

# NEXT-TO-LEADING ORDER

# NLO CORRECTIONS TO DPS

DGS framework opens the way for the first NLO computations of DPS.  
What is needed for these computations?

- NLO corrections to partonic cross sections: already known for many processes from SPS calculations ✓
- NLO 'usual' splitting functions - needed for evolution of  $F(\mathbf{y})$ : already known since the 80s ✓  
Curci, Furmanski, Petronzio, Nucl. Phys. B175, 27 (1980),  
Furmanski, Petronzio, Phys. Lett. 97B, 437 (1980),...
- NLO corrections to the splitting - recently computed! ✓

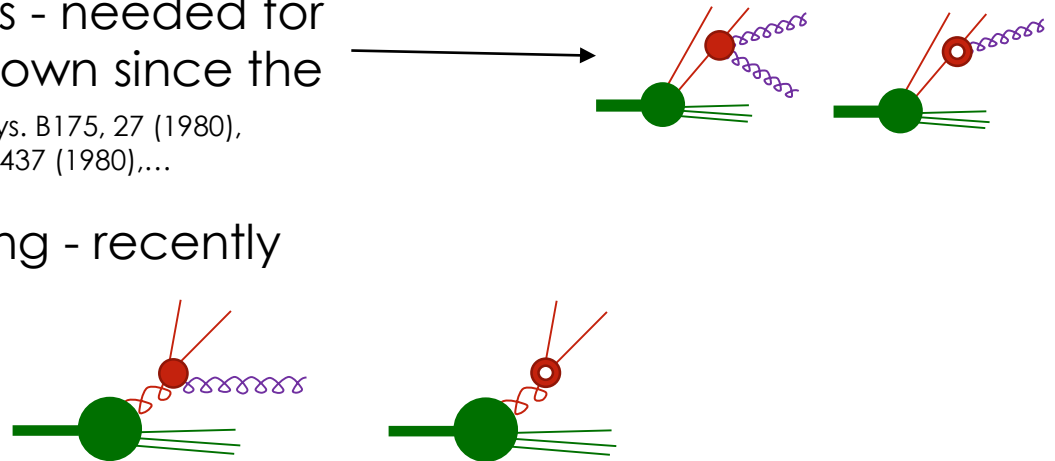

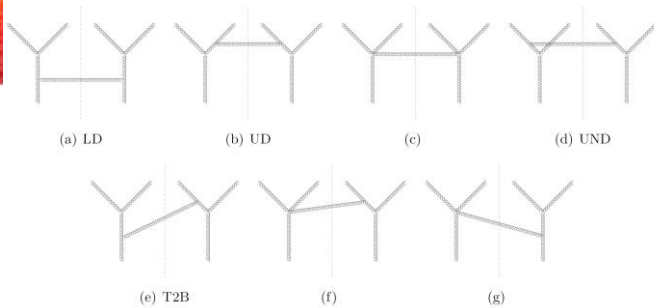

# NLO: METHOD

Compute graph expressions  
(FORM, FeynCalc).  
Integrate over minus components using contours.

[Kuipers, Ueda, Vermaseren, Vollinga, Comput. Phys. Commun. 184 (2013) 1453-1467]  
[Shtabovenko, Mertig, Orellana, Comput. Phys. Commun. 207 (2016) 432-444]



$$D_1 = \frac{(k_1 + \Delta)^2}{x_1} + \frac{(k_2 - \Delta)^2}{x_2} + \frac{(k_1 + k_2)^2}{x_3} \quad D_2 = \frac{k_1^2}{x_1} + \frac{k_2^2}{x_2} + \frac{(k_1 + k_2)^2}{x_3}$$

$$D_3 = (k_1 + \Delta)^2 \quad D_4 = k_2^2 \quad \tilde{D}_4 = k_1^2 \quad \tilde{D}_5 = (k_1 + k_2)^2$$

$$I_1(a_1, a_2, a_3, a_4) = \int \frac{d^{d-2} \mathbf{k}_1 d^{d-2} \mathbf{k}_2}{\prod_{i=1..4} D_i^{a_i}} \quad I_2(a_1, a_2, a_3, a_4, a_5) = \int \frac{d^{d-2} \mathbf{k}_1 d^{d-2} \mathbf{k}_2}{\prod_{i=1..3} D_i^{a_i} \prod_{i=4..5} \tilde{D}_i^{a_i}}$$

$$I_1(1, 1, 0, 0), I_1(0, 1, 1, 0), I_1(1, 1, 1, 0), I_1(1, 0, 1, 1), I_1(1, 1, 1, 1), I_1(2, 1, 1, 1)$$

$$I_2(0, 1, 1, 0, 1), I_2(1, 1, 1, 1, 0)$$

Integration-by-parts reduction to master integrals (LiteRed)

[Lee, J. Phys. Conf. Ser. 523 (2014)]

$$\begin{bmatrix} \frac{\partial I_1(1,1,0,0)}{\partial x_1} \\ \frac{\partial I_1(0,1,1,0)}{\partial x_1} \\ \frac{\partial I_1(1,1,1,0)}{\partial x_1} \\ \frac{\partial I_1(1,0,1,1)}{\partial x_1} \\ \frac{\partial I_1(1,1,1,1)}{\partial x_1} \\ \frac{\partial I_1(2,1,1,1)}{\partial x_1} \end{bmatrix} = \begin{bmatrix} \blacksquare & 0 & 0 & 0 & 0 & 0 \\ 0 & \blacksquare & 0 & 0 & 0 & 0 \\ \blacklozenge & \blacklozenge & \blacksquare & 0 & 0 & 0 \\ 0 & \blacklozenge & 0 & \blacksquare & 0 & 0 \\ \blacklozenge & \blacklozenge & \blacklozenge & \blacklozenge & \blacksquare & \blacksquare \\ \blacklozenge & \blacklozenge & \blacklozenge & \blacklozenge & \blacksquare & \blacksquare \end{bmatrix} \begin{bmatrix} I_1(1, 1, 0, 0) \\ I_1(0, 1, 1, 0) \\ I_1(1, 1, 1, 0) \\ I_1(1, 0, 1, 1) \\ I_1(1, 1, 1, 1) \\ I_1(2, 1, 1, 1) \end{bmatrix}$$

Construct differential equations in  $x_1$  and solve (Fuchsia)

[Gituliar, Magerya, Comput. Phys. Commun. 219 (2017) 329-338]

Results for bare graphs!

$$\rightarrow I_1(0, 1, 1, 0) \rightarrow \pi^{3-2\epsilon} x_3^{1-\epsilon} (x_1 x_2)^\epsilon \frac{\Gamma[-\epsilon]}{\sin[2\pi\epsilon] \Gamma[1-3\epsilon]}$$

Computation of  $x_3 \rightarrow 0$  limit of master integrals using method of regions (boundary conditions)

# NLO: SOME NUMERICS

Scale 10 GeV, splitting contribution only, no evolution after splitting

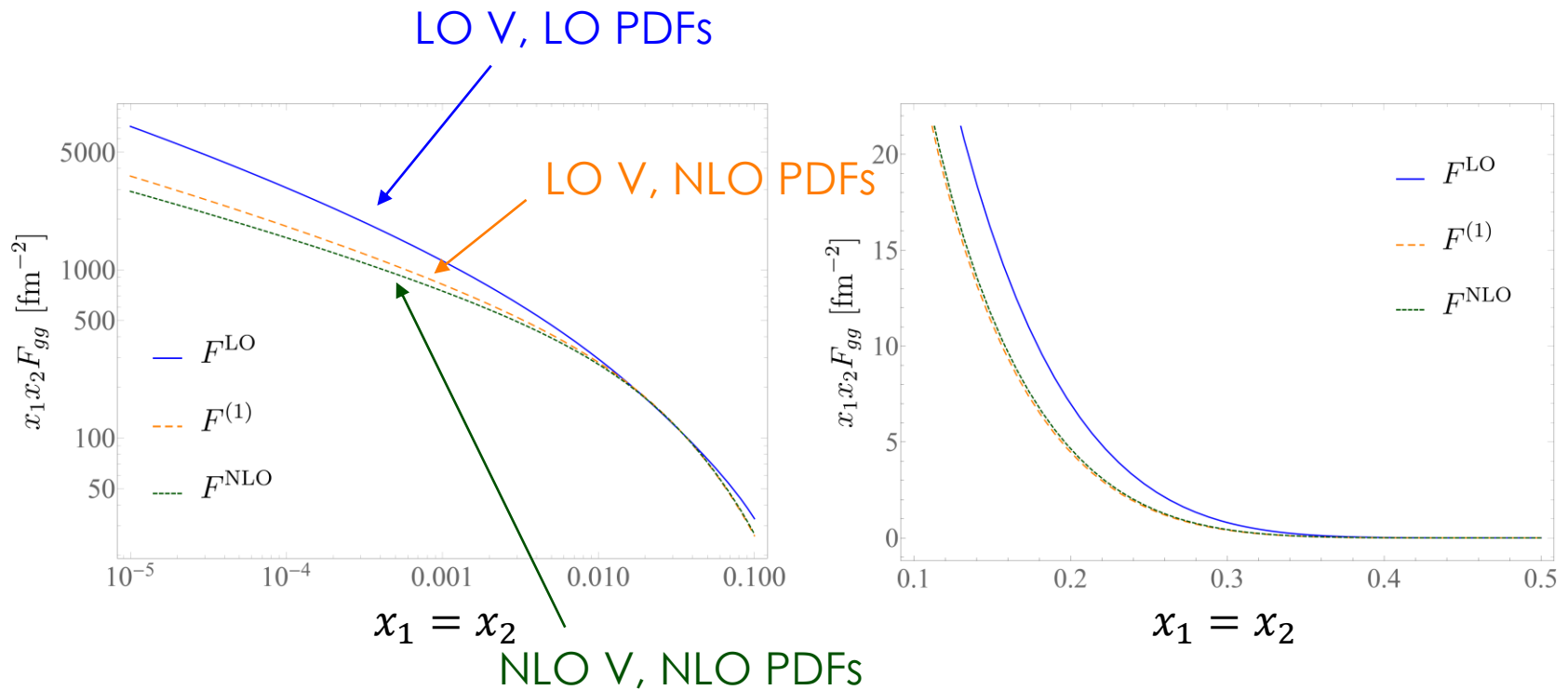

# NLO: SOME NUMERICS

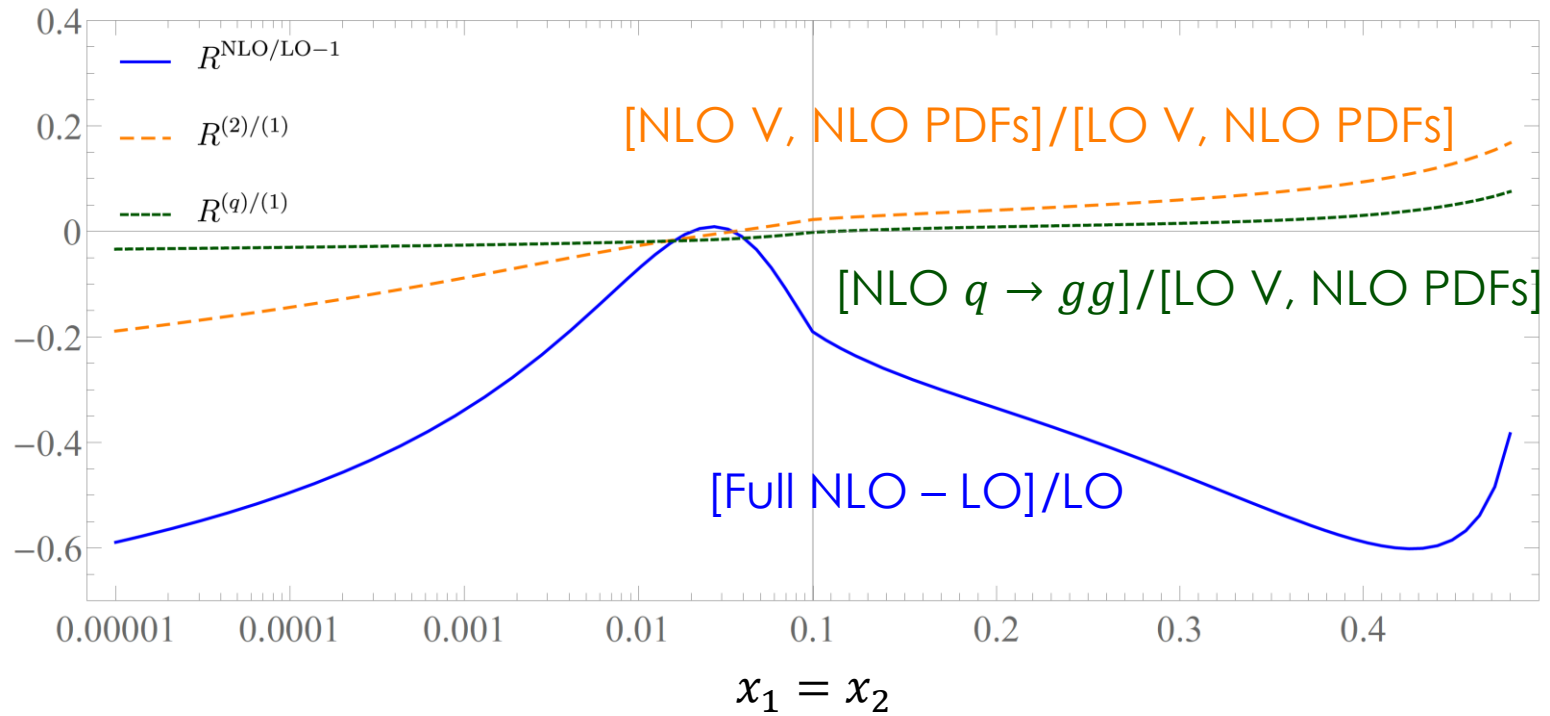

# TRANSVERSE MOMENTUM IN DPS



# TRANSVERSE MOMENTUM IN DPS

Small  $q_i$  region particularly important for DPS – DPS & SPS same power

Parton model analysis:  $\frac{d\sigma^{(A,B)}}{d^2q_1 d^2q_2} \sim \int d^2y d^2z_i e^{-iz_1 \cdot q_1 - iz_2 \cdot q_2} \underbrace{F(z_1, z_2, y) F(z_1, z_2, y)}_{\text{DTMDs}}$

Diehl, Ostermeier, Schafer, JHEP 1203 (2012) 089

DTMDs

QCD treatment of transverse momentum in DPS (including DGS-style double counting subtraction) developed in Buffing, Diehl, Kasemets JHEP 1801 (2018) 044. DPS cross section in QCD:

$$\frac{d\sigma_{\text{DPS}}}{dx_1 dx_2 d\bar{x}_1 d\bar{x}_2 d^2q_1 d^2q_2} = \frac{1}{C} \cdot \sum_{a_1, a_2, b_1, b_2} \hat{\sigma}_{a_1 b_1}(Q_1, \mu_1) \hat{\sigma}_{a_2 b_2}(Q_2, \mu_2) \times \int \frac{d^2z_1}{(2\pi)^2} \frac{d^2z_2}{(2\pi)^2} d^2y \cdot e^{-iq_1 z_1 - iq_2 z_2} W_{a_1 a_2 b_1 b_2}(\bar{x}_i, x_i, z_i, y; \mu_i, \nu),$$

Cut-off functions

$$W_{a_1 a_2 b_1 b_2}(\bar{x}_i, x_i, z_i, y; \mu_i, \nu) = \Phi(\nu y_+) \Phi(\nu y_-) \times \sum_R \eta_{a_1 a_2}(R) {}^R F_{b_1 b_2}(\bar{x}_i, z_i, y; \mu_i, \zeta) \cdot {}^R F_{a_1 a_2}(x_i, z_i, y; \mu_i, \zeta).$$

Dependence on ren. scales  $\mu_i$  AND a rapidity scale  $\zeta$ .

Evolution of DTMDs in all of these scales known at one loop.

# TRANSVERSE MOMENTUM IN DPS

Still need some 'initial' expressions for the DTMDs. Function of many arguments  $(x_i, \mathbf{y}, \mathbf{z}_i)$ . Hopeless?

For perturbative  $|\mathbf{q}_i| \gg \Lambda$  can expand DTMDs in terms of collinear quantities:

Large  $\mathbf{y} \sim 1/\Lambda$ :

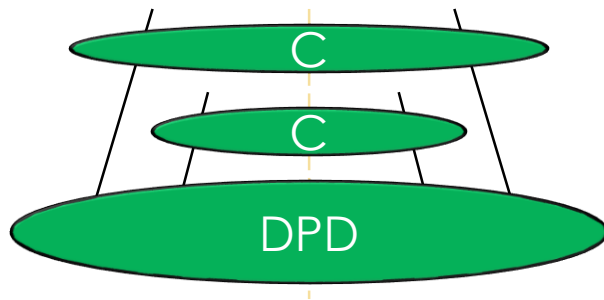

Small  $\mathbf{y} \sim 1/q_T \sim |\mathbf{z}_i|$ :

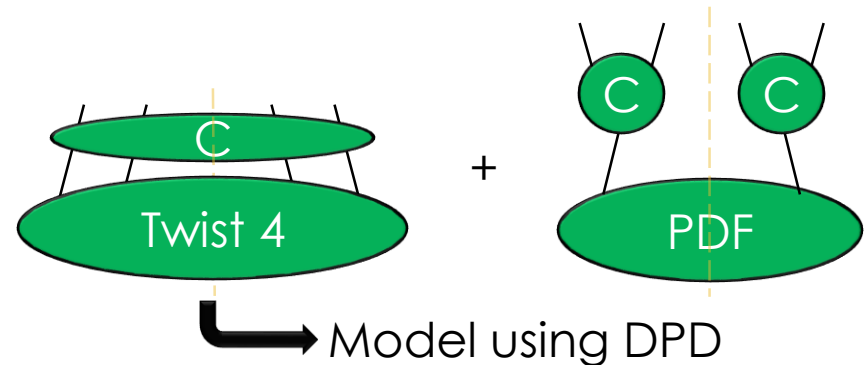

So then, need only DPDs and PDFs: very good prospects for phenomenology at perturbative  $|\mathbf{q}_i|$ !

Brief overview of transverse momentum in DPS given in JG, Kasemets, Advances in High Energy Physics, 2019, 3797394

# DSHOWER

# DSHOWER ALGORITHM

(1) Select  $x_i$  of initiating partons and  $y$  using DPS formula:

$$\sigma_{(A,B)}^{\text{DPS}}(s) = \frac{1}{1 + \delta_{AB}} \sum_{i,j,k,l} \int d\tau_A dY_A d\hat{t}_A d\tau_B dY_B d\hat{t}_B \frac{d\hat{\sigma}_{ij \rightarrow A}}{d\hat{t}_A} \frac{d\hat{\sigma}_{kl \rightarrow B}}{d\hat{t}_B} \\ \times \int 2\pi y dy \Phi^2(y\nu) F_{ik}(x_1, x_3, \mathbf{y}, \mu^2) F_{jl}(x_2, x_4, \mathbf{y}, \mu^2)$$

DPDs

Cut-off of DPS for  $y$  values  $\lesssim 1/\nu \sim 1/Q$

# DSHOWER ALGORITHM

(2) Generate QCD emissions, going backwards from hard process

In shower must select an evolution variable. We make the same choice as Herwig:

For ISR:  $Q^2 = \tilde{q}_{ISR}^2 = -\frac{(p_i^2 - m_i^2)}{(1-z)} \approx E_k^2 \theta_j^2$  ← Angular ordering

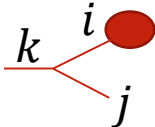

Probability that partons  $ij$  survive from  $Q_h$  to  $Q$ , and then at  $Q$  there is an emission from one leg:

$$d\mathcal{P}_{ij}^{ISR} = d\mathcal{P}_{ij} \underbrace{\exp\left(-\int_{Q^2}^{Q_h^2} d\mathcal{P}_{ij}\right)}_{\text{'Sudakov factor'}}$$

Emission probability

$$d\mathcal{P}_{ij} = \frac{dQ^2}{Q^2} \left( \sum_{i'} \int_{x_1}^{1-x_2} \frac{dx'_1}{x'_1} \frac{\alpha_s(p_{\perp}^2)}{2\pi} P_{i' \rightarrow i} \left( \frac{x_1}{x'_1} \right) \frac{F_{i'j}(x'_1, x_2, \mathbf{y}, Q^2)}{F_{ij}(x_1, x_2, \mathbf{y}, Q^2)} \right. \\ \left. + \sum_{j'} \int_{x_2}^{1-x_1} \frac{dx'_2}{x'_2} \frac{\alpha_s(p_{\perp}^2)}{2\pi} P_{j' \rightarrow j} \left( \frac{x_2}{x'_2} \right) \frac{F_{ij'}(x_1, x'_2, \mathbf{y}, Q^2)}{F_{ij}(x_1, x_2, \mathbf{y}, Q^2)} \right)$$

Emission from leg 1

Emission from leg 2

Use 'competing veto algorithm' to decide which leg emits

# DSHOWER ALGORITHM

(3) At scale  $\mu_y \sim 1/y$ , decide whether to merge partons  $i$  and  $j$ . Merging is done with a probability given by:

$$p_{Mrg} = F_{ij}^{spl}(x_1, x_2, y, \mu_y^2) / F_{ij}^{tot}(x_1, x_2, y, \mu_y^2)$$

Total DPD

$$F_{ij}^{spl}(x_1, x_2, y, \mu_y^2) = \frac{1}{\pi y^2} \frac{f_k(x_1+x_2, \mu_y^2)}{x_1+x_2} \frac{\alpha_s(\mu_y^2)}{2\pi} P_{k \rightarrow ij} \left( \frac{x_1}{x_1+x_2} \right) \times \text{large } y \text{ suppression}$$



If no merging: continue with two parton branching algorithm from (2), using only 'intrinsic' DPDs.

If merging: shower single parton a la Herwig.

# KINEMATICS: NO MERGING

No merging:

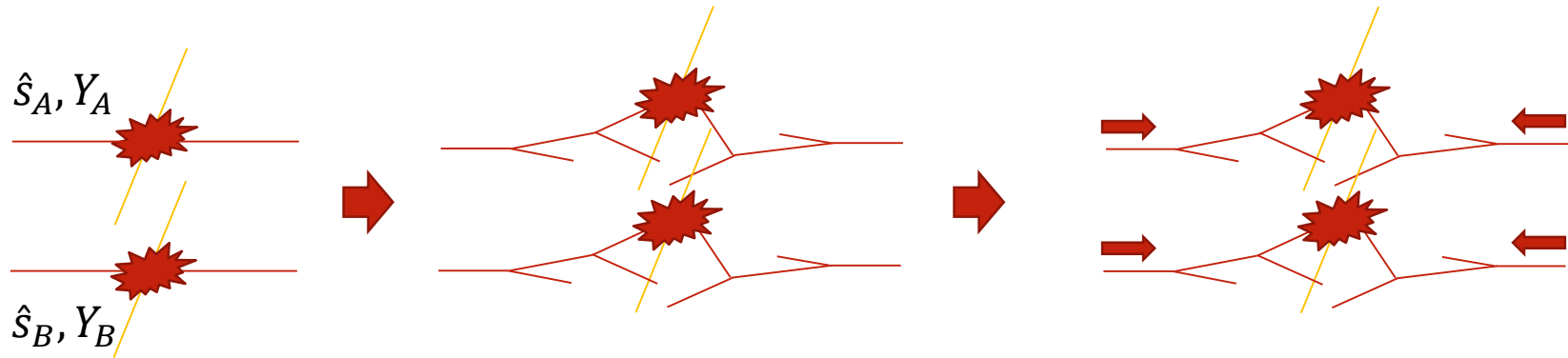

Generate hard process using DPS  $\sigma$

Add shower,  
kinematics of hard  
processes altered

Boost initiator partons  
to restore  $\hat{s}_A, Y_A, \hat{s}_B, Y_B$

Works as 4 variables (boosts) and 4 constraints! What about if there is a merging? 2/3 initiator partons  $\rightarrow$  overconstrained system!

# KINEMATICS: MERGING

With merging:

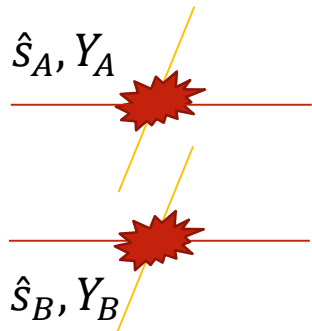

Generate hard process using DPS  $\sigma$

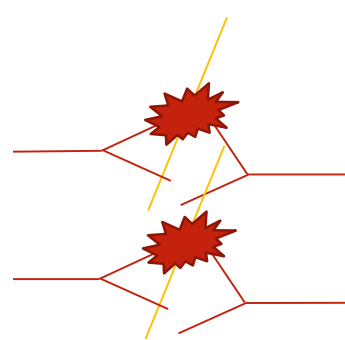

At  $\mu_y$ , decided merging will happen

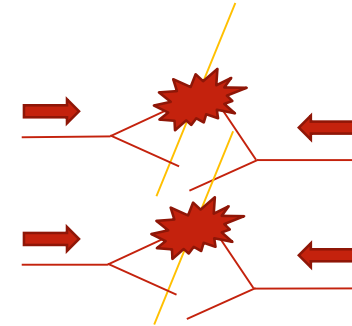

Boost initiator partons to restore  $\hat{s}_A, Y_A, \hat{s}_B, Y_B$

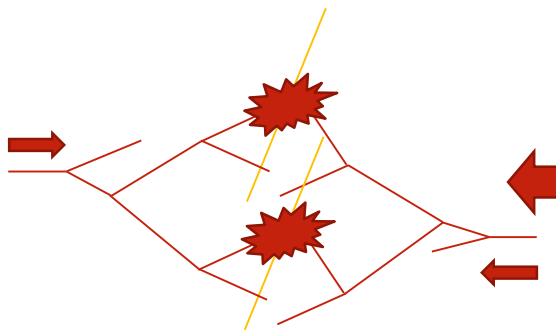

Boost initiator partons to restore  $\hat{s}', Y'$

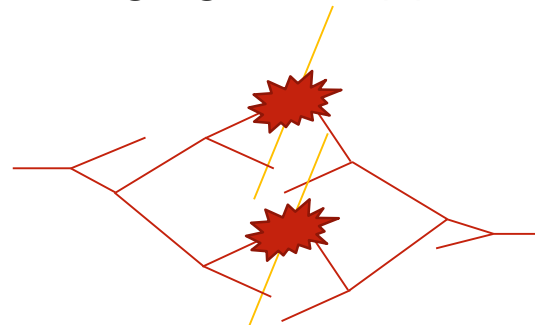

Continue shower

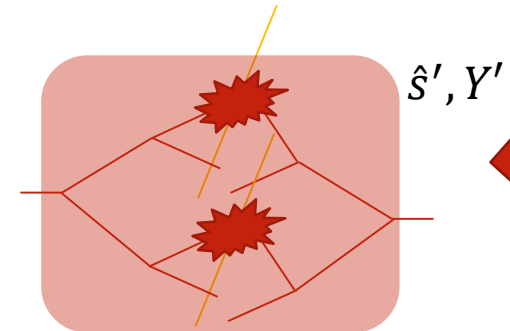

Merge (zero  $p_T$ , or  $p_T \sim \mu_y$ ). Define new hard system.



# COLOUR WITH MERGING

Shower uses large  $N_c$  approximation. Each new emission  $\rightarrow$  new colour. Independent showers before merging.

Mergings require some colour reshuffling. We impose minimal colour disruption.

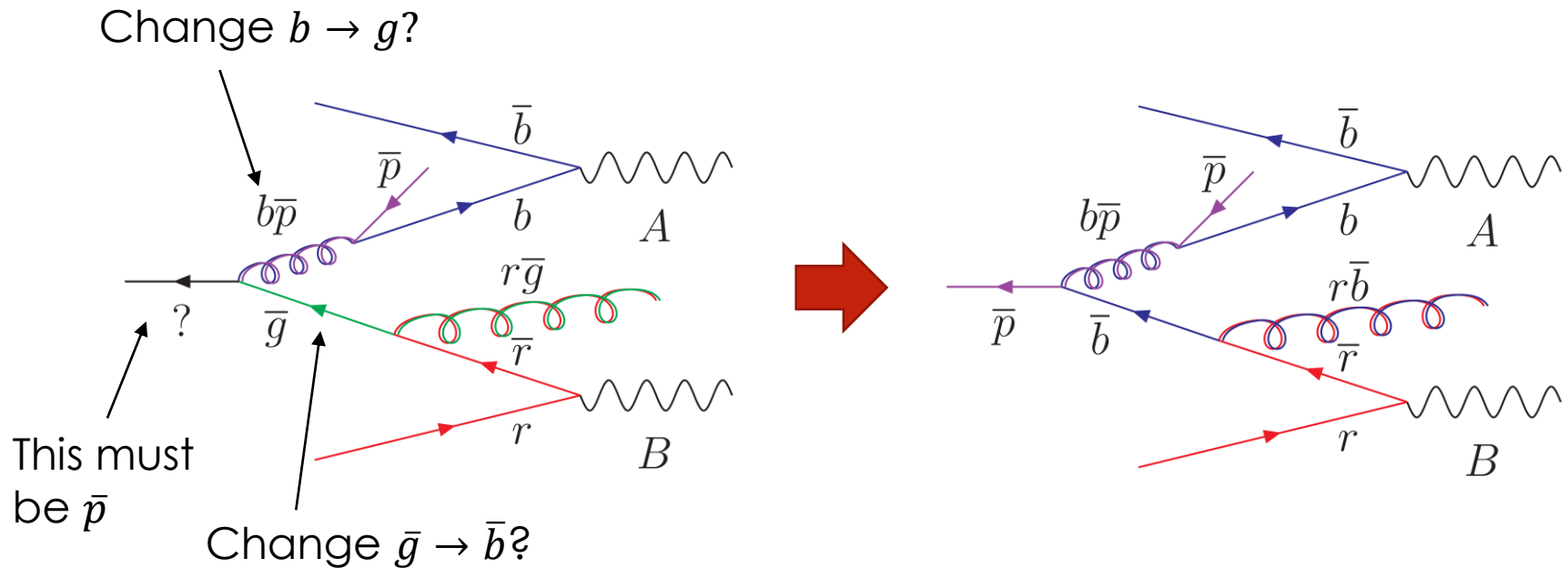

Not so important for parton-level simulation, but could be important when we add hadronisation

# COMBINING DPS AND SPS IN THE SHOWER

# IMPLEMENTATION

How do we implement this in practice?

$$\frac{d\sigma_{A+B}^{tot}}{dO} = \underbrace{\mathbf{s}_1(t_1) \otimes \left[ \frac{d\sigma_{A+B}^{SPS}}{dO} - \frac{d\sigma_{(A,B)}^{sub}}{dO} \right]}_{\text{SPS-type events ('type 1')}} + \underbrace{\int d^2\mathbf{y} \mathbf{s}_2(t_2) \otimes \frac{d\sigma_{(A,B)}^{DPS}}{dO d^2\mathbf{y}}}_{\text{DPS-type events ('type 2')}}$$

Phase space for two pieces is different.

Consider e.g. on-shell diboson production (ZZ)

$$\Phi_1 = \{Y_1, Y_2, p_T\}$$

$$\Phi_2 = \{Y_1, Y_2, \mathbf{y}\}$$

# IMPLEMENTATION

For each event type, define weight:  $w(\Phi_i) = \frac{1}{h(\Phi_i)} \frac{d\sigma_i}{d\Phi_i}$  Dimension =  $[\sigma]$

$$M_i = \max_{\Phi_i} [w(\Phi_i)]$$

$$\int h(\Phi_i) d\Phi_i = 1$$

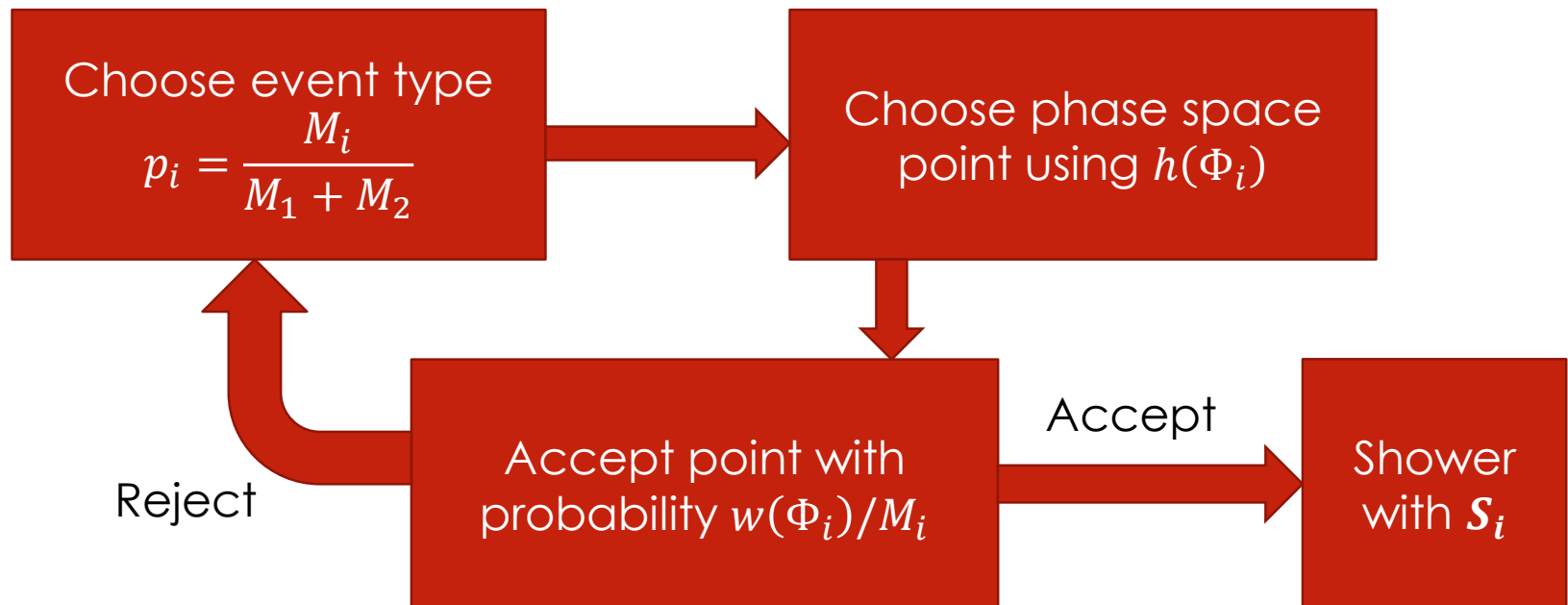

# IMPLEMENTATION

For each event type, define weight:  $w(\Phi_i) = \frac{1}{h(\Phi_i)} \frac{d\sigma_i}{d\Phi_i}$  Dimension =  $[\sigma]$

$$M_i = \max_{\Phi_i} [w(\Phi_i)]$$

$$\int h(\Phi_i) d\Phi_i = 1$$

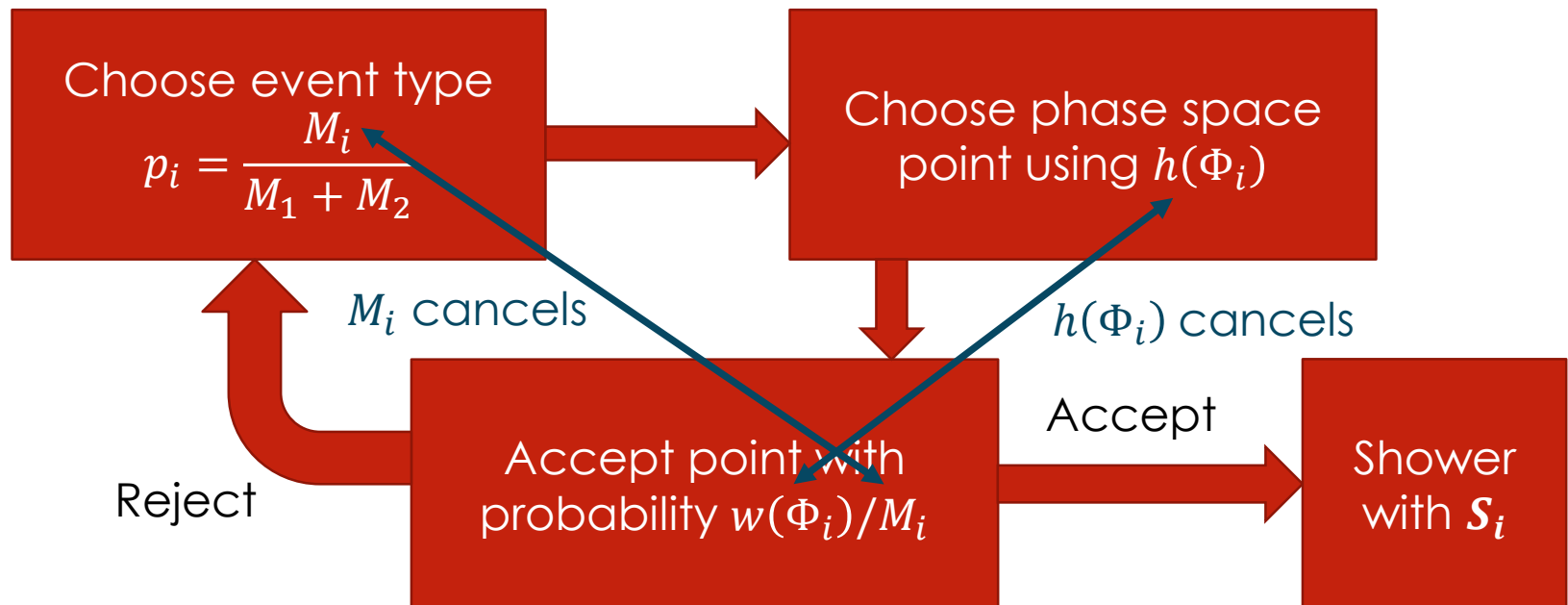

# THE SUBTRACTION: LARGE & SMALL $\gamma$

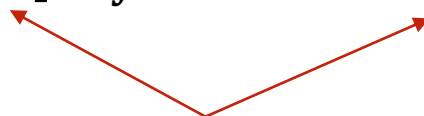
$$\frac{d\sigma_{A+B}^{tot}}{dO} = \mathbf{s}_1(t_1) \otimes \left[ \frac{d\sigma_{A+B}^{SPS}}{dO} - \frac{d\sigma_{(A,B)}^{sub}}{dO} \right] + \int d^2\mathbf{y} \mathbf{s}_2(t_2) \otimes \frac{d\sigma_{(A,B)}^{DPS}}{dO d^2\mathbf{y}}$$

If sub kinematics correctly reproduces double splitting kinematics of DPS term  $\rightarrow$  DPS & sub cancel at small  $\gamma$ , give  $d\sigma_{A+B}^{SPS}/dO$

Want sub and SPS loop-induced term to cancel at large  $\gamma$  (also differential in  $O$ ). But we don't have SPS differential in  $\gamma$ .

One thing we can look at is  $p_T$  of Z bosons – small  $p_T$  behaviour dominated by large  $\gamma$ !

# THE SUBTRACTION: LARGE & SMALL $Y$

Want sub and SPS to coincide as closely as possible at small  $p_T$  -  
constrains splitting  $p_T$  kinematics in sub & DPS terms.

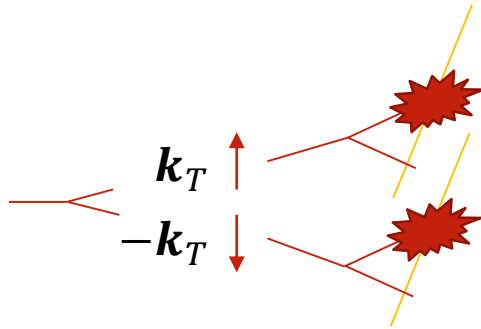

$\mathbf{k}_T$  distributed  
according to  $g(\mathbf{k}_T, y)$

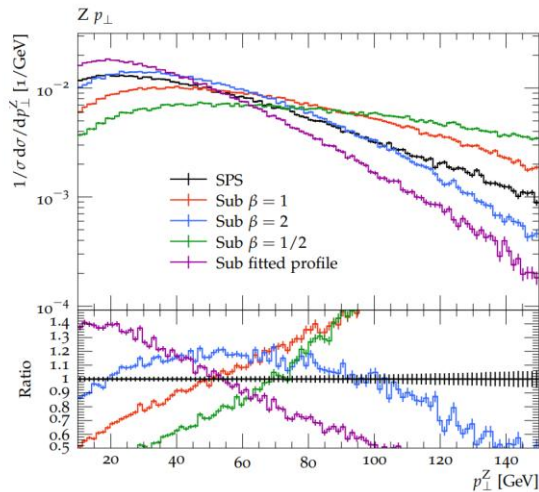

Options: (a) Gaussian  $g(\mathbf{k}_T, y)$ :

$$g(\mathbf{k}_T, y) = \frac{\beta}{\pi} y^2 \exp(-\beta y^2 k_T^2)$$

(b) 'Decreasing Gaussian'  
(more realistic)

$$g(\mathbf{k}_T, y) = \frac{1}{\pi\sqrt{2}} \frac{y}{k_T} \exp\left(-\frac{\pi}{2} y^2 k_T^2\right)$$

# DIFFERENT PROFILES

Many distributions: ~  
no difference

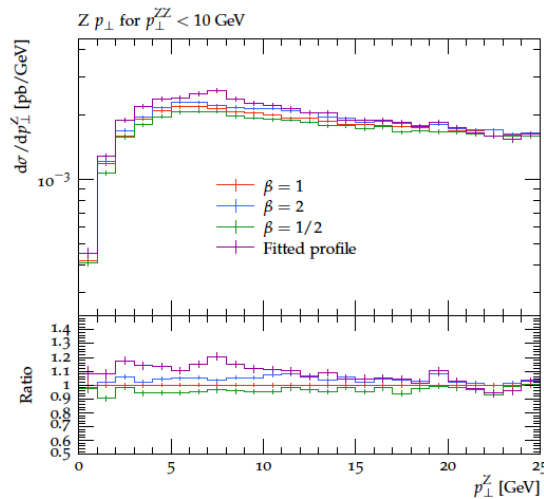
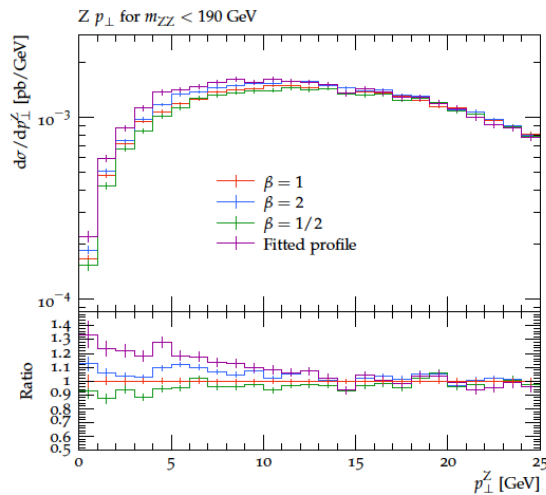
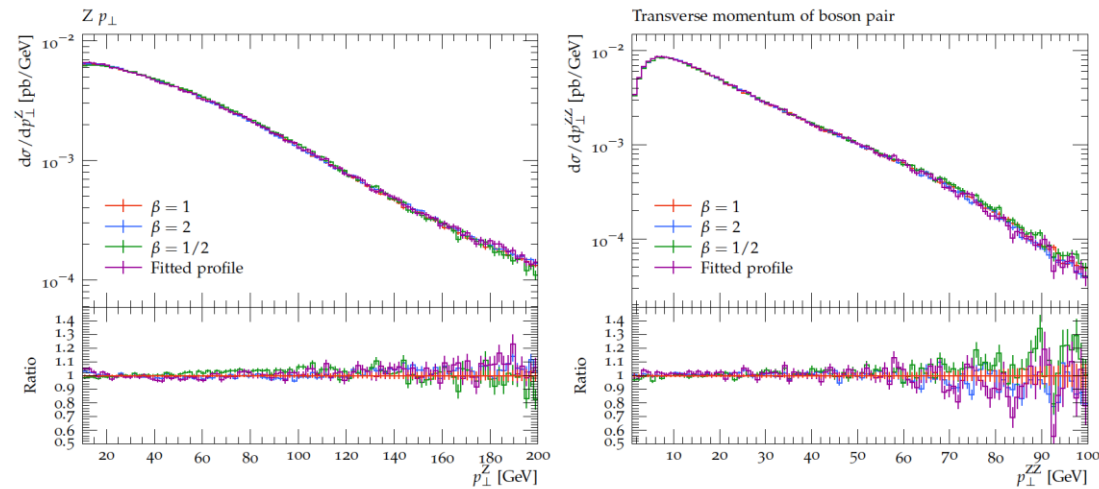

Can see some small differences focussing on region where  $p_{T^s}$  of both bosons are small



# CORRELATIONS

# CORRELATIONS

Partons in DPS can also be correlated in spin & colour.

Can have interesting effects beyond a change in rate – e.g. transverse spin correlations can cause  $\varphi$  distribution to have a non-flat shape.

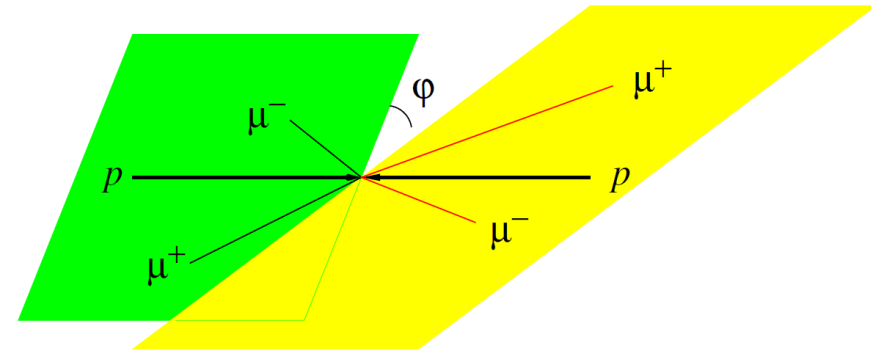

Framework for incorporating these correlations is known.

Mekhfi, Phys. Rev. D32 (1985) 2380  
 Diehl, Ostermeier and Schafer (JHEP 1203 (2012))  
 Manohar, Waalewijn, Phys.Rev. D85 (2012) 114009

How important are these effects?

# SPIN CORRELATIONS

Model and lattice results indicate spin correlations large at larger  $x$  and low scale.

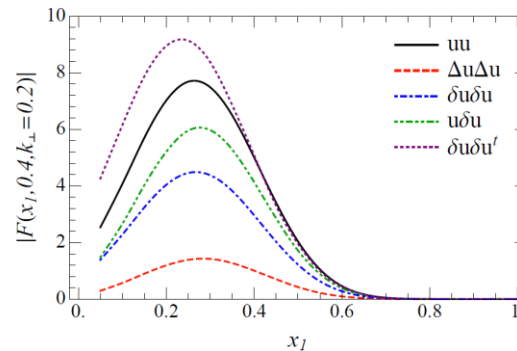

Chang, Manohar, Waalewijn,  
Phys.Rev. D87 (2013) no.3, 034009

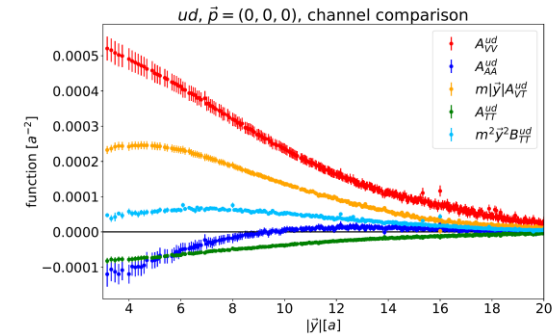

C. Zimmermann, talks at  
LATTICE2019, MPI@LHC 2019

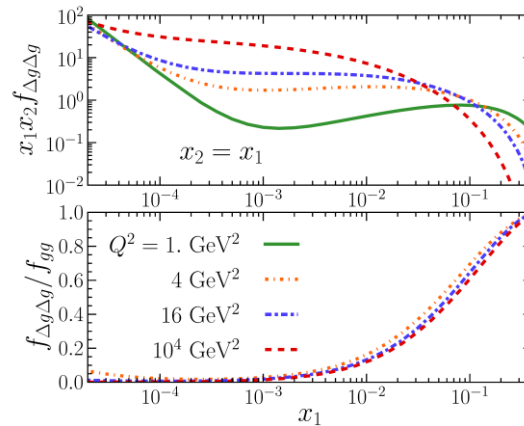
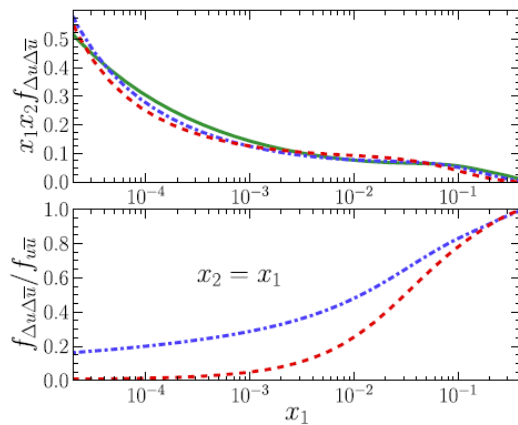

Evolution tends to wash out the correlations. Slowest at high  $x$ , and for quark channels.

Diehl, Kasemets, Keane, JHEP 1405 (2014) 118

# SPIN CORRELATIONS IN $W^\pm W^\pm$

Recently identified that **spin polarisation effects** may have a measurable effect in **same-sign  $WW$**  [Cotogno, Kasemets, Myska, Phys.Rev. D100 (2019) 1, 011503]

Good process in terms of spin polarisation:

- involves quarks.
- $W$ 's couple only to left-handed quarks

Input at 1 GeV for polarised DPD  
chosen to yield maximum  
possible effect

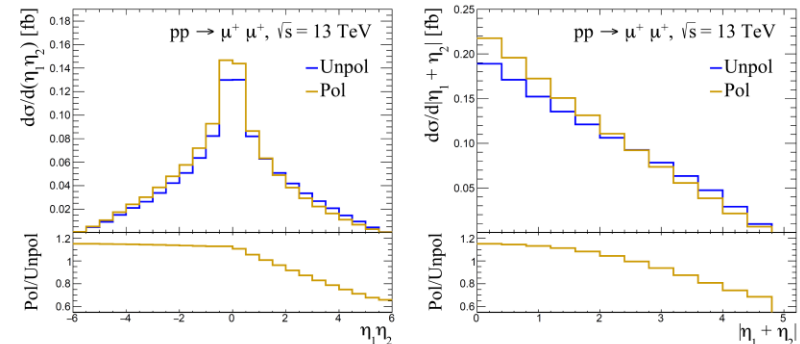

$$\mathcal{A} = \frac{l^+ - l^+}{l^+ + l^+}$$

$ \eta_i $	$> 0$	$> 0.6$	$> 1.2$
$A$	0.07	0.11	0.16
$\sigma$ [fb]	0.51	0.29	0.13

Few percent effect on lepton pseudorapidity asymmetry

# COLOUR CORRELATIONS

Colour correlations are strongly suppressed at high scales

[Technically: Sudakov suppression due to movement of colour between amplitude & conjugate by distance  $\mathbf{y}$ .]

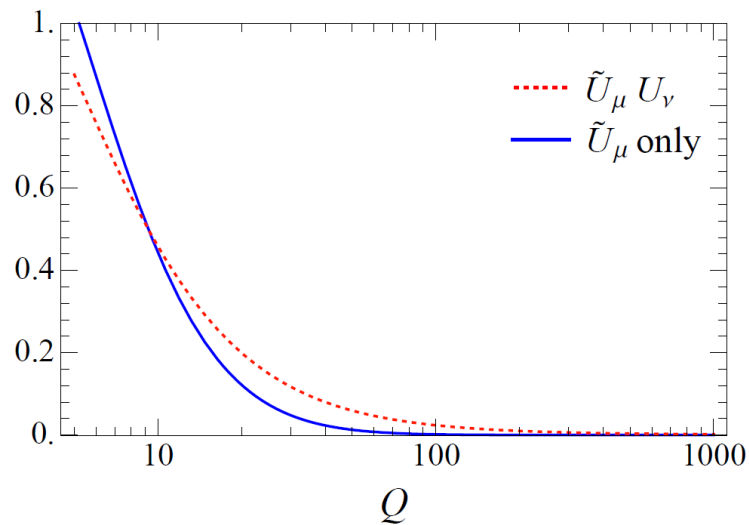

First estimate: negligible at 100 GeV, but could be relevant at moderate scales  $\sim 10$  GeV.

# DPS IN HEAVY ION COLLISIONS

# DPS IN pA COLLISIONS

For pA, **two** possible contributions to DPS:

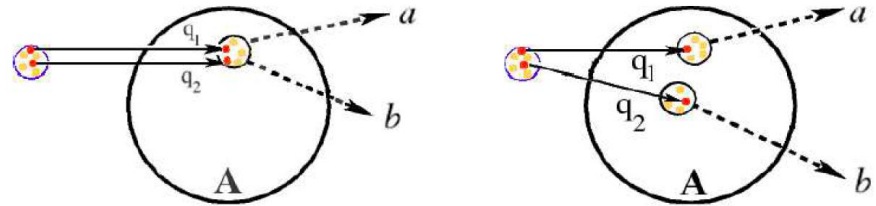

Nuclear thickness:  $T(\mathbf{B}) = \int \rho(z, \mathbf{B}) dz$

Assume this is  $\sim$  constant over size of one nucleon. Ignore nuclear matter effects.

Strikman, Treleani, Phys.Rev.Lett. 88 (2002) 031801

$$\sigma_{pA, I}^{\text{DPS}} = \frac{m}{2} \int F(x_1, x_2, \mathbf{y}) F(x'_1, x'_2, \mathbf{y}) \hat{\sigma}_a \hat{\sigma}_b dx_i dx'_i d^2 \mathbf{y} \int d^2 \mathbf{B} T(\mathbf{B}) = A \sigma_{pp}^{\text{DPS}}$$

Probes L + T correlations in the same way as pp DPS

$$\sigma_{pA, II}^{\text{DPS}} = \frac{m}{2} \frac{A-1}{A} \int f(x'_1) f(x'_2) \left[ \int F(x_1, x_2, \mathbf{y}) d^2 \mathbf{y} \right] \hat{\sigma}_a \hat{\sigma}_b dx_i dx'_i \int d^2 \mathbf{B} T^2(\mathbf{B})$$

Probes longitudinal correlations of **one DPD only**

**II contribution in pA probes DPDs in a different way to pp DPS.**

# DPS IN pA COLLISIONS

Common simplified ansatz (neglect correlations):  $F(x_1, x_2, \mathbf{y}) \rightarrow f(x_1) f(x_2) G(\mathbf{y})$

Then:  $\sigma_I^{\text{DPS}} = A \frac{m}{2} \frac{\sigma_a \sigma_b}{\sigma_{eff}} = A \sigma_{pp}^{\text{DPS}}$

$$\sigma^{\text{SPS}} = A \sigma_{pp}^{\text{SPS}}$$

$$\sigma_{II}^{\text{DPS}} = \frac{m}{2} \frac{A-1}{A} \sigma_a \sigma_b \int d^2 \mathbf{B} T^2(\mathbf{B})$$

If nucleus is sphere of constant density,  $\frac{\sigma_{II}^{\text{DPS}}}{\sigma_{\text{SPS}}^{\text{DPS}}} \propto A^{\frac{1}{3}}$ . **Relative importance of DPS grows with  $A$  in pA.**

$\frac{\sigma_{II}^{\text{DPS}}}{\sigma_I^{\text{DPS}}} \sim 2$  at large  $A$ , **two contributions comparable.**

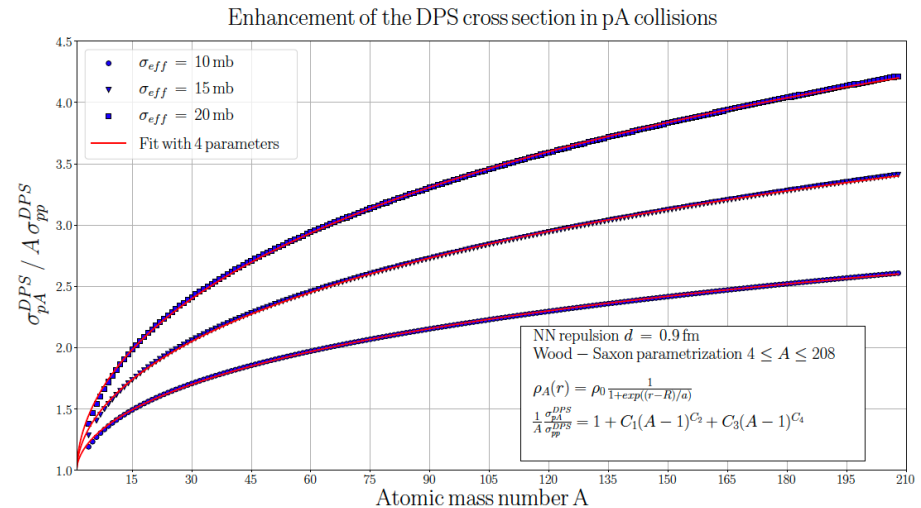



# DPS IN AA COLLISIONS

For AA collisions, three contributions to DPS:

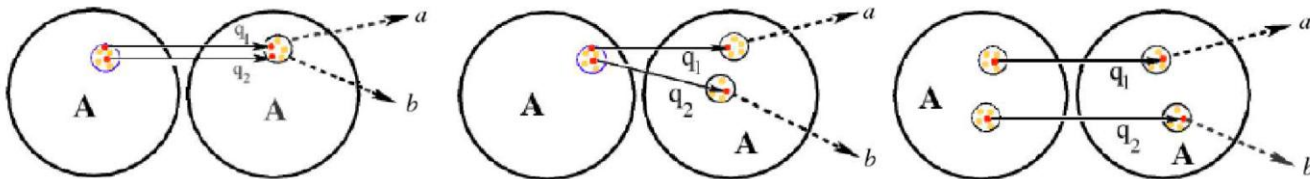

$$\sigma_{AA,I}^{\text{DPS}} = A^2 \sigma_{pp}^{\text{DPS}}$$

$$\sigma_{AA,II}^{\text{DPS}} = 2A \sigma_{pA}^{\text{DPS}}$$

$$\sigma_{AA,III}^{\text{DPS}} = \frac{m}{2} \left( \frac{A-1}{A} \right)^2 \sigma_a \sigma_b$$

$$\times \int T(\mathbf{b}_1) T(\mathbf{b}_2) T(\mathbf{b}_1 - \mathbf{B}) T(\mathbf{b}_2 - \mathbf{B}) d^2 \mathbf{b}_1 d^2 \mathbf{b}_2 d^2 \mathbf{B}$$

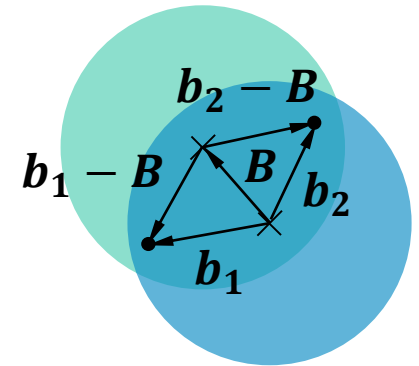

This contribution corresponds to **double nucleon-nucleon scattering** – doesn't probe parton-parton correlations.

# DPS IN AA COLLISIONS

Relative size of three contributions? Rough estimate using hard sphere nucleus & large A:

$$\sigma_{AA}^{DPS} \approx A^2 \sigma_{pp}^{DPS} \left[ \overset{\boxed{\text{I}}}{1} + \overset{\boxed{\text{II}}}{\frac{2}{\pi} A^{1/3}} + \overset{\boxed{\text{III}}}{\frac{1}{2\pi} A^{4/3}} \right]$$

Term III grows much faster than the other two, dominates other two for reasonably large A:

A = 40 (Ca):	I: II: III = 1: 2.3: 23	87% is term III
A = 208 (Pb):	I: II: III = 1: 4: 200	97.5% is term III

d'Enterria, Snigirev, *Phys.Lett.B* 727 (2013) 157-162, *Adv.Ser.Direct.High Energy Phys.* 29 (2018) 159-187

**In AA collisions, DPS is dominated by double nucleon-nucleon scattering**