



Sizing and Desizing of Glass and Ceramic Materials at CERN

Javier Osuna

30 October 2024

Acknowledgements

- **Materials Testing:**
 - P.A Contat, F.O. Pincot, D. Polvani, J.S. Rigaud C. Urscheler, B. Verma
- **Preparation of Samples, Parts and Equipment:**
 - A. Benfkih, S. Clément, P.O. Coste, D. Cote, B. Fornes, G. Maury, N. Peray, R. Perdrix, P.A. Rizzo
- **General Guidance:**
 - R. Piccin, C. Scheuerlein, B. Teissandier, D. Tommasini, A. Brem, A. Devred

Outline

- **Context/Motivation**
- **Desizing for Insulation Robustness**
- **Further Work**

Context/Motivation

Sizings on Continuous Filaments

The sizing on continuous filaments has a number of uses, such as:

- Lubrication
- Antistatic Agent
- Improved Wetting for Impregnation
- Coupling Agent for Fibre-Matrix Interface

This means that there may be **multiple components** in the sizing of a particular fibre. Furthermore, the exact composition is a trade-secret.



Image from Roy, S. S. *et al.* Braiding Ultrathin Layer for Insulation of Superconducting Rutherford Cables (2018) ([sagepub.com](https://www.sagepub.com))

In the S2-Glass insulation of Nb₃Sn magnets at CERN, **three different fibre sizings are currently used.**

These are chosen depending on **location and function** of the insulation.

AGY S-2 Glass Sizings Components (Data and Confidence Levels from S. Gayot CERN Report) - EDMS 1828310

| AGY SIZING REFERENCE | COUPLING AGENT | LUBRICANT | FILM FORMER |
|----------------------|-----------------|--------------------------------------|----------------------|
| 636 (Starch-Oil) | None (by logic) | Vegetal Oil (Possibly Triglycerides) | Starch or Derivative |
| 933 (Inorganic) | Aminosilanes | Polypropylene Glycol (PPG) | Aliphatic Polyurea |
| 493 (Resin) | Aminosilanes | Vegetal Oil (Possibly Triglycerides) | Bisphenol-A Epoxy |

Analysis performed using FTIR, SEM, XPS and Colorimetry



- Medium Confidence



- High Confidence

HFM WP4.3: Insulation Materials for Magnet Coils and Conductors

The cable and conductors in the HFM magnets should contain a **robust** electrical insulation. →

- The currently applied route for Nb₃Sn coil manufacturing is **Wind and React**.
- The insulation materials within the coil pack (e.g. cable, interlayer) must undergo a **650°C heat treatment in argon**.
- Polyimide has been replaced by an S2-Glass braid, which is later impregnated with CTD101K.
- The S-2 Glass fibre braid:
 - Provides a continuous **conductor spacing**.
 - **Facilitates impregnation** by wetting phenomena.
 - **Limits crack propagation** in resin.
- The CTD101K Epoxy Resin:
 - Confers a **rigid shape** to the coil during manufacturing.
 - Provides a high **dielectric strength** (>100kV/mm) to the turn-to-turn insulation

| Challenge | Example | Ref. |
|--|---|------|
| High Voltage | 900V Coil to Ground during quenches | [1] |
| Thermal Cycles | 1.9K, 300K | [2] |
| Radiation Environment | ~25MGy for quadrupoles in Inner Triplet (IT) Region | [3] |
| Nb₃Sn Reaction Cycle | 665°C for 50h in Argon | [2] |
| Mechanical Loads | Up to 200MPa Pre-Stress | [2] |
| Braiding | Yarns should not break or undergo filamentation | [4] |

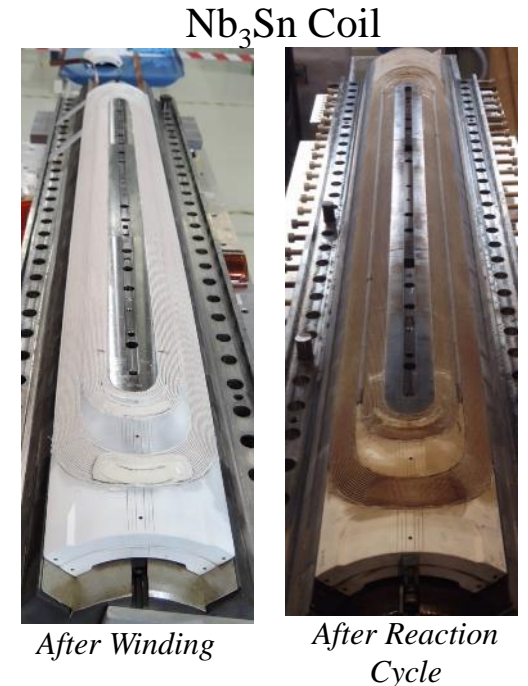

Courtesy of G. Campagna

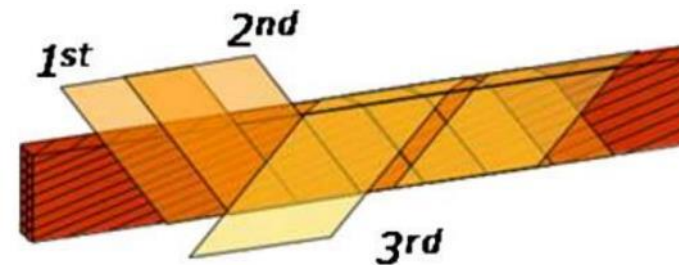

Polyimide Insulation Scheme Applied for Nb-Ti Cables in the LHC



Nb₃Sn (Precursor) Cable Insulation being Braided

Table References:

- [1] Ambrosio, G. *et al.* MQXFA Electrical Design Criteria (2020) (fnal.gov)
- [2] Ambrosio, G. *et al.* MQXFA FInal Design Report (2022) [CERN Document Server](https://cern.ch/cern-document-server)
- [3] Polinski, J. *et al.* Certification of the Radiation Resistance of Coil Insulation Material (2014) [EuCARD](https://euCARD)
- [4] Roy, S. S. *et al.* Braiding Ultrathin Layer for Insulation of Superconducting Rutherford Cables (2018) (sagepub.com)

Fessia *et al.* Electrical and Mechanical Performance of an Enhanced Cable Insulation Scheme for Superconducting Magnets (2010)

P. Ferracin, *et al.*, "QXF cable insulation at CERN." Joint LARP/CM20 HiLumi meeting Napa Valley, CA, USA, April 2013.

Nb₃Sn Reaction Cycle Effects on Fibre Mechanical Properties

Tensile Tests on Fibres Only

Flexural Tests on Fibres + CTD101K

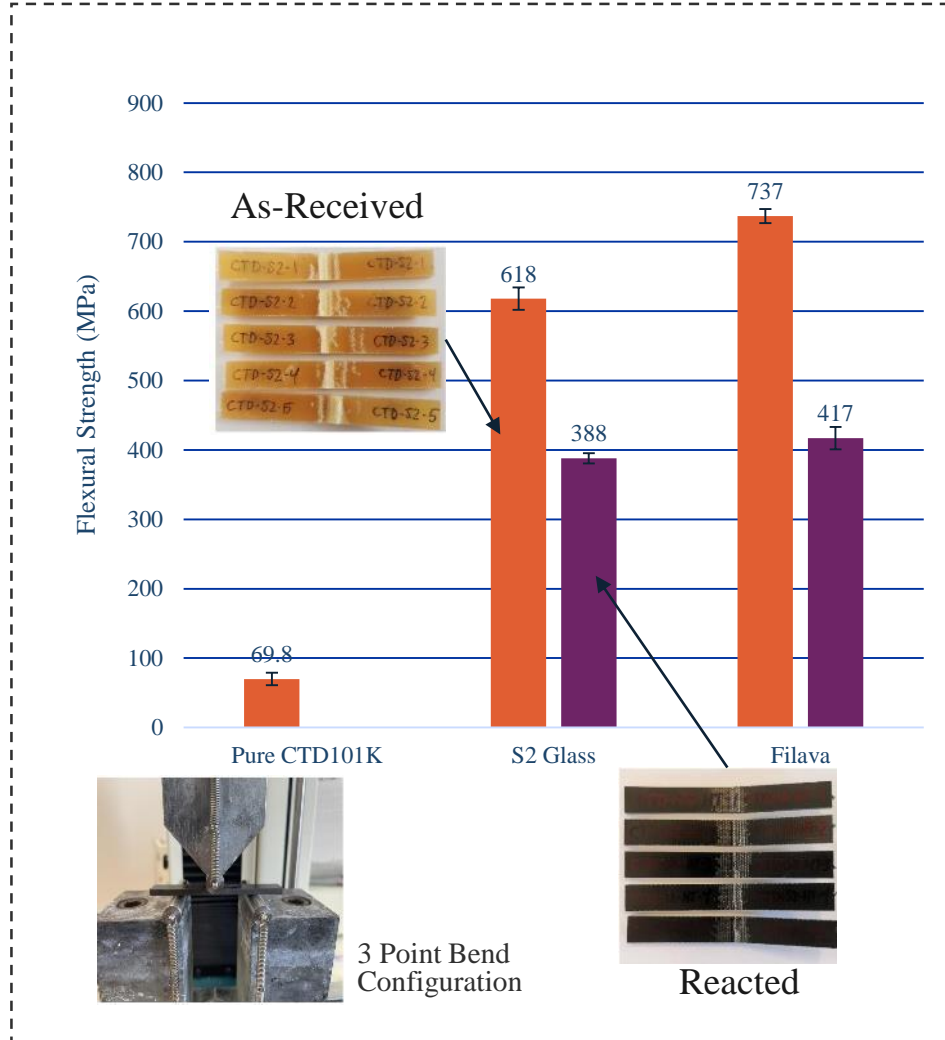
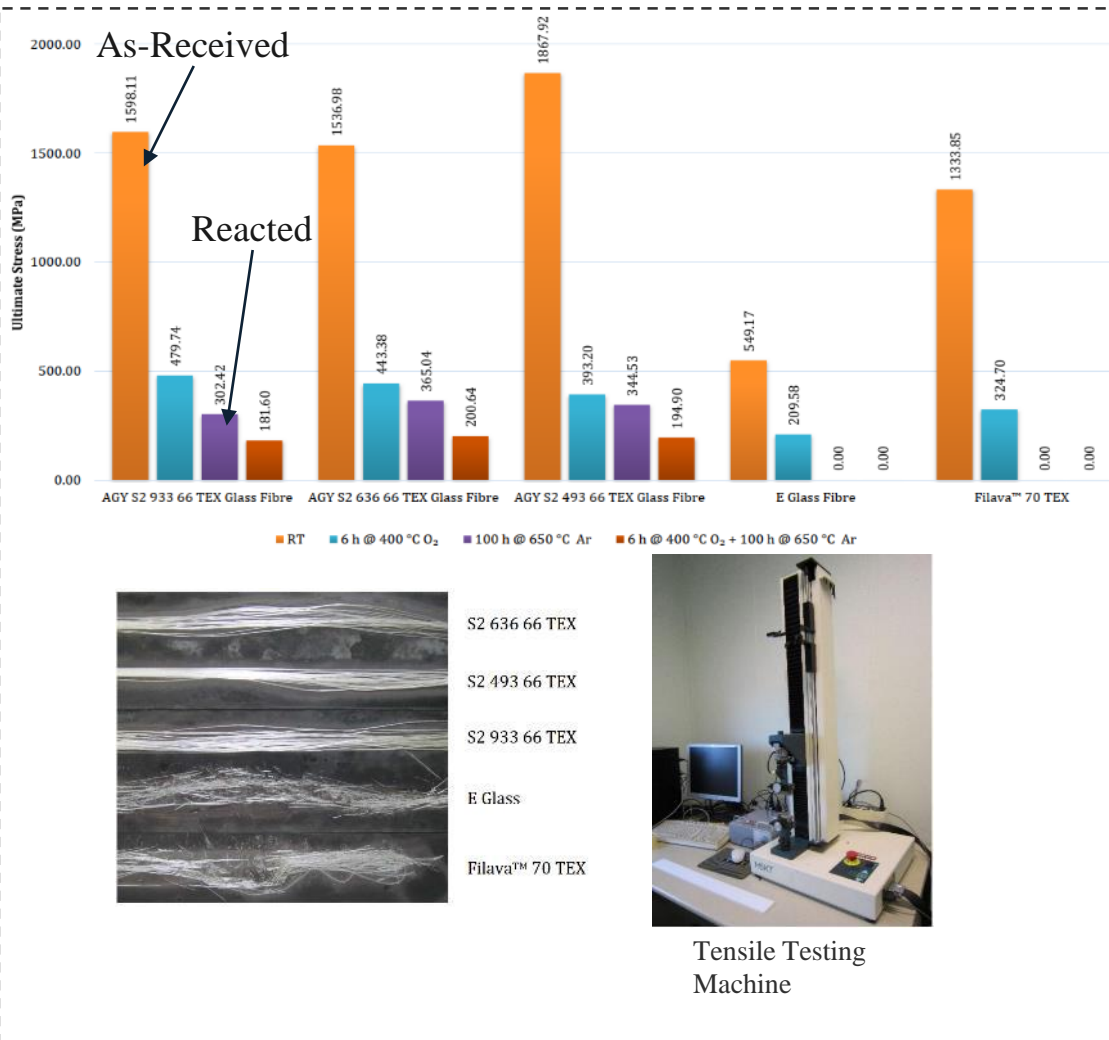

- The Reaction Cycle in Argon appears to deteriorate the mechanical properties of the insulation materials.
- Research on alternative fibres was started by C. Urscheler, including on:



Basalt



Quartzel

M.G. Lopes - Glass Fiber / Binder Characterization – TE-MSc 2014 - EDMS 1405346

C. Scheuerlein, MQXF interlayer mechanical properties – TE-MSc 2022 - EDMS 2735359

Nb₃Sn Reaction Cycle Effects on Electrical Properties of Insulation Materials



Osuna, J. *Influence of 650°C Thermal Cycle on the Dielectric Strength of CTD101K Epoxy Resin Laminates*, EDMS 3004067 (2023)

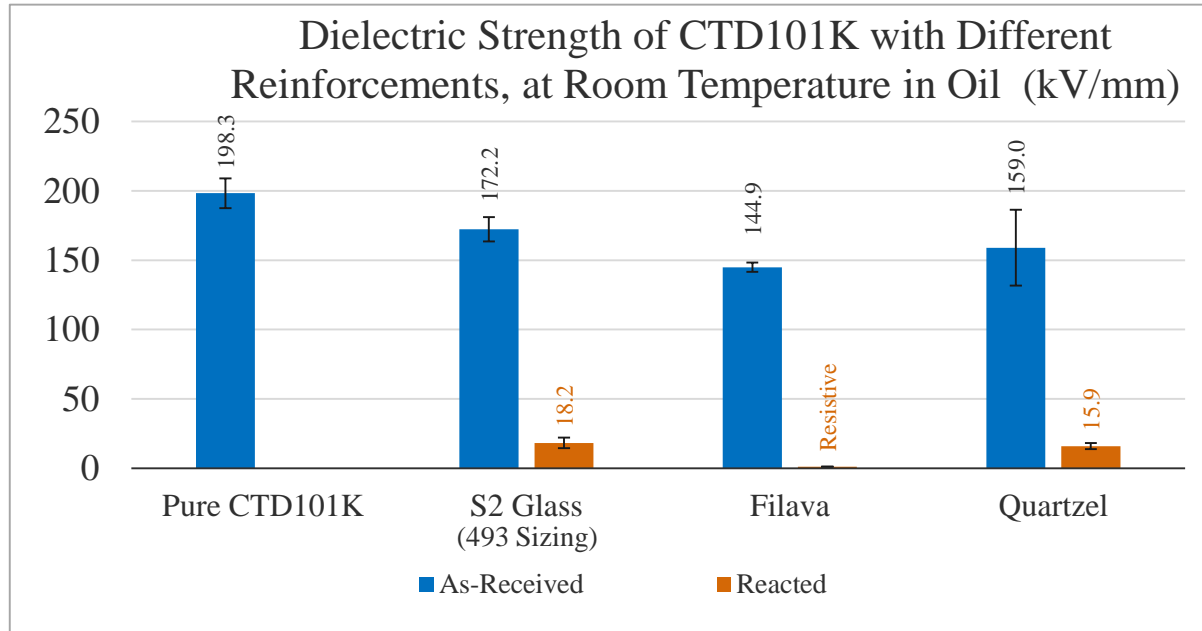

Nb₃Sn Precursor Cable Insulated with S-2 Glass Before (Left) and After (Right) Nb₃Sn Reaction Cycle (Courtesy of C. Urscheler)

- It is believed that the reaction cycle produces **conductive residue** on fibres due to pyrolysis of the fibres' **organic sizing** in the absence of oxygen.
- In the case of S-2 Glass composite, this conductive residue affects the insulating properties of the composite dramatically.
- Similar effects have been observed for Quartz and Basalt fibre composites.

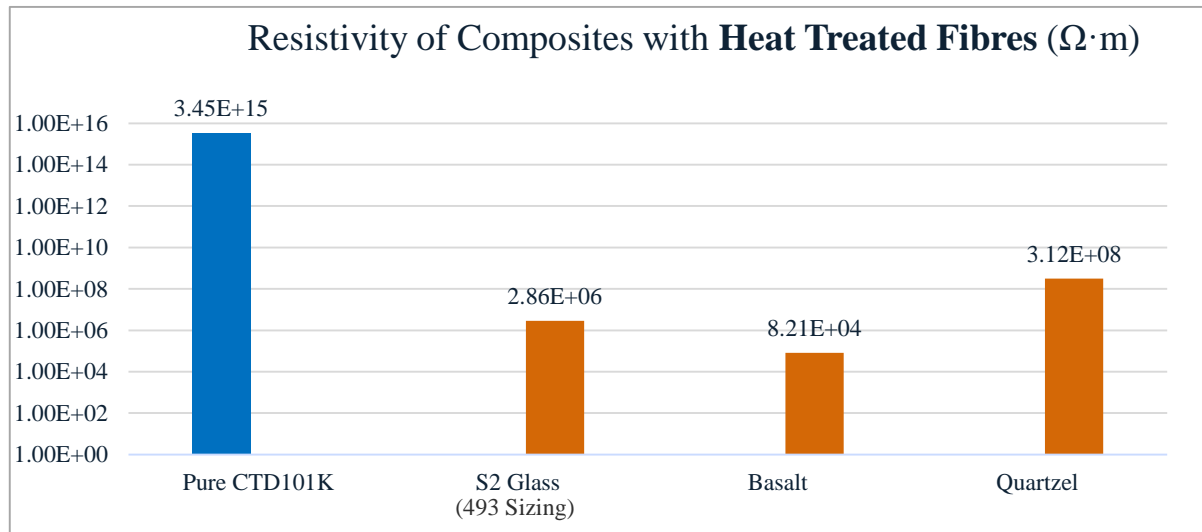

picoammeter

A

ELECTRODE

SAMPLE

ELECTRODE

500V DC

Nb₃Sn Reaction Cycle Effects on Electrical Properties of Insulation Materials

Turn-to-Turn Electrical Tests on 10-Stacks with MQXF Cable (S2 Glass, 933 Sizing)

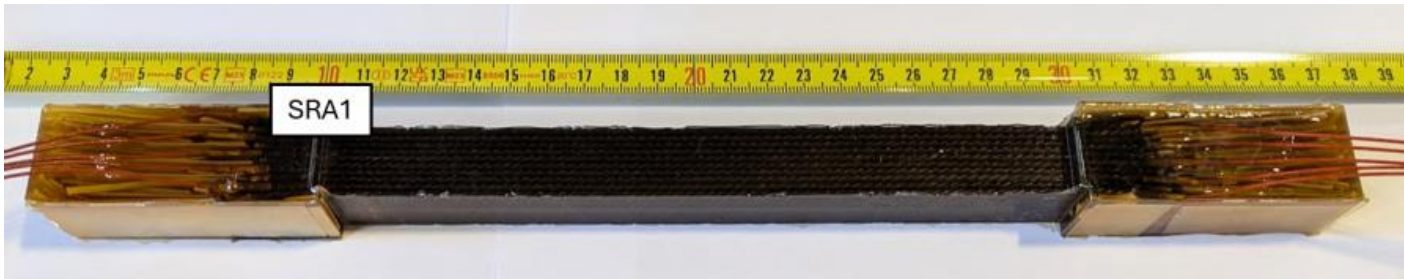
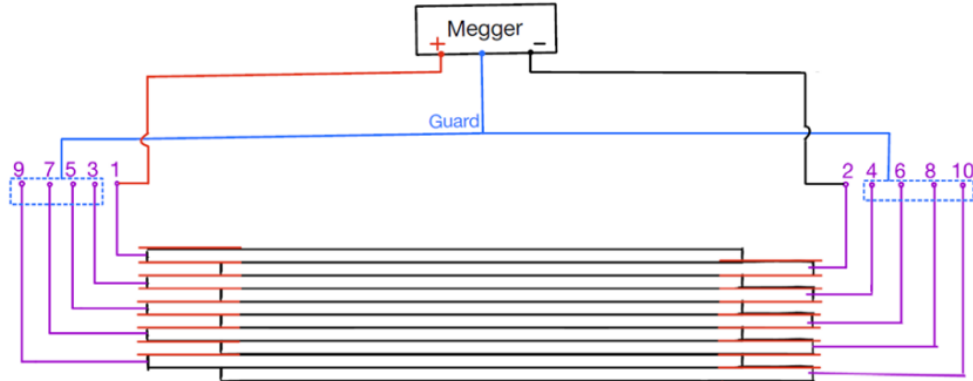

- These effects were also confirmed when testing turn-to-turn insulation of a 10-stack of cables, which is a more representative set-up of magnet coil geometry.

| Test Date and Conditions | Room Temperature 09/09/2024 23°C, 61% RH | | | | |
|--------------------------|--|----------------|-----------------|-------------|-------------------|
| | Turn n, Turn n | IR (MΩ) (30 s) | IR (MΩ) (300 s) | PI | Test Voltage (kV) |
| SRA1-CTD101K | 1,2 | 39 | 45 | 1.15 | 0.5 |
| | 2,3 | 23 | 24.2 | 1.05 | 0.5 |
| | 3,4 | 25 | 25 | 1.00 | 0.5 |
| | 4,5 | 21 | 23 | 1.10 | 0.5 |
| | 5,6 | 40.8 | 47.1 | 1.15 | 0.5 |
| | 6,7 | 40.6 | 46 | 1.13 | 0.5 |
| | 7,8 | 51.3 | 54 | 1.05 | 0.5 |
| | 8,9 | 35.2 | 40.1 | 1.14 | 0.5 |
| | 9,10 | 66.6 | 70.9 | 1.06 | 0.5 |
| | Coil-Ground | 62.3 | 140 | 2.25 | 0.5 |
| AVERAGE | 38.06 | 41.70 | 1.09 | 0.5 | |
| STD DEV | 14.58 | 15.81 | 0.05 | 0.00 | |

Polvani, D. *Towards Novel Electrical Insulation Systems for Nb₃Sn High Field Magnets*, EDMS 3168202 (2024)

Desizing for Insulation Robustness

Desizing in the Literature (Electrical Properties)

Desizing is reported to allow the fibres to largely retain their insulating properties following the thermal cycle.

Dielectric Tests on 0.4mm-thick Laminates with DGEBF Epoxy Resin + DETDA Curing Agent – Canfer *et al.*

TABLE 2: Results of electrical breakdown test to BS7831

| Fabric | Heat treatment | Colour of laminate | Breakdown voltage kV/mm |
|---------|---------------------------|--------------------|----------------------------|
| S glass | Desized + 660°C vacuum | White | >30 |
| S glass | 660°C vacuum | Dark grey | 2.5 |

Canfer, S.J. (2006) ‘Insulation development for the next European dipole’, AIP Conference Proceedings [Preprint]. doi:10.1063/1.2192364

Dielectric Tests on Desized Fibre Laminates – Devred *et al.*

| System Reinforcement | Denomination | Elementary Wrapping Pattern ^a | Fiber Content (vol%) |
|---------------------------------------|--------------|--|----------------------|
| E-glass fiber tape | EE | 2 layers of E-glass fiber tape wrapped with a 50% overlap | 39 |
| S2-glass fiber tape | SS | 2 layers of S2-glass fiber tape wrapped with a 50% overlap | 41 |
| E-glass fiber tape + Mica-glass foil | EM | 2 layers of E-glass fiber tape butt-wrapped with 1 mica-glass foil | |
| S2-glass fiber tape + Mica-glass foil | SM | 2 layers of S2-glass tape butt-wrapped with 1 mica-glass foil | |
| Standard quartz fiber tape | QS | 2 layers of standard quartz fiber tape wrapped with a 50% overlap | 31 |
| Chrome-oxide-coated quartz fiber tape | QH | 2 layers of COC quartz fiber tape wrapped with a 50% overlap | 30 |

^a Representative of the turn-to-turn insulation in a magnet coil.

Table 3. Breakdown voltages of various samples of insulation systems measured in oil at room temperature.

| Denomination | Heat Treatment at 660 °C | Sample Thickness (mm) | Breakdown Voltage (kV) | Breakdown Voltage per Unit Length (kV/mm) |
|--------------|--------------------------|-----------------------|------------------------|---|
| EE | No | 0.40 | 12.5±1.5 | 31 |
| EE | Yes | 0.44 | 15.8±1.1 | 36 |
| SS | No | 0.38 | 14.5±1.0 | 38 |
| SS | Yes | 0.35 | 16.0±0.5 | 45 |
| EM | No | 0.35 | 16.0±1.0 | 46 |
| EM | Yes | 0.40 | 16.2±1.0 | 41 |
| SM | No | 0.30 | 15.5±0.5 | 52 |
| SM | Yes | 0.29 | 17.2±0.5 | 59 |
| QS | No | 0.25 | 12.6±0.5 | 51 |
| QS | Yes | 0.24 | 13.2±1.1 | 55 |
| QH | No | 0.25 | 13.6±0.9 | 54 |
| QH | Yes | 0.26 | 13.2±0.8 | 51 |

The epoxy resin used for the vacuum impregnation was a diglycidylether of bisphenol A, mixed with cresylglycidylether as reactive diluent and phthalic and hexahydrophthalic anhydrides as curing agents. The applied curing cycle was 12 hours at 95 °C followed by 48 hours at 110 °C. This epoxy resin has been studied elsewhere,¹⁰ and its measured density at room temperature is 1.221 g/cm³.

Devred, A *et al.* (2000). *Insulation Systems for NB3SN Accelerator Magnet Coils Fabricated by the “Wind and React” Technique*. In: Balachandran, U.B., Hartwig, K.T., Gubser, D.U., Bardos, V.A. (eds) *Advances in Cryogenic Engineering Materials*. Springer, Boston, MA. https://doi.org/10.1007/978-1-4615-4293-3_18

Desizing in the Literature

(Applicability for W&R Nb₃Sn Magnets)

KEK - Toshiba Small-Scale Nb₃Sn Dipole (1980)

Heat Cleaning E-Glass air at 300°C for 24h

The heat-treatment was divided into two stages. The first was a preliminary heating for evaporating a material which coated the E glass fibers. This heating was done in air at 300°C for 24 hours.

The second was a heat-treatment for formation of Nb₃Sn. This heat-treatment was carried out at 700°C for 70 hours and argon gas was flown through the furnace during this process.

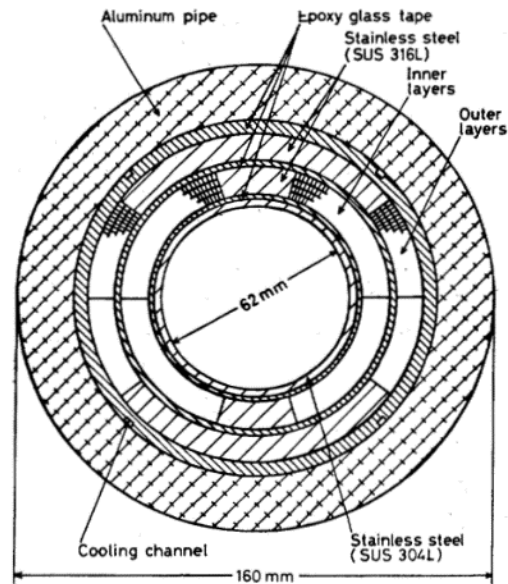

Fig. 2 Cross-sectional view of the magnet

K. Ishibashi, M. Koizumi, K. Hosoyama, M. Kobayashi and T. Horigami, "Nb₃Sn dipole magnet by wind and react process," in IEEE Transactions on Magnetics, vol. 17, no. 1, pp. 428-431, January 1981, doi: 10.1109/TMAG.1981.1061080

CERN-ELIN Nb₃Sn Dipole Model (1989)

Heat-cleaning mica-glass insulation by firing dry air at 600C for 30 minutes

At last solutions to problems related to the Nb₃Sn cable insulation and reaction are briefly mentioned: The optimum reaction temperature versus time has been furnished by the cable manufacturer; an intermediate, relatively short insulation heat treatment step had to be added in order to eliminate the organic part of the insulation. This has been successfully implemented after adequate technological development. It has further been ascertained, that the cable superconductive performance, its copper part resistivity at ambient temperature and at 4.2 K had not been modified by the treatment of the insulation.



Fig. 4.12 End view of a reacted coil inner layer. (Courtesy of ELIN, Austria)

S. Wenger, F. Zerobin and A. Asner, "Towards a 1 m high field Nb/sub 3/Sn dipole magnet of the ELIN-CERN collaboration for the LHC-project-development and technological aspects," in IEEE Transactions on Magnetics, vol. 25, no. 2, pp. 1636-1639, March 1989, doi: 10.1109/20.92613

Perin, R. (2019). CERN-ELIN Nb₃Sn Dipole Model. In: Schoerling, D., Zlobin, A. (eds) Nb₃Sn Accelerator Magnets. Particle Acceleration and Detection. Springer, Cham. https://doi.org/10.1007/978-3-030-16118-7_4

UT-CERN Cos-theta LHC-Type Nb₃Sn Dipole Magnet (1991)

Heat-cleaning glass insulation by heat treating in air 300°C

as shown in Fig. 5.10. The wrapped glass ribbon holds the glass-mica tape in position, improves epoxy penetration into the cable and winding pack, enhances the shear strength between adjacent conductors, and therefore increases the effective thermal conductivity of the insulation layer at 4.4 K by at least a factor of 2. Before applying the Rutherford cable, the S2-glass tape was heat-treated in air at 300 °C to minimize carbon residuals in the coils during the high-temperature reaction heat treatment.

Fig. 5.11 Coil fabrication: (a) coil end after winding; (b) coil end after reaction heat treatment

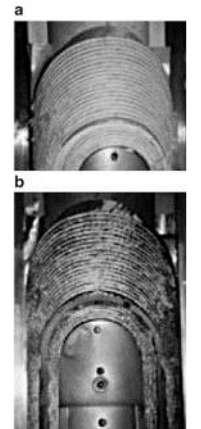

Schoerling, D., Zlobin, A. (eds) Nb₃Sn Accelerator Magnets. Particle Acceleration and Detection. Springer, Cham. https://doi.org/10.1007/978-3-030-16118-7_4

Desizing in the Literature

(Applicability for W&R Nb₃Sn Magnets)

LBNL Cos-theta Nb₃Sn Dipole Magnet D20 (1990s)

Heat-cleaning and resizing with palmitic acid

The sizing used by the manufacturer left a heavy residue of carbon after reaction in an argon atmosphere. Removal of the sizing with a partial atmosphere of oxygen has been previously used in W&R Nb₃Sn magnets. This approach was, however, abandoned due to problems with oxidation of the copper matrix and incomplete carbon removal in less accessible areas of the coils. Instead, the sizing was removed by pre-heating, and replaced with palmitic acid, which volatilizes in argon below 400 °C and did not leave a heavy carbon residue. A high gas flow through the coils was, however, needed to flush it from the coils. The palmitic acid was applied by dip-coating the sleeve through a solution of 1 part palmitic acid to 20 parts ethanol by weight. After dip-coating, the sleeve was passed through a drying tower to evaporate the ethanol.



Fig. 6.9 Layer 2 return end before reaction (end spacers coated)



Fig. 6.10 Prototype coil with tape insulation added (note the carbon residue)

Schoerling, D., Zlobin, A. (eds) Nb₃Sn Accelerator Magnets. Particle Acceleration and Detection. Springer, Cham. https://doi.org/10.1007/978-3-030-16118-7_4

PSI (2024)

Heat Cleaning S2 Glass using Oxygen Pulses
(Chemical Desizing also applied in BOX Tests)



Fig. 4. Images of Rutherford cables after the RHT, with and without the introduction of oxygen.

TABLE I
RRR_{292/18} MEASUREMENTS

| sample | RRR | reduction in % |
|---------------|-----|----------------|
| reference | 532 | - |
| 250 °C-400 °C | 521 | 2 |
| 665 °C vacuum | 443 | 16 |

A. Brem et al., "From Hot to Cold: Advanced Materials and Processes for Nb₃Sn Based Magnets," in IEEE Transactions on Applied Superconductivity, vol. 34, no. 5, pp. 1-5, Aug. 2024, Art no. 7700105, doi: 10.1109/TASC.2023.3338588.

Recent Desizing at CERN

- The sizing on the fibres is fundamental to the braiding process. If the insulation is de-sized, the yarns will undergo filamentation and possibly break.

- Therefore, the desizing process seems only feasible **after braiding**.

- Three strategies currently being investigated:

1. Thermal Desizing

- Injection of Air during coil reaction

2. Plasma Desizing

- In-line plasma treatment during winding

3. Chemical Washing

- In-line washing during spooling
- Rinsing of wound coil

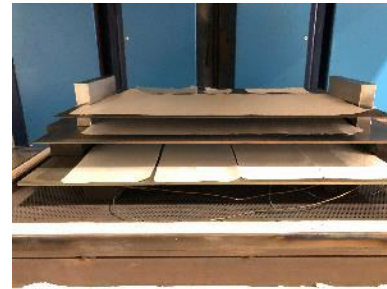

Plasma/Chemical Desizing →

Thermal/Chemical Desizing →

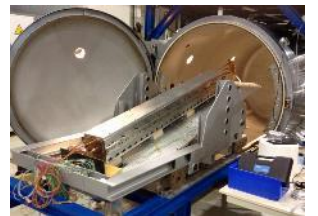
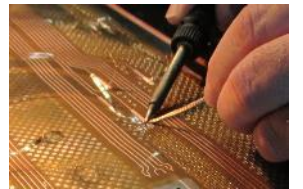
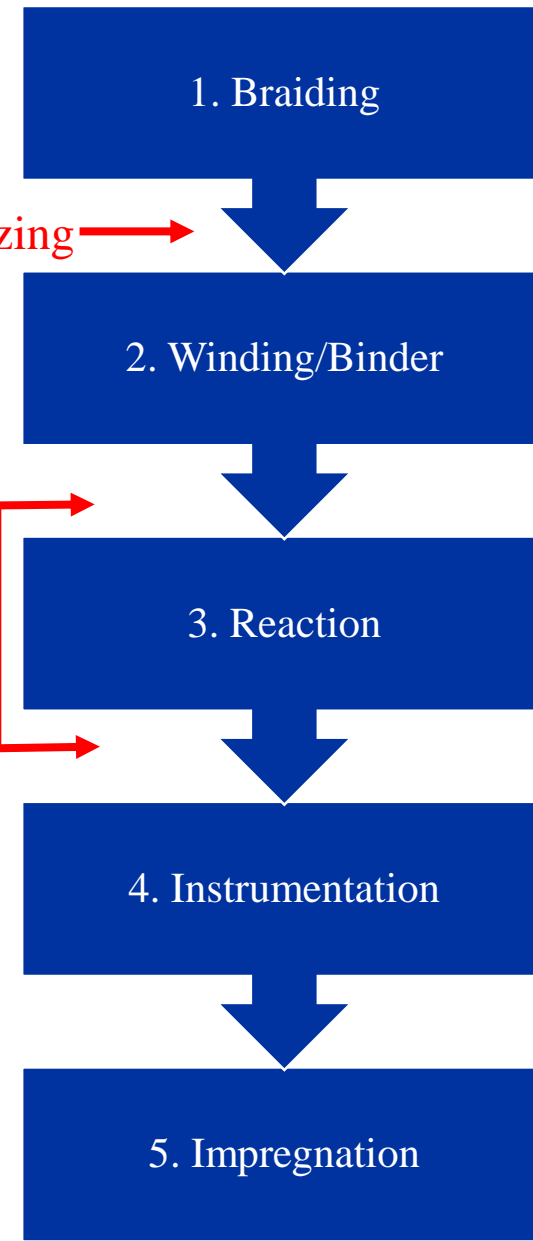

Images Courtesy of G. Campagna and P. Ferracin

Assessment of Desizing Effectiveness

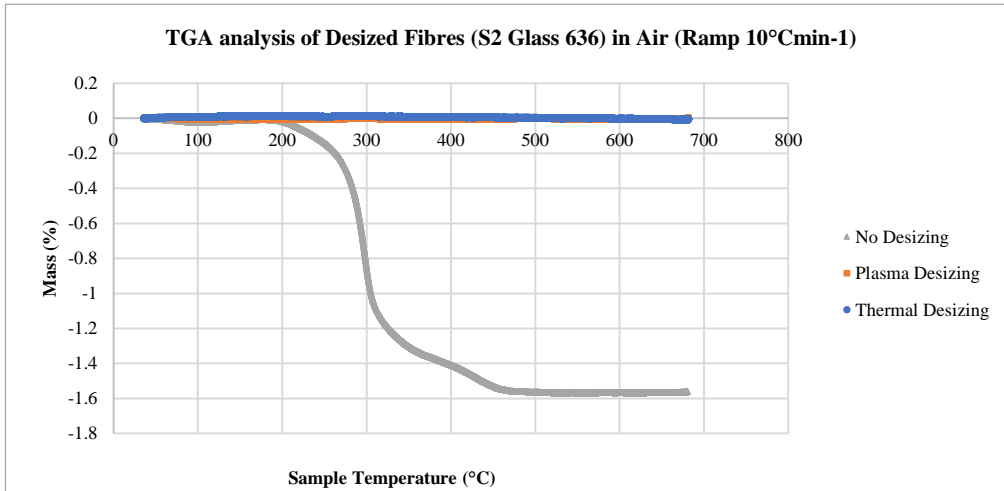

1. Thermogravimetry

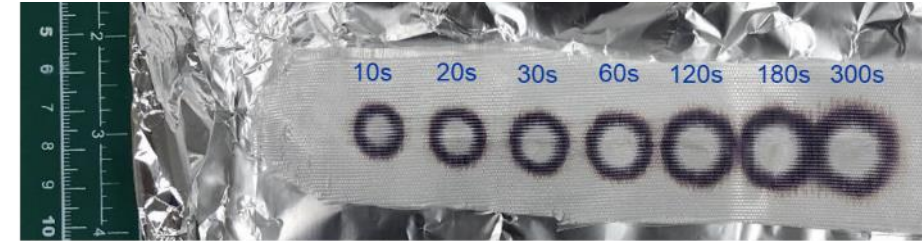

Iodine Test after Plasma Desizing of S2 Glass (636), with Varying Treatment Times at a 5mm Distance.



Iodine Test after Plasma Desizing of S2 Glass (636). 1mm Distance, 1.5m/s Moving Nozzle

2. Iodine Tests (For starch-based sizing)

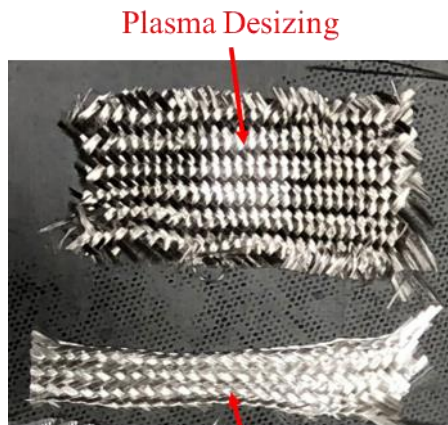

Thermal Desizing

3. Visual

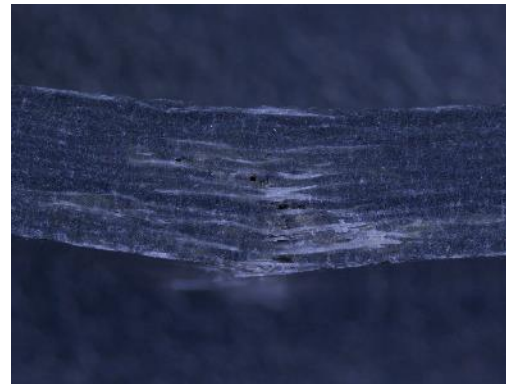

4. Composite Properties

- Electrical, mechanical, adhesion

5. Effects on Cable Conductor

- Residual Resistivity Ratio (RRR)
- Critical Current, I_c

Nb-Ti VAMAS Sample
Jérôme Fleiter «Round Robin
Test for I_c Measurements of Nb-
Ti and YBCO Conductors»
(2010)

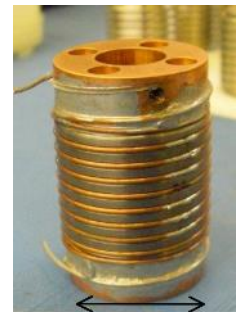

32 mm

DC Breakdown Tests of Laminates in Liquid Nitrogen

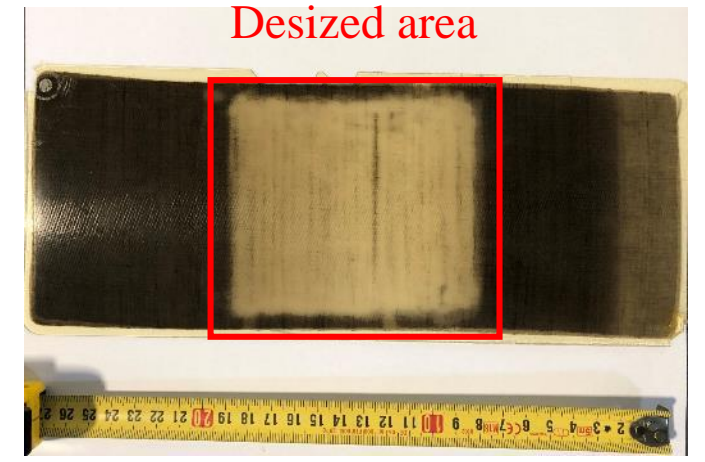
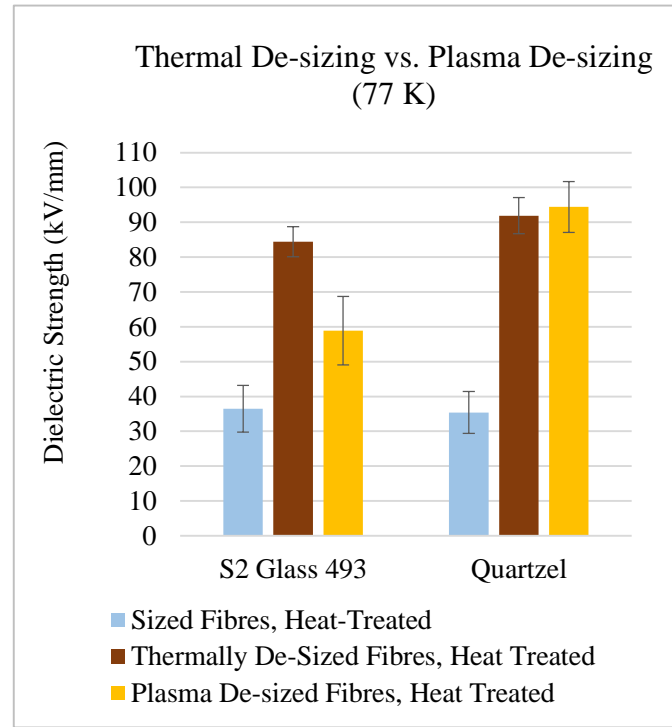
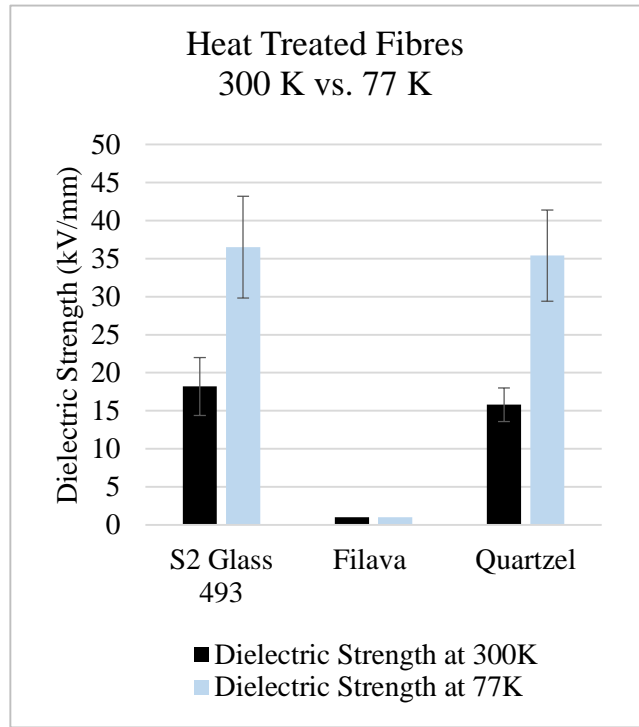

0.5mm plate of CTD101K + Plasma Desized, Heat-Treated Quartzel Composite

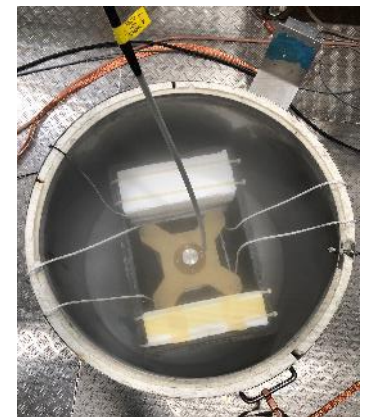

DC Breakdown Setup in Liquid Nitrogen

J. Osuna *et al.* Advanced Composite Insulation Systems in Nb₃Sn Superconducting Magnets for Accelerators: Electrical Characterization of Laminates at Cryogenic Temperatures (2024)

- Testing at cryogenic temperatures is more representative of the magnet's operating conditions.
- When tested in liquid nitrogen at 77K, the performance of the composites appears to improve.
- Thermal desizing appears more reliable than plasma desizing. However, in both cases, an improvement was achieved relative to the untreated samples.

Optimization of Heat-Cleaning Procedure using TGA

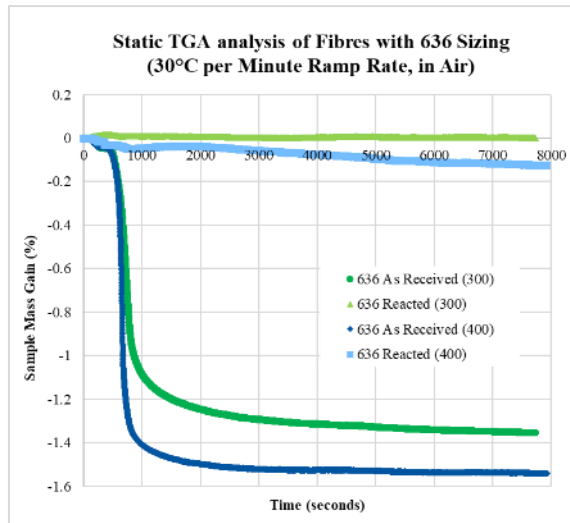
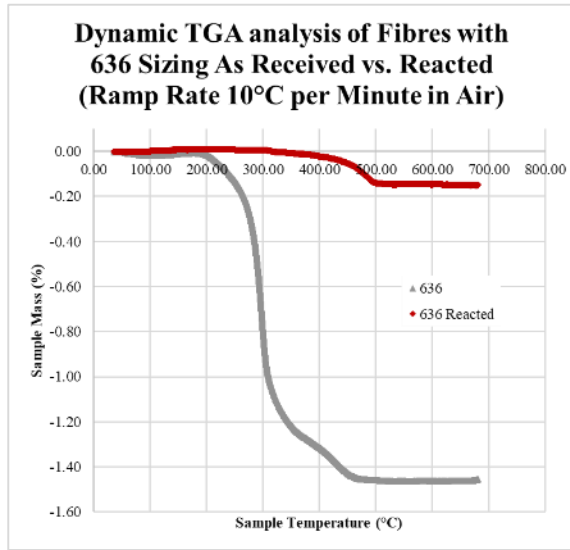

Modified Nb_3Sn reaction cycle with **desizing step**.

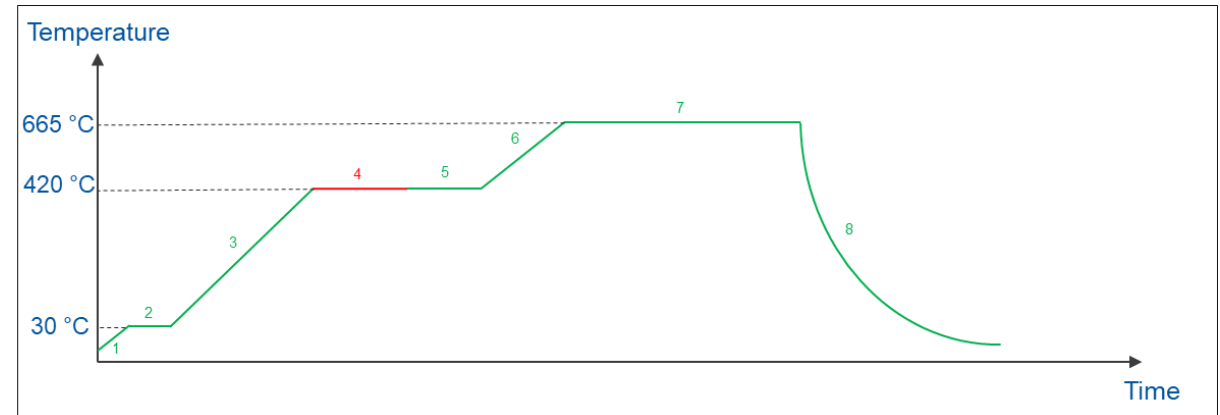

Osuna, J. Modified nb3sn reaction cycle with air for desizing S2 glass and Quartzel fibers, EDMS 3175024 (2024)

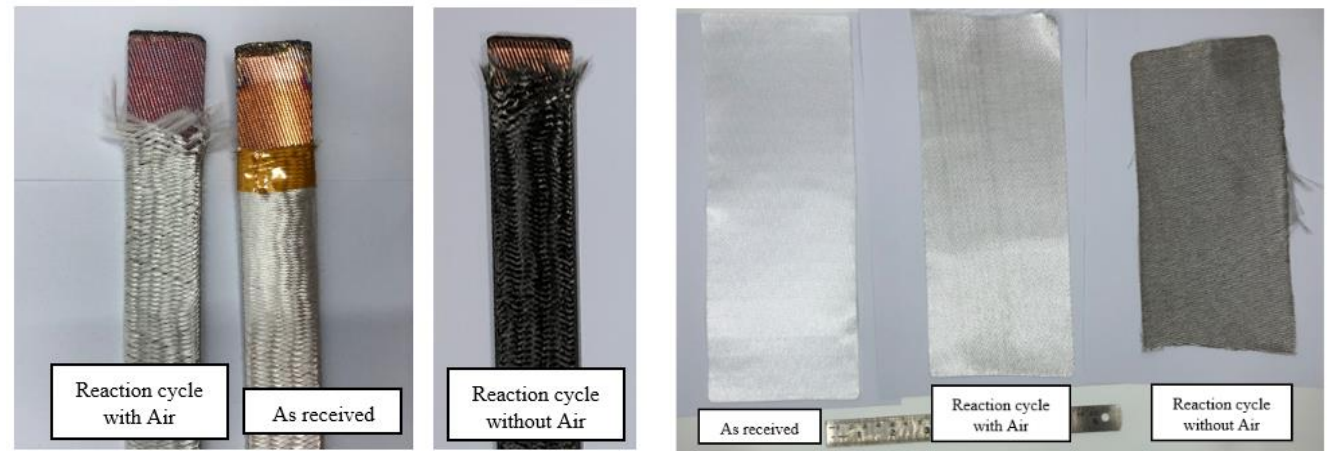

Nb_3Sn Cable with S2 Glass 933 Insulation

Quartzel Fibre Fabric

Osuna, J. TGA Analysis of S2 Glass Fibres with 636 Sizing for Thermal Desizing Study, EDMS 3165822 (2024)

Other Ongoing Efforts

1. Parameter optimization of plasma treatment on Nb₃Sn cables and effects on cable conductor.

Spot Desizing

(1 sec, 2 sec, 5 sec, 10 sec, 30 sec, 60 sec)



Cable conductor after plasma treatments above



Insulation After Plasma Treatment and Nb₃Sn Reaction Cycle

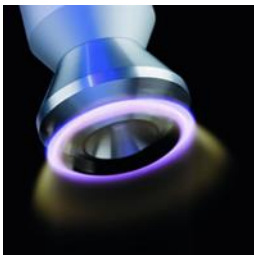

Collaborating with plasma technology suppliers for the testing of rotary nozzle technology. Example nozzle shown left.

Picture from: <https://www.henkel-adhesives.com/us/en/products/industrial-sealants/gasketing/potting.html>

Moving Nozzle

(0.3m/min. , 0.6 m/min. , 1.2m/min. , 1.8m/min.)



Cable conductor after plasma treatments above

2. Chemical washing and effects on cable conductor

Alconox

- Designed for applications where minimal corrosiveness/residue is wanted.
- Suggested by Andre (PSI) and used for BOX samples.

Methyl Ethyl Ketone

- Recommended by a supplier for fibre desizing.

More aggressive cleaning agents:

- Alcojet (also suggested by Andre, PSI)
- Citranox

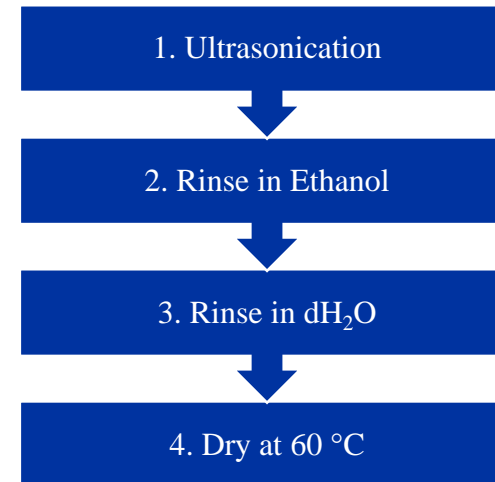

Future Work

Conclusions and Further Work

- The robustness (from an electrical standpoint) of the Nb₃Sn coil and cable insulation can be improved by preventing the formation of conductive residue on fibres.
- Thermal desizing and plasma desizing appear effective for desizing cable insulation, and thus for minimizing the formation of conductive residue. Results for chemical desizing are in progress.
- The removal of sizing will likely affect the mechanical properties of the composite, due to the role of sizing in forming the fiber matrix interface.
- Further research on desizing will be aimed at:
 1. Performing de-sizing and electrical tests on 10-stacks, which are more representative of coil geometry.
 2. Comparing the mechanical properties of reacted fibres with and without sizing (flexural strength/ILSS).
 3. Better understanding the effects of thermal, plasma and chemical treatments on RRR and I_c when applied on a cable insulation.
 4. Improving the reproducibility of plasma treatment and ensuring it works for different sizings and fibre materials.

Additional Slides

Function of Insulation in Superconducting Magnets

Insulator (electrical): A material with a large energy gap between the valence and conduction band, which does not readily permit electrons to carry an electrical current under the application of an electric field.

- **Insulating materials help fulfill a number of critical functions:**
 1. Provide **conductor spacing** and if possible facilitate **resin impregnation**.
 2. Prevent **short circuits and arcing** between conducting parts of magnet and from magnet to ground.
 3. Have a well-defined thickness to preserve **magnetic field quality**.
 4. Confer a **rigid shape** to the coils.

Magnet Insulation Components (MQXF)

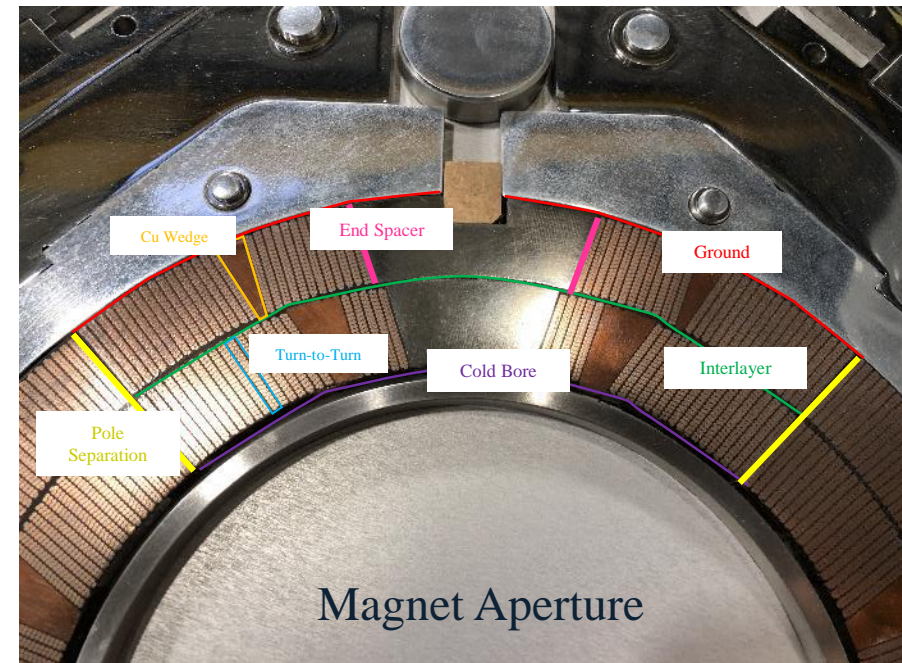

Atmospheric Plasma Cleaning

Plasma which does not require a vacuum, and can realistically take place at low temperatures (below 200 °C).

Physicochemical process, involving the simultaneous action of:

- UV Light
- Free-Radicals
- Ions
- Temperature

Air plasma to be applied on top and bottom of cable simultaneously during a spooling process.

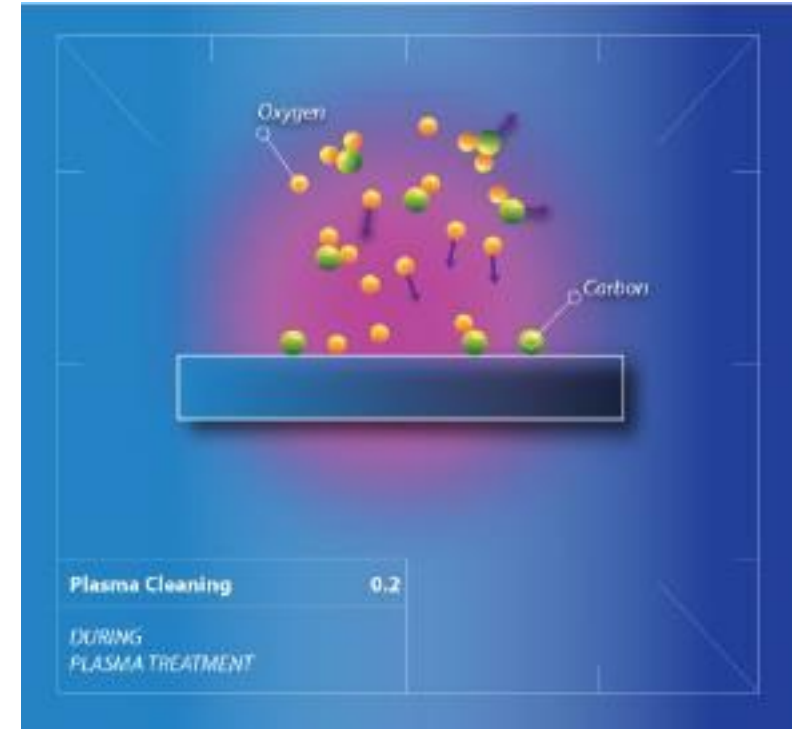

https://plasmatreatment.co.uk/images/plasma-technology/plasma-tech-overview/PlasmaCleaning_02.jpg



Example Plasma Treatment on a Nb₃Sn Cable

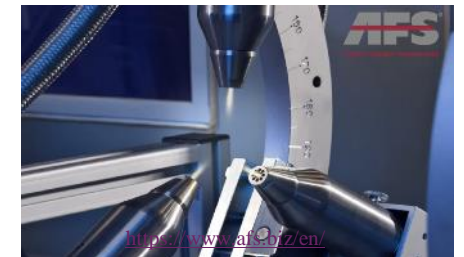

Electrical Tests Performed of Fibre Insulation

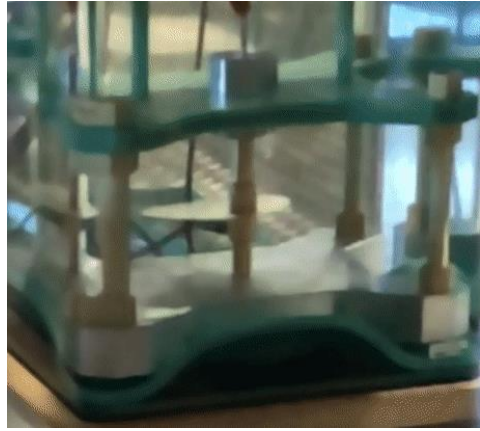

- **DC Breakdown Tests:**

- Power Supply:
 - 0.5mA, 150kV FUG HCP 140-150000
 - 5mA, 65kV FUG HCP 350-65000
- Ramp Rate: 500V/s
- Testing Medium: Oil, Air, Liquid Nitrogen



25mm Diameter Brass Electrode

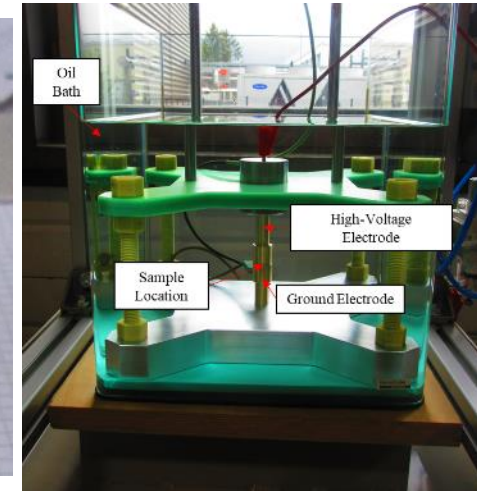

- **Volume Resistivity Tests:**

- Guarded Electrode Configuration
- Power Supply: Keithley 2260B-800-1 360W
- Picoammeter: Keithley 6485 Picoammeter
- Test Voltage: 500VDC*
- Testing Medium: Air

*Lower voltages were used for samples that were not insulating.



Picoammeter

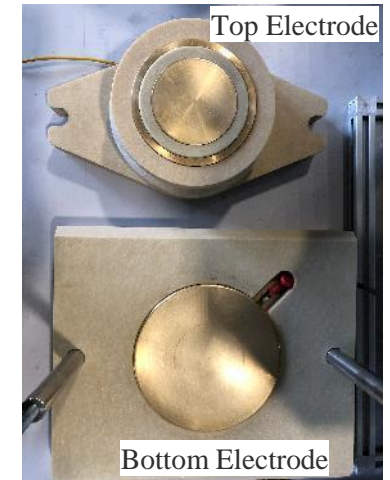

Top Electrode

Bottom Electrode

picoammeter

A

ELECTRODE

SAMPLE

ELECTRODE

500V DC

MQXF Interlayer Study (EDMS 2735359)

C. Scheuerlein, MQXF interlayer mechanical properties – TE-MS C 2022

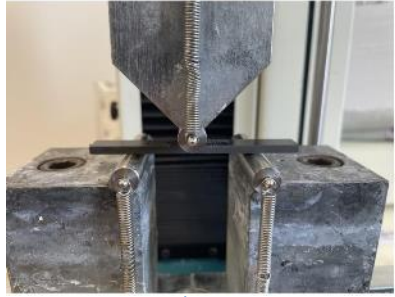

3 Point Bend Configuration

Flexural Strength (MPa)

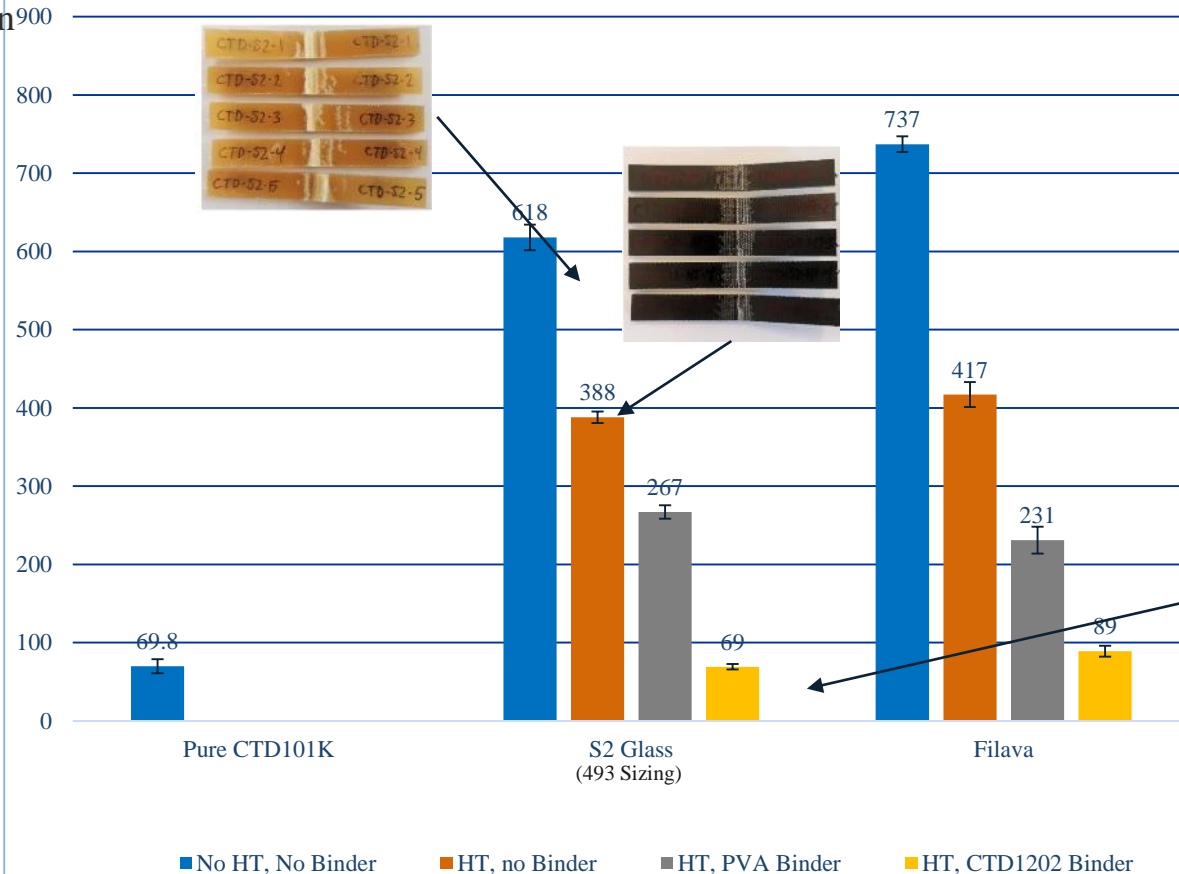

The flexural strength of CTD101K composite samples decreases significantly following the Nb_3Sn reaction cycle in Argon.

The presence of ceramic binder appears to exacerbate this effect.

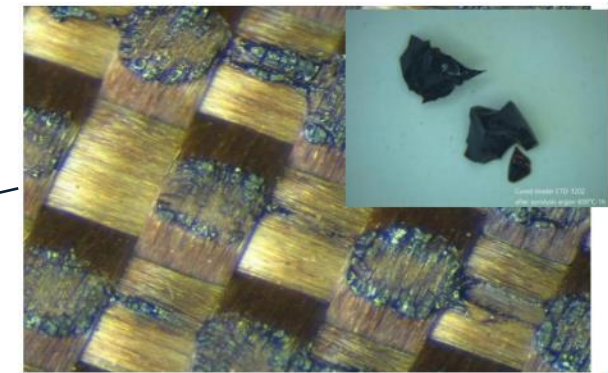

Formation of **Silicon Oxycarbide** during 650°C Reaction Cycle in Argon

D. Ternova, FTIR and XRF analysis of the S2 TEX glass-fibre with the CTD-1202 ceramic binder after several treatments, TE- VSC 2022 - EDMS 2732657

Binder Effects on Electrical Properties of Insulation Materials

- The use of ceramic binder appears to partially maintain the insulating behaviour of the epoxy + S2-Glass composite following the Nb₃Sn reaction cycle.

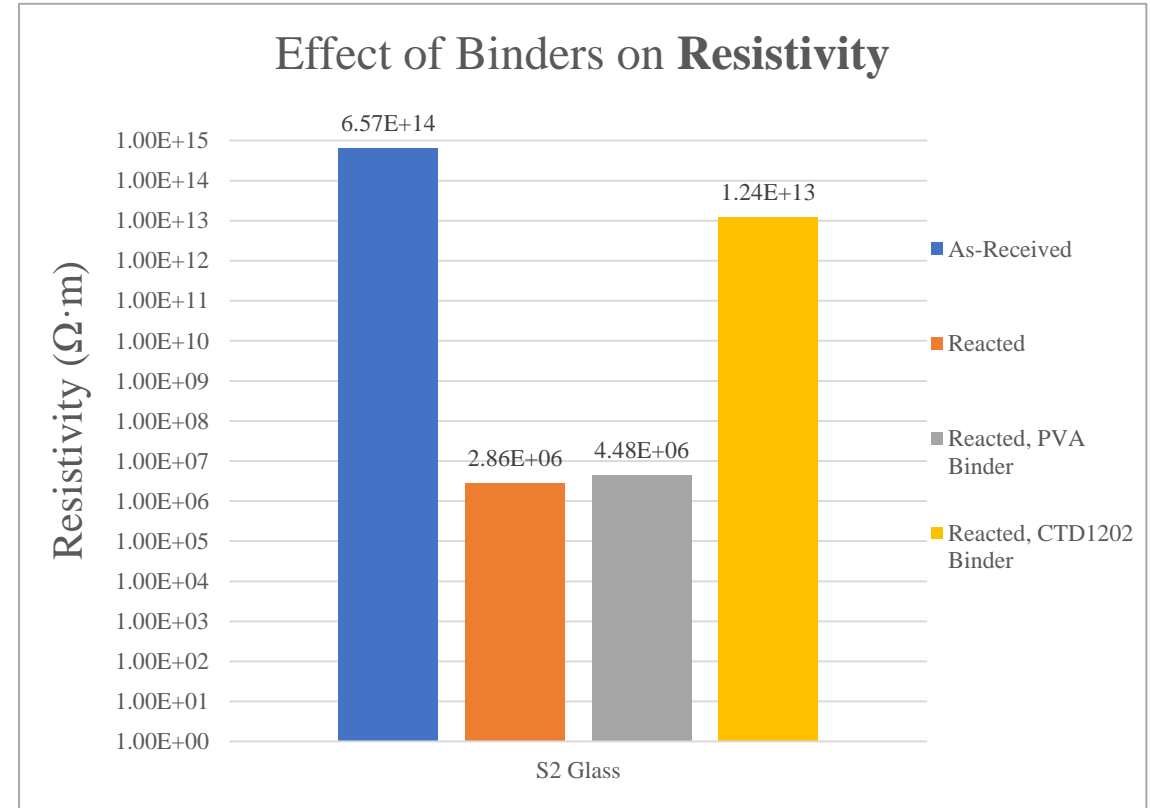
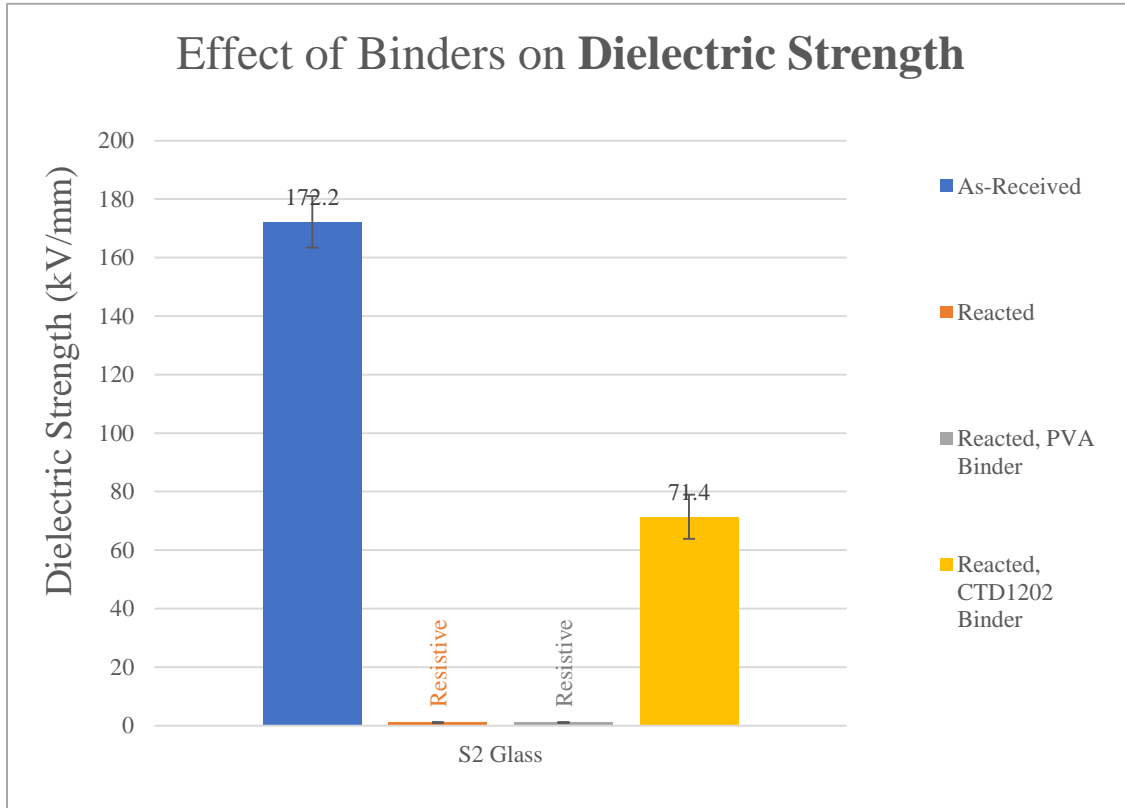

Thermal Desizing Experiment

Another experiment is being performed to **remove sizing from a fiberglass fabric by the graphitization method.**

Various fiberglass fabrics have been placed in an oven for **four hours at 400°C, in air.**

The iodine test was performed on the fabric containing the **636 sizing.**

Because **the other fabrics do not contain 636 sizing,** the iodine test cannot be performed to monitor the removal of sizing.

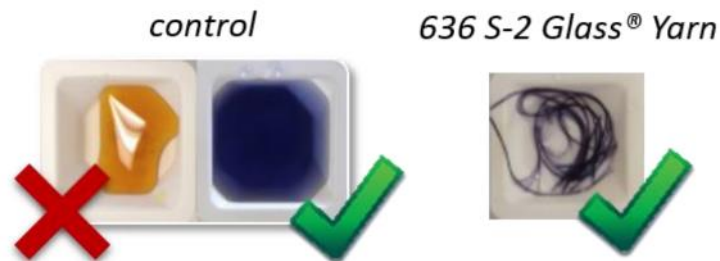
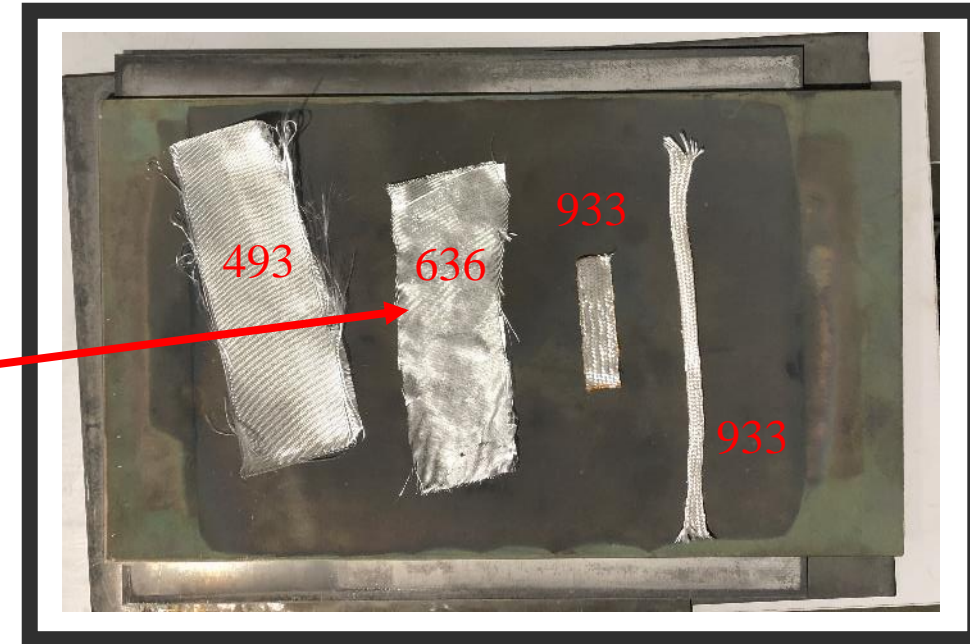
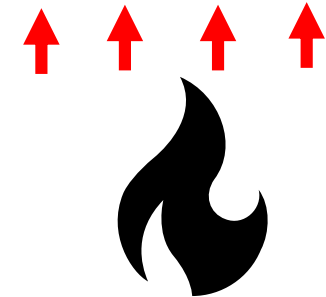

Figure 13: Iodine test on 636 S-2 Glass® Yarn by AGY



4 hours at 400°C (air)

Results of Plasma Desizing Experiment

Appearance following
Plasma Treatment



Nozzle at 25mm

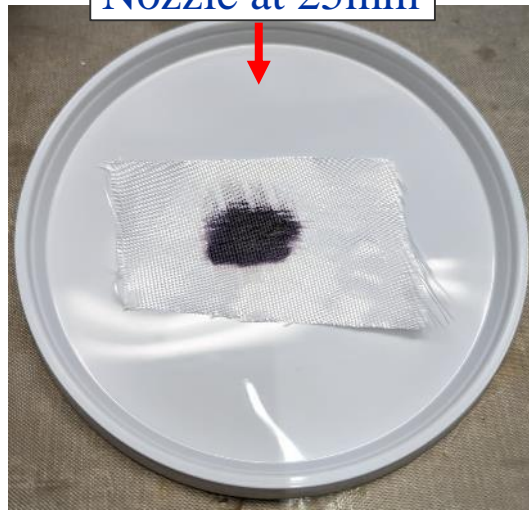

Iodine Test

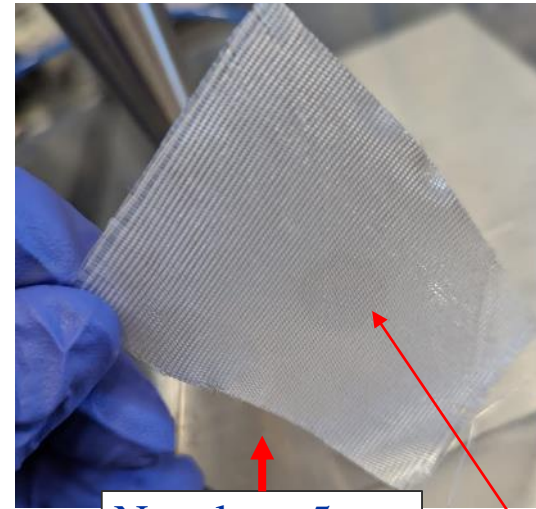

Nozzle at 5mm



- The starch test is **positive for 25mm nozzle distance and negative for 5mm.**
- This is evidence that the **sizing can be removed** when treating for 5 minutes at 5mm.
- The results also indicate that treatment is **strongly dependent on distance.**
- **Even before performing the test, there is a visible change in appearance** of the treated surface for the 5mm treatment.

Thermal Desizing Experiment – 636 Sizing Results



Appearance following
Thermal Desizing

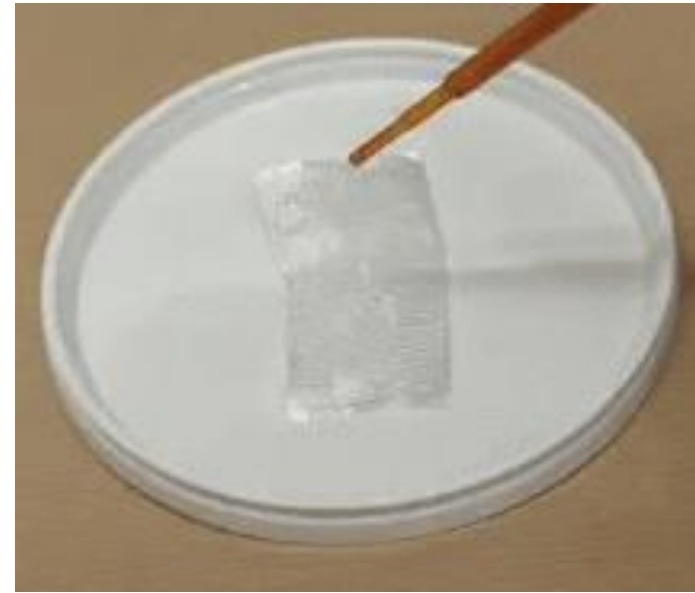

Iodine Test

- The starch test is **negative** for the fibre tissue following the thermal desizing.
- This is evidence that the **sizing can be removed** with a thermal cycle in oxygen at 400°C for 4 hours.
- The starch was not detected anywhere on the surface of the sample. The **sizing appears to be removed throughout the whole sample.**

Results of Plasma Desizing Experiment (II)

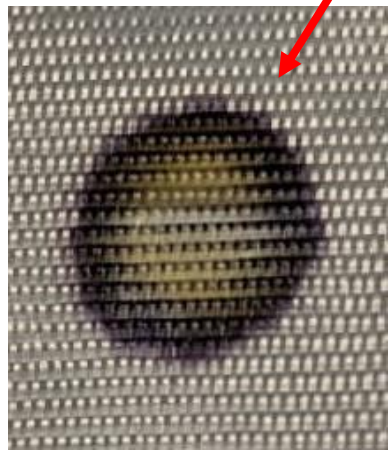
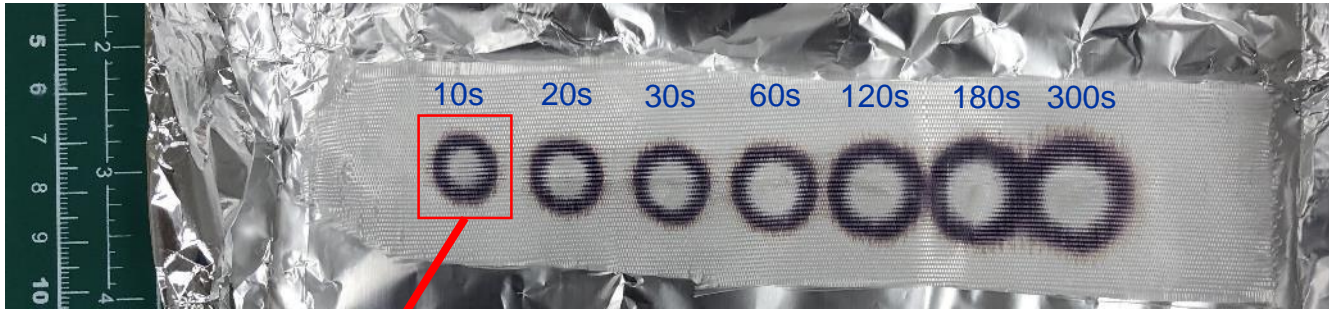

Initial appearance of Iodine solution when applied to fabric.

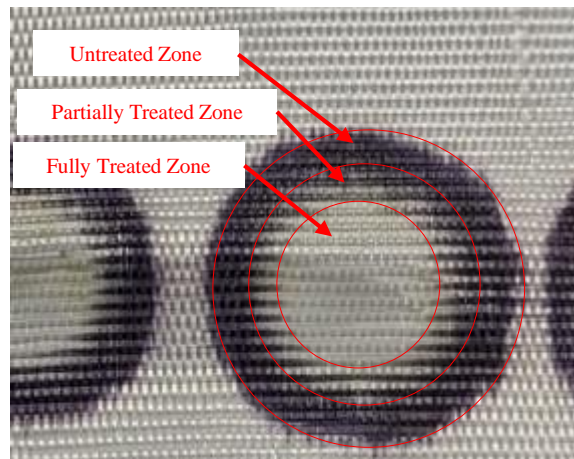

Close-up of Iodine test result.

Average Diameter of Fully Treated Zone (mm)

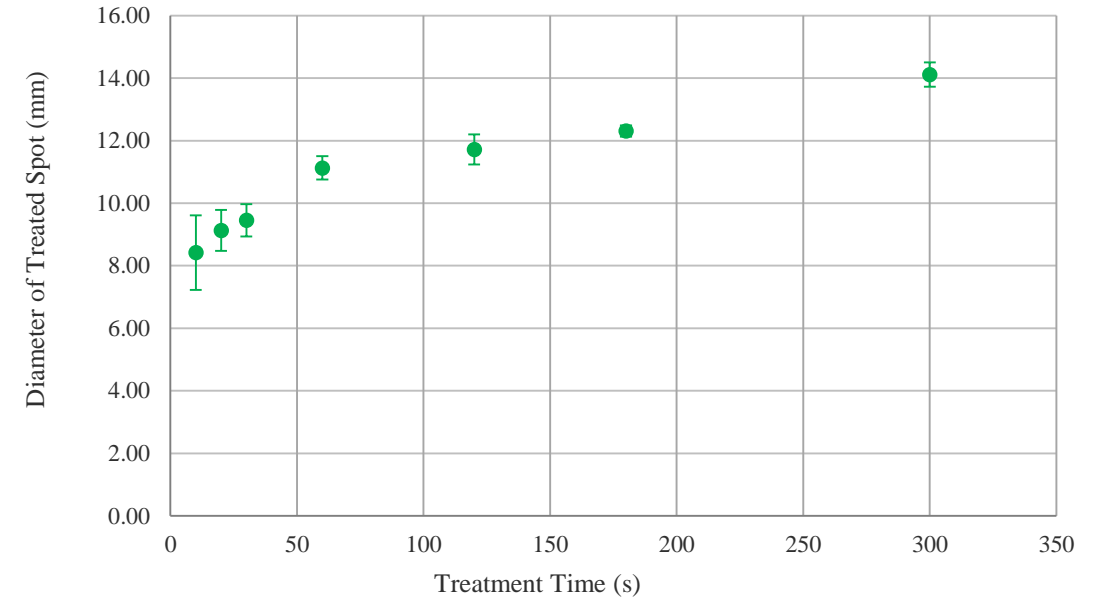

- The absence of starch is noticeable after **10 seconds of plasma treatment**.
- The diameter of the treated area has a **higher rate of increase in the first ~60 seconds of plasma treatment**.
- The **wettability** of the fabric with iodine solution was also observed to increase with treatment time.

Literature – Desizing

Two general approaches to de-sizing:

Solvent Removal

Graphitisation (Burning) in air

| Reference | Desizing Method | Fiber Material |
|-------------------------------------|---|--|
| Greenhalgh <i>et al.</i> [6] | Graphitisation (350°C for 16h in air) | S-Glass/Quartz, organic sizing assumed |
| Fabian <i>et al.</i> [4] | Graphitisation (400°C for 4h, assumed in air) | S-2 Glass, 6781, 8-harness satin weave, silane finish |
| Roy <i>et al.</i> [9] | Graphitisation (350°C, time not mentioned, in air) | HYBON 2001 E-Glass, organic sizing assumed |
| Arkan <i>et al.</i> [1] | Graphitisation (Various temperatures for 3h in air, one test for 16h) | S-2 Glass, starch/oil-based sizing (Owen-Corning designation: 636) |
| Devred <i>et al.</i> [3] | Graphitisation (350°C overnight in air, with prior desizing in air at 700°C for 10-15 minutes in the case of quartz only.) | E-Glass, S-2 Glass, Quartz and Mica with organic sizing |
| Gayot, Sarah (CERN Test Report) [5] | Solvent Removal 1. 3-Stage rinsing in n-hexane 2. Soxhlet extraction in acetone | S-2 Glass (Various sizings/Weaves) |
| Li <i>et al.</i> [8] | Solvent Removal - Acid Desizing (Boiling Water followed by 0.24M H ₂ SO ₄) - Oxidant Desizing (4mL/L H ₂ O ₂ , 2 g/L NaOH and 2 g/L JFC) | Cotton fibers with starch-based sizing |
| Ul-Haq <i>et al.</i> [10] | Solvent Removal (Enzymatic Desizing with amylase) | Cotton fibers with starch-based sizing |

Sizings at High Temperatures

FTIR Results of 933 and 636 Sizings after Heat Treatment – Sarah Gayot CERN Report [5]

3.6 Sizing characterisation on glass fibres after reaction cycle

3.6.1 S-2 933 "braided sock" for MQXFS cable insulation

FTIR results suggest that the reaction cycle did not completely degrade 933 sizing into volatile products. The polyurea-based film former, in particular, does not seem to have been much altered, as the corresponding signal is nearly similar as the one obtained prior to heat treatment.

However, the PPG lubricant seems to have been completely volatilised. This observation is consistent with literature studies, which indicate that PPG is fully decomposed into volatile products long before reaching 650°C, even under an inert atmosphere (Song et al.).

Additionally, the absence of PPG in the hexane spectrum allowed to unveil the presence of a very weak signal corresponding to small quantities of silicones, possibly amidosilicones. These compounds, which are known to be heat-resistant, might have been part of the initial formula of sizing 933. In that case, it

3.6.2 S-2 636 "braided sock" for 11T cable insulation

FTIR results suggest that the reaction cycle did not completely degrade 636 sizing into volatile products. Triglyceride-based lubricant, silicone (likely PDMS) and starch film former did undergo pyrolysis reactions, but some of the by-products remained as residue on the fibre surface. This observation is consistent with literature studies, which indicate that both starch molecules and triglycerides undergo strong but incomplete degradation when heated up under an inert atmosphere (Soliman et al., Uzun et al.). The corresponding by-products are said to be mostly char, as well as a complex mixture of hydrocarbons - alkanes, alkenes, either aliphatic or aromatic (Uzun et al., Schmeltz & Schlotzhauser) -, which also matches the FTIR results obtained. As concerns PDMS, it is supposed to be fully degraded into volatiles when heated up under an inert atmosphere (Camino et al.).

Studying Ideal Temperature for Graphitisation – Arkan *et al.* [1]

| # | Material | Curing Conditions | Weight Reduction | Remarks |
|---|------------|-----------------------------|------------------|---------------------------------|
| 1 | S-2 Sleeve | 100 °C; 3 Hr | 0.00% | White in color |
| 2 | S-2 Sleeve | 200 °C; 3 Hr | 0.14% | very light brown in color |
| 3 | S-2 Sleeve | 300 °C; 3 Hr | 0.83% | Sleeve turned brown in color |
| 4 | S-2 Sleeve | 400 °C; 3 Hr | 0.57% | Sleeve turned pale white |
| 5 | S-2 Sleeve | 500 °C; 3 Hr | 0.55% | back to the initial white color |
| 6 | S-2 Tape | 500 °C; 3 Hr | 0.63% | White in color |
| 7 | S-2 Sleeve | Repeat of 3 at 500 °C; 3 Hr | 0.09% | turned white in color |
| 8 | S-2 Sleeve | Repeat of 5 at 500 °C ; 3Hr | 0.02% | no change in color |
| 9 | S-2 Sleeve | Closed; 300 °C; 3Hr | 0.58% | Dark brown in color |

Table 1: Insulation burning test results on S-2 glass insulation.

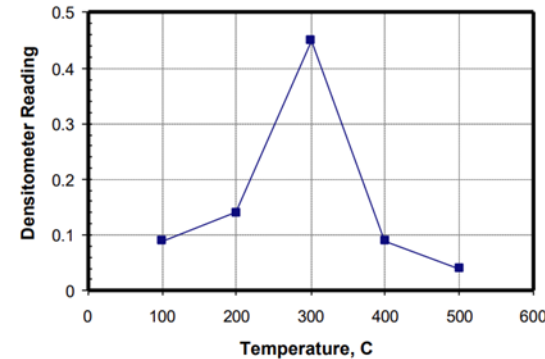

Fig. 1: Densitometer readings on burned S-2 fiber glass in insulation. Note that the as-received material showed a densitometer reading of 0.06.

Determination of Desizing Efficiency – Roy *et al.* [9]

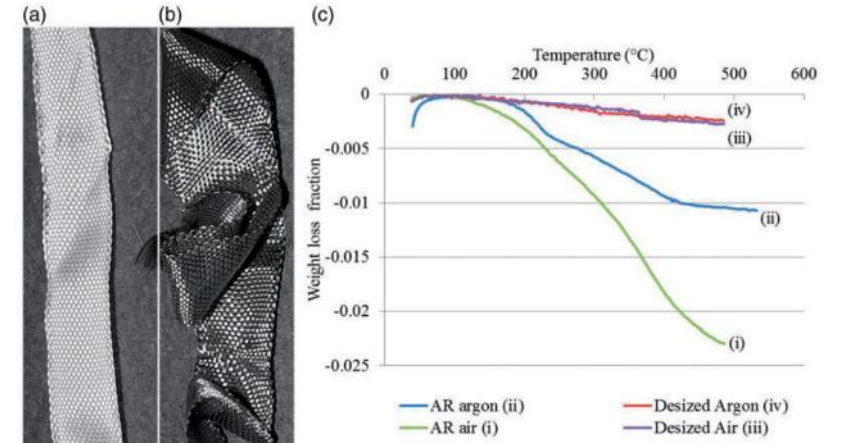

Figure 4. Organic size-coated glass fibre woven tape (a) before heat treatment (as received), (b) carbon residue from burnt organic components on the glass fibre tape after heat treatment at 660°C in vacuum and (c) graph representing TGA analysis of HYBON 2001 E glass fibre as received (AR) and after desizing in air and inert atmosphere.

References for Slides 31-32

[1] Arkan, T.T. *et al.* (1998), *Studies on S-2 Fiber Glass Insulation for Nb₃Sn Cable*

<https://lss.fnal.gov/archive/vlhc/fermilab-vlhcpub-197.pdf>

[2] Canfer, S.J. (2006) ‘*Insulation development for the next European dipole*’, AIP Conference Proceedings [Preprint]. doi:10.1063/1.2192364.

[3] Devred, A *et al.* (2000). *Insulation Systems for NB₃SN Accelerator Magnet Coils Fabricated by the “Wind and React” Technique*. In: Balachandran, U.B., Hartwig, K.T., Gubser, D.U., Bardos, V.A. (eds) *Advances in Cryogenic Engineering Materials* . Springer, Boston, MA. https://doi.org/10.1007/978-1-4615-4293-3_18

[4] Fabian, P.E., *et al.*(1994). *Properties of Candidate ITER Vacuum Impregnation Insulation Systems*. In: Reed, R.P., Fickett, F.R., Summers, L.T., Stieg, M. (eds) *Advances in Cryogenic Engineering Materials* . An International Cryogenic Materials Conference Publication, vol 40. Springer, Boston, MA.

https://doi.org/10.1007/978-1-4757-9053-5_128

[5] Gayot, Sarah (2017), *Chemical characterisation and comparison of glass fibre sizings for MQXFS insulation scheme* <https://edms.cern.ch/document/1828310/1.1>

[6] Greenhalgh, R.J.S. *et al.* (2008) ‘*Fracture measurements on insulation for high-field superconducting magnets: Relationship to processing regimes and test temperature*’, *Engineering Fracture Mechanics*, 75(9), pp. 2642–2650. doi:10.1016/j.engfracmech.2007.03.003.

[7] Gonçalves Lopes, Marco (2014) *Glass Fibre/Binder Characterization* <https://edms.cern.ch/document/1405346/1>

[8] Li, W. *et al.* (2022) ‘*Quaternization-butyrylation to improve the viscosity stability, adhesion to fibers, film properties and desizability of starch for warp sizing*’, *International Journal of Biological Macromolecules*, 204, pp. 500–509. doi:10.1016/j.ijbiomac.2022.02.021.

[9] Roy, SS *et al.* (2018) *Braiding ultrathin layer for insulation of superconducting Rutherford cables*. *Journal of Industrial Textiles*. 2018;48(5):827-847. doi:10.1177/1528083716661204

[10] Ul-Haq, N. and Nasir, H. (2011) ‘*Cleaner production technologies in desizing of cotton fabric*’, *Journal of the Textile Institute*, pp. 1–8.

doi:10.1080/00405000.2011.570045.