



Practical Days @ CERN

Normal Conducting Magnets

Part 1: Magnet Technology, Production and Testing

Tuesday 11th & Wednesday 12th March 2025, 9:00 – 16:15

jeremie.bauche@cern.ch

Outline

- Normal Conducting Magnets at CERN
 - Magnet group
 - Magnet patrimony
 - NCM mission and opportunities
- Program and Organization of Magnet Practical Works
 - Magnet Technology, Production and Testing
 - Magnetic Measurements (see next talk from L. Fiscarelli)

GAO
Group Assistant's Office

SANDELL Sonja

TE-MSC
Magnets, Superconductors
and Cryostats

GL: MILANESE Attilio
DGL: BALLARINO Amalia

~150 persons (staff, fellows, students)

TE-MSC-CMI Cryostats & Machine Integration	TE-MSC-HSD High Temperature Superconductors & Devices	TE-MSC-LMF Large Sc Magnet Facility	TE-MSC-LSC Low Temperature Superconductors & Characterization	TE-MSC-NCM Normal Conducting Magnets	TE-MSC-SMT Superconducting Magnet Technology	TE-MSC-IMM Magnetic Measurements & Modelling	TE-MSC-MQA Magnetic Qualifications & Analysis
SAVARY Frederic	BALLARINO Amalia	IZQUIERDO BERMUDEZ Susana	BOUTBOUL Thierry	SCHOERLING Daniel	TODESCO Ezio	BUZIO Marco	WILLERING Gerard
DESCHAMPS Jean-Baptiste DIAZ VEZ Ruth DUARTE RAMOS Delio LECLERCQ Yann MCINTYRE Sean MESSINA Noel MOULEYRE Jeremy PASDELOUP Florian STRUUK Michael	BARTH Christian BASKYS Algirdas CAREIL Marc-Philippe GHARIB Alain HURTE Julien MAZET Jacky PERINI Diego ROWLAND Maxwell	AXENSALVA Jerome BAMPTON Tavis BAUDIN Lucie BECLE Steve Thierry BOURCEY Nicolas EYVAUD Nicolas FAVIER Ludovic FERRADAS TROITINO Jose GRAND-CLEMENT Ludovic LE NAOUR Sandrine LUSA Nicholas LUZIEUX Sebastien POZZOBON Marc PRIN Herve TRIQUET Stephane VIEITEZ SUAREZ Andres	BONASIA Angelo FLEITER Jerome GAUTHERON Emma GIRARDOT Florian HOPKINS Simon JACQUOT Pierre-Francois MALABAIA Marina VANDEN CRAEN Arnaud	BAUCHE Jeremie BODART Dominique CATHERINE Pascal COT Cyril Pierre CRETIN Alexandre CRETIEZ Olivier DUMAS Maxime GERARD Delphine HAAUEN Haavard NEWBOROUGH Antony PERRIN-BONNET Gregory SCHWARZ Philip THONET Pierre VON FREEDEN Luke	CARLON ZURITA Alejandro CHAGANTI Pavan CLEMENT Sebastien COTE Dominique FERNANDES Carlos FOUSSAT Arnaud Pascal HAZIOT Ariel Elie KARPPINEN Mikko MAURY Gregory PEREZ Juan Carlos PICCIN Roland PINCOT Francois-Olivier RIZZO Pietro Antonio SCHEUERLEIN Christian URSCHLER Cedric	BELTRON MERADILLO Ricardo BONORA-TAM Matthias CHRITIN Regis DEFERNE Guy DUNKEL Olaf FISCARELLI Luca GILOTEAUX David MARTINEZ HERNANDEZ Unai PETRONE Carlo RUSSENSCHLOCK Stephan	BOCZAN Michael Steven DITSCH Olivier Claude FEUVRIER Jerome JUBERG Stian MANGIAROTTI Franco Julio NINET Gaelle Marie PICHON Guillaume Pierre VIRET Patrick
STAFF	STAFF	STAFF	STAFF	STAFF	STAFF	STAFF	STAFF
GARCIA ROBLES Diego PRYCE William SANCHIS ORTOLA Victorio SPATHOPOULOS Stefanos	GAL Norbert JAY-BRETONVILLE Paul KRAMER Tim LAZARIDOU Aikaterini MORISI Simone PEREZ MARTINEZ Rita SABA Aisha VOGL Christian	QUASSOLO Penelope Matilde STRAARUP Simon TOFTE Hans Christian TUROCY Marek	AVRONSART Julien BAUMANN Josef PRESMANES CARDAMA Javier	DEVECI Halil GARCIA-AGUIRREBEITIA SANCHEZ Ignacio GAWEDZKI Marcin GILL Alastair KEY SANCHEZ Raul NEIDHART Andre NIEBERLE Patrick	BEN EL CAID Federico FERNANDEZ MORA Elena GEIGER Kieran Paul HERNANDO IRISARRI Gonzalo OSUNA Javier PARRAGH David PEREZ DE LAZARRAGA VIGUTI Ignacio SALA Nicola SCHENK Vincent	DIAMANTIS Konstantinos DI CAPUA Vincenzo GANESH Abhishek PENNELLA Miriam ROGACKI Piotr Tomasz	DIAS GONCALVES Roberto
FELL/GRAD	FELL/GRAD	FELL/GRAD	FELL/GRAD	FELL/GRAD	FELL/GRAD	FELL/GRAD	FELL/GRAD
	VAN INGEN Frederik	BREINER Thomas	BIJLSMA Jeroen KUCZYNSKA Joanna		GO WRISHANKAR Sachin LANZONI Enrico WOLF Lukas	BELLELLI Alberto MACCARI Jacopo OESTERBRUNN Maximus PRAZNOVSKY Martin TAUPADEL Marcus TSIOLAKIS Christoforos	JACOBS Mathijs
	STUDENTS	STUDENTS	STUDENTS		STUDENTS	STUDENTS	STUDENTS

Superconducting Magnets

Normal Conducting Magnets

CERN Normal Conducting Magnets

The CERN accelerator complex
Complexe des accélérateurs du CERN

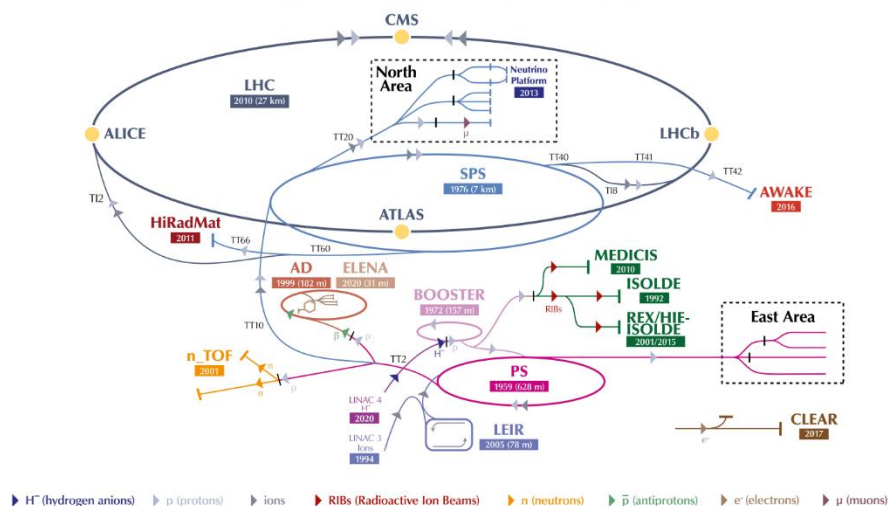

- About 20 km of beam lines in >20 different machines, all interconnected
- ~ 4500 installed magnets + ~ 2000 stored magnets → 50 000 tons

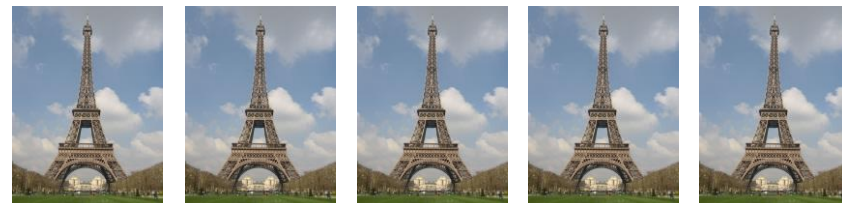

- Large variety: ~ 500 different types



LINAC4 DTL PMQ, < 1 kg



LEIR main dipole, 60 tons

LHC - Large Hadron Collider // SPS - Super Proton Synchrotron // PS - Proton Synchrotron // AD - Antiproton Decelerator // CLEAR - CERN Linear Electron Accelerator for Research // AWAKE - Advanced WAKEfield Experiment // ISOLDE - Isotope Separator OnLine // REX/HIE-ISOLDE - Radioactive Experiment/High Intensity and Energy ISOLDE // MEDICIS // LEIR - Low Energy Ion Ring // LINAC - LINear ACcelerator // n_TOF - Neutrons Time Of Flight // HiRadMat - High-Radiation to Materials // Neutrino Platform

The MNC Section

Design, procurement/manufacture, maintenance, consolidation, upgrade, disposal of the normal conducting magnets in the accelerators, transfer lines and experimental areas

- **Operation: maintenance and consolidation of existing machines**

2 dedicated radioactive workshops treating about 100 magnets/year

→ maintenance of installed magnets in the accelerators

→ interventions during physics run to minimize beam downtime

- **Projects: upgrades and new beam lines**

2 dedicated workshops for magnet and component production (prototyping)

→ upgrade of existing magnet systems (e.g. ISOLDE 2GeV, HL-LHC)

→ construction of new magnets (existing and future accelerators, like FCC-ee)

<https://te-msc-ncm.web.cern.ch/>

Operation and Maintenance



Design and Procurement

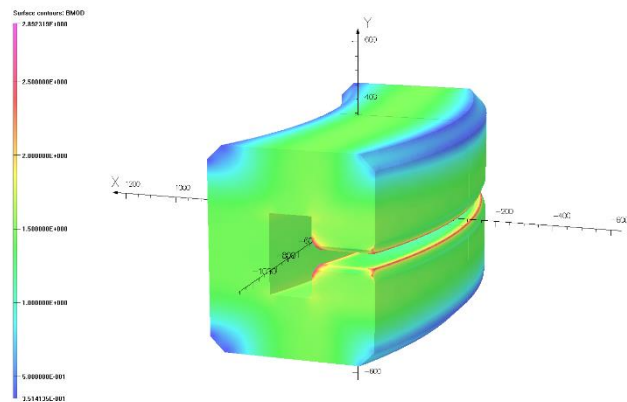

Magnetic design

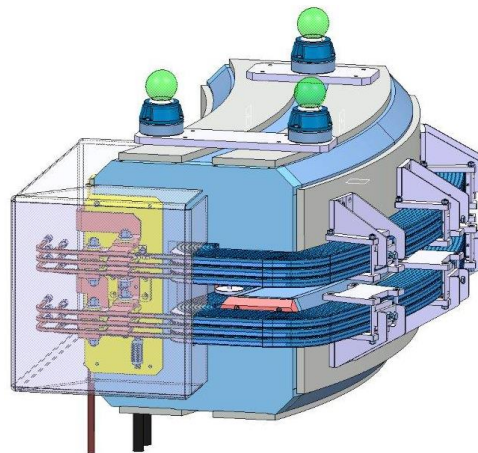

Mechanical design

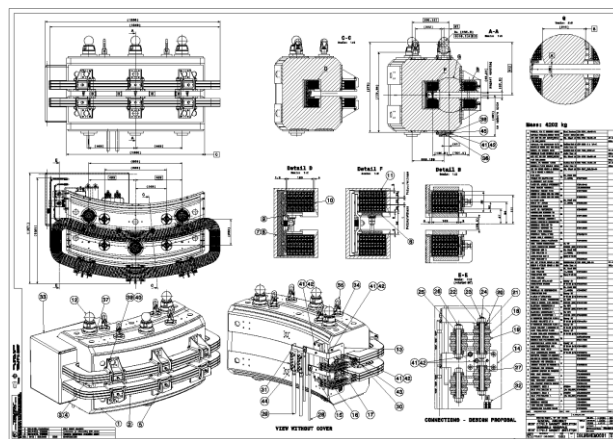
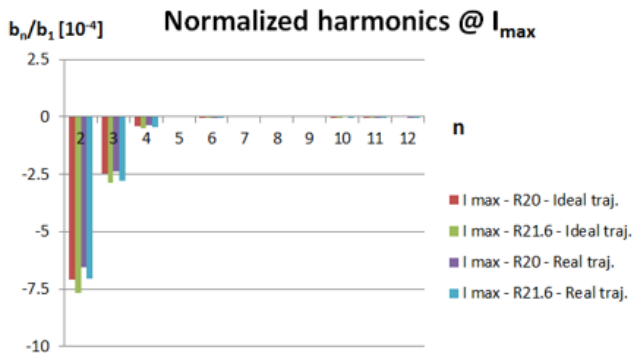

ORGANISATION EUROPÉENNE POUR LA RECHERCHE NUCLÉAIRE
 CERN EUROPEAN ORGANIZATION FOR NUCLEAR RESEARCH

EDMS N°: 1288334
HIE-ISOLDE Project Document Ref: HIE-MBHEM-CL0001

Group Code: TEM5C-MNC
IT-3909 TE HIE-ISOLDE

The HIE-ISOLDE Project

Invitation to Tender

Technical Specification

**Beam Transfer Line Dipole Magnets
for the HIE-ISOLDE Facility**

Abstract

This technical specification concerns the supply of four C-type dipole electromagnets, plus one set of spare coils for the HIE-ISOLDE high energy beam transfer lines. These magnets are made of laminated steel yokes and of water-cooled coils wound from hollow copper wire. Their mass is approximately 4200 kg per magnet. Delivery shall be completed within 14 months after placement of the contract.

June 2013

Specifications for

manufacture;

Production

in house / in industry

Manufacture and Tests



Manufacture



Tests and measurements

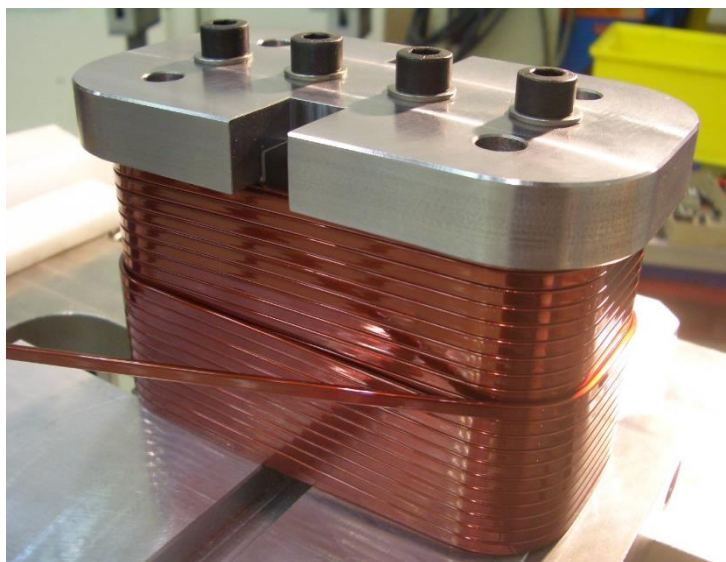

Projects – at CERN

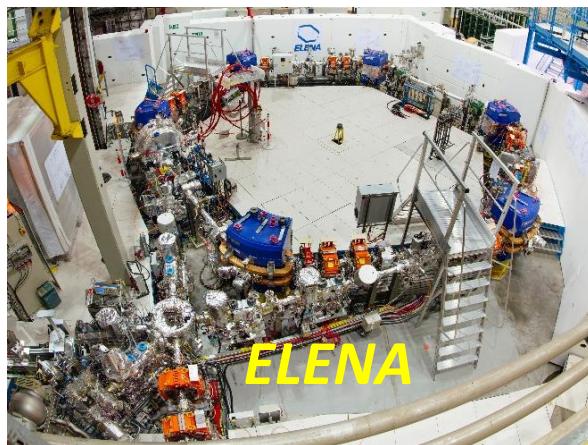

Projects – outside CERN



Projects – The Future

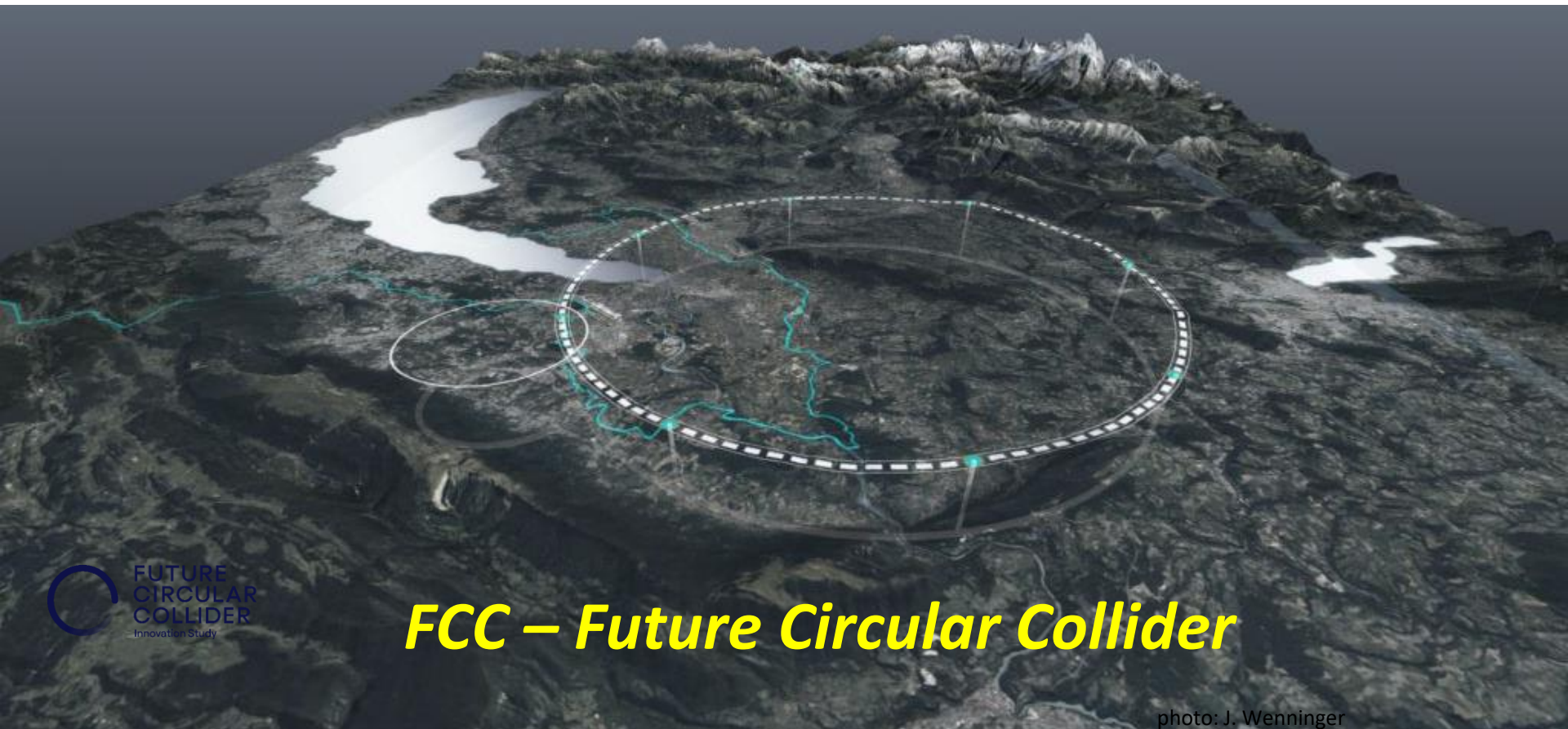

FCC energy efficient magnets

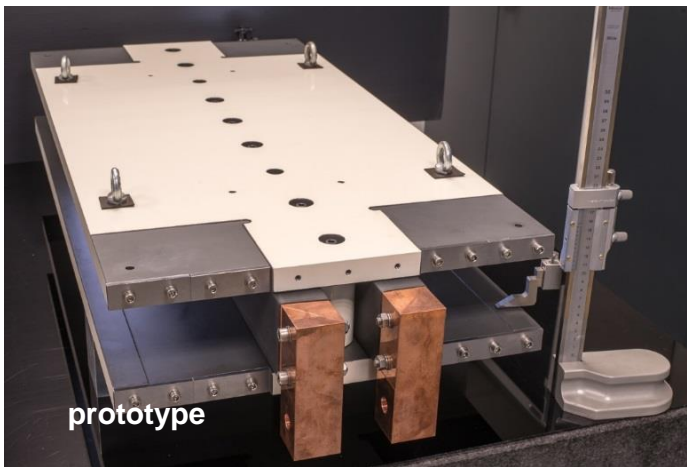
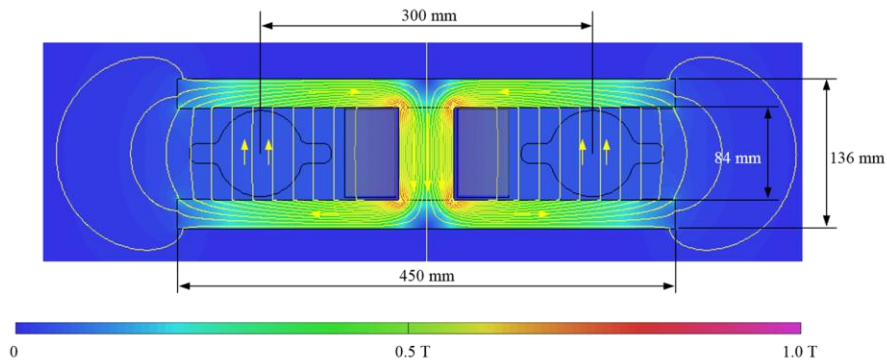

Twin-aperture dipole

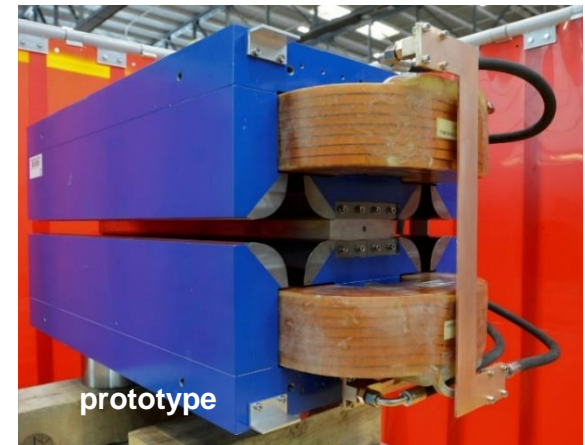
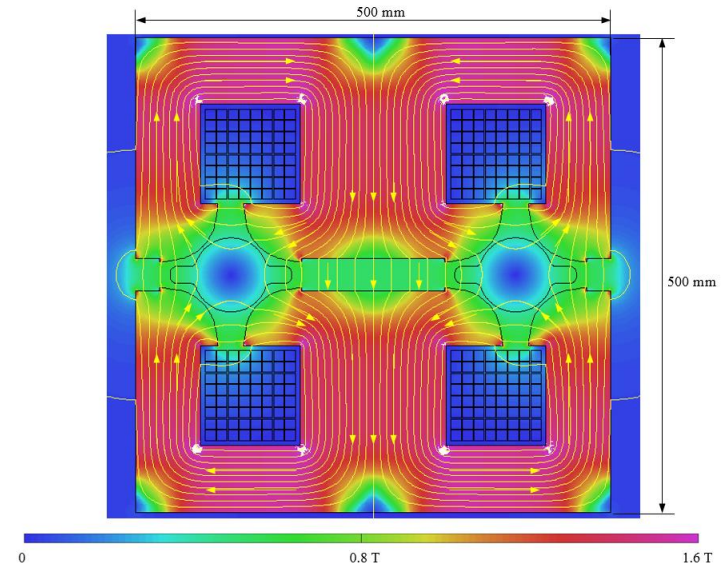

Twin-aperture quadrupole

Program and Organization of Practical days

- Up to 12 participants/days, shared in two groups
- Split into two half-day sessions
 - Magnet manufacture and testing
 - Magnetic measurements
- Hands-on practical work in CERN laboratories
- Guided by CERN magnet engineers

Magnet Manufacture and Testing

- Introduction to magnet manufacture (1h)
 - Materials for magnets
 - Magnet components
 - Manufacturing technologies
 - Yoke manufacturing
 - Coil winding and impregnation
 - Testing and measurement techniques
- Practical work in magnet test facility (2h30')
 - Participants will perform tests and measurements on magnets
 - Measurements on systems and apparatus using instruments and formulae learned during the theoretical courses

Magnet Manufacture

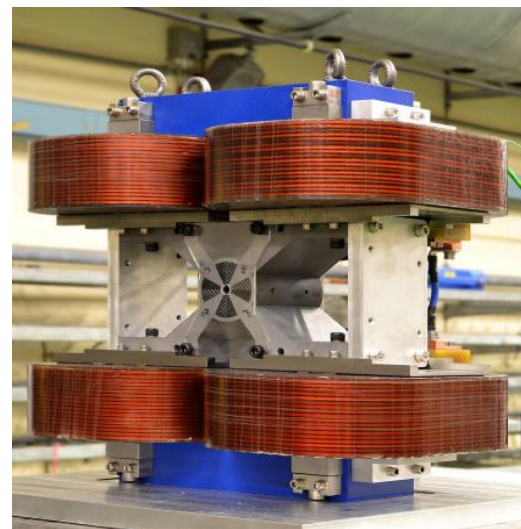
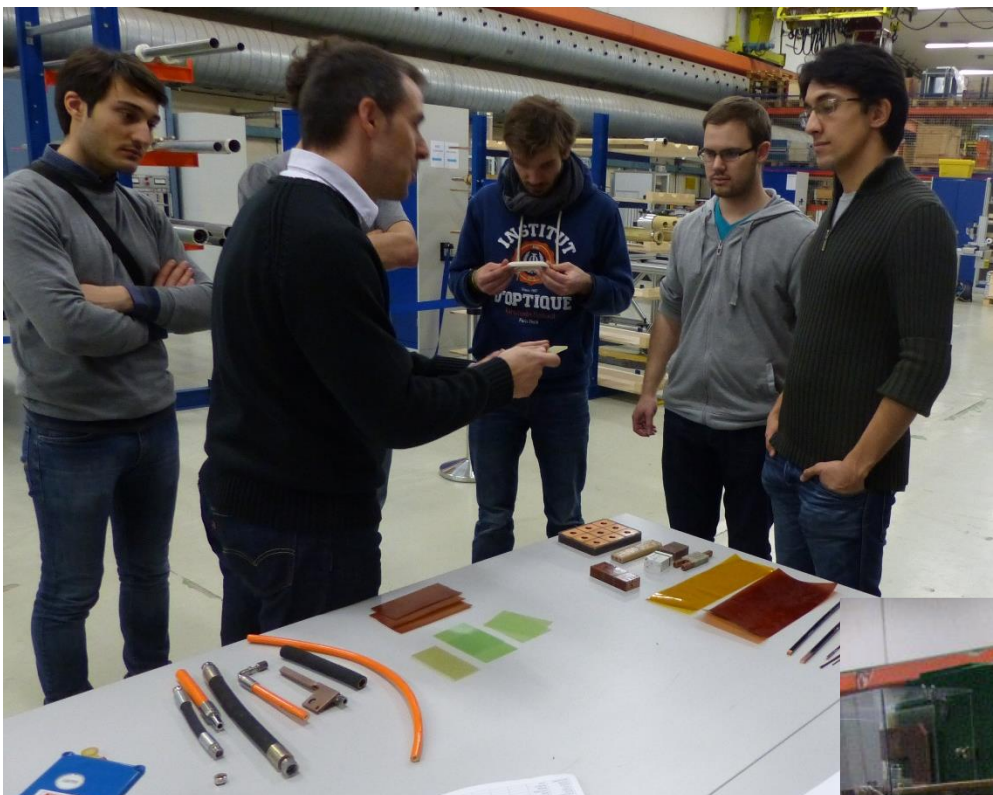

Materials, technologies,
components, manufacturing
processes, and assembly
techniques

Magnet Testing and Practical Applications

Use of analytical formulae and measurements systems to calculate magnet parameters

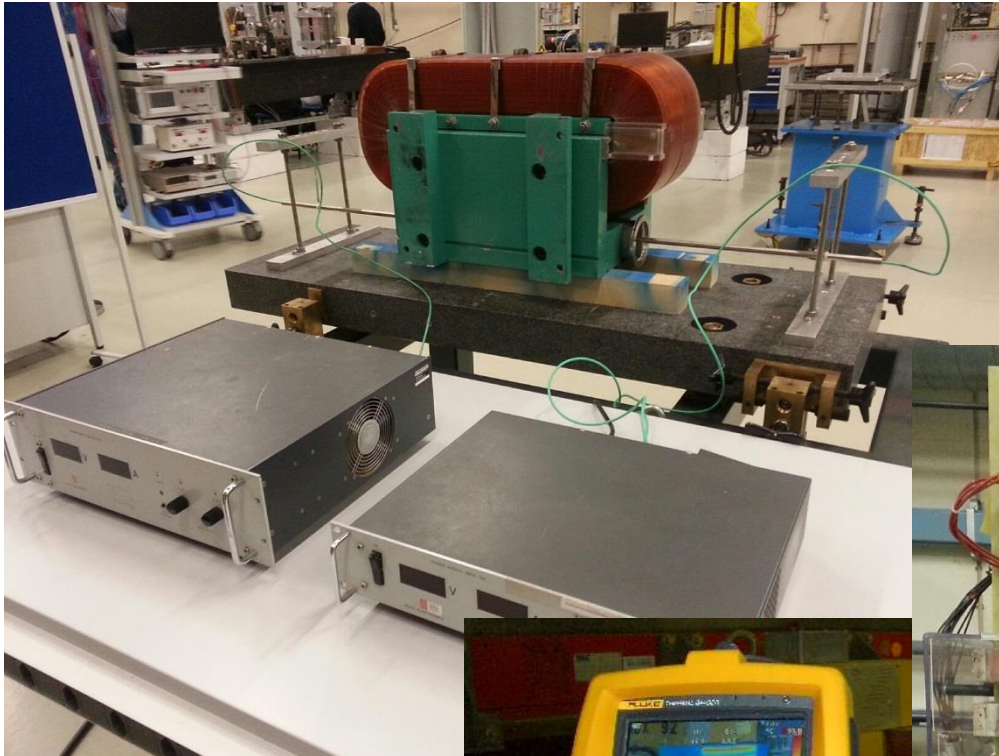

Testing magnets to assess their functionality and reliability

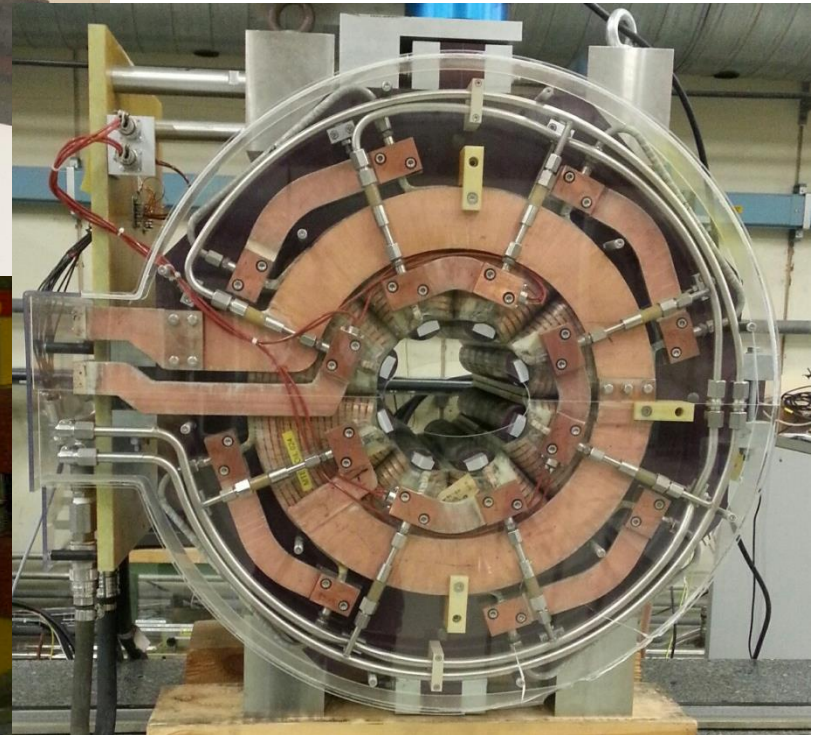

We are
looking
forward...



...to welcome
you at CERN

... and
unravel the
mysteries of
the magnets

...in a *relaxed* atmosphere!