

# 2025 Joint Universities Accelerator School

## Superconducting Magnets Section IV

**Paolo Ferracin**

*([pferracin@lbl.gov](mailto:pferracin@lbl.gov))*

Lawrence Berkeley National Laboratory (LBNL)

- **Section I**
  - Particle accelerators and magnets
  - Superconductivity and practical superconductors
- **Section II**
  - Magnetic design
- **Section III**
  - Coil fabrication
  - Forces, stress, pre-stress
  - Support structures
- **Section IV**
  - **Quench, protection, training**

## ● **Quench, protection, and training**

- K.-H. Mess, P. Schmuser, S. Wolff, “*Superconducting accelerator magnets*”, Singapore: World Scientific, 1996.
- Martin N. Wilson, “*Superconducting Magnets*”, 1983.
- Fred M. Asner, “*High Field Superconducting Magnets*”, 1999.
  
- P. Ferracin, E. Todesco, S. Prestemon, “*Superconducting accelerator magnets*”, US Particle Accelerator School, [www.uspas.fnal.gov](http://www.uspas.fnal.gov).
- E. Todesco, “Masterclass - Design of superconducting magnets for particle accelerators”, <https://indico.cern.ch/category/12408/>
  
- Presentations from Luca Bottura and Martin Wilson
  
- A. Devred, “*Quench origins*”, AIP Conference Proceedings 249, edited by M. Month and M. Dienes, 1992, p. 1309-1372.
- E. Todesco, “*Quench limits in the next generation of magnets*”, CERN-2013-006.
- L. Bottura, “*Magnet quench 101*”, CERN-2013-006.

## quench

/kwen(t)SH/

verb

verb: **quench**; 3rd person present: **quenches**; past tense: **quenched**; past participle: **quenched**; gerund or present participle: **quenching**

1. **satisfy (one's thirst) by drinking.**

- **satisfy (a desire).**

"he only pursued her to quench an aching need"

Similar: satisfy slake sate satiate gratify relieve assuage ▾

2. **extinguish (a fire).**

"firemen hauled on hoses in a desperate bid to quench the flames"

Similar: extinguish put out snuff out smother douse dampen down

- **stifle or suppress (a feeling).**

"fury rose in him, but he quenched it"

3. **rapidly cool (red-hot metal or other material), especially in cold water or oil.**

- **PHYSICS • ELECTRONICS**

**suppress** or **damp** (an effect such as **luminescence**, or an **oscillation** or discharge).

noun

noun: **quench**; plural noun: **quenches**

an act of quenching something very hot.

### Origin

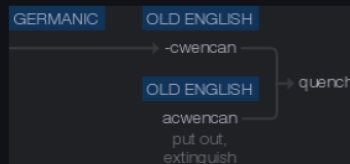

Old English *-cwencan* (in *acwencan* 'put out, extinguish'), of Germanic origin.

### Use over time for: quench



verb

1. spegnere
2. smorzare

See More →

- Current **ramp-up** (magnet powering, excitation)
  - Increase of bore and coil/conductor field
    - **Load line**
  
- **Target**
  - Achieve operational current/field
    - Usually at about **80%** of maximum  $I$  or **short sample current  $I_{ss}$** 
      - i.e. **not too close** to the critical surface
  
- What if you continue to increase  $I$ ?

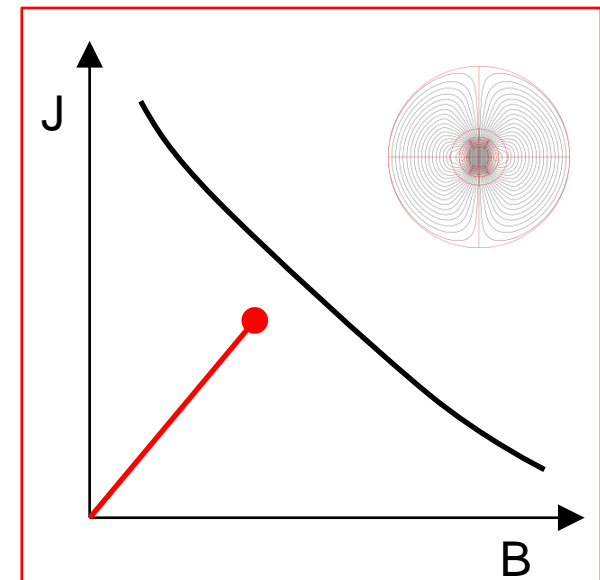
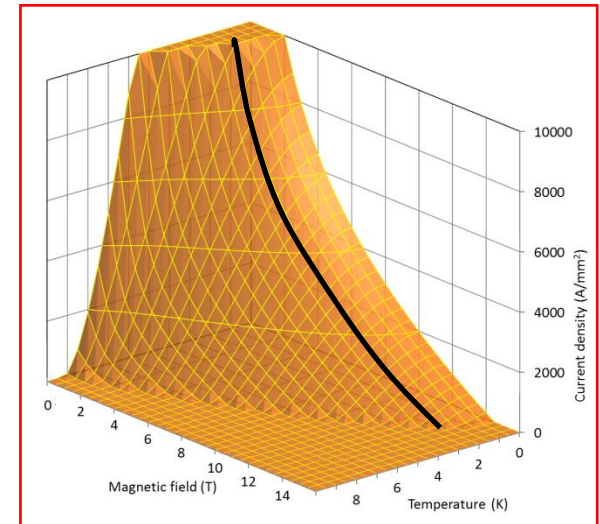

- First scenario
  - Critical **surfaces** is passed by increasing the **current**
    - The superconductor still carries the critical current at  $T_{CS}$
    - The rest flows in the stabilizer → **power dissipation**
  - If power high enough and cooling low enough
    - Temperature of the superconductor increases → critical current decreases
      - More current in the stabilizer, less in the superconductor → more dissipation
    - Irreversible transition → **quench** → **propagation**

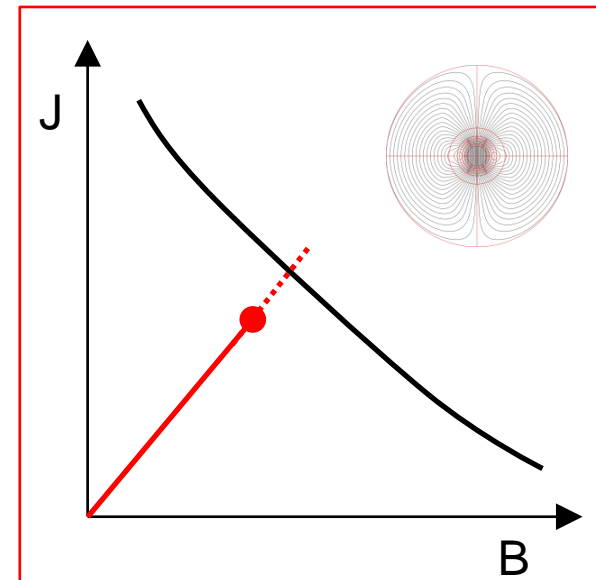
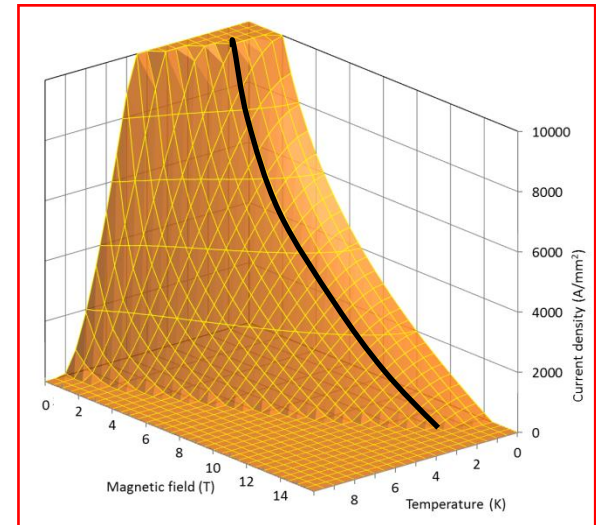

- **Conductor-limited quench**

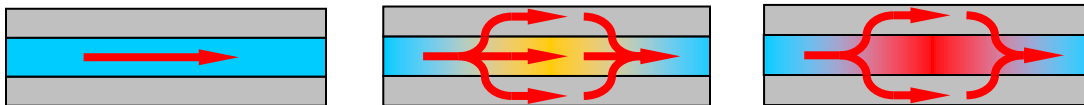

by L. Bottura

- Other scenario

- Disturbance** → release of energy → increase the temperature of the conductor
    - The superconductor still carries the critical current at  $T_{cs}$
    - The rest flows in the stabilizer → **power dissipation**
  - If power high enough and cooling low enough
    - Temperature of the superconductor increases → critical current decreases
      - More current in the stabilizer, less in the superconductor → more dissipation
    - Irreversible transition → **quench** → **propagation**

- Energy-deposited** or **premature quenches**

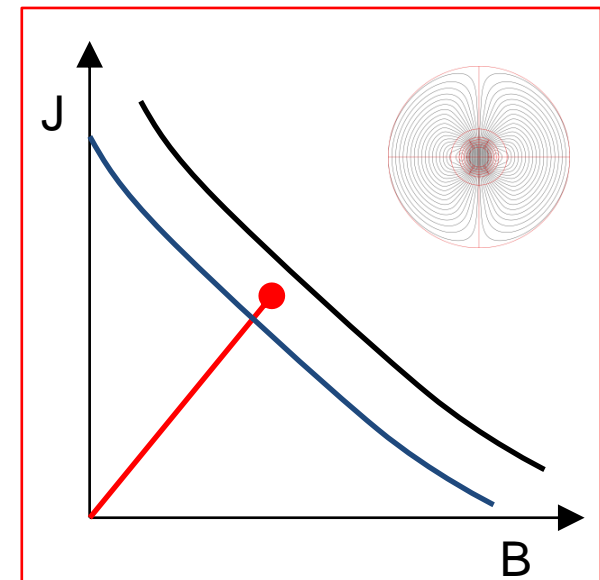
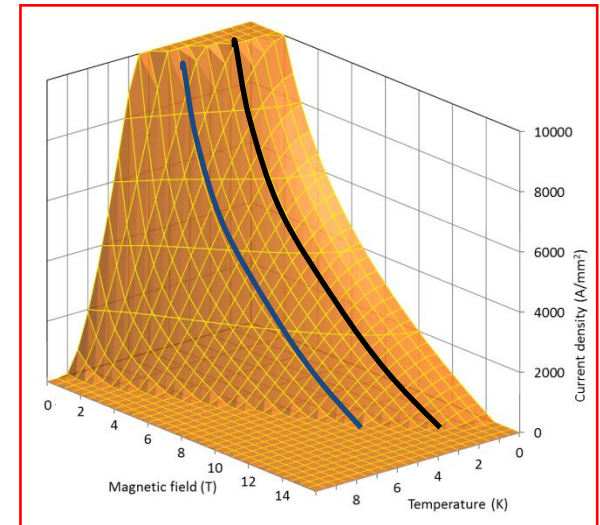
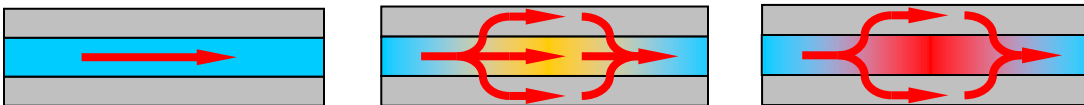

- In other words
  - *Conductor-limited quench*
    - critical surface is crossed because of an increase of  $I$  (and  $B$ )
  - *Energy-deposited* or *premature quenches*
    - critical surface is crossed because of an increase of  $T$

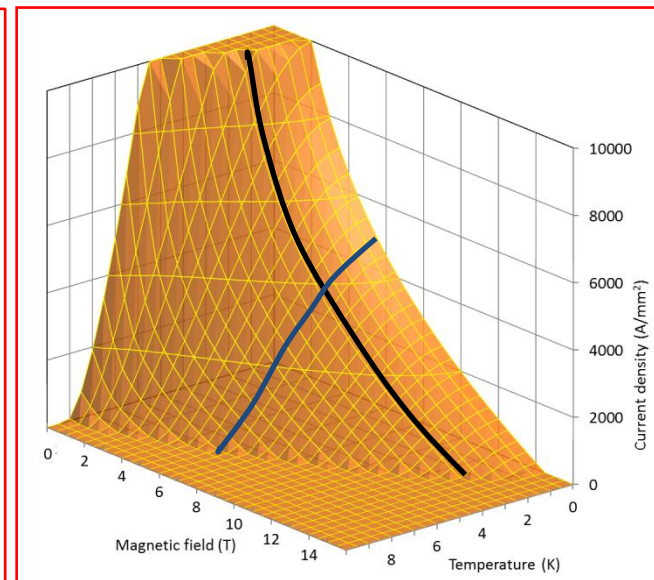
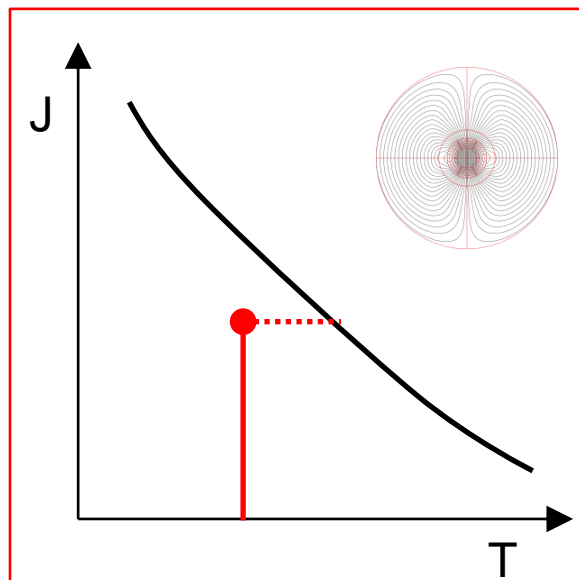
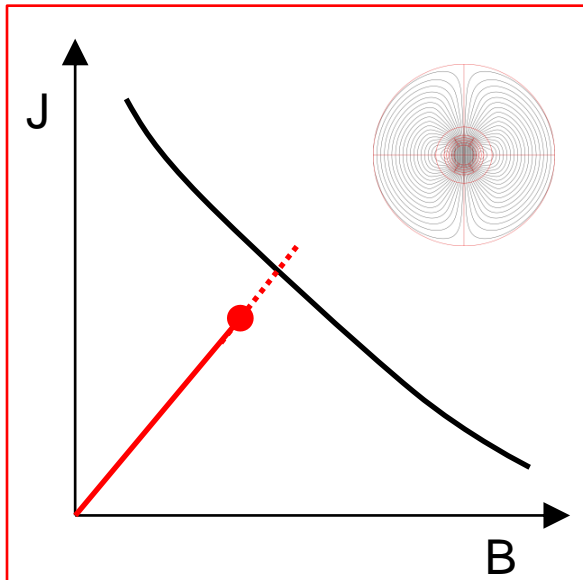



- Which are these **disturbances**?
- We can define a spectrum of disturbances, which classifies the energy disturbances along two dimensions: time and space (M. Wilson).

		Space	
		Point	Distributed
Time	Transient	J	J/m <sup>3</sup>
	Continuous	W	W/m <sup>3</sup>

- **Continuous disturbances** are due to a steady power dissipations
  - Point: ramp **splice** with high resistance joint
  - Distributed: **a.c. losses** in the conductor, **thermal leak** of the cryo-system.
- They are usually well understood disturbances.

		Space	
		Point	Distributed
Time	Transient	J	$\text{J}/\text{m}^3$
	Continuous	W	$\text{W}/\text{m}^3$

- **Transient disturbances** are due to a sudden release of energy, either over a small volume (J) or over a large volume ( $\text{J}/\text{m}^3$ )
  - **Flux jumps**: dissipative redistribution of magnetic field within the superconductor
    - It can be eliminated with small filaments.
  - **Mechanical disturbances**: wire frictional motion, epoxy cracking
    - They are less predictable and difficult to avoid, since they are related to mechanical design, material properties, fabrication processes, etc.

- **Epoxy cracking**

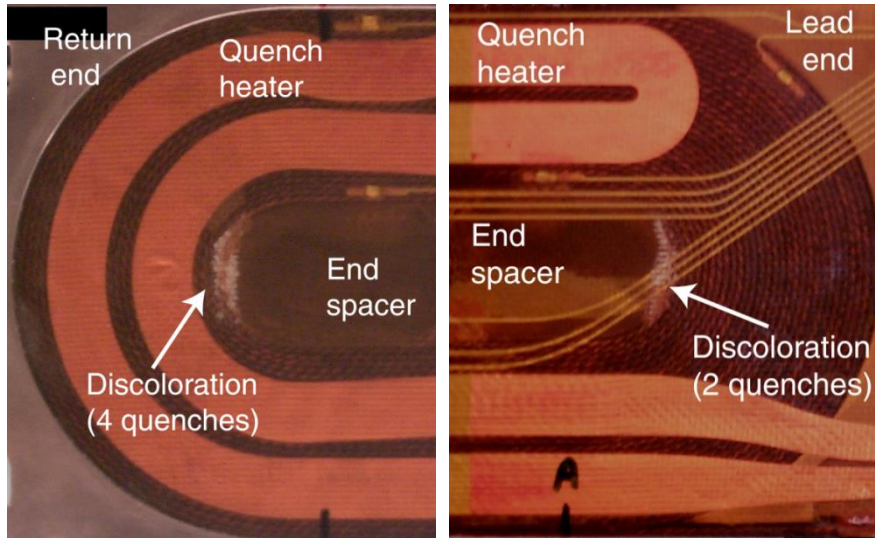

- **Frictional motion**

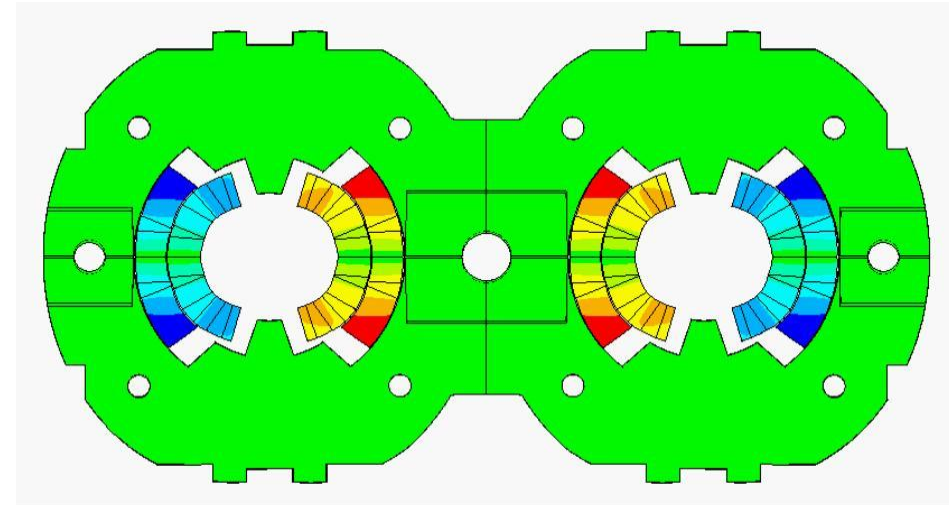

- In order to reduce the **occurrence of a quench**, one has to act on multiple fronts.
- These fronts can be seen as the different terms of a **heat equation** along a superconducting wire, that is

$$\begin{array}{ccccccc}
 \text{Heat} & \text{Heat} & \text{Joule} & & & & \\
 \text{capacity} & \text{source} & \text{heat} & \text{Conduction} & & & \text{cooling} \\
 \\
 \boxed{C \frac{\partial T}{\partial t}} = & \boxed{q_{ext}} + \boxed{q_J} + & \boxed{\frac{\partial}{\partial x} \left( \kappa \frac{\partial T}{\partial x} \right)} - & \boxed{\frac{wh}{A} (T - T_{he})} \\
 & \text{generation} & & \text{Heat transfer}
 \end{array}$$

- Increase of temperature of a superconductor is linked to
  - the **heat** coming from the **disturbance**,
  - the **ohmic heat** generated once the transition to normal conductivity occurs,
  - and the **heat removed** by conduction along the wire and by the cooling liquid.

- More in general, the equation describes the concept of *stability of a superconductor*
  - capability of a superconductor, and of the cooling system, to withstand a thermal input.
- Lets focus on the importance of the *stabilizer*.

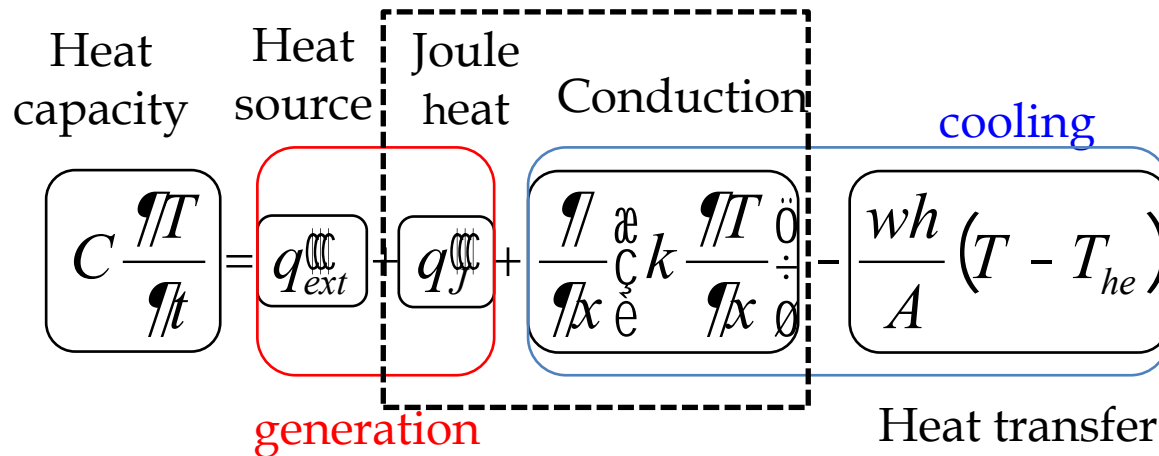

- Let's imagine that
  - a certain amount of energy  $E$  is released.
  - a volume  $V$  of the superconductor to a temperature  $T \geq T_c$ .
  - if  $E$  or  $V$  are **not large enough**  $\rightarrow$ 
    - the temperature of the superconductor **will decrease** to below the critical temperature, because of cooling and or thermal conductivity.
  - If, on the other hand,  $E$  or  $V$  **are large enough**  $\rightarrow$ 
    - the normal zone **will increase** and a quench propagate.

- More in general, the equation describes the concept of *stability of a superconductor*
  - capability of a superconductor, and of the cooling system, to withstand a thermal input.
- Lets focus on the importance of the *stabilizer*.

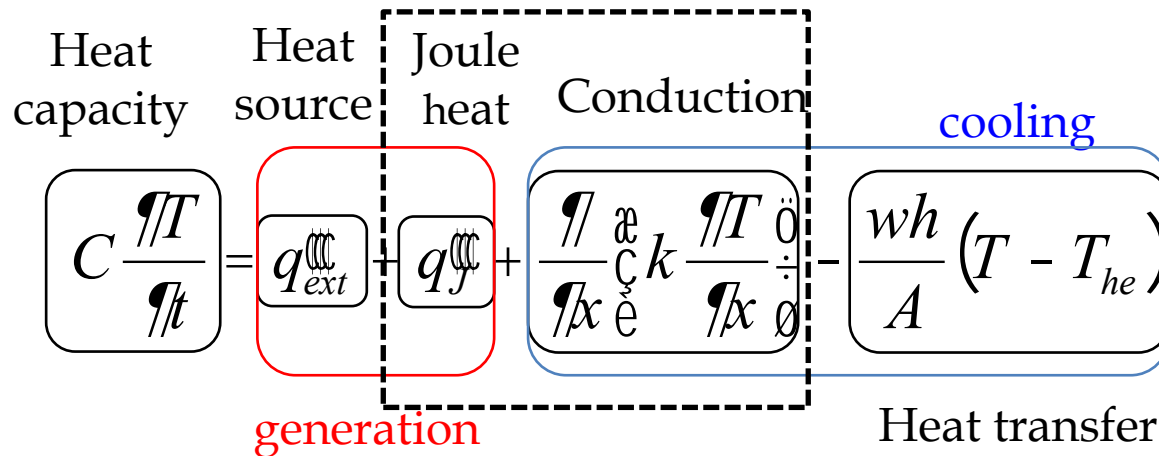

- We therefore can define
  - as *minimum quench energy MQE*, the minimum energy necessary to initiate a quench;
  - as *minimum propagation zone MPZ*, the minimum volume of superconductor that must be brought beyond the critical temperature in order to initiate a quench.
  - The two parameters are connected: MQE is the energy necessary to created MPZ.

- Wire made purely of superconductor at  $\theta_0$ .
- Energy  $E$  increases the temp. beyond  $\theta_c$  over a length  $l$ .
- $l$  dissipates  $J_c^2 \rho A l$  [W].
- Thermal gradient  $\sim (\theta_c - \theta_0)/l$ .

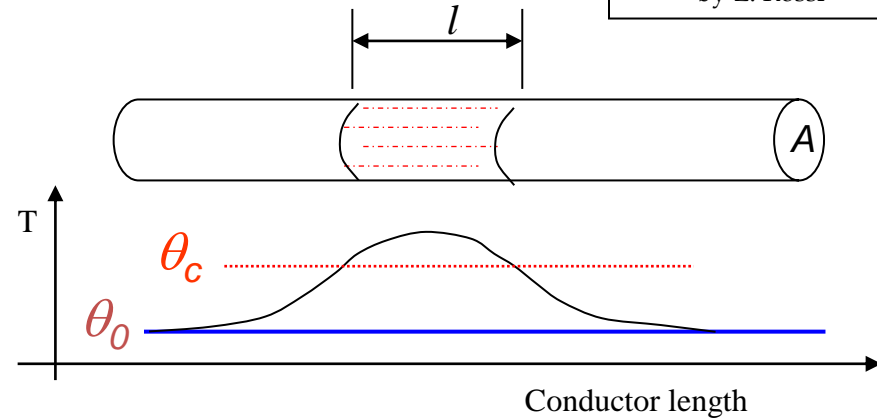

$$\left( \frac{dT}{dx} \right)_{sc} = \left( \frac{dT}{dx} \right)_{ns} + q_{j} + \left( \frac{1}{\rho} \frac{d}{dx} \left( k \frac{dT}{dx} \right) - \frac{wh}{A} T_{he} \right)$$

$$\frac{2kA(\theta_c - \theta_0)}{l} = J_c^2 \rho A l$$

$$l = \sqrt{\frac{2k(\theta_c - \theta_0)}{J_c^2 \rho}}$$

- When power dissipated = power conducted
- For a Nb-Ti 6 T magnet  $l = 0.5 \mu\text{m}$  and, with 0.3 mm diameter, the required energy is  $10^{-9}$  J.
- we have to increase  $k/\rho$ : composite conductor!

- Composite conductor: increase  $k/\rho$  by almost a factor  $10^7$ .
  - Nb-Ti vs. Cu
    - $\rho = 6.5 \times 10^{-7}$  vs.  $3 \times 10^{-10}$  [ $\Omega$  m]
    - $k = 0.1$  W vs. 350 [ $\text{W m}^{-1} \text{K}^{-1}$ ]
- Three phases
  - All current in the supercond.
  - **Current shared** by the supercond. and stabilizer
  - All current in the stabilizer.
- **MQE**: increased from the nJ to the 10-100  $\mu\text{J}$  level
- **MPZ**: from the  $\mu\text{m}$  to the mm level.

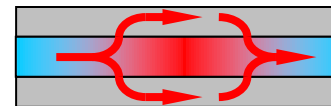
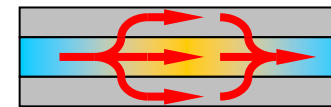



- **Section I**
  - Particle accelerators and magnets
  - Superconductivity and practical superconductors
- **Section II**
  - Magnetic design
- **Section III**
  - Coil fabrication
  - Forces, stress, pre-stress
  - Support structures
- **Section IV**
  - Quench, **protection**, training

# Quench protection Propagation

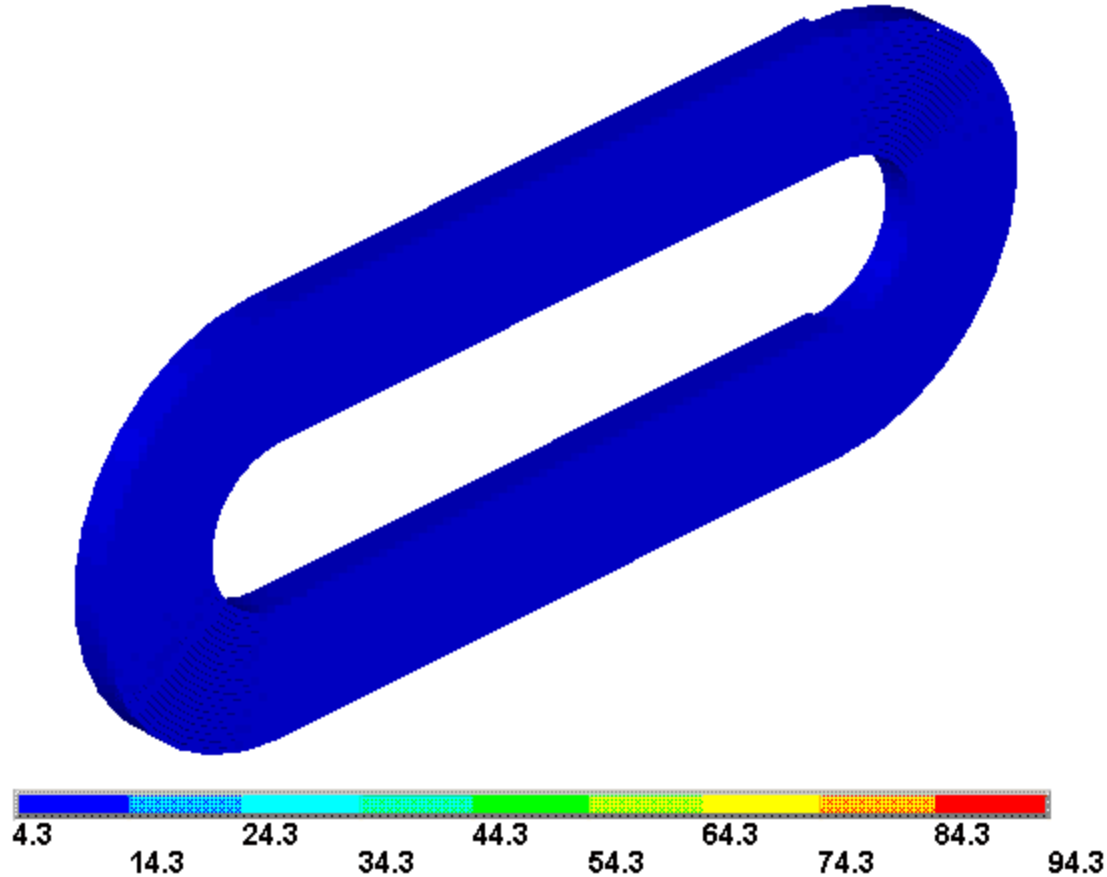

- Quench represents a dangerous situation

$$C \frac{\partial T}{\partial t} = q_{ext} + q_J + \frac{\partial}{\partial x} \left( k \frac{\partial T}{\partial x} \right) - \frac{wh}{A} (T - T_{he})$$

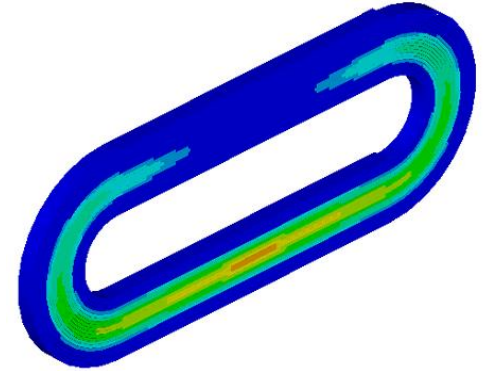

- Joule heating → **hot spot temperature**

- Goal of the quench **protection system**

- Limit hot spot temperature to avoid conductor/coil degradation
  - Limit thermal stress due to different thermal expansion in the coil
  - Avoid material damage (resins)
- In most cases **room temperature** is considered to be safe

- Analysis strategy: **adiabatic condition** →  $C \frac{\partial T}{\partial t} = q_J$

- Adiabatic conditions

$$C \frac{\partial T}{\partial t} = q_J'''$$

$$\int_0^{\infty} [I(t)]^2 dt = \nu A^2 \int_{T_0}^{T_{\infty}} \frac{c_p^{ave}(T)}{\rho_{Cu}(T)} dT$$

- Where  $I$  is the magnet current,  $\nu$  the Cu fraction,  $A$  the cable cross-sectional area,  $c_p^{ave}$  the volumetric specific heat of the insulated cable and  $\rho_{Cu}$  the copper resistivity
- The two terms are expressed in **MIITS**
- If  $T_{\infty} = T_{max}$   $\rightarrow$  The right term gives the max # of MIITS to keep the peak temperature below  $T_{max}$
- The faster the drop in current, the lower the  $T_{\infty}$ 
  - How do we accelerate the drop in current?

- Once the quench starts propagating, the magnet can be seen as a **L/R circuit**

- Therefore

$$I = I_0 \exp\left(-t \frac{R(t)}{L}\right)$$

- We need to **maximize R**
- Quench propagation is **not enough**
  - ~10-20 m/s along the cable
    - About 1 s for a 10 m long magnet
  - ~10 ms turn-to-turn
  - ~50 ms between layers
- So we need to make the entire coil resistive by heating it → **Quench heaters**

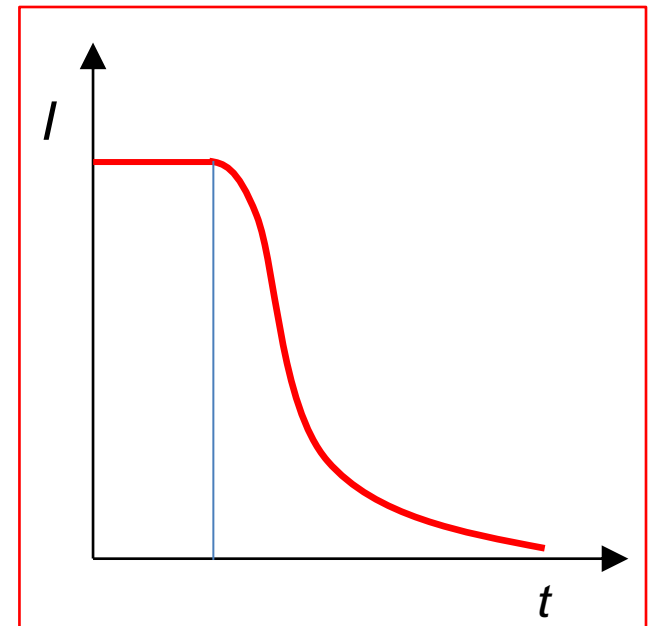
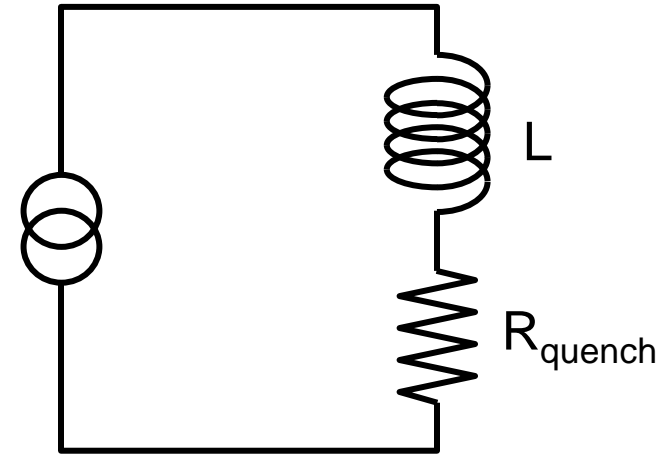

# Quench protection Quench heaters

- **Stainless steel strips** (25  $\mu\text{m}$ ) on a **polyimide sheet** (50  $\mu\text{m}$ ) with **Cu cladding** ( $\sim 10 \mu\text{m}$ ) or larger width (to **reduce V**)

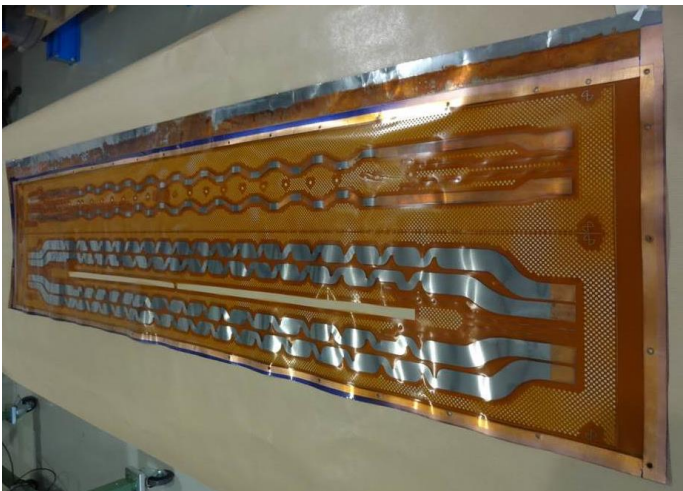
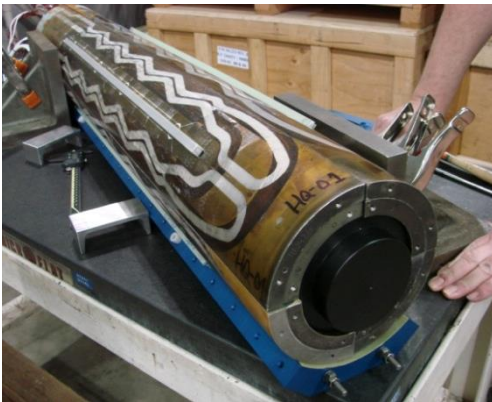

- But we need to do it as **fast** as possible

- **Detection time:** 5 to 20 ms

- $t$  needed to detect a quench
- Voltage threshold  $\sim 100$  mV
- Depends on quench velocity
  - high or low field area

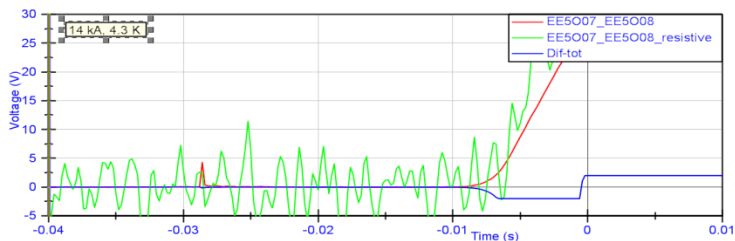

- **Validation time:** 5 to 10 ms

- To avoid false events

- **Switch opening:** 2 ms

- And then...the **quench heaters delay**

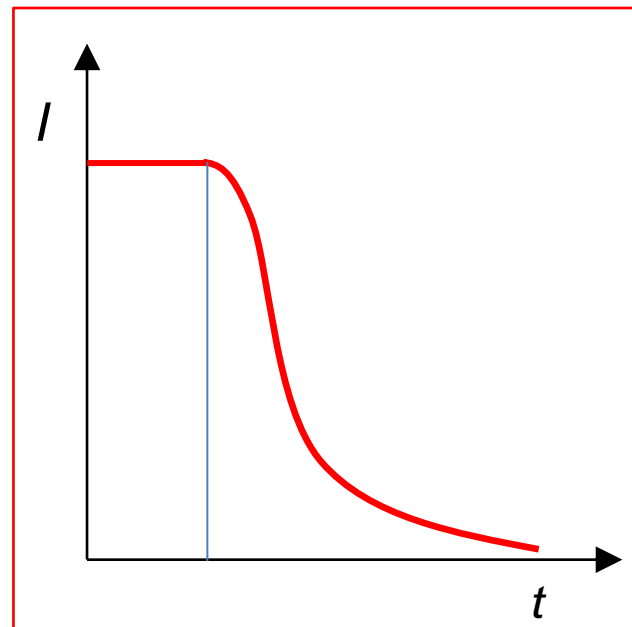
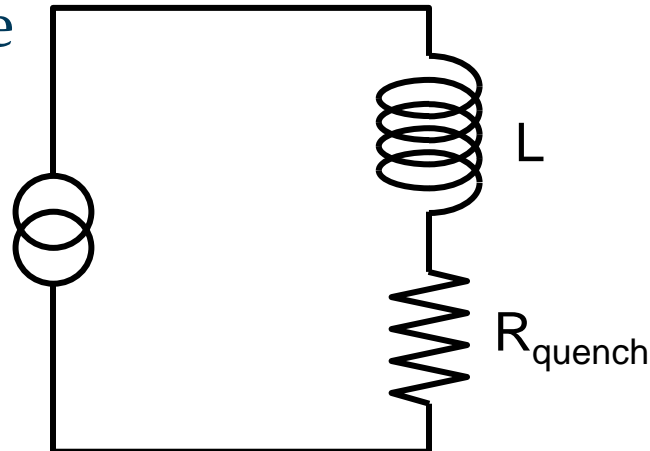



### ● Heater delay

- From the stainless steel strip to the cable through the polyimide: **~10-20 ms**
  - A factor **2.5 more** to quench to low field part of the coils
    - Higher T margin
- **Few ms** to propagate between heating stations
- Additional **5-10 ms** to quench in the low field area
- Then, **additional time** to quench the inner layer
  - Unless quench heater on inner surface

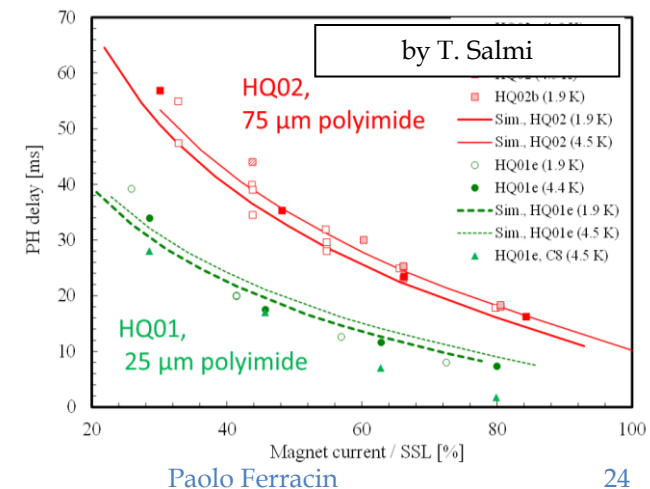
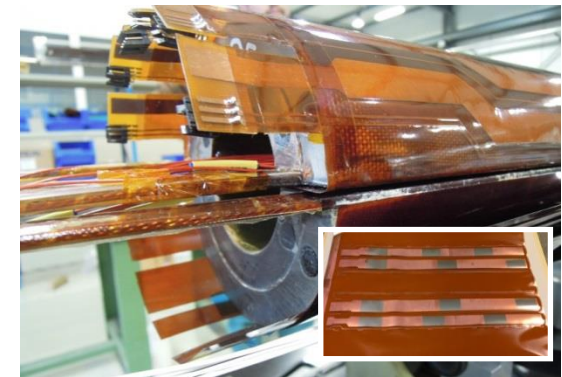
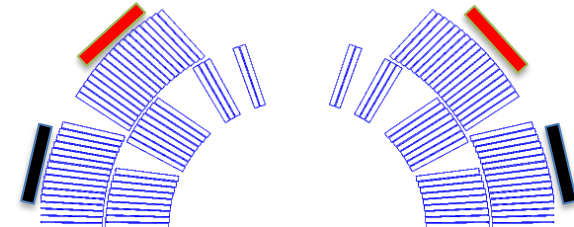



- Back to the adiabatic condition
- If  $T_\infty = T_{max}$  → The right term gives the max # of **MIITS available**
- Then the left term, assuming magnet fully resistive → **MIITS during the drop**

$$\int_0^\infty [I(t)]^2 dt = vA^2 \int_{T_0}^{T_\infty} \frac{C_p^{ave}(T)}{\rho_{Cu}(T)} dT$$

$$I = I_0 \exp\left(-t \frac{R(t)}{L}\right)$$

- The difference gives you the max # of MIITS and **time available to quench** all
  - In general for Nb-Ti: **100-200 ms**
  - For Nb<sub>3</sub>Sn **~30-50 ms** very challenging!!!
    - Higher energy densities

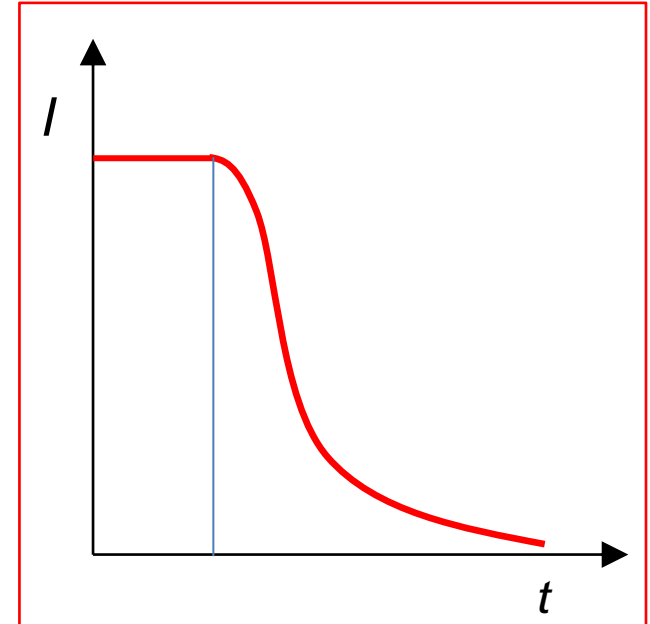

- **Section I**
  - Particle accelerators and magnets
  - Superconductivity and practical superconductors
- **Section II**
  - Magnetic design
- **Section III**
  - Coil fabrication
  - Forces, stress, pre-stress
  - Support structures
- **Section IV**
  - Quench, protection, **training**

- How do we establish if a magnet
  - reached its **limit**?
  - is **degraded**?
  - is limited by **conductor motion** or **flux jumps**?
- What is “**training**”?
- Which are the **causes**?

- Conductor limited quenches are usually very stable.
- A series of conductor limited quenches appears as a plateau.
  - For these reasons they are also called **plateau quenches**.
- After having reached the **maximum magnet current** during test of the magnet, we have to compare it with the **short sample current  $I_{ss}$** 
  - the maximum  $I$  according according to strand short sample measurements

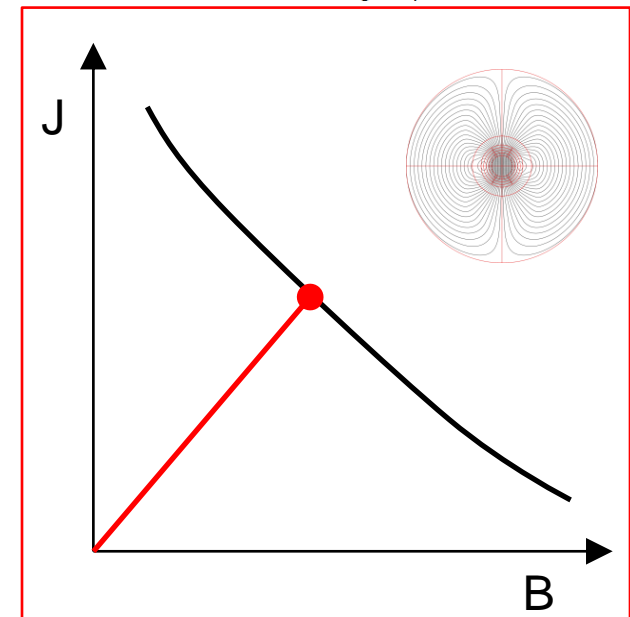
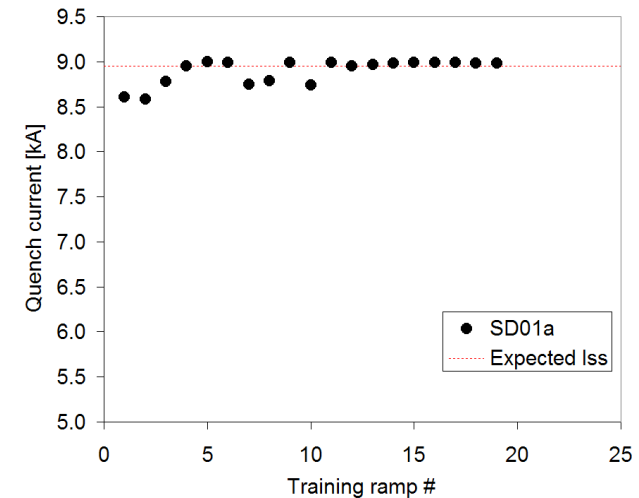

- Wire short sample on a **sample holder**
  - Cooled-down, ramped at different  $B$ 
    - Quench  $\rightarrow$  **Critical surface/curve** measured
- If during magnet test  $I_{max} = I_{ss}$ 
  - **victory!**
- A conductor-limited quench or a plateau at a level lower
  - indication of **degradation**
    - Conductor damage
    - Error in cable manufacturing
    - Stress
  - ...or **disturbances**
  - ...or error in the **computations...**

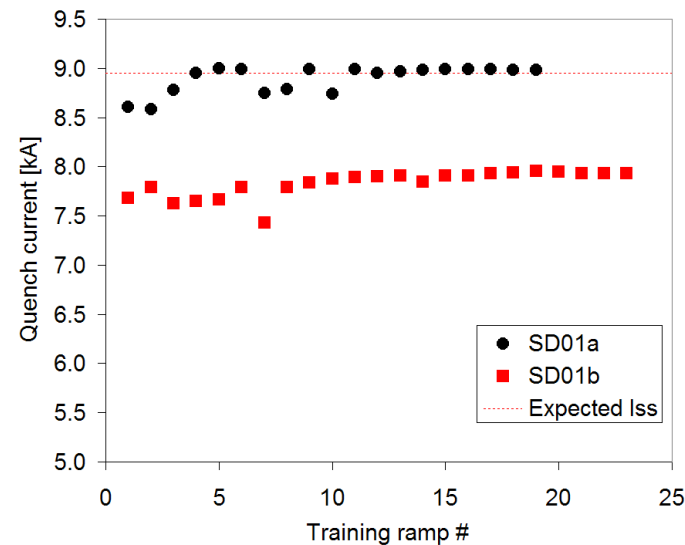
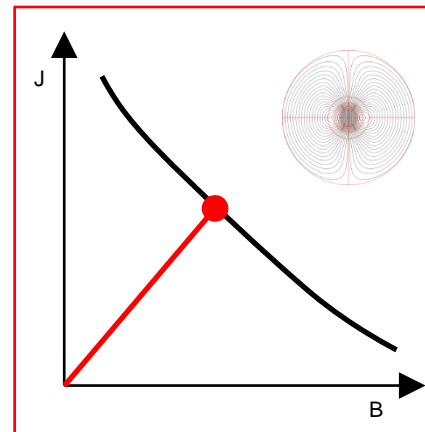

- **Voltage signal studies**

- Quench have different voltage precursors.
  - A motion or a flux jump generates a change in magnetic flux inside the winding.
  - A variation of magnetic flux results in a voltage signal detected across the coil.
- Depending on the shape of the voltage signal, it is possible to identify
  - **Conductor limited** quenches: slow, gradual resistive growth
  - **Flux jump** induced quenches: low-frequency flux changes
  - **Motion** induced quenches: acceleration-deceleration-ringing

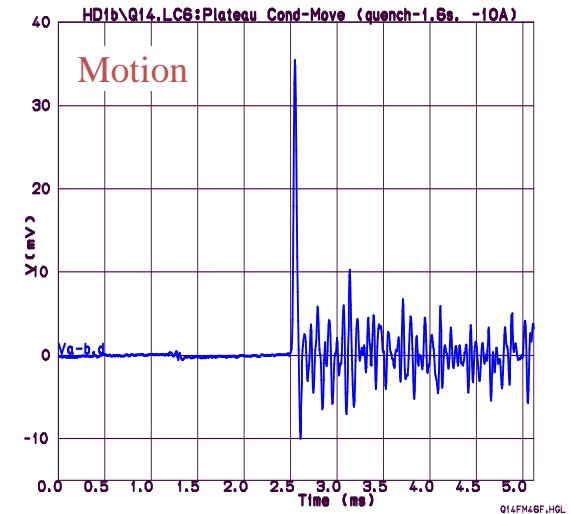
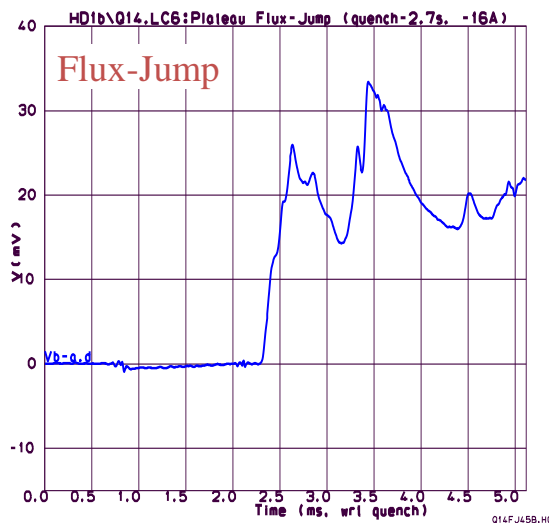
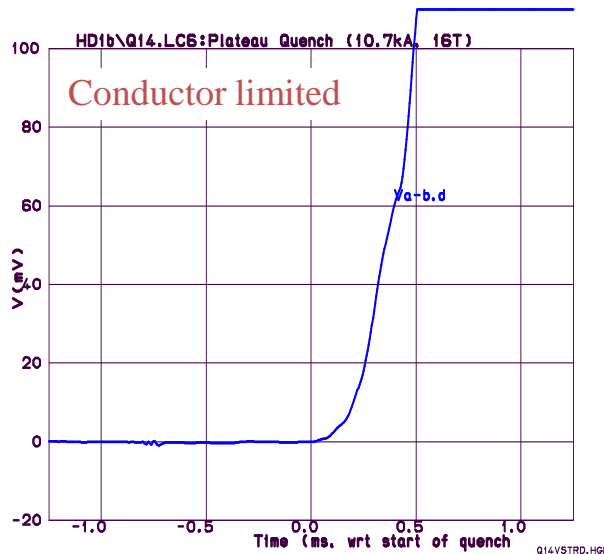

## TRAINING AND DEGRADATION PHENOMENA IN SUPERCONDUCTING MAGNETS

H. Brechna

Department of Electrical Engineering  
Federal Institute of Technology  
Zurich, Switzerland

P. Turowski

Kernforschungszentrum Karlsruhe IEKP  
Federal Republic of Germany

### I. INTRODUCTION

In the early 70's interest was centred upon a new phenomenon observed at CERN in two race track shaped epoxy impregnated coils<sup>1)</sup>. While energized for the first time, they quenched at about 30% of the measured short sample current value. After numerous runs finally design values were reached. Interestingly enough many laboratories reported shortly afterwards a similar trend in race track shaped coils and even in solenoids. The phenomenon, that after each successive quench the transport current could be raised by some fraction yielding an improved performance of the conductor until design, or short sample value is reached, was termed "training".

The word training must not be blended with degradation, which is essentially a deficiency of the superconductor, a real inadequacy in the magnet design, since the magnet may never reach the calculated and predicted field values.

### NbZr solenoid Chester, 1967

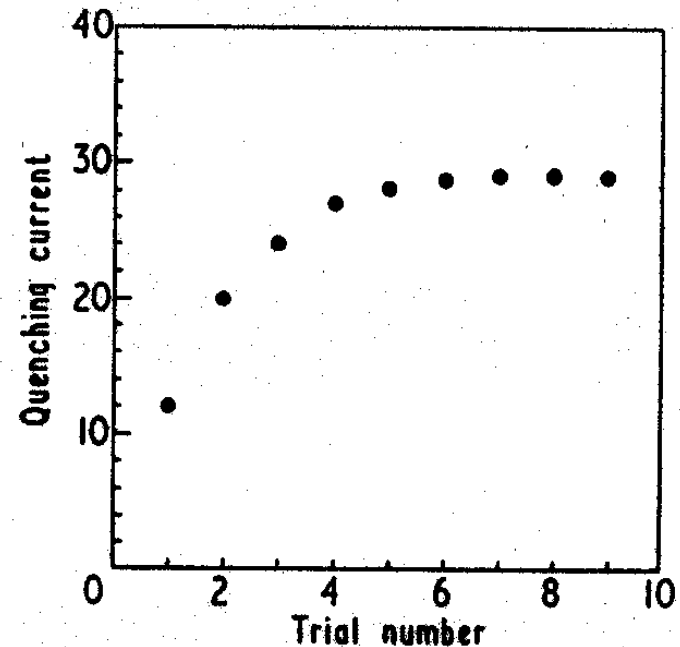

P.F. Chester, Rep. Prog. Phys., XXX, II, 561, 1967.

Proceedings of the 6<sup>th</sup> International Conference on Magnet Technology, 1978. p. 597.

- Training is characterized by two phenomena
  - The **occurrence** of premature quenches
    - Which are the causes?
  - The **progressive increase** of quench current
    - Something not reversible happens, or, in other words, the magnet is somehow “improving” or “getting better” quench after quench.
    - Some irreversible change in the coil’s mechanical status is occurring.
- In R&D magnets, training may not be an issues.
- For **accelerator magnets** it can be **expensive**
  - both in term of time and cost.

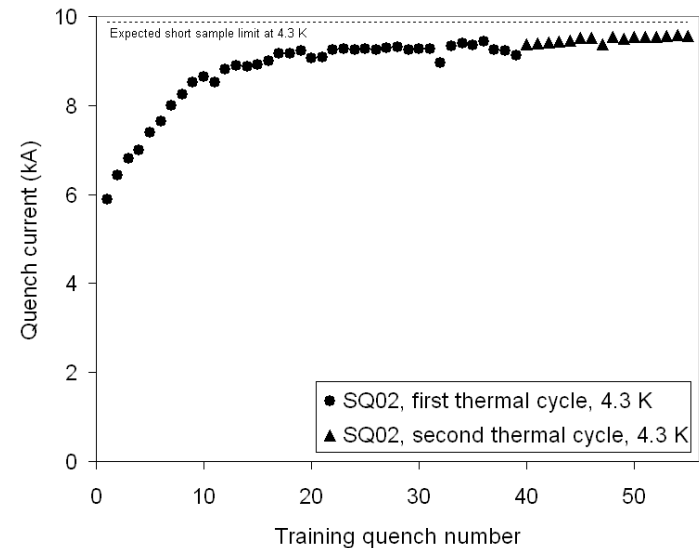
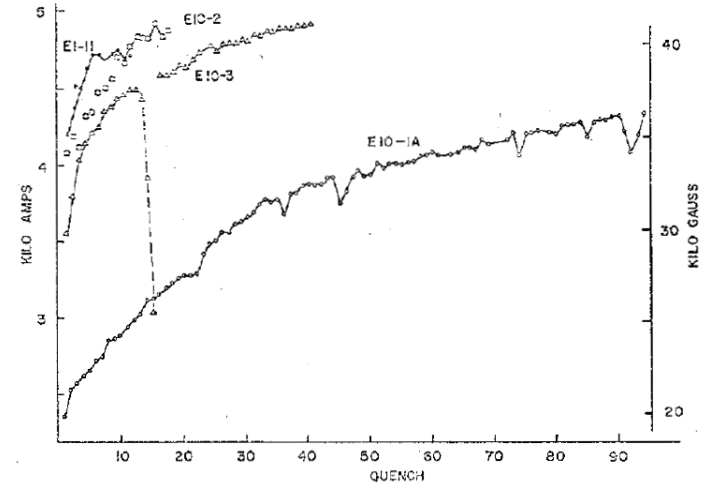



- **Mechanical induced quenches** are considered the main causes of training

- **Frictional motion**

- E.m. forces  $\rightarrow$  motion  $\rightarrow$  quench
- Coil locked by friction in a secure state

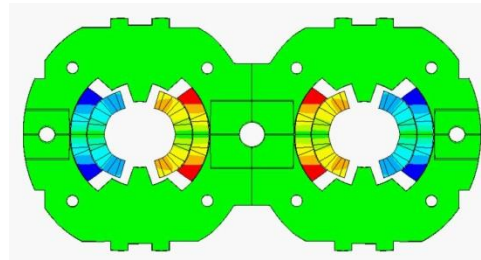

- **Epoxy failure**

- E.m. forces  $\rightarrow$  epoxy cracking  $\rightarrow$  quench
- Once epoxy locally fractured, further cracking appears only when the e.m. stress is increased.

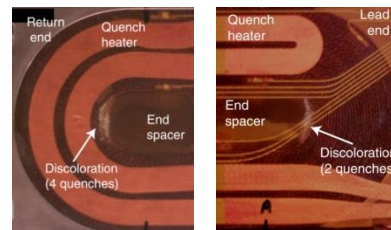

- The Coulomb friction (or static friction) model

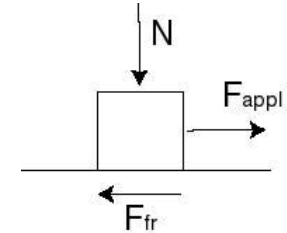

- The **friction force** is given by  $F_{fr} \leq \mu N$  where  $\mu$  is the friction factor.
- This means that the friction force depends on  $F_{app}$ 
  - If  $F_{app} \leq \mu N$ , no sliding occurs, i.e. the friction force prevent motion
  - If  $F_{app} > \mu N$ , sliding occurs, and the friction force is constant and  $= \mu N$ .
- We can use a contact pressure  $P$  instead of force  $N$ , and **frictional stress or shear stress**  $\sigma_{fr}$  instead of  $F_{fr}$ .
- The **frictional energy** dissipated per unit area  $E$  ( $\text{J}/\text{m}^2$ )

$$E = \delta \sigma_{fr}$$

- where  $\delta$  (m) is the relative sliding

- A simple analytical model has been proposed by O. Tsukamoto and Y. Iwasa.
  - A simple force cycle applied to a **spring system** shows
    - **Irreversible displacement** at the end of the first cycle
    - **Reduction** of total displacement in the second cycle

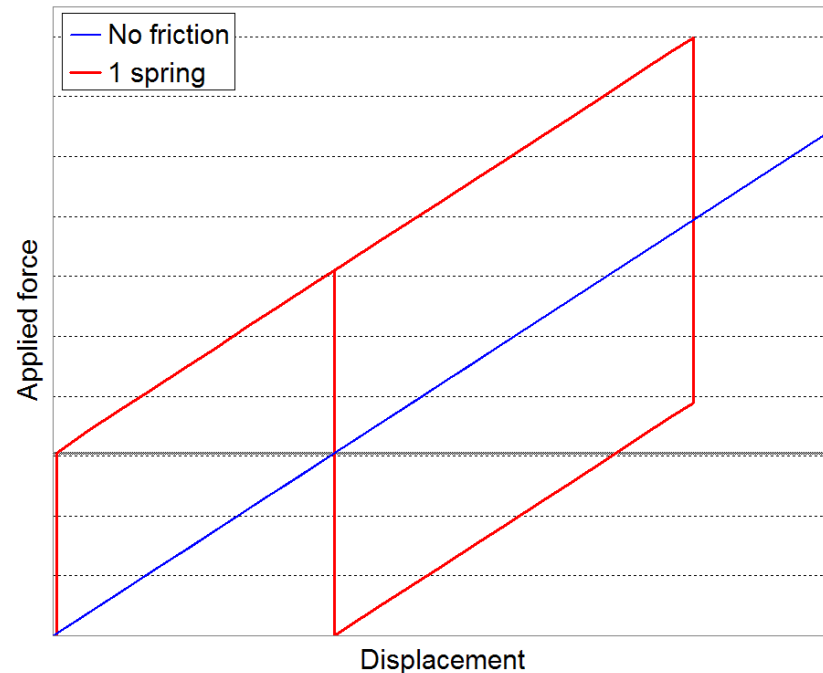
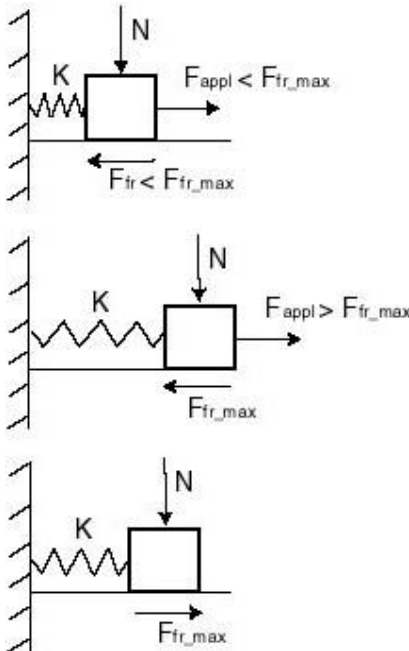
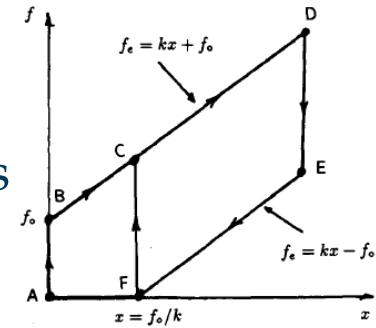

- **Acoustic emissions** measurements

- AE are emitted during frictional sliding between two surfaces (cracks)

- **Kaiser effect**

- “During a sequence of cyclic loading, mechanical disturbances such as conductor motion and epoxy fracture appear only when the loading responsible for disturbances exceeds the maximum level achieved in the previous loading sequence.”

by H. Maeda, *et al.*

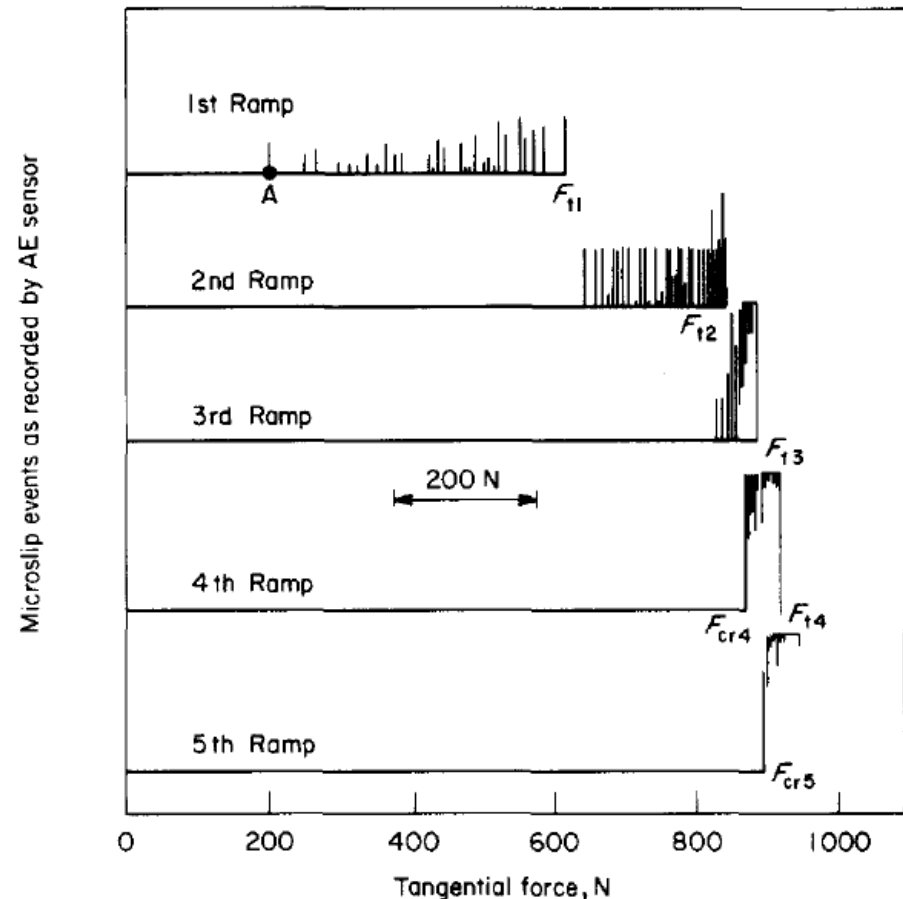

- Epoxy resin becomes **brittle** at low temperature
  - Micro-cracking or micro-fractures may occur
- The phenomenon is enhanced by the fact that the epoxy has an **high thermal contraction**
  - After cool-down the resin is in **tension**
- A brittle material in tension may experience **crack**
  - When a crack propagated, the strain energy is converted in heat.

$$Q = \frac{1}{2} \frac{\sigma^2}{E} = \frac{E \varepsilon^2}{2}$$

- To prevent it
  - fibrous reinforcement (**fiberglass**) are added
  - volume with only resin are **minimized**
  - In general, epoxy used where it is needed (Nb<sub>3</sub>Sn magnets).

by M. Wilson

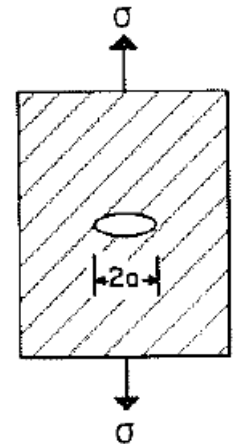

- Magnets operate with margin
  - Nominal  $I$  reached with few quenches.

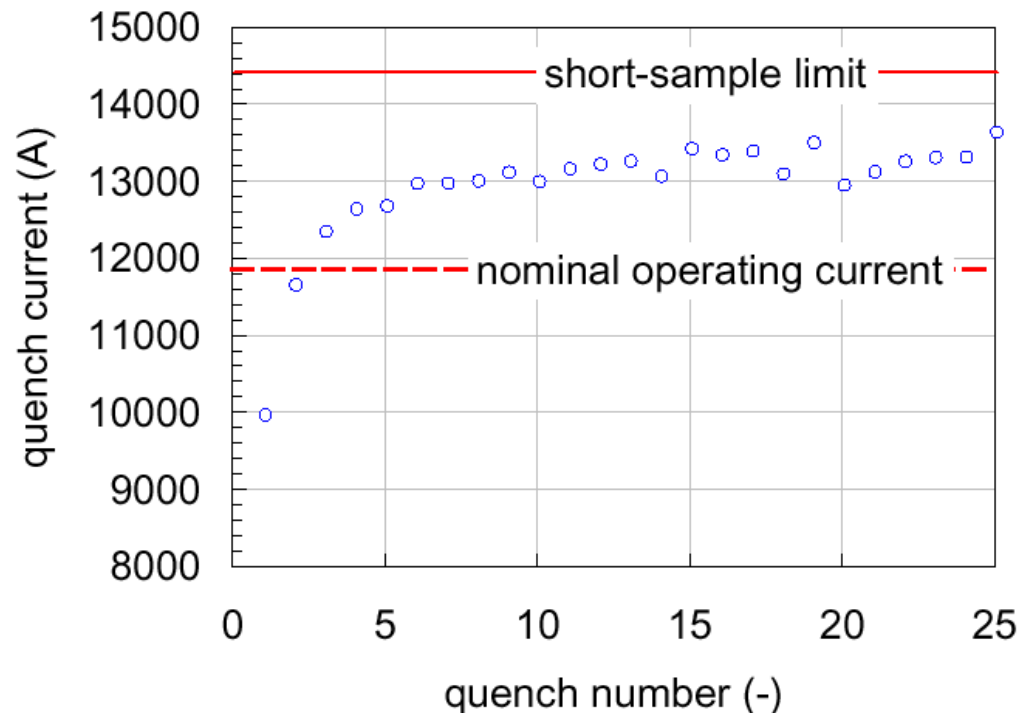

- In general, **very emotional** process



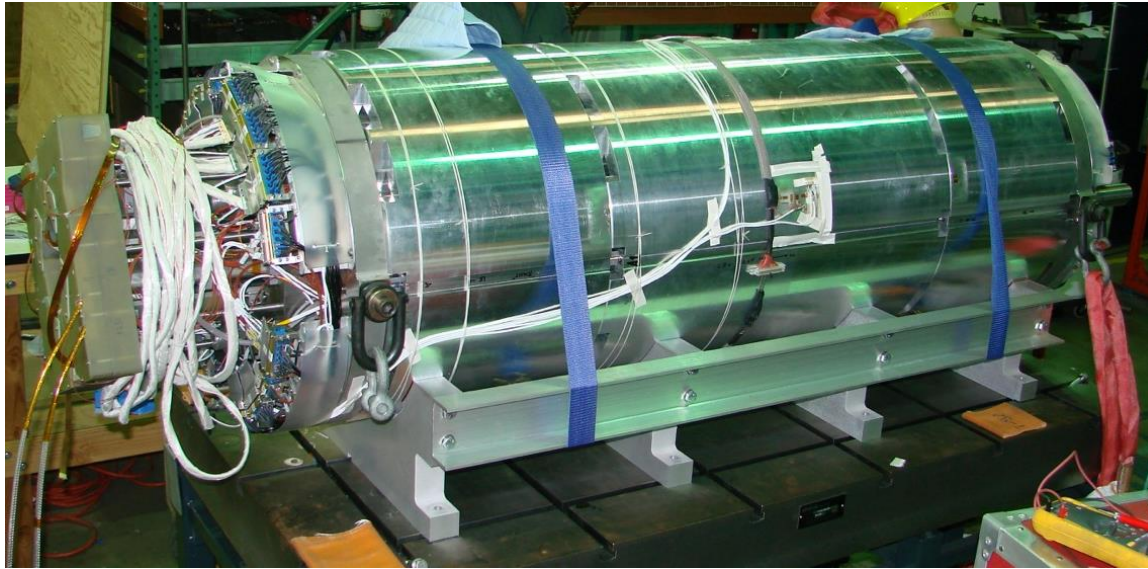

- Test at **FNAL** in 2016

# MQXFS01 test

## First test of HiLumi Nb<sub>3</sub>Sn IR quadrupole

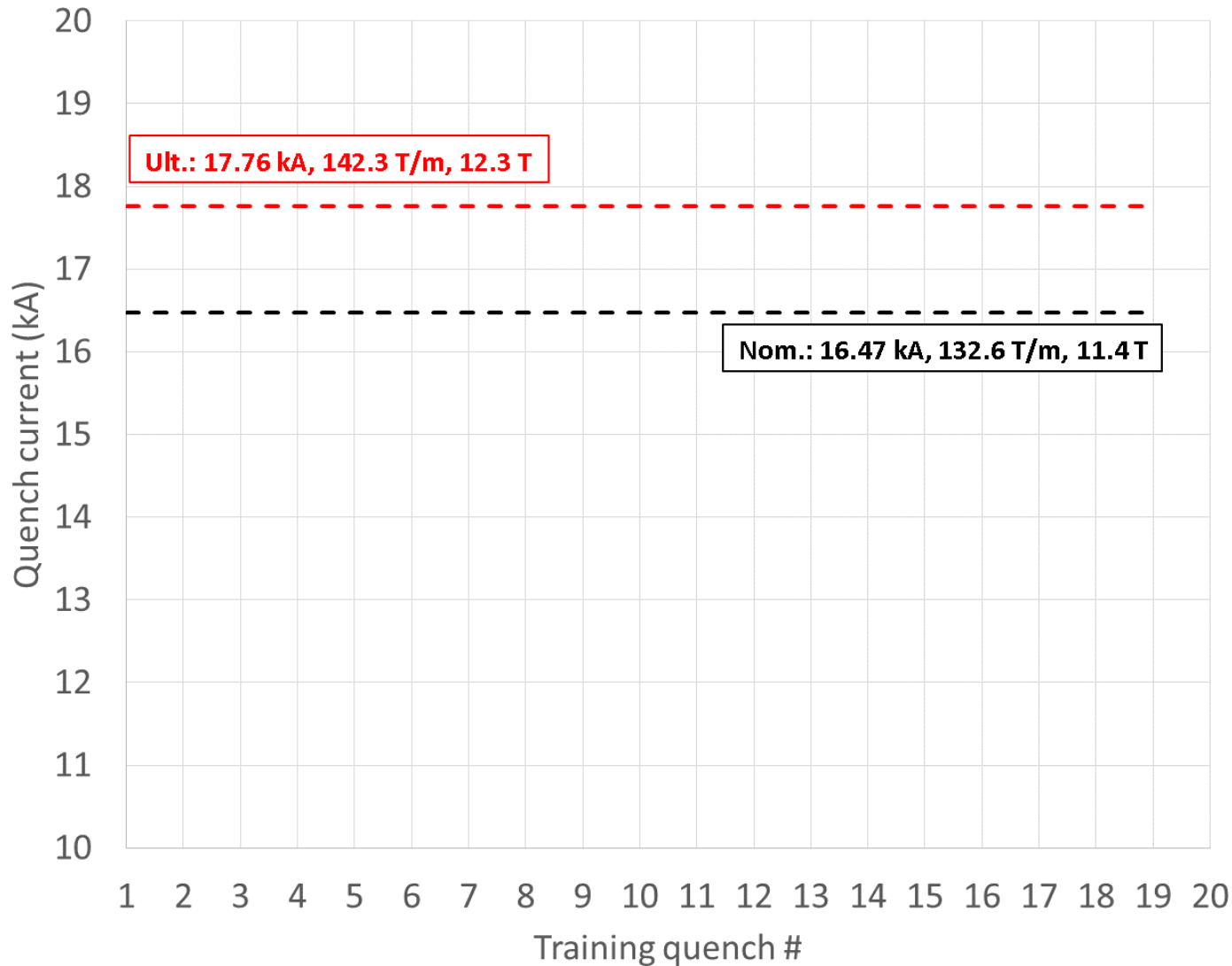



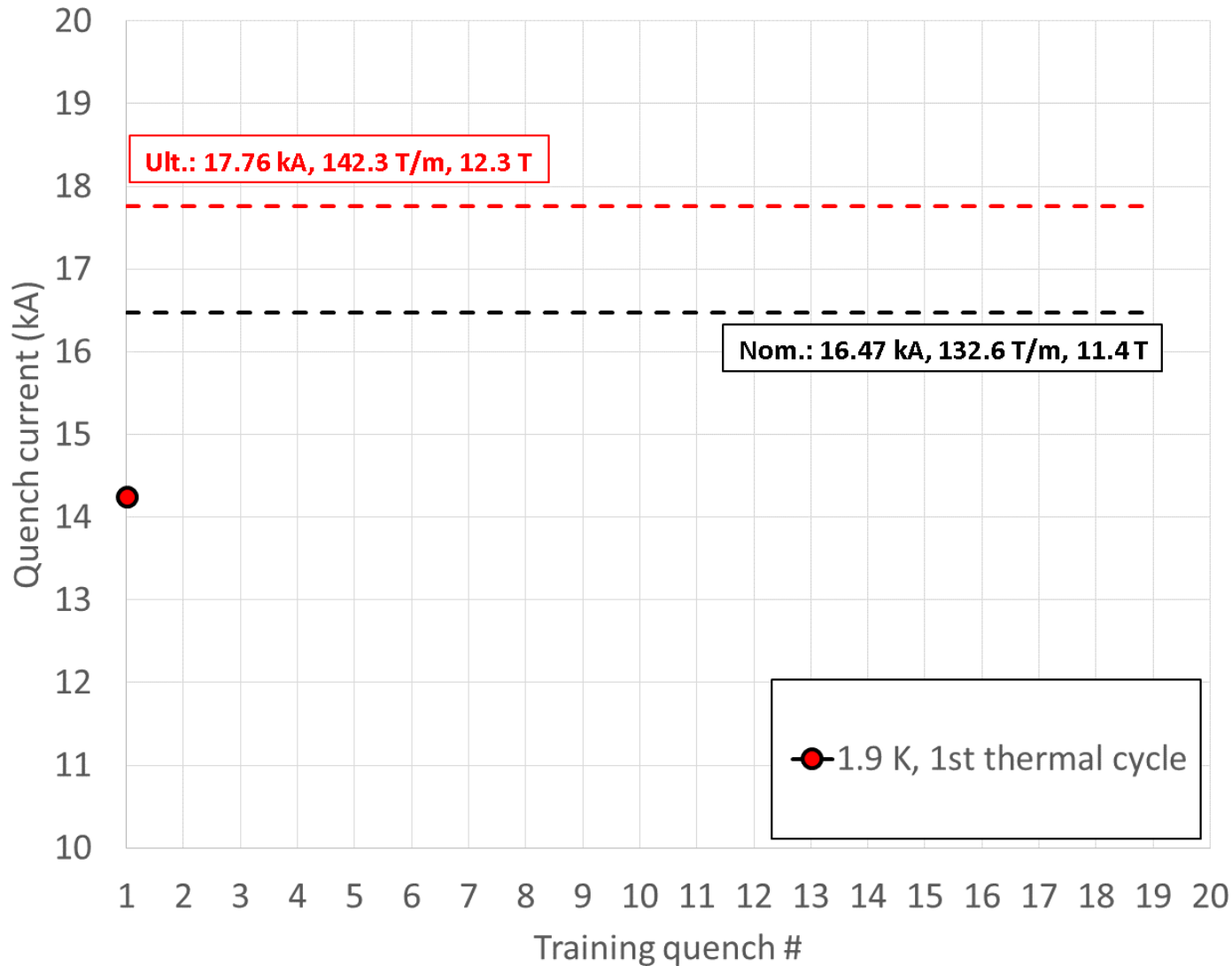

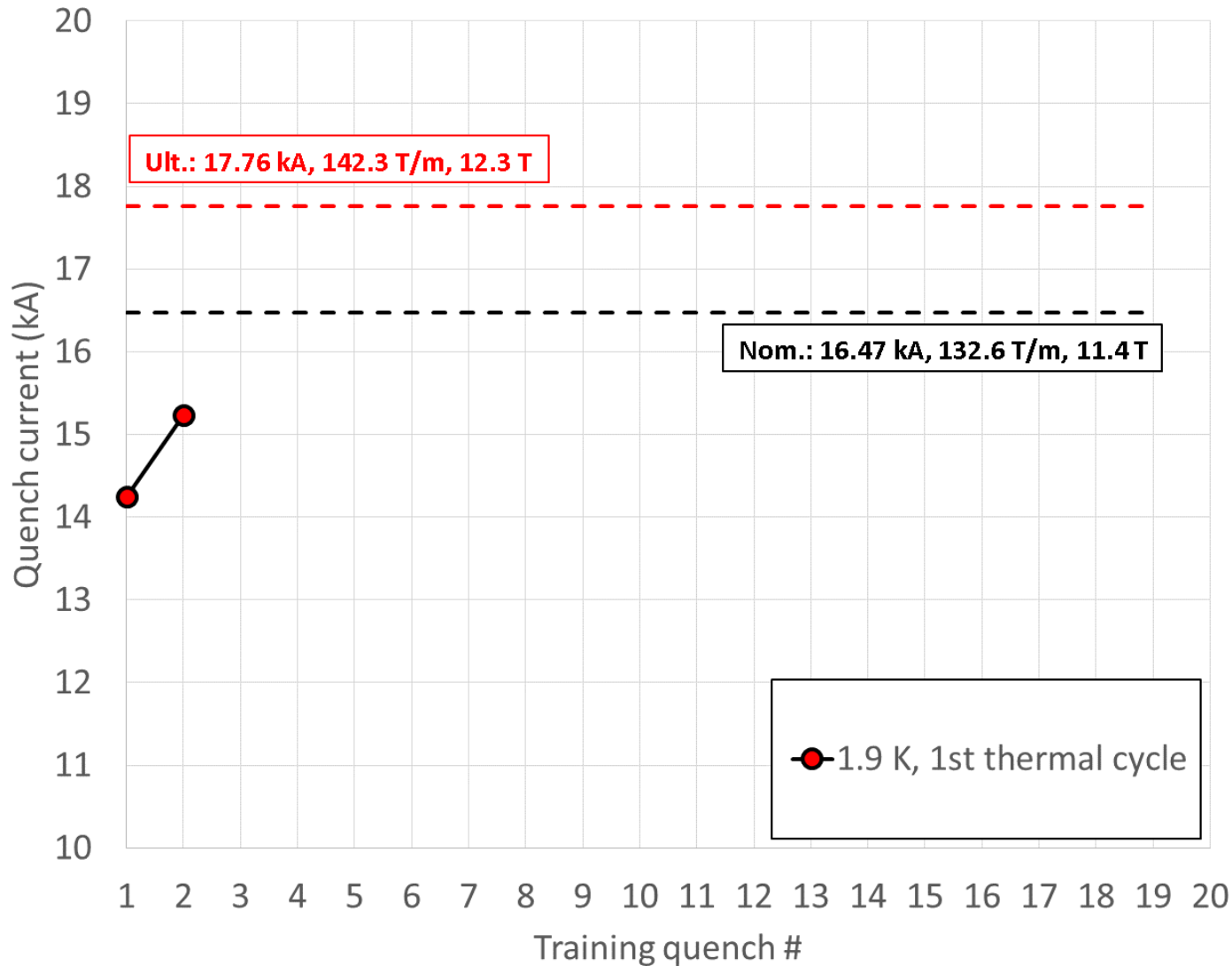

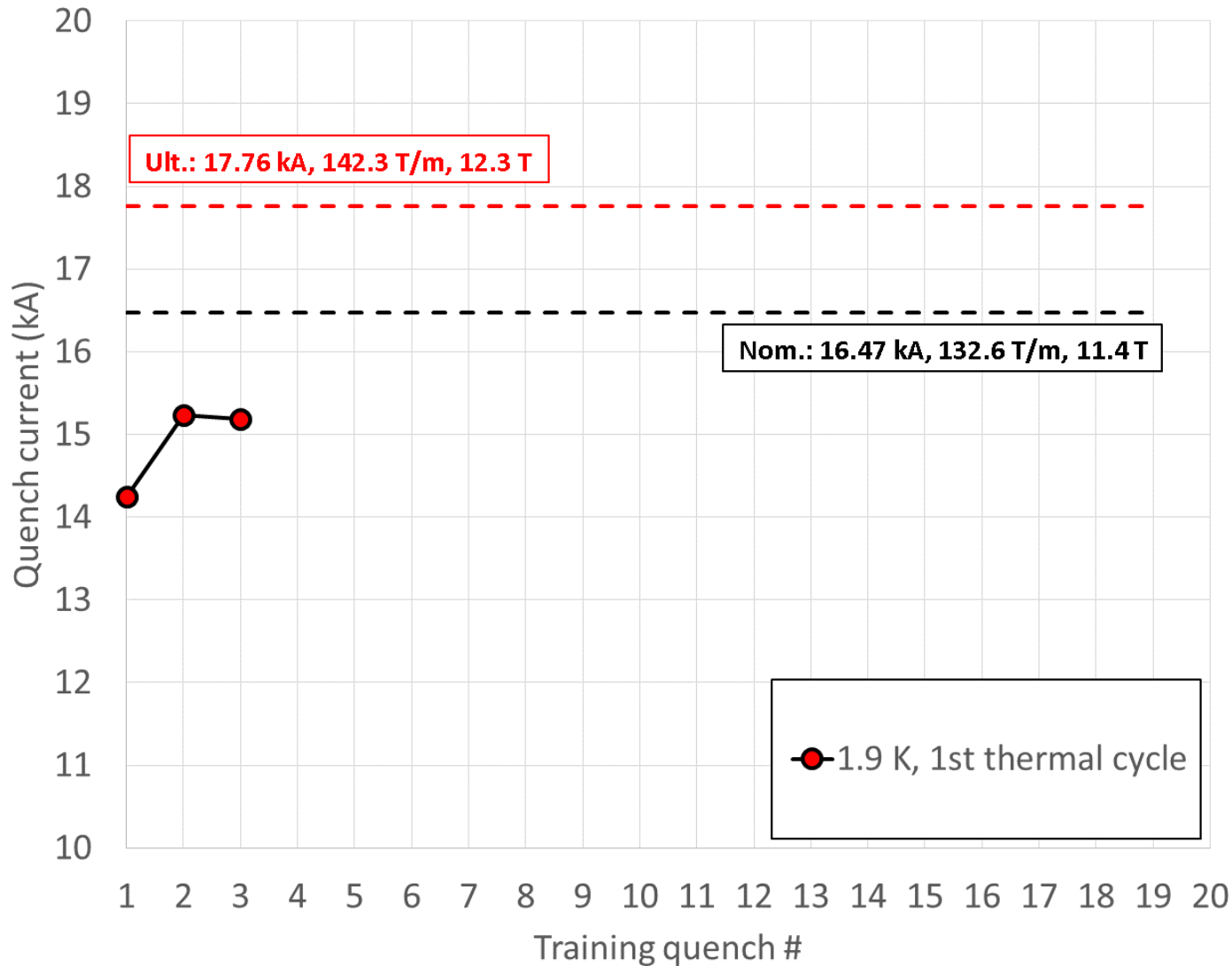

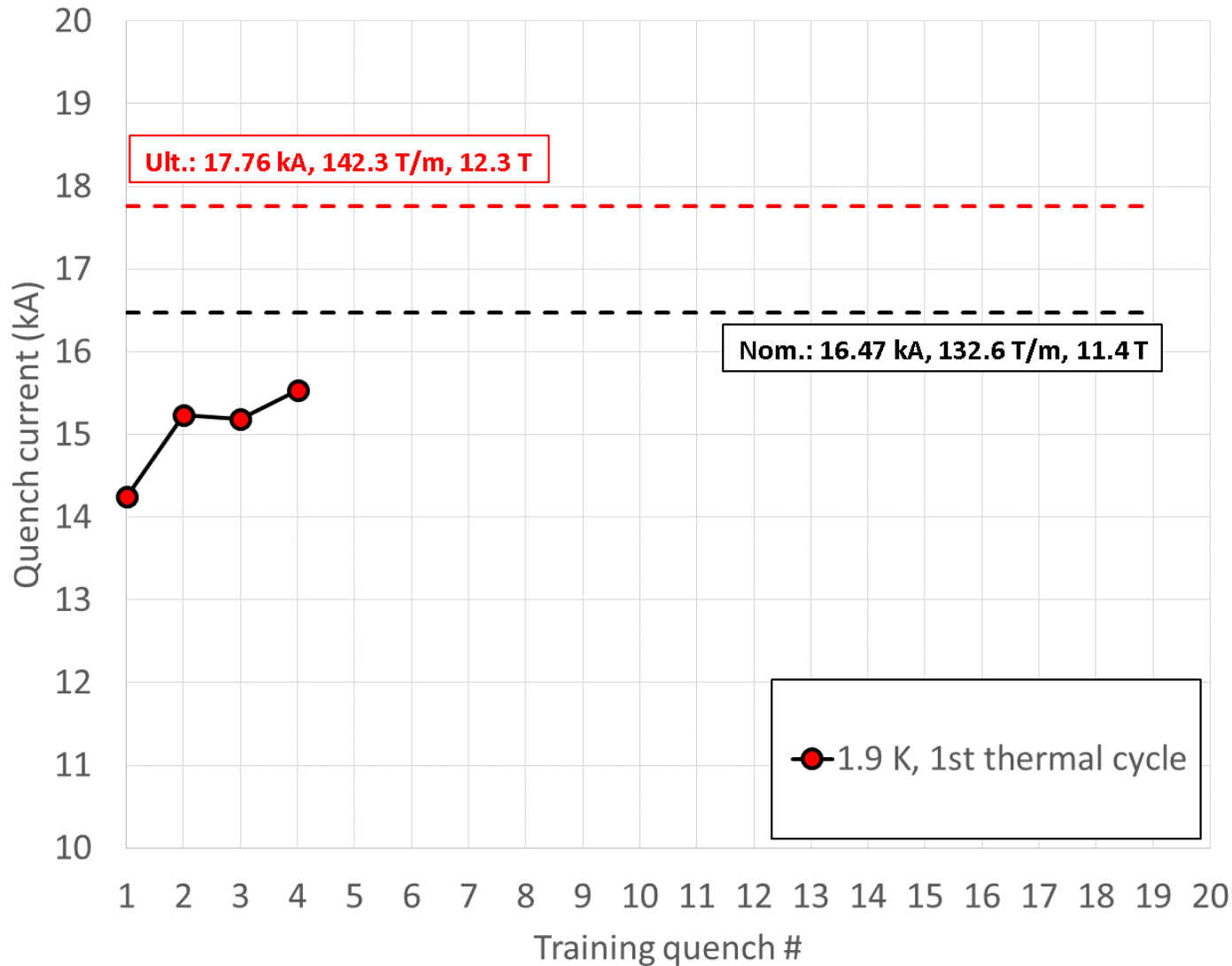

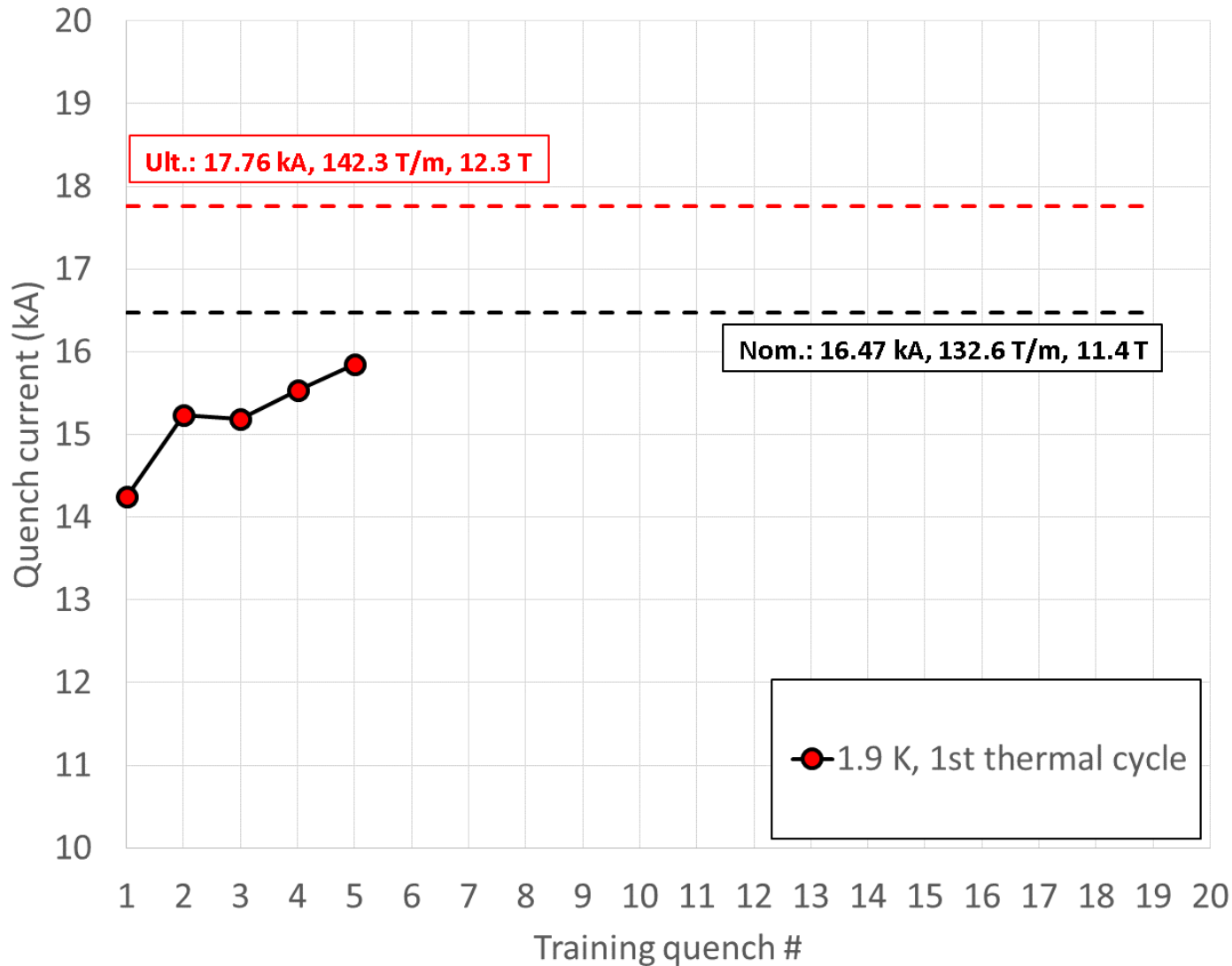

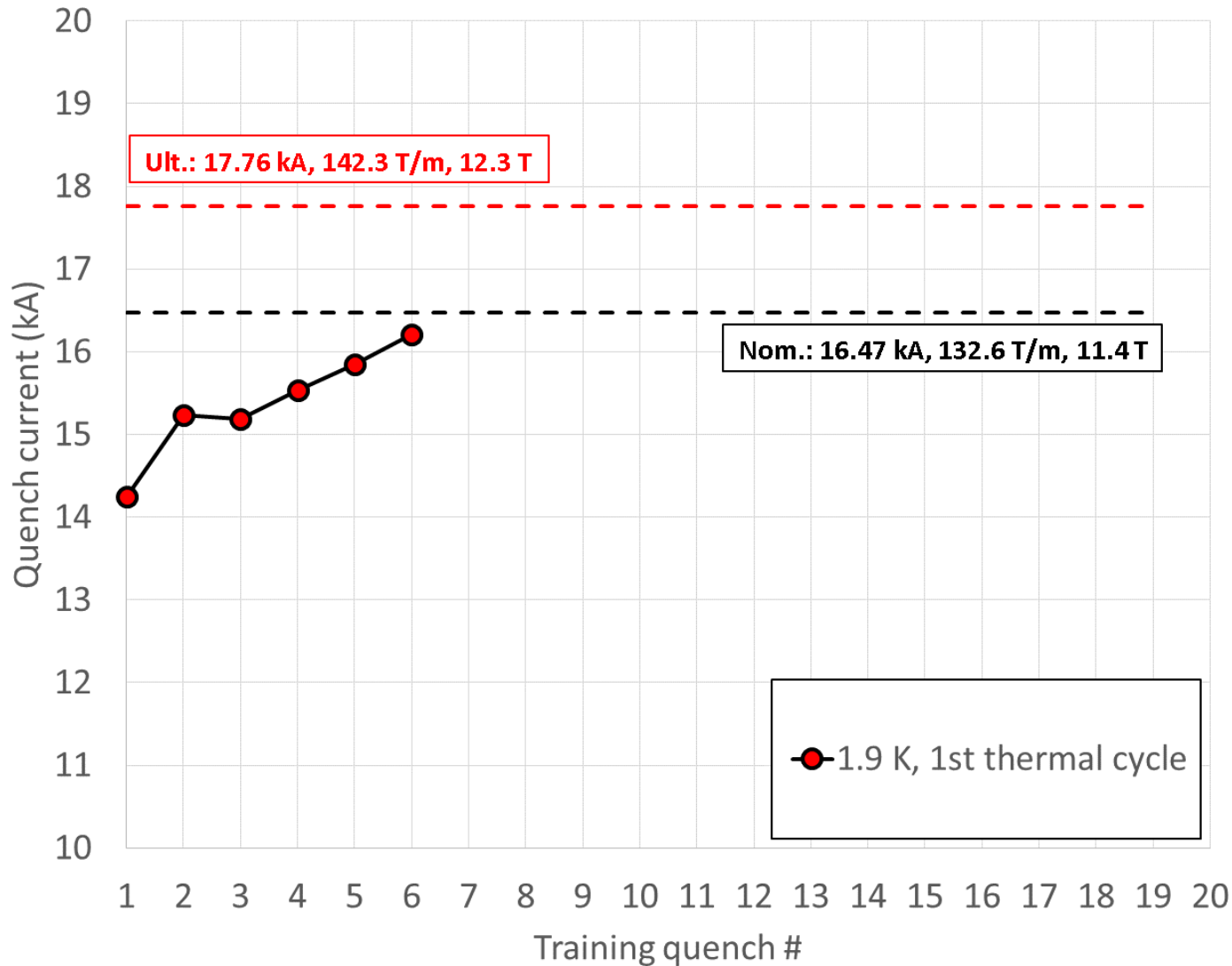

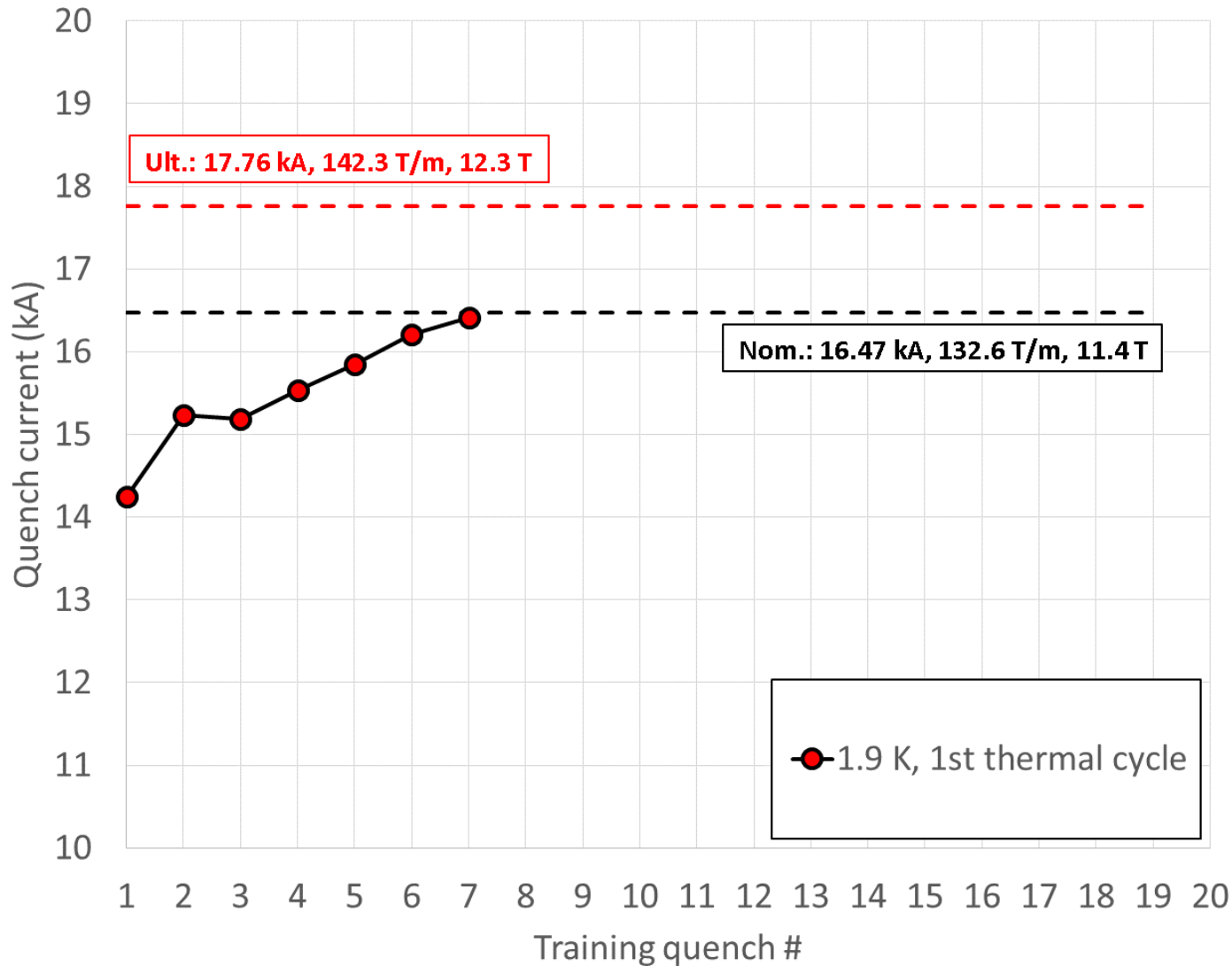

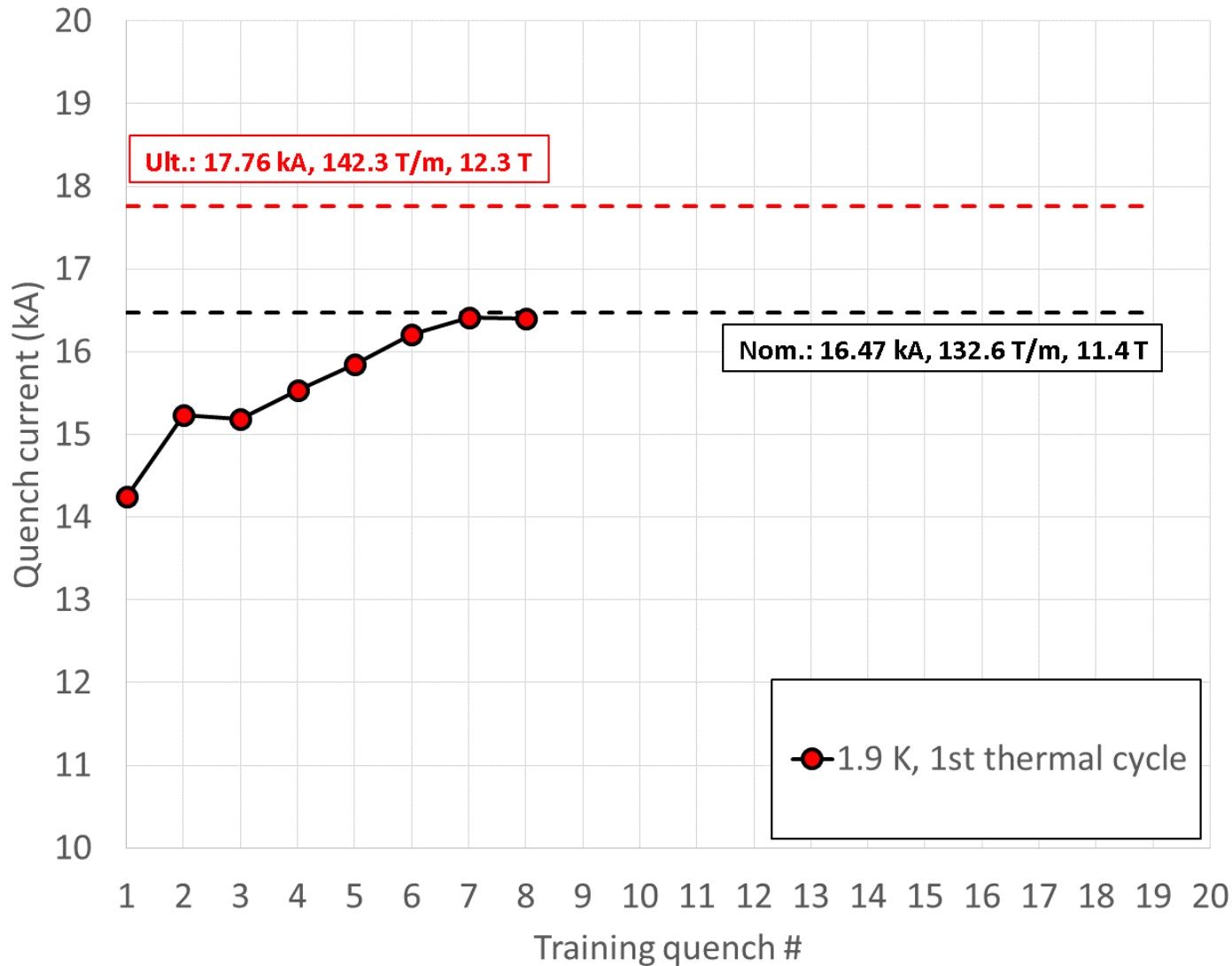



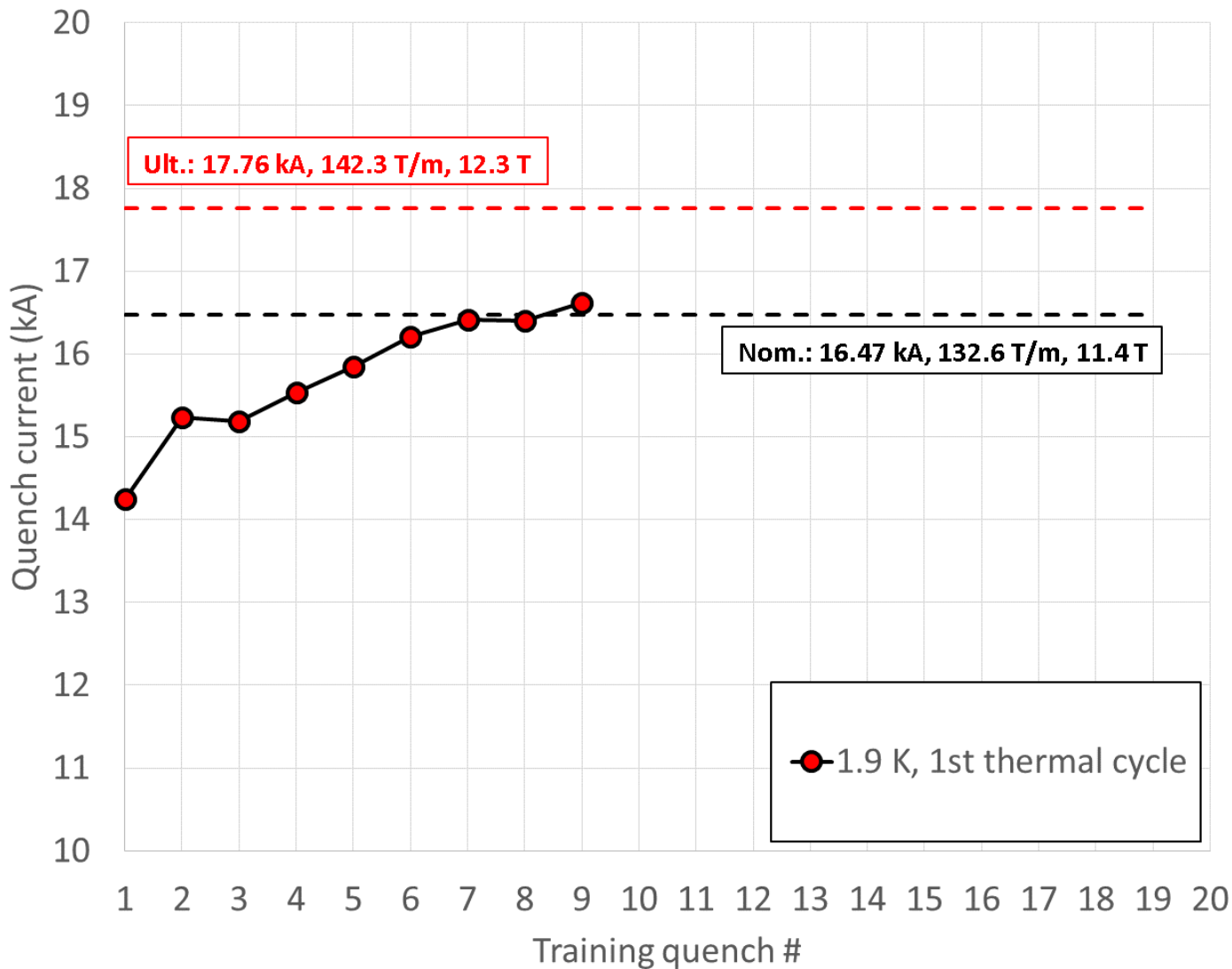

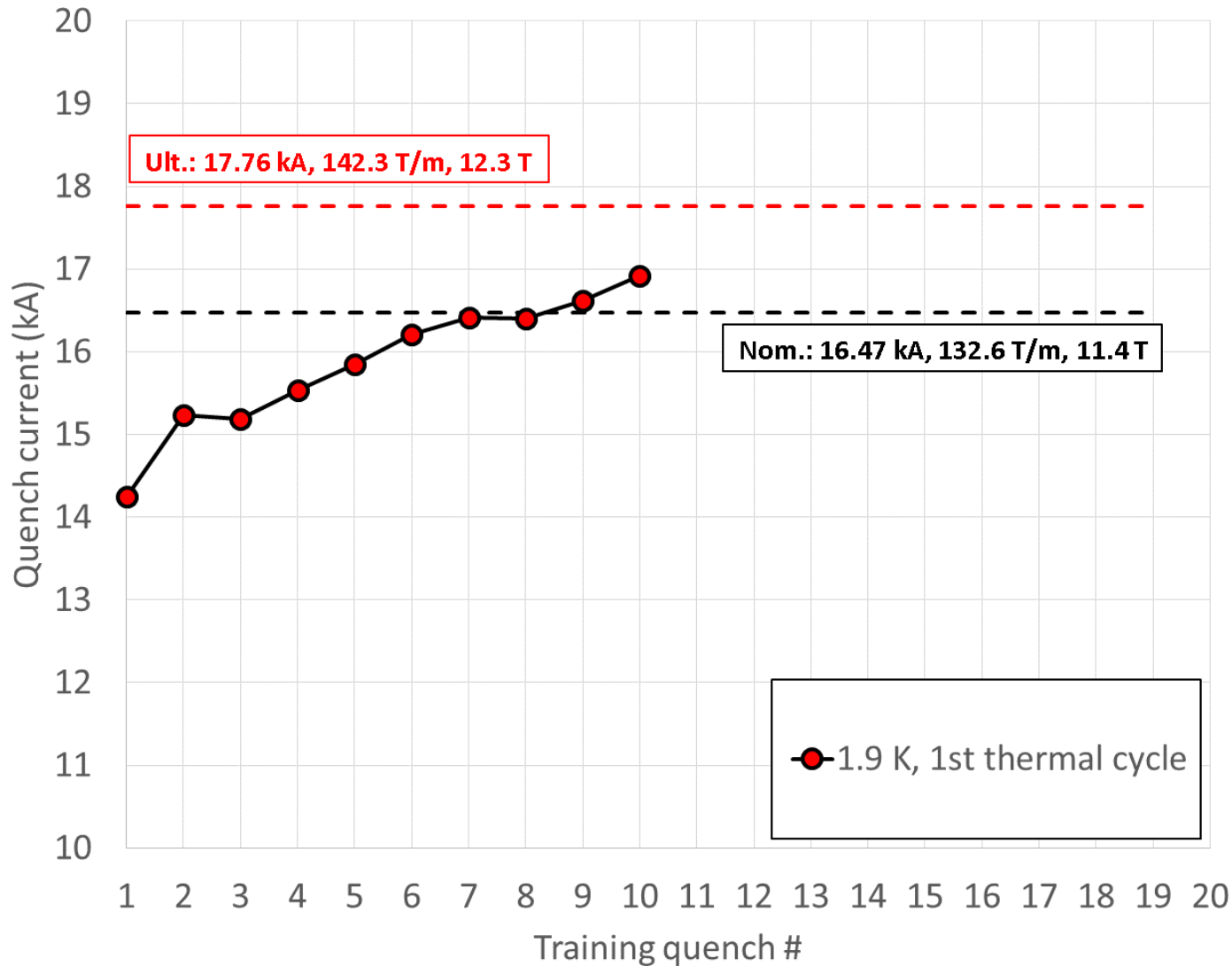

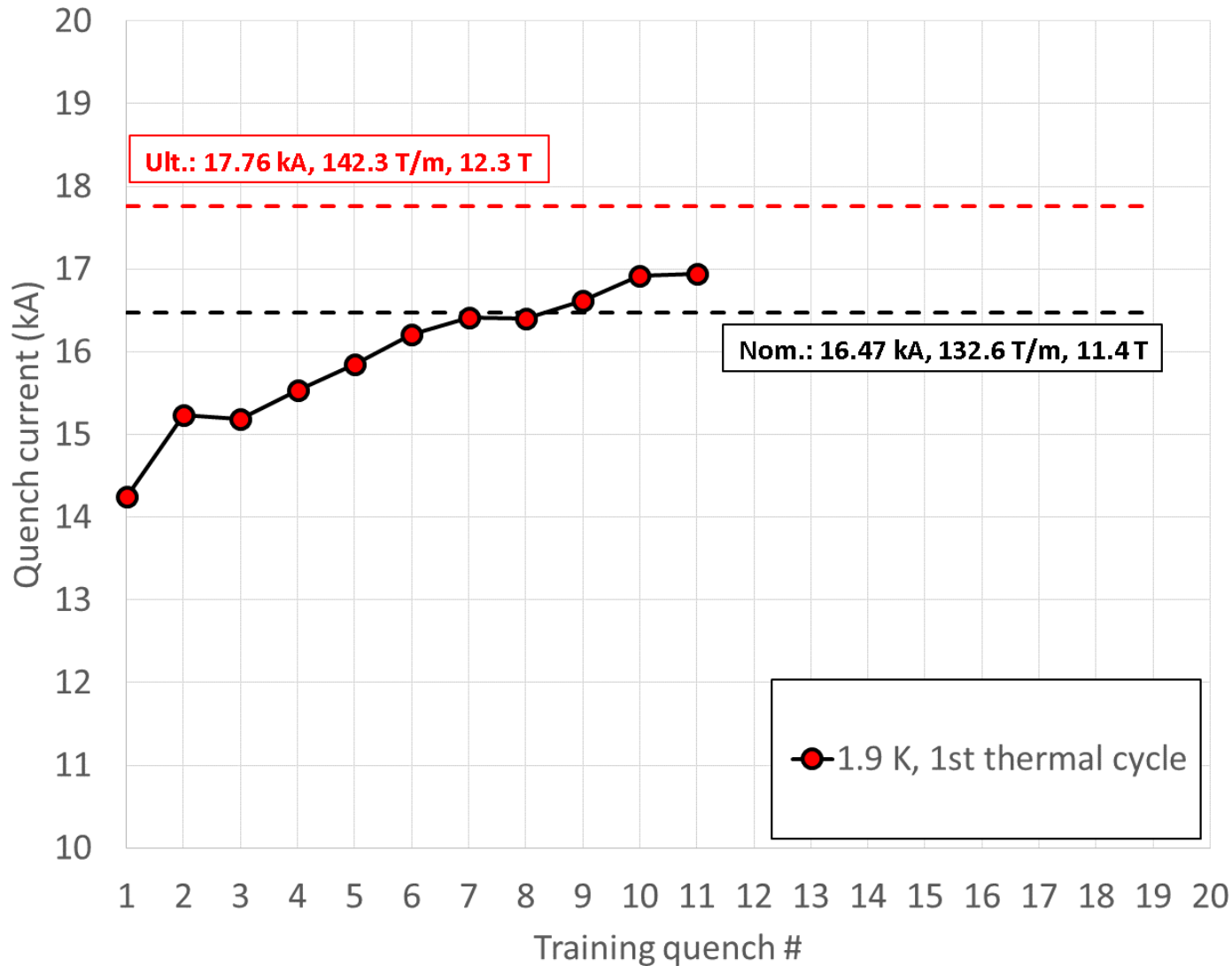

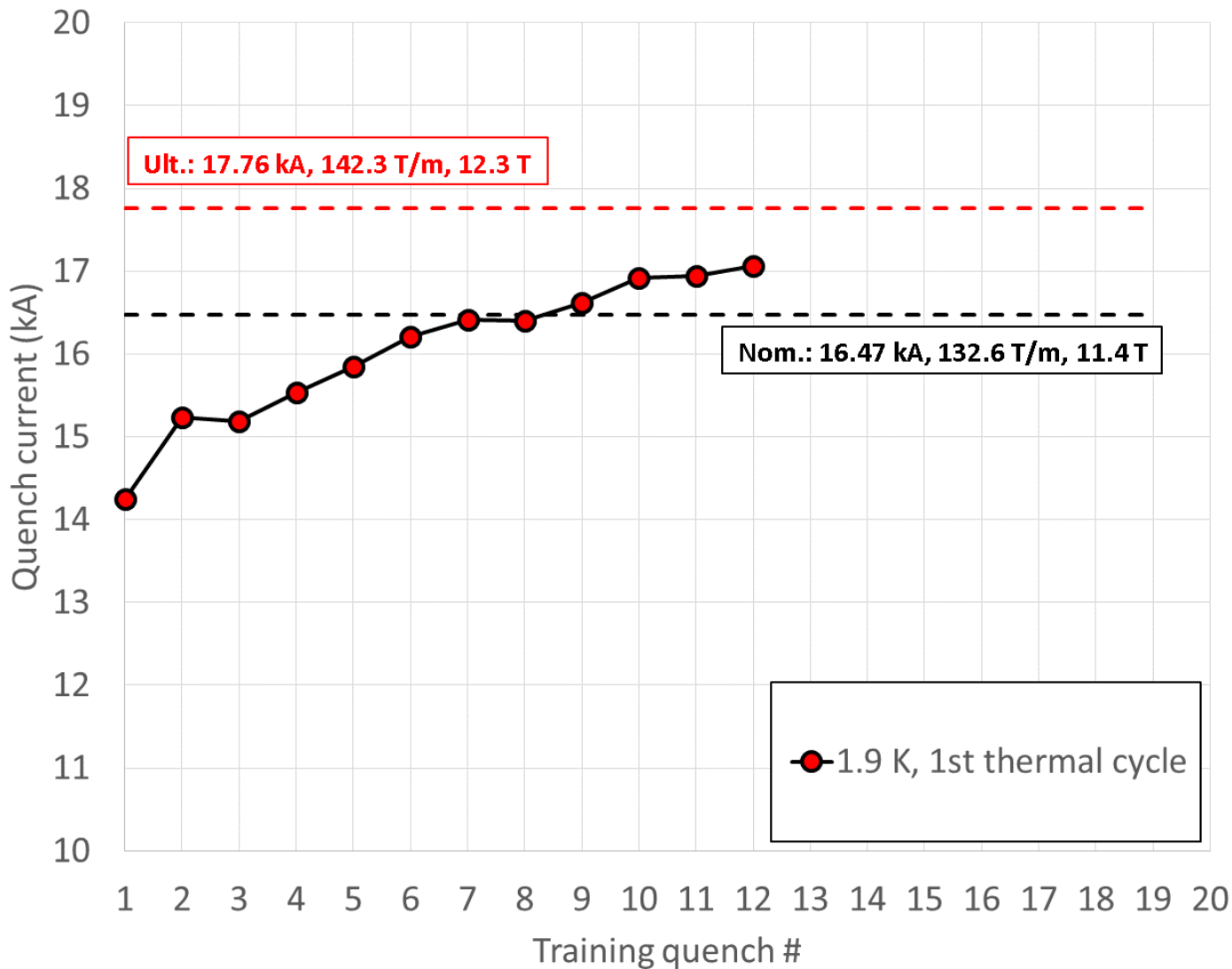

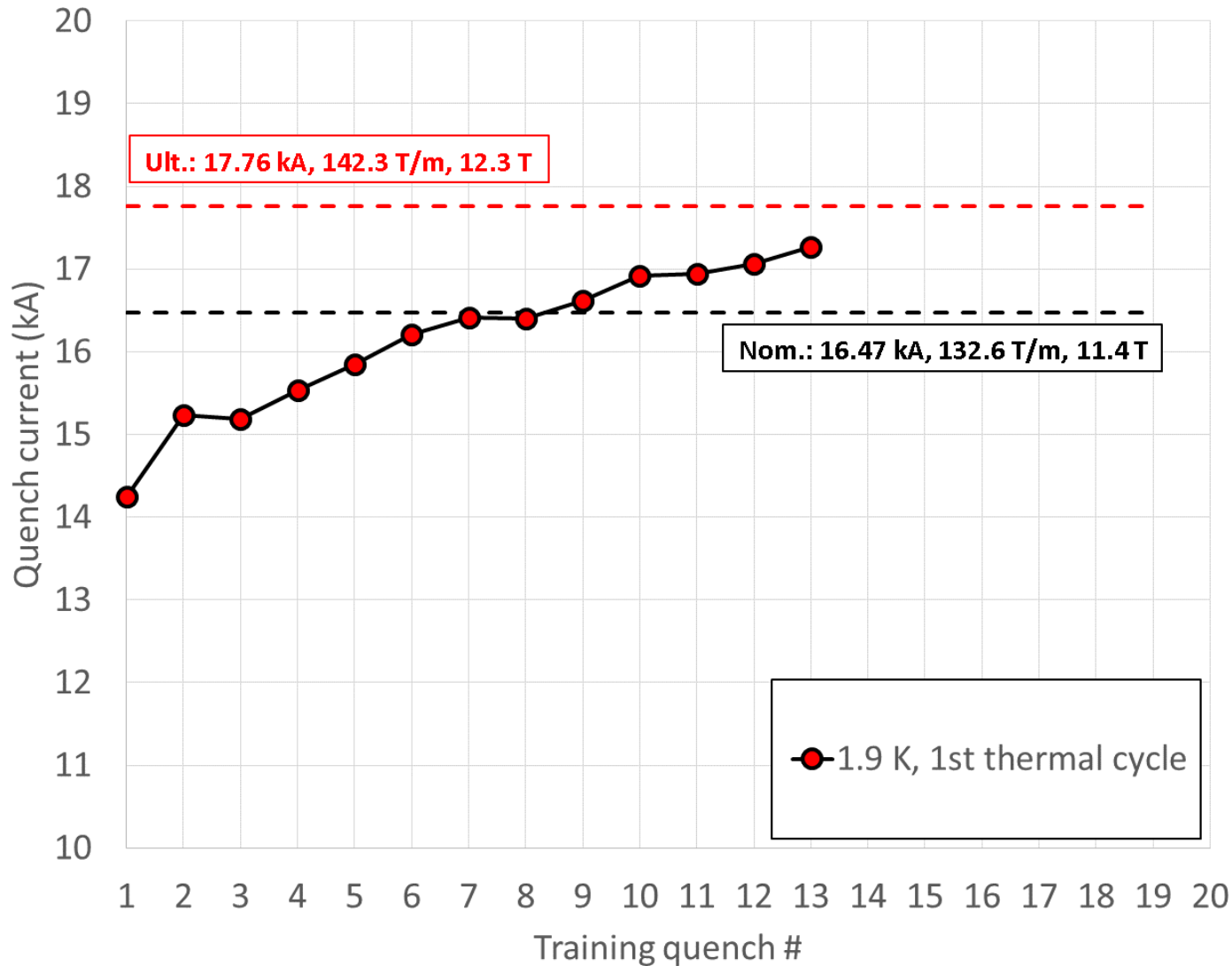

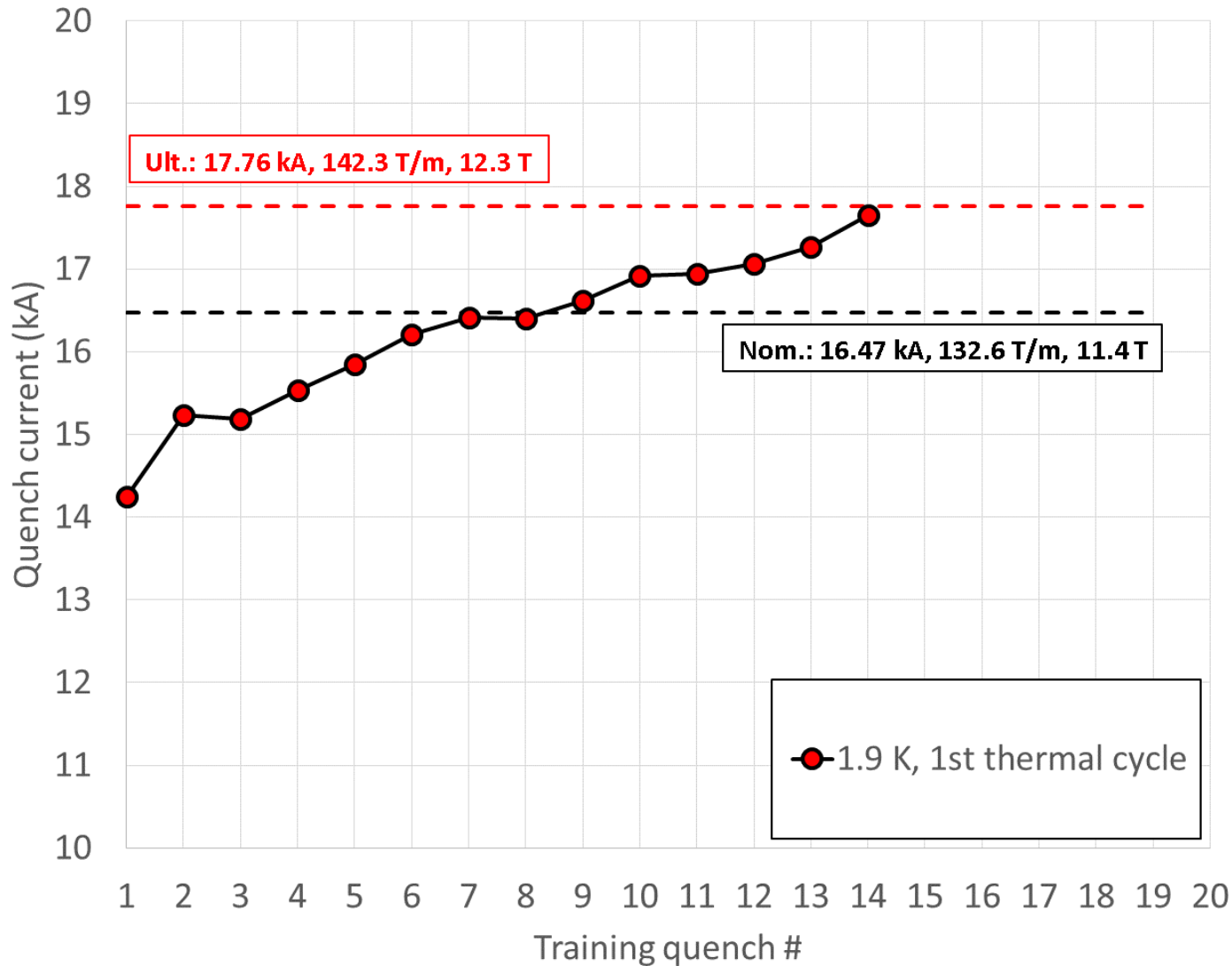

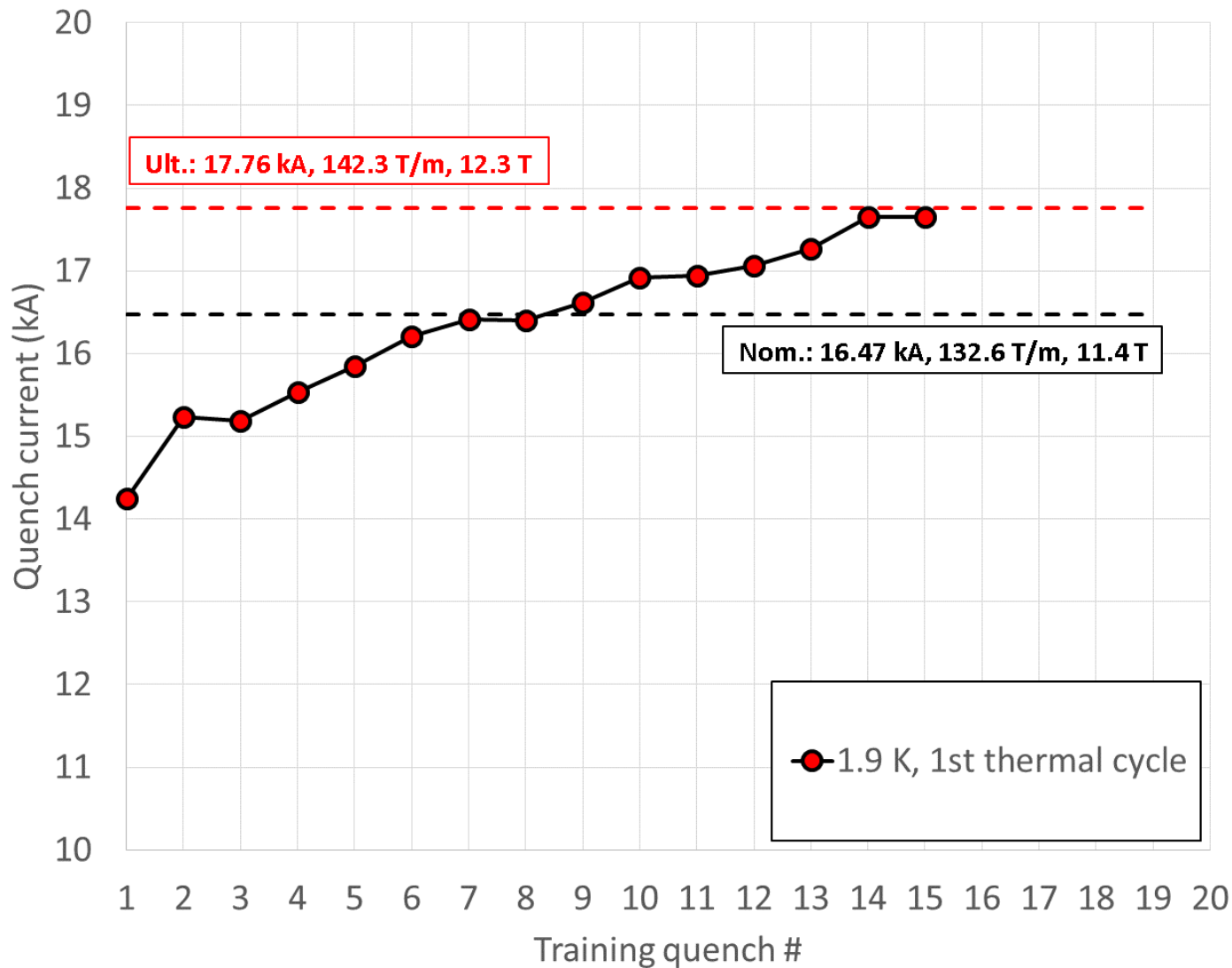



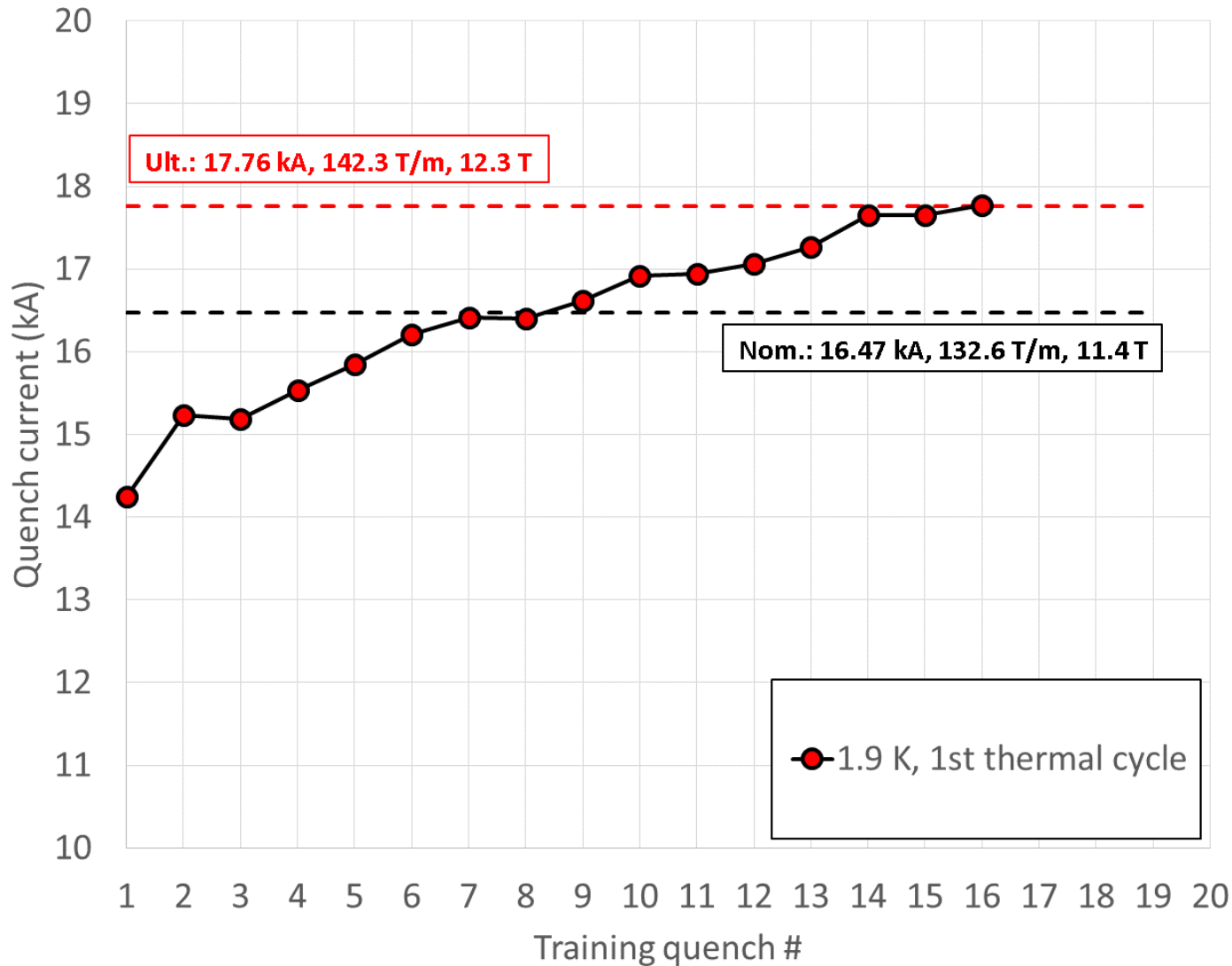

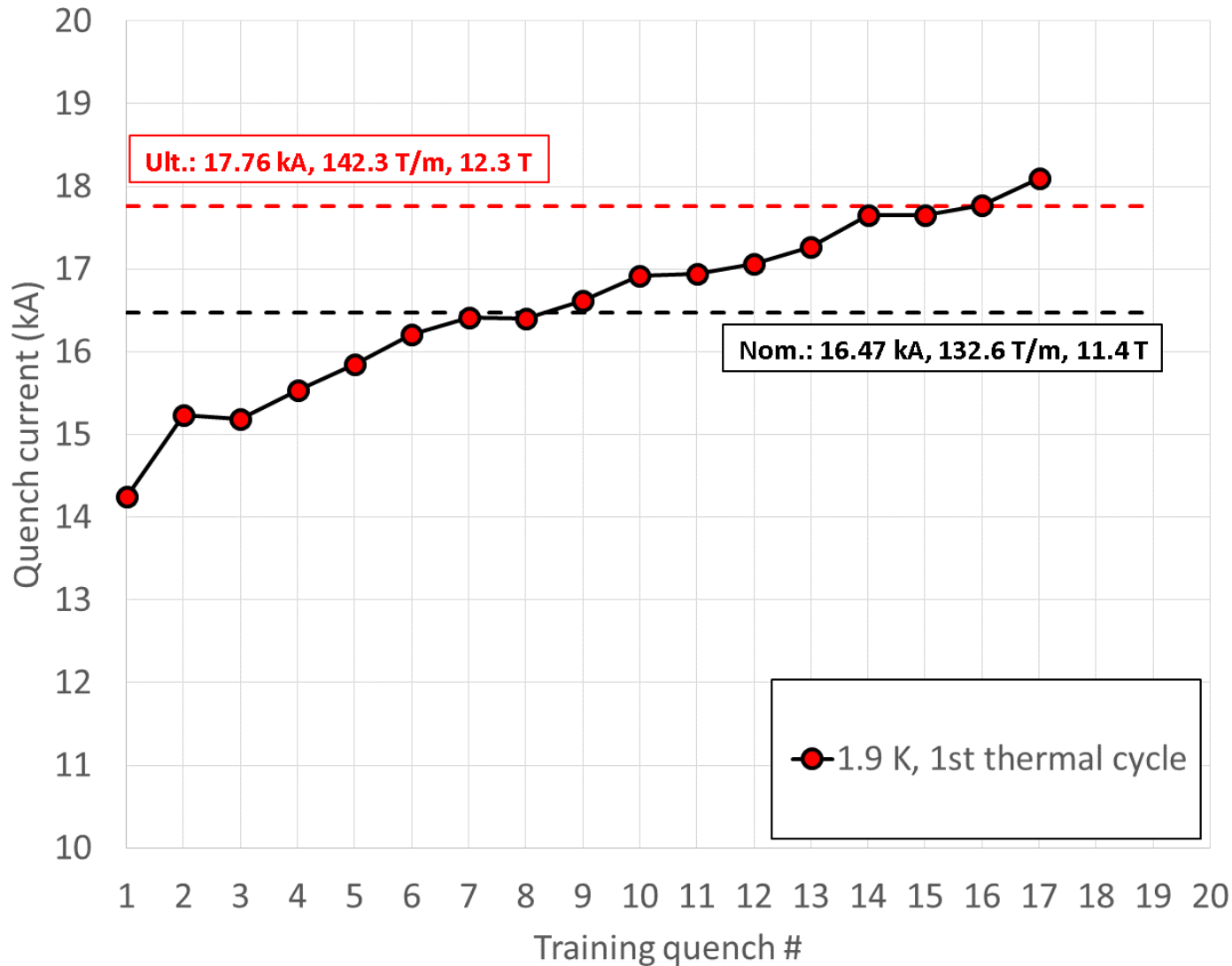

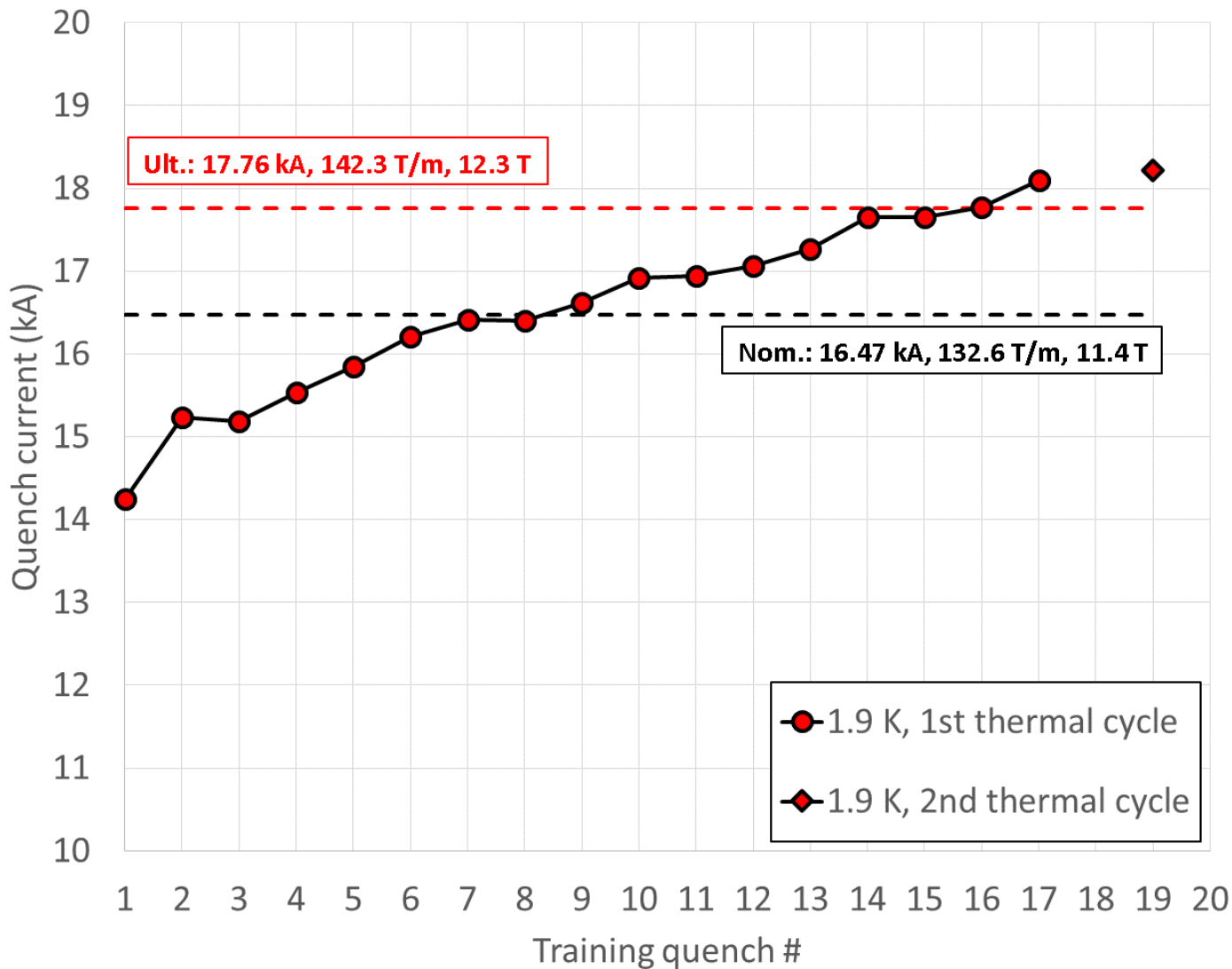

# Second MQXFS magnet Detraining...degradation

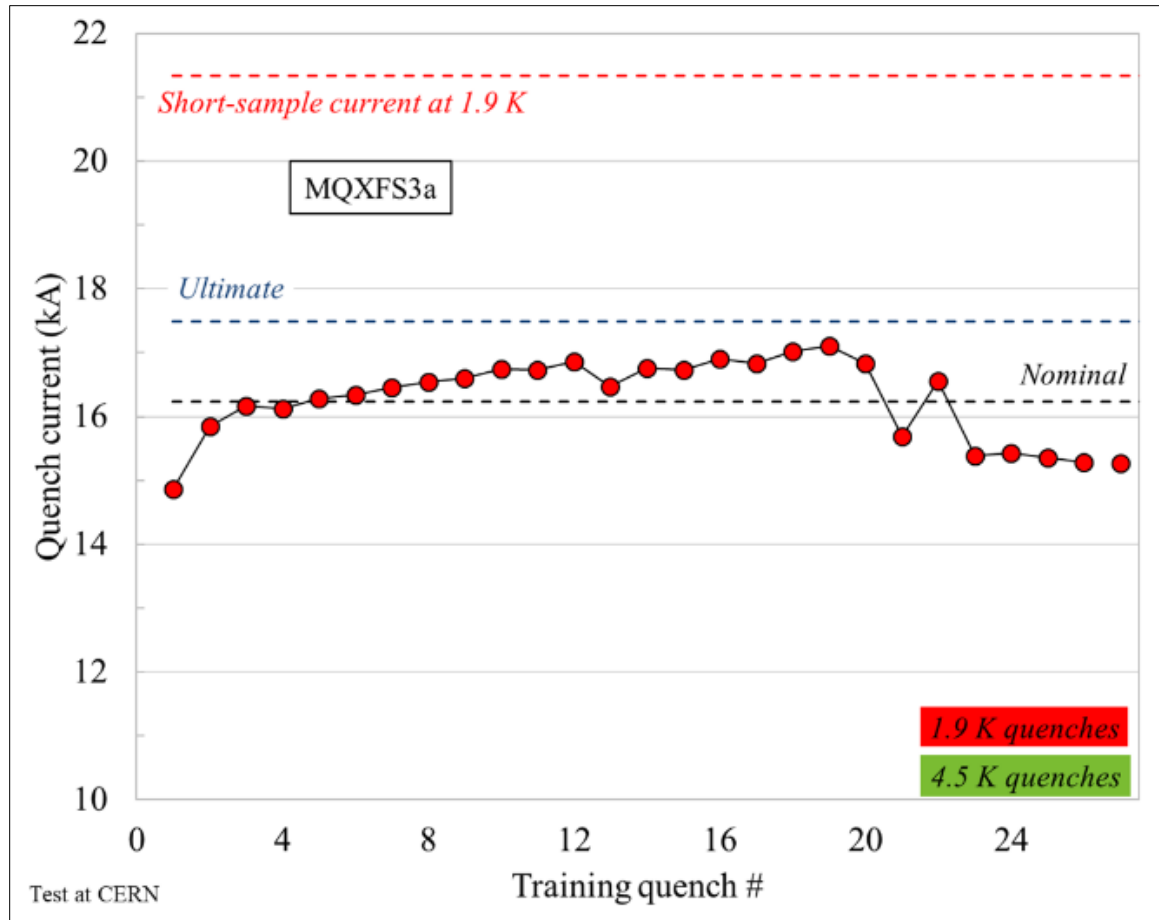

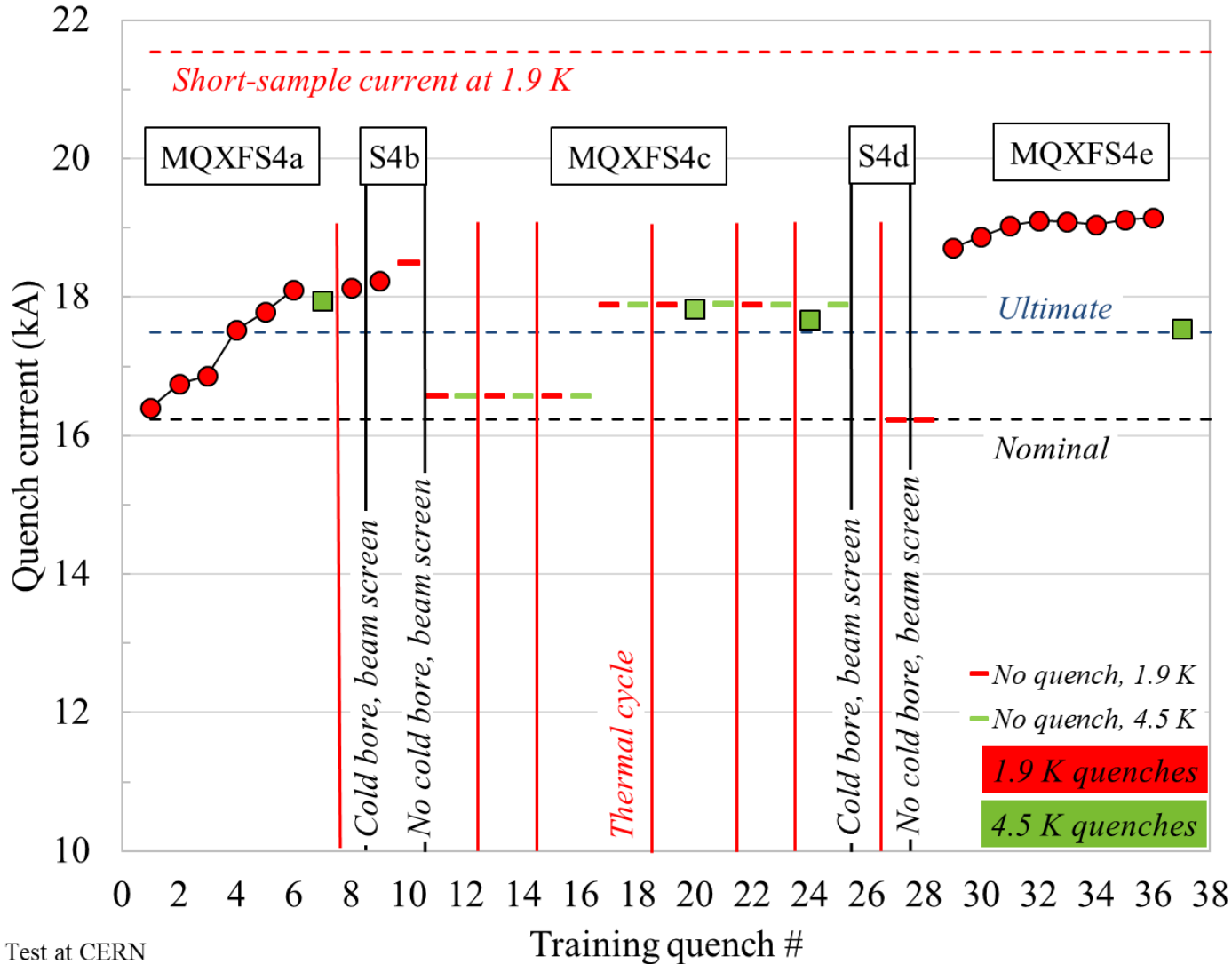

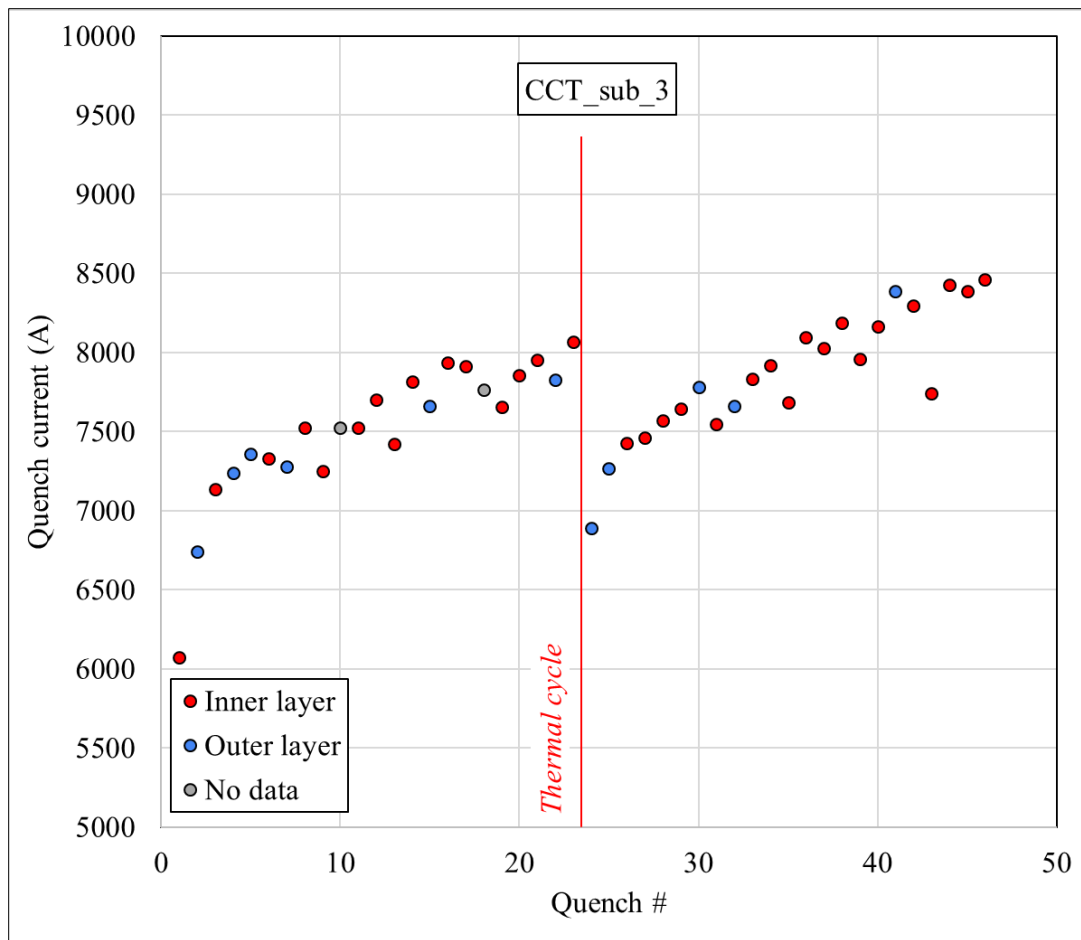

# Erratic training....loss of memory...but significant improvement with wax

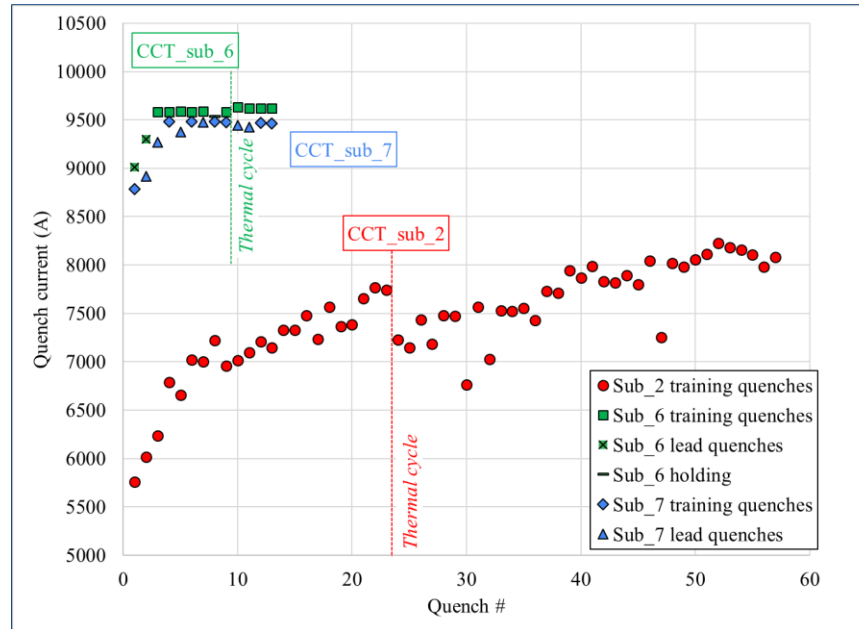



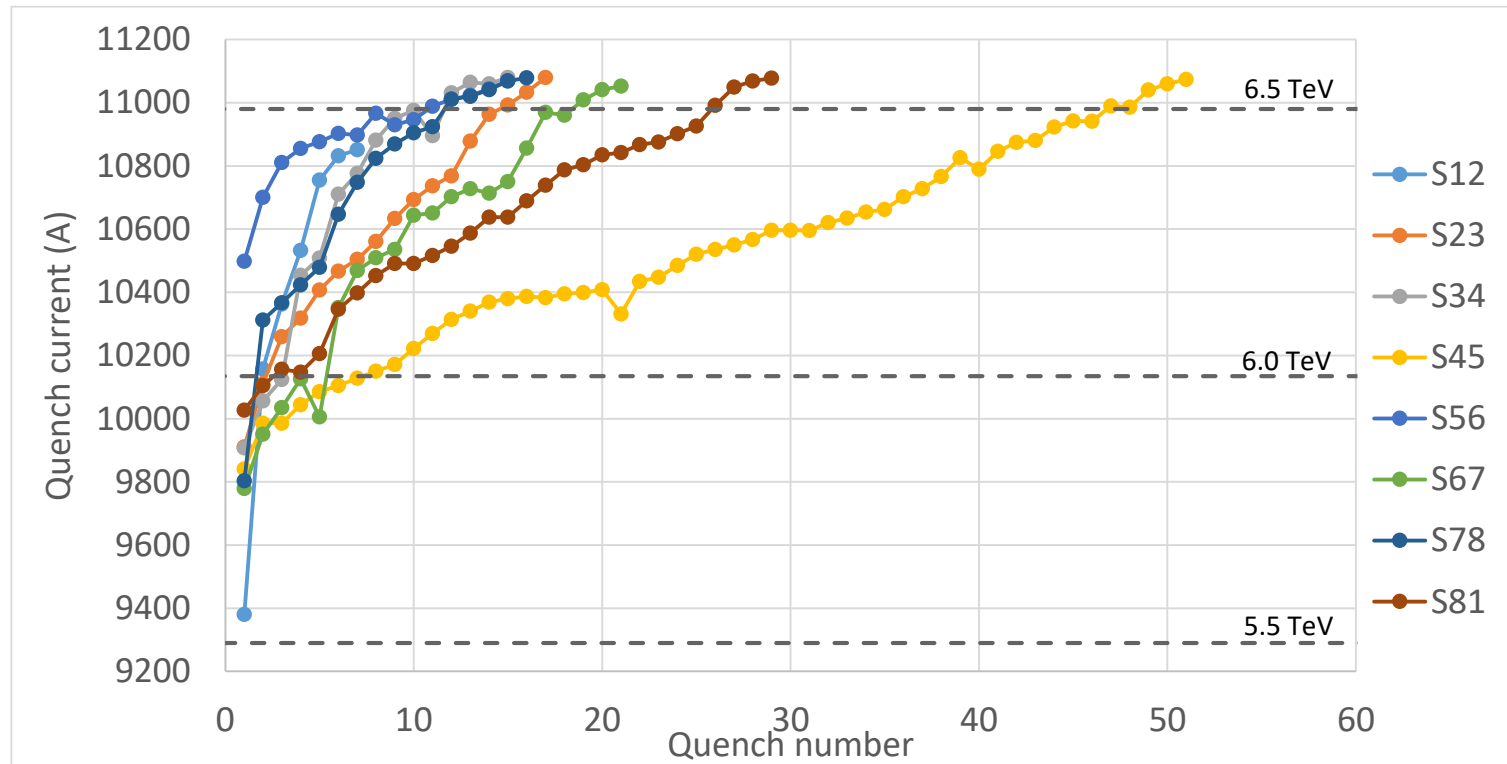

## RB training quenches

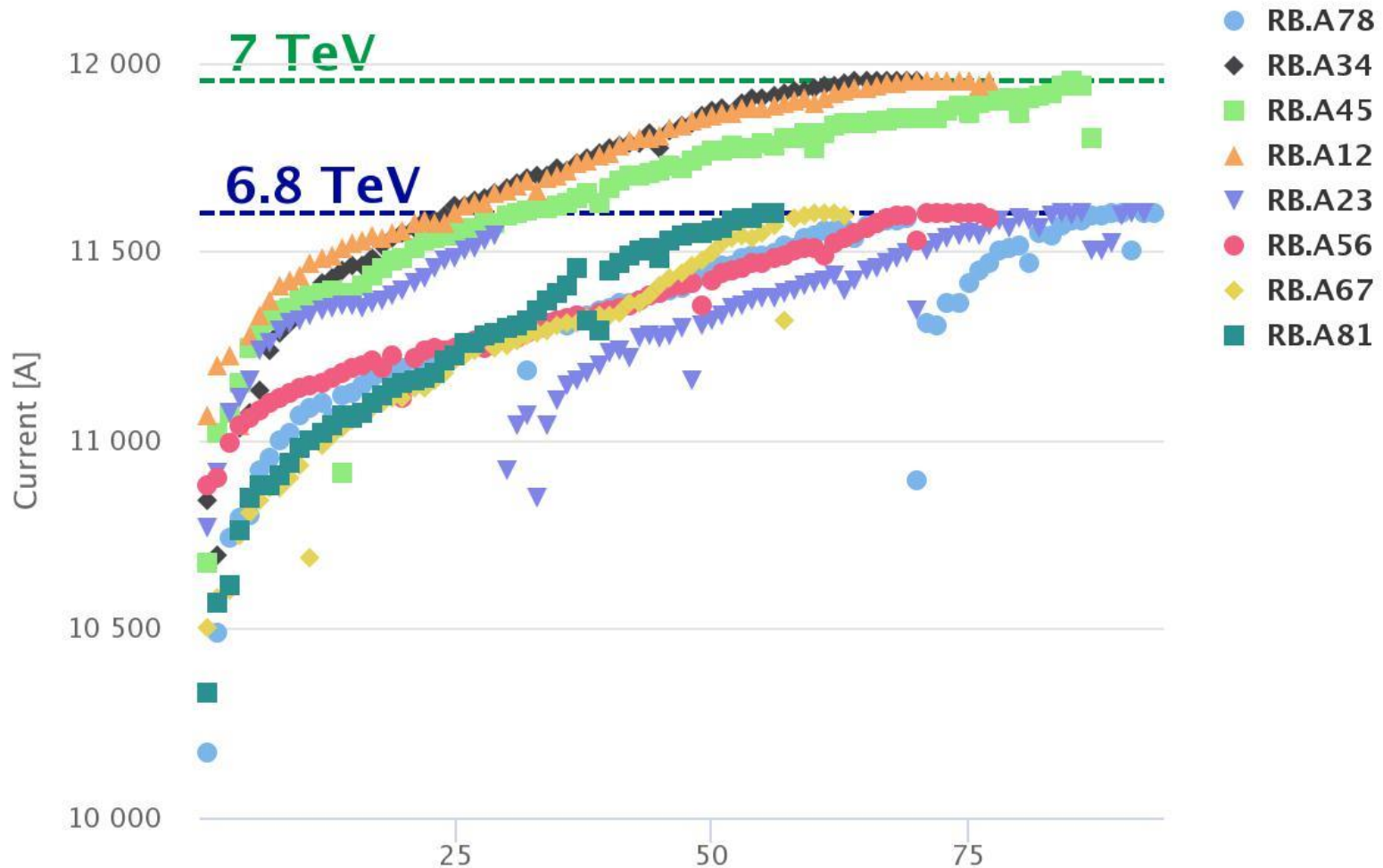

## ● Particle accelerators and superconductors

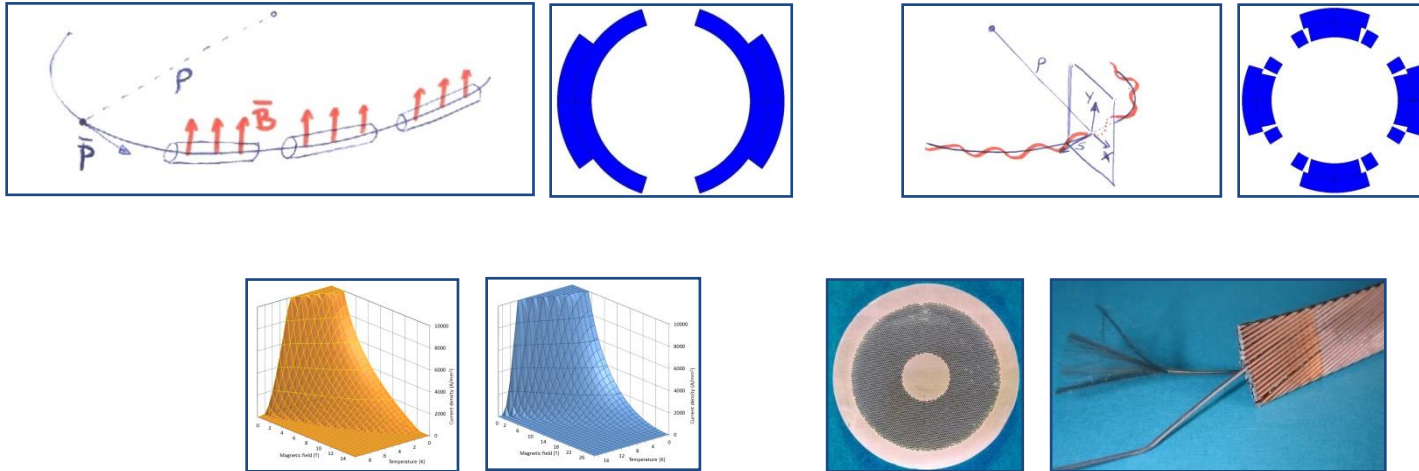

## ● Magnetic design and coil fabrication

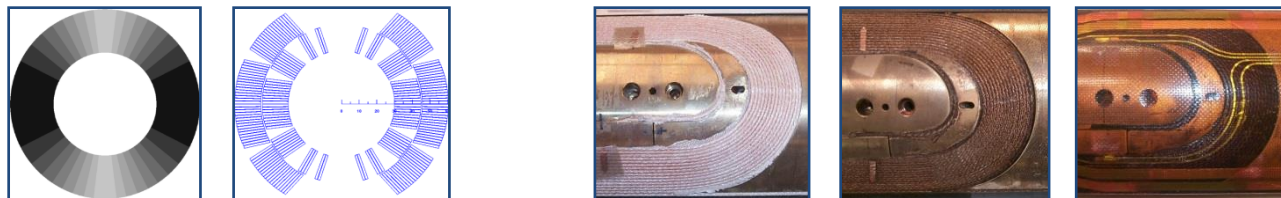

- Forces, stress, pre-stress, support structures

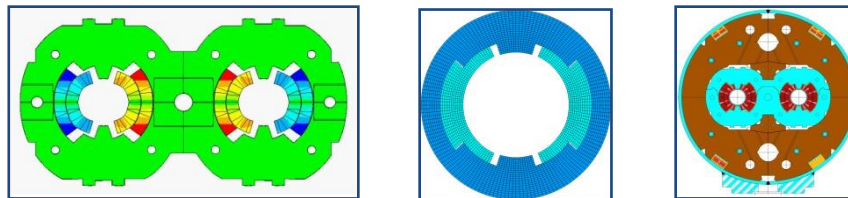

- Quench, protection, training

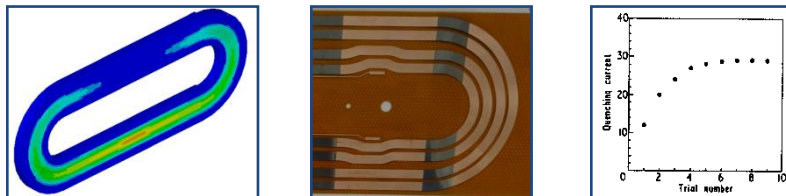



# Quench

## Distributed disturbances

- Release of energy uniformly distributed: **adiabatic condition**.
  - The T increase is uniform and no heat is conducted along the coil.

$$C \frac{dT}{dt} = q_{ext} + \left[ \text{conduction terms} \right] - \left[ \text{heat loss term} \right]$$

The diagram shows the energy balance equation for a quench. The left side is  $C \frac{dT}{dt}$ . The right side is a sum of terms:  $q_{ext}$  (external heat source), a term with a red 'X' (representing conduction along the coil), a term with a red 'X' (representing conduction across the coil), and a term with a red 'X' (representing heat loss to the helium bath,  $\frac{wh}{A} T_{he}$ ).

- Energy density required to quench
  - convenient to use the volumetric **specific enthalpy**  $H$  (J/m<sup>3</sup>) with  $\gamma$  (kg/m<sup>3</sup>) is the density

$$H(\theta) = \gamma \int_{1.8}^{\theta} C(\theta) d\theta$$

- Then, possible to compute the energy density to quench

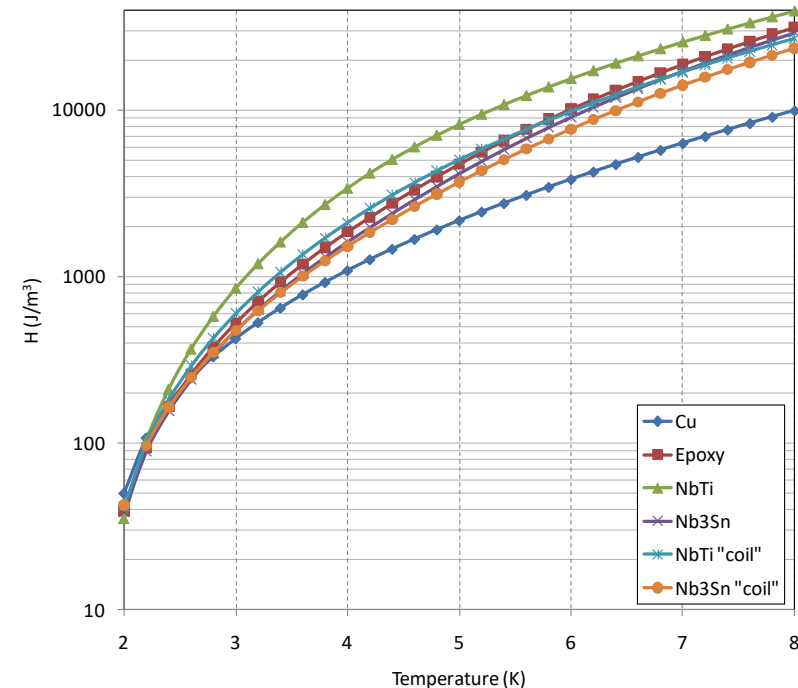

- At 80% of  $I_{ss}$ 
  - $Nb_3Sn$  has  $\sim 5$  K of temperature margin at 1.9 K  $\rightarrow \sim 15$  mJ/cm<sup>3</sup> (strand volume)
    - ...but impregnated ( $\sim$ adiabatic) coils
  - $Nb-Ti$  has  $\sim 2$  K of temperature margin at 1.9 K  $\rightarrow \sim 3$  mJ/cm<sup>3</sup> (strand volume)
    - ...but superfluid LHe surrounding the strands

