

2025 Joint Universities Accelerator School

Exercise on Superconducting Magnets

Case study

Paolo Ferracin

(pferracin@lbl.gov)

Lawrence Berkeley National Laboratory (LBNL)

- **Goal:** outline design of a superconducting magnet
 - Apply the theory explained during lectures to a practical case
 - Solve a case study using analytical formulas, “back of the envelope” calculation, plots, data, etc. provided during the presentations
 - From the superconducting material to the full magnet
 - Understand physics and reasoning behind design options
 - General dimensions, orders of magnitude of different parameters

Superconducting material

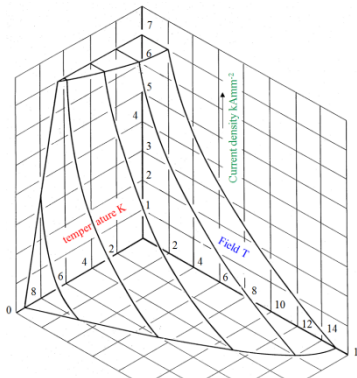

Superconducting strand

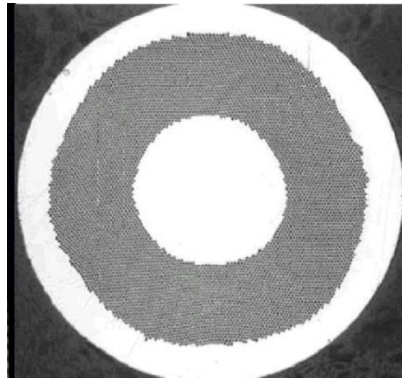

Superconducting cable

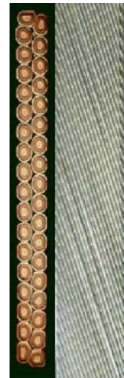

Superconducting coil



Superconducting magnet

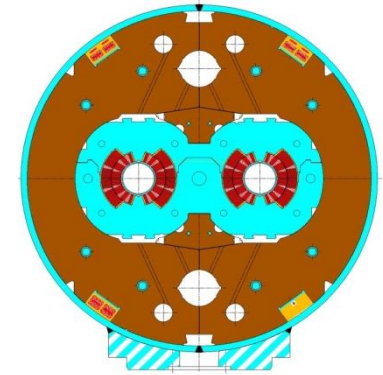

- 11 T Nb₃Sn dipole for the LHC collimation upgrade

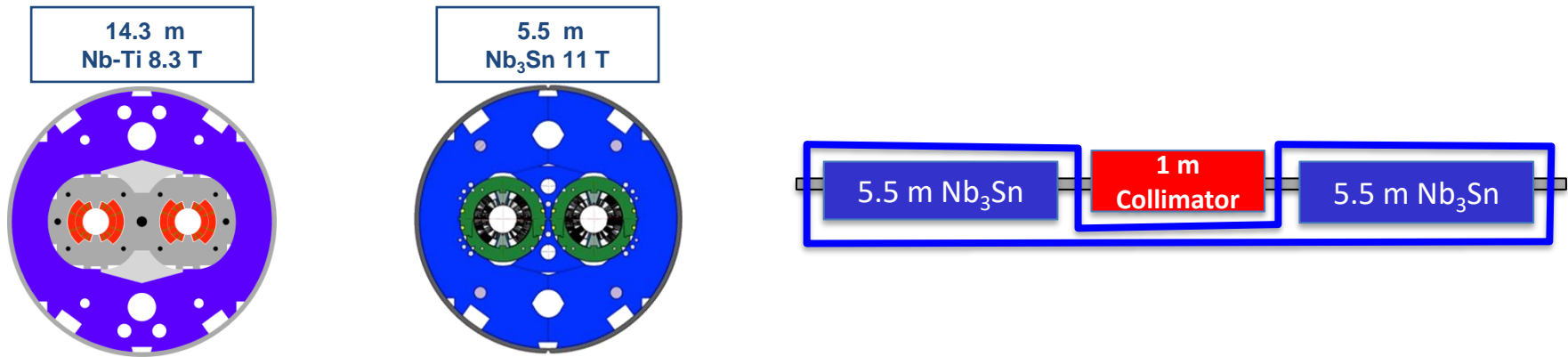

- Second long shutdown: increase of collimation efficiency
 - New collimation units
 - Some 8.3 T Nb-Ti dipoles replaced by **11 T Nb₃Sn dipoles**
 - FNAL/CERN collaboration

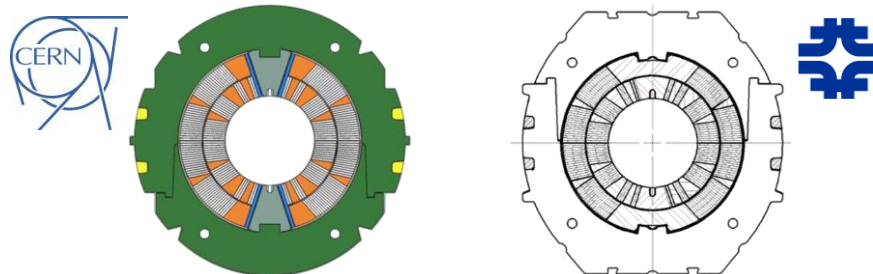

- **11 T Nb₃Sn dipole for the LHC collimation upgrade**
 - **Introduction**
 - The second phase of the LHC collimation upgrade will enable proton and ion beam operation at nominal and ultimate intensities.
 - To improve the collimation efficiency by a factor 15–90, additional collimators are foreseen in the room temperature insertions and in the dispersion suppression (DS) regions.
 - To provide longitudinal space of about 3.5 m for additional collimators, a solution based on the substitution of a pair of 5.5-m-long 11 T dipoles for several 14.3-m-long 8.33 T LHC main dipoles (MB) is being considered.
 - **Goal**
 - Design a **Nb₃Sn** superconducting **dipole** with an **60 mm aperture** and a operational field (80% of the current limit I_{ss}) at **1.9 K** of **11 T**.

- 11 T Nb₃Sn dipole for the LHC collimation upgrade

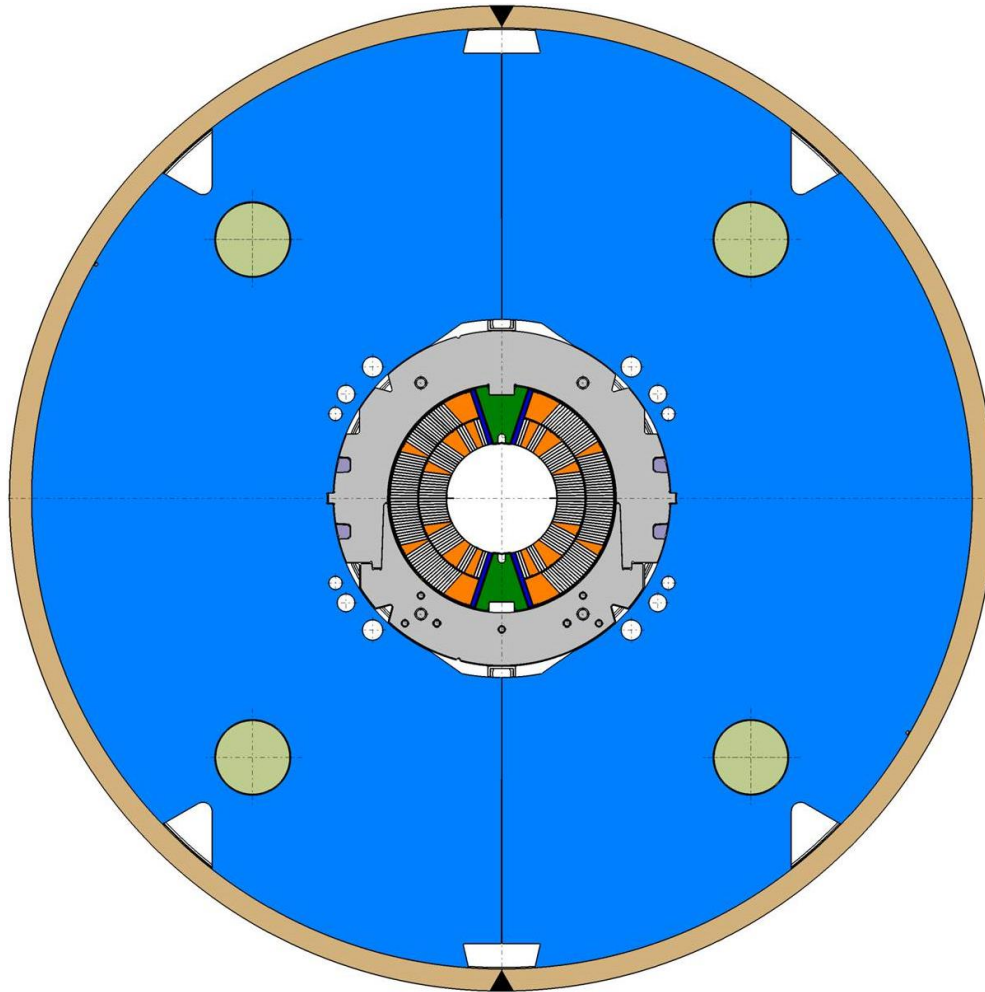

● 11 T Nb₃Sn dipole for the LHC collimation upgrade

● Questions

1. Determine and plot critical curves (J_{sc} vs. B) for Nb₃Sn and Nb-Ti at 1.9 K
2. Determine coil filling factor (J_0 / J_{sc} ratio or $A_{\text{non-Cu_cable}} / A_{\text{insulated_cable}}$)
3. Compute load-line (J_{sc} vs. B) for a
 1. Sector coil (60°) with constant current density
4. Determine coil size, operational (80% of I_{ss}), conditions, “short-sample” conditions, and margins
 1. w
 2. $j_{sc_ss}, j_{o_ss}, B_{bore_ss}, B_{peak_ss}$
 3. $j_{sc_op}, j_{o_op}, B_{bore_op}, B_{peak_op}$
 4. T, j_{sc}, B_{peak} margins
5. Compare “short sample”, “operational” conditions and margins if the same design uses Nb-Ti superconducting technology with the same coil size w
6. Determine e.m forces F_x and F_y and the accumulated stress on the coil mid-plane in the operational conditions
7. Evaluate dimension of collars, iron yoke, and shrinking cylinder, assuming that the support structure is designed to reach 90% of I_{ss}

- 11 T Nb₃Sn dipole for the LHC collimation upgrade
 - Question
 - Determine and plot critical curves (J_{sc} vs. B) for Nb₃Sn and Nb-Ti at 1.9 K

- The critical surface defines the boundaries between superconducting state and normal conducting state in the space defined by temperature, magnetic field, and current densities.
- The surface, determined experimentally, can be fitted with parameterization curves.

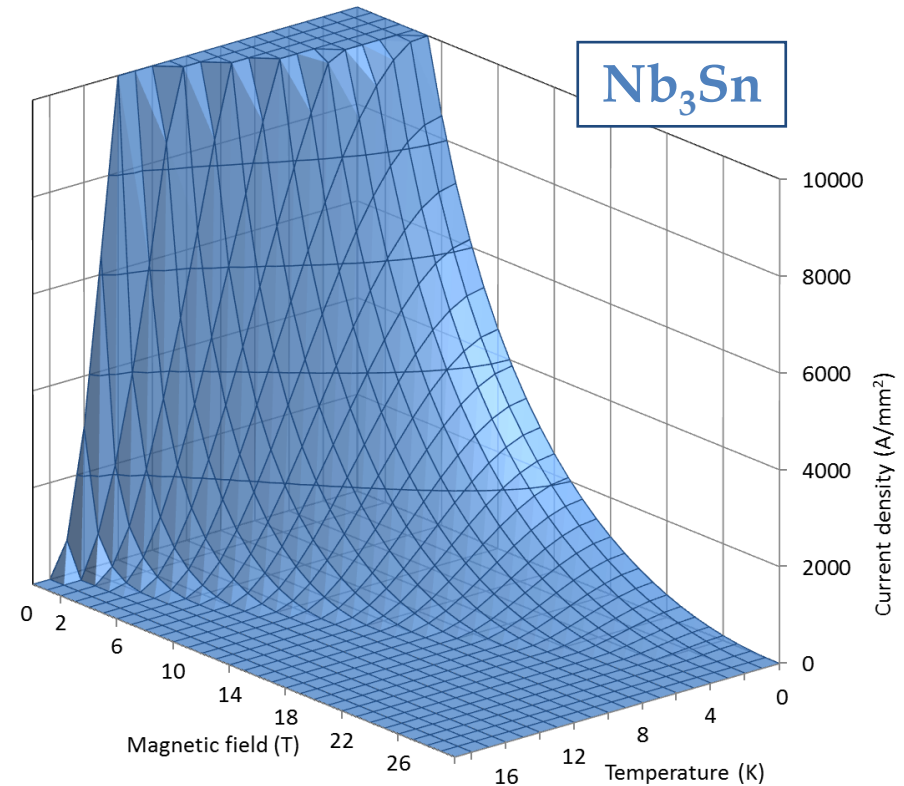
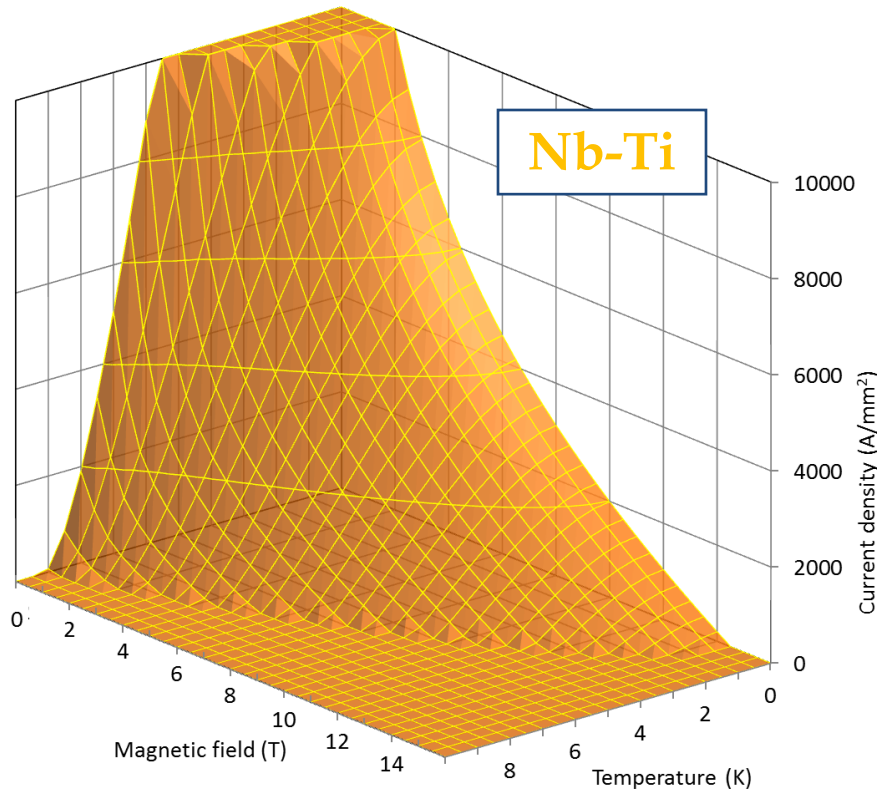

- The critical current of a conductor is measured by winding a sample of the wire around a sample holder.
- To avoid premature quenching induced by Lorentz forces during ramping, the wire must be well supported
 - Stycast glue may be used to constrain the wire around the holder
- In case of Nb_3Sn wires, a sample holder made of titanium is used.
- Once the wire is cooled-down and placed in a given magnetic field, the current is increased until the transition occurs.



- Nb-Ti parameterization

- Temperature and field dependence of B_{C2} and T_C are provided by Lubell's formulae:

$$B_{C2}(T) = B_{C20} \left[1 - \left(\frac{T}{T_{C0}} \right)^{1.7} \right] \quad T_C(B)^{1/1.7} = T_{C0} \left[1 - \left(\frac{B}{B_{C20}} \right)^{1/1.7} \right]$$

where B_{C20} is the upper critical flux density at zero temperature (14.5 T), and T_{C0} is critical temperature at zero field (9.2 K)

- Temperature and field dependence of J_c is given by Bottura's formula

$$\frac{J_C(B, T)}{J_{C,ref}} = \frac{C_{NbTi}}{B} \left[\frac{B}{B_{C2}(T)} \right]^{\alpha_{NbTi}} \left[1 - \frac{B}{B_{C2}(T)} \right]^{\beta_{NbTi}} \left[1 - \left(\frac{T}{T_{C0}} \right)^{1.7} \right]^{\gamma_{NbTi}}$$

where $J_{C,Ref}$ is critical current density at 4.2 K and 5 T (3000 A/mm²) and C_{Nb-Ti} (27 T), α_{Nb-Ti} (0.63), β_{Nb-Ti} (1.0), and γ_{Nb-Ti} (2.3) are fitting parameters.

- Nb₃Sn parameterization

- Temperature, field, and strain dependence of J_c is given by Summers' formula

$$J_c(B, T, \varepsilon) = \frac{C_{Nb_3Sn}(\varepsilon)}{\sqrt{B}} \left[1 - \frac{B}{B_{C2}(T, \varepsilon)} \right]^2 \left[1 - \left(\frac{T}{T_{C0}(\varepsilon)} \right)^2 \right]^2$$

$$\frac{B_{C2}(T, \varepsilon)}{B_{C20}} = \left[1 - \left(\frac{T}{T_{C0}(\varepsilon)} \right)^2 \right] \left\{ 1 - 0.31 \left(\frac{T}{T_{C0}(\varepsilon)} \right)^2 \left[1 - 1.77 \ln \left(\frac{T}{T_{C0}(\varepsilon)} \right) \right] \right\}$$

$$C_{Nb_3Sn}(\varepsilon) = C_{Nb_3Sn,0} \left(1 - \alpha_{Nb_3Sn} |\varepsilon|^{1.7} \right)^{1/2}$$

$$B_{C20}(\varepsilon) = B_{C20m} \left(1 - \alpha_{Nb_3Sn} |\varepsilon|^{1.7} \right)$$

$$T_{C0}(\varepsilon) = T_{C0m} \left(1 - \alpha_{Nb_3Sn} |\varepsilon|^{1.7} \right)^{1/3}$$

where α_{Nb_3Sn} is 900 for $\varepsilon = -0.003$, T_{C0m} is 18 K, B_{C20m} is 27.6 T, and $C_{Nb_3Sn,0}$ is a fitting parameter equal to 43100000000 AT^{1/2}mm⁻² for a $J_c=2900$ A/mm² at 4.2 K and 12 T.

Assume $\varepsilon = 0.000$

● References

- M.S. Lubell, “Empirical scaling formulas for critical current and critical fields for commercial NbTi,” *IEEE Trans. Magn.*, Vol. MAG-19 No. 3, pp. 754–757, 1983.
- L. Bottura, “A practical fit for the critical surface of NbTi,” *IEEE Trans. Appl. Supercond.*, Vol. 10, No. 1, pp. 1054–1057, 2000.
- L.T. Summers, M.W. Guinan, J.R. Miller and P.A. Hahn, “A model for the prediction of Nb₃Sn critical current as a function of field, temperature, strain and radiation damage,” *IEEE Trans. Magn.*, Vol. 27, No. 2, pp. 2041–2044, 1991.

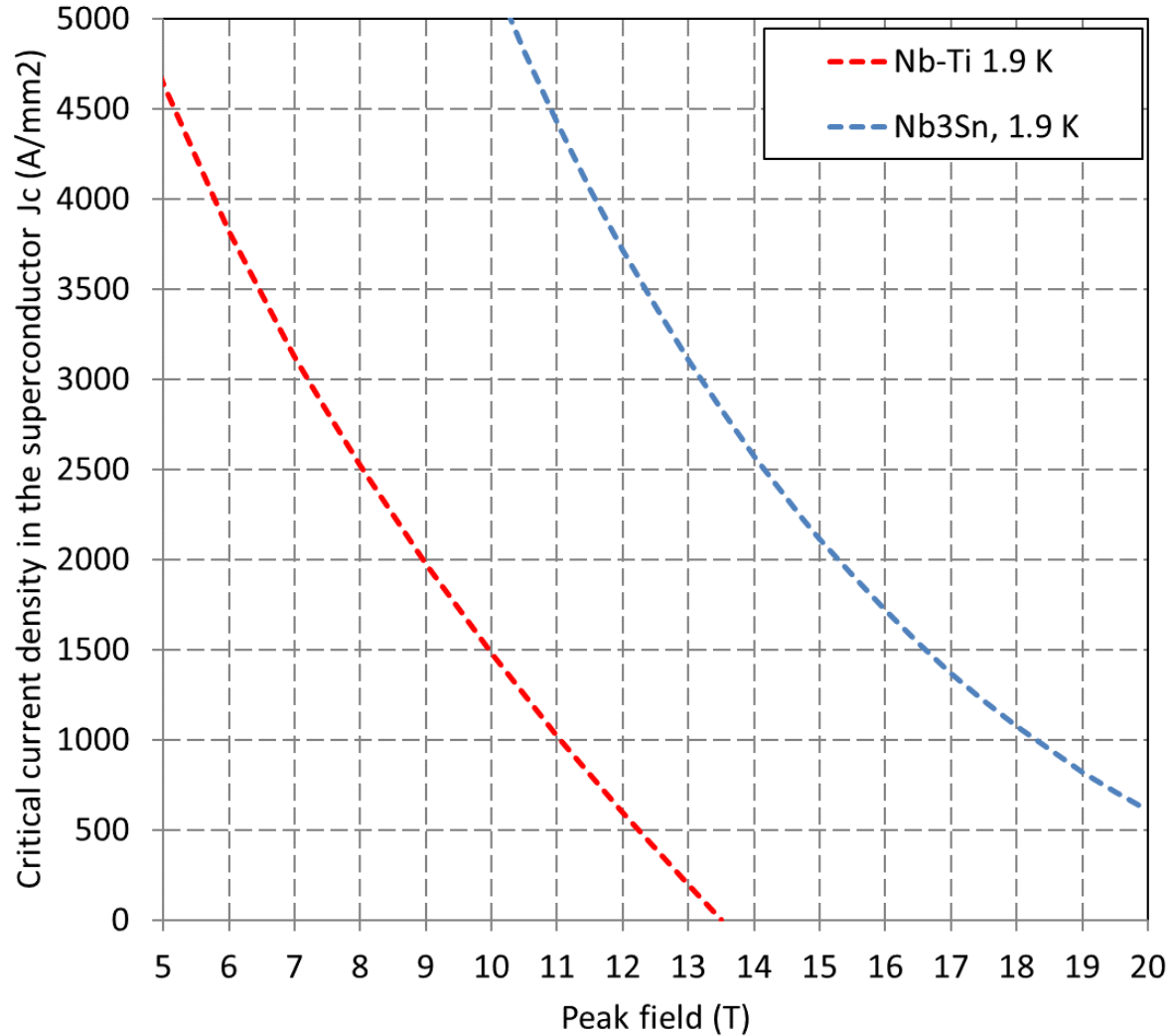

- 11 T Nb₃Sn dipole for the LHC collimation upgrade
 - Question
 - Determine coil filling factor (J_0 / J_{sc} ratio or $A_{\text{non-Cu_cable}} / A_{\text{insulated_cable}}$)



- The cable design parameters are:

- Number of wires N_{wire}
- Wire diameter d_{wire}
- Cable mid-thickness t_{cable}
- Cable width w_{cable}
- (Cu/non-Cu) ratio
- Insulation thickness
- Pitch angle
 - To be neglected in this comp.

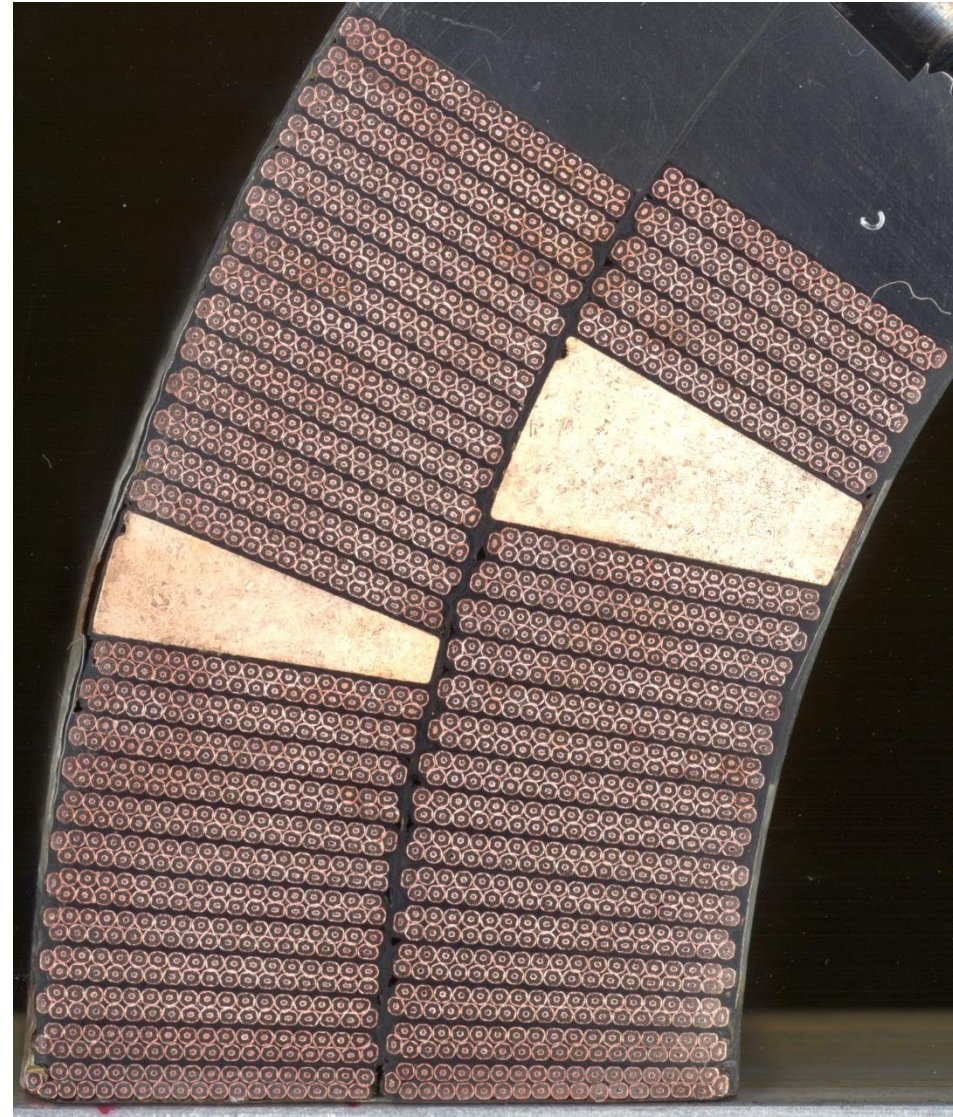
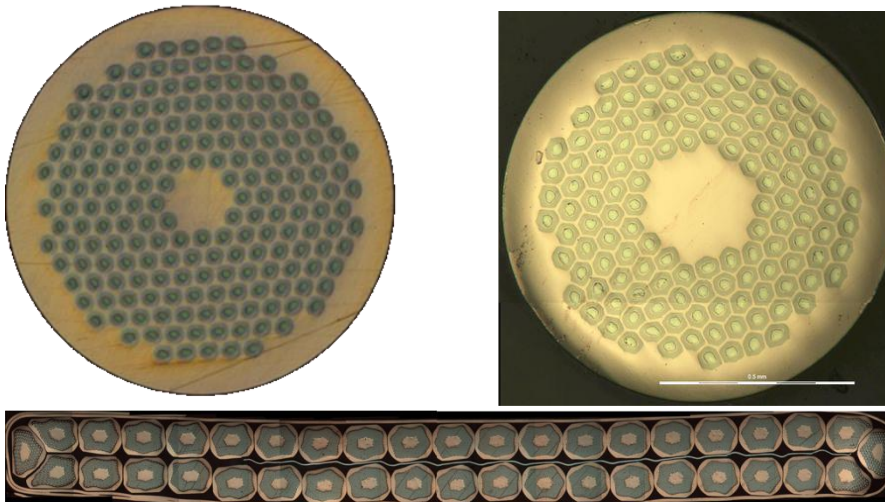

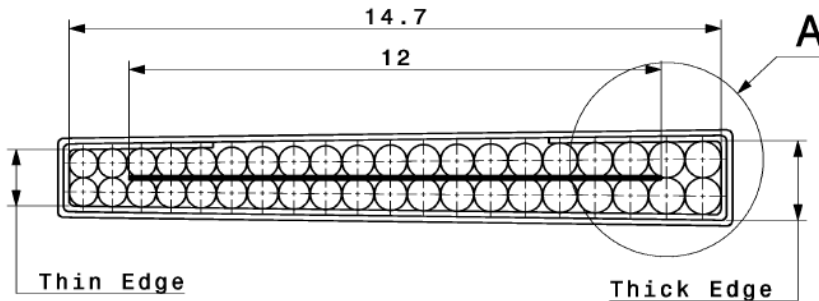

Enlarged and not to scale,
for illustration purposes only

Detail A
Scale: 20:1

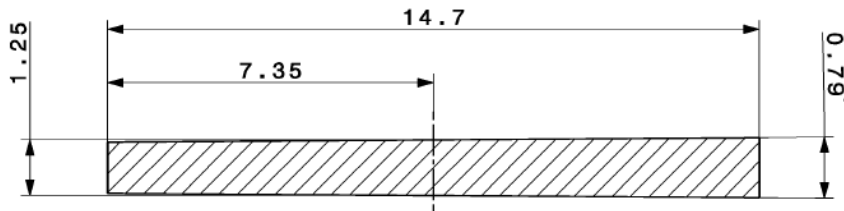
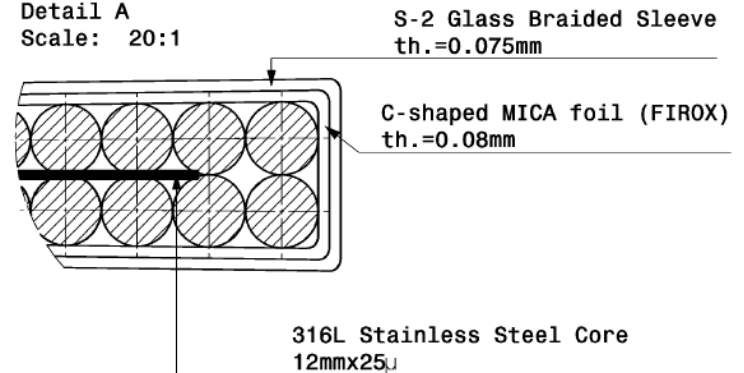

DIMENSION FOR
CONDUCTOR WITHOUT INSULATION
Scale:10:1

UNREACTED CABLE DIMENSIONS	
Strand Type	Nb3Sn
Strand Diameter	0.7 mm
Number of strands	40 (2 x 20)
Width	14.7 mm
Mid-thickness	1.25 mm
Keystone Angle	0.79°
(Thin Edge Height)	(1.149 mm)
(Thick Edge Height)	(1.351 mm)
Inner Core	12 mm x 25 µ
INSULATION THICKNESS	
Mica Layer	0.08 mm
Fibre braiding	0.075 mm
Total insulation thickness	0.155 mm (under compression 30MPa: 0.1 mm)

● *Cu to non-Cu ratio: 1.2*

11 T	
N strand	40
Strand d (mm)	0.7
Cable width (mm)	14.7
Cable in thckn. (mm)	1.149
Cable out thckn. (mm)	1.351
Keystone angle	0.79
Ins	0.1
Cu%	54.5
Sc%	45.5
Cu/Sc ration	1.20
Area sc in cable (mm ²)	7.004
Area copper in cable (mm ²)	8.390
Area ins cable (mm ²)	21.605
Fill fact	0.32

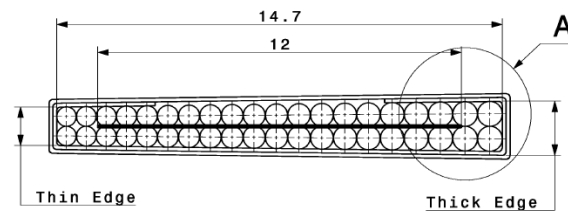

Enlarged and not to scale, for illustration purposes only

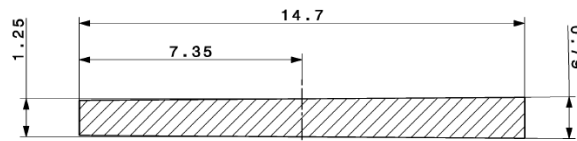

DIMENSION FOR CONDUCTOR WITHOUT INSULATION
Scale:10:1

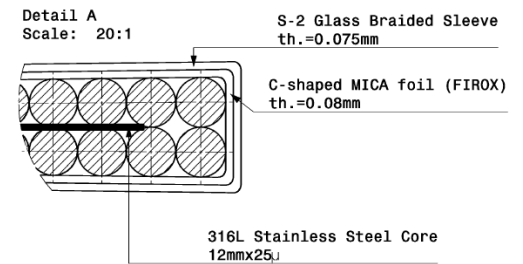

UNREACTED CABLE DIMENSIONS	
Strand Type	Nb3Sn
Strand Diameter	0.7 mm
Number of strands	40 (2 x 20)
Width	14.7 mm
Mid-thickness	1.25 mm
Keystone Angle	0.79°
(Thin Edge Height)	(1.149 mm)
(Thick Edge Height)	(1.351 mm)
Inner Core	12 mm x 25 µ
INSULATION THICKNESS	
Mica Layer	0.08 mm
Fibre braiding	0.075 mm
Total insulation thickness	0.155 mm (under compression 30MPa: 0.1 mm)

● 11 T Nb₃Sn dipole for the LHC collimation upgrade

● Question

- Compute load-line (J_{sc} vs. B) for a
 - Sector coil (60°) with constant current density
- Determine coil size, operational (80% of I_{ss}), conditions, “short-sample” conditions, and margins
 - w
 - $j_{sc_{ss}}, j_{o_{ss}}, B_{bore_{ss}}, B_{peak_{ss}}$
 - $j_{sc_{op}}, j_{o_{op}}, B_{bore_{op}}, B_{peak_{op}}$
 - T, j_{sc}, B_{peak} margins
- Compare “short sample”, “operational” conditions and margins if the same design uses Nb-Ti superconducting technology with the same coil size w

- Short sample current
 - The critical current is measured in few different conditions of temperature and field. By fitting the data with known parameterizations, the entire critical surface can be reconstructed.
- If the magnet reaches the maximum current computed through the intersection of the measured critical surface and the load line, i.e. $I_{max} = I_{ss}$, one can declare victory (at least from the quench performance point of view).
- If the magnet maximum current I_{max} is lower than I_{ss} , the quench performance is expressed in term of fraction of short sample (I_{max}/I_{ss}).
- Usually magnets are designed to operate at $I_{op} = 0.8 I_{ss}$ or below.

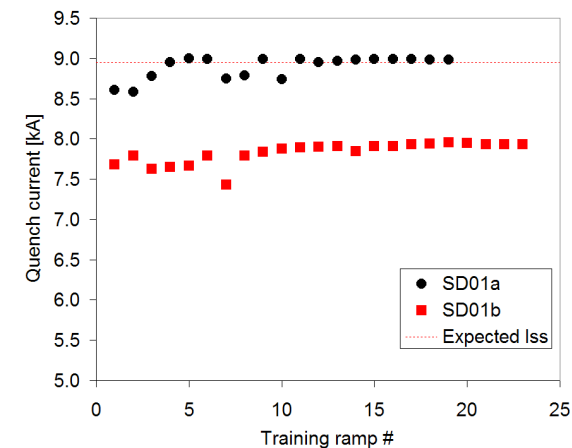
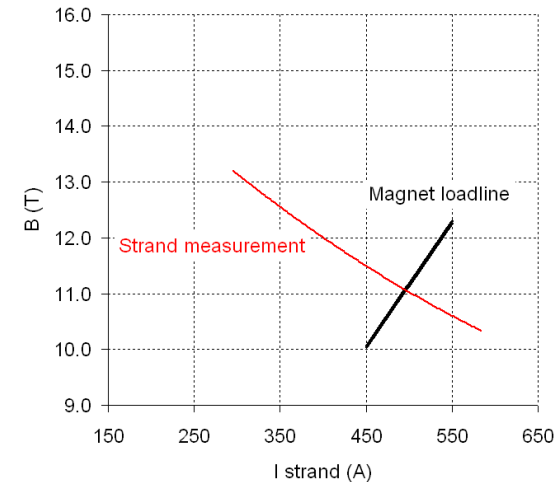

- Sector coil
 - Current density $J = J_0$ (A per unit area) on a a sector with a maximum angle $\theta = 60^\circ$ for a dipole

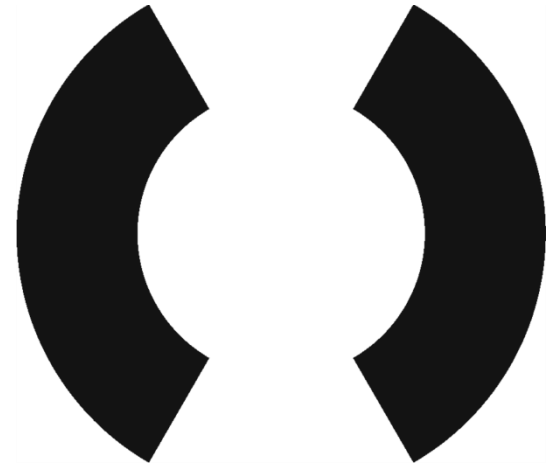

Approximations of practical winding cross-sections

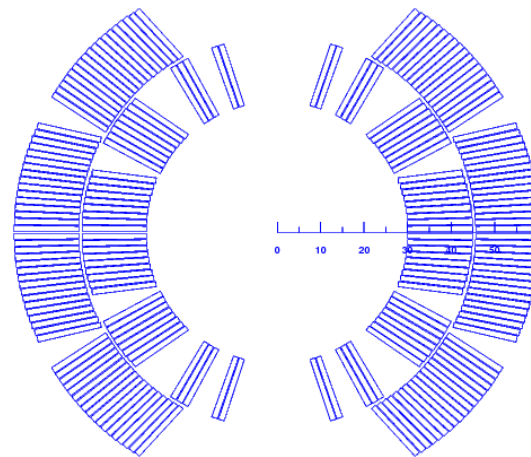
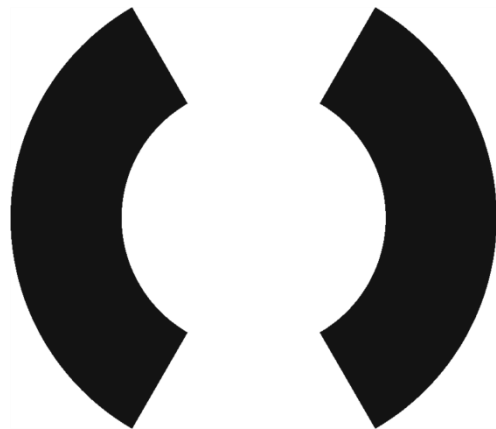

• Sector coil

- Current density $J = J_0$ (A per unit area) on a sector with a maximum angle $\theta = 60^\circ$ for a dipole

$$B_{bore} = -\frac{2j_0\mu_0}{\pi} w \sin(60)$$

- Where, B_{bore} is the bore field, j_0 is overall current density and w is the coil width
- “Less ideal” case
 - $B_{peak} = B_{bore} \cdot \sim 1.04$
 - “Not so perfect” field quality
 - $b_3 = 0$

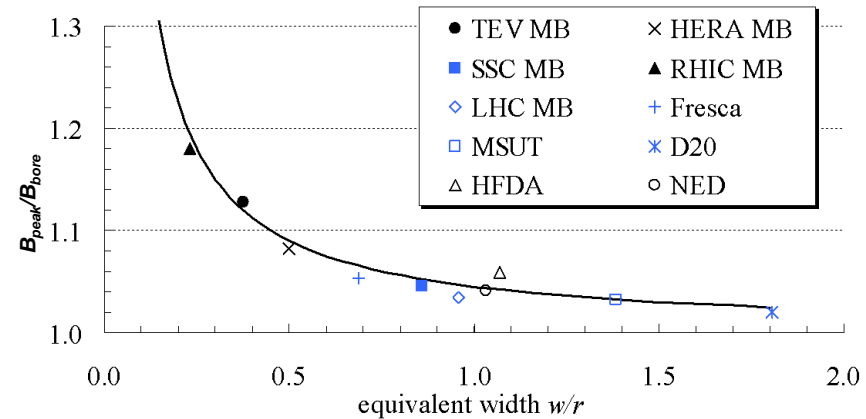
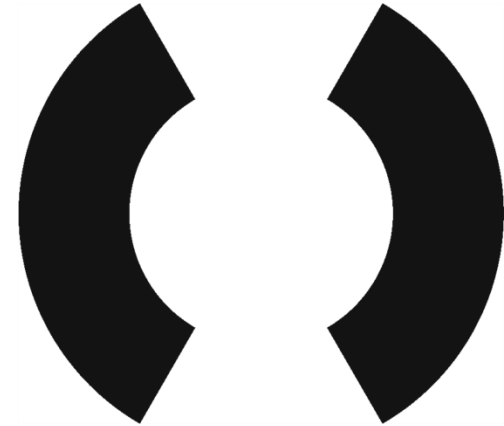

L. Rossi, E. Todesco, “Electromagnetic design of superconducting quadrupoles”, Phys. Rev. ST Accel. Beams 9 (2006) 102401.

- With a w/r of $30/30 = 1 \rightarrow 1.04$

- $B_{bore_op} = 11 \text{ T}$
- $B_{bore_ss} = B_{bore_op} / 0.8 = 13.75 \text{ T}$
- $B_{peak_ss} = B_{bore_ss} \cdot 1.04 = 14.3 \text{ T}$

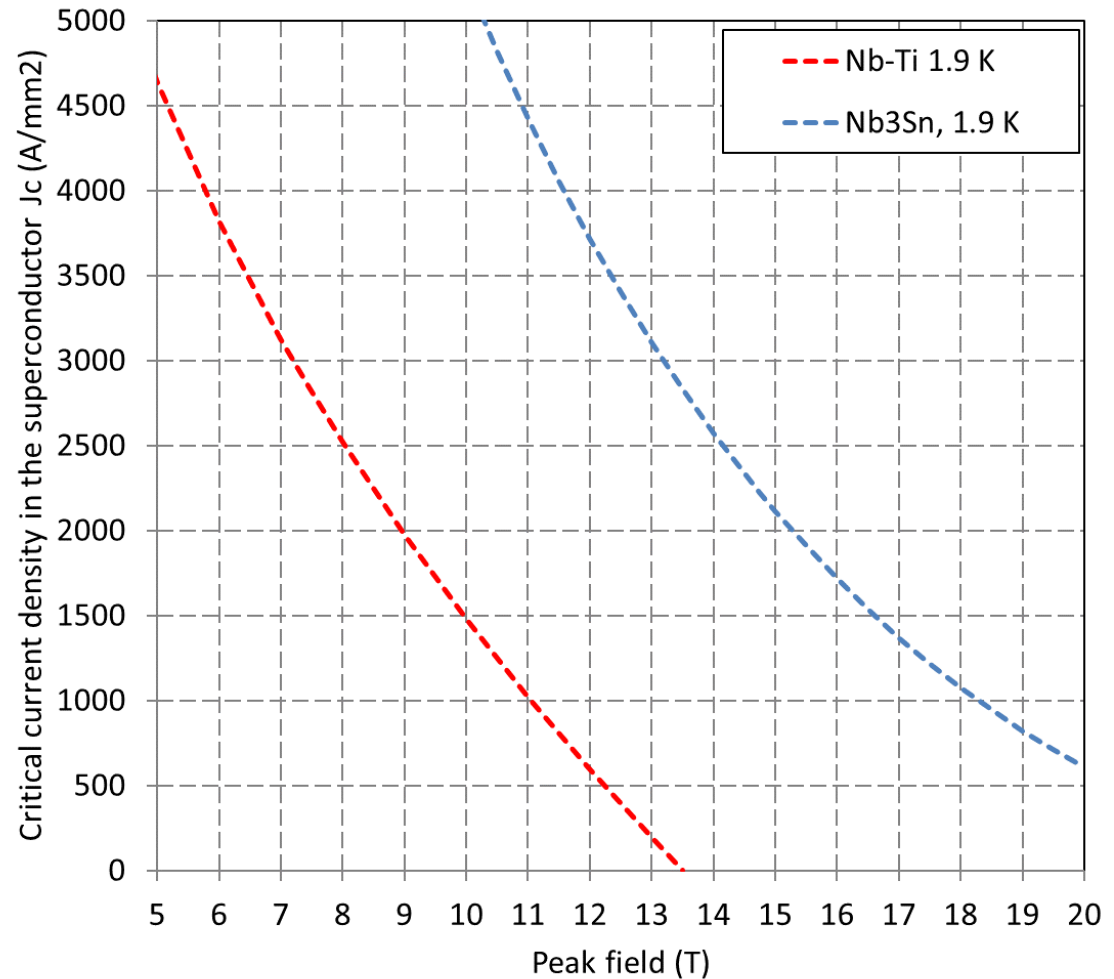

Computation of the load line Sector coil

- $B_{bore_op} = 11 \text{ T}$
- $B_{bore_ss} = B_{bore_op} / 0.8 = 13.75 \text{ T}$
- $B_{peak_ss} = B_{bore_ss} \cdot 1.04 = 14.3 \text{ T}$
- From the critical curve
 - $j_{sc_ss} = 2460 \text{ A/mm}^2$
- Therefore
 - $w = 25.25 \text{ mm}$
- Results
 - $j_{sc_ss} = 2460 \text{ A/mm}^2$
 - $j_{o_ss} = j_{sc_ss} \cdot \lambda = 786 \text{ A/mm}^2$
 - $B_{bore_ss} = 13.75 \text{ T}$
 - $B_{peak_ss} = 14.3 \text{ T}$
 - $j_{sc_op} = 1965 \text{ A/mm}^2$
 - $j_{o_op} = j_{sc_op} \cdot \lambda = 629 \text{ A/mm}^2$
 - $B_{bore_op} = 11 \text{ T}$
 - $B_{peak_op} = 11.44 \text{ T}$
 - $j_{sc_margin} = 2140 \text{ A/mm}^2$
 - $B_{peak_margin} = 4 \text{ T}$
 - $T_{margin} = 6.7 \text{ K}$

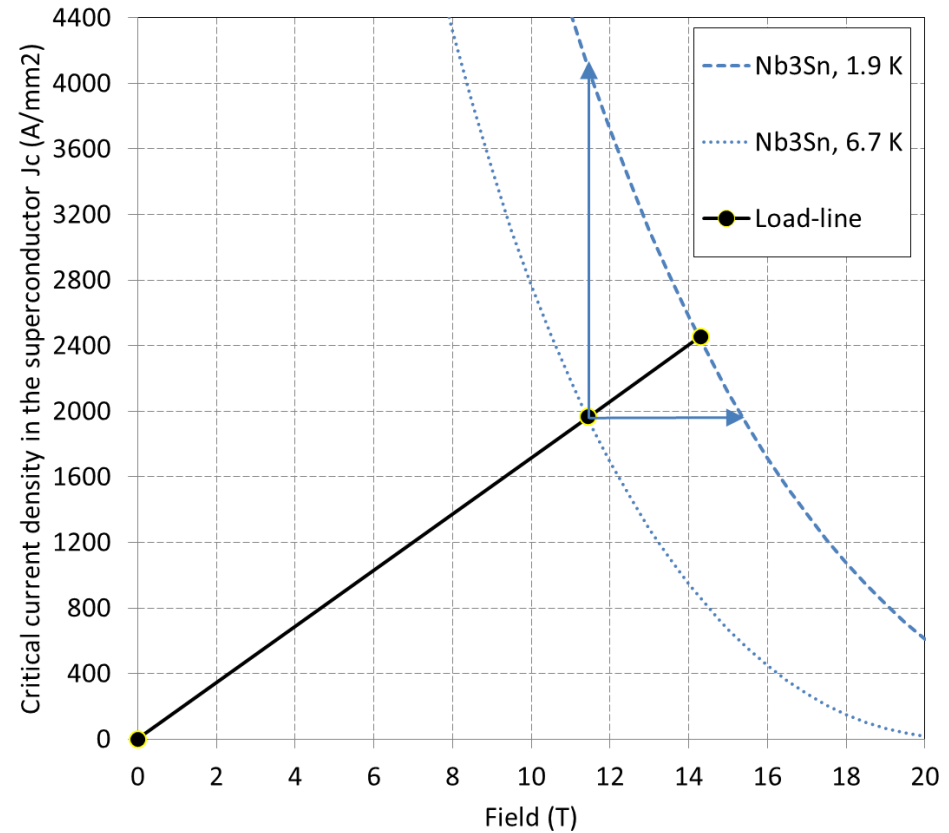

- Nb-Ti parameters

- $w = 25.25 \text{ mm}$

- Results

- $j_{sc_ss} = 1660 \text{ A/mm}^2$
- $j_{o_ss} = j_{sc_ss} * \lambda = 532 \text{ A/mm}^2$
- $B_{bore_ss} = 9.3 \text{ T}$
- $B_{peak_ss} = 9.7 \text{ T}$

- $j_{sc_op} = 1330 \text{ A/mm}^2$
- $j_{o_op} = j_{sc_op} * \lambda = 425 \text{ A/mm}^2$
- $B_{bore_op} = 7.45 \text{ T}$
- $B_{peak_op} = 7.74 \text{ T}$

- $J_{margin} = 1370 \text{ A/mm}^2$
- $B_{margin} = 2.5 \text{ T}$
- $T_{margin} = 2.1 \text{ K}$

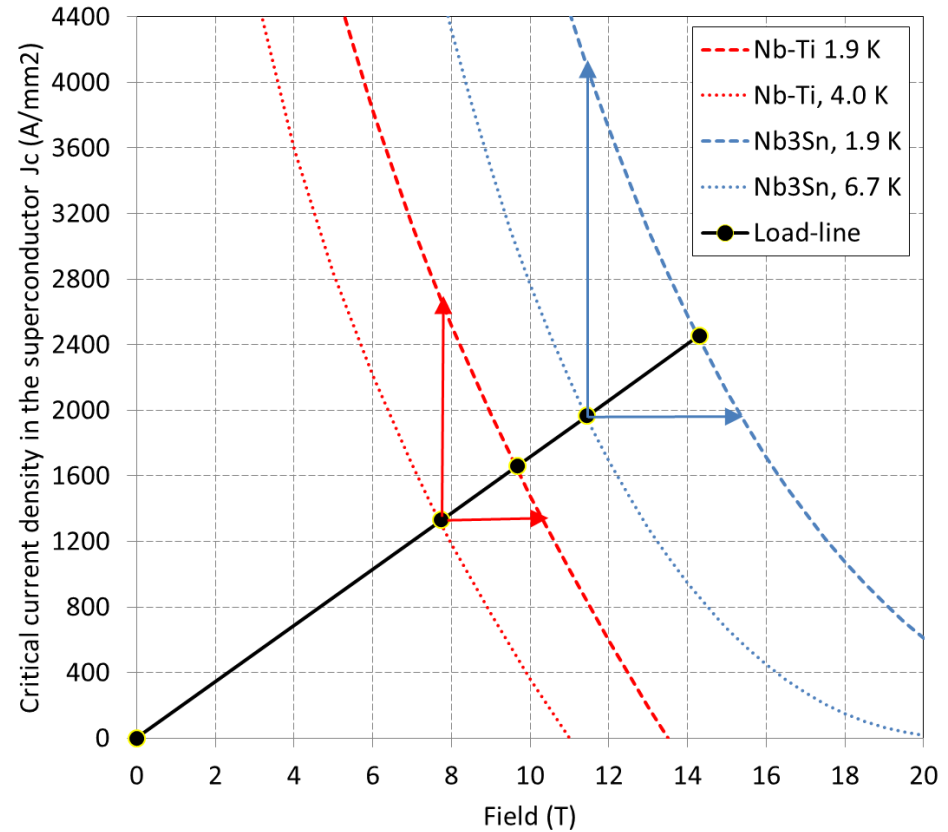

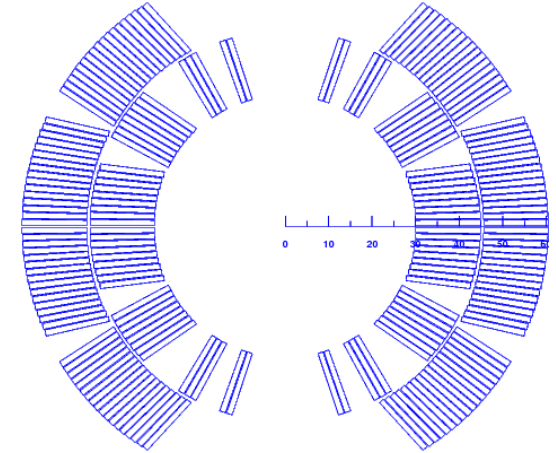
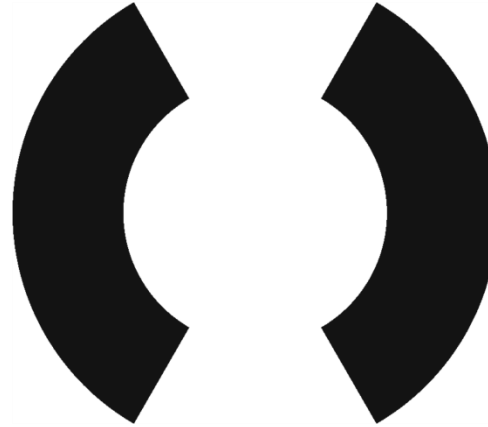

Nb3Sn ss		
	mu	1.2566E-06
Degree	alpha	60
A/m2	J0	786000000
lambda		0.32
A/m2	Jsc	2456250000
A/mm2	Jsc	2456
m	a1	0.03
m	a2	0.05525
m	w	0.02525
T	B1	13.750
	Bpeak/B1	1.040
T	Bpeak	14.300

Roxie		
	mu	1.2566E-06
Degree	alpha	
A/m2	J0	796112011
lambda		0.324
A/m2	Jsc	2455676180
A/mm2	Jsc	2456
m	a1	0.03
m	a2	0.0598
m	w	0.0298
T	B1	13.726939
	Bpeak/B1	1.04019549
T	Bpeak	14.2787

- 11 T Nb₃Sn dipole for the LHC collimation upgrade
 - Question
 - Determine e.m forces F_x and F_y and the accumulated stress on the coil mid-plane in the operational conditions with sector coil approximation

- The e.m. forces in a dipole magnet tend to push the coil
 - Towards the mid plane in the vertical-azimuthal direction ($F_y, F_\theta < 0$)
 - Outwards in the radial-horizontal direction ($F_x, F_r > 0$)

Tevatron dipole

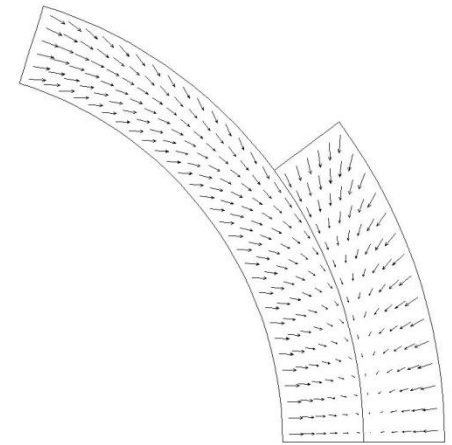
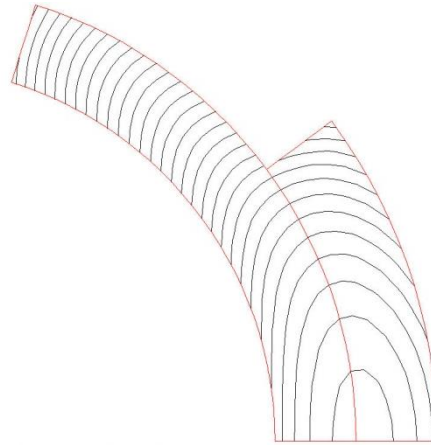
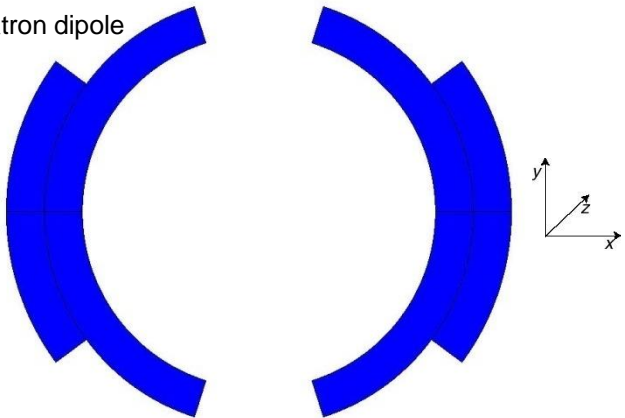

HD2

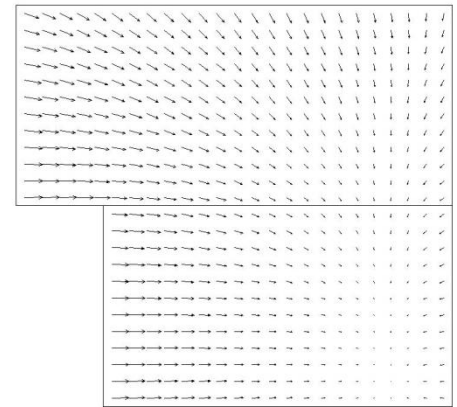
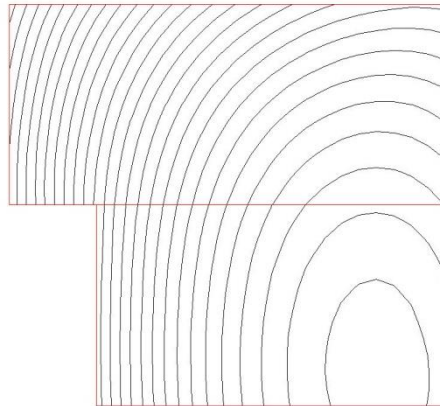
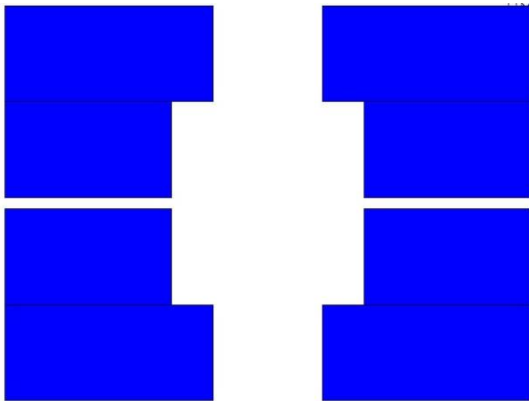

LHC dipole at 0 T

LHC dipole at 9 T

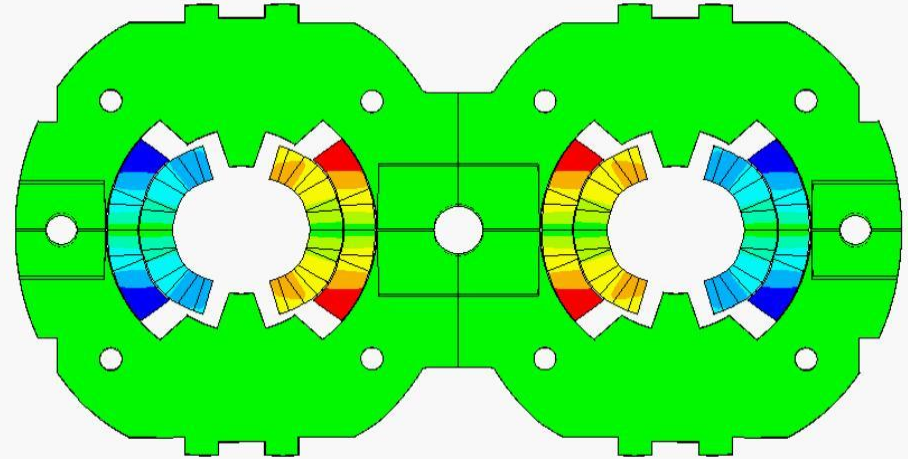
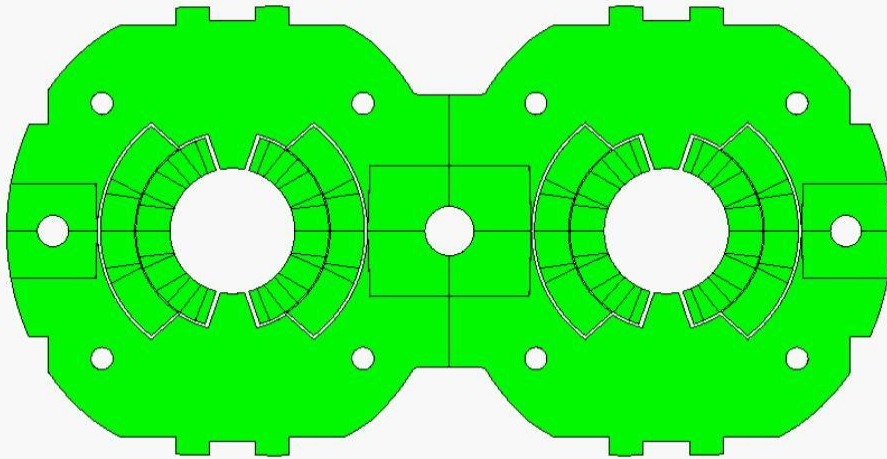

Displacement scaling = 50

- Usually, in a dipole or quadrupole magnet, the highest stresses are reached at the mid-plane, where all the azimuthal e.m. forces accumulate (over a small area).

- For a dipole sector coil, with an inner radius a_1 , an outer radius a_2 and an overall current density j_o , each block (quadrant) see

- Horizontal force outwards

$$F_x = + \frac{2\mu_0 J_0^2}{\pi} \frac{\sqrt{3}}{2} \left[\frac{2\pi - \sqrt{3}}{36} a_2^3 + \frac{\sqrt{3}}{12} \ln \frac{a_2}{a_1} a_1^3 + \frac{4\pi + \sqrt{3}}{36} a_1^3 - \frac{\pi}{6} a_2 a_1^2 \right]$$

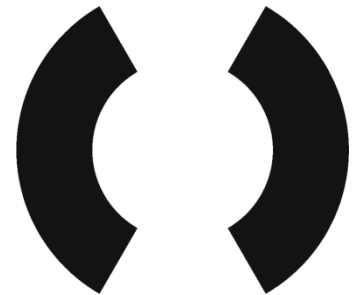

- Vertical force towards the mid-plane

$$F_y = - \frac{2\mu_0 J_0^2}{\pi} \frac{\sqrt{3}}{2} \left[\frac{1}{12} a_2^3 + \frac{1}{4} \ln \frac{a_1}{a_2} a_1^3 - \frac{1}{12} a_1^3 \right]$$

- In case of frictionless and “free-motion” conditions, no shear, and infinitely rigid radial support, the forces accumulated on the mid-plane produce a stress of

$$\sigma_{\theta_mid-plane} = \int_0^{\pi/2} f_{\theta} r d\theta = - \frac{\mu_0 J_0^2}{2} \frac{r}{2} \left[(a_2 - r) + \frac{r^3 - a_1^3}{3r^2} \right]$$

- In the operational conditions ($B_{bore_op} = 11.0$ T)

- F_x (quadrant) = +2.29 MN/m
 - F_x (total) = +4.60 MN/m = 460 t/m
- F_y (quadrant) = -2.10 MN/m

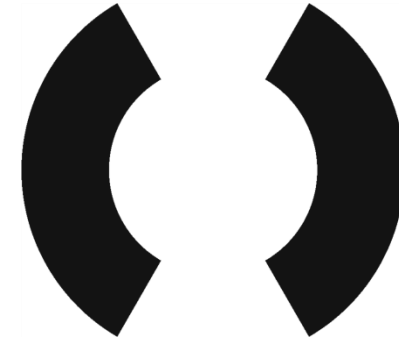

- The accumulates stress on the coil mid-plane is

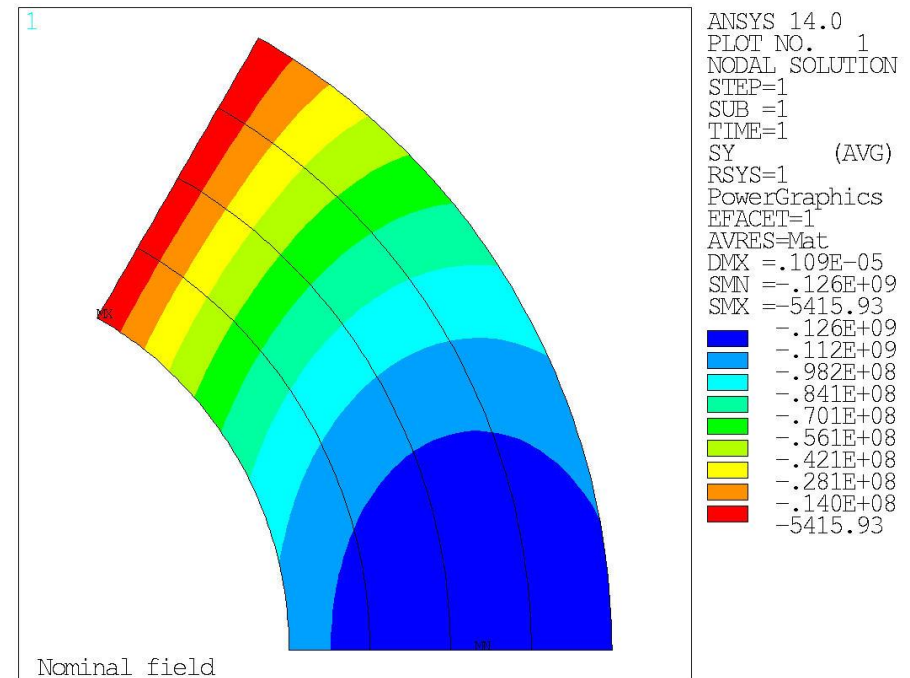
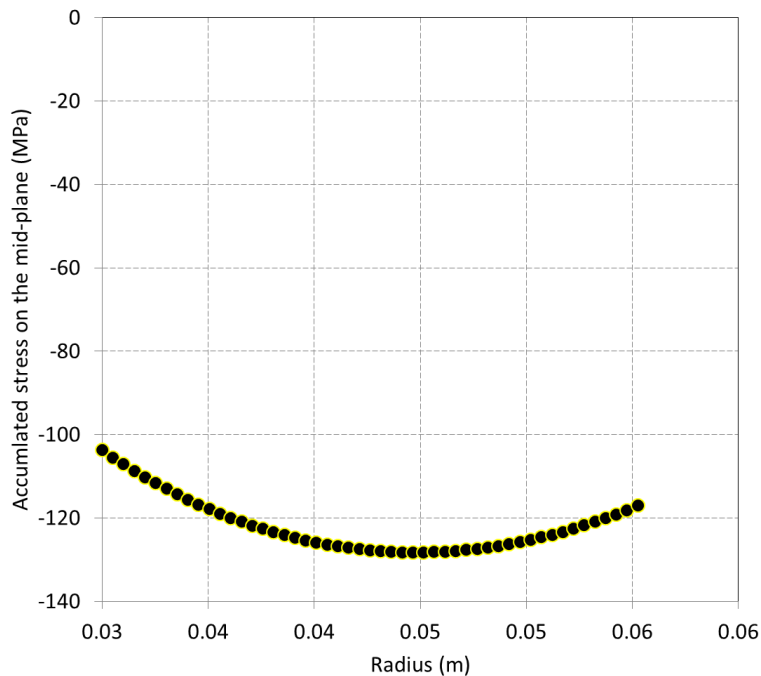

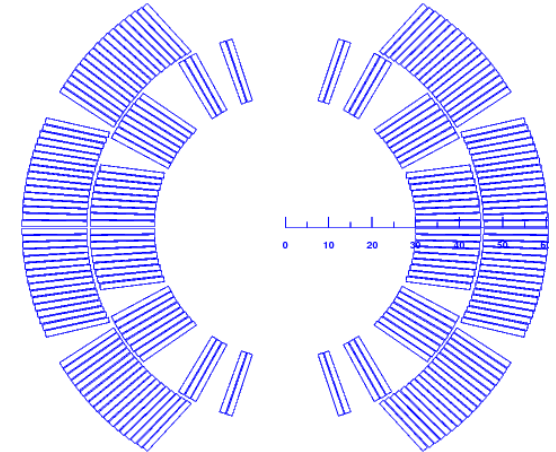
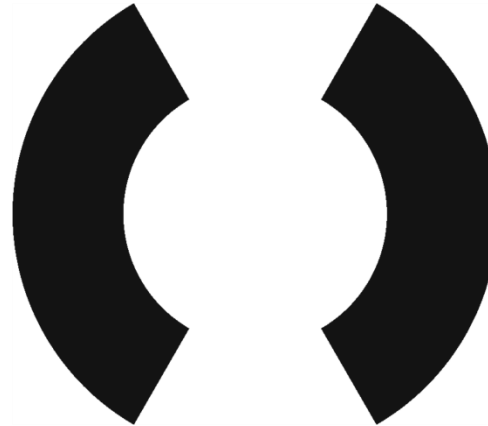

Nb3Sn ss		
	mu	1.2566E-06
Degree	alpha	60
A/m2	J0	786000000
lambda		0.32
A/m2	Jsc	2456250000
A/mm2	Jsc	2456
m	a1	0.03
m	a2	0.05525
m	w	0.02525
T	B1	13.750
	Bpeak/B1	1.040
T	Bpeak	14.300
N/m	Fx (quad)	3590690
N/m	Fy (quad)	-3288267
N/m	Fx tot	7181379

Roxie		
	mu	1.2566E-06
Degree	alpha	
A/m2	J0	796112011
lambda		0.324
A/m2	Jsc	2455676180
A/mm2	Jsc	2456
m	a1	0.03
m	a2	0.0598
m	w	0.0298
T	B1	13.726939
	Bpeak/B1	1.04019549
T	Bpeak	14.2787
N/m	Fx (quad)	4127000
N/m	Fy (quad)	-3294600
N/m	Fx tot	8254000

- 11 T Nb₃Sn dipole for the LHC collimation upgrade
 - Question
 - Evaluate dimension of collars, iron yoke, and shrinking cylinder, assuming that the support structure is designed to reach 90% of I_{ss}

- Collars were implemented for the first time in the Tevatron dipoles.
- Since then, they have been used in all but one (RHIC) the accelerator magnets and in most of the R&D magnets.
- They are composed by stainless-steel or aluminum laminations few mm thick.
- By clamping the coils, the collars provide
 - coil pre-stressing;
 - rigid support against e.m. forces (it can be self-supporting or not);
 - precise cavity (tolerance $\pm 20 \mu\text{m}$).

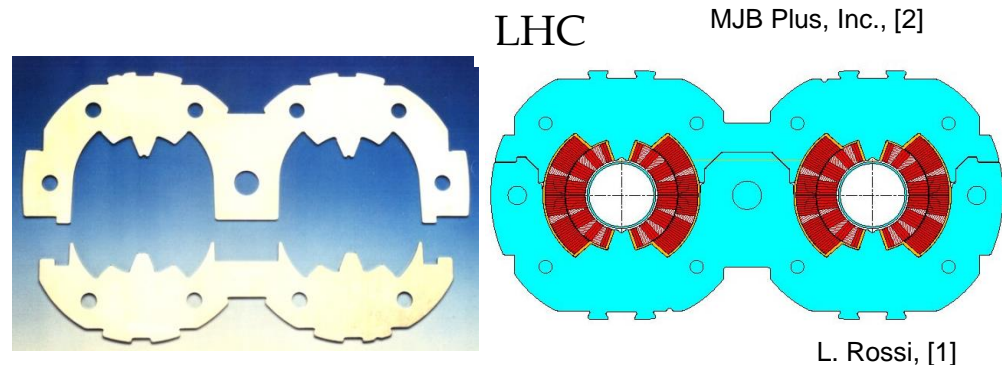
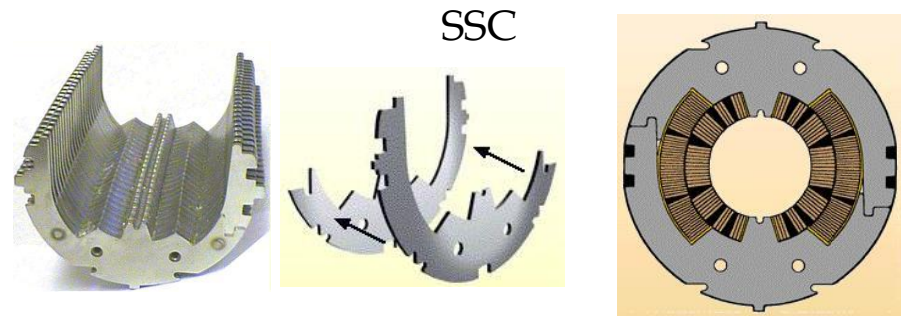
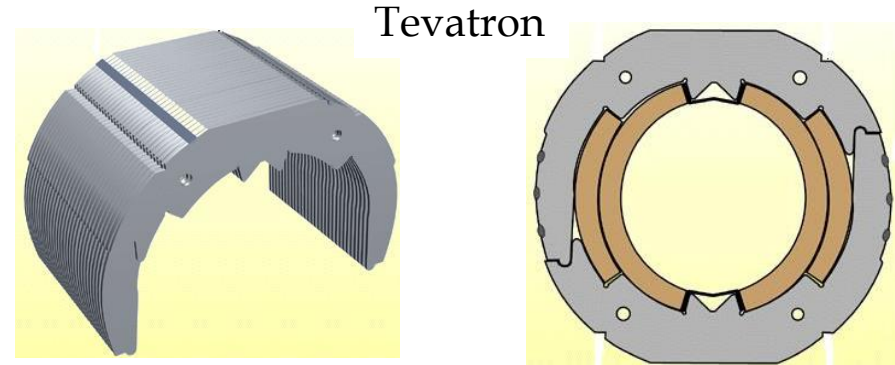

- Collaring procedure
 - Collars are pre-assembled in packs (several cm long) and placed around the coil.
 - The collar laminations are divided in “short” and “long”.
 - Since the uncompressed coil is oversized with respect to the collar cavity dimension, at the beginning of the collaring procedure the collars are not locked (open).
 - The coil/collar pack is then introduced into a collaring press.
 - The pressure of the press is increased until a nominal value.
 - Collars are locked with keys, rods or welded, and the press released.
 - Once the collaring press is released, the collar experience a “spring back” due to the clearance of the locking feature and deformation.

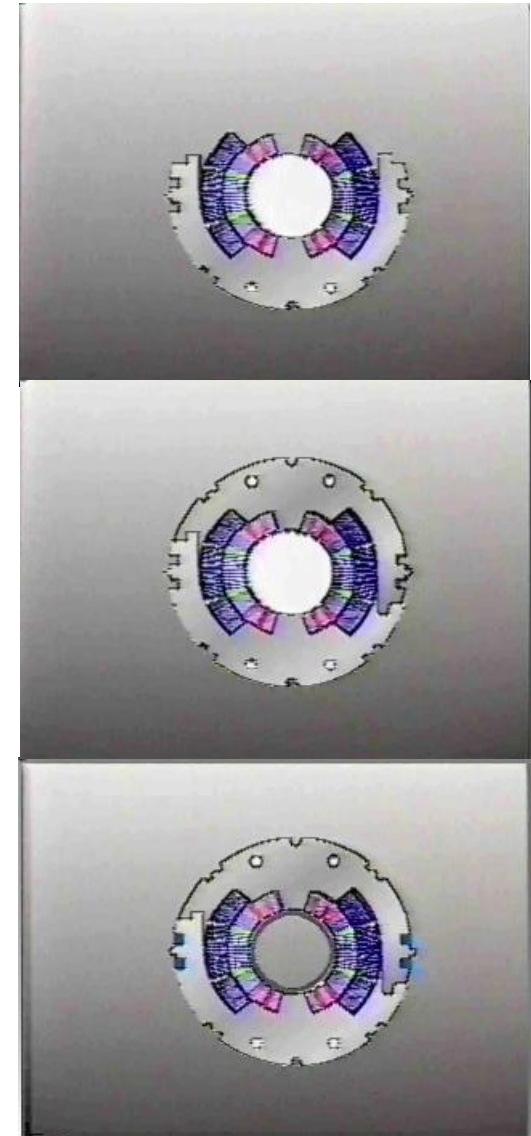

Collaring of a dipole magnet

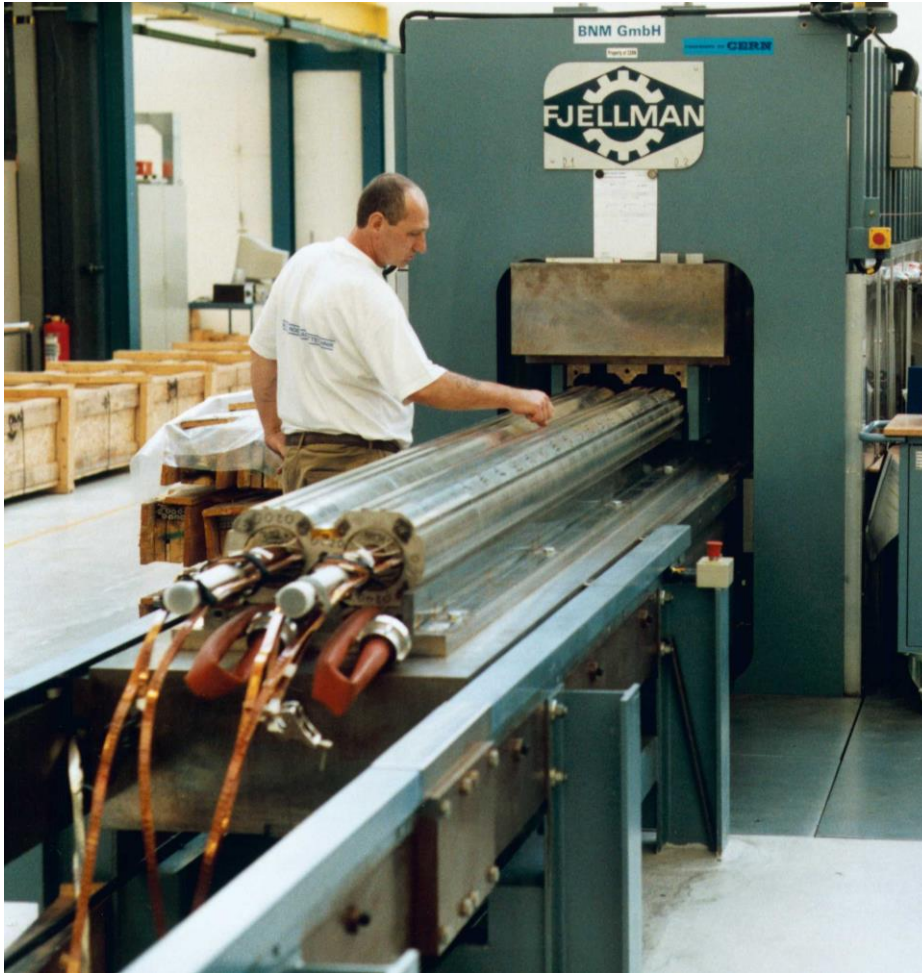

Collaring of a quadrupole magnet

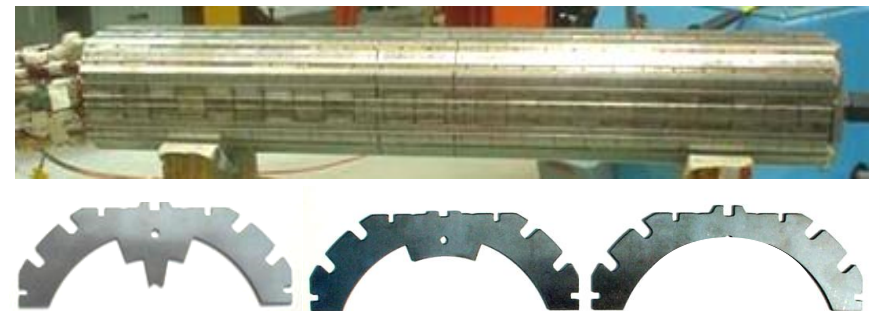
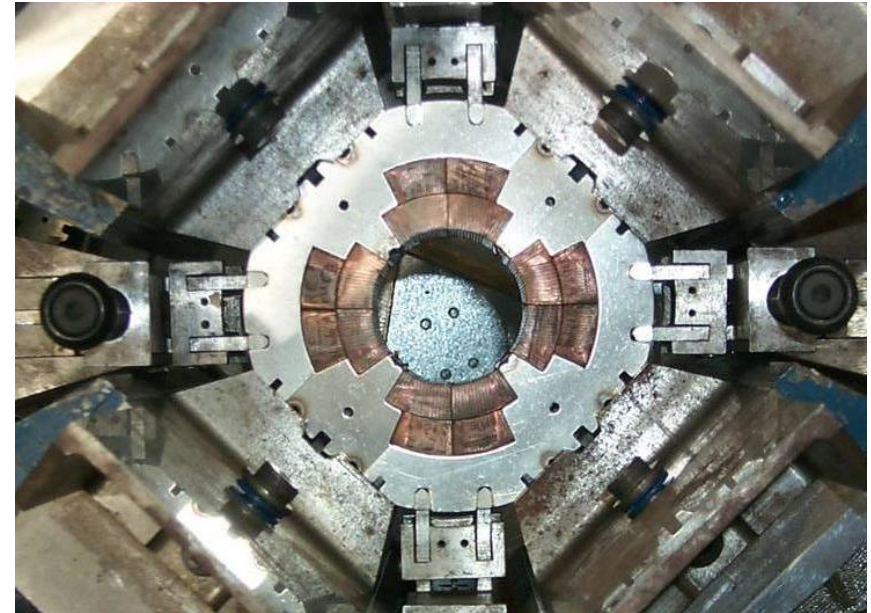

- We assume a 25 mm thick collar
 - Images not in scale

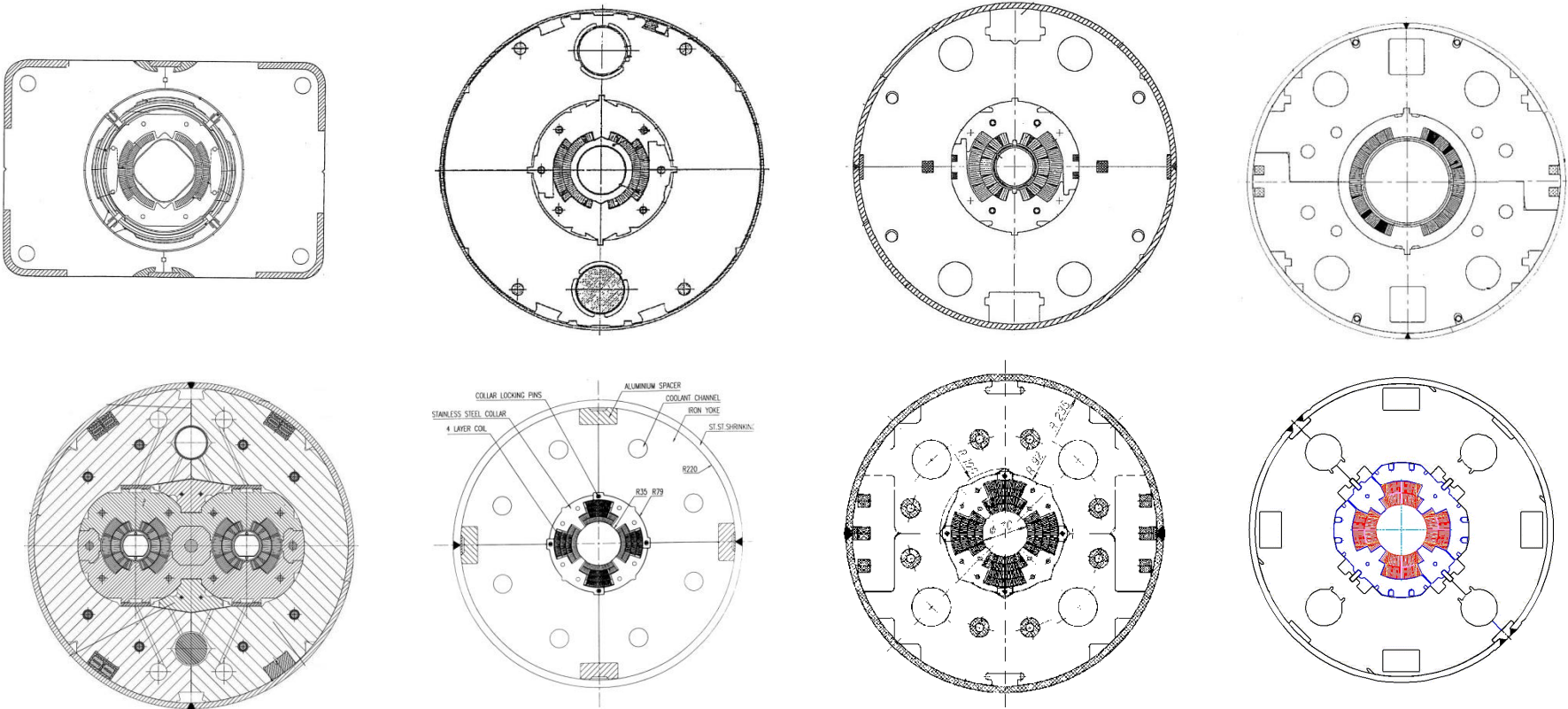

Without iron yoke

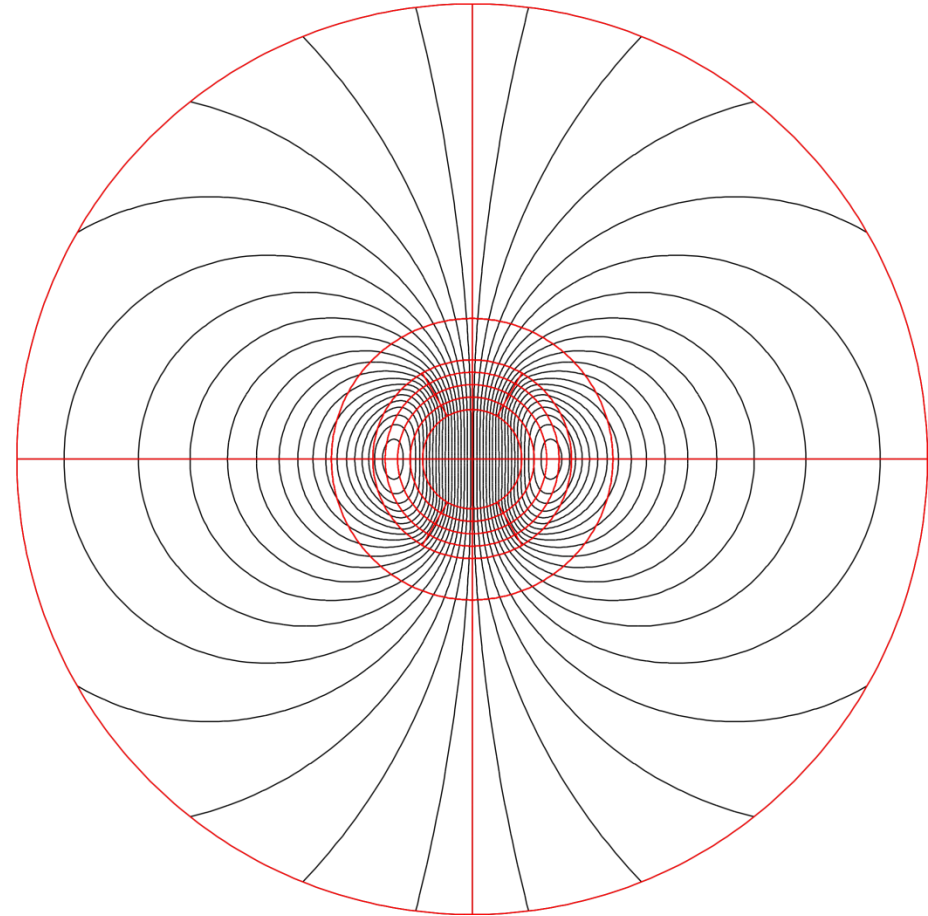
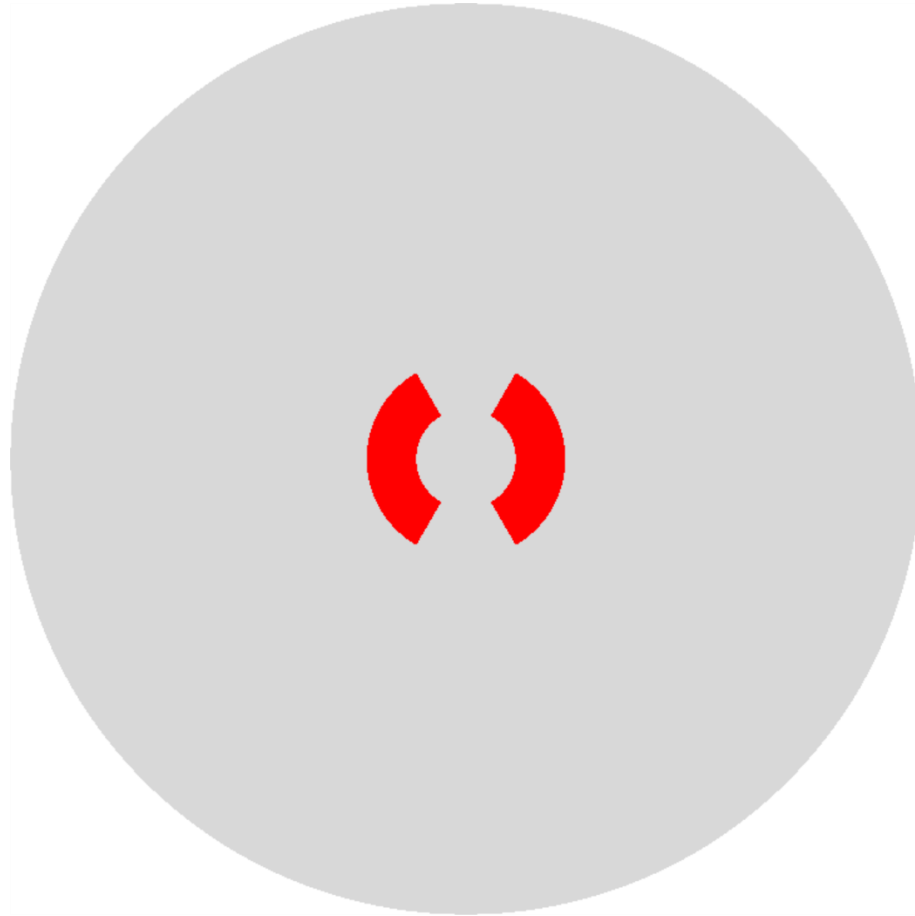

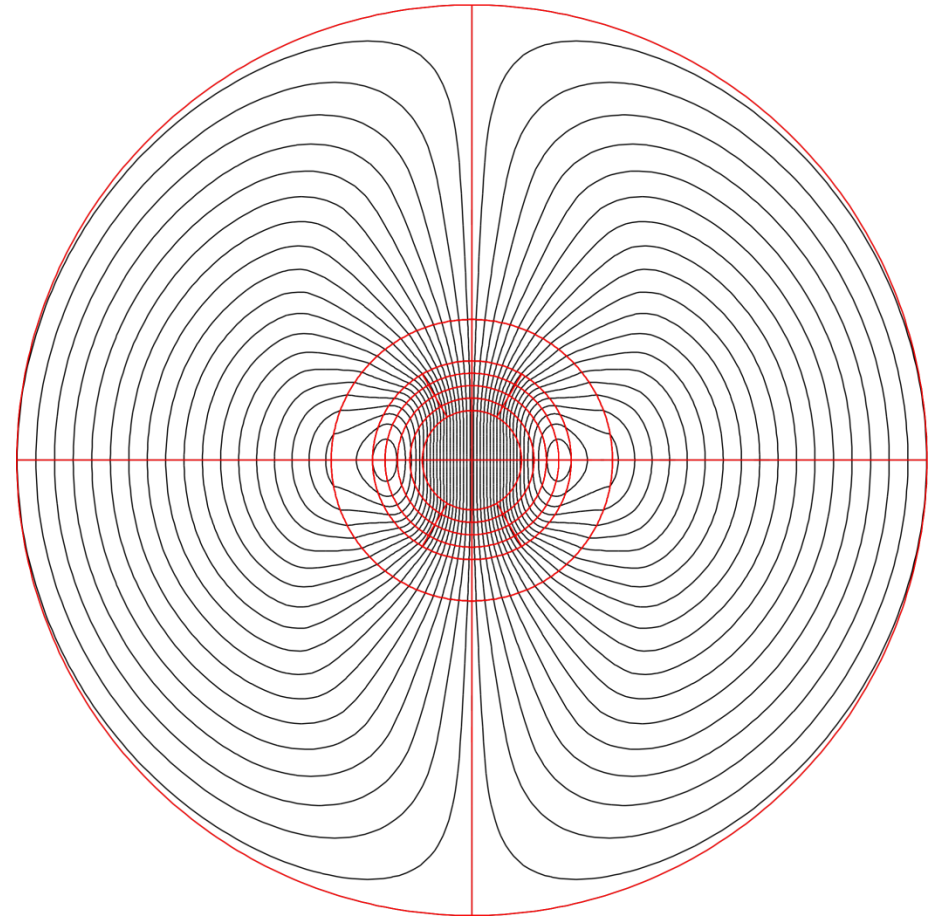
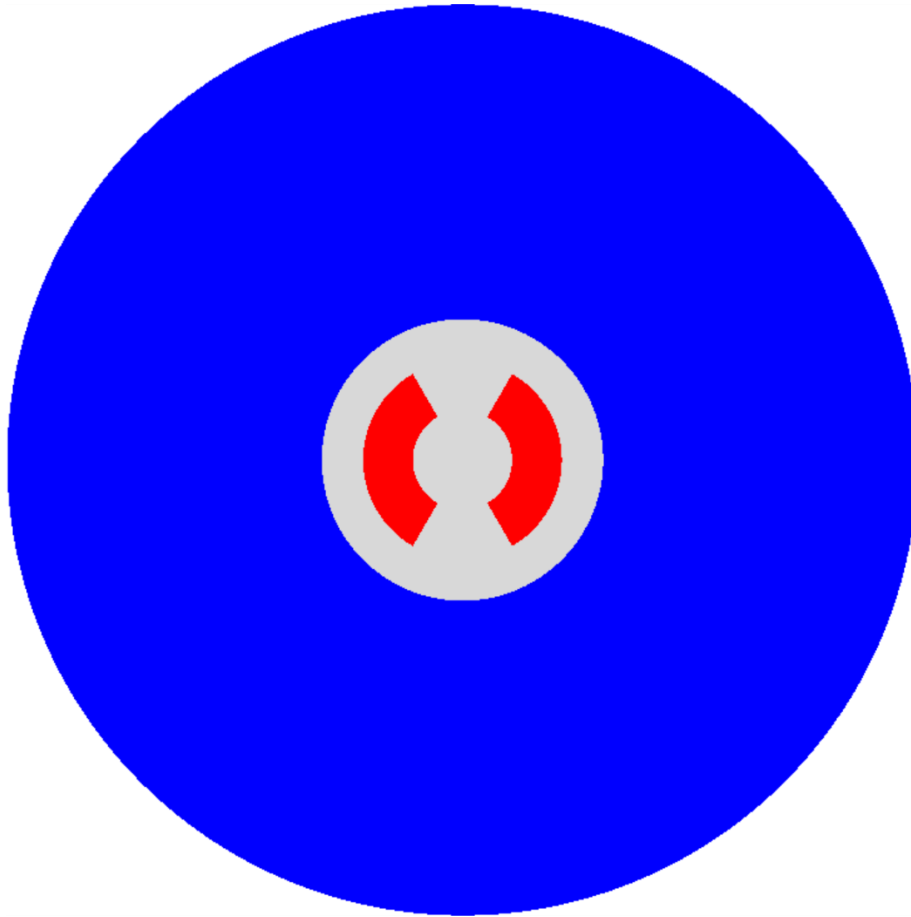

- The iron yoke thickness can be estimated with $rB \sim t_{iron} B_{sat}$

- The iron yoke thickness can be estimated with $rB \sim t_{iron} B_{sat}$

- Therefore, being

- $B_{bore} = 12.2 \text{ T}$ (at 90% of I_{ss})
- $r = 30 \text{ mm}$ and
- $B_{sat} = 2 \text{ T}$

- we obtain

- $t_{iron} = \sim 190 \text{ mm}$

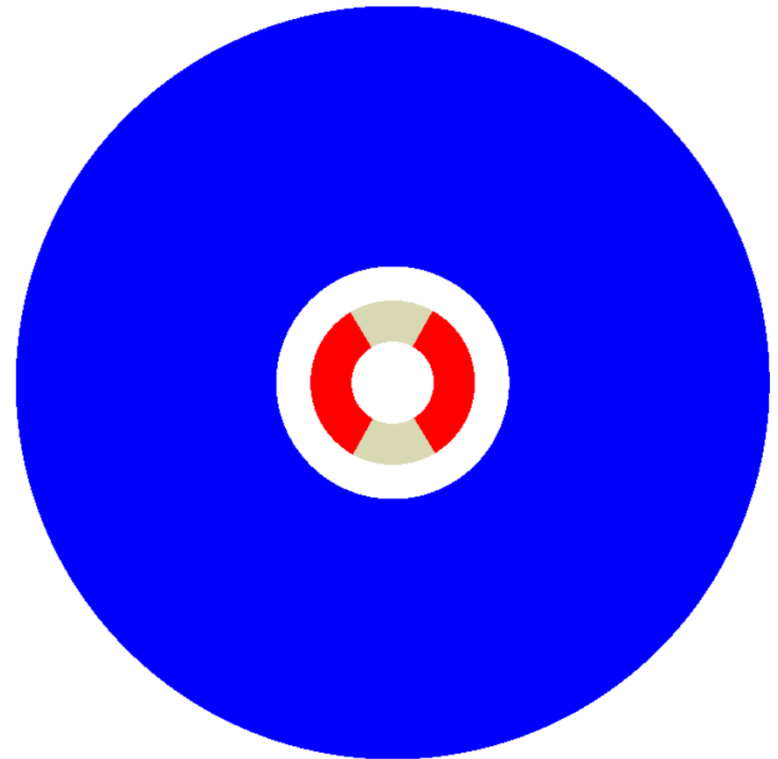

Support structure Shell (or shrinking cylinder)

- The cold mass is contained within a shell (or shrinking cylinder).
- The shell constitutes a containment structure for the liquid Helium.
- It is composed by two half shells of stainless steel welded around the yoke with high tension (about 150 MPa for the LHC dipole).
 - With the iron yoke, it contributes to create a rigid boundary to the collared coil.
- If necessary, during the welding process, the welding press can impose the desired curvature on the cold mass.
 - In the LHC dipole the nominal sagitta is of 9.14 mm.

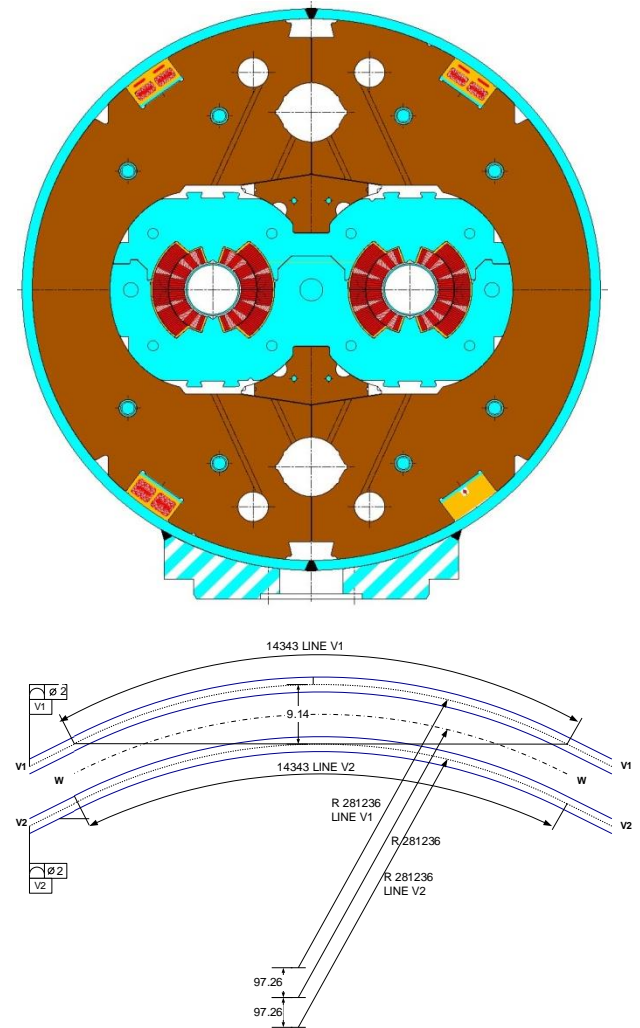

Support structure Shell (or shrinking cylinder)

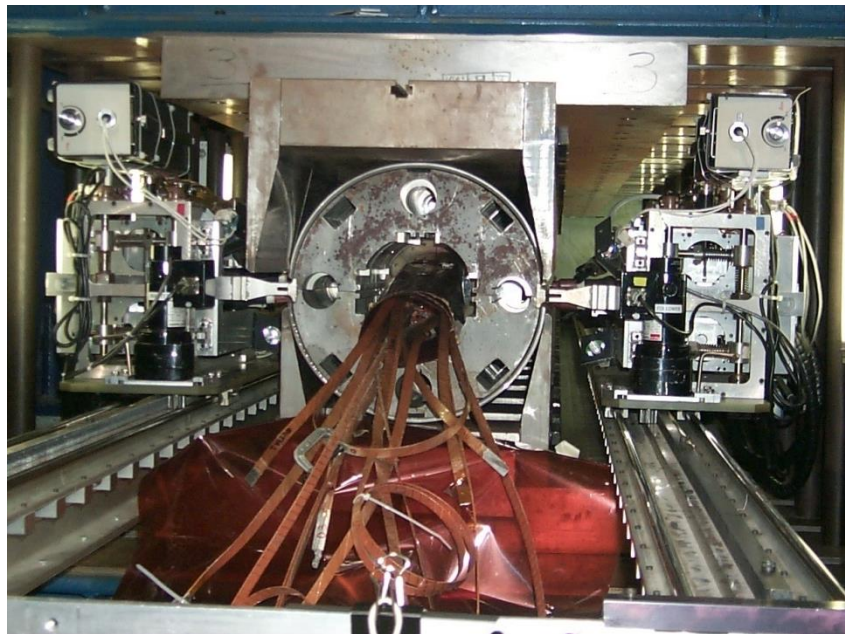
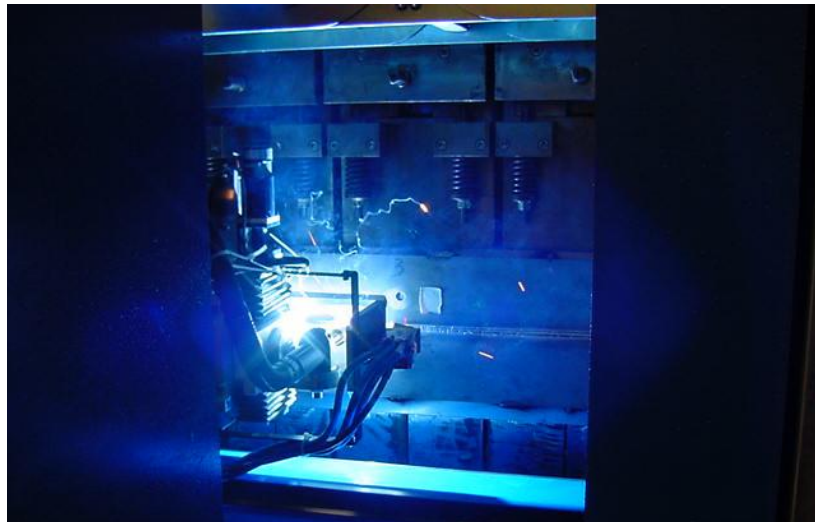
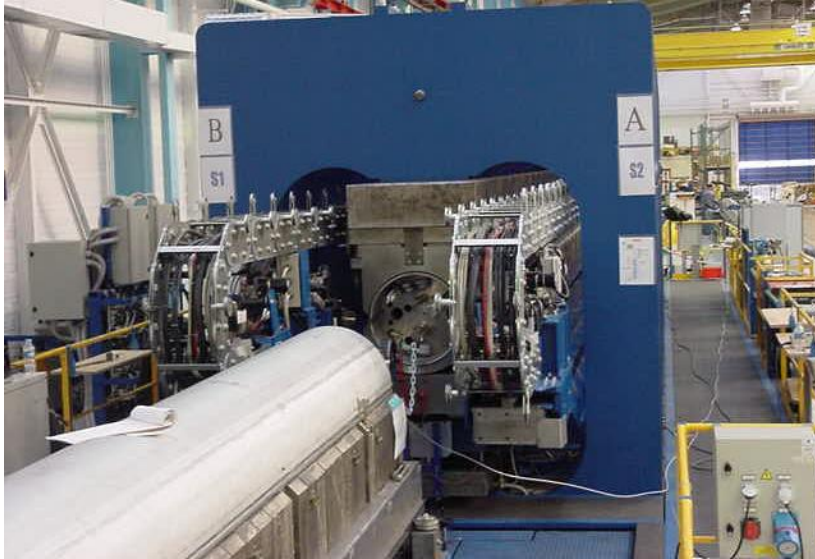

Support structure Shell (or shrinking cylinder)

- The shell tension provided by the welding may contribute to the overall support of the collared coil.
- An often (SSC, LHC) implemented approach is the line-to-line fit.
 - When the yoke is put around the collared coil, a gap (vertical or horizontal) remains between the two halves; this gap is due to the collar deformation induced by coil pre-stress.
 - After welding, the shell tension closes the gap, and good contact is provided between yoke and collar.
 - After cool-down, despite the higher thermal contraction of the collared coil with respect to iron, the gap remain closed (high rigidity), and the collared coil in good contact with the yoke.
- Aluminum spacer may be used to control the yoke gap.

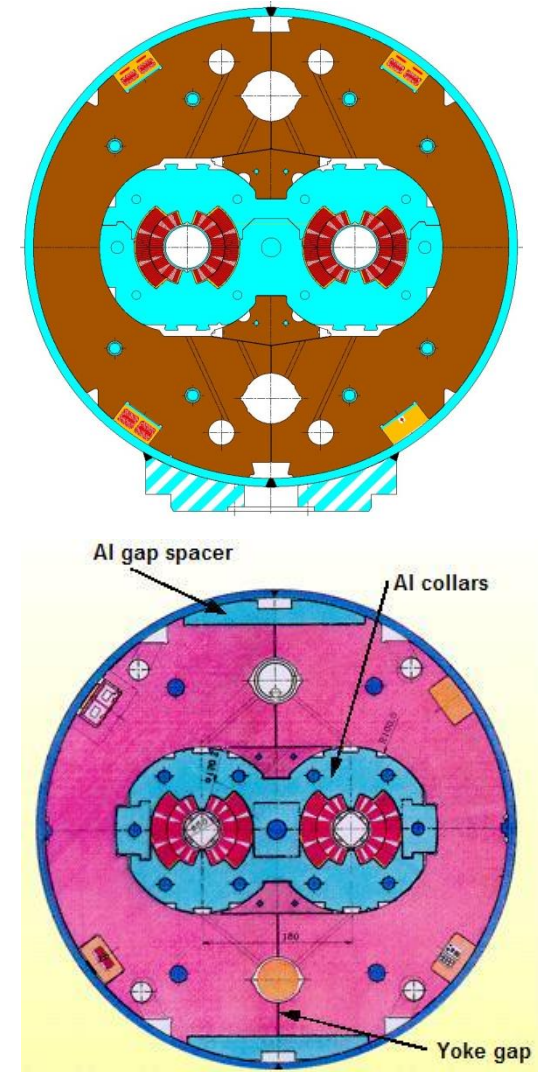

- We assume that the shell will close the yoke halves with the same force as the total horizontal e.m. force at 90% of I_{ss}
- We assume an azimuthal shell stress after cool-down of
 - $\sigma_{shell} = 200 \text{ MPa}$

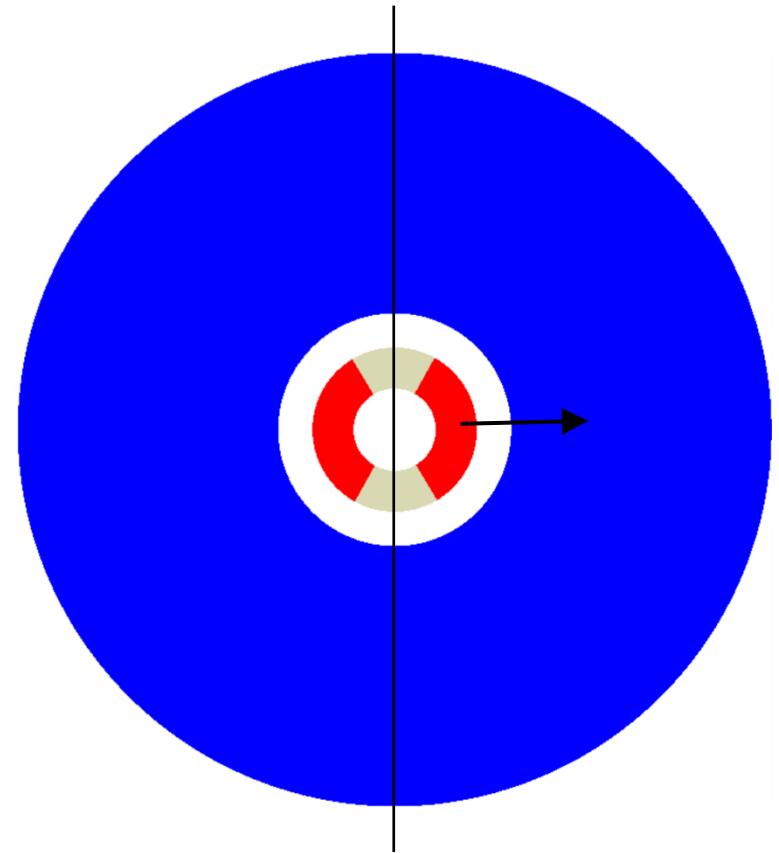

- We assume that the shell will close the yoke halves with the same force as the total horizontal e.m. force at 90% of I_{ss}
 - $F_{x_total} = F_{x_quadrant} * 2 = +6.8 \text{ MN/m}$
- Assuming an azimuthal shell stress after cool-down of
 - $\sigma_{shell} = 200 \text{ MPa}$
- The thickness of the shell is
 - $t_{shell} = F_{x_total}/2/1000/\sigma_{shell} \sim 17 \text{ mm}$

