

MICE

Muon Ionization cooling Experiment

Javier Bilbao



UNIVERSITÉ
DE GENÈVE

Why MICE

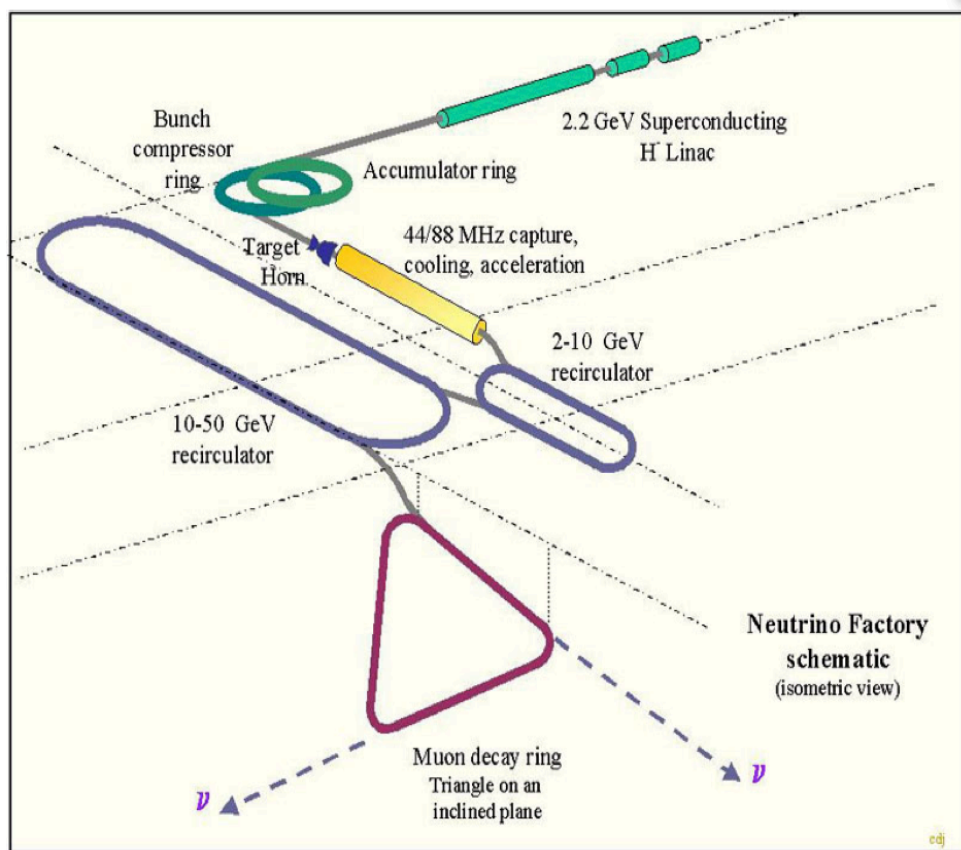

Neutrino factories

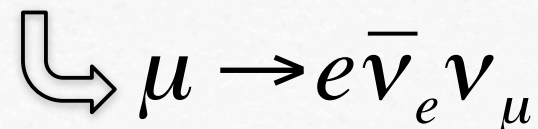

~~Classical cooling techniques~~

First step to $\mu\mu^+$ colider



UNIVERSITÉ
DE GENÈVE

Javier Bilbao

Cooling Principle

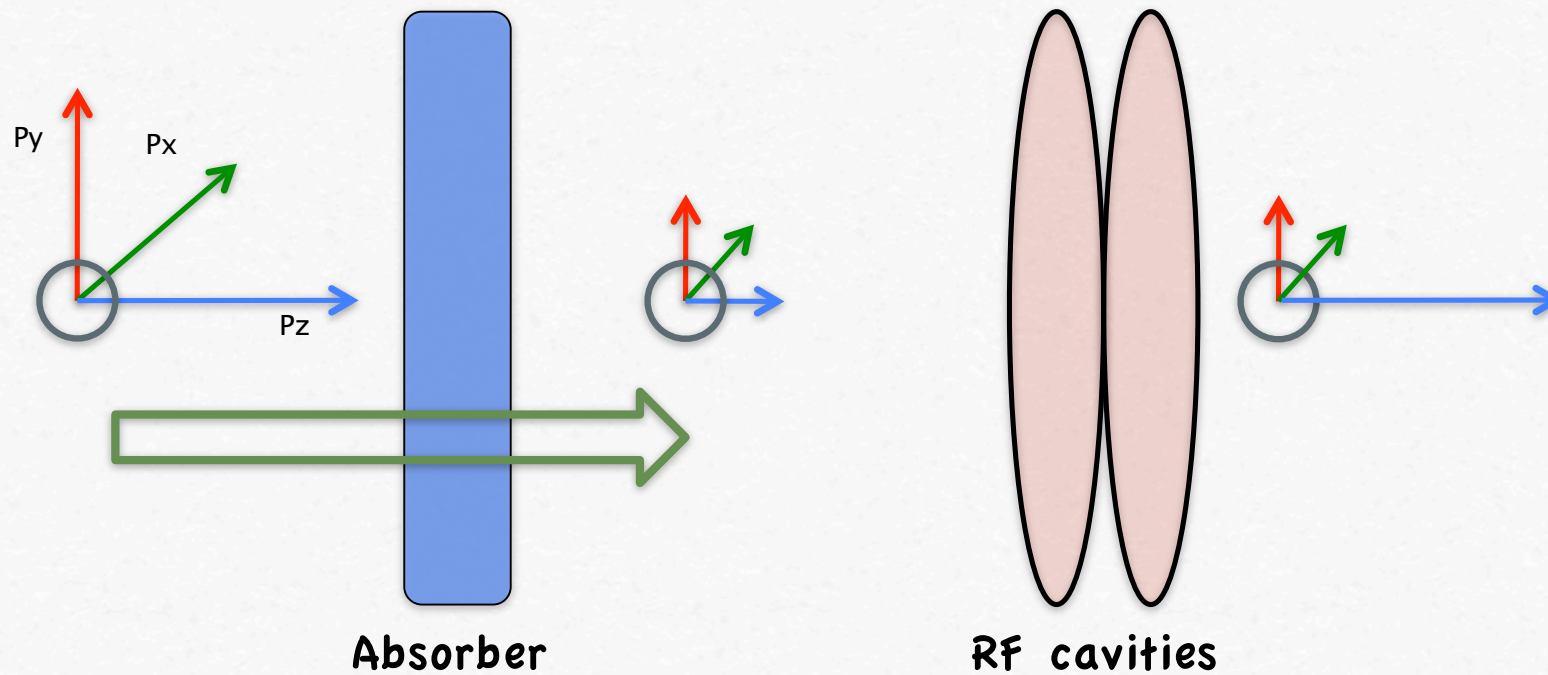

Reduction of transverse momentum



UNIVERSITÉ
DE GENÈVE

MICE Setup

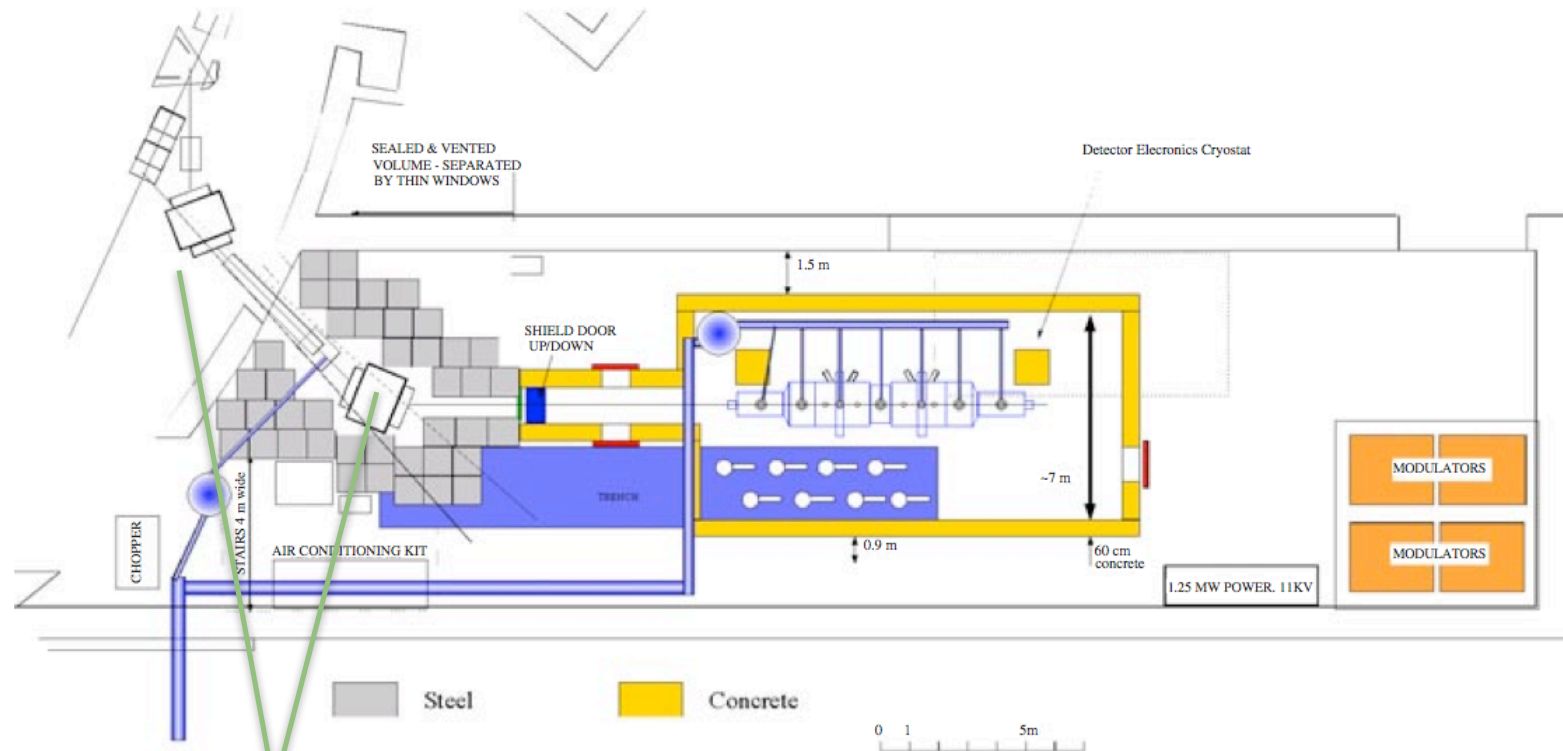

Momentum analyzer

MICE Setup

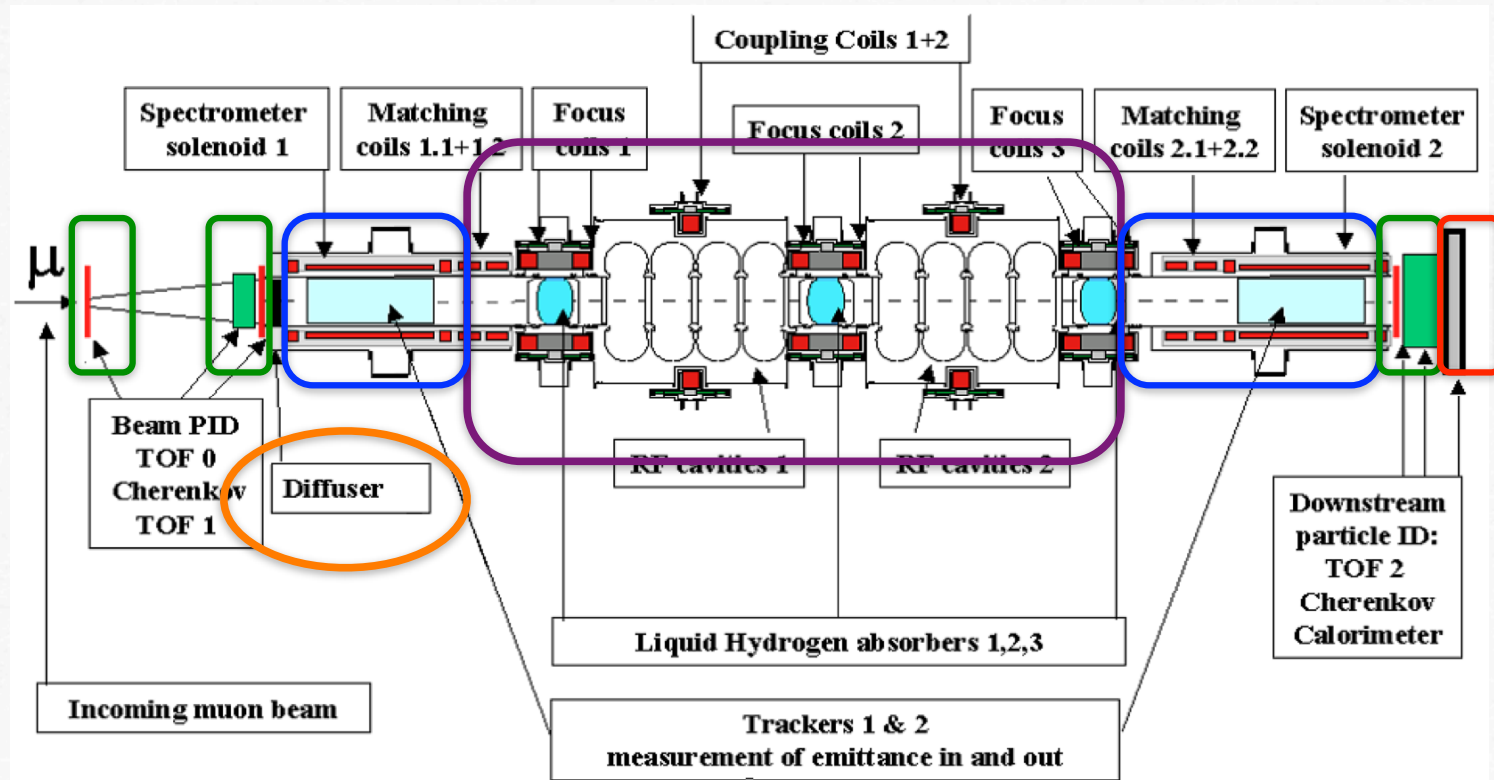

Limits

$$\frac{d\epsilon_n}{ds} = -\frac{1}{\beta^2} \left\langle \frac{dE_\mu}{ds} \right\rangle \frac{\epsilon_n}{E_\mu} + \frac{1}{\beta^3} \frac{\beta_\perp (0.014)^2}{2E_\mu m_\mu X_0},$$

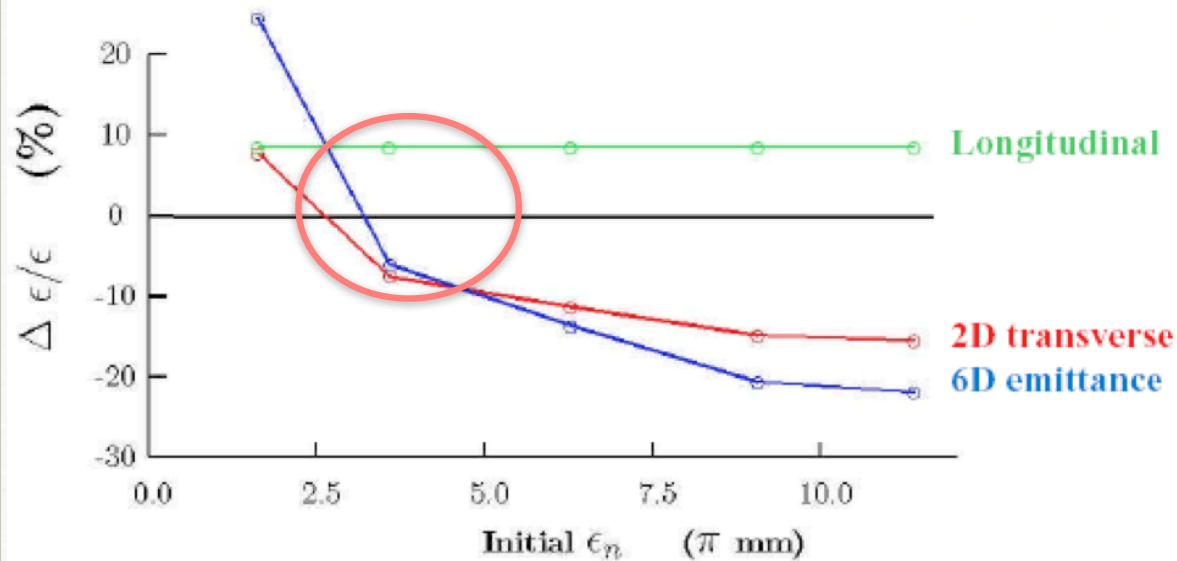

Calorimeter

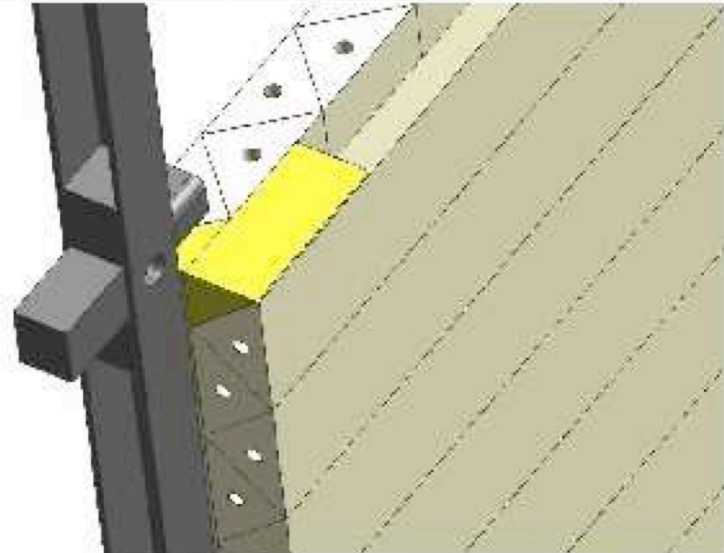
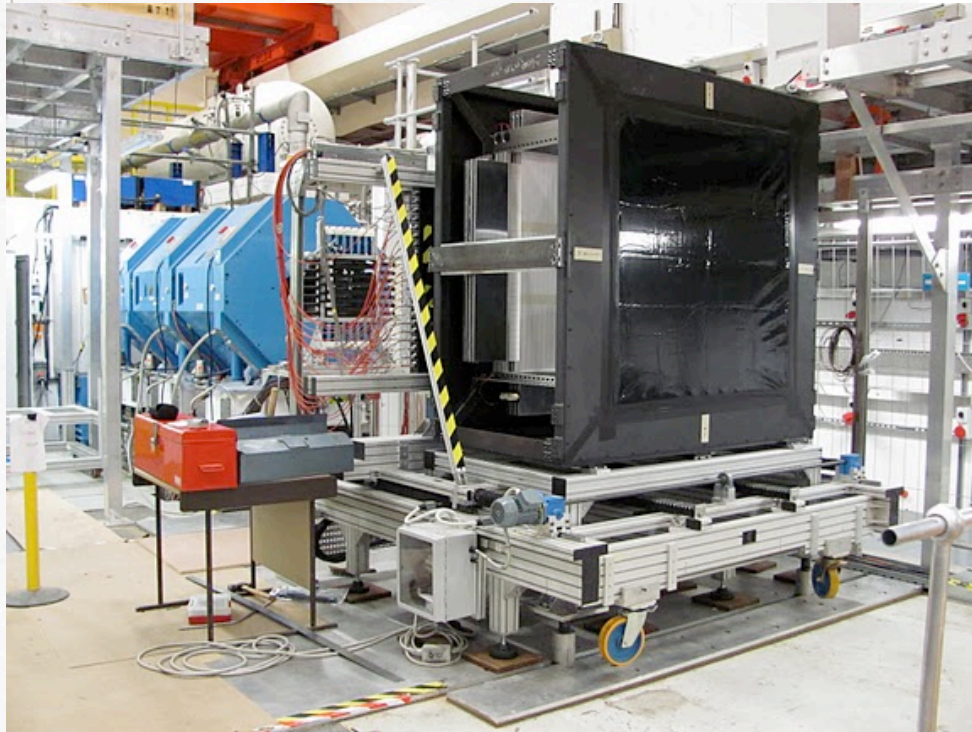
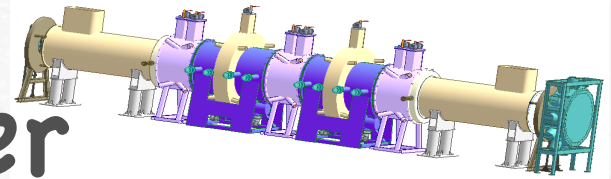

UNIVERSITÉ
DE GENÈVE

Javier Bilbao

Thank you



UNIVERSITÉ
DE GENÈVE

Absorbers

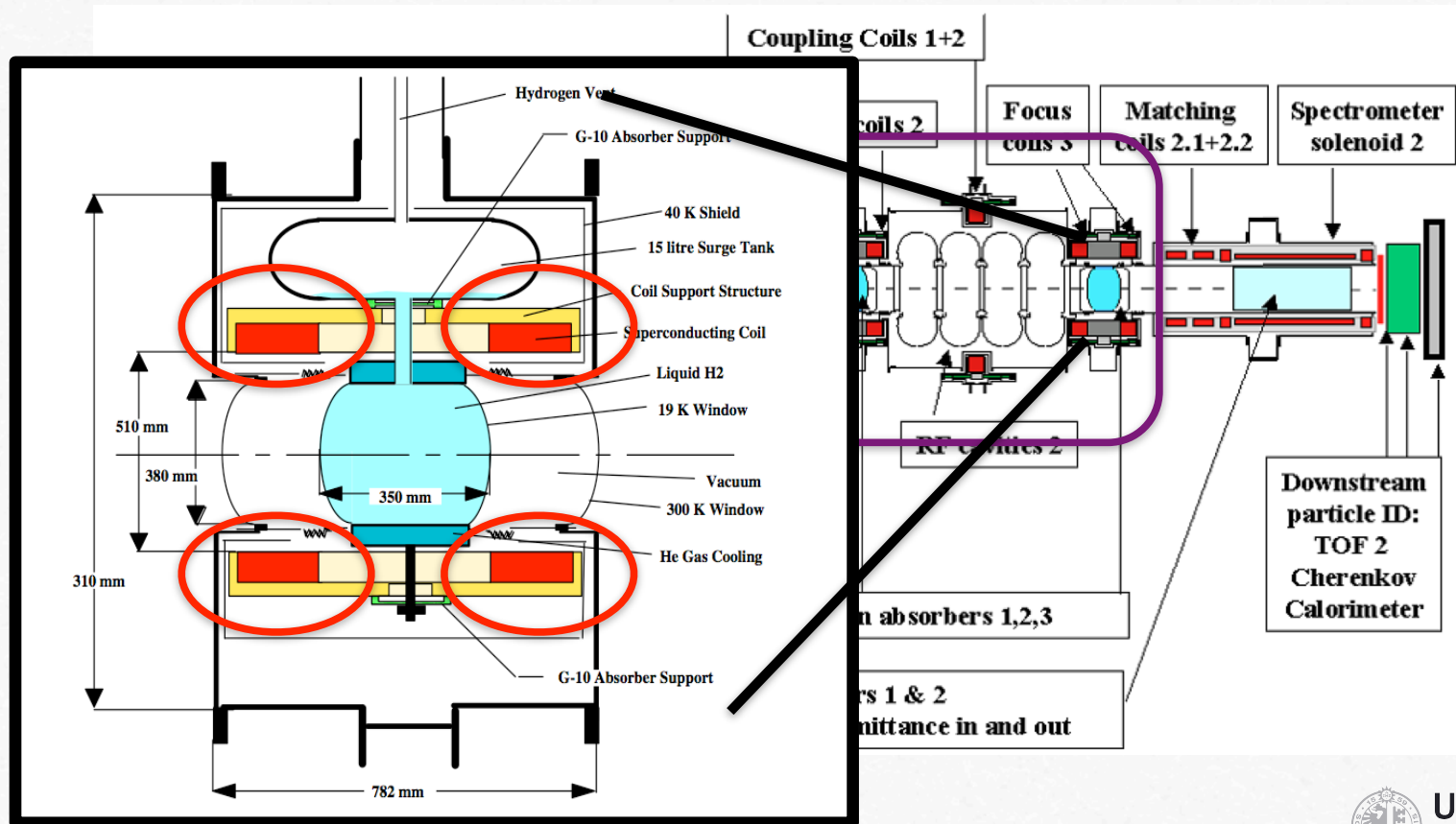

Absorbers

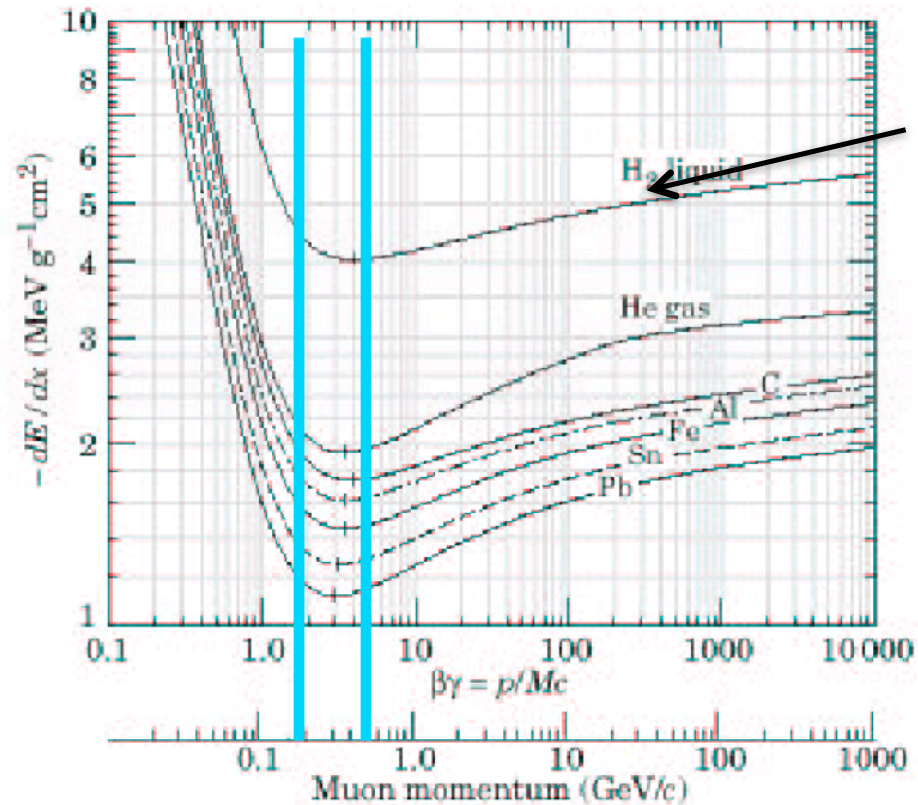

Liquid Hydrogen
absorbers



UNIVERSITÉ
DE GENÈVE

RF cavities

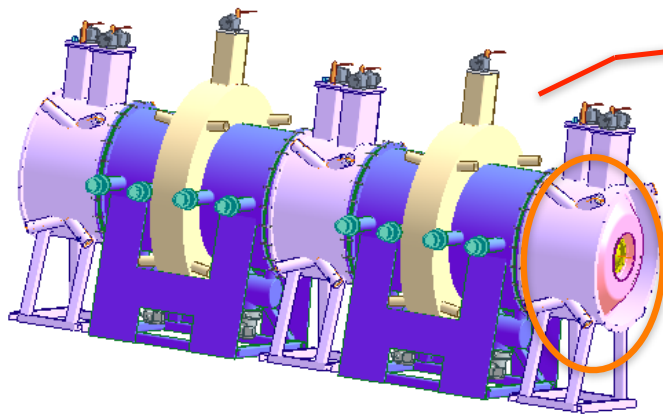

large background generated

200 MeV + 10% cooling

$$\downarrow \frac{\Delta E}{E} = \frac{\Delta \varepsilon}{\varepsilon}$$

20 MeV

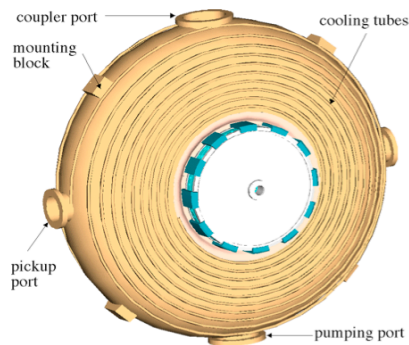

Figure 5.5: Cavity model showing external cooling tubes.

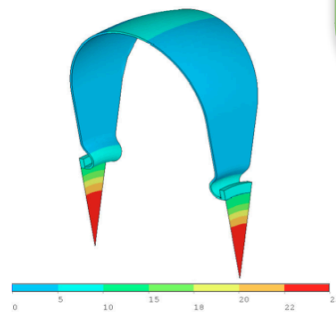

Figure 5.6: ANSYS temperature calculation with 10 kW average power.



UNIVERSITÉ
DE GENÈVE

Javier Bilbao

Spectrometers

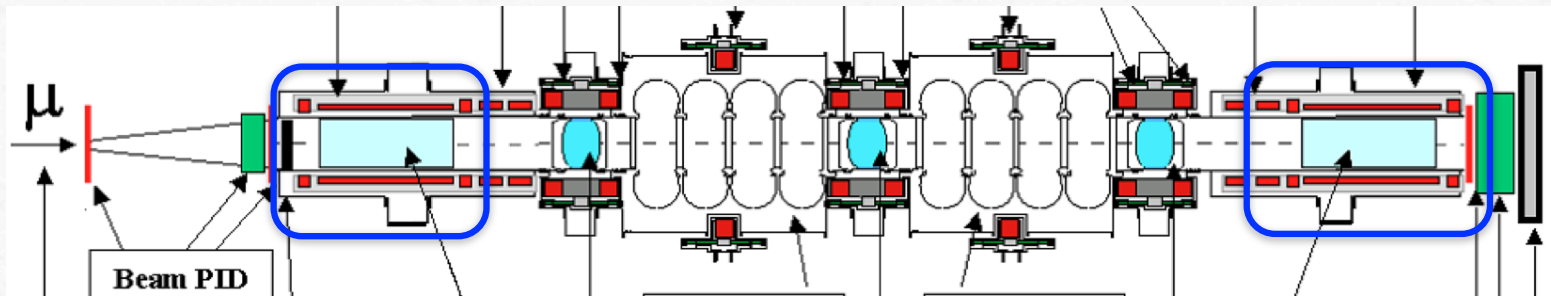
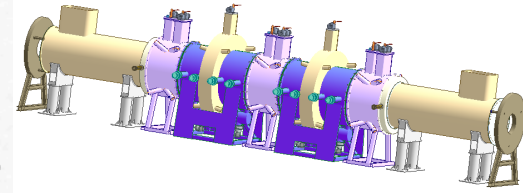

Spectrometer $\begin{cases} x, y, z \\ p_x, p_y, p_z \end{cases}$

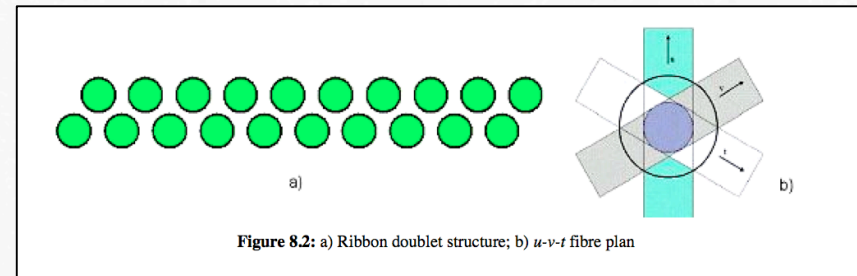

➔ redundant information

TOF

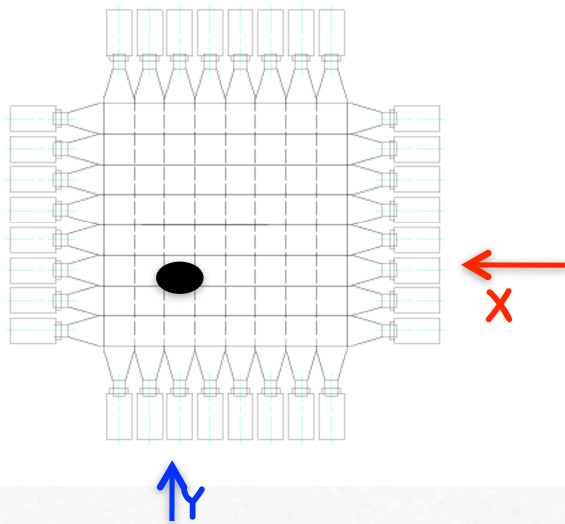
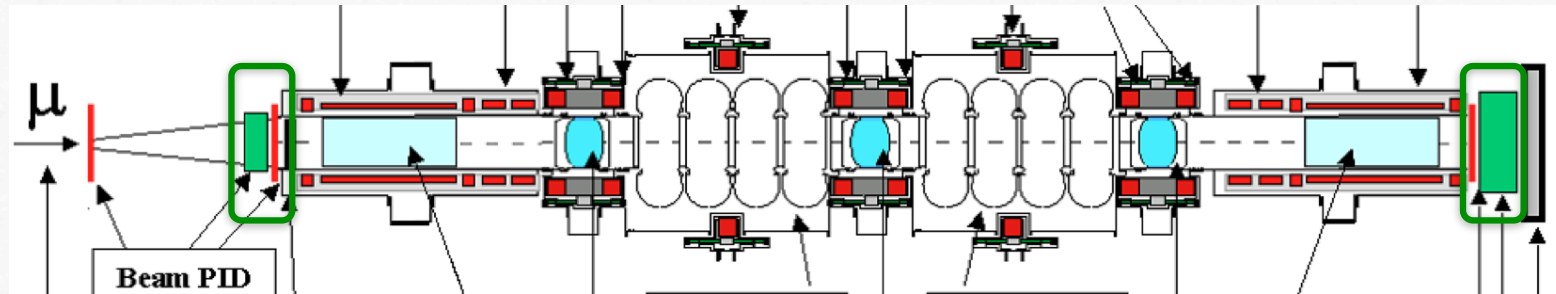
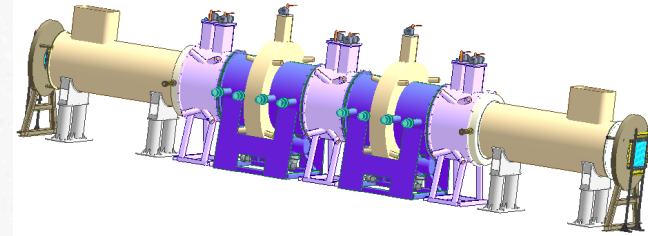

200 MHz RF system, 5° degrees



51 and 62 ps



UNIVERSITÉ
DE GENÈVE

Calorimeter

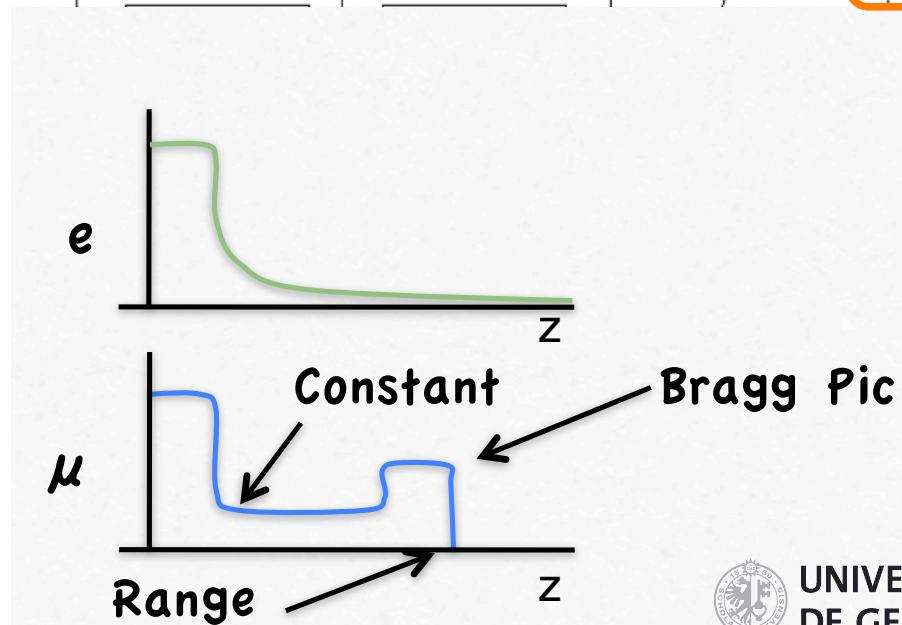
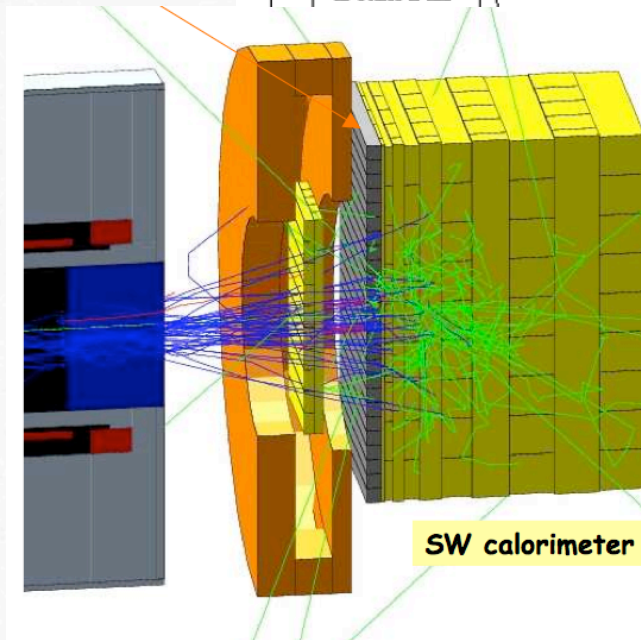
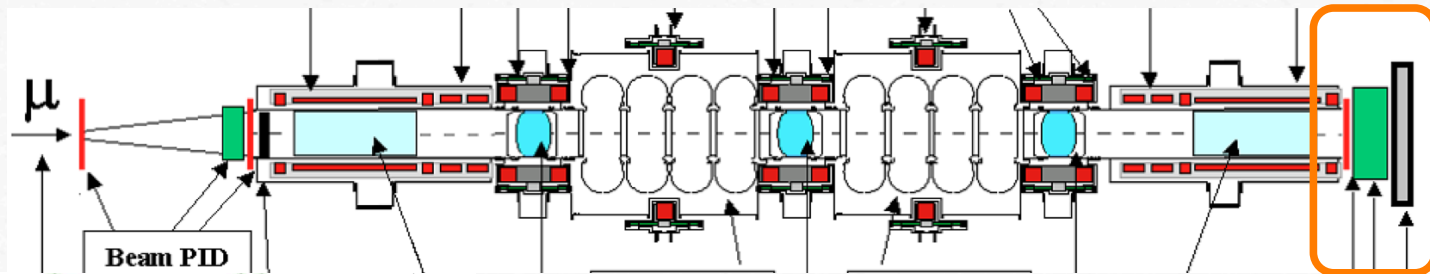
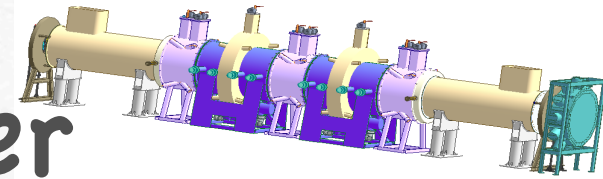

Calorimeter

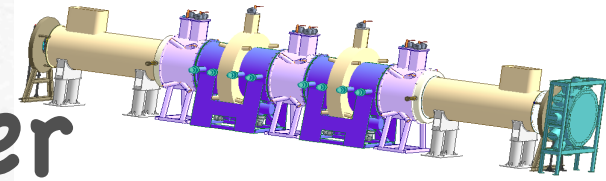

- Good segmentation (Range)
- X and Y mesurment
- Large calorimeter 1m x 1m
- No dead regions

\$/ channel

Low
sensitivity

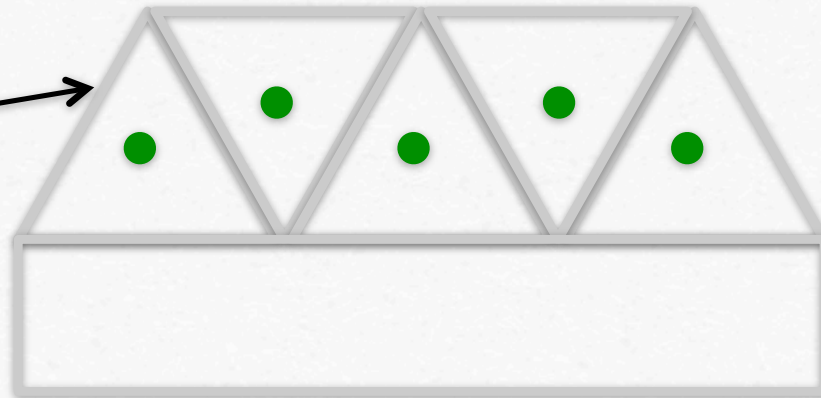

UNIVERSITÉ
DE GENÈVE

Conclusion

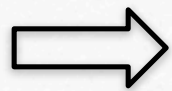

- **First Muon Cooling**
- **Good Emittance measurement**
- **Needed for Neutrino Factory**

And lot more coming soon!!



**UNIVERSITÉ
DE GENÈVE**

Calorimeter

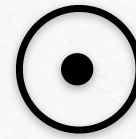
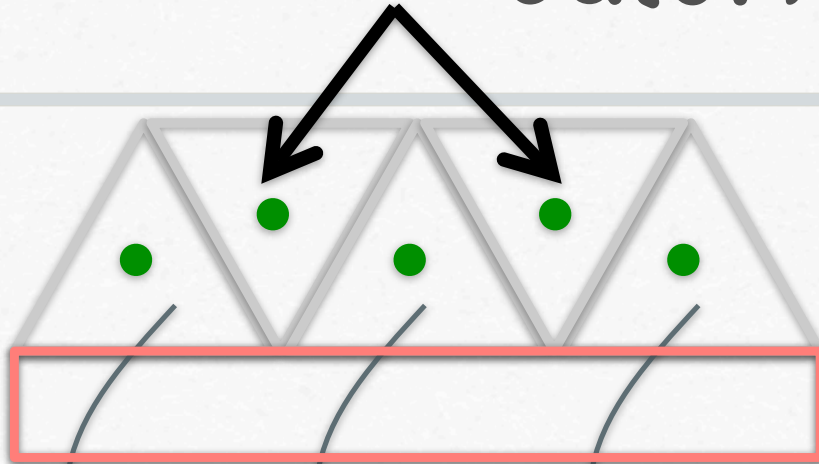
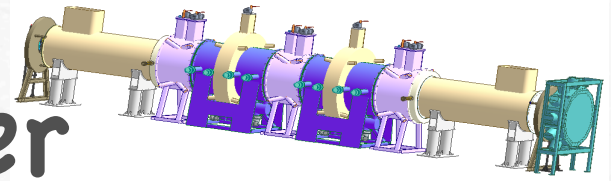

Global plane E

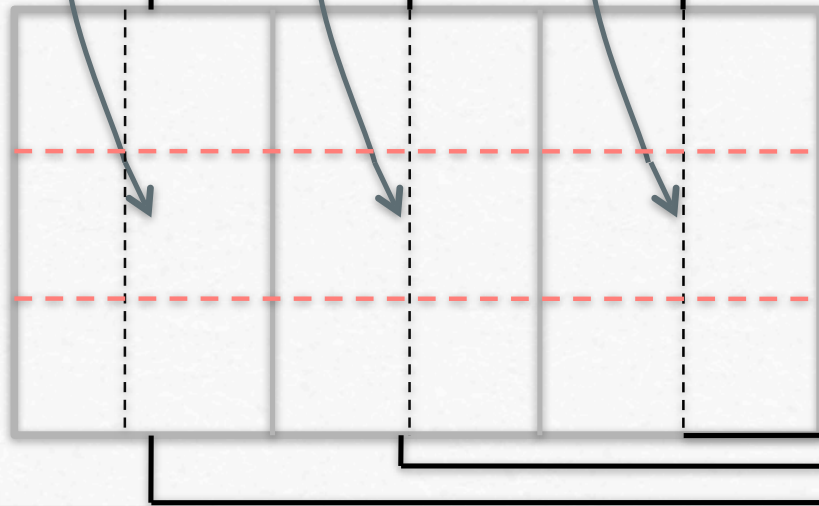

Digital reading



UNIVERSITÉ
DE GENÈVE

Emittance measurement

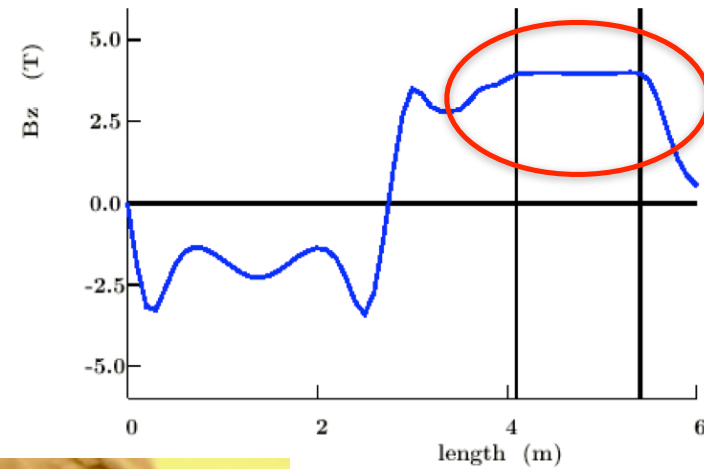
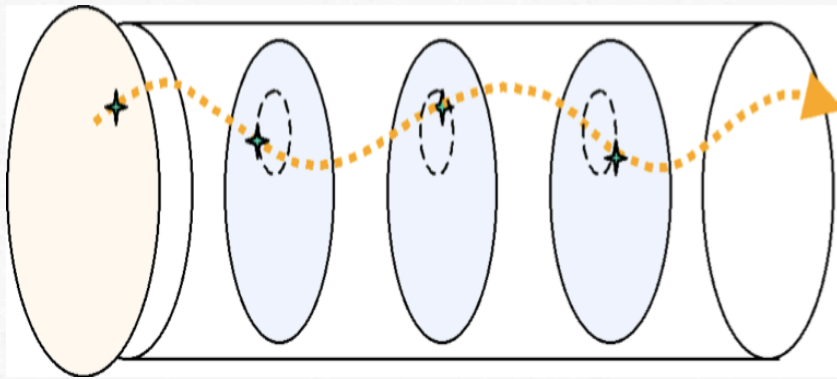

UNIVERSITÉ
DE GENÈVE