



4-axis-controller

iMC-S8

Operating Instruction

About this operating instruction

Used shortcuts

MRL	<i>machine directive 2006/42/EC</i>
ERL	<i>EMC directive 2014/30/EC</i>
NRL	<i>low voltage directive 2014/35/EC</i>

Used symbols

You will find different symbols in this manual that signalizes important information/facts and danger.

**Warning!**

This symbol indicates dangers that cause damages for person's health, physical injury or death.

**Warning! Dangerous voltage!**

Warning of danger from electricity. Ignoring can lead to serious injury or death.

**Attention!**

This Symbol indicates important notes. Ignoring this symbol leads to damages and malfunctions of the machinery

**Information:**

This symbol indicates important information and notes.

Observe the safety instructions



Before you take the 4-axis-controller iMC-S8 in operation, working with the controller or make additions or changes to the wiring of the, make sure to read carefully the safety instructions in this manual. (Chapter 1.2 Safety instructions).

All information, technical data and dimensions contained in this booklet correspond to the technical state at the moment of publication. However, possible misprints or mistakes cannot be ruled out. We will appreciate all suggestions for improvement and error notes.

We would like to point out that all used software and hardware names of the respective companies generally are subject to protection by brand, trademark and patent law.

All rights reserved. It is prohibited to process, duplicate or reproduce this booklet partially or on the whole in any form (print, copy, or other procedure) without written permission of **isel Germany AG**.

This booklet has been translated from the original German version into English language. It does not lay claim to completeness nor flawlessness. In case of doubt the German original has validity.



isel controllers are concurrent with CE norms and marked accordingly. Commissioning of all other parts or components, for which CE safety regulations apply, is prohibited until all respective requests are met.



isel Germany AG as the manufacturer cannot take over guarantee if you change the controller in any way.



The EMC test is valid only for the controller's original configuration ex works, i.e. the delivery state.

Manufacturer: **isel Germany AG**
 Bürgermeister-Ebert-Straße 40
 D-36124 Eichenzell

Tel.: (06659) 981-0
 Fax: (06659) 981-776
 Email: automation@isel.com
<http://www.isel.com>

Item-No.: 970395 BE001
(Translation of operation instruction in German language)

Revisions	Date of change	Reason for change	Changed by
f	23/05/2021	Layout change, Resolution MD28	KJ
e	02/08/2021	Leadshine Power changes MD24/ MD28	KJ
d	18/07/2019	Declaration of Conformity, Stop button, RoHS, Layout	CB, KJ
c	13/09/2016	Declaration of Conformity	RL
b	08/06/2015	Current setting MD24	RL
a	06/01/2015	Serial number	RL
	07/2014	First print	

Technical changes reserved.



Latest operating instructions and manuals for download, visit:
www.isel.com

Table of contents

1	Introduction	5
1.1	Intended use	5
1.2	Safety instructions.....	6
2	Scope of delivery	8
3	Technical data	9
4	iMC-S8 hardware description	11
4.1	front side	11
4.2	Back side	13
4.2.1	Using inverter-case FCC-750.....	20
4.3	Assembly iMC-S8	21
4.3.1	DIP-switch settings	22
5	Operation modes and operation	25
5.1	Controller preparation	25
5.2	CNC-mode	26
5.3	Initial Operation and user programming in CNC-mode	27
5.3.1	Install programming software PALPC.exe	27
5.3.2	PALPC- operation.....	28
5.4	DNC- mode	31
5.5	Initial operation und user programming in DNC-mode	32
6	EC - Declaration of Conformity	35
7	Bibliography	36
8	Index	37

1 Introduction

The stepper-motor-controller iMC-S8 is a freely programmable compact control up to four linear or rotational units with 2-phase stepper motors. The controller integrates maximum four motor power amplifiers with step/direction interface, a processor core with flash memory to interpret the user programs and generating step/direction signals for the power amplifiers, power supply units, security circuit module and a table housing with net input filter and control elements.

1.1 Intended use

The processors operating system (firmware) provides following operation modes:

- **DNC-mode:**
The controller is permanent connected with a PC/laptop via serial interface.
- **CNC-mode:**
The controller works „Stand Alone“ after a user program is downloaded to the processors flash memory.

The controller is able to drive stepper-motors in micro stepping mode. The power amplifiers generates up to 128 micro-steps per full-step. This allows a smoothly run of the connected motors. An automatic current reduction reduces the power loss in the amplifier and motor.

The peak current amounts 7,8A and is adjustable via DIP-switches.

With the impulse input it's possible to control the most important functions (start, stop). Thereby it's also possible to connect an external control console or a higher ranked control (e.g. PLC).

All axis of the controller have to be used only with the compatible motor type.

Please read this operation instruction manual carefully before first use of the controller therewith you can:

- Work safely, fast and effective
- Keep away danger from persons
- Use all the power and features of the controller.

1.2 Safety instructions



- The stepper-motor-controller iMC-S8 is designed in conformability to current technical and recognized rules.
- The device may only be used if it is in correct condition. Any faults have to be eliminated immediately. Neither children nor non-authorized persons are allowed to put the device into operation.
- The device may only be used for the intended purpose: control of 2 up to 4 linear or rotational axes with 2-phase stepper motors.
- All work with the controller iMC-S8, especially initial operation, installation as well as external wiring must be executed by authorized personal regarding electrical industry rules and accident prevention regulations.
- Assembly and use of operating material has to be according to EMC directive 2014/30/EC and Low voltage directive 2014/35/EC. In case of in proper use even the observation of the respective rules and standards does not protect against physical damages and damage to property.
- Do not expose the device to high humidity or high vibrations.
- Please take care of the instruction manual. Be sure that all users know the instructions.
- Ignoring the instruction manual can lead to damage, heavy physical damage or to death.



High leakage current!



- **Warning! High earth leakage current (ground discharge current, protection conductor current).** Before connecting to the AC supply network, it is necessarily required an **additional protective grounding**. Before connecting the CNC controller to the AC supply network, an **additional protective grounding** (cross section: 2.5 mm² or 4 mm², see below) has to be connected! Before the electrical start-up of the controllers a protective grounding of 2.5 mm² (protected installation) or a protective conductor of 4 mm² (unprotected installation) has to be connected durably to the marked clamping point  at the back of the housing where the cross section of the protective grounding shall not be less than 10 mm² copper or 16 mm² aluminum has (e.g. electrical distribution of the building). Please instruct an electrician with these implementation. When using the Residual Current circuit Device (RCD) for line fuses/fault current delimitation: Do not use an RCD with AC characteristics. Using a frequency inverter and choppered power stages in the power units may cause superimposed AC fault units with pulsating direct current and direct current apart from AC fault currents. Please consult your electrician.
- **The term leakage is understood here as grounding discharge current. This is defined in the standard EN 60204-1:2006 section 8.2.8, note 1**
- **If the CNC machine (ideal) is set up isolated from the reference potential, the grounding discharge current is equal to the protective grounding stream.**



2 Scope of delivery

The stepper motor controller iMC-S8 is available in the following variants:

iMC-S8 (Part.-No. 383320 200x) as desk controller

- stepper motor controller iMC-S8 with Core module as desk device with max. four stepper motor power amplifiers MD28
- main cable (protection contact plug, IEC-60320 power connector)
- RS232-communication cable, 9-pin Sub-D (socket) to 9-pin Sub-D (plug)
- Operating instruction
- Programming software PALPC 2.1 (software version 2.1.5.1 or higher)

iMC-S8 (Part.-No. 383320 100x) as 19 inch plug-in controller

- stepper motor controller iMC-S8 with Core module as 19 inch device with max. four stepper motor power amplifiers MD28
- main cable (protection contact plug, IEC-60320 power connector)
- RS232-communication cable, 9-pin Sub-D (socket) to 9-pin Sub-D (plug)
- Operating instruction
- Programming software PALPC 2.1 (software version 2.1.5.1 or higher)

3 Technical data



Electrical data:	
<i>power supply voltage:</i>	100-230VAC 50...60 Hz
<i>power consumption:</i>	ca. 120 W (3 axis)
<i>fuses:</i>	2 x 6,3 A/250V (inert)
Stepper motor control:	
<i>peak current per amplifier:</i>	2,8 A - 7,8 A
<i>rated current per amplifier:</i>	2,0 A - 5,6 A
<i>voltage of the amplifiers:</i>	48 VDC
<i>automatic current reduction:</i>	to 50%
<i>digital inputs:</i>	8 x inputs
<i>digital outputs:</i>	8 x transistor outputs 24VDC/300 mA 1 x relay output 230V/6A
<i>analog outputs:</i>	1 x analog output 0...10V for speed control setting to a frequency inverter

General data:	
<i>dimensions (W x H x D):</i>	475 x 187,5 x 324 mm
<i>weight:</i>	15 kg
<i>maximum number of axis :</i>	4
<i>motors:</i>	2-phase stepper motors (1,8°)
<i>safety class:</i>	IP20
<i>ambient temperature:</i>	0°C - +40°C
<i>storage temperature:</i>	-20°C - +65°C
<i>humidity:</i>	maximum 90% not condensing
Embedded controller data:	
<i>controller core:</i>	32Bit-RISC processor (embedded controller)
<i>program memory:</i>	512 Kbyte flash total, 16000 commands storable
<i>communication via RS232:</i>	RS232 (19200 baud, 8 data bit, 1 stop bit, no parity)
<i>stepper motor amplifier:</i>	stepper motor driver MD28
<i>max. step input frequency:</i>	40 kHz (full step)
<i>cover/door control:</i>	Yes
<i>motor brake on Z-axis:</i>	Yes
<i>safety data:</i>	Emergency stop function according to DIN EN ISO 13849-1:2016-06 corresponds to PL c
Software:	
<i>CNC mode:</i>	PALPC 2.1 (software version 2.1.5.1 or higher)
<i>DNC mode:</i>	Remote (software version 1.46.2.1 or higher), <i>optional: ProNC</i>

4 iMC-S8 hardware description

4.1 front side

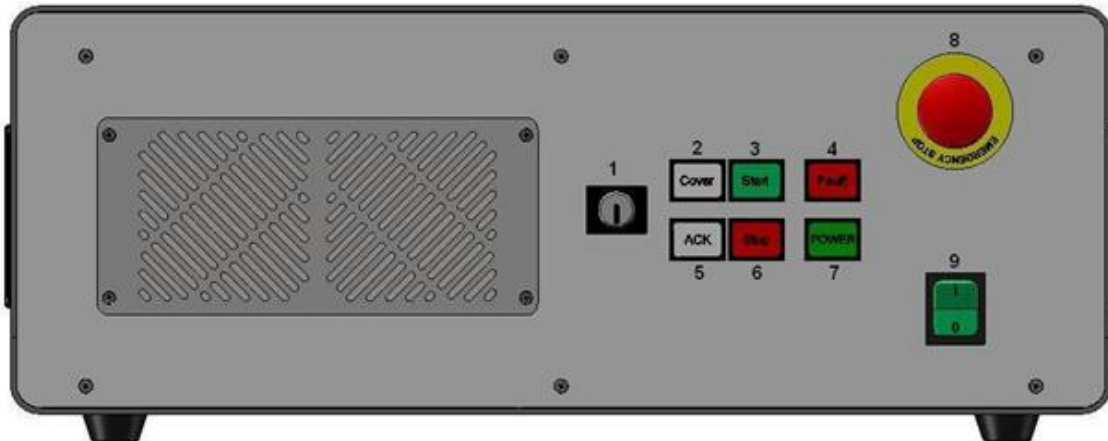

1 - operation mode switch (key switch)

Use this switch to choose between automatic- and setup-



mode.



In **automatic-mode(AUTO)** you can **only open** the **cover or safety door** of the machine if **no axis is in motion** and the mounted **working spindle is switched off** (means that spindle does not turn).

In the **setup-mode (TEST)** you can **only open** the **cover or safety door** of the machine if the mounted **working spindle is switched off** (means that spindle does not turn). You can just **move the axes at opened cover or safety door** if you **press the ACK button**.

When **switching from the operation mode AUTO onto the operation mode TEST** a running **working spindle** will be immediately **switched off**. The enable signal for the hood / machine door (COVER button lighted) takes place with a time delay in order to guarantee that the working spindle can run out.

Ensure that in setup-mode (key switch on TEST) only authorized personal operates on the machine.

2 - cover-button

Use this button to open the machines cover or safety door. This is possible only if the conditions from point “4 – operation mode switch“ are complied. An enable for opening of the cover or safety door is signaled by a white lighted cover button.

3 - start-button

If you press the start button in CNC mode (see chapter 5.2 CNC-mode) a saved user program in the flash memory will be executed.



You cannot use the start switch in DNC mode.

4 - fault-lamp

The fault lamp indicates an error within the safety circuit.

5 - ACK

This button has no function on 4-axis-Controller iMC-S8.

6 - stop-button

If you press the stop button in CNC mode an active user program / axis motion will be stopped. You can continue the execution of the user program by pressing the start button.



You cannot use the stop switch in DNC mode.

7 - power-button

Use this button to switch on motor power supply voltage for the motor power amplifiers.

Conditions for switch on:

- Main power switch on the controller back side is switched on
- Emergency stop button is pulled out



Be sure that the contacts for external emergency stop switch on the remote connector are bridged!

If power supply voltage is successfully switched on the power button is lighted green.

8 - emergency stop switch

Turns off the power supply for the motor power amplifiers and the working spindle in case of any danger. This means dangers for the users health or machine safety. The integrated security circuit is applicable category 2 with PL c according to EN 13849-1.



If you push the emergency stop switch the motor power supply will be switched off immediately and any axes motion will be stopped. The main power supply voltage of 115/230VAC lies still on the device, only the motor power supply voltage for the amplifiers is switched off.

9- Main switch (if mounted)

Switch on net power supply voltage for the controller. The switch is lighted green if device is powered.

4.2 Back side



Stepper-Motor – motor connector X-, Y-, Z-, A-axis, M23 – 12-pin

Connector for motor modules (CNC axis).



Connect / disconnect the Sub-D plug only if the controller is switched off. Ignoring this instruction can lead to damage the motor cable or stepper motor amplifier.

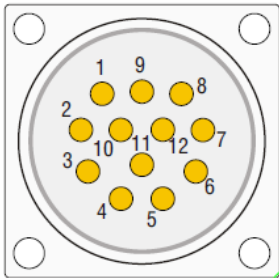

pin	description
1	motor phase 2B
2	motor phase 2A
3	motor phase 1B
4	motor phase 1A
5	+24VDC (switches)
6	motor brake (+24VDC/1,8A)
7	GND (switches)
8	GND (motor brake)
9	limit switch 1 - Öffner (NC)
10	limit switch 2 - Öffner (NC)
11	n.u.
12	n.u.
case	cable shield



On all iMC-S8 controllers with delivery date before 01.01.2012 is the connection of a stepper motor with brake only on the connector of the Z-axis possible. At this jack the switching signal (+24 V to pin 6) for the motor brake is provided.
On all iMC-S8 controllers with delivery date after 01.01.2012 it is possible to connect a stepper motor with brake on every axis.

Remote - security circuit interface, 8-pin socket

Use this connector to include the controller into a higher ranked security circuit system. Please note that the external power input is only useable if the power button from the controller front is switched off.

That will be realized by bridging the pins 1 and 2.

pin	description
1	power button select
2	power button select
3	external power (make contact)
4	external power (make contact)
5	external emergency stop channel 1 (brake contact, 11)
6	external emergency stop channel 1 (brake contact, 12)
7	external emergency stop channel 2 (brake contact, 21)
8	external emergency stop channel 2 (brake contact, 22)



Use external emergency stop:

- pin 5 and 6 bridged
- pin 7 and 8 bridged

The length of the connection cable for the external emergency stop button must not more than 5m.

Use external power button:

- pin 1 and 2 bridged
- connect external power button (make contact) on pin 3 and 4

Impulse - interface impulse control, 8-pin connector

Use this connector to integrate the function keys start button, stop button and reset from the controller front side as external signal inputs.

pin	description
1	input external START button
2	+24VDC
3	input external STOP button
4	output lamp START button
5	GND
6	output lamp STOP button
7	input length measure switch
8	+24VDC

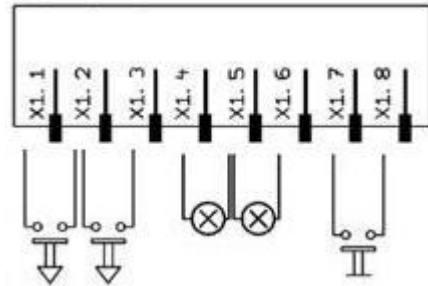

If the external STOP button is not used pins 2 and 3 must be bridged.

Input - digital inputs, 8-pin connector

The controller has 8 digital user inputs. Use these inputs to connect external devices like sensors, switches or outputs from other devices. All inputs are opto-decoupled. If +24VDC lies on the input a logical HIGH is signalized. Not connected (e.g. switch open) a logical LOW is signalized.



Do not short 24VDC reference potential of the controller with GND or case ground.

The binary user inputs 1 – 8 must be wired as shown opposite.

The load of the controller internal 24V power supply unit amounts on 1-active state 4 mA per input.

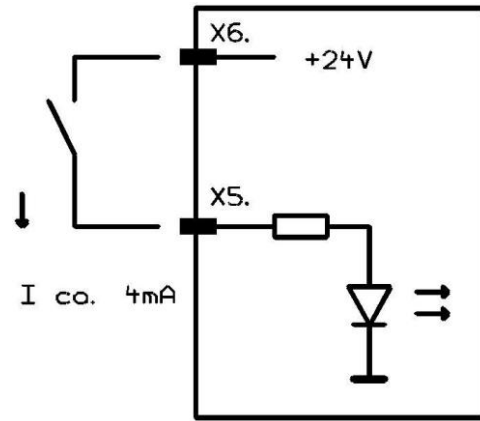

Output - digital outputs, 8-pin connector

The controller has 8 digital user outputs. Use these outputs to connect external devices like relays, or inputs from other devices. The maximum load of each relay output is 24 VDC/300 mA



Do not short 24VDC reference potential of the controller with GND or case ground.



If you have pushed the emergency stop switch all states of the binary user outputs will be maintained and not reset!



When using inductance, a free-wheeling diode is necessarily.

The binary user output 1 – output 8 must be wired as shown opposite.

The transistor outputs (output 1 – 8) can be rated with 300 mA per output.

If all outputs are switched (1-active) the maximum load of the internal 24VDC power supply unit is 1,5 A (ca. 180mA per output).

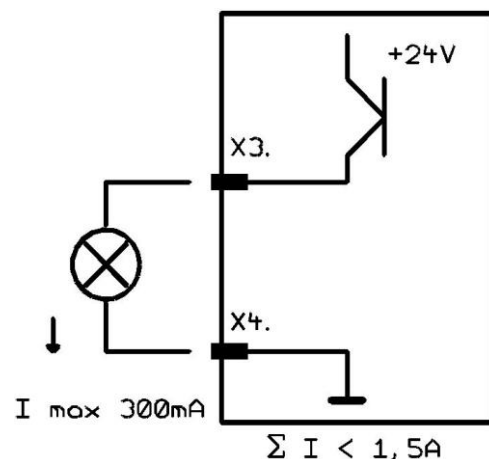

Analog - Out, Sub-D9-pin connector

Use this connector to drive an external frequency inverter with the corresponding working spindle via a 0 – 10 V analog output.

pin	description
1	+24VDC
2	n.u.
3	n.u.
4	make contact 1 (potential free contact)
5	analog 0 ...10V
6	GND
7	n.u.
8	make contact 1 (potential free contact)
9	GND

Cover - Sub-D9-pin connector

This connector is used to integrate a solenoid interlock to the security circuit of the controller.

On isel machines the solenoid interlock is realized by a switch of type:



SCHMERSAL EX-AZM 170-02ZK-24V (part-no. 577047 0800)

Only this type interlocks or interlocks with the same functionality have to be used.

pin	description
1	+ coil break contact
2	switch 1.1 (bridge to pin 3 if no safety door is used)
3	switch 1.2 (bridge to pin 2 if no safety door is used)
4	switch 2.1 (bridge to pin 5 if no safety door is used)
5	switch 2.2 (bridge to pin 4 if no safety door is used)
6	- coil break contact
7 - 9	n.u.



If no cover or safety door is used the pins 2, 3 and 4, 5 must be bridged. Therefore use the enclosed Sub-D 9-pin plug.



If the contacts of the interlock is interrupted (e.g. forcible opening of the hood or remove the jumper, Sub-D) will immediately trigger an emergency stop and turned off the spindle.

RS232 (PC) – programming interface

Communication between iMC-M / iMC and control PC is realized via a serial interface (RS232). Use the delivered communication (null modem) cable for connection.

A software protocol realizes the faultless transmission of the ASCII characters. Therefore it's necessary that both systems respect the communication protocol:

- The connected control PC sends a command which ends with a line end character [CR, char (13)].
- The processor unit quits the execution or storing of a command with the quitting signal 0[char (48)] or returns an occurred error with an ASCII character unequal 0.

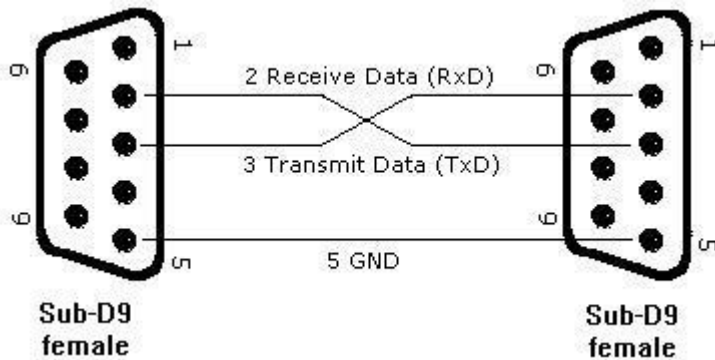

Data transfer parameters:

- 19200 baud
- 8 data bits
- 1 stop bit
- no parity

AC-Input - net input module 100 - 230 VAC, 50 - 60 Hz

The net input module consists of net input socket, net filter, fuse holder and net main switch. Connect the controller via delivered net cable to a free receptacle. After that you can switch on the controller with the net main switch.

Spindle - 100 - 230V output, three-pin-plug

Use this output connector to directly plug a working spindle or a frequency inverter with a speed controlled working spindle (e.g. iSA750). According to the working spindle type you have to change the internal power supply connection on the security circuit module either for the working spindle without speed control or for the frequency inverter with a working spindle with speed control.

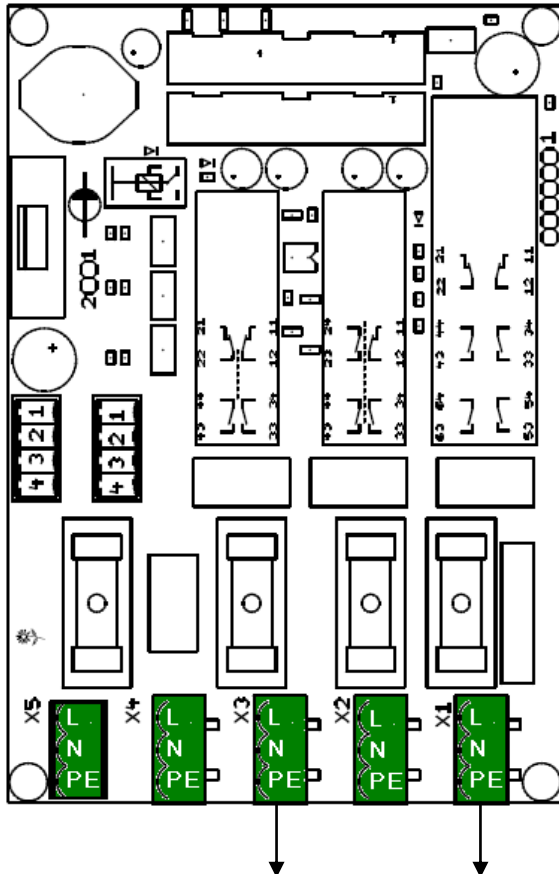

Remove the controller cover by loosen the screws on the right and left side of the controller (only on desk controller type). After that remove the cover plate by loosen the screws all around on the top of the controller case.

Connect the 3-pin wire from connector „Spindle 230V“ inside the controller with the for you necessary connector on the security circuit module.



Ex factory the controller is delivered with the connection to X1 (that means for a working spindle without speed control).

Connector **X3** for frequency inverter with working spindle with speed control,
max. switching capacity
100-230V / 6A

connector **X1** for working spindle without speed control,
max. switching capacity
100-230V / 6A



Please note that in case of an emergency stop the power supply voltage on connector X3 will switched off time delayed (ca. 7 sec)

Power supply voltage on connector X 1 will switched off immediately in emergency stop case.

4.2.1 Using inverter-case FCC-750

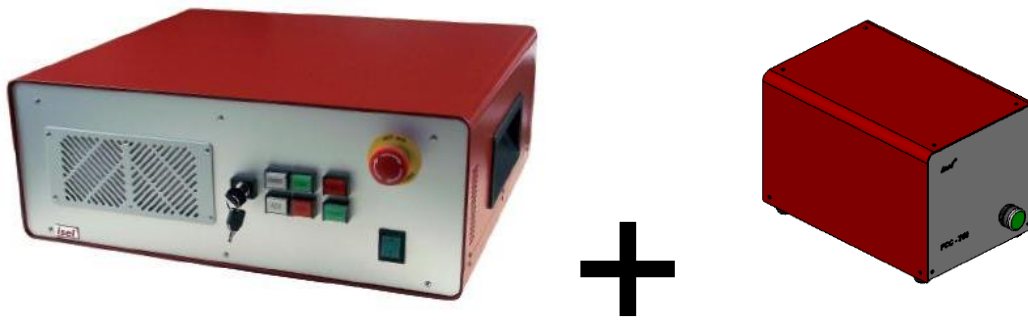

The FCC 750 is used for dilating the iMC-S8 controller to a frequency converter for three-phase induction motors.

The module is used with isel milling spindles Typs iSA500 (Art.-Nr. 477004 3130) and iSA750 (Art.-Nr.477008 3124).

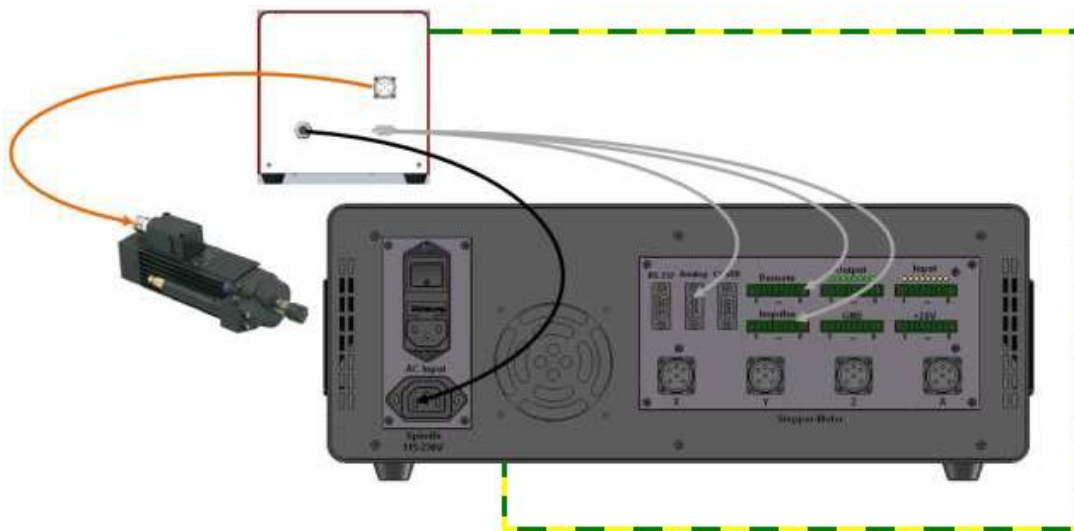

Connecting the FCC 750

- 1.) Turn off and disconnect the iMC-S8 controller from electrical power supply
- 2.) Connect the iMC-S8 controller and the FCC 750 with an additional protective conductor of 2.5 mm² (protected installation) or 4mm² (unprotected installation) on the marked points ⚡
- 3.) Connect the FCC 750 with the related socket´s of the iMC-S8
- 4.) Connect the spindle motor (iSA500/iSA750) to FCC750
- 5.) Start-up the iMC-S8



It is not allowed to use FCC -750 without controller iMC-S8!

4.3 Assembly iMC-S8

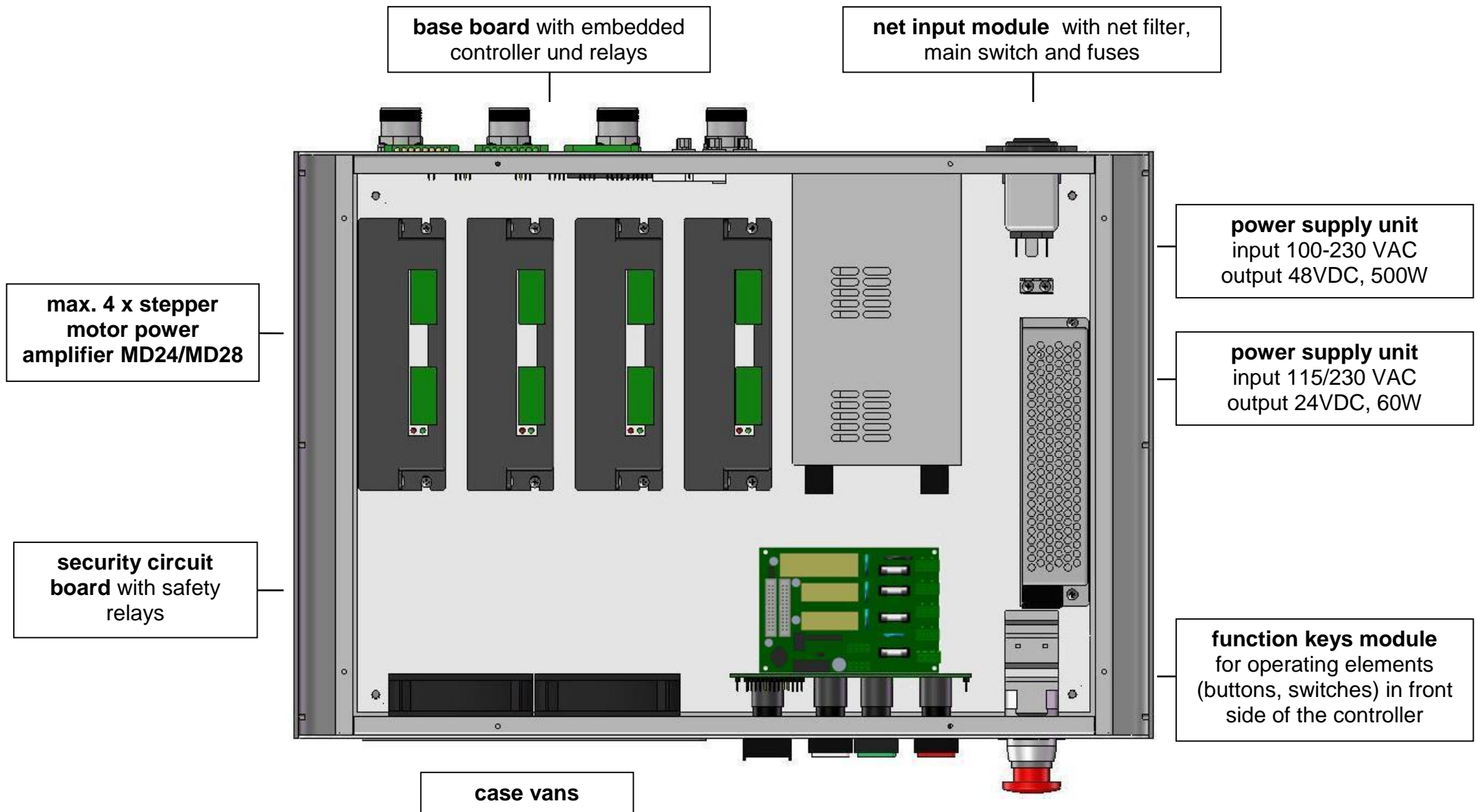

4.3.1 DIP-switch settings

The controller iMC-S8 has four stepper motor power amplifiers MD28. Settings for rated current, step resolution and current reduction takes place by the DIP-switch on the top side of the amplifiers case.



Configuration of the controller should be done before first start-up so that a connected motor will not be damaged because of an incorrect power setting.

To configure the step resolution and motor current open the cover and set the jumper on each amplifier as follows (more information /1/ Microstepping Driver MD24/MD28):

DIP Switch - MD28 in iMC-S8

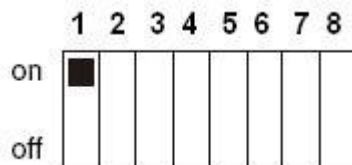

- 1: current setting 1
- 2: current setting 2
- 3: current setting 3
- 4: current reduction
- 5: step resolution 1
- 6: step resolution 2
- 7: step resolution 3
- 8: step resolution 4

Current setting (DIP-switch 1, 2, 3)

Use the DIP switches 1, 2 and 3 to set the current of the motor. The following table shows the motor current (RMS) setting for the different switch positions:

Peak current[A]		Rated current[A]		SW1	SW2	SW3
MD24	MD28	MD24	MD28			
1.00	2.80	0.71	2.00	ON	ON	ON
1.46	3.50	1.04	2.50	OFF	ON	ON
1.91	4.20	1.36	3.00	ON	OFF	ON
2.37	4.90	1.69	3.50	OFF	OFF	ON
2.84	5.70	2.03	4.10	ON	ON	OFF
3.31	6.40	2.36	4.53	OFF	ON	OFF
3.76	7.00	2.69	5.00	ON	OFF	OFF
4.20	7.80	3.00	5.57	OFF	OFF	OFF



The factory set of the motor current is 2.03 A (RMS) at MD24 and 3.00 A (RMS) at MD28 on all motor power amplifiers.

Current reduction (DIP-switch 4)

Use the DIP switch 4 to set the automatic current reduction. If the DIP switch is set to ON the automatic current reduction is deactivated. DIP switch in state OFF means that the current is set to 50% of the motor current if the motor standstill.

DIP 4	Current reduction
ON	0% reduction (deactivated)
OFF	50% reduction



If the holding torque is sufficient, the activated automatic current reduction is recommended.



The factory set of the current reduction is active (DIP 4 = OFF).

Step resolution (DIP-switch 5, 6, 7, 8)

Use the DIP switches 5, 6, 7 and 8 to set the step resolution. Setting the factor to a higher value causes a smooth motion of the motor but the maximum reachable velocity will taking down. Also the motor torque will be reduced to 75% in microstep mode. The following table shows the DIP switch settings for the different step resolutions:

micro steps	steps/ rev. (1,8 ° motor)	SW5	SW6	SW7	SW8
2	400	OFF	ON	ON	ON
4	800	ON	OFF	ON	ON
8	1600	OFF	OFF	ON	ON
16	3200	ON	ON	OFF	ON
32	6400	OFF	ON	OFF	ON
64	12800	ON	OFF	OFF	ON
128	25600	OFF	OFF	OFF	ON
5	1000	ON	ON	ON	OFF
10	2000	OFF	ON	ON	OFF
20	4000	ON	OFF	ON	OFF
25	5000	OFF	OFF	ON	OFF
40	8000	ON	ON	OFF	OFF
50	10000	OFF	ON	OFF	OFF
100	20000	ON	OFF	OFF	OFF
125	25000	OFF	OFF	OFF	OFF

Tabelle 1: Step resolution MD24

micro steps	steps/ rev. (1,8 ° motor)	SW5	SW6	SW7	SW8
2	400	ON	ON	ON	ON
4	800	OFF	ON	ON	ON
8	1600	ON	OFF	ON	ON
16	3200	OFF	OFF	ON	ON
32	6400	ON	ON	OFF	ON
64	12800	OFF	ON	OFF	ON
128	25600	ON	OFF	OFF	ON
256	51200	OFF	OFF	OFF	ON
5	1000	ON	ON	ON	OFF
10	2000	OFF	ON	ON	OFF
20	4000	ON	OFF	ON	OFF
25	5000	OFF	OFF	ON	OFF
40	8000	ON	ON	OFF	OFF
50	10000	OFF	ON	OFF	OFF
100	20000	ON	OFF	OFF	OFF
200	40000	OFF	OFF	OFF	OFF

Tabelle 2: Step resolution MD28



The Factory set of the step resolution is 800 steps/rev. for all motor power amplifiers.

5 Operation modes and operation

The processors operating system (firmware processor core) provides the following operation modes:

- DNC-mode:
 - PC/Laptop is permanent connected to the 4-axis-controller via serial interface
 - Software Remote/ProNC is used to drive the controller
- CNC-mode:
 - 4-axis-controller executes user programs stand alone without a connected PC/Laptop
 - Software PALPC 2.1 is used for programming and download of user programs into the flash memory of the controller

5.1 Controller preparation

Before first startup of the controller please check the scope of delivery. The following parts should be included:

- 4-axis-stepper-motor-controller iMC-S8 as desk or 19" device
- Net power supply cable 115/230VAC
- RS232-communication cable, 9-pin Sub-D (female) to 9-pin Sub-D (female)
- Bridging connectors
- Operating instruction

If all this parts are included you can begin initial operation.

Provide all electrical connections.

Connectors

- Connect net power supply cable
- Connect axis (motors) on the controller back side

Configuration

- Set DIP-switches / jumper for motor current, step resolution, current reduction, motor brake (see chapter 224.3.1)

Initial operation

- Switch on controller with main power switch on the back side
- Check if emergency switch is pulled out
- Push power button on the front of the controller
→ Power button should be lighted green – controller is ready for work

Operation mode

- Use the 4-axis-controller in CNC- or DNC-mode
-

5.2 CNC-mode

The CNC mode (automatic mode = CNC mode) is the program controlled mode of the 4-axis-stepper-motor-controller iMC-S8.

That means that a user program which is saved in the controller's memory (flash) will be executed till the end.

During the automatic mode (CNC mode) you can stop the execution of the active user program by pressing the STOP-key on front side of the controller or by using the external Stop input. A following operation of the START-key on the front side of the controller or the activation (1-active) of the external start input effects the resumption of the automatic mode.

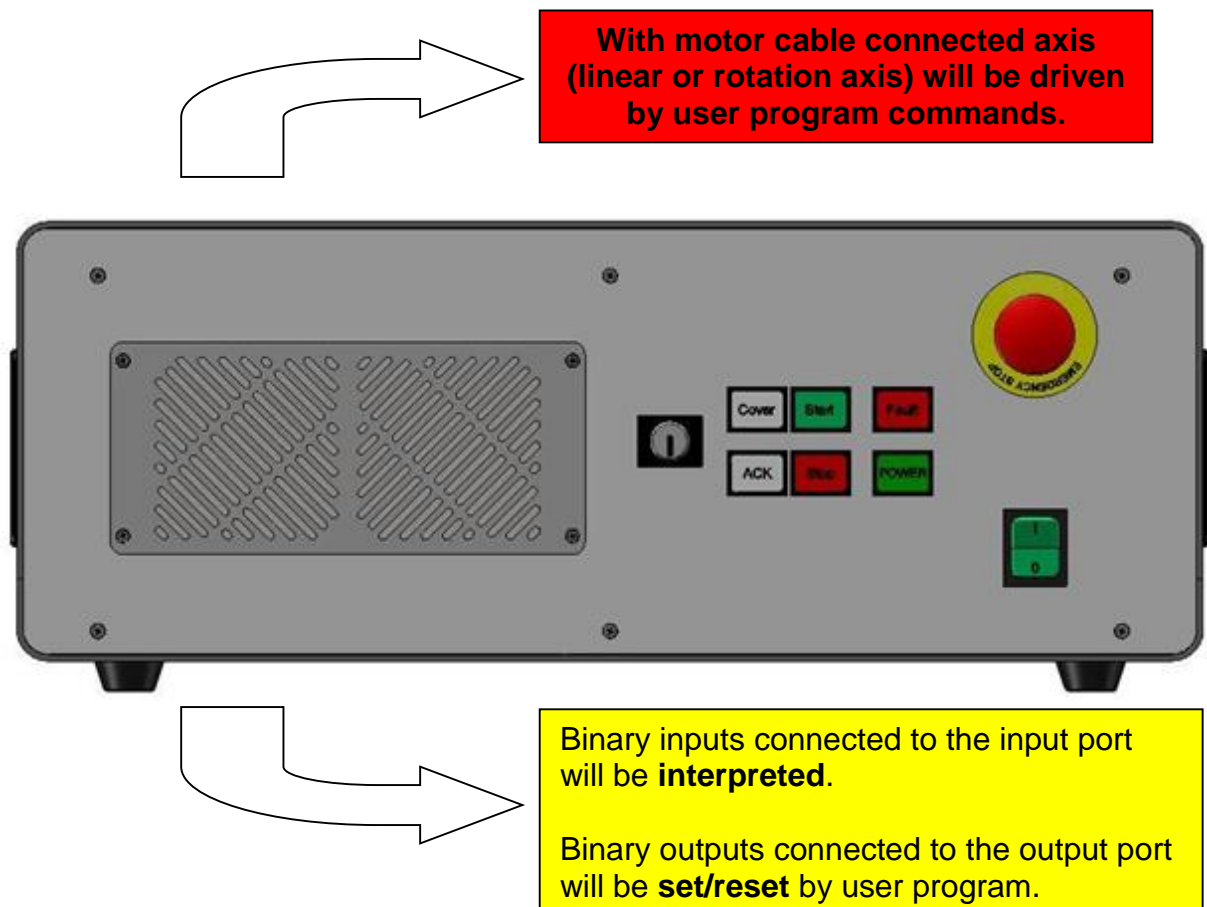

5.3 Initial Operation and user programming in CNC-mode

Creating user programs for 4-axis-controller iMC-S8 is realized with the software PALPC.exe. The implementation method is simple and described in “/2/ PAL-PC programming instruction“:

Analyze technological problem definition:

- Layout program algorithm (solve problem definition)
- Implementation of the control algorithm into a PALPC source program *.ppc; edit code with text editor
- Compile PALPC source file with PALPC compiler; on faultless translation an output file *.out is created by the compiler
- Download output file *.out into the flash memory of 1-axis-controller MC1
- Start program and check control behavior regarding technological problem definition

5.3.1 Install programming software PALPC.exe

To install PALPC software do the following:

1. Insert PALPC 2.1 installation medium (delivered CD or USB stick) with the control computer.
2. Following Auto-start-window will be shown (when installing from CD):

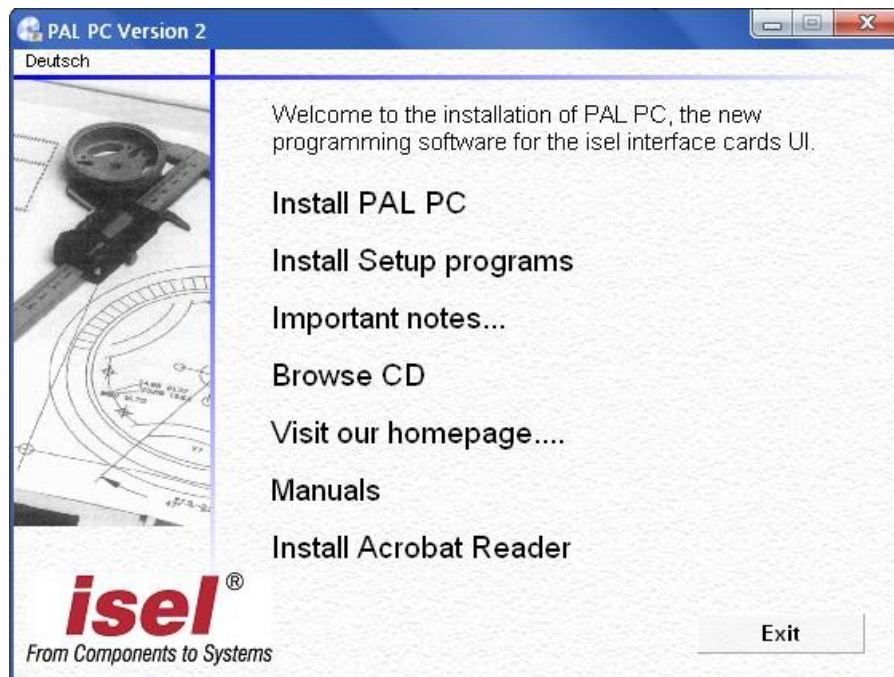

If Auto-Start-window is not shown start the Windows Explorer and open the root directory of the CD/DVD- or USB-drive. Double click on the file “Autorun.exe“.

3. Click on “**Install PAL PC**” and follow the installation instructions.

PALPC installation assistant → installation dialog:



4. Start PALPC.exe via start menu entry or desktop shortcut. On first startup an activation window will be shown. Enter delivered registration data (serial number and activation code) into the dialogs edit fields.

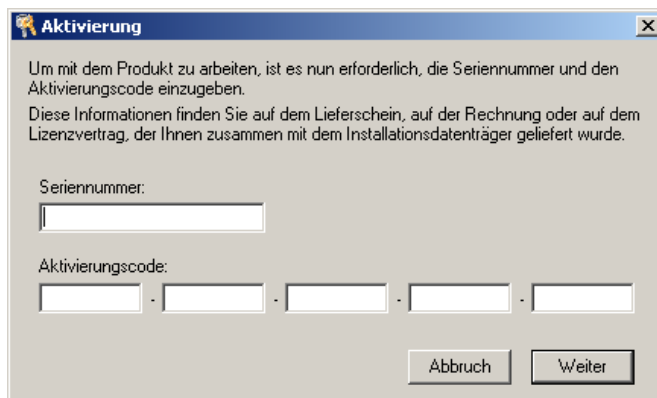

5.3.2 PALPC- operation

The use of PALPC and user programming are described in /1/ PALPC user manual and /2/ PALPC programming instruction.

For 4-axis-controller iMC-S8 note following specialties:

```

Datei: SetPortA1.ppc
Controller: 4-Achs-Controller iMC-M / iMC-P von isel Germany 2009
Inhalt: Testprogramm im CNC-Mode -> Setzen
        - der binären Ausgänge A1.1 bis A1.8 (A1=Port 65532)
        - Analogausgang und Spindel-Start (A2=Port 65528)
erstellt: 20/07/2009, isel Germany

*****

#control IMCMP;          / Festlegung des Ziel-Controllers
                        /> nur für Offline-Betrieb (ohne Controller) wichtig

#axis xyza;             / Achsenwahl
#steps 800,800,800,800; / Schrittauflösung: 4 Mikroschritte * 200 Vollschritte/U
#elev 5,5,4,4;          / Steigung der Achsen

#input                  / nachfolgende Anweisungen speichern

/ JG: zum offline-Test:
test_mode on;

reference xyza;        / Referenzfahrt Achsen

repeat                 / Schleifenanfang

/ Hinweis: A1 steht bei der iMC-M/P für die Portadresse 0 (Binärausgabe)
set_port 0,1=1         / binären Ausgang A1.1 setzen
time 1;
set_port 0,2=1         / binären Ausgang A1.2 setzen
time 1;
set_port 0,3=1         / binären Ausgang A1.3 setzen
time 1;
set_port 0,4=1         / binären Ausgang A1.4 setzen
time 1;
set_port 0,5=1         / binären Ausgang A1.5 setzen
time 1;
set_port 0,6=1         / binären Ausgang A1.6 setzen
time 1;
set_port 0,7=1         / binären Ausgang A1.7 setzen
time 1;
set_port 0,8=1         / binären Ausgang A1.8 setzen
time 1;
set_port 0,128=0x00;   / Port A1: A1.1 bis A1.8 rücksetzen
time 1;
set_port 0,128=0xFF;  / Port A1: A1.1 bis A1.8 setzen
time 10;
set_port 0,1=0         / binären Ausgang A1.1 rücksetzen
time 1;
set_port 0,2=0         / binären Ausgang A1.2 rücksetzen
time 1;
set_port 0,3=0         / binären Ausgang A1.3 rücksetzen
time 1;

```

1. The declaration
#control IMCMP;
 defines target controller as 4-axis-controller iMC-S8 (iMC-M / iMC-P / IMC4 compatible family)

2. The declaration
#axis xyza;
 defines the axis that will be used, in this case four axis: x, y, z and a

3. The declaration
#steps 800;
 defines the step resolution set by DIP switch
 e.g. #steps 800; /4 micro steps per full step * 200 full steps/motor revolution

4. The declaration
 defines the spindle elevation of the connected linear axis,
 e.g. #elev 5,5,5,4 /elevation 5mm for xyz-axis, 4mm for a-axis

#elev 360°/ transmission ratio;
defines the transmission ratio of the connected rotary axis,

e.g. ZR20 with transmission ratio 1:20:

$$\frac{360^\circ}{20} = 18 \rightarrow \text{\#elev 18;}$$

5.4 DNC- mode

In DNC mode the 4-axis-controller controller **iMC-S8** is connected permanently via RS-232 interface with a control PC (IBM compatible PC or Notebook).

A user program stored in flash memory will not be executed. The commands to execute an action/motion (e.g. reference motion, motion of the axis or I/O actions) will be sent by user software from the PC with the new Remote/ProNC motion control for 4-axis-controller (IMC4 compatibility mode).

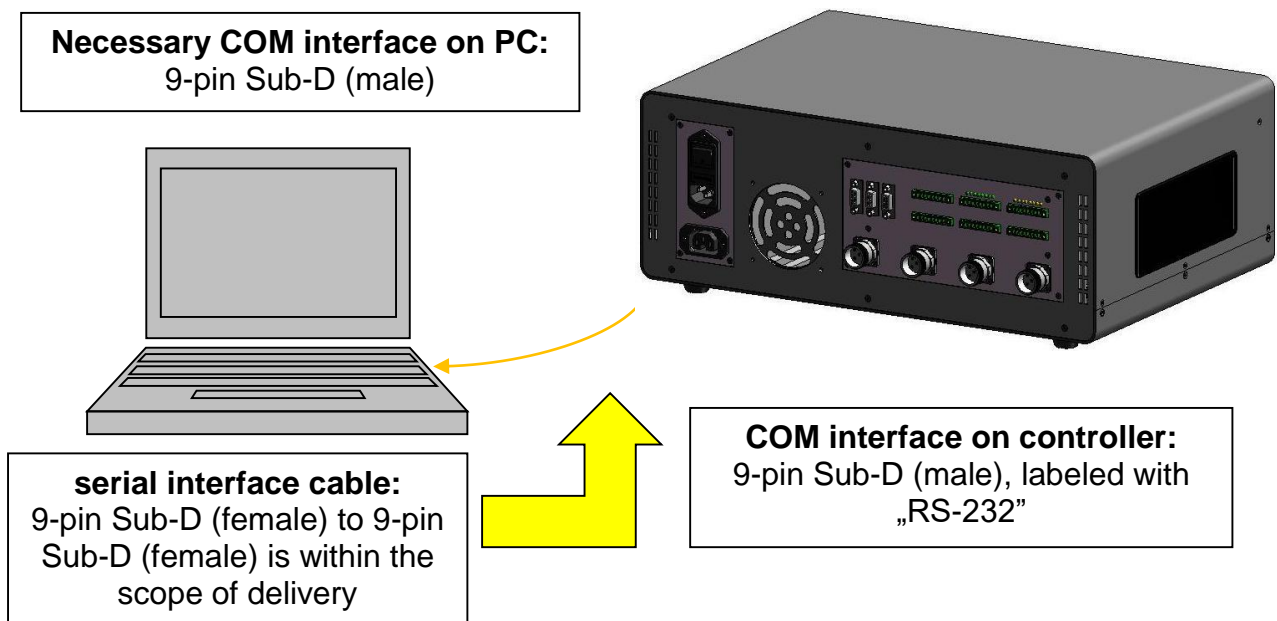

Image: serial connection (RS-232) between PC / Notebook and iMC-S8 via interface cable

Likewise in this configuration can be done:



PALPC 2.1 user program download into the flash memory of the 4-axis-controller iMC-S8
(COM Interface for PALPC: 19200 Bit/sec, PaIPC.exe)

5.5 Initial operation und user programming in DNC-mode

User programming and control of the 4-axis-controller iMC-S8 in DNC-mode takes place by the programs **Remote** or **ProNC** by binding the corresponding motion-control-DLL file. Commands in the user program will be send to the 4-axis-controller.

Installation of the control software Remote (version 1.46.2.1 or higher)

the following steps to install setup software:

1. Insert Remote (part.-no.: Z12_334500) installation medium (delivered CD or USB stick) with the control computer.
2. An Auto-start-window will be shown (when installing from CD):



If Auto-Start-window is not shown start the Windows Explorer and open the root directory of the CD/DVD- or USB-drive. Double click on the file "Autorun.exe".

3. Click on the entry "**Installation of Remote**".

Choose your language and follow the instructions of the setup assistant.

4. Mark on setup window “Select control“ the option “Stepper motor control IMC4“ to install the IMC4 stepper motor driver module.

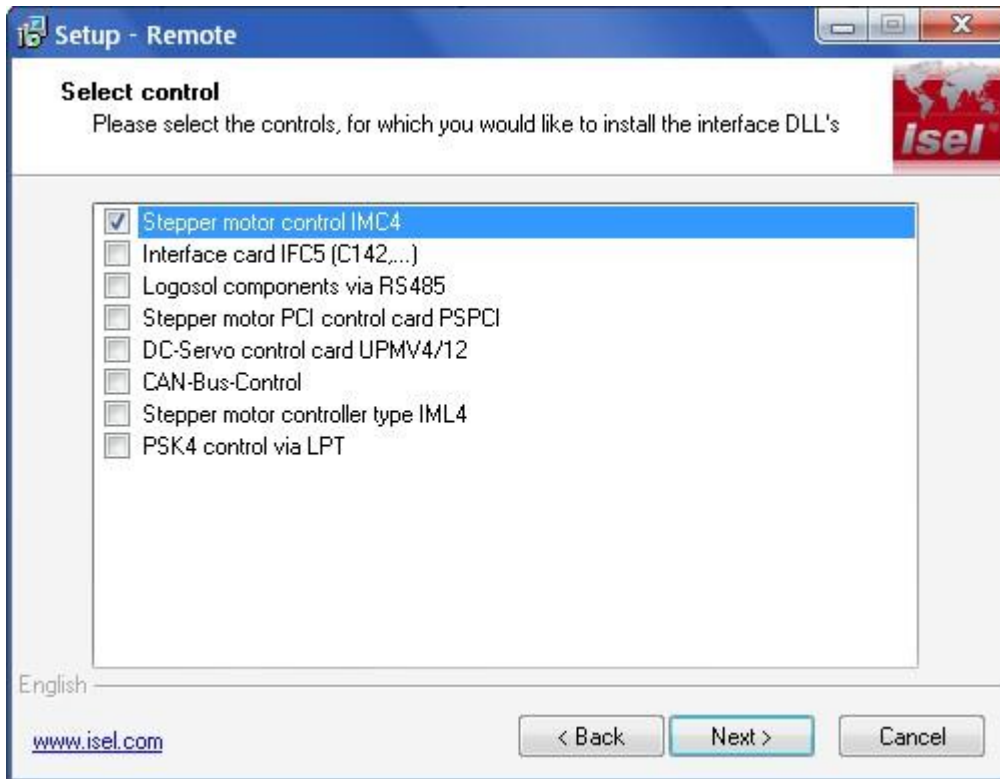

After finishing the installation click on button “Exit“ to close the Auto-Start-menu.

5. Open the control software Remote via shortcut on the windows desktop or the start menu entry: Start → Programs → CNCworkbench → Remote
6. On first startup of the software Remote you have to type in a serial number and an activation code. You will find this information on the delivered registration formular.

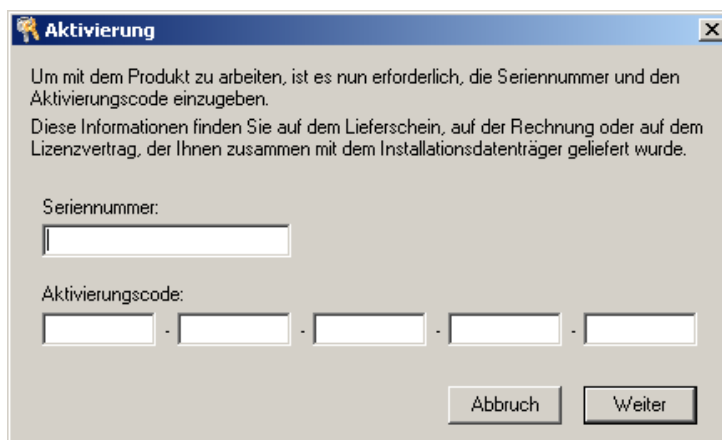

Click on button „Next“ to check the registration data. If the data is ok Remote will starting.

Use of the controller with Remote

Using iMC-S8 with Remote (ProNC) via serial interface:

1. Start control software *Remote*. If you don't have activated *Remote* you have to do it now.
2. After installation of *Remote* for a specific control (in this case IMC4) all module DLL's for the motion control, I/O module, spindle module and security circuit module are set correctly. You only have to set the parameters to your machine configuration.

Click in the main menu to the entry Settings → Control

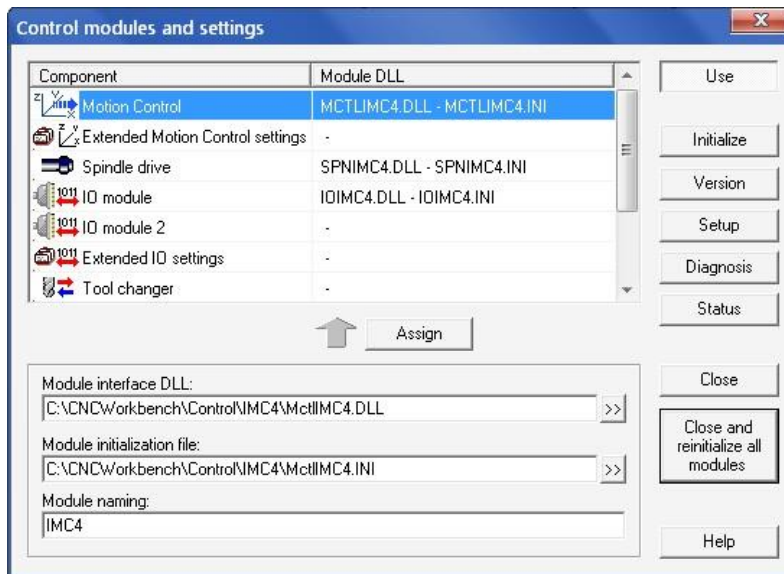



The dialog shows all active and used modules in a list.

Mark the line “Motion Control” and click on button “Setup” on the right side to show the settings for communication and axis kinematics.

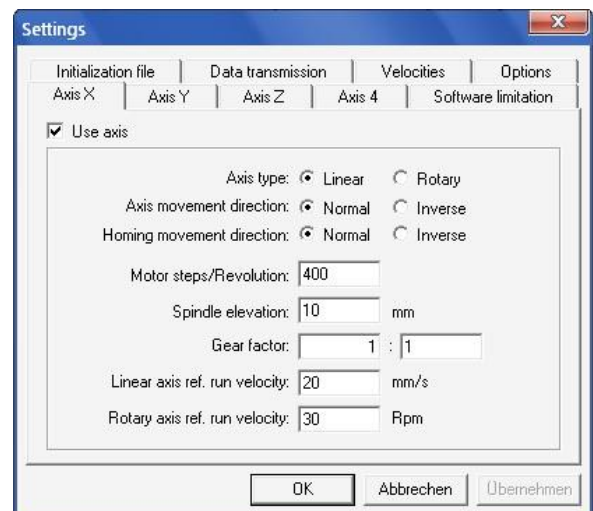
Over the different register cards you can change the parameters like axis direction, spindle gradient, gear etc. for each separate axis. Over the register card “Data transmission” you can change the used COM Port of the control computer.



3. If you have set all parameters close the dialog with the button „OK“. Click on button “Close & Initialize” in the “Control module and settings” dialog to take effect the new settings and reinitialize the control.

4. Perform a software reset  and a reference run  to check correct behaviour of the machine /system.

6 EC - Declaration of Conformity

Der Hersteller

The manufacturer

isel Germany AG
Bürgermeister-Ebert-Str. 40
D-36124 Eichenzell

erklärt hiermit, dass folgendes Produkt
hereby declares that the following product

Geräteart: **4-Achs-Schrittmotor-Controller**

Device: *4-axis stepper motor controller*

Typ: **iMC-S8 / iMC-S8 16/16**

Type:

Art.-Nr.: **383320 x00x**

Product - No.: *383320 x00x*

mit den Vorschriften folgender Europäischer Richtlinien übereinstimmt:
complies with the requirements of the European Directives:

EG-Richtlinie 2014/30/EU

EC-Directive 2014/30/EC

EMV Richtlinie

EMC directive

EG-Richtlinie 2014/35/EU

EC-Directive 2014/35/EC

Niederspannungsrichtlinie

low voltage directive

EG-Richtlinie 2011/65/EU + 2015/863/EU

EC-Directive 2011/65/EC + 2015/863/EC

RoHS Richtlinie + delegierte Richtlinie

RoHS directive + delegated directive

Folgende harmonisierte Normen wurden angewandt:

Following harmonized standards have been applied:

EN 61000-6-2:2006

EMV - Fachgrundnorm - Störfestigkeit für Industriebereich
EMC - Generic standards - Immunity for industrial environments

EN 61000-4-2:2008

EMV - Prüf- und Messverfahren - Prüfung der Störfestigkeit gegen Entladung statischer Elektrizität (ESD)
EMC - Testing and measurement techniques; Electrostatic discharge immunity test

EN 61000-4-4:2012

EMV - Prüf- und Messverfahren - Prüfung der Störfestigkeit gegen schnelle transiente elektrische Störgrößen (Burst)
EMC - Testing and measurement techniques - Electrical fast transient/burst immunity test

EN 61000-4-5:2007

EMV - Prüf- und Messverfahren - Prüfung der Störfestigkeit gegen energiereiche Impulse (Surge)
EMC - Testing and measurement techniques - Surge immunity test

EN 61000-4-11:2005

EMV - Prüf- und Messverfahren - Prüfung der Störfestigkeit gegen Spannungseinbrüche / Spannungsunterbrechungen
EMC - Testing and measurement techniques - Voltage dips, short interruptions and voltage variations immunity tests

EN 61000-6-3:2011

EMV - Fachgrundnorm - Störaussendung Wohn- und Geschäftsbereich, Kleinbetriebe
EMC - emission standard for residential, commercial and light-industrial environments

EN 61000-6-4:2007

EMV - Fachgrundnorm - Störaussendung Industriebereich
EMC - Generic standards - Emission standard for industrial environments

EN 55016-2-1:2014

EMV - Prüf- und Messverfahren - Messung der leitungsgeführten Störaussendung
EMC - Generic standards - Conducted disturbance measurements

Dermbach, 18.07.2019

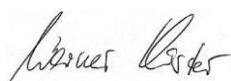

Werner Kister, Vorstand / managing board

7 Bibliography

/820/ Microstepping Driver MD28, Hardware Description, 08/2021

/2/ PAL PC 2.0 Operating instruction, status 06/2004

/3/ Remote operating instruction, status 2003

Operating instructions and manuals for download you can find here:

www.isel.com

8 Index

#

#control 29
#steps 29

A

activation code 28
Analog - Out 17

C

CNC mode 26
Cover 17
current reduction 23
current setting 22

D

digital inputs 9
digital outputs 9
DNC-mode 31

E

emergency stop switch 12
EMV Richtlinie 35
external emergency stop 15

F

flash memory 31

H

harmonisierte Normen 35

I

installation dialog 28
intended use 6

interface impulse control 15

L

Low voltage directive 6

N

Niederspannungsrichtlinie 35

O

Operation mode switch 11
output file 27

P

PALPC compiler 27
PALPC.exe 27
peak current 9
power-button 12
program memory 9
ProNC 31

R

rated current 9
Remote 31
RS232 18

S

security circuit interface 14
serial number 28
Spindle 19
start-button 11
step resolution 23
stop-button 12

T

text editor 27