



UNIVERSITY  
OF  
JOHANNESBURG



# Data Acquisition Hardware (Hands-on Approach)

ISOTDAQ2012, February 2<sup>nd</sup>

S. Ballestrero University of Johannesburg & CERN - W.Vandelli CERN/PH-ATD

---



# Outline



## → Introduction

## → Measure energy deposition

- Scintillator setup
- Photomultiplier
- Analog-to-Digital conversion
- Charge-to-Digital conversion
- QDC in real life

## → Measure position

- Wire chamber setup
- Time-to-Digital conversion
- TDC in real life

## → Corollary



# Introduction



- This wants to be a hands-on approach to the basic DAQ hardware
- We will discuss two different experiments, requiring different techniques and components
- We also have some good real data to discuss
  - You will see, we are talking about real life here
- Let's get started!

Material and ideas have been taken from CERN Summer Student lectures of P.Farthouat, C.Joram and O.Ullaland



# 1<sup>st</sup> experiment



# Energy measurement

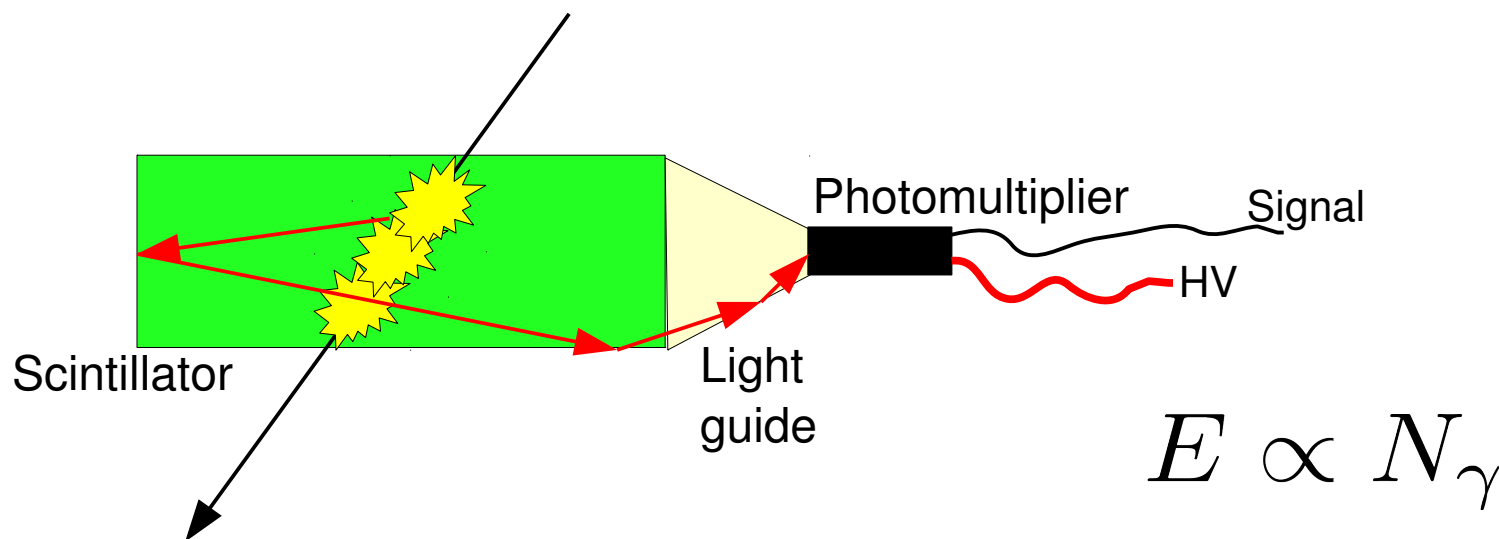

- Measure the energy deposited by a particle traversing a (special) medium
- The (detector) medium is a scintillator → The molecules, excited by the passing particle, relax emitting light
  - The amount of light is proportional to the deposited energy
- The light is then collected, using dedicated optical means (light guide), and fed into a photo-detector → photomultiplier



# Photomultiplier

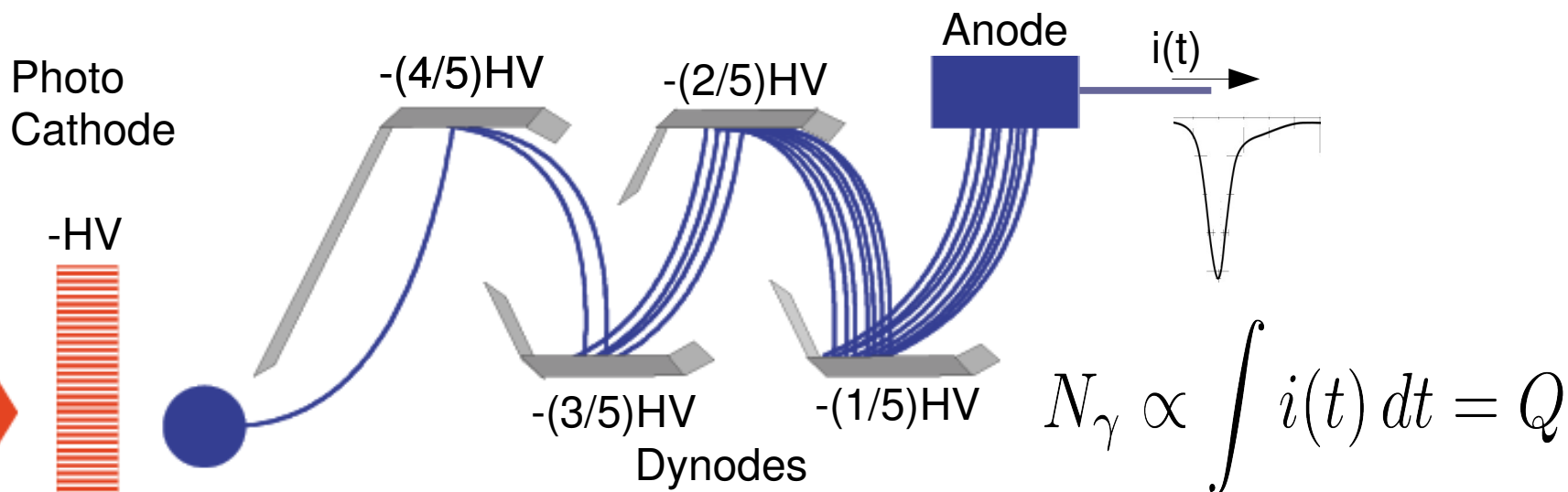

→ *Photo cathode*: photon to electron conversion via photo-electric effect

- Typical quantum efficiency  $\approx 1-10\%$  (depends on material and wavelength)

→ *Dynodes*: electrodes that amplify the number of electrons thanks to secondary emission

- Typical overall gain  $\approx 10^6$

→ *Dark current*: current flowing in the PMT without light → noise





# Getting started

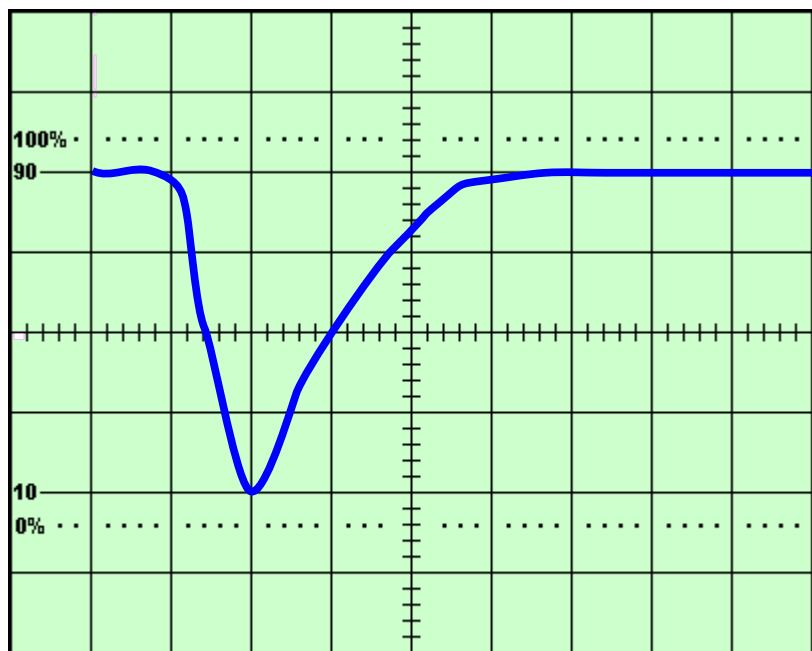

CH1: V/div 100mV Title:  
CH2: V/div  
Time/div: 20ns

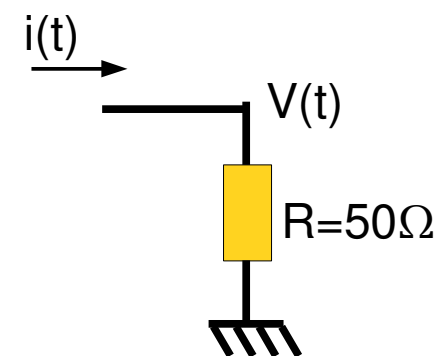
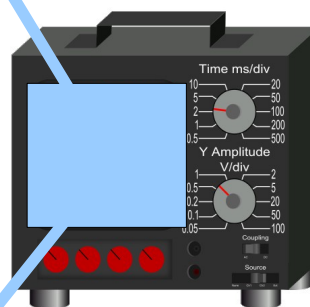

$$Q = \int i(t) dt = \frac{1}{R} \int V(t) dt$$



# Good old scope



→ Approximate Q measurement using oscilloscope

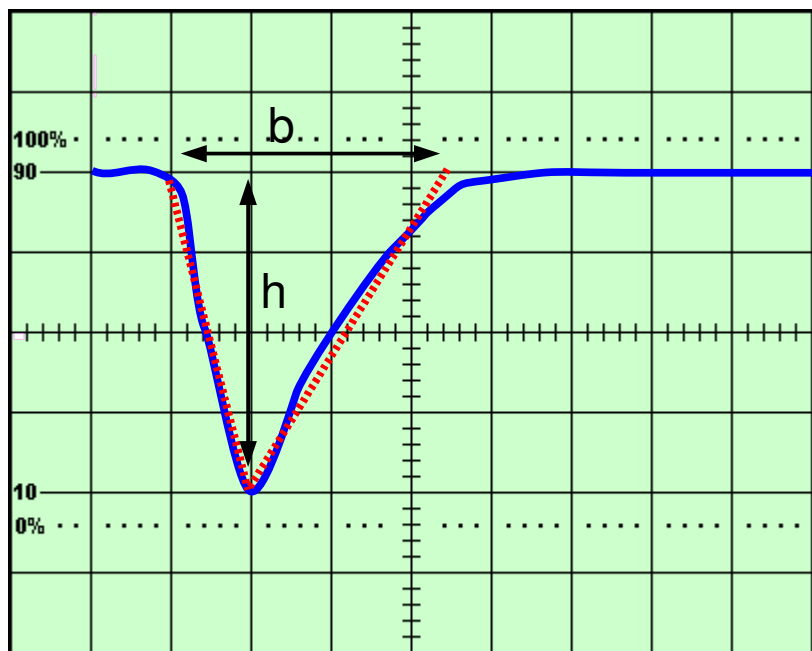

CH1: V/div 100mV Title:  
 CH2: V/div  
 Time/div: 20ns

- Linear approximation of a exponential decay

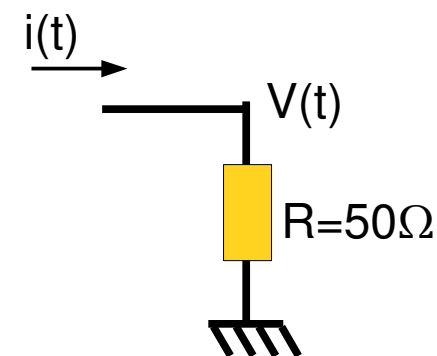
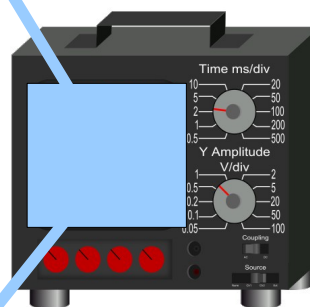

$$Q = \int i(t) dt = \frac{1}{R} \int V(t) dt$$

$$Q \approx \frac{1}{R} \frac{bh}{2} = \frac{1}{50\Omega} \frac{(3.5 \cdot (20\text{ns})) (4 \cdot (100\text{mV}))}{2} = 280\text{pC}$$





# Getting started

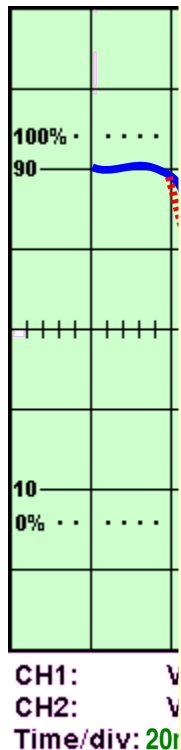

Done! (In less than 5 slides)

- Approximate measurement
- Deadtime ~3000%/Hz (if you are good)
- Encode the data into some sort of electronic format by hand

Wouldn't be much more convenient to have a direct electronic measurement? It could save the data in some digital format and fill a histogram on-line. Wouldn't be cool?

The scope method is still fundamental: allows for the validation of your DAQ (and, yes, you should never thrust it a priori!) *it*

$$Q \approx \frac{1}{R} \frac{bh}{2} = \frac{1}{50\Omega} \frac{(3.5 \cdot (20\text{ns})) (4 \cdot (100\text{mV}))}{2} = 280\text{pC}$$



# Analog to digital conversion: introduction



→ Digitization → Encode a analog value into a binary representation

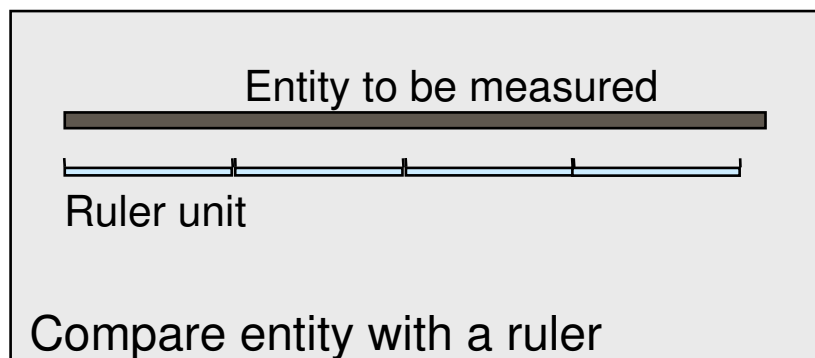



# Analog to digital conversion: Flash ADC



→ Digitization → Encode a analog value into a binary representation

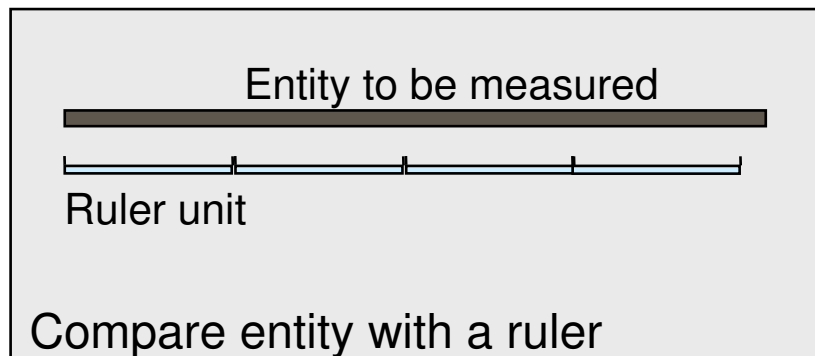

→ Flash ADC simplest and fastest implementation

→ Performs M comparisons in parallel

- Input voltage is compared with M fractions of a reference voltage:  $V_{ref}/(2M) \rightarrow (M-1/2)V_{ref}/M$

→ Result is encoded into a compact binary form of N bits

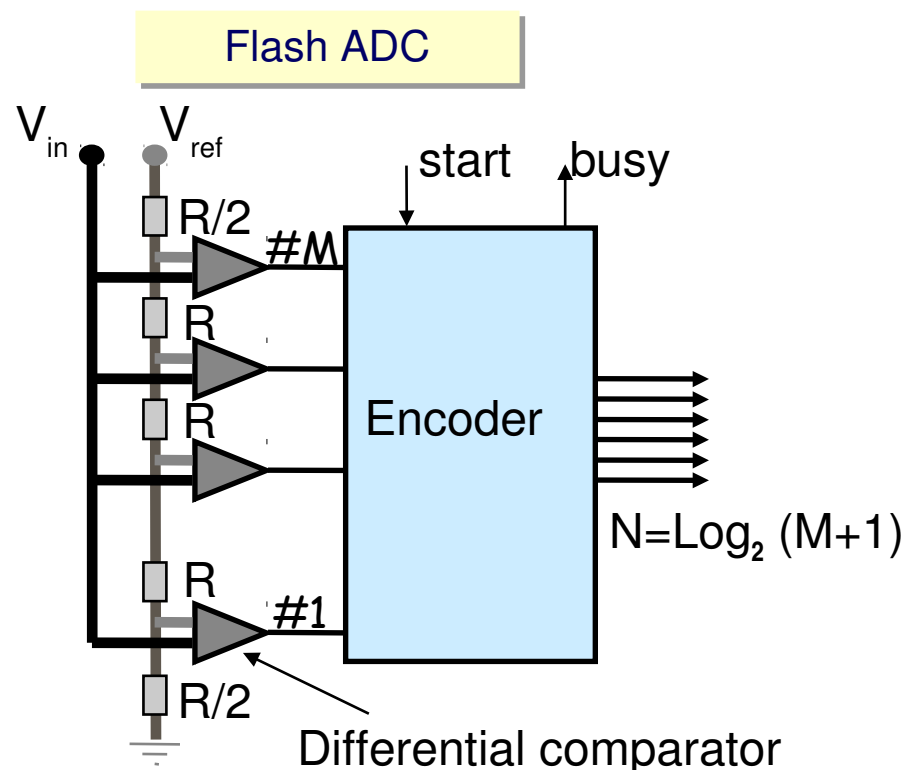



# Analog to digital conversion: Flash ADC



→ Digitization → Encode a analog value into a binary representation

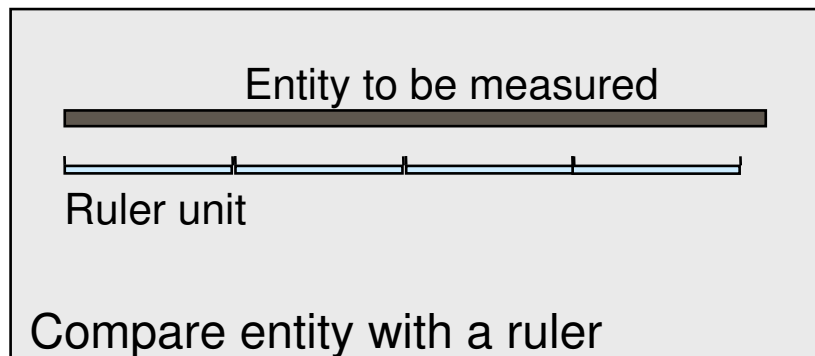

→ Example  $M=3 \rightarrow N=2$

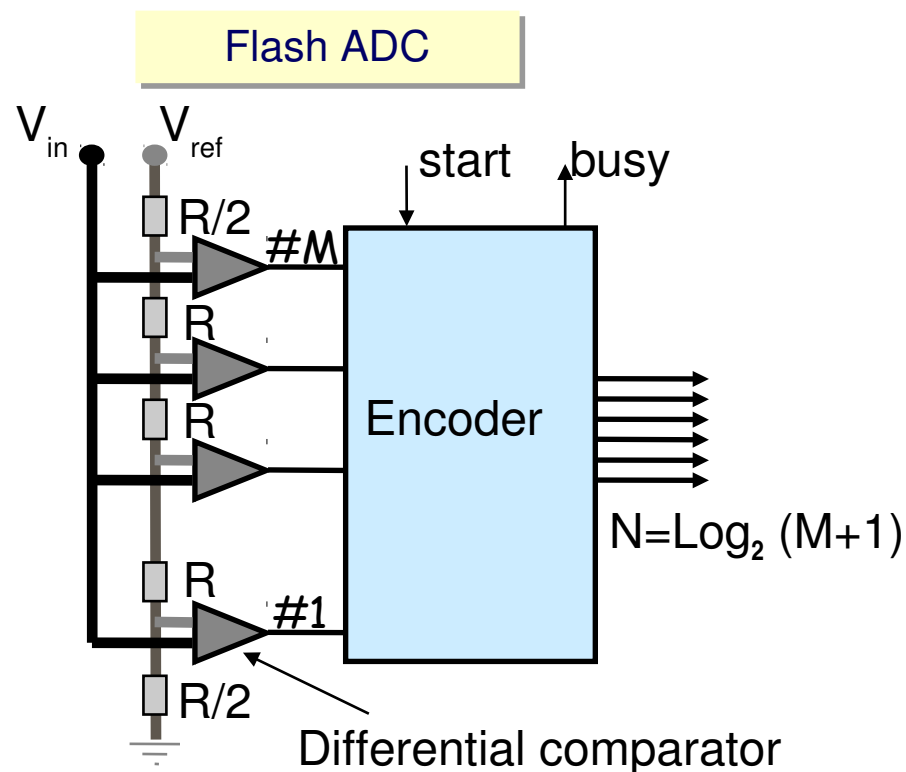

$V_{in}/V_{ref}$	Comparison results	Encoded form
$<1/6$	000	00
$1/6 \leq <3/6$	001	01
$3/6 \leq <5/6$	011	10
$5/6 \leq$	111	11



# ADC Characteristics



→ Digitization → Encode a analog value into a binary representation

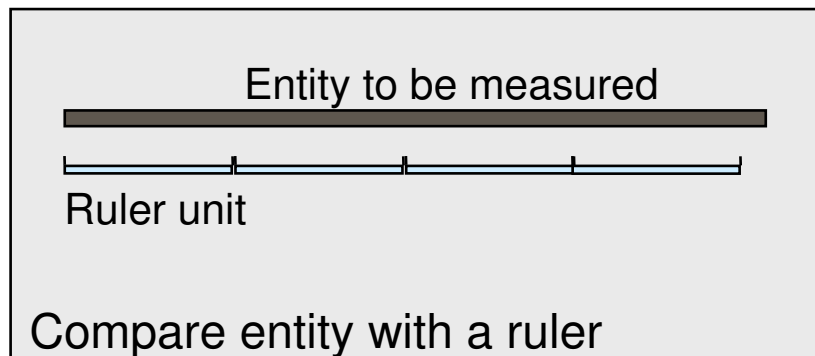

→ Resolution (LSB), the ruler unit:  $V_{\max}/2^N$

- 8bit, 1V → LSB=3.9mV

→ Quantization error, because of finite size of the ruler unit:  $\pm\text{LSB}/2$

→ Dynamic range:  $V_{\max}/\text{LSB}$

- N for linear ADC

- >N for non-linear ADC

- Constant relative resolution on the valid input range



# ADC phase-space



Many different ADC technique exists, mostly because of the trade-off between speed and resolution

Speed (sampling rate)

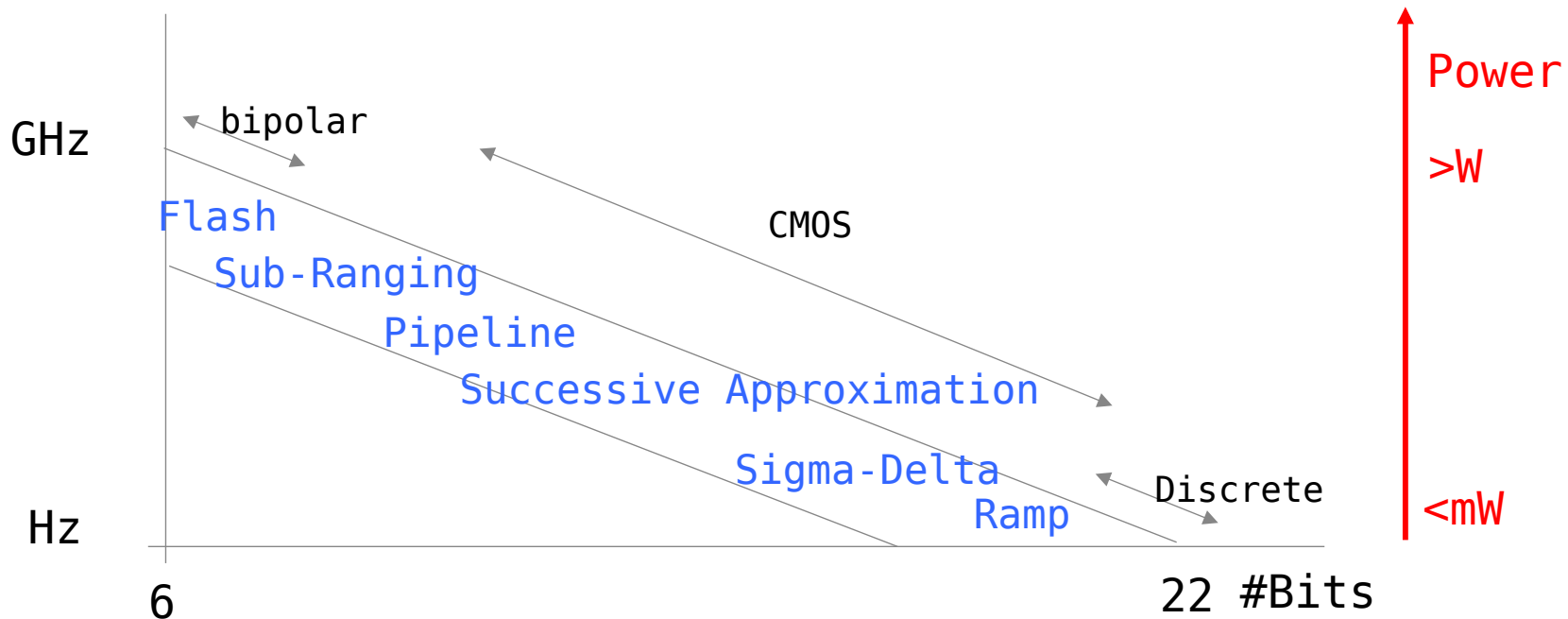



# ADC (In)Accuracies

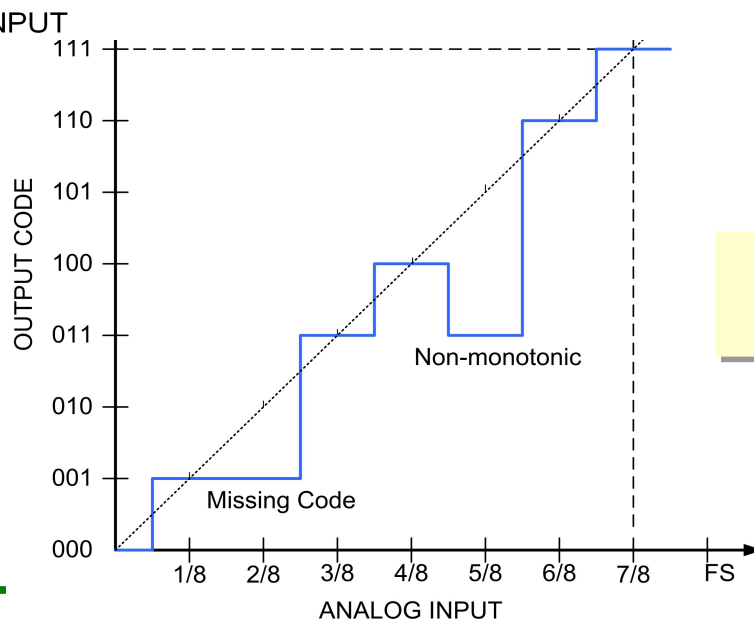
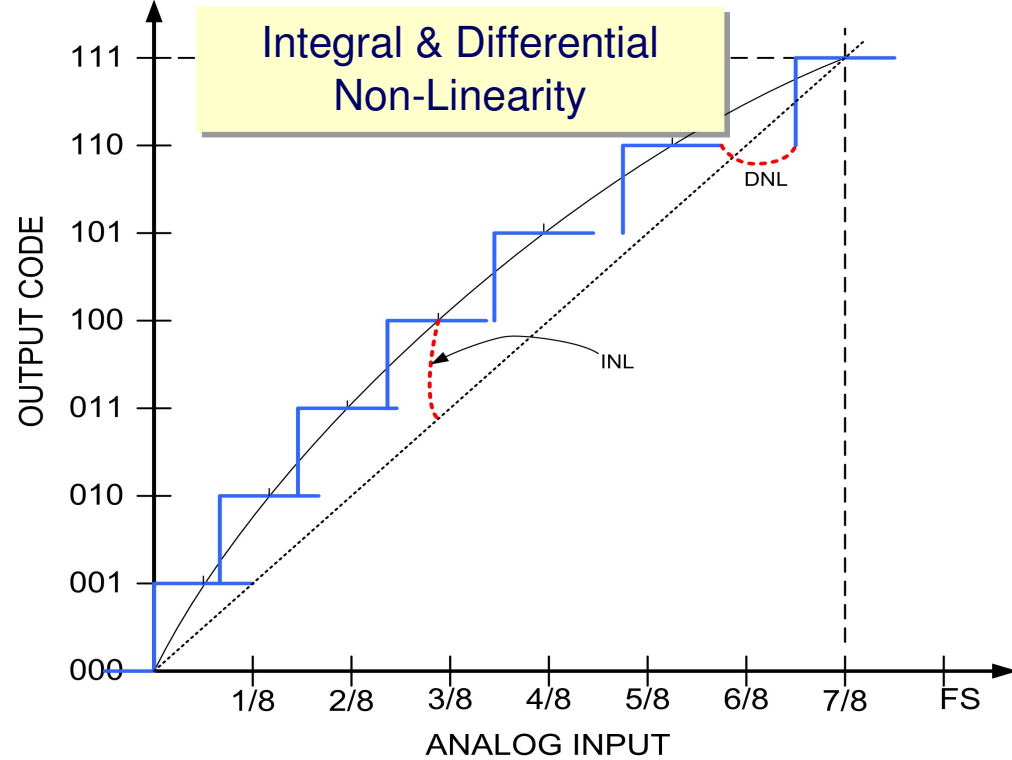
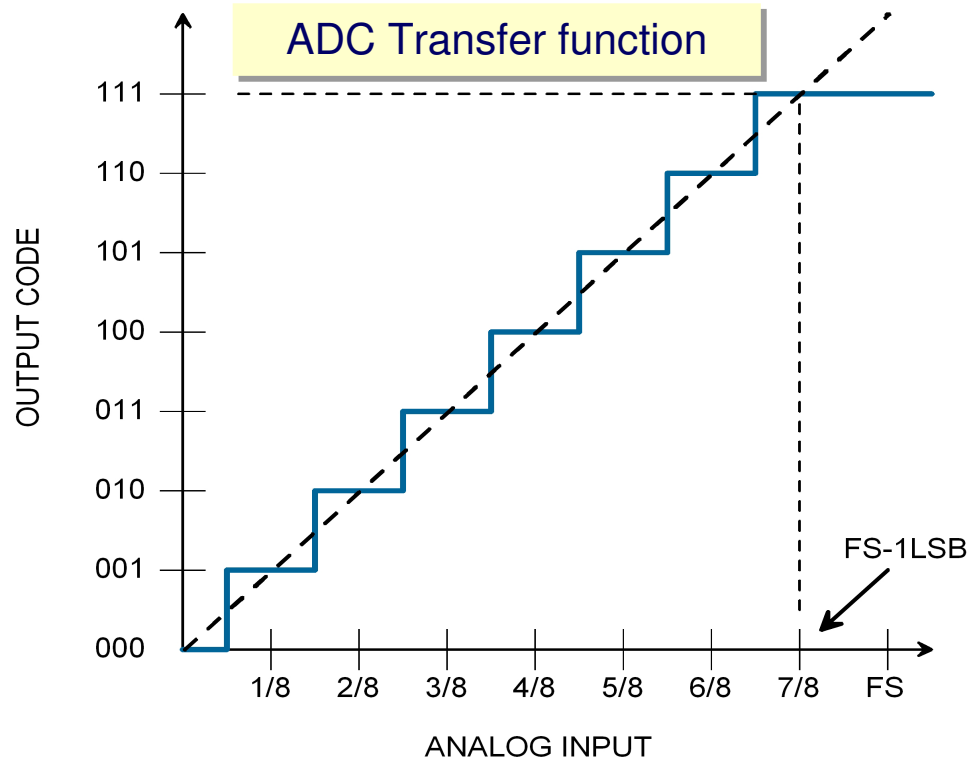

**Extreme Differential Non-Linearity**



# Charge to Digital → QDC



→ ADC converts a voltage into a digital representation. However, in our experiment, we have a current and we are interested in the total charge

→ QDC → Charge to Digital Converter

- Essentially an integration step followed by an ADC

→ Integration requires limits → gate

$$I = \int_a^b f(x) dx$$





# QDC and experiment 1



→ ADC converts a voltage into a digital representation. However, in our experiment, we have a current and we are interested in the total charge

→ QDC → Charge to Digital Converter

- Essentially an integration step followed by an ADC

→ Integration requires limits → gate

$$I = \int_a^b f(x) dx$$

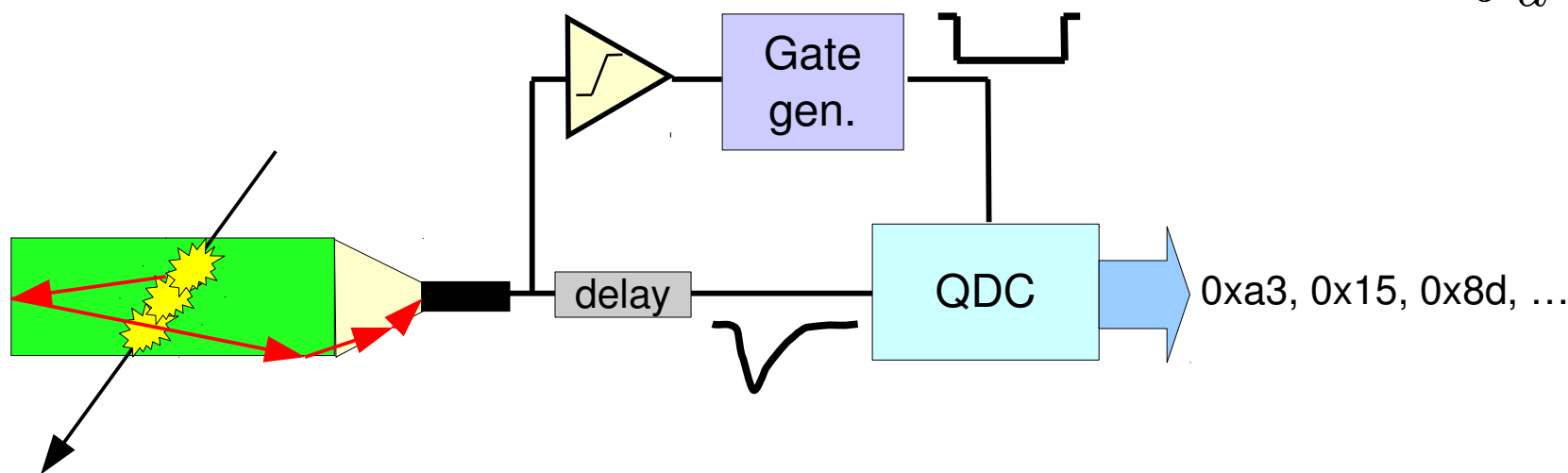

→ We are done: we have a digital representation of:

$$Q \propto N_\gamma \propto E$$

Question: what should follow the QDC? With which aim?



# QDC and experiment 1

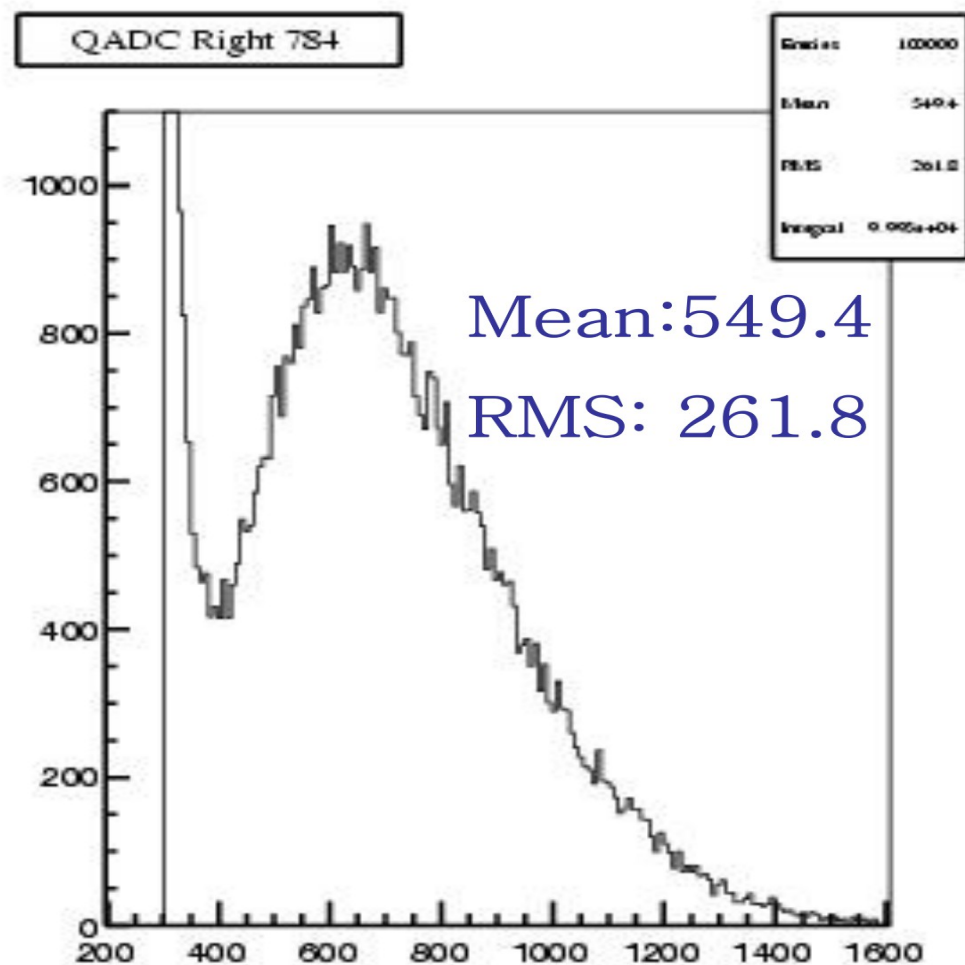
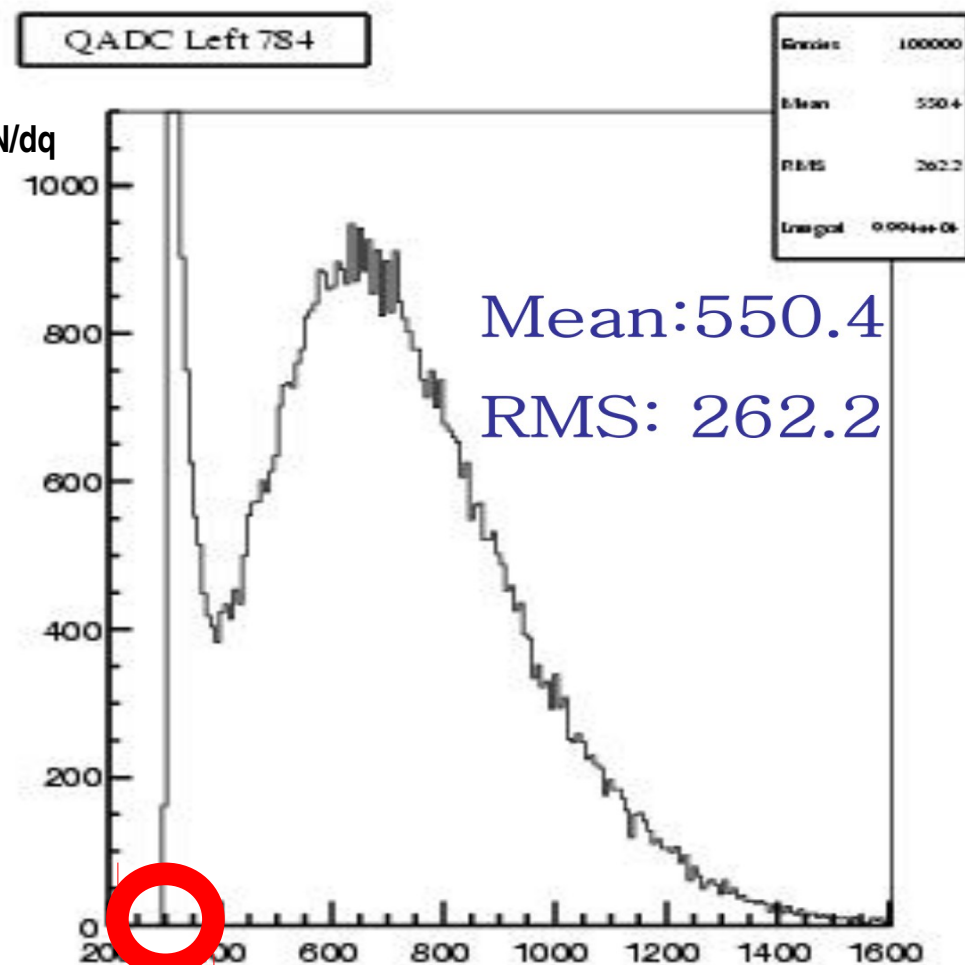

QDC count

2007-03-13 09:32:49

→ We are done: we have a digital representation of:

$$Q \propto N_{\gamma} \propto E$$

Question: what should follow the QDC? With which aim?



# QDC: Timing

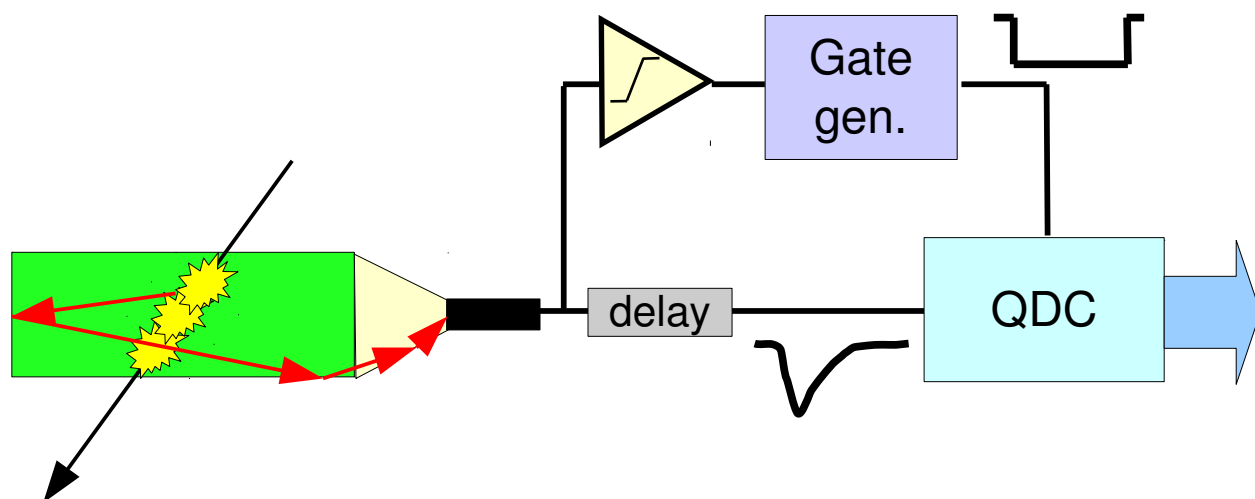

$$I = \int_a^b f(x) dx$$

→ Relative timing between signal and gate is important

- Delay tuning

→ Gate should be **large enough** to contain the full pulse and to accommodate for the jitter

- Fluctuations are always with us!

→ Gate should **not be too large** → increases the noise level

- By the way, which is the noise contribution to our charge measurement?

Q: the tail is exponential, how large is large enough?

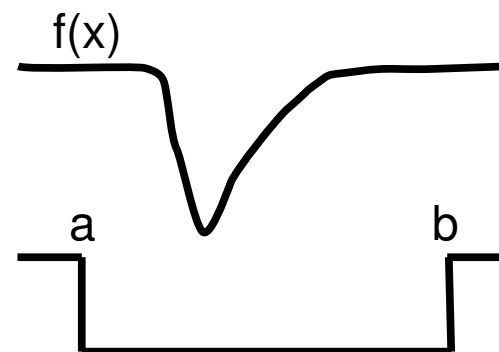



# QDC: pedestal subtraction

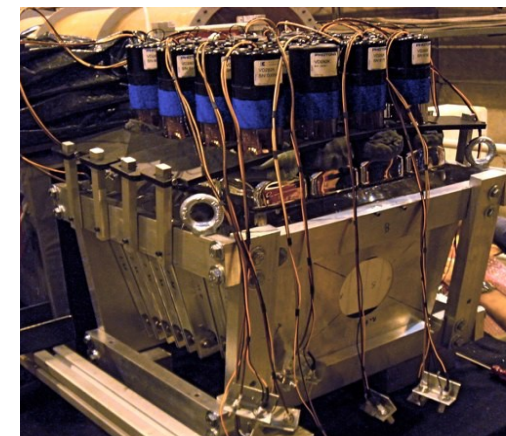
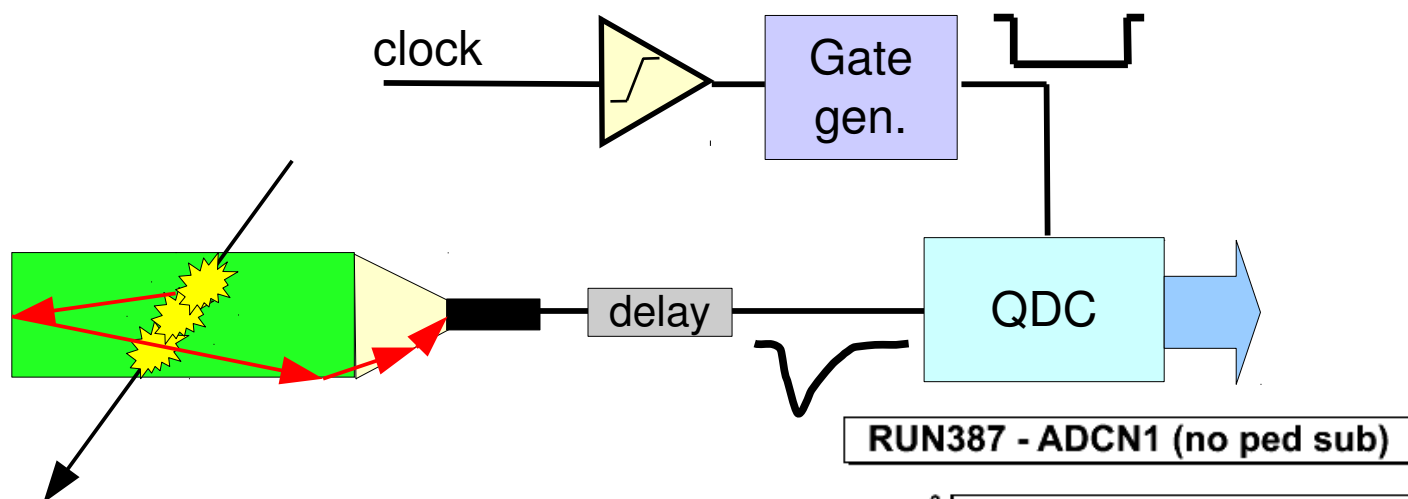

Calibration data from a test beam @CERN

- With an out-of-phase trigger we can measure the baseline (pedestal)
  - PMT dark current, thermal noise, ...
  - Out-of-time particles
- The same noise enters our physics measurements and contributes with an offset to the distribution
- The result of a pedestal measurement has to be subtracted from our charge measurements

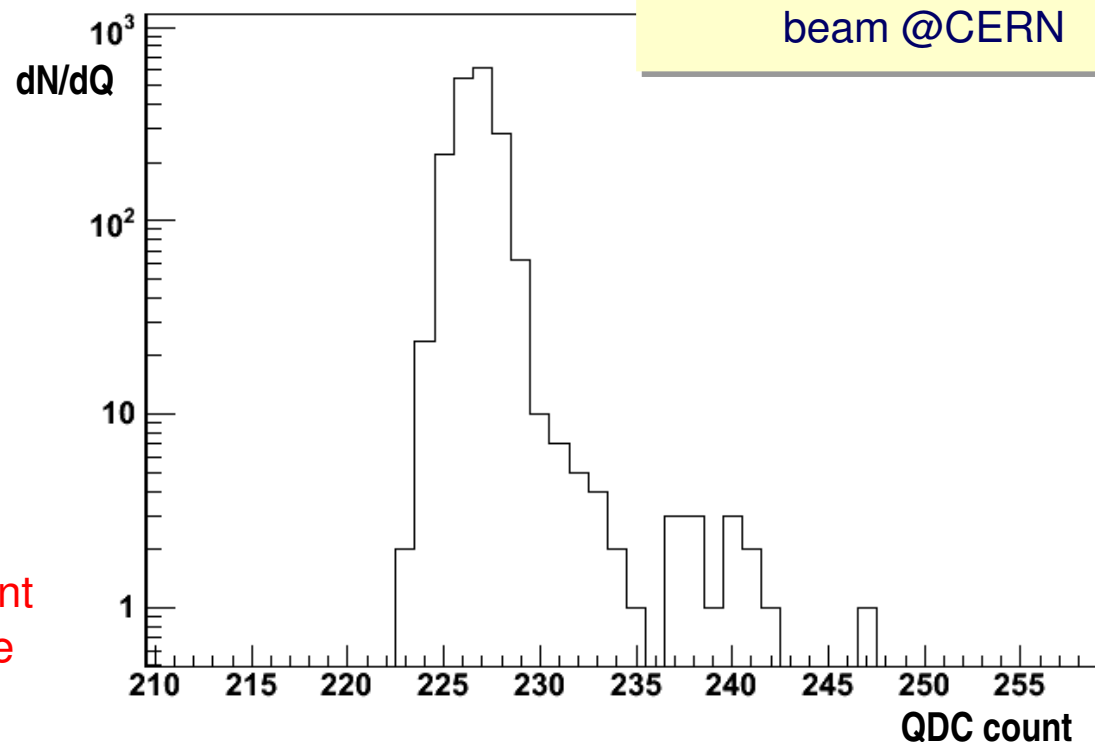



# Real QDCs at work



- Real data from a beam test @CERN
- $\text{PbWO}_4$  (scintillating) crystal equipped with two PMTs and exposed to  $e, \mu$  and  $\pi$  beams

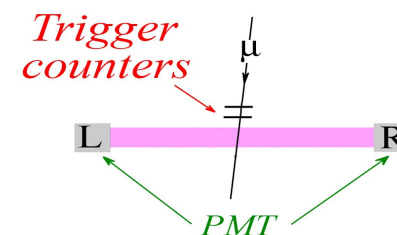



# Real QDCs at work



- Real data from a beam test @CERN
- $\text{PbWO}_4$  (scintillating) crystal equipped with two PMTs and exposed to  $e, \mu$  and  $\pi$  beams

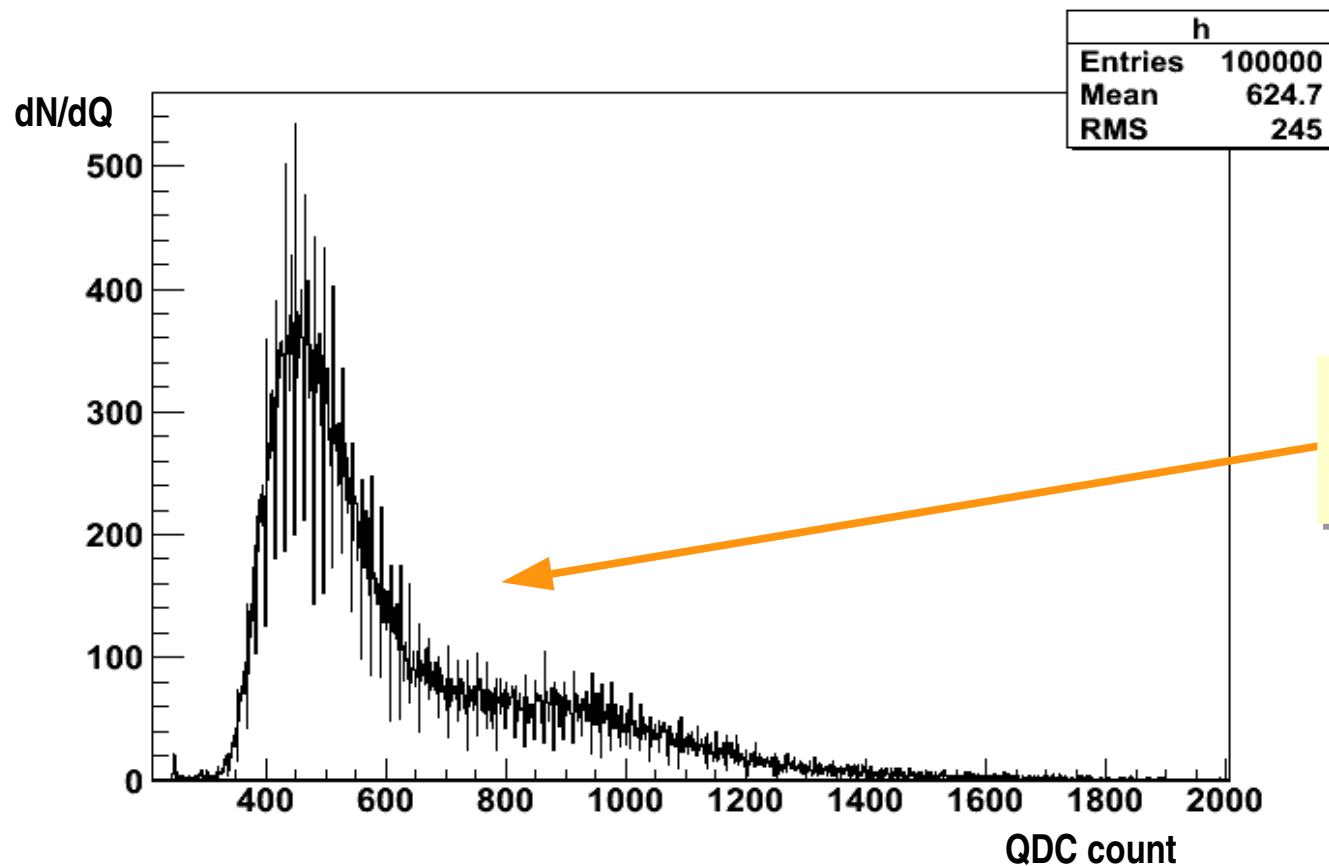
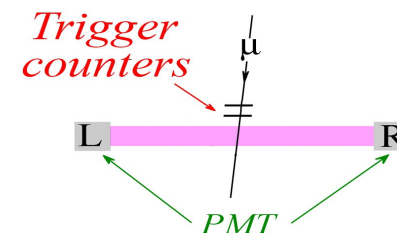

Nice pion-beam charge-distribution for one PMT



# Real QDCs at work



→ Real data from a beam test @CERN

→  $\text{PbWO}_4$  (scintillating) crystal equipped with two PMTs and exposed to  $e, \mu$  and  $\pi$  beams

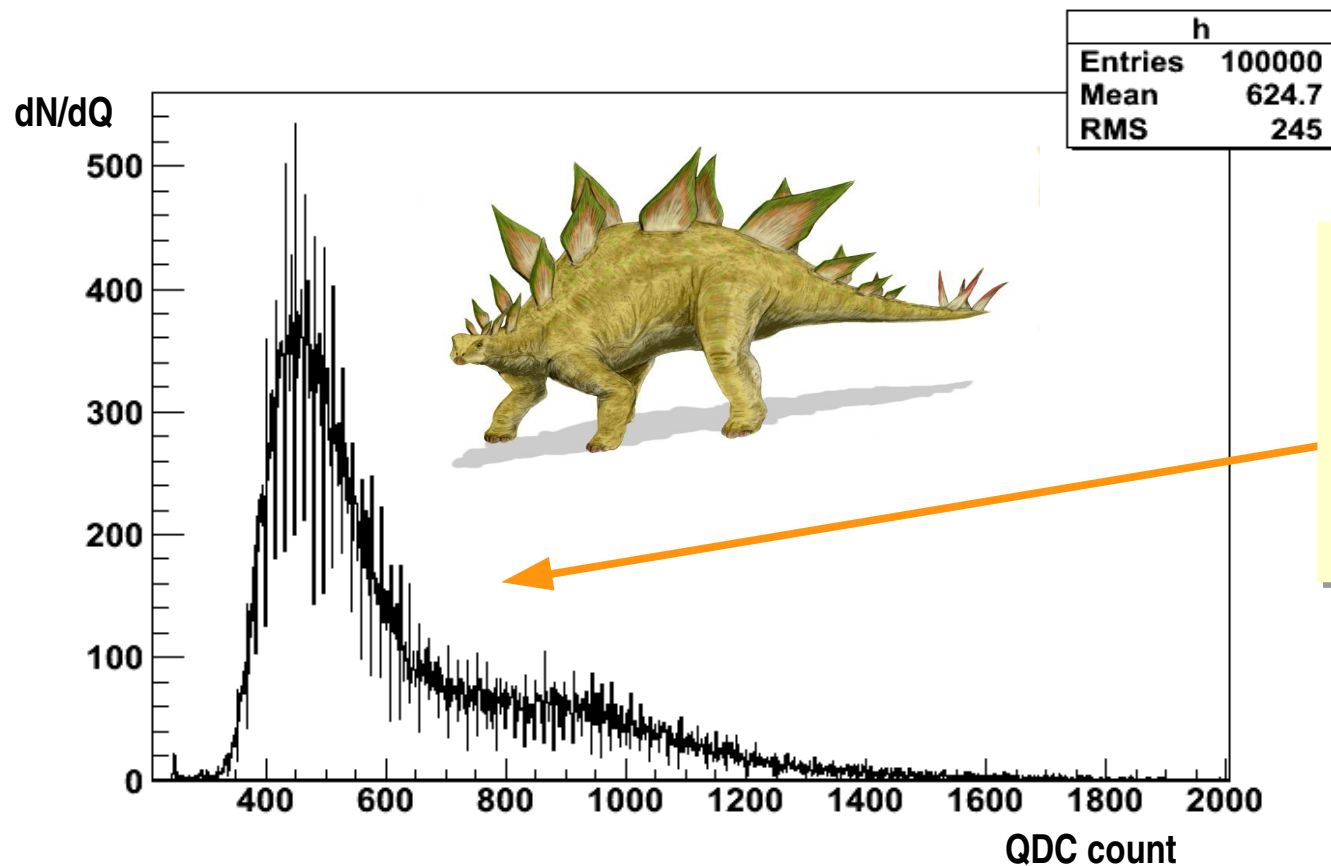
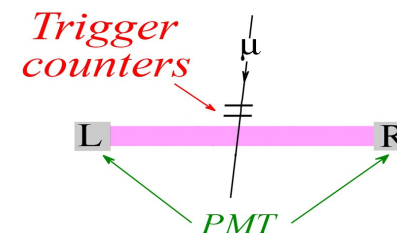

Nice pion-beam charge-distribution for one PMT

But, what are all those little peaks? Just statistical fluctuations? Let's zoom in!



# Real QDCs at work

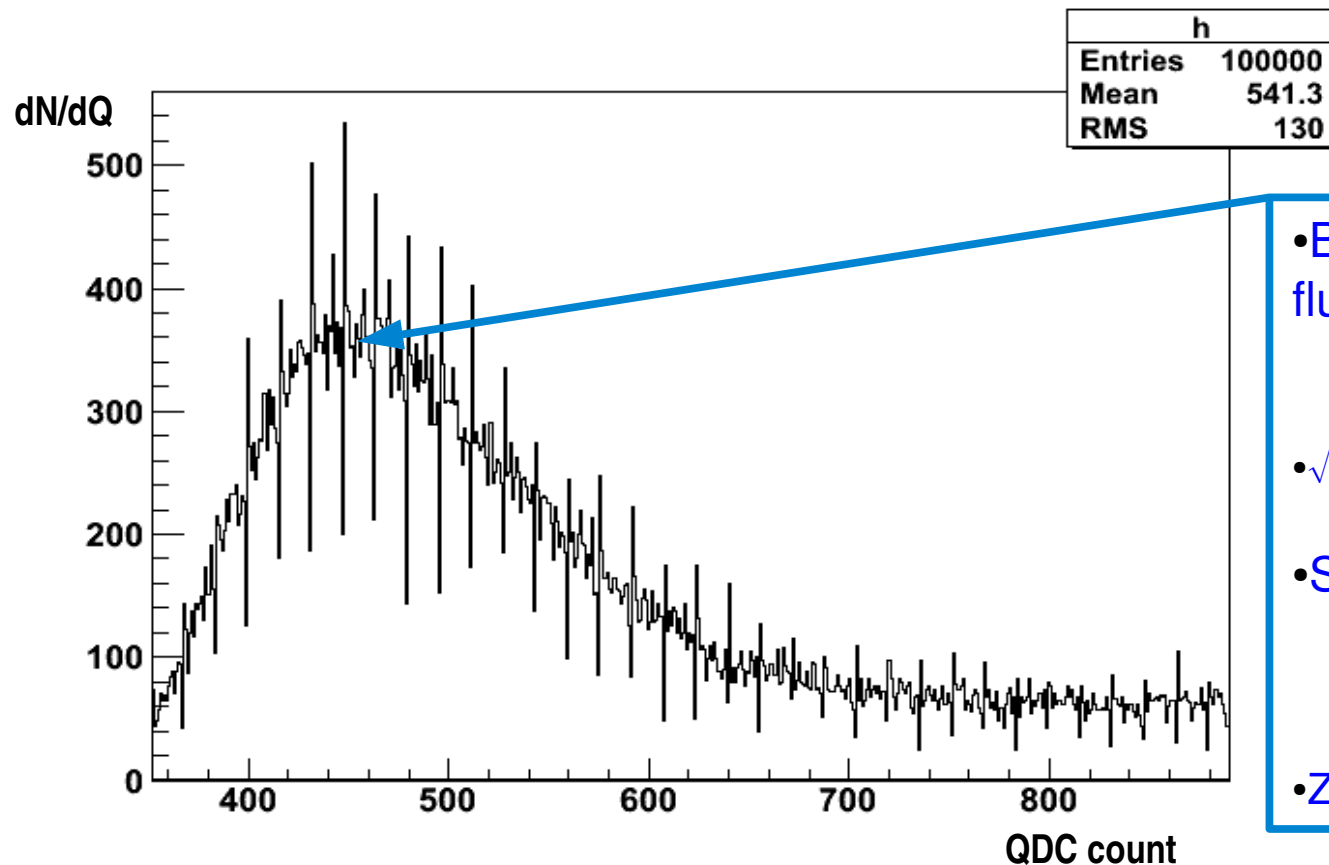
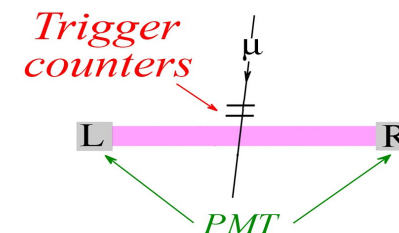

- Bin with N entries shall fluctuate with
  - $\sigma = \sqrt{N}$
- $\sqrt{360} \sim 19 \rightarrow () \sim 10\sigma$
- Spikes are regularly distributed
  - Some systematic effect must be taking place
- Zoom in a bit more!





# Real QDCs at work



- 415 & 416 → 0x19f & 0x1a0
- 431 & 432 → 0x1af & 0x1b0
- 447 & 448 → 0x1bf & 0x1c0

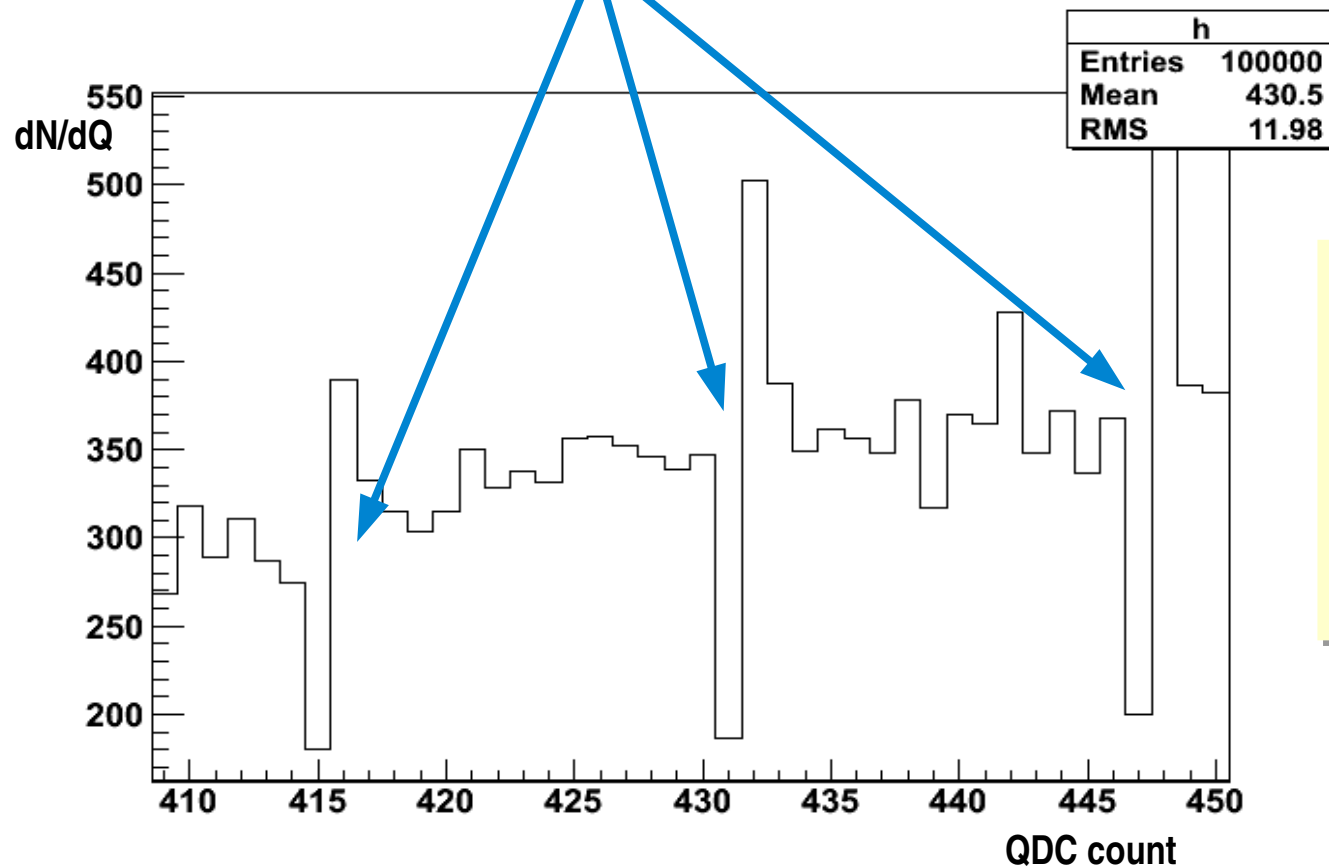
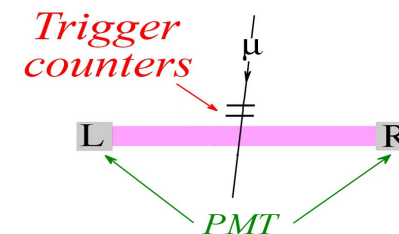

Can you see the effect?

The QDC prefers output configurations of type xxx0 in respect of those like xxxf



# Real QDCs at work

- 415 & 416 → 0x19f & 0x1a0
- 431 & 432 → 0x1af & 0x1b0
- 447 & 448 → 0x1bf & 0x1c0

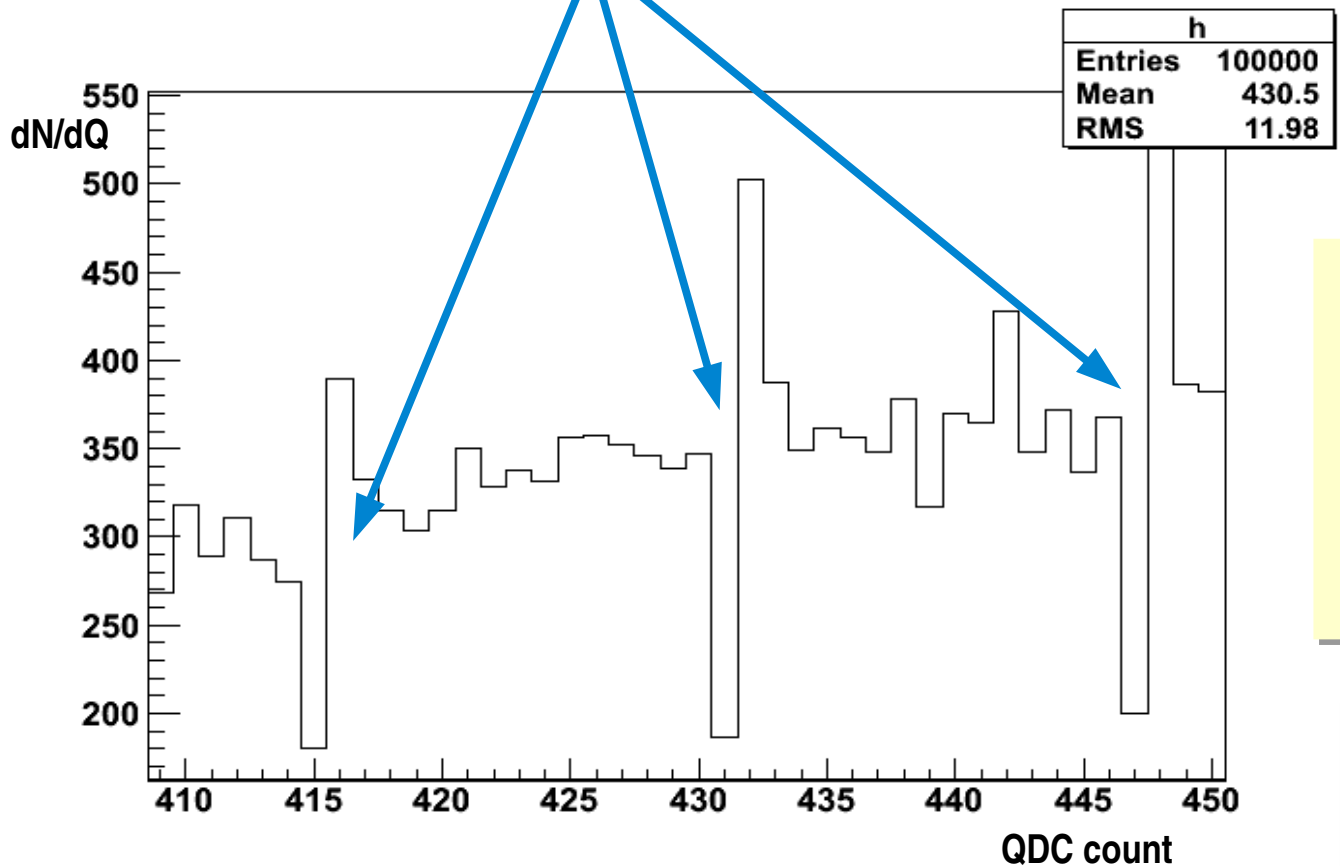
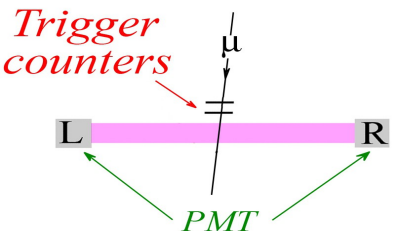

Can you see the effect?

The QDC prefers output configurations of type xxx0 in respect of those like xxxf

Homework: which is the simplest way to fix this problem in the data? At which cost? Can you understand the module name?

Module: 4c6543726f79204c31313832



# 2<sup>nd</sup> experiment



# Position measurement



- We want to measure the position of particle with a wire chamber
- The ionization electrons created by the passage of the particle will take a time  $\Delta t$  to reach the anode wire
- Transit time is normally negligible with respect to  $\Delta t$
- If we consider a constant drift speed  $v_D$  ( $50\mu\text{m/ns}$ ), then position is:

$$x = v_D \cdot \Delta t$$

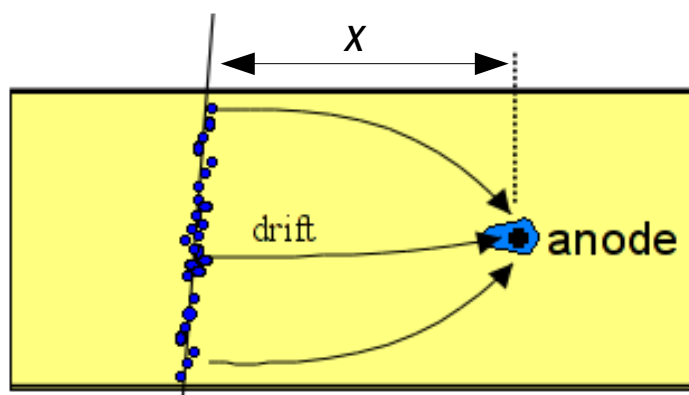



# Triggering

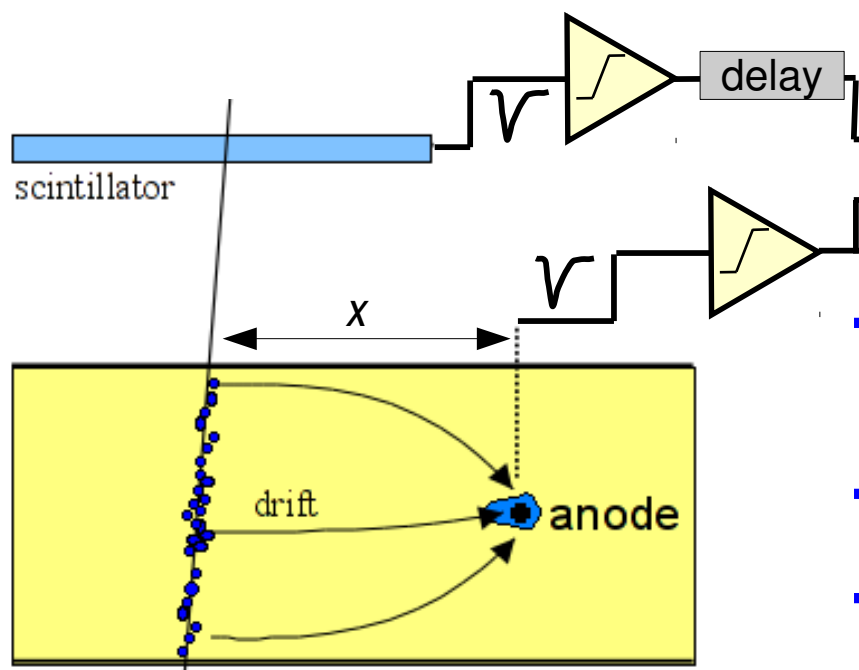

→ The wire chamber alone is not sufficient however

→ We need a triggering system

→ Therefore we will measure a relative time  $\Delta t + t_0 = t^*$

- $t_0$  accounts for the time delays, offsets, ... between the wire chamber and the triggering system

$$x = \alpha t^* + \beta$$



# Time measurement

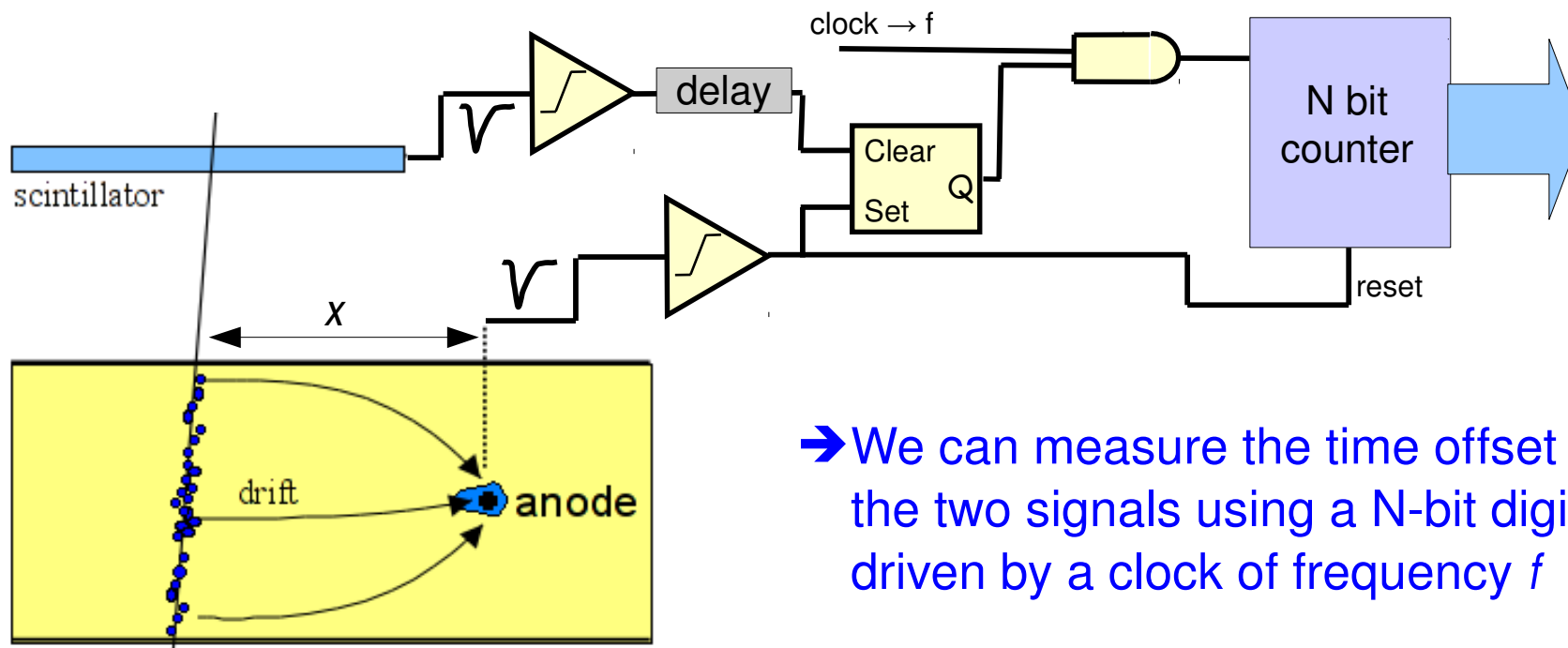

- We can measure the time offset between the two signals using a N-bit digital counter driven by a clock of frequency  $f$
- The wire signal acts as a start signal
- The trigger provides the stop signal



# Time measurement → TDC

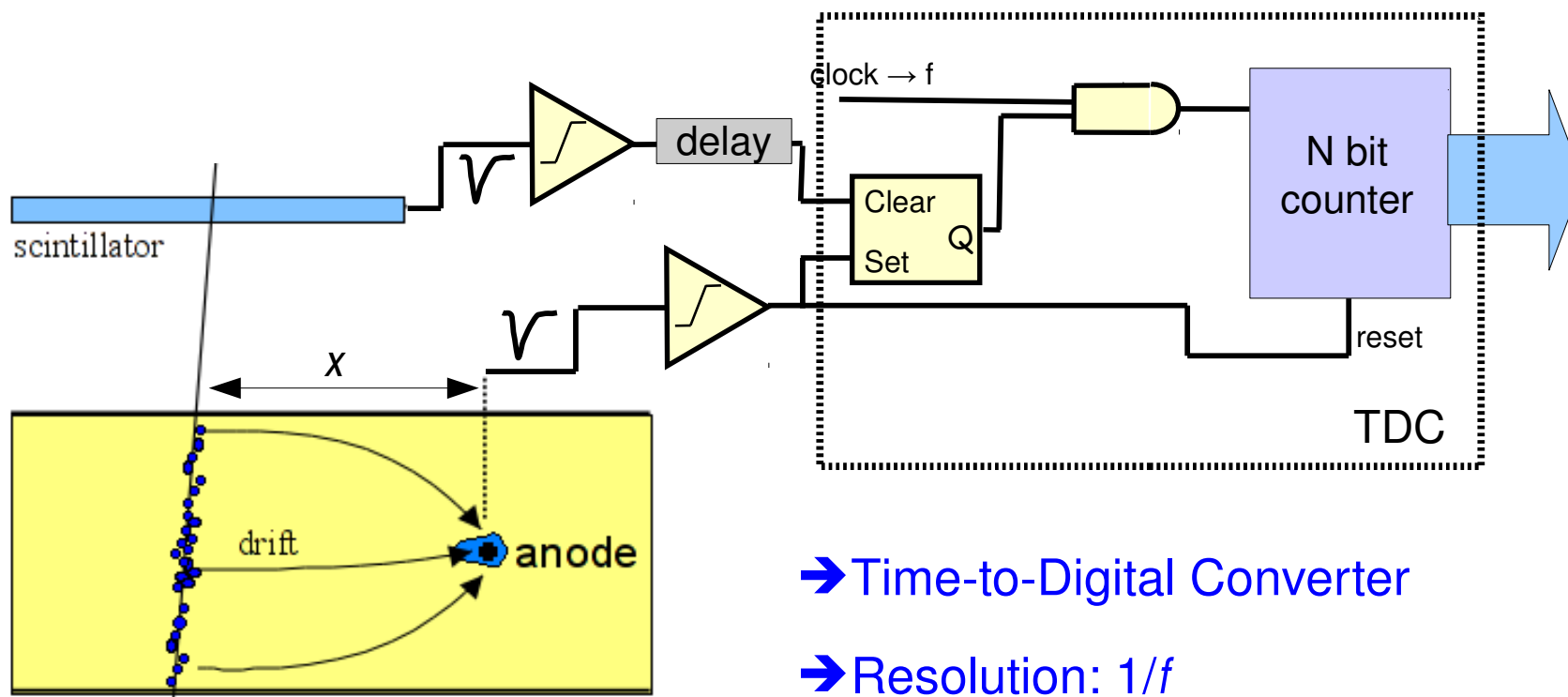

→ Time-to-Digital Converter

→ Resolution:  $1/f$

→ Dynamic range: N

→ Single hit TDC

- e.g. a noise spikes comes just before the signal → measure is lost



# Multi-hit TDC

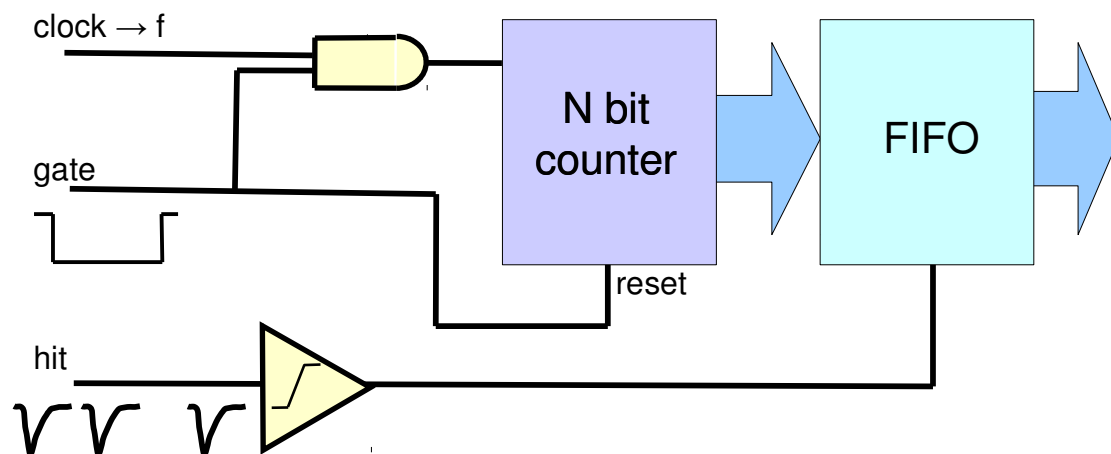

- Gate resets and starts the counter. It also provides the measurement period. It must be smaller than  $2^N/f$
- Each “hit” (i.e. signal) forces the FIFO to load the current value of the counter, that is the delay after the gate start
  - In order to distinguish between hits belonging to different gates, some additional logic is need to tag the data
- Common-start configuration





# Actual TDCs

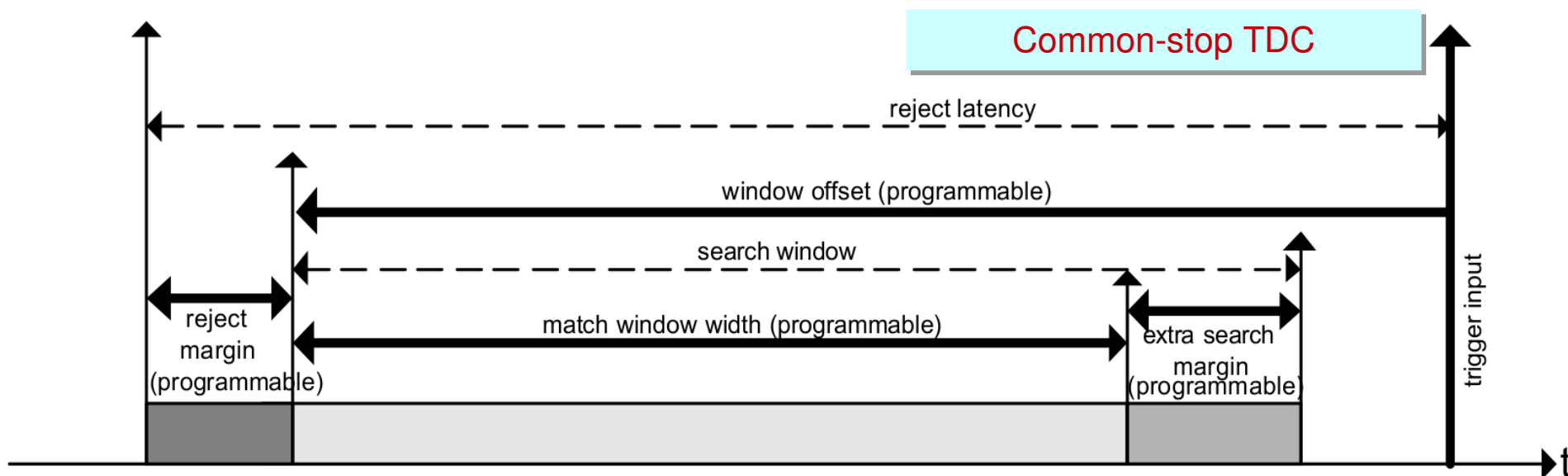

→ Real TDCs provide advanced functionalities for fine-tuning the hit-trigger matching

- Internal programmable delays
- Internal generation of programmable gates
- Programmable rejection frames

Can you imagine/sketch a common stop setup?



# Real life wire chamber & TDC

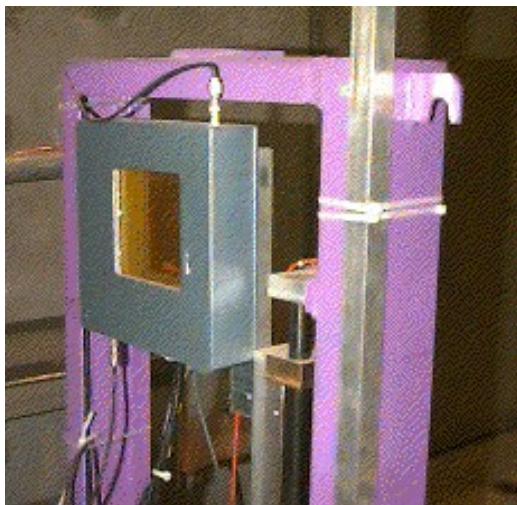

- XDWC: delay wire chambers used on the SPS extracted lines to measure beam profiles
- Two cathode planes provide X and Y positions
- Measurement is based on the delay gained along a delay line

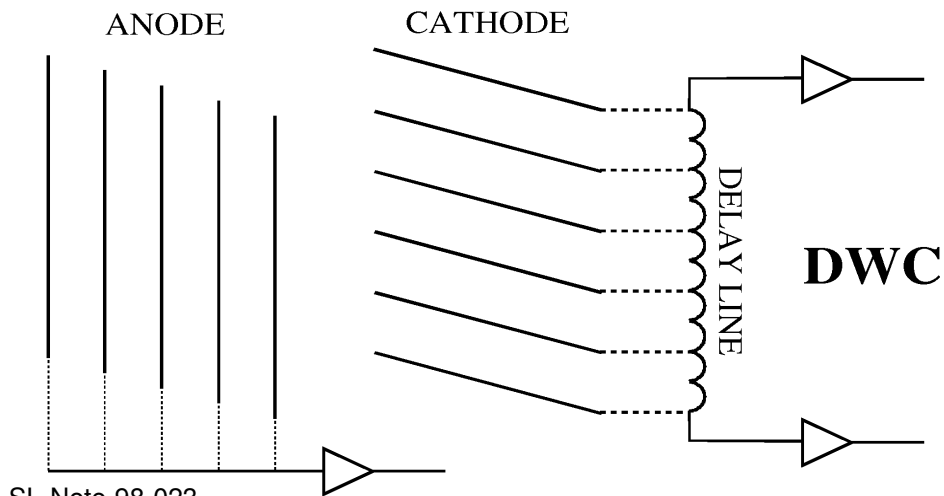

SL-Note-98-023



# Principle

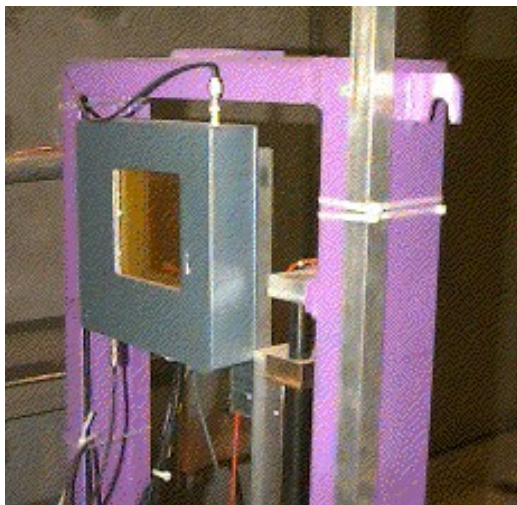

- XDWC: delay wire chambers used on the SPS extracted lines to measure beam profiles
- Two cathode planes provide X and Y positions
- Measurement is based on the delay gained along a delay line

$$y = a \cdot \Delta t + \beta = a \cdot (t_{top} - t_{bottom}) + \beta$$

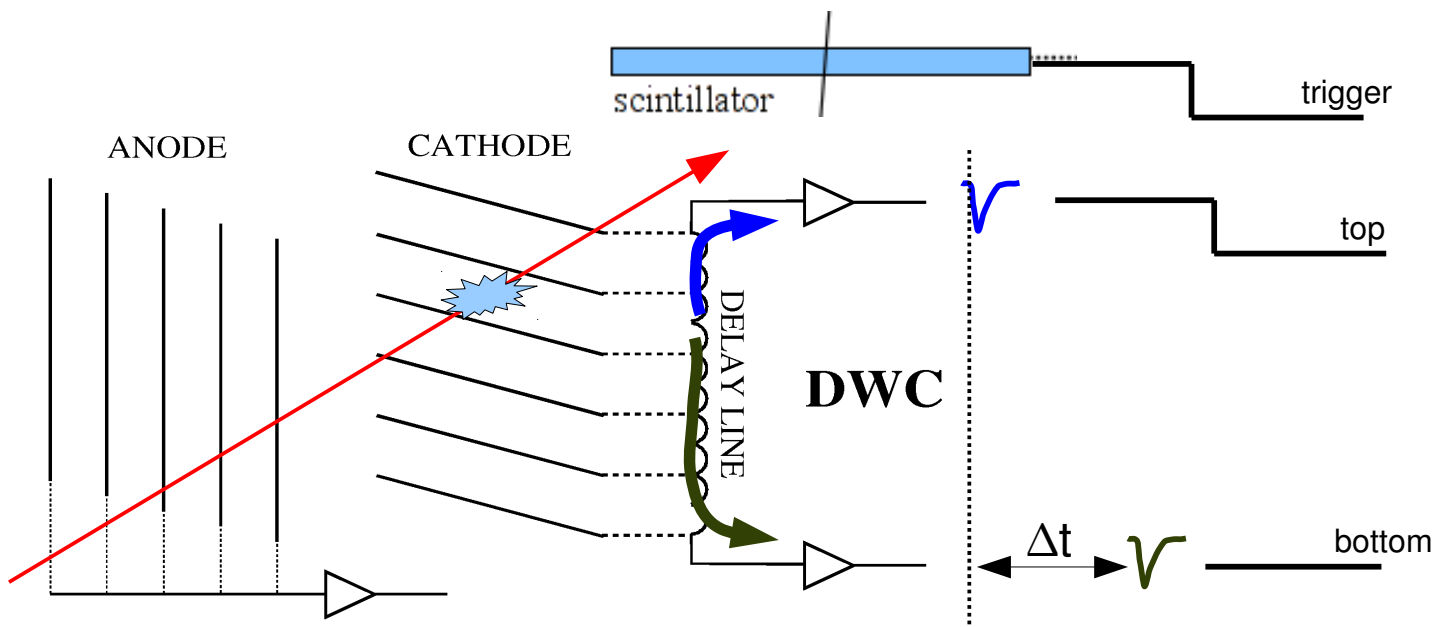



# Raw time data



RUN997 - TDC

tdc_dwc_dw_u	
Entries	4105
Mean	79.38
RMS	24.2

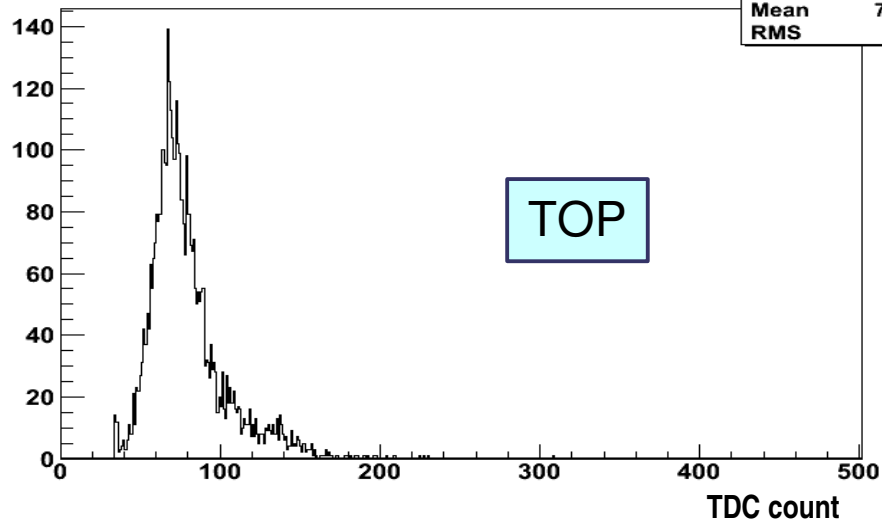

RUN997 - TDC

tdc_dwc_dw_d	
Entries	4840
Mean	118.9
RMS	22.32

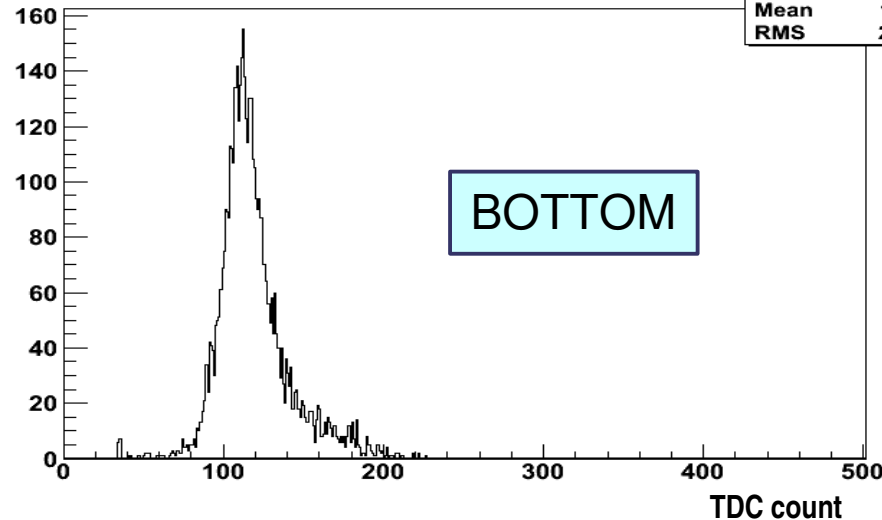

Individual channel distributions

RUN997 - TDC

tdc_dwc_dw_l	
Entries	4828
Mean	113.1
RMS	23.42

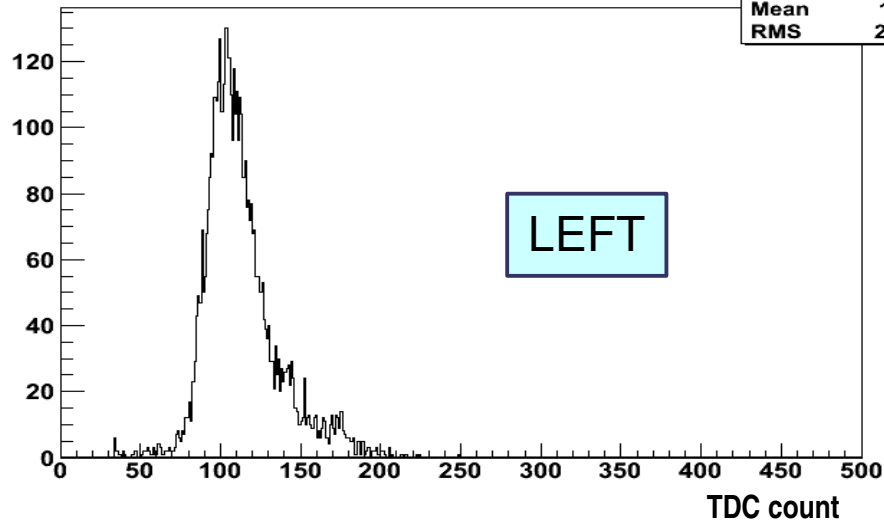

RUN997 - TDC

tdc_dwc_dw_r	
Entries	4850
Mean	88.4
RMS	22.86

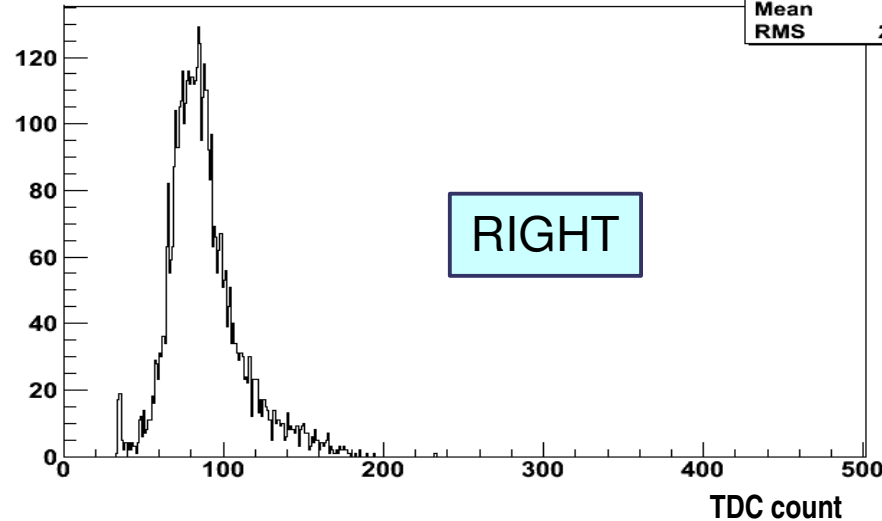



# (Uncalibrated) Beam Profile



RUN997 - DWC DW U-D

TOP-BOTTOM

tdc_dwc_dw_ud	
Entries	4094
Mean	-39.79
RMS	21.64

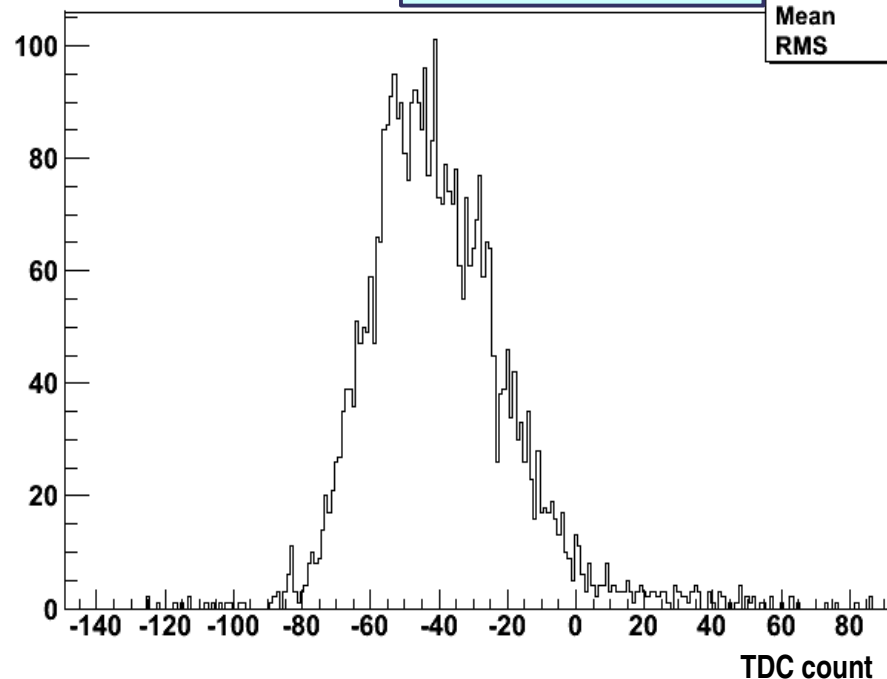

RUN997 - DWC DW L-R

RIGHT-LEFT

tdc_dwc_dw_lr	
Entries	4827
Mean	24.76
RMS	23.13

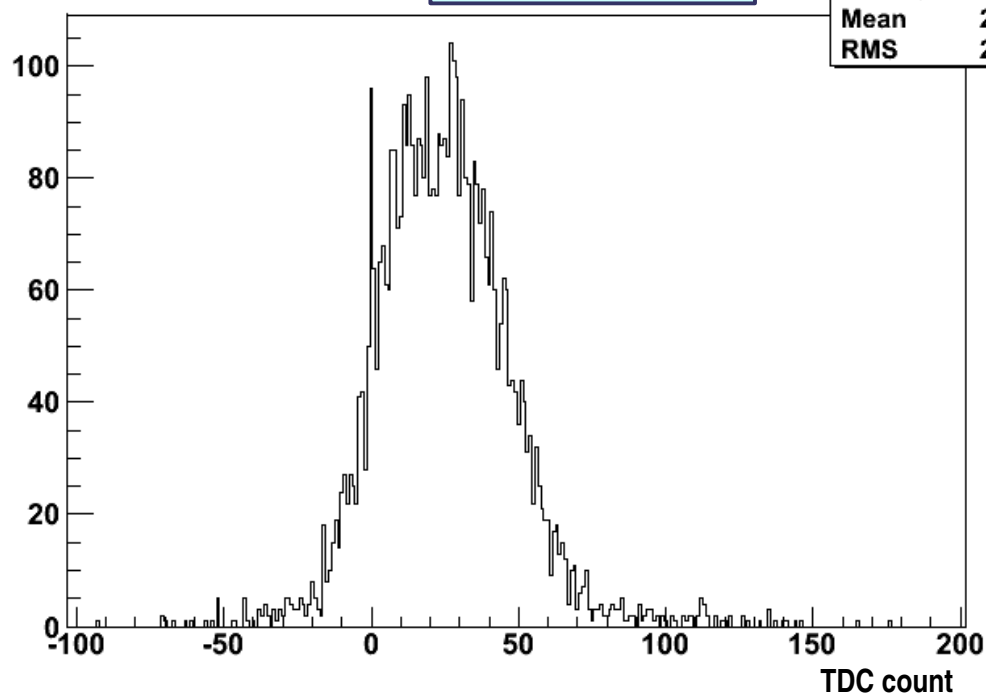

→ Beam sizes are still in TDC counts

- Not very useful, though

→ How do we convert this into a known scale (e.g. cm)?



# Corollary: calibration



→ Both the experiments we discussed provide relative measurements. The values obtained via our system are in some (known) relation with the interesting quantity

- Scintillator

$$Q \propto N_{\gamma} \propto E$$

- XDWC

$$y = \alpha \cdot \Delta t + \beta = \alpha \cdot (t_{top} - t_{bottom}) + \beta$$

→ Our instruments need to be **calibrated** in order to give us the answer we are looking for

- We have to determine the parameters that transform the raw data into a physics quantity
- The parameters normally depend on the experimental setup (e.g. cable length, delay settings, HV settings, ... )

→ In the design of our detector and DAQ we have to foreseen calibration mechanisms/procedures



# Ge crystal for isotope identification

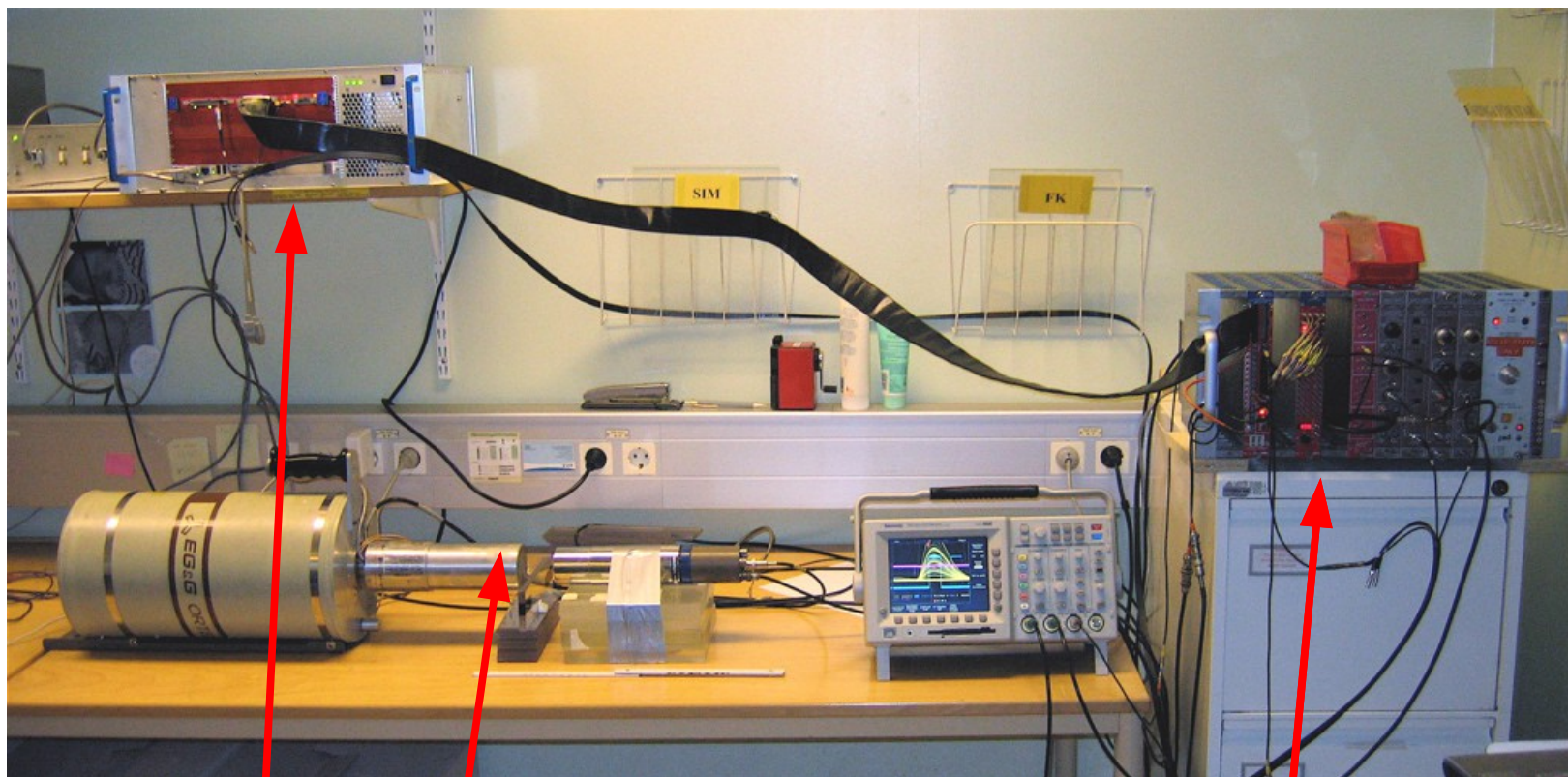

Crystal HPGe

Readout (ADC)

Trigger & front-end





# Crystal calibration

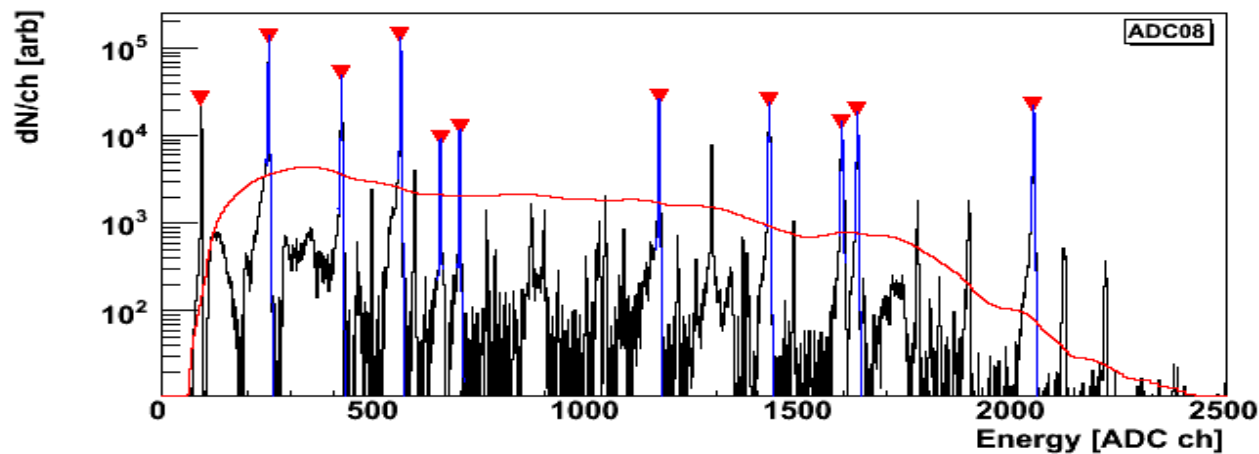

→ <sup>152</sup>Europium reference source

- Known  $\gamma$  emission lines
- Peak find & fit

→ Allow for definition of the parameters describing functional relation between ADC count and  $E$

$$Q \propto N_{\gamma} \propto E$$

→ Reality is not perfectly linear

- Polynomial fits
- Physical models

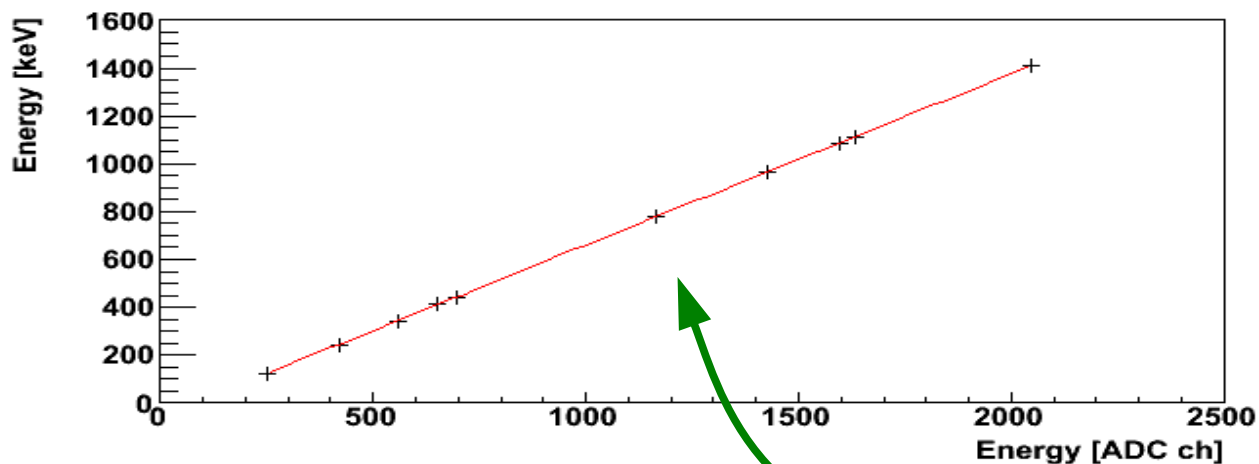



# Isotope identification

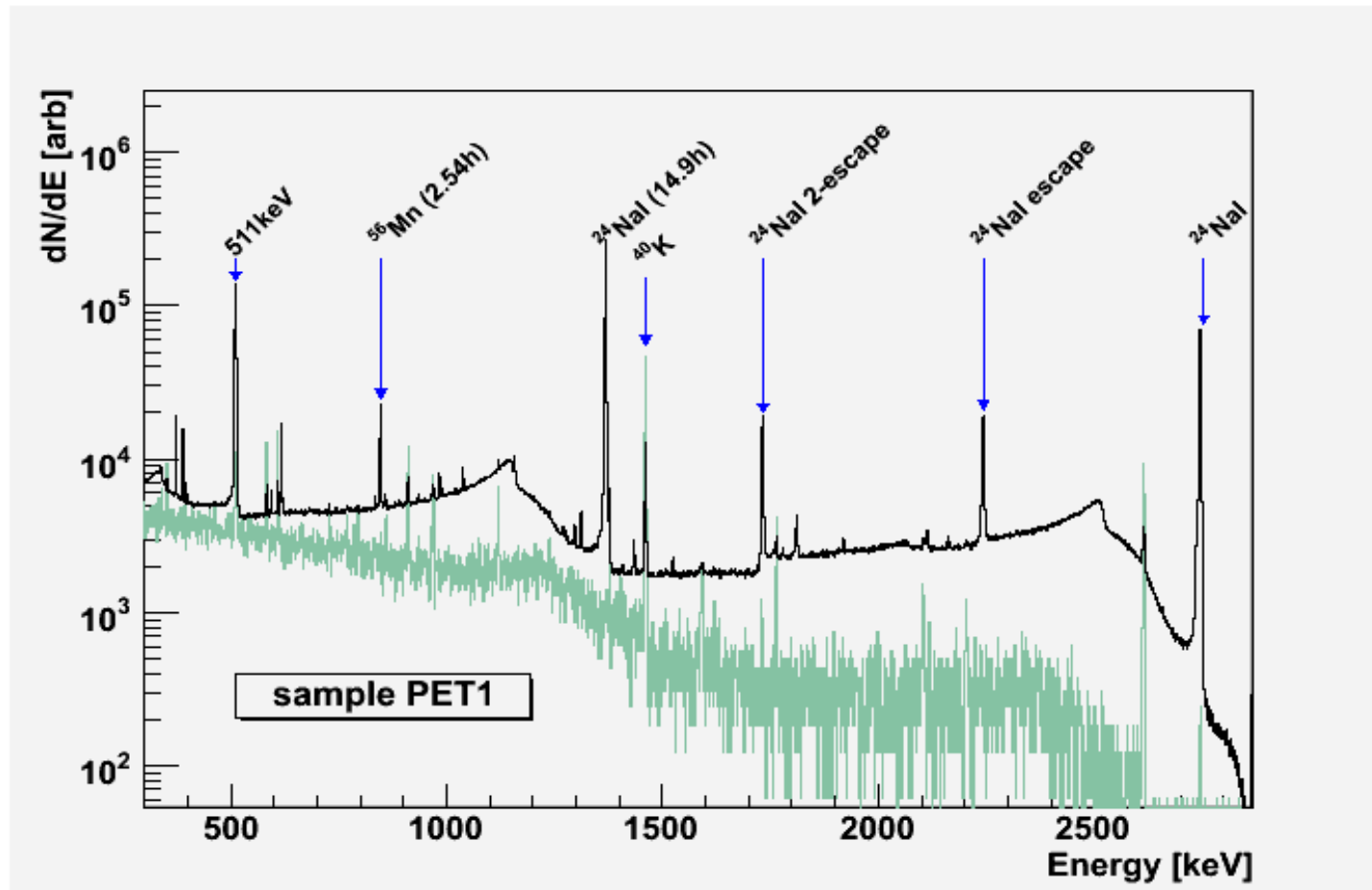

Calibrate crystal setup can be used to identify isotopes generated in  $\gamma$ -irradiated samples



# XDWC Calibration



- XDWC chamber have 3 calibration inputs that allow for independent calibrations of X and Y axis with only 3 different sets of data
- The calibration input simulate signals from particles respectively hitting
  - Right-top corner (X=Y=30mm)
  - Center (X=Y=0mm)
  - Left-bottom corner (X=Y=-30mm)
- The calibration data sets shall be taken with final setup and TDC
- Interpolating the three points in the  $t$ - $x$  space, the parameters of the calibration equation can be measured

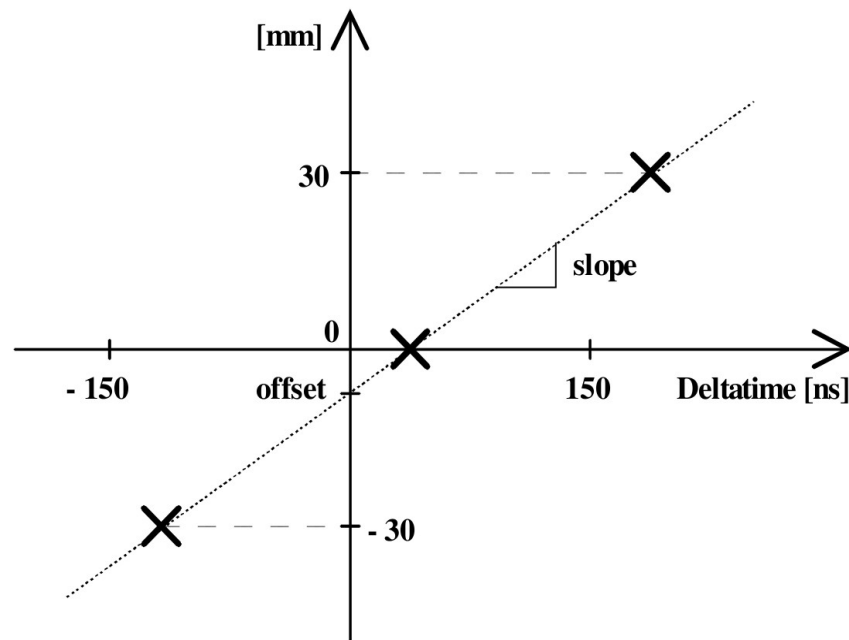

$$x = \alpha t^* + \beta$$



# Calibrated XDWC



RUN997 - X\_DW

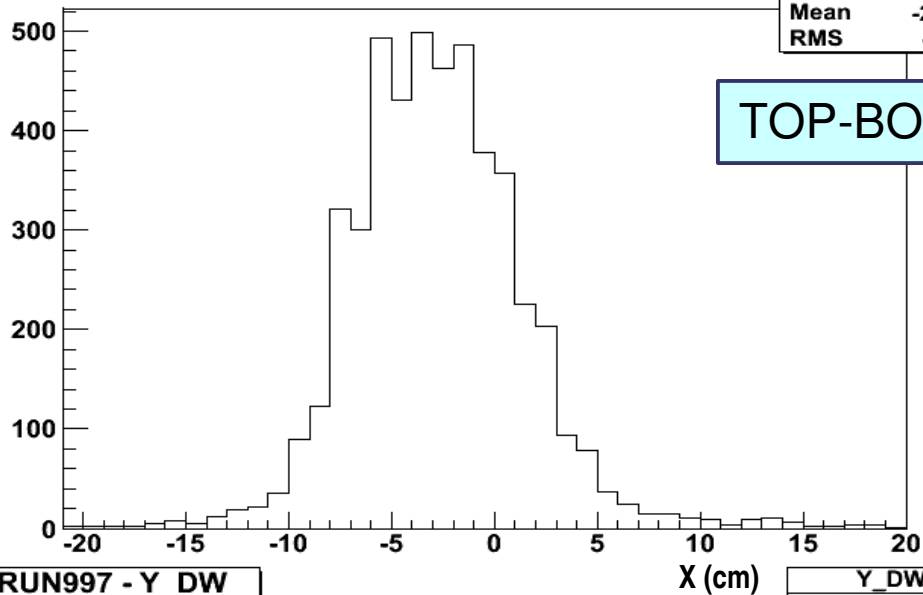

TOP-BOTTOM

Beam profile

RUN997 - Y\_DW vs X\_DW

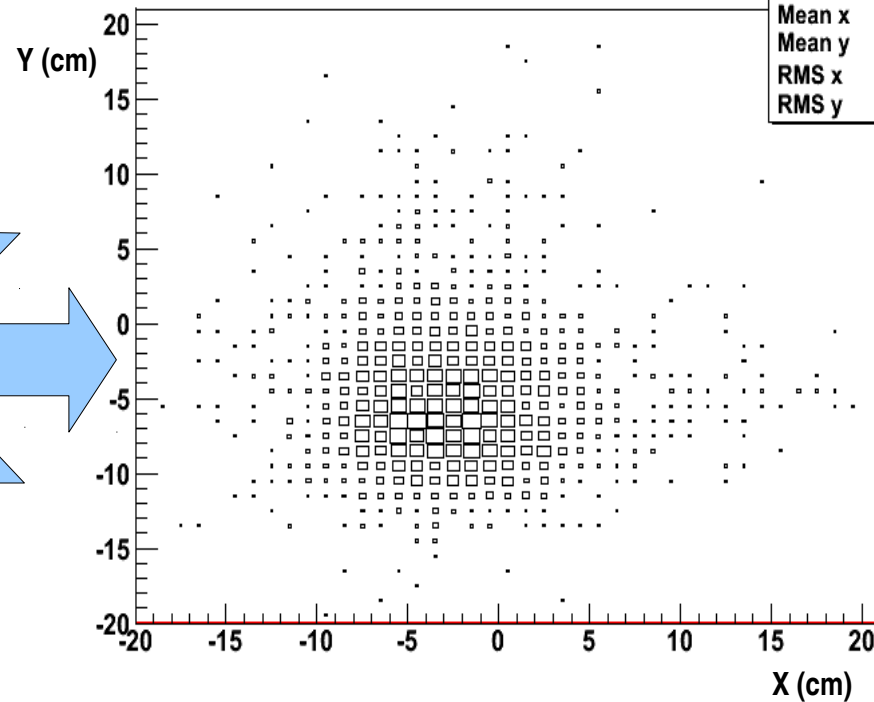

RUN997 - Y\_DW

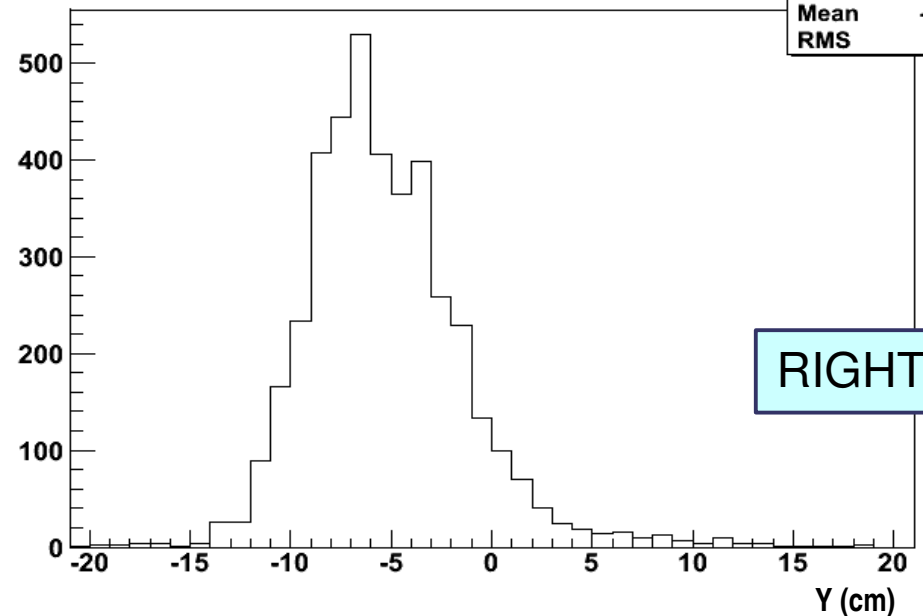

RIGHT-LEFT



# Wrap-up



- Digitization techniques produce data directly manageable by digital systems (e.g. a computer)
  - Greatly simplifies the down-stream data-handling
  - Root of every modern DAQ system
  - Available on a variety of platforms: VME, PCI, USB, ...
- Open the “black box” and see where the numbers come from
  - Real electronics does not behave as the ideal one
- Trade-offs between speed/precision/cost exist
  - You have to choose the solution that best suits you
- Physics quantities are derived from the raw data via calibration
  - Calibration procedures have to be foreseen for your detector and DAQ

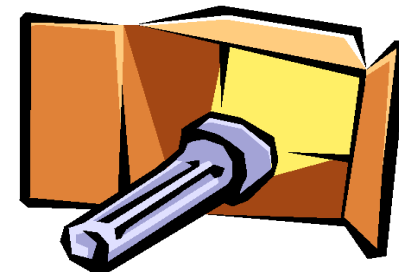



UNIVERSITY  
OF  
JOHANNESBURG



# Bonus



# Example – NA59 Drift Chambers



- ➔ More complex, precise detectors need more sophisticated calibration
- ➔ Calibrate both “detector behavior” and “DAQ behavior” (eg TDC), sometimes at once.

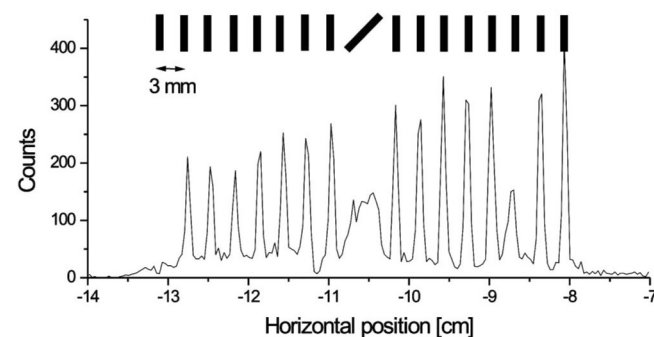
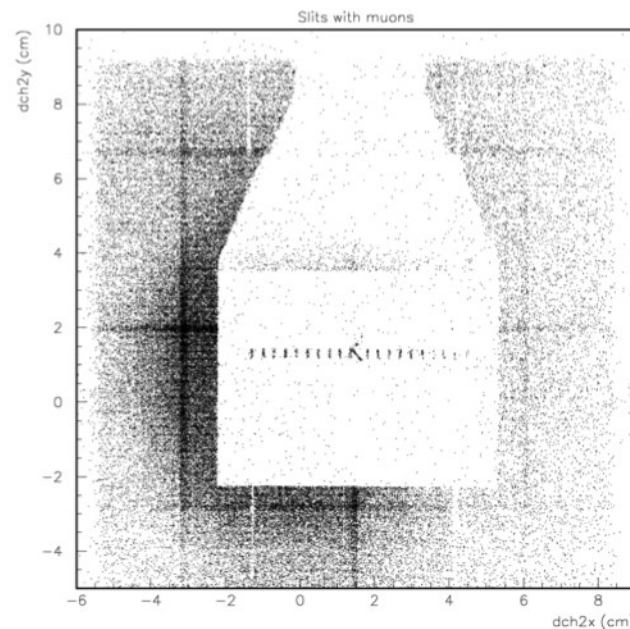
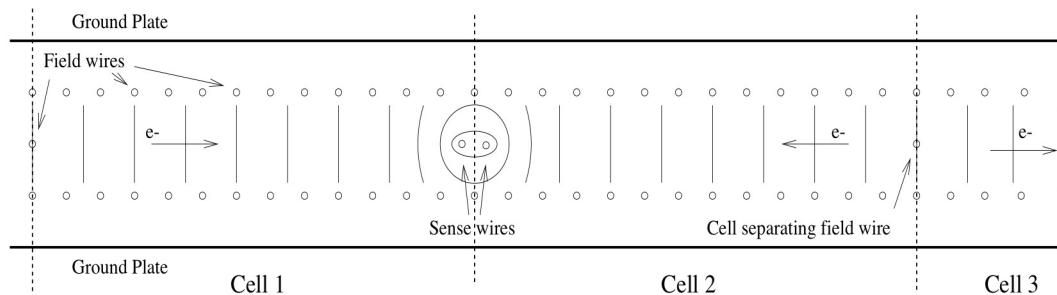
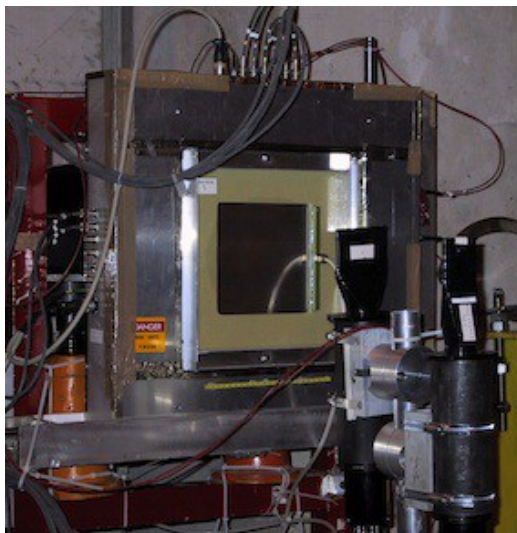

FIG. 4. Calibration data for drift chamber 4. The “comb” is due to slits in the veto (Slit1) combined with hits in the corresponding counter (Hit1) as indicated in the upper part of the figure.



# A word on front-end electronics



## Advanced FE

## Complex FE

