

Nonlinear extension of the CCFM equation

Krzysztof Kutak

Instytut Fizyki Jądrowej im. H. Niewodniczańskiego
Radzikowskiego 152, 31-342 Krakow, Poland

DOI: <http://dx.doi.org/10.3204/DESY-PROC-2012-02/54>

Motivated by the regime of QCD explored nowadays at LHC, where both the total energy of collision and momenta transfers are high, evolution equations of high energy factorization are investigated. In order to study such effects like parton saturation in final states one is inevitably led to investigate how to combine physics of the BK and CCFM evolution equations. We report on recently obtained resummed form of the BK equation and nonlinear extension of the CCFM equation.

1 Introduction

The Large Hadron Collider (LHC) is already operational and Quantum Chromodynamics (QCD) is the basic theory which is used to set up the initial conditions for the collisions at the LHC as well as to calculate hadronic observables. The application of perturbative QCD relies on factorization theorems which allow to decompose a given process into a long distance part, called parton density, and a short distance part, called matrix element. Here we will focus on high energy factorization [1, 2]. The evolution equations of high energy factorization sum up logarithms of energy accompanied by a strong coupling constant, i.e. terms proportional to $\alpha_s^n \ln^m s/s_0$, which applies when the total energy of a scattering process is much bigger than any other hard scale involved in a process.

Until now, in principle, the BFKL, BK [3–5] and CCFM [6–8] evolution equations were used on equal footing since the energy ranges did not allow to discriminate between these frameworks. However, there were indications already at HERA [9] for the need to account for nonlinear effects in gluon density. These observations are supported by recent results obtained in [10, 12]. On top of this, the results from [13] point at the need to use the framework which incorporates hardness of the collision into BFKL like description. With the LHC one entered into a region of phase space where both the energy and momentum transfers are high and formed systems of partons dense. Recently a framework has been provided in [14] where both dense systems and hard processes at high energies can be studied.

2 Exclusive form of the Balitsky-Kovchegov equation

At the leading order in $\ln 1/x$ the Balitsky-Kovchegov equation for the dipole amplitude in the momentum space is written as an integral equation reads [14]:

$$\begin{aligned} \Phi(x, k^2) = & \Phi_0(x, k^2) \\ & + \bar{\alpha}_s \int_x^1 \frac{dz}{z} \int_0^\infty \frac{dl^2}{l^2} \left[\frac{l^2 \Phi(x/z, l^2) - k^2 \Phi(x/z, k^2)}{|k^2 - l^2|} + \frac{k^2 \Phi(x/z, k)}{\sqrt{(4l^4 + k^4)}} \right] \\ & - \bar{\alpha}_s \int_x^1 \frac{dz}{z} \Phi^2(x/z, k) \end{aligned} \quad (1)$$

where the lengths of transverse vectors lying in transversal plane to the collision axis are $k \equiv |\mathbf{k}|$, $l \equiv |\mathbf{l}|$ (\mathbf{k} is a vector sum of transversal momenta of emitted gluons during evolution), $z = x/x'$ (see Fig. (1)), $\bar{\alpha}_s = N_c \alpha_s / \pi$. The linear term in eq. (1) can be linked to the process of creation of gluons while the nonlinear term can be linked to fusion of gluons and therefore introduces gluon saturation effects.

The unintegrated gluon density obeying the high energy factorization theorem [1] is obtained from [18, 19]:

$$\mathcal{F}_{BK}(x, k^2) = \frac{N_c}{\alpha_s \pi^2} k^2 \nabla_k^2 \Phi(x, k^2) \quad (2)$$

where the angle independent Laplace operator is given by $\nabla_k^2 = 4 \frac{\partial}{\partial k^2} k^2 \frac{\partial}{\partial k^2}$. As explained in [14] this equation can be rewritten in a resummed form:

$$\begin{aligned} \Phi(x, k^2) = & \tilde{\Phi}^0(x, k^2) \\ & + \bar{\alpha}_s \int_x^1 dz \int \frac{d^2 \mathbf{q}}{\pi q^2} \theta(q^2 - \mu^2) \frac{\Delta_R(z, k, \mu)}{z} \left[\Phi\left(\frac{x}{z}, |\mathbf{k} + \mathbf{q}|^2\right) - q^2 \delta(q^2 - k^2) \Phi^2\left(\frac{x}{z}, q^2\right) \right]. \end{aligned} \quad (3)$$

where $\mathbf{q} = \mathbf{l} - \mathbf{k}$ and $\Delta_R(z, k, \mu) \equiv \exp\left(-\bar{\alpha}_s \ln \frac{1}{z} \ln \frac{k^2}{\mu^2}\right)$ is a Regge form factor.

Eq. (3) is a new form of the BK equation in which the resummed terms in a form of Regge form factor are the same for the linear and nonlinear part. This form will serve as a guiding equation to generalize the CCFM equation to include nonlinear effects which allow for recombination of partons with constraint on angle of emission.

2.1 Nonlinear extension of the CCFM equation

As it has already been stated the motivation to extend the CCFM to account for nonlinearity is to be able to study the impact of saturation of partons on exclusive observables. There are indications [15, 23] that such effects might be significant in for instance production of charged particles at HERA or in forward production of di-jets [10, 11].

The nonlinear extension of CCFM has been recently proposed in [14] and its extension changes the interpretation of the quantity for which the equation is written. It is not longer high energy factorizable gluon density but should be interpreted as the dipole amplitude in momentum space Φ , denoted from now on by \mathcal{E} , which besides x and k^2 depends also on a hard scale p . The peculiar structure of the nonlinear term of the equation written below is motivated by the following requirements:

- the second argument of the \mathcal{E} should be k^2 as motivated by the analogy to BK

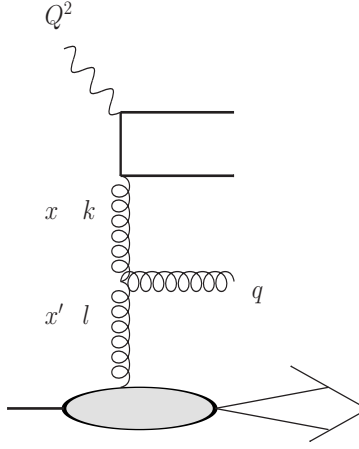

Figure 1: Plot explaining meaning of variables in BK and CCFM evolution equations.

- the third argument should reflect locally the angular ordering

$$\begin{aligned}
\mathcal{E}(x, k^2, p) &= \mathcal{E}_0(x, k^2, p) \\
&+ \bar{\alpha}_s \int_x^1 dz \int \frac{d^2 \bar{\mathbf{q}}}{\pi \bar{q}^2} \theta(p - z\bar{q}) \Delta_s(p, z\bar{q}) \left(\frac{\Delta_{ns}(z, k, q)}{z} + \frac{1}{1-z} \right) \left[\mathcal{E} \left(\frac{x}{z}, k'^2, \bar{q} \right) \right. \\
&\left. - \bar{q}^2 \delta(\bar{q}^2 - k^2) \mathcal{E}^2 \left(\frac{x}{z}, \bar{q}^2, \bar{q} \right) \right].
\end{aligned} \tag{4}$$

The momentum vector associated with i -th emitted gluon is

$$q_i = \alpha_i p_P + \beta_i p_e + q_{ti} \tag{5}$$

The variable p in (4) is defined via $\bar{\xi} = p^2/(x^2 s)$ where $\frac{1}{2} \ln(\bar{\xi})$ is a maximal rapidity which is determined by the kinematics of hard scattering, \sqrt{s} is the total energy of the collision and $k' = |\mathbf{k} + (1-z)\bar{\mathbf{q}}|$. The momentum $\bar{\mathbf{q}}$ is the transverse rescaled momentum of the real gluon, and is related to \mathbf{q} by $\bar{\mathbf{q}} = \mathbf{q}/(1-z)$ and $\bar{q} \equiv |\bar{\mathbf{q}}|$.

The form factor Δ_s screens the $1-z$ singularity while form factor Δ_{ns} screens the $1/z$ singularity, in a similar form as the Regge form factor but also accounts for angular ordering:

$$\Delta_{ns}(z, k, q) = \exp \left(-\alpha_s \ln \frac{1}{z} \ln \frac{k^2}{zq^2} \right). \tag{6}$$

where for the lowest value of zq^2 we use a cut off μ .

Similarly as in case of the BK equation in order to obtain high energy factorizable unintegrated gluon density one applies relation (2). The nonlinear term in (4), apart from allowing for recombination of gluons might be understood as a way to introduce the decoherence into the emission pattern of gluons. This is because the gluon density is build up due to coherent gluon emission and since the nonlinear term comes with the negative sign it slows down the

growth of gluon density and therefore it introduces the decoherence. We expect the nonlinear term to be of main importance at low x similarly as in case of the BK equation. In this limit it will be of special interest to check whether in this formulation of the nonlinear extension of the CCFM equation one obtains an effect of saturation of the saturation scale as observed in [17]. This effect is of great importance since it has a consequences for example for imposing a bound on amount of production of entropy from saturated part of gluon density as observed in [24].

3 Conclusions and outlook

We reported on recently obtained new form of the BK equation written in a resummed form and on extension of CCFM to account for nonlinearity. The obtained extension of CCFM will be useful for studies of impact saturation of gluons on exclusive observables.

Acknowledgements

I would like to thank organizers of DIS 2012 and in particular Dimitri Colferai for inviting me to give a talk. This research has been supported by grant LIDER/02/35/L-2/10/NCBiR/2011

References

- [1] S. Catani, M. Ciafaloni, F. Hautmann, Nucl. Phys. **B366** (1991) 135-188.
- [2] L. V. Gribov, E. M. Levin and M. G. Ryskin, Phys. Rept. **100** (1983) 1.
- [3] I. Balitsky, Nucl. Phys. B **463** (1996) 99.
- [4] Y. V. Kovchegov, Phys. Rev. D **60** (1999) 034008.
- [5] Y. V. Kovchegov, Phys. Rev. D **61** (2000) 074018.
- [6] M. Ciafaloni, Nucl. Phys. B **296**, 49 (1988).
- [7] S. Catani, F. Fiorani and G. Marchesini, Nucl. Phys. B **336**, 18 (1990).
- [8] S. Catani, F. Fiorani and G. Marchesini, Phys. Lett. B **234**, 339 (1990).
- [9] A. M. Stasto, K. J. Golec-Biernat, J. Kwiecinski, Phys. Rev. Lett. **86** (2001) 596-599.
- [10] J. L. Albacete, C. Marquet, Phys. Rev. Lett. **105** (2010) 162301.
- [11] K. Kutak and S. Sapeta, arXiv:1205.5035 [hep-ph].
- [12] A. Dumitru, K. Dusling, F. Gelis *et al.*, Phys. Lett. **B697** (2011) 21-25.
- [13] M. Deak, F. Hautmann, H. Jung, K. Kutak, [arXiv:1012.6037].
- [14] K. Kutak, K. Golec-Biernat, S. Jadach and M. Skrzypek, JHEP **1202** (2012) 117.
- [15] K. Kutak, H. Jung, Acta Phys. Polon. **B40** (2009) 2063-2070.
- [16] E. Avsar and E. Iancu, Nucl. Phys. A **829** (2009) 31.
- [17] E. Avsar and A. M. Stasto, JHEP **1006** (2010) 112.
- [18] M. Braun, Eur. Phys. J. C **16**, 337 (2000).
- [19] K. Kutak and J. Kwiecinski, Eur. Phys. J. C **29** (2003) 521.
- [20] J. Bartels, M. Wusthoff, Z. Phys. **C66** (1995) 157-180.
- [21] J. Bartels, K. Kutak, Eur. Phys. J. **C53** (2008) 533-548.
- [22] J. Kwiecinski, A. D. Martin and P. J. Sutton, Phys. Rev. D **52** (1995) 1445.
- [23] C. Adloff *et al.* [H1 Collaboration], Nucl. Phys. **B485** (1997) 3-24.
- [24] K. Kutak, Phys. Lett. B **705** (2011) 217.