



Enabling Grids for E-science

AMGA Metadata Service

Gergely Sipos

www.eu-egee.org



- **This presentation primarily consists in slides from:**
 - Tony Calanducci
 - Third EELA Tutorial for Managers and Users
 - Rio de Janeiro, 26-30 June 2006
 - Nuno Santos, Birger Koblitz
 - 20 June 2006
 - Workshop on Next-Generation Distributed Data Management
 - Patricia Méndez Lorenzo: UNOSAT application using AMGA
 - User Forum
 - CERN, 1st March 2006
 - <http://indico.cern.ch/materialDisplay.py?contribId=23&sessionId=11&materialId=slides&confId=286>
 - **Further information on EGEE events:**
<http://www.egee.nesc.ac.uk/schedreg/index.cfm>

- **Background and Motivation for AMGA**
- **Examples**
- **Interface, Architecture and Implementation**
- **Metadata Replication on AMGA**
- **Further information**

- Metadata is **data about data**
- On the EGEE Grid: **information about files**
 - Describes files
 - Locate files based on their metadata
- You many have **1000's of files, being shared with other researchers**
 - Either:
 - You all access data by remembering lfns (or guids...)
 - .. And hope you know what is in the file...
 - Or
 - Have a metadata catalogue
 - Allow selection of files based on metadata
- **Metadata is fundamental to e-research**

- **AMGA – ARDA Metadata Grid Application**
 - ARDA: A Realisation of Distributed Analysis for LHC
 - Hundreds of millions of files
 - No special security requirements
 - Protection against DoS attacks
- **Now part of gLite middleware**
 - Official Metadata Service for EGEE
 - Also available as standalone component
- **Expanding user community**
 - HEP, Biomed, UNOSAT...
 - More on this later

A set of entries.
Entries: The objects (e.g. files) that need to be described with metadata

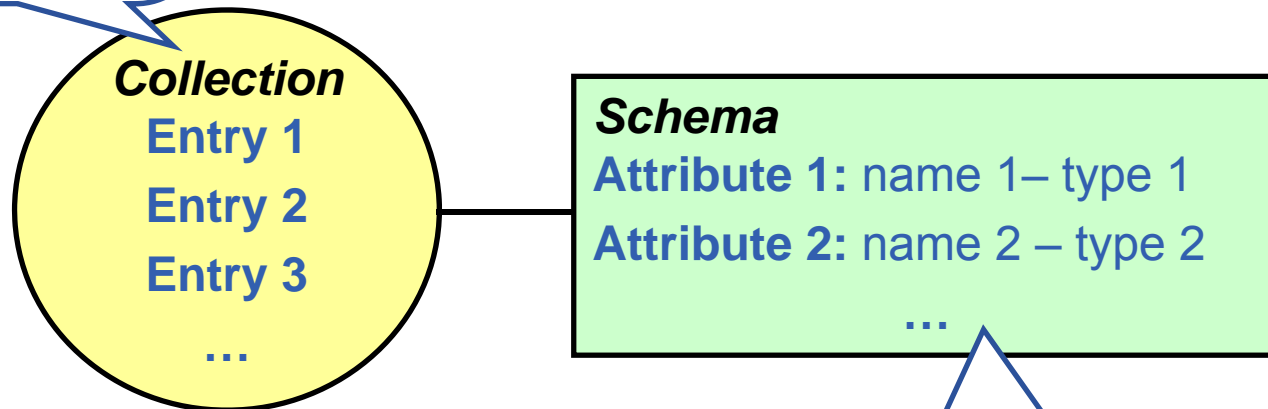

Collection

Entry 1

Entry 2

Entry 3

...

Schema

Attribute 1: name 1 – type 1

Attribute 2: name 2 – type 2

...

Schema: a set of attributes.
Defines the structure of the metadata

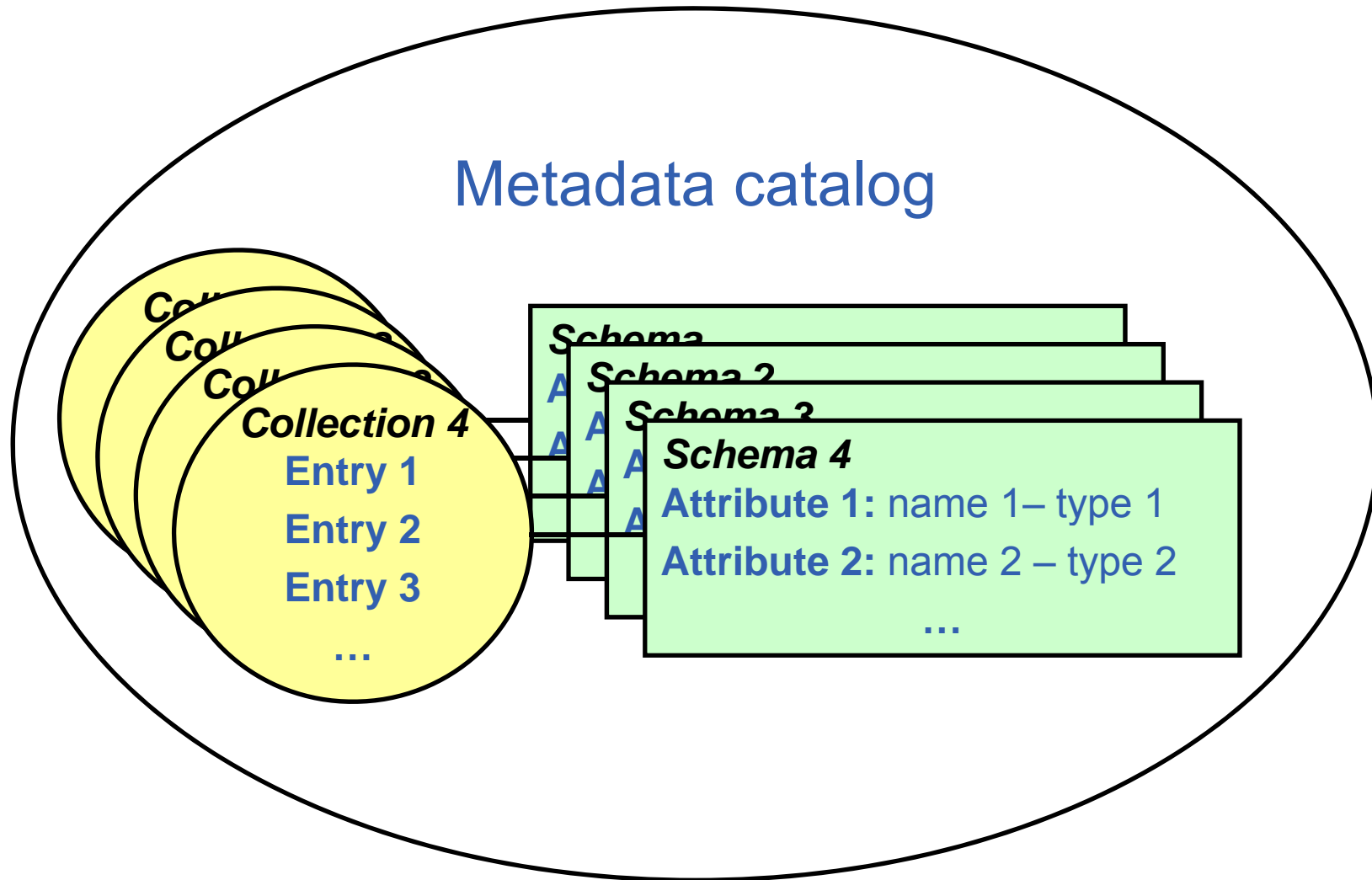

- **Some Concepts**

- **Metadata** - List of attributes associated with **entries**
- **Attribute** – name/value pair with type information
 - **Type** – The type (int, float, string,...)
 - **Name** – The name of the attribute
 - **Value** - Value of an entry's attribute
- **Schema** – A set of attributes
- **Collection** – A set of entries associated with a schema
- Think of schemas as tables, attributes as columns, entries as rows

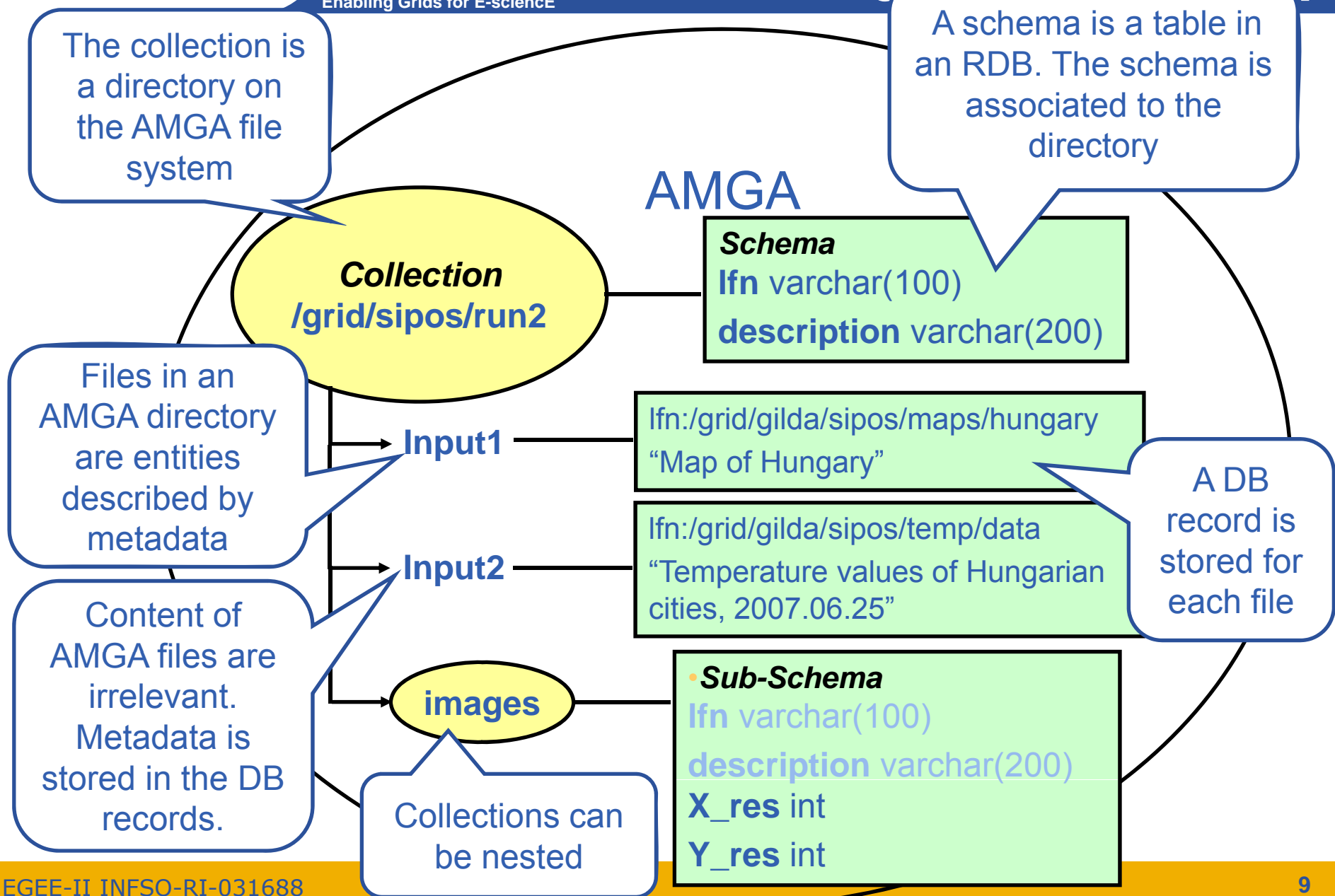

- **gLibrary**
 - Files are saved on SEs and registered into LFC file catalogues
 - The AMGA Metadata Catalogue is used to archive and organize metadata and to answer users' queries.
- **LHCb-bookkeeping**
 - Migrated bookkeeping metadata to ARDA prototype
 - 20M entries, 15 GB
 - Large amount of static metadata
 - Feedback valuable in improving interface and fixing bugs
 - AMGA showing good scalability
- **Ganga**
 - Job management system
 - Developed jointly by Atlas and LHCb
 - Uses AMGA for storing information about job status
 - Schema is flexible – store whatever you want in the DB table!
 - Small amount of highly dynamic metadata

- **gLibrary is built using the following AMGA collections:**
 - /gLibrary contains generic metadata for each entry
 - /gLAudio, /gLImage, /gLVideo, /gLPPT, /EGEEPPT, /gLDoc, ... are examples of collections of “additional features” (shown later)
 - /gLTypes
 - keeps the associations between document types and the names of the collection that contains the “additional features”
 - is used by gLibrary to find out where it has to look when new document types are added into the system (extensibility)
 - /gLKeys is used to store Decryption Keys

Collection		/gLibrary		
Entry Names	Attributes			
	FileName	PathName	Type	Submitter
4ffaafc8-26e7-4826-b460-3d5bf08081a4	DedicatoAte.mp3	lfn:/grid/gilda/calanducci	Audio	Tony Calanducci
00454dca-a269-4b93-8a45-c4012af05600	ardizca_is_231005.ppt.gpg	lfn:/grid/gilda/calan/EGEE	EGEEDOC	Tony Calanducci

/gLibrary (continuum)

Attributes				
SubmissionDate	Encryption	Description	Keywords	CreationDate
2006-01-05 00:00:00	false	Canzone delle vibrazioni che ha ricevuto un enorme successo tra i teenagers nel 2003	Vibrazioni	2004-02-05 00:00:00
2005-01-05 16:44:22	true	gLite Information System	R-GMA, RGMA, BDII, IS	2005-10-05 23:40

Initialize your VOMS proxy asking to be member of the gilda VO

Edit your `.mdclient.config` setting `Login=NULL` (user will be retrieved from your proxy extensions)

Log into AMGA

```
$ voms-proxy-init --voms gilda
$ voms-proxy-info -fqan
/gilda/Role=NULL/Capability=NULL
$ grep Login .mdclient.config
Login = NULL
```

Suppose we want to look for all contents about VOMS

```
Query> whoami
>> gilda
Query> selectattr /gLibrary:FILE /gLibrary:FileName /gLibrary:Type
'like(/gLibrary:Keywords, "%VOMS%")'
>> 1f6e9ac6-5c86-4599-b03b-560e0e7ea38a
>> VOMS_server_Installation.ppt.gpg
>> EGEEEDOC
```

Now let's find out in which collection EGEEEDOC attributes are stored

```
Query> getattr /gLTypes/EGEEEDOC Path
>> EGEEEDOC
>> /EGEEPPT
```

- **Medical Data Manager – MDM**

- Store and access medical images and associated metadata on the Grid
- Built on top of gLite 1.5 data management system
- Demonstrated at last EGEE conference (October 05, Pisa)

- **Strong security requirements**

- Patient data is sensitive
- Data must be encrypted
- Metadata access must be restricted to authorized users

- **AMGA used as metadata server**

- Demonstrates authentication and encrypted access
- Used as a simplified DB

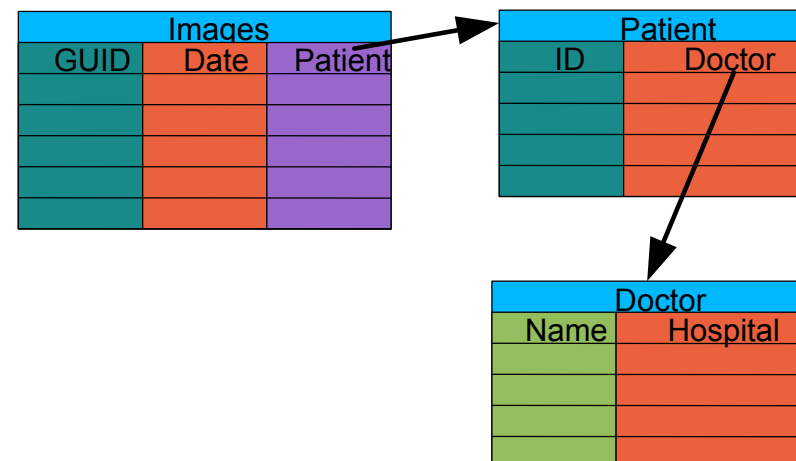

- **More details at**

- <https://uimon.cern.ch/twiki/bin/view/EGEE/DMEncryptedStorage>

UNOSAT is a United Nations Initiative

Objectives

- Provide the humanitarian community with access to satellite imagery and Geographic Information System services
 - ▶ Reduce disasters and plan sustainable development
- Ensure cost-effective and timely products

Core Services

- Humanitarian Mapping
- Image Processing

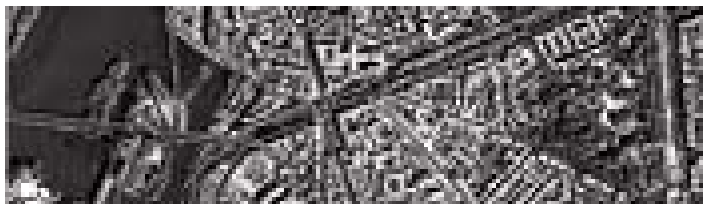

VEGETATION – 1 Km

IKONOS – 1m

- Potential Bottlenecks:

- UNOSAT beginning to suffer from limited capacity and processing power
 - Multiple satellites being launched
 - Larger and larger storage capacity needed

- In summer 2005 we have provided a whole structure at CERN for UNOSAT

- UNOSAT Virtual Organization (VO)
 - 3.5TB in CASTOR
 - Computing Elements, Resource Brokers
 - Collaboration with ARDA group
 - AFS area of 5GB

We have provided
the whole GRID
infrastructure
At CERN

- We have run some UNOSAT tests (images compression) inside the GRID environment (quite successful)

- The framework developed for in principle for Geant4 (See Alberto Ribon's presentation [49]) has been adapted for UNOSAT needs

- UNOSAT provided us with a set of images for testing
- Associated to each image a metadata file was included
File name, directory path, geographical coordinates

■ Steps:

STORAGE LEVEL

- Copy and registration of the images in Castor@CERN
 - ▶ Use of the LFC Catalog
- Parse the metadata files to extract the different metadata
- Use of the AMGA tool to parse metadata to location of the files

COMPUTING LEVEL

- Use of compression tools to compress images inside LCG resources
- Use of the general submission tool adapted to UNOSAT needs

☐ LFC Catalogue

➔ Mapping of LFN to TURL

☐ UNOSAT requires

➔ User will give as input data certain coordinates (x, y, z)

➔ As output, want the satellite image file for downloading

☐ The ARDA Group assists us setting up the AMGA tool for UNOSAT

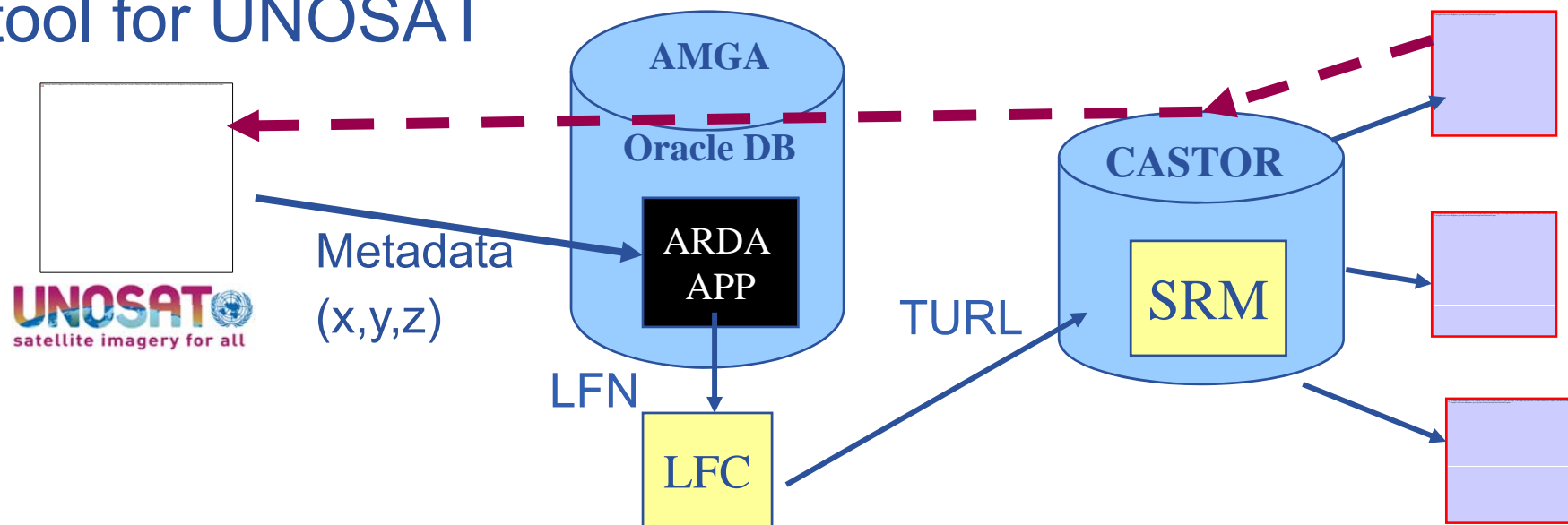

- **AMGA Implementation:**
 - SOAP and Text frontends
 - Streamed Bulk Operations
 - Supports single calls, sessions & connections
 - SSL security with grid certs (negotiated by client)
 - Own User & Group management + VOMS
 - PostgreSQL, Oracle, MySQL, SQLite backends
 - Works alongside LFC
 - C++, Java, Perl, Python clients

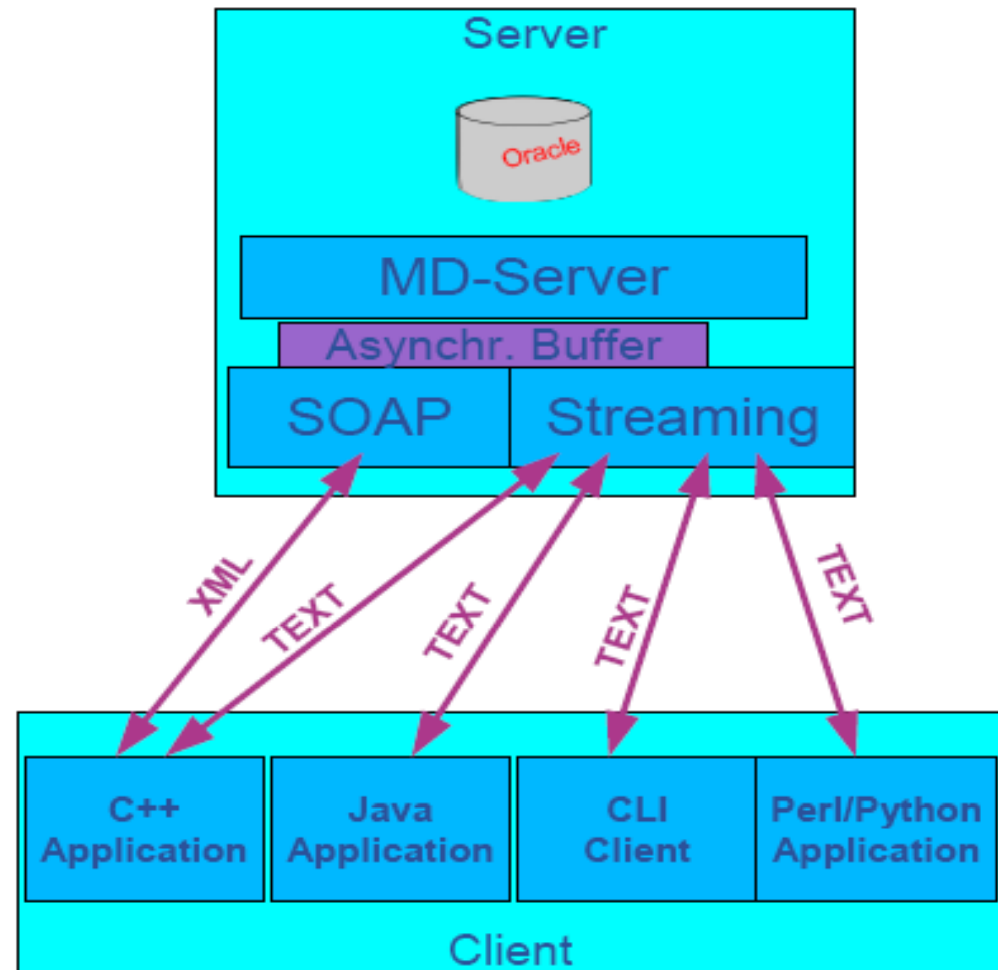

- **Dynamic Schemas**
 - Schemas can be modified at runtime by client
 - Create, delete schemas
 - Add, remove attributes
- **Metadata organised as an hierarchy**
 - Collections can have subcollections (directory – subdirectory)
 - Schemas can contain sub-schemas
 - Analogy to file system:
 - Schema ↔ Directory; Entry ↔ File
- **Flexible Queries**
 - SQL-like query language
 - Joins between schemas

- **Unix style permissions**
- **ACLs – Per-collection or per-entry.**
- **Secure connections – SSL**
- **Client Authentication based on**
 - Username/password
 - General X509 certificates
 - Grid-proxy certificates
- **Access control via a Virtual Organization Management System (VOMS):**

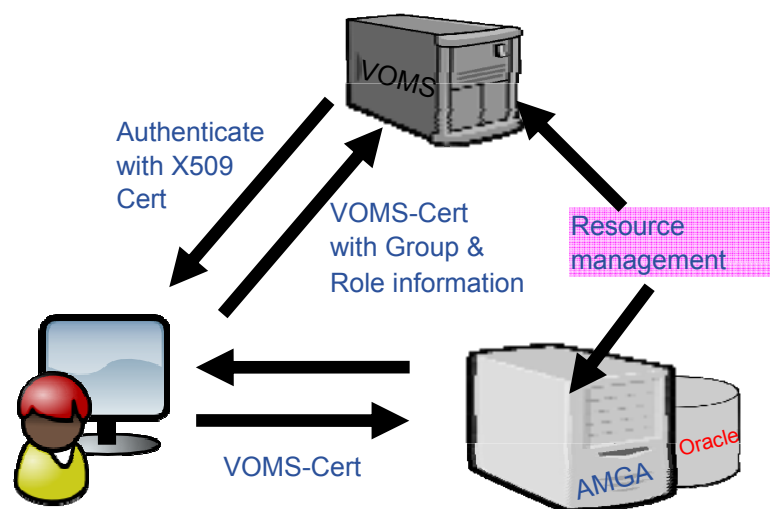

- Currently working on **replication/federation** mechanisms for AMGA
- **Motivation**
 - **Scalability** – Support hundreds/thousands of concurrent users
 - **Geographical distribution** – Hide network latency
 - **Reliability** – No single point of failure
 - **DB Independent replication** – Heterogeneous DB systems
 - **Disconnected computing** – Off-line access (laptops)
- **Architecture**
 - Asynchronous replication
 - Master-slave – Writes only allowed on the master
 - Replication at the application level
 - Replicate Metadata commands, not SQL → DB independence
 - Partial replication – supports replication of only sub-trees of the metadata hierarchy
- <http://amga.web.cern.ch/amga/publications/nsantos2006AMGAReplication.pdf>

Some use cases

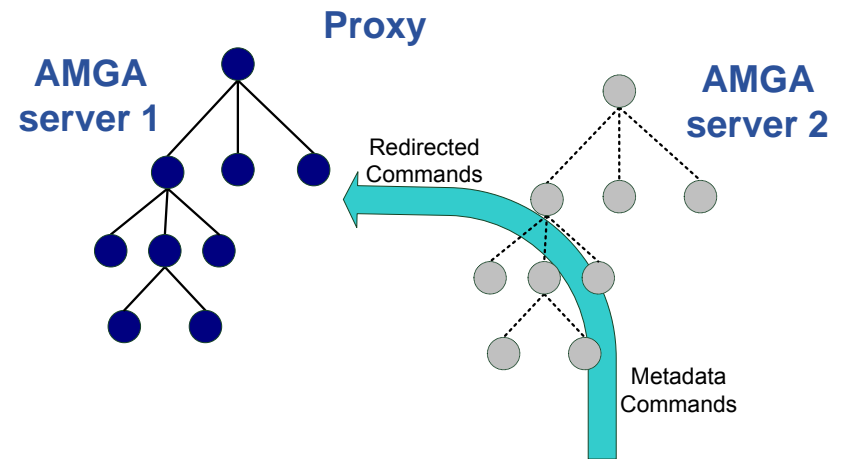
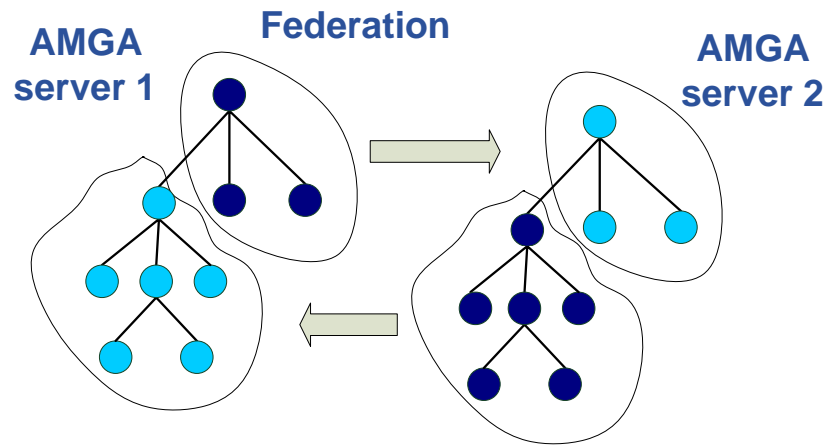
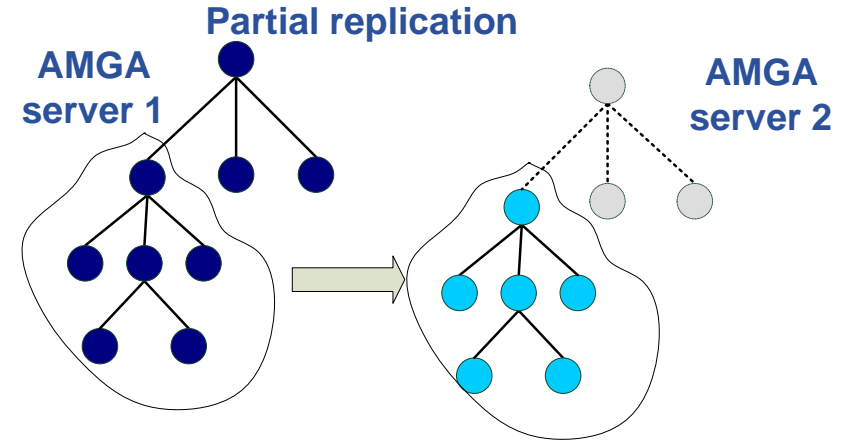
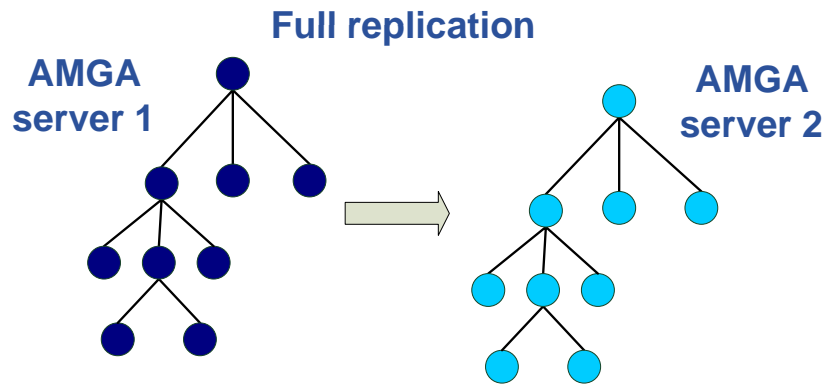

- **But also....**

- simplified DB access on the Grid**

- Many Grid applications need structured data
 - Many applications require only simple schemas
 - Can be modelled as metadata
 - Main advantage: better integration with the Grid environment
 - Metadata Service is a Grid component
 - **Grid security**
 - Hide DB heterogeneity

- Files are saved on SEs and registered into LFC file catalogues
- **The AMGA Metadata Catalogue is** used to archive and organize metadata and to answer users' queries.
- gLibrary is built using the following AMGA collections:
 - /gLibrary contains generic metadata for each entry
 - /gLAudio, /gLImage, /gLVideo, /gLPPT, /EGEEPPT, /gLDoc, ... are examples of collections of “additional features” (shown later)
 - /gLTypes
 - keeps the associations between document types and the names of the collection that contains the “additional features”
 - is used by gLibrary to find out where it has to look when new document types are added into the system (extensibility)
 - /gLKeys is used to store Decryption Keys

Collection		/gLibrary		
Entry Names	Attributes			
	FileName	PathName	Type	Submitter
	4ffaafc8-26e7-4826-b460-3d5bf08081a4	DedicatoAte.mp3	/grid/gilda/calanducci	Audio Tony Calanducci
00454dca-a269-4b93-8a45-c4012af05600	ardizzonelarocca_is_231005.ppt.gpg	/grid/gilda/calanducci/ EGEE	EGEEDOC Tony Calanducci	

/gLibrary (continuum)

Attributes				
SubmissionDate	Encryption	Description	Keywords	CreationDate
2006-01-05 00:00:00	false	Canzone delle vibrazioni che ha ricevuto un enorme successo tra i teenagers nel 2003	Vibrazioni	2004-02-05 00:00:00
2005-01-05 16:44:22	true	gLite Information System	R-GMA, RGMA, BDII, IS	2005-10-05 23:40

Example of gLibrary collections

Collection	/gLTypes
Entry names	Attributes
	Path (<i>refers to a collection</i>)
Audio	/gLAudio
Image	/gLImage
Video	/gLVideo
Documents	/gLDOC
PowerPoint	/gLPPPT
EGEEDOC	/EGEEPPT

Collection	/gLKeys
Entry names	Attributes
	Passphrase
00454dca-a269-4b93-8a45-c4012af05600	ardizzo

“additional features”

Collection	/EGEEPPT							
Entry names	Attributes							
	Title	Runtime	Author	Type	Date	Event	Speaker	Topic
00454dca-a269-4b93-8a45-c4012af05600	Information Systems	00:30:00	Valeria Ardizzone, Giuseppe La Rocca	Theoretical	2005-10-23	4 th EGEE Conference	Giuseppe La Rocca, Valeria Ardizzone	R-GMA, BDII

Collection	/gLAudio					
Entry names	Attributes					
	SongTitle	Duration	Album	Genre	Singer	Format
4ffaafc8-26e7-4826-b460-3d5bf08081a4	Dedicato A Te	00:03:27	Dedicato A Te	Pop	Le Vibrazioni	MP3

- **User Requirements:**
 - a valid proxy with VOMS extensions
 - VOMS Role and Group needed to be recognized by gLibrary as a contents manager.
- **3 kinds of users:**
 - **gLibraryManager:** (s)he can create new content type and allows a generic VO user to become gLibrarySubmitter
 - **gLibrarySubmitters:** they can add new entries and define access rights on the entries they create.
 - Fine-grained permission (reading, writing, listing, decrypting) settings on each entry: whole VO members, VO groups, list of DNs
 - **generic VO users:** browse and make queries (on entries they have access to)
- **Basic level of cryptography:**
 - New files saved on SEs can be encrypted beforehand with a symmetric passphrase that will be saved in /gLKeys. Only selected users (that have a specific DN in the subject of their VOMS proxy) can access the passphrase and decrypt the file.

Initialize your VOMS proxy asking to be member of the gilda VO

Edit your `.mdclient.config` setting `Login=NULL` (user will be retrieved from your proxy extensions)

Log into AMGA

```
$ voms-proxy-init --voms gilda
$ voms-proxy-info -fqan
/gilda/Role=NULL/Capability=NULL
$ grep Login .mdclient.config
Login = NULL
```

Suppose we want to look for all contents about VOMS

```
Query> whoami
>> gilda
Query> selectattr /gLibrary:FILE /gLibrary:FileName /gLibrary:Type
'like(/gLibrary:Keywords, "%VOMS%")'
>> 1f6e9ac6-5c86-4599-b03b-560e0e7ea38a
>> VOMS_server_Installation.ppt.gpg
>> EGEEEDOC
```

Now let's find out in which collection EGEEEDOC attributes are stored

```
Query> getattr /gLTypes/EGEEEDOC Path
>> EGEEEDOC
>> /EGEEPPT
```

Now we can make a JOIN between the 2 tables to extract all the information we like

```
Query> selectattr /gLibrary:FILE /gLibrary:FileName /gLibrary:Description
/EGEEPPT:Author /EGEEPPT:Title /EGEEPPT:Event '/gLibrary:FILE=/EGEEPPT:FILE and
like(/gLibrary:Keywords, "%VOMS%") `
>> 1f6e9ac6-5c86-4599-b03b-560e0e7ea38a
>> VOMS_server_Installation.ppt.gpg
>> VOMS Server installation tutorial done in Venezuela
>> ziggy, Giorgio
>> Installing a gLite VOMS Server
>> First Latin American Workshop for Grid Administrators
```

Let's see where the passphrase to decrypt the file is stored

```
Query> selectattr /gLibrary:FILE DecryptKeyDir 'FILE="1f6e9ac6-5c86-4599-b03b-
560e0e7ea38a" '
>> 1f6e9ac6-5c86-4599-b03b-560e0e7ea38a
>> /DLKeys/gildateam
```

But ...

```
Query> getattr /gLKeys/gildateam/1f6e9ac6-5c86-4599-b03b-560e0e7ea38a
Passphrase
Error 4: Permission denied
```

Because gilda is not a member of the gildateam group

- **on AMGA and gLibrary:**

- <http://indico.eu-eela.org/conferenceTimeTable.py?confId=37>
- (go to day 3 for the AMGA tutorial)

- **AMGA Web Site**

<http://project-arda-dev.web.cern.ch/project-arda-dev/metadata/>

- **AMGA – Metadata Service of gLite**
 - Useful for simplified DB access
 - Integrated in the Grid environment (Security)
- **Replication/Federation under development**
- **Tests show good performance/scalability**
- **Already deployed by several Grid Applications**
 - LHCb, ATLAS, Biomed, ...
 - DLibrary