

ALICE Indonesia, Grid Infrastructure, and Its Connectivity

-site report-

Online-Tsukuba
@ATCF9, 25 Sept 2025

Andria Arisal
on behalf of ALICE @BRIN

andria.arisal@[brin.go.id | cern.ch]



Outline

- Introduction to BRIN
- ALICE @BRIN
- BRIN's HPC infrastructure
- ALICE grid @BRIN
- IdREN connectivity
- Challenges and Future initiatives



BRIN - National Research and Innovation Agency

- The sole (largest) national research agency of Indonesia
 - 12 research organizations (85 research centers)
 - 7 deputies (administrative)
- ALICE @BRIN
 - Research Center for Quantum Physics
 - Research Center for Computation
 - Research Center for Data and Information Sciences
 - Deputy of Research and Innovation Infrastructure



ALICE @BRIN

- still illegal :)
 - MoU between ALICE-CERN with LIPI (Indonesian Institute of Sciences)
 - LIPI is dissolved into BRIN in 2021 (no more LIPI)
 - MoU between ALICE-CERN and BRIN (National Research and Innovation Agency) has not been signed yet
- Member:
 - Syaefudin Jaelani (Physicist - Team Leader)
 - Zulkaida Akbar (Physicist - Deputy TL)
 - Rifki Sadikin (Engineer - Deputy TL)
 - Suharyo Sumowidagdo (Physicist)
 - M. Jauhar Kholili (Engineer)
 - Andria Arisal (Engineer)
- Students: PhD (1), Bachelor (1)

ALICE @BRIN

- Activities:

- Physics analysis: heavy flavour, small system
- Detector and Instrumentation Lab: expressed interests in Forward Calorimeter Hadronic (FoCal-H), testing and construction of silicon photomultiplier
- Computation: HPC lab (ALICE grid services)

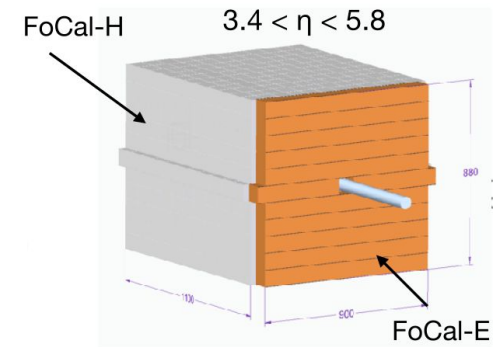

(relatively) New HPC infrastructure (2024)



BRIN's HPC Infrastructure

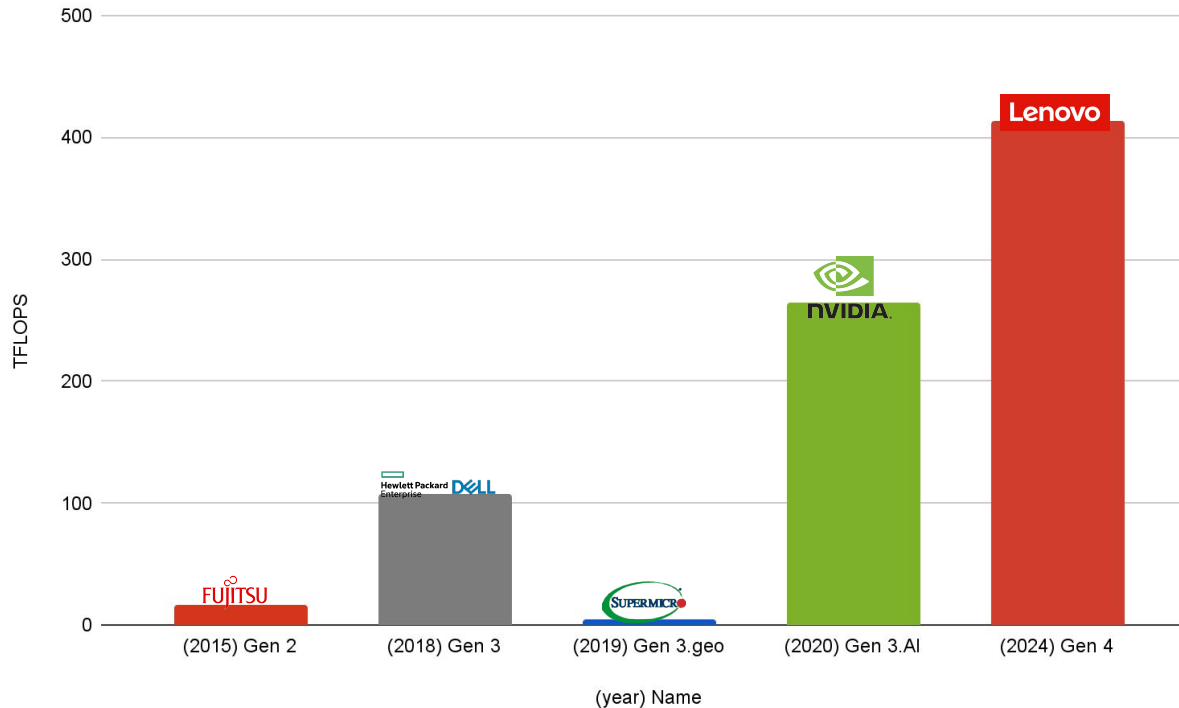

(year) Name	TFLOPS
(2015) Gen 2	17
(2018) Gen 3	107
(2019) Gen 3.geo	5
(2020) Gen 3.AI	265
(2024) Gen 4	414
(2026) Gen 4.AI (ASEAN + ROK)	3500

BRIN's HPC Infrastructure

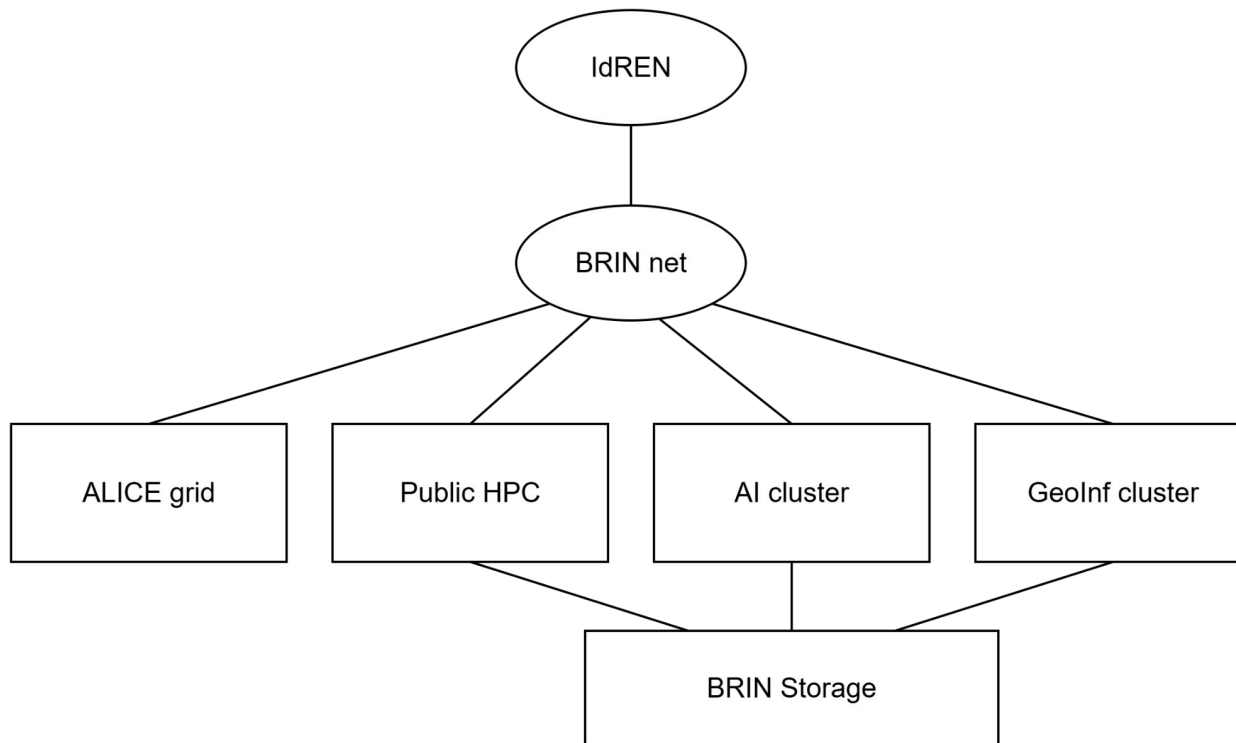

ALICE grid @BRIN

- (still) small grid cluster
 - ALICE grid integration
 - Maintain consistency since late 2023
 - More worker nodes next year
-
- Trying to get institution's commitment for WLCG

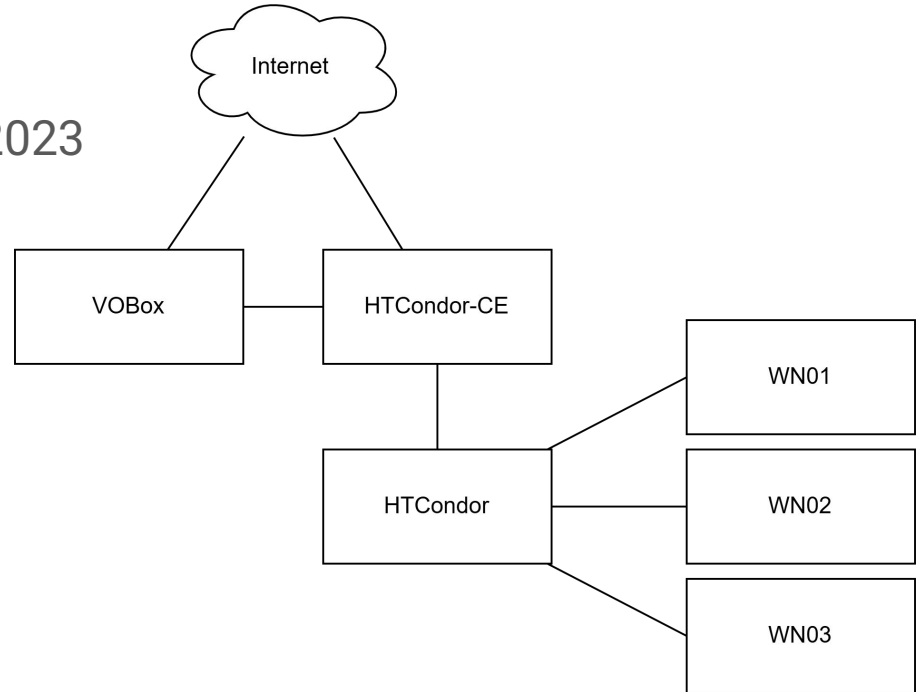

Maintaining ALICE Service @Cibinong

Running Jobs

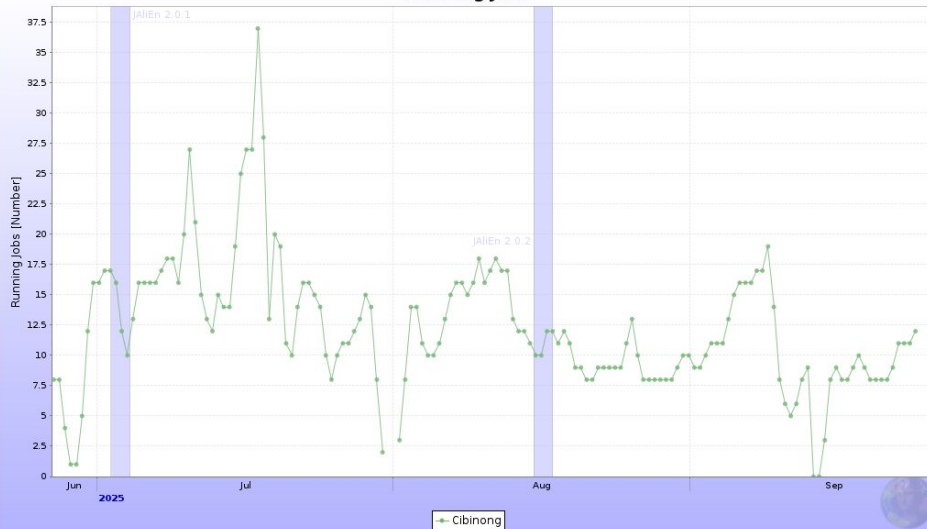

Running Jobs				
Series	Last value	Min	Avg	Max
1. Cibinong	12	0	12.26	87
Total	12		12.26	

Done jobs in Cibinong



Done jobs in Cibinong				
Series	Last value	Min	Avg	Max
1. DONE	14723	114	9217	14723
Total	14723		9217	

IdREN: Indonesian Research and Education Network



TEIN Network Topology (Aug 2025)

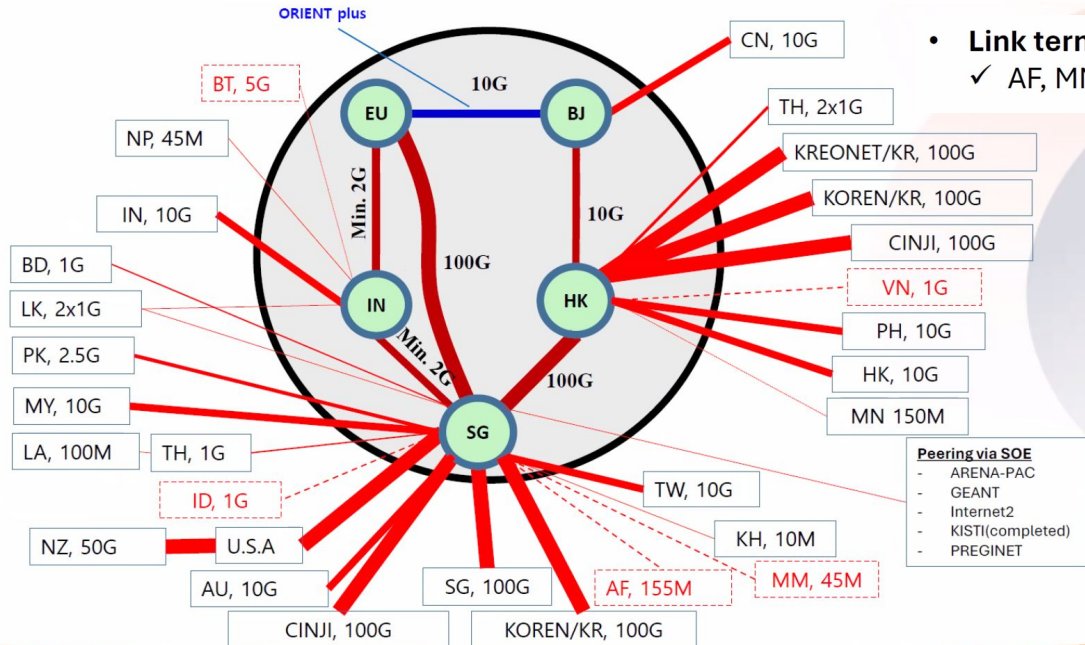

• Link termination

- ✓ AF, MM(EU's policy), ID, VN(financial constraints)

- Peering via SOE**
- ARENA-PAC
 - GEANT
 - Internet2
 - KISTI(completed)
 - PREGINET

IdREN: Indonesian Research and Education Network

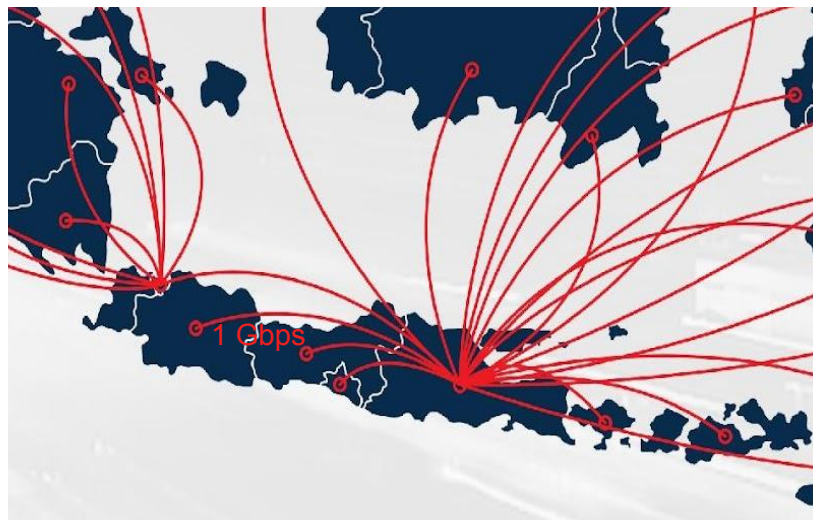

Regional Connectivity

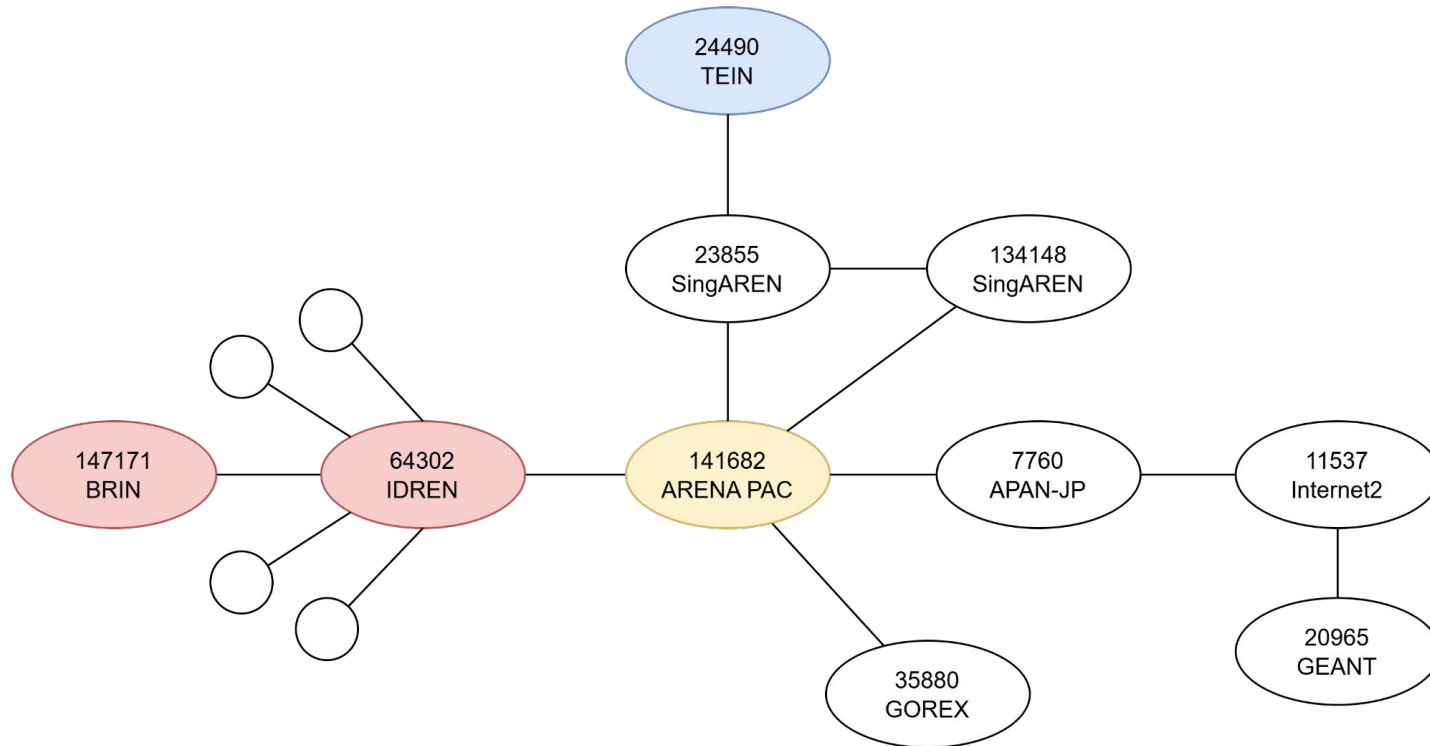

Challenges

- Network hiccups
- REN Bandwidth Underutilization
 - > 80% through commercial network
- Lack of sustainable funding
 - a BRIN management representative in Alice RRB

Future Initiatives

- Indonesian Domestic
 - Open computing resources (from BRIN + higher education) for Indonesian researcher
 - Improving domestic bandwidth (currently < 1 Gbps)
- Regional
 - ASEAN HPC: Building HPC Infrastructure and Capacity for ASEAN Data Utilization (ASEAN + KISTI)

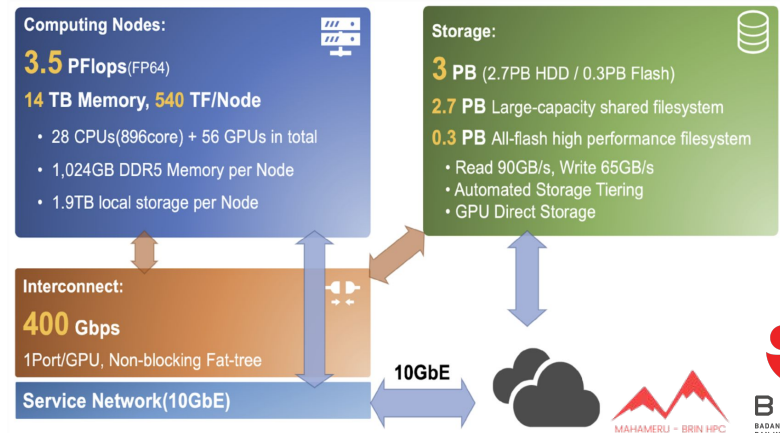

Summary and Plan

- Alice grid
 - add more worker nodes (commit additional 5500 HS23 CPU capacity in 2026)
- Research
 - resource monitoring and management
 - distributed file storage (comparison and profiling)
- Next Procurement
 - 2025/2026 ASEAN HPC (ASEAN + ROK (KISTI))
 - Bandwidth upgrade Cibinong (Jakarta) => Malang

Thank You

andria.arisal@[brin.go.id | cern.ch]