

Particle Detectors 1/2

Werner Riegler, CERN, werner.riegler@cern.ch

History of Particle Physics

- 1895:** X-rays, W.C. Röntgen
- 1896:** Radioactivity, H. Becquerel
- 1899:** Electron, J.J. Thomson
- 1911:** Atomic Nucleus, E. Rutherford
- 1919:** Atomic Transmutation, E. Rutherford
- 1920:** Isotopes, E.W. Aston
- 1920-1930:** Quantum Mechanics, Heisenberg, Schrödinger, Dirac
- 1932:** Neutron, J. Chadwick
- 1932:** Positron, C.D. Anderson
- 1937:** Mesons, C.D. Anderson
- 1947:** Muon, Pion, C. Powell
- 1947:** Kaon, Rochester
- 1950:** QED, Feynman, Schwinger, Tomonaga
- 1955:** Antiproton, E. Segre
- 1956:** Neutrino, Rheines
- etc. etc. etc.

History of Instrumentation

1906: Geiger Counter, H. Geiger, E. Rutherford

1910: Cloud Chamber, C.T.R. Wilson

1912: Tip Counter, H. Geiger

1928: Geiger-Müller Counter, W. Müller

1929: Coincidence Method, W. Bothe

1930: Emulsion, M. Blau

1940-1950: Scintillator, Photomultiplier

1952: Bubble Chamber, D. Glaser

1962: Spark Chamber

1968: Multi Wire Proportional Chamber, C. Charpak

Etc. etc. etc.

On Tools and Instrumentation

“New directions in science are launched by new tools much more often than by new concepts.

The effect of a concept-driven revolution is to explain old things in new ways.

The effect of a tool-driven revolution is to discover new things that have to be explained”

From Freeman Dyson ‘Imagined Worlds’



History of Instrumentation

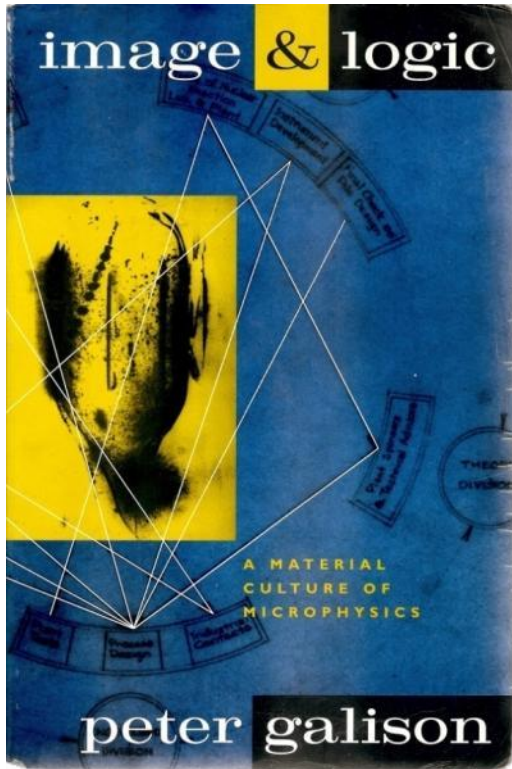

Peter Galison, *Image and Logic*
A Material Culture of Microphysics

History of 'Particle Detection'

Image Tradition: Cloud Chamber
Emulsion
Bubble Chamber

Logic Tradition: Scintillator
Geiger Counter
Tip Counter
Spark Counter

Electronics Image: Wire Chambers
Silicon Detectors

...

History of Instrumentation

Image Detectors

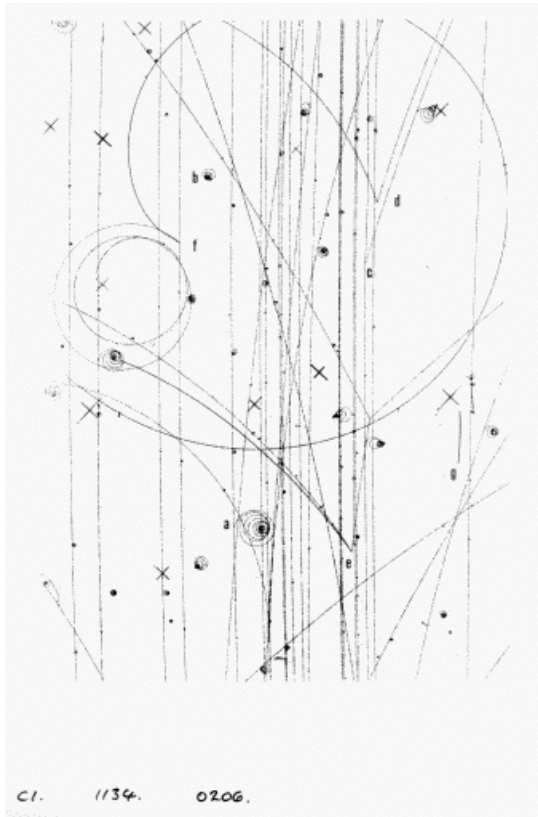

Bubble chamber photograph

'Logic (electronics) Detectors'

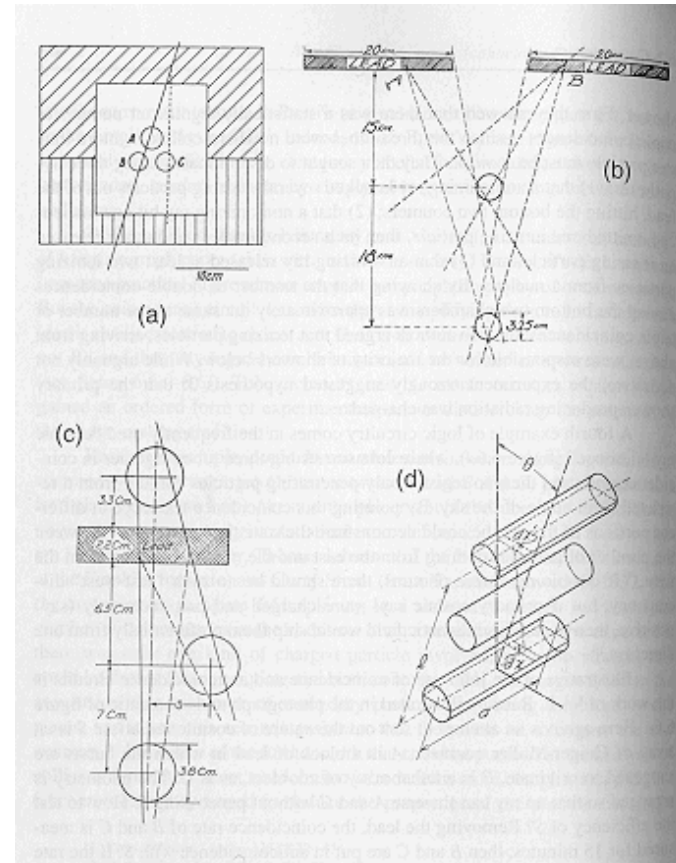

Early coincidence counting experiment

History of Instrumentation

Both traditions combine into the 'Electronics Image' during the 1970ies

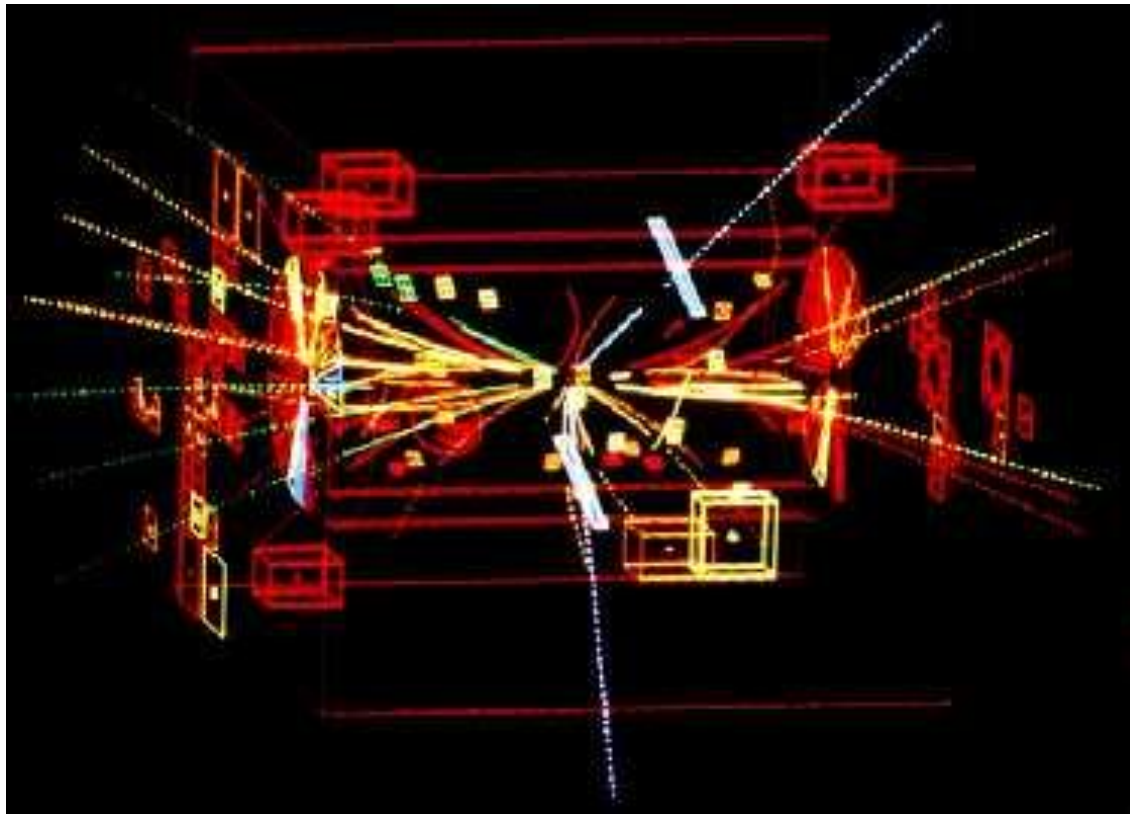

Z-Event at UA1 / CERN

IMAGES

Cloud Chamber

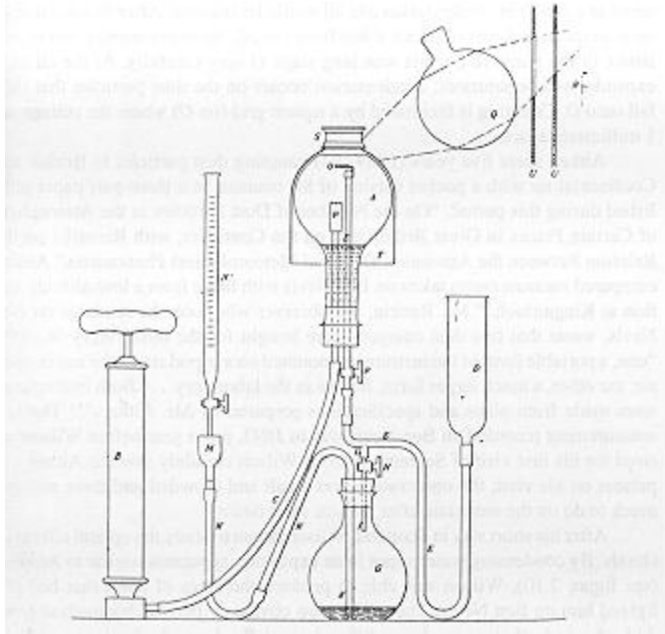

Dust Chamber, Aitken 1888

John Aitken, *1839, Scotland:

Aitken was working on the meteorological question of cloud formation. It became evident that cloud droplets only form around condensation nuclei.

Aitken built the 'Dust Chamber' to do controlled experiments on this topic. Saturated water vapor is mixed with dust. Expansion of the volume leads to super-saturation and condensation around the dust particles, producing clouds.

From steam nozzles it was known and speculated that also electricity has a connection to cloud formation.

Cloud Chamber

Charles Thomson Rees Wilson, * 1869, Scotland:

Wilson was a meteorologist who was, among other things, interested in cloud formation initiated by electricity.

In 1895 he arrived at the Cavendish Laboratory where J.J. Thompson, one of the chief proponents of the corpuscular nature of electricity, had studied the discharge of electricity through gases since 1886.

Wilson used a 'dust free' chamber filled with saturated water vapor to study the cloud formation caused by ions present in the chamber.

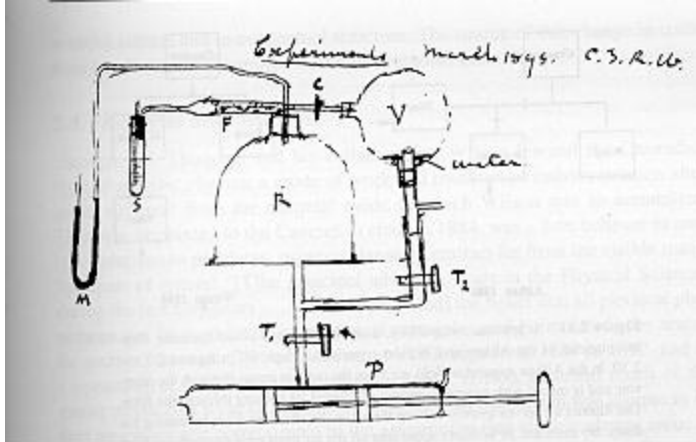

Cloud Chamber, Wilson 1895

Cloud Chamber

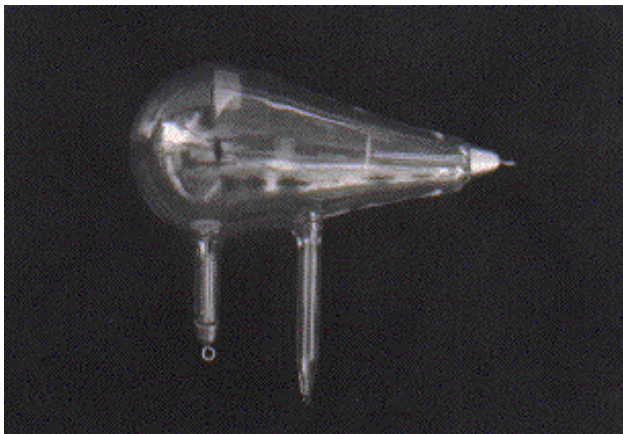
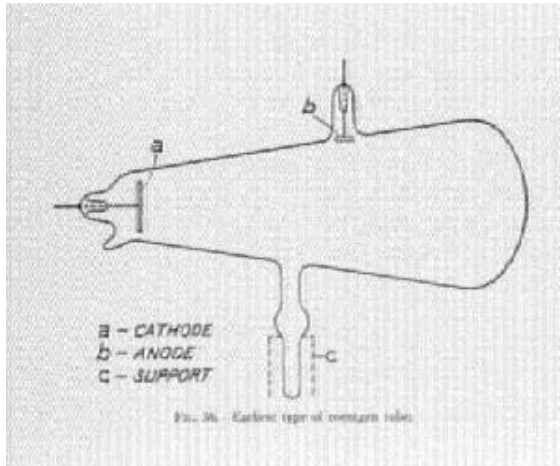

This tube is a glass bulb with positive and negative electrodes, evacuated of air, which displays a fluorescent glow when a high voltage current is passed through it. When he shielded the tube with heavy black cardboard, he found that a greenish fluorescent light could be seen from a platinum screen 9 feet away.

Conrad Röntgen discovered X-Rays in 1895.

At the Cavendish Lab Thompson and Rutherford found that irradiating a gas with X-rays increased its conductivity suggesting that X-rays produced ions in the gas.

Wilson used an X-Ray tube to irradiate his Chamber and found 'a very great increase in the number of the drops', confirming the hypothesis that ions are cloud formation nuclei.

Radioactivity ('Uranium Rays') discovered by Becquerel in 1896. It produced the same effect in the cloud chamber.

1899 J.J. Thompson claimed that cathode rays are fundamental particles → electron.

Soon afterwards it was found that rays from radioactivity consist of alpha, beta and gamma rays (Rutherford).

Cloud Chamber

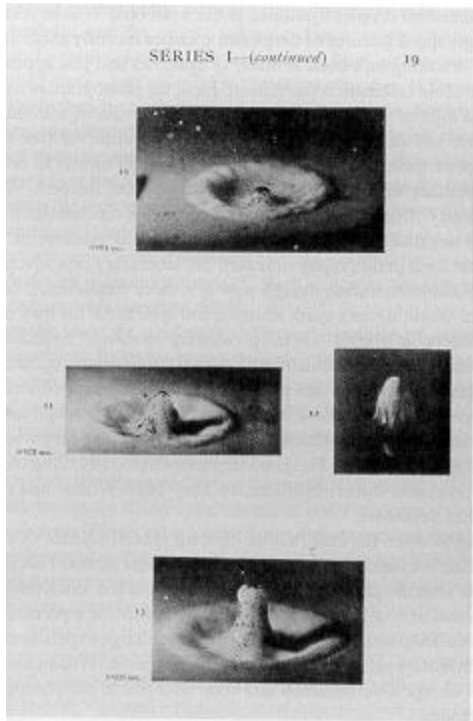

Worthington 1908

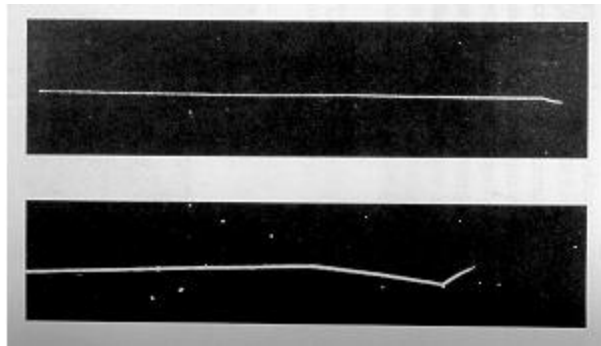

Early Alpha-Ray picture, Wilson 1912

Using the cloud chamber Wilson also did rain experiments i.e. he studied the question on how the small droplets forming around the condensation nuclei are coalescing into rain drops.

In 1908 Worthington published a book on 'A Study of Splashes' where he shows high speed photographs that exploited the light of sparks enduring only a few microseconds.

This high-speed method offered Wilson the technical means to reveal the elementary processes of condensation and coalescence.

With a bright lamp he started to see tracks even by eye !

By Spring 1911 Wilson had track photographs from alpha rays, X-Rays and gamma rays.

Cloud Chamber

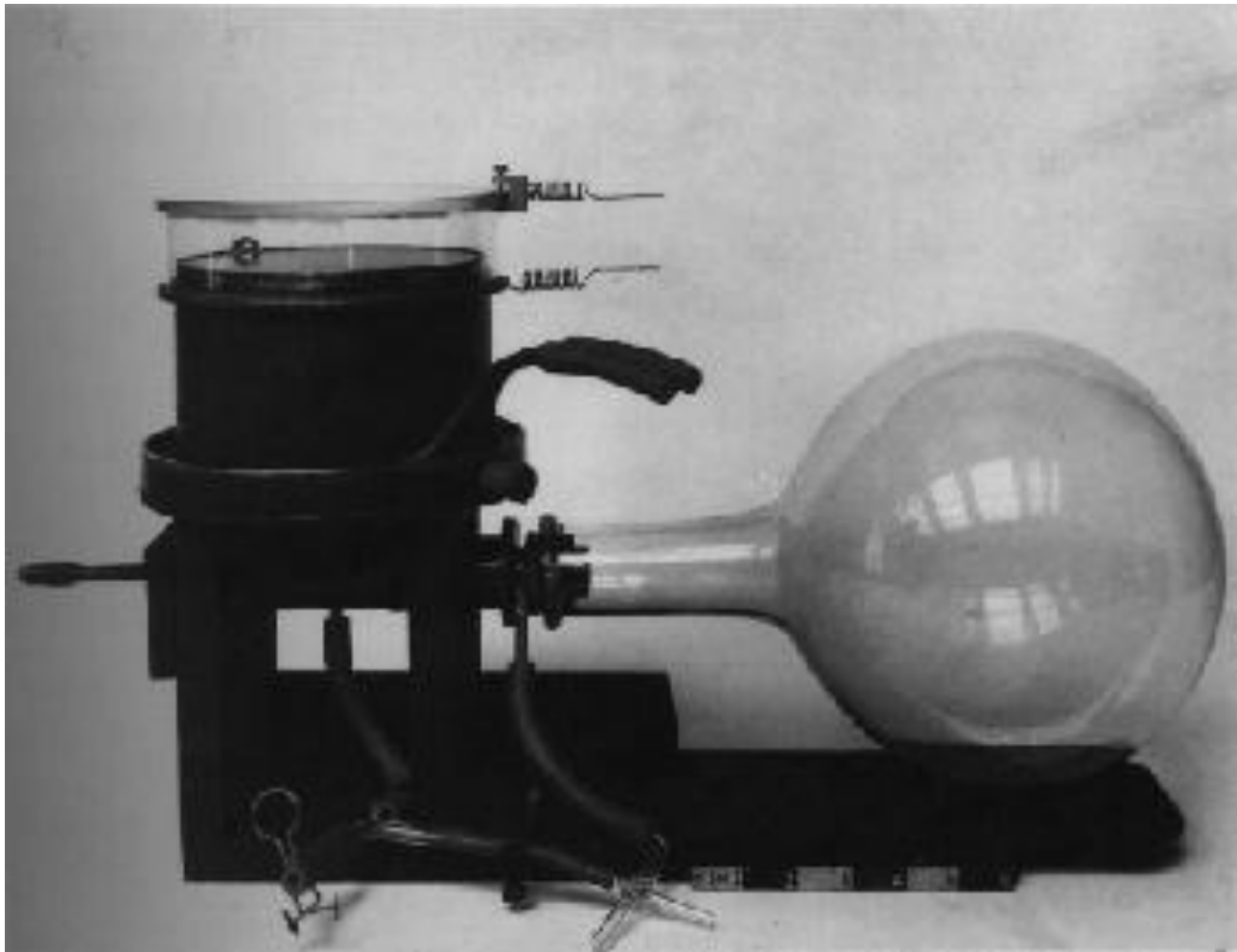

Wilson Cloud Chamber 1911

Cloud Chamber

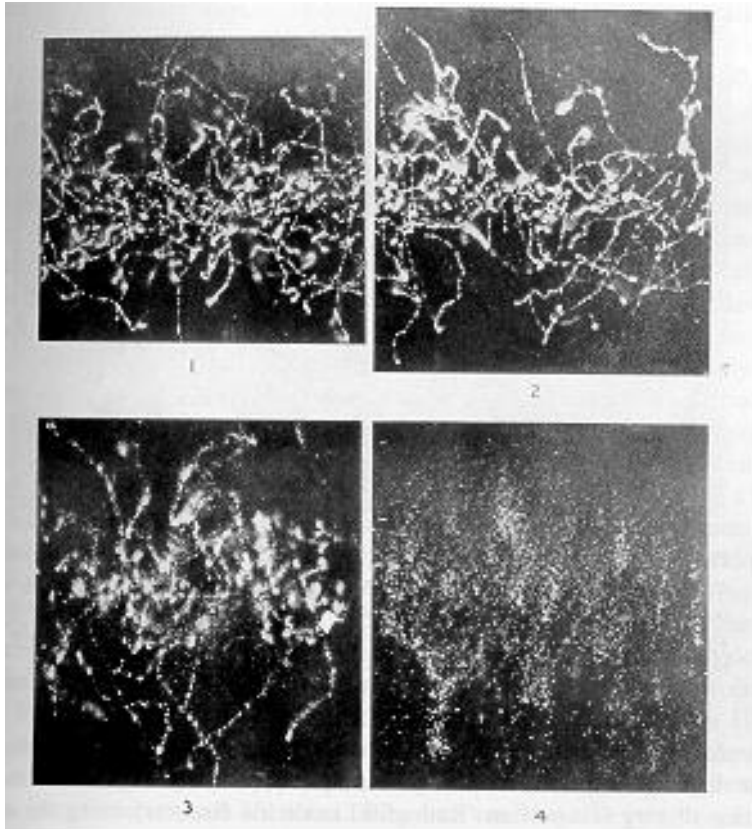

X-rays, Wilson 1912

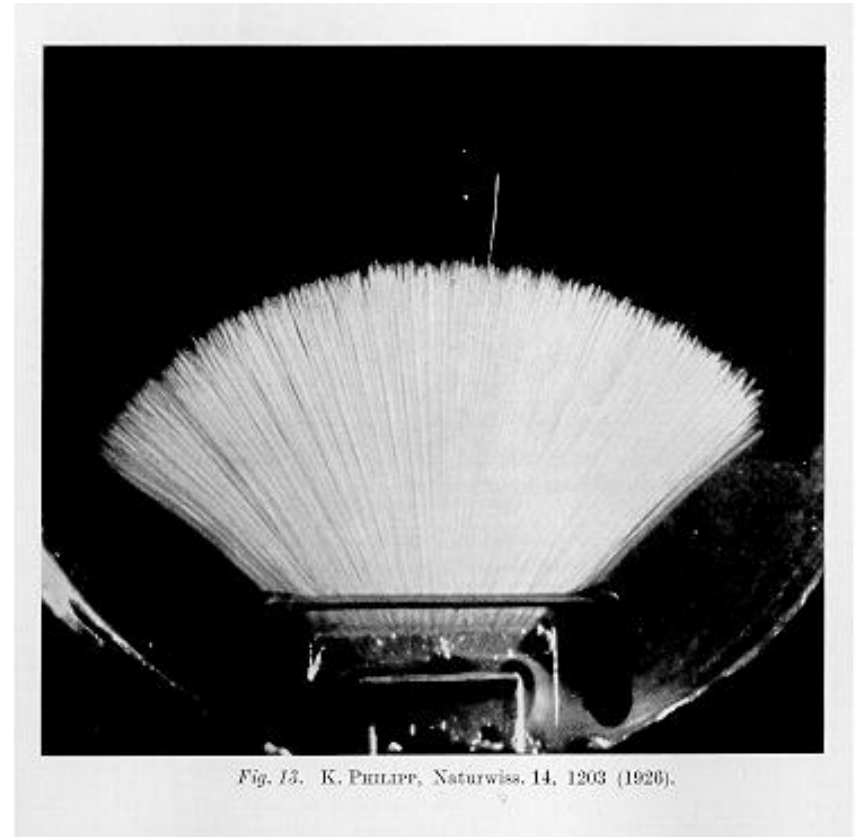

Alphas, Philipp 1926

Cloud Chamber

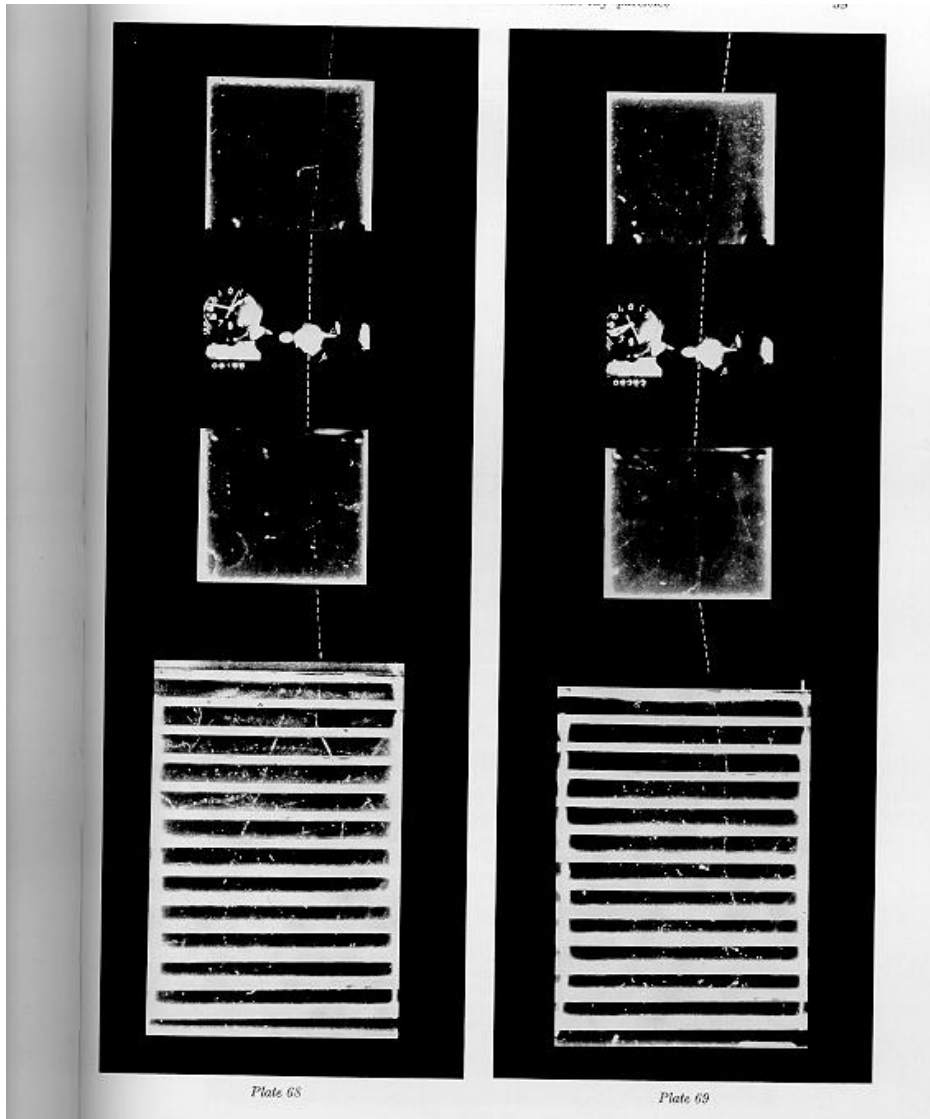

1931 Blackett and Occhialini began work on a counter controlled cloud chamber for cosmic ray physics to observe selected rare events.

The coincidence of two Geiger Müller tubes above and below the Cloud Chamber triggers the expansion of the volume and the subsequent illumination for photography.

Cloud Chamber

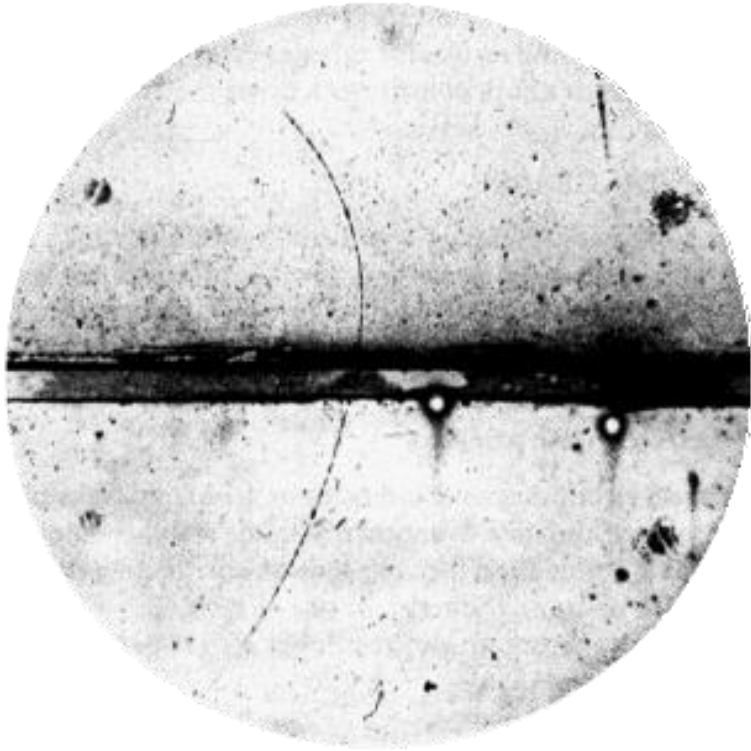

**Positron discovery,
Carl Andersen 1933**

**Magnetic field 15000 Gauss,
chamber diameter 15cm. A 63 MeV
positron passes through a 6mm lead plate,
leaving the plate with energy 23MeV.**

**The ionization of the particle, and its
behaviour in passing through the foil are
the same as those of an electron.**

Cloud Chamber

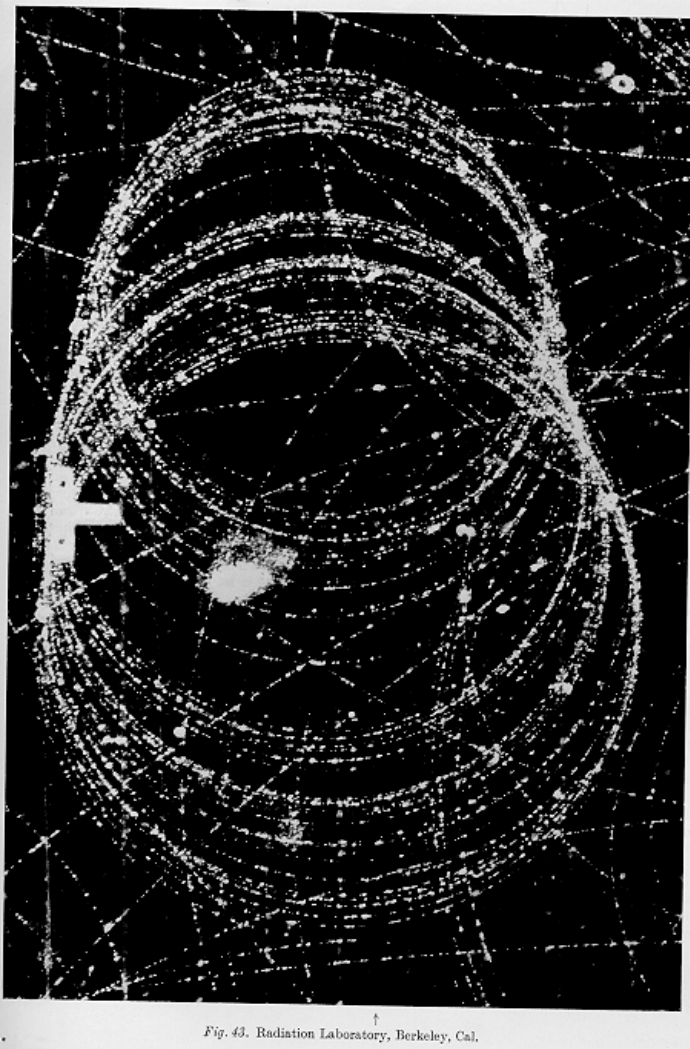

The picture shows an electron with 16.9 MeV initial energy. It spirals about 36 times in the magnetic field.

At the end of the visible track the energy has decreased to 12.4 MeV. From the visible path length (1030 cm) the energy loss by ionization is calculated to be 2.8 MeV.

The observed energy loss (4.5 MeV) must therefore be caused in part by Bremsstrahlung. The curvature indeed shows sudden changes as can most clearly be seen at about the seventeenth circle.

Fast electron in a magnetic field at the Bevatron, 1940

Cloud Chamber

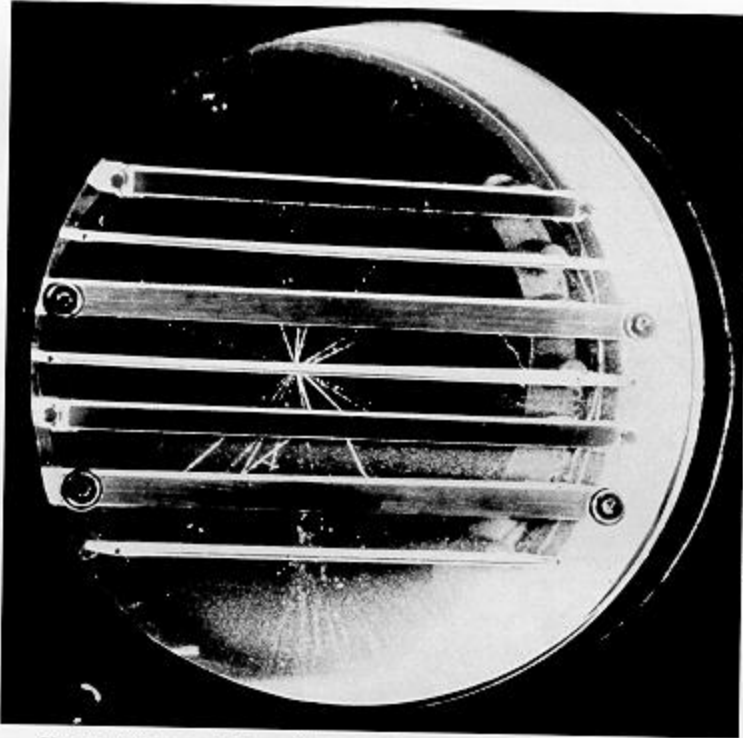

Plate 79. A. LOVATI, A. MURA, G. SALVINI, G. TAGLIAFERRI, Milan. (Unpublished.)

Taken at 3500m altitude in counter controlled cosmic ray Interactions.

Nuclear disintegration, 1950

Cloud Chamber

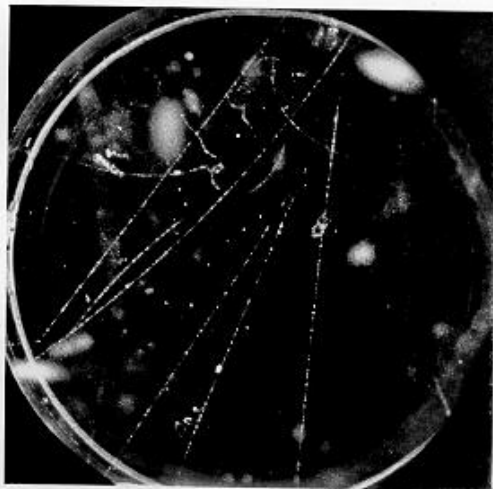

Plate 115

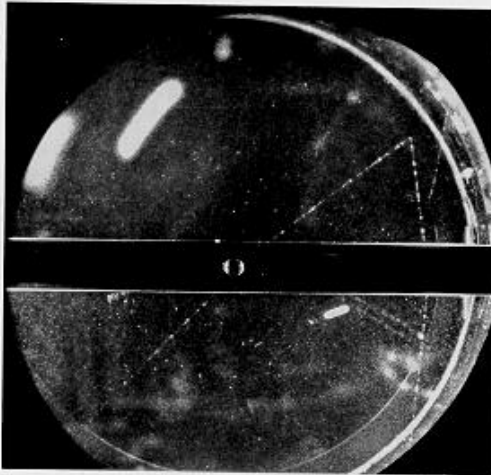

Plate 116

Particle momenta are measured by the bending in the magnetic field.

‘ ... The V_0 particle originates in a nuclear interaction outside the chamber and decays after traversing about one third of the chamber. The momenta of the secondary particles are 1.6 ± 0.3 BeV/c and the angle between them is 12 degrees ... ‘

By looking at the specific ionization one can try to identify the particles and by assuming a two body decay one can find the mass of the V_0 .

‘... if the negative particle is a negative proton, the mass of the V_0 particle is 2200 m, if it is a Pi or Mu Meson the V_0 particle mass becomes about 1000m ... ‘

Rochester and Wilson

Nuclear Emulsion

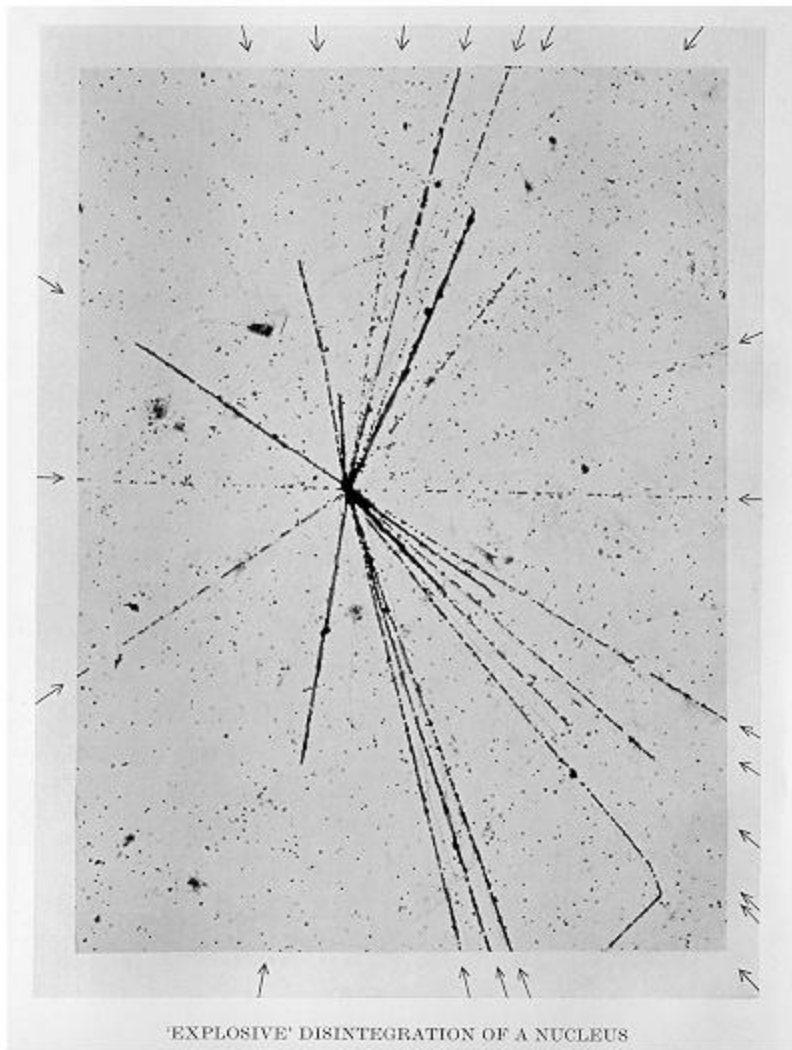

Film played an important role in the discovery of radioactivity but was first seen as a means of studying radioactivity rather than photographing individual particles.

Between 1923 and 1938 Marietta Blau pioneered the nuclear emulsion technique.

E.g.

Emulsions were exposed to cosmic rays at high altitude for a long time (months) and then analyzed under the microscope. In 1937, nuclear disintegrations from cosmic rays were observed in emulsions.

The high density of film compared to the cloud chamber 'gas' made it easier to see energy loss and disintegrations.

Nuclear Emulsion

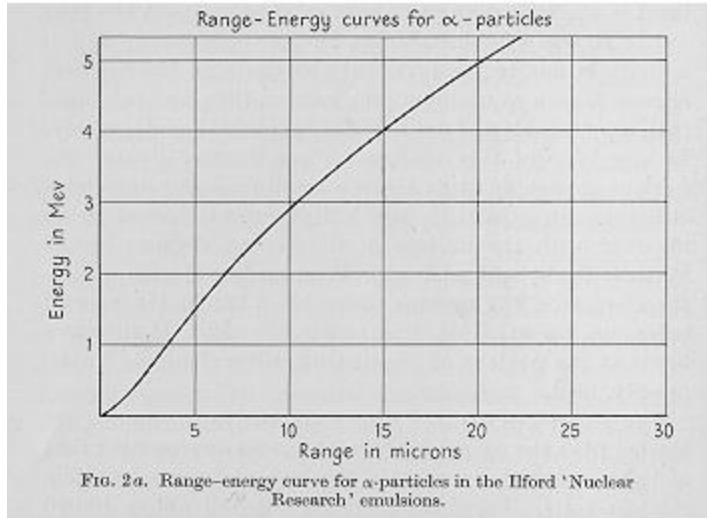

In 1939 Cecil Powell called the emulsion 'equivalent to a continuously sensitive high-pressure expansion chamber'.

A result analog to the cloud chamber can be obtained with a picture 1000x smaller (emulsion density is about 1000x larger than gas at 1 atm).

Due to the larger 'stopping power' of the emulsion, particle decays could be observed easier.

Stacks of emulsion were called 'emulsion chamber'.

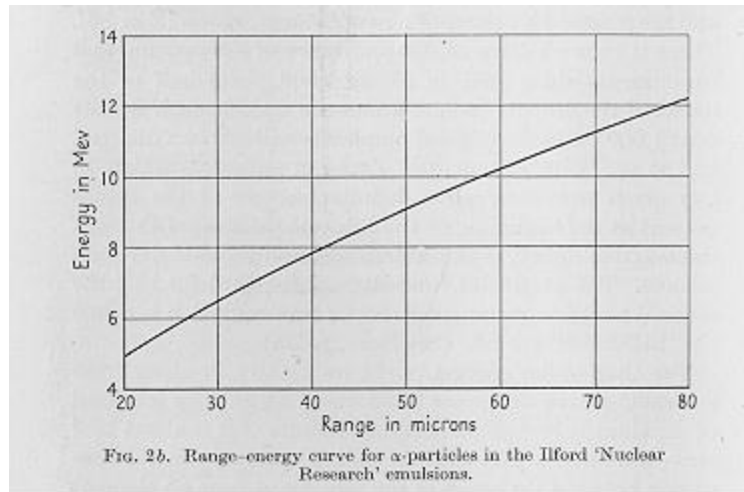

Nuclear Emulsion

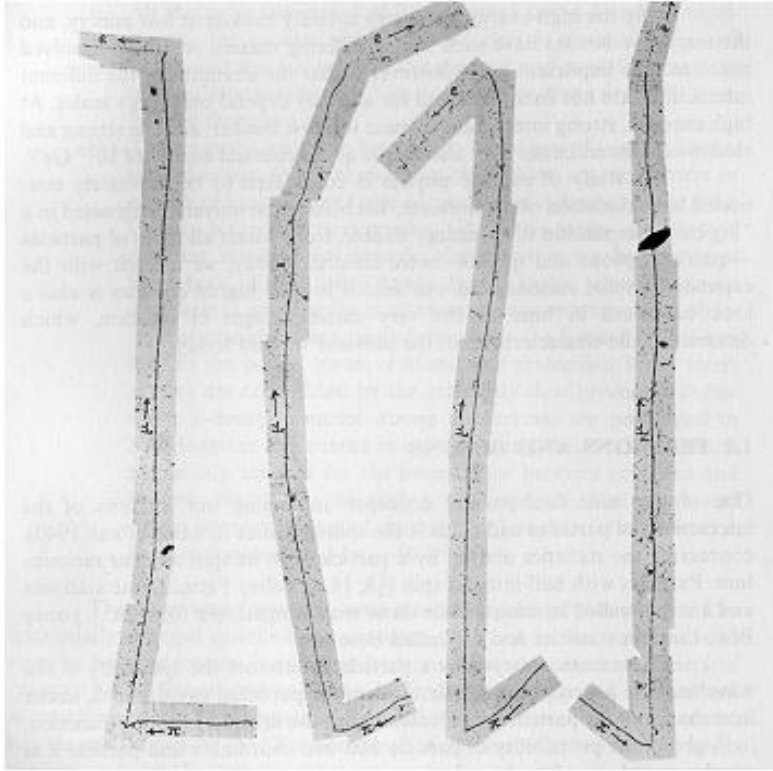

Discovery of muon and pion

Discovery of the Pion:

The muon was discovered in the 1930ies and was first believed to be Yukawa's meson that mediates the strong force.

The long range of the muon was however causing contradictions with this hypothesis.

In 1947, Powell et. al. discovered the Pion in Nuclear emulsions exposed to cosmic rays, and they showed that it decays to a muon and an unseen partner.

The constant range of the decay muon indicated a two body decay of the pion.

Nuclear Emulsion

Energy Loss is proportional to Z^2 of the particle

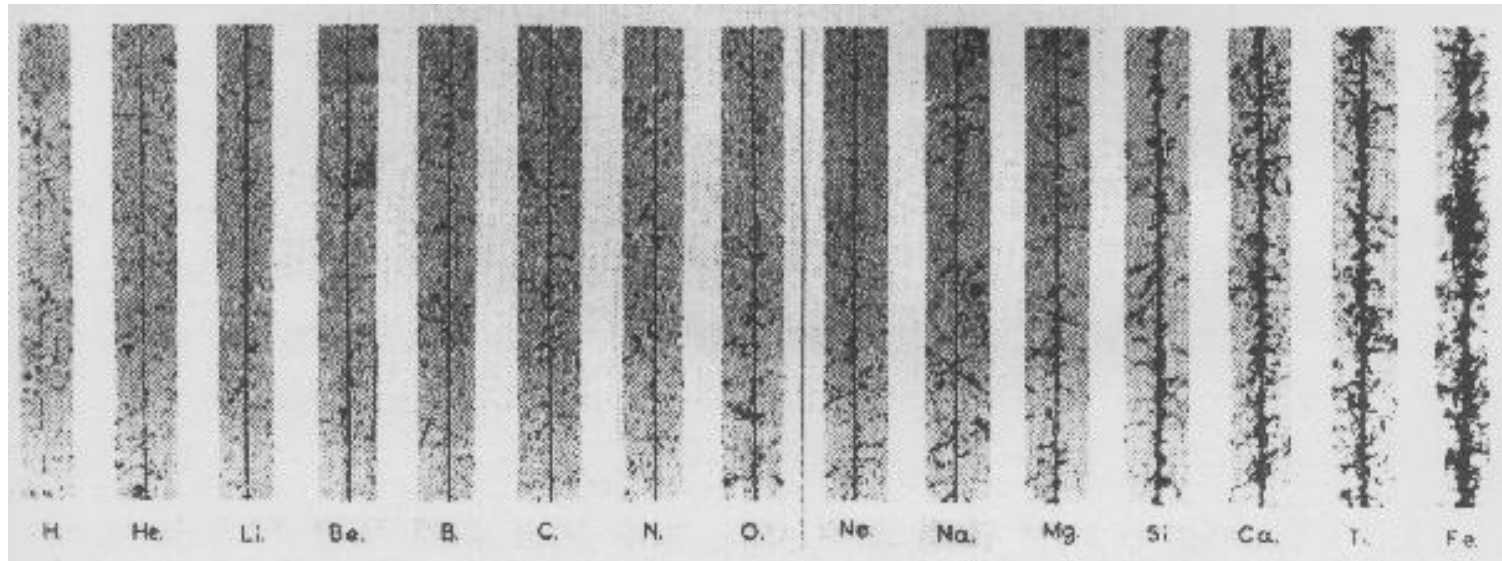

The cosmic ray composition was studied by putting detectors on balloons flying at high altitude.

Nuclear Emulsion

First evidence of the decay of the Kaon into 3 Pions was found in 1949.

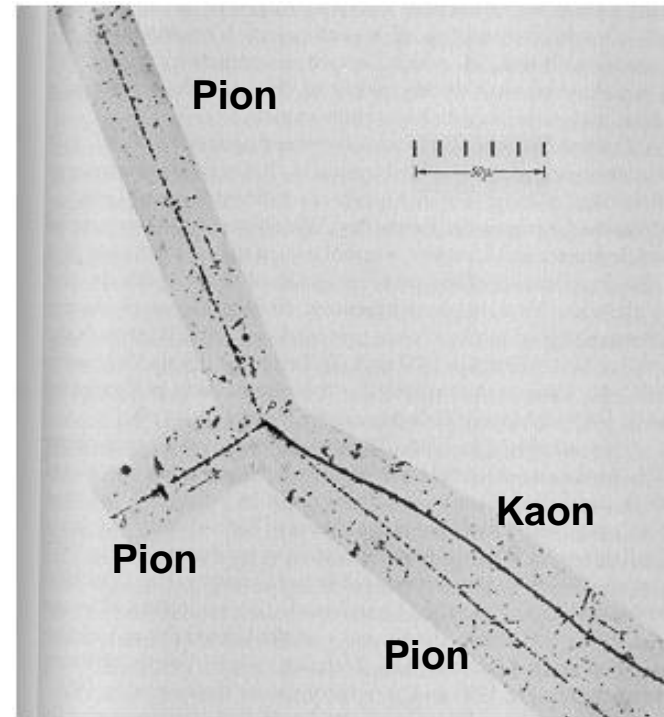
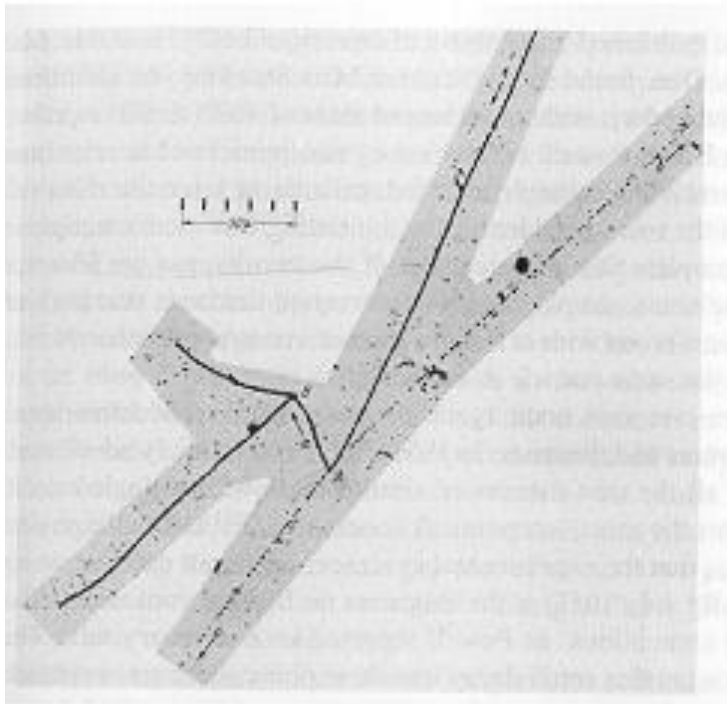

Particles in the mid 50ies

By 1959: 20 particles

e^- : fluorescent screen

n : ionization chamber

7 Cloud Chamber:

e^+

μ^+, μ^-

K^0

Λ^0

Ξ^-

Σ^-

6 Nuclear Emulsion:

π^+, π^-

anti- Λ^0

Σ^+

K^+, K^-

2 Bubble Chamber:

Ξ^0

Σ^0

3 with Electronic techniques:

anti-n

anti-p

π^0

Bubble Chamber

In the early 1950ies Donald Glaser tried to build on the cloud chamber analogy:

Instead of supersaturating a gas with a vapor one would superheat a liquid. A particle depositing energy along it's path would then make the liquid boil and form bubbles along the track.

In 1952 Glaser photographed first Bubble chamber tracks. Luis Alvarez was one of the main proponents of the bubble chamber.

The size of the chambers grew quickly

1954: 2.5''(6.4cm)

1954: 4'' (10cm)

1956: 10'' (25cm)

1959: 72'' (183cm)

1963: 80'' (203cm)

1973: 370cm

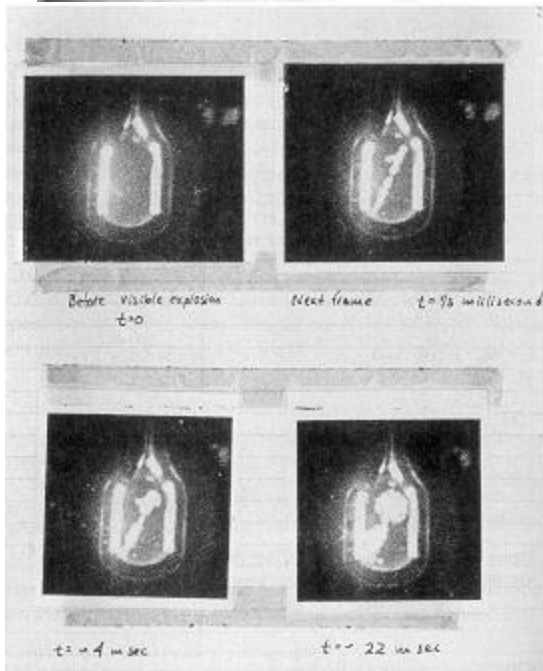
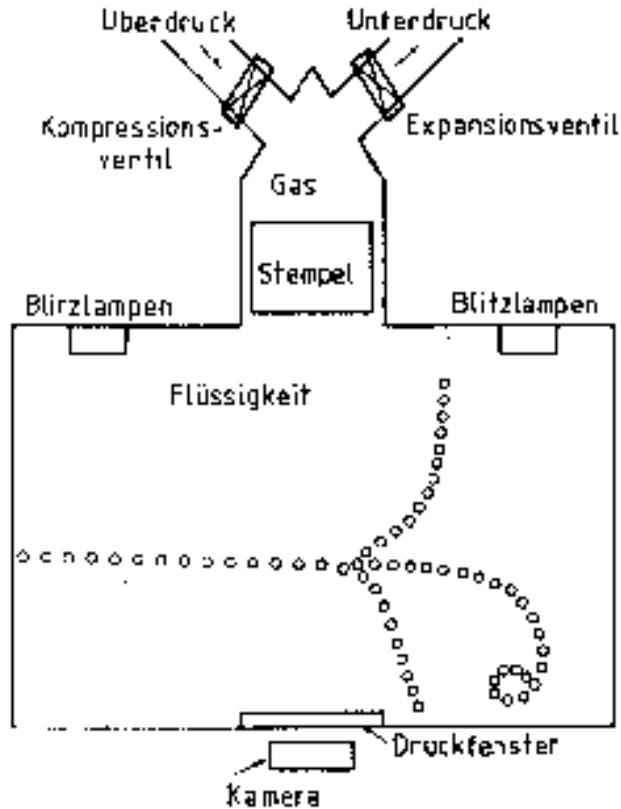
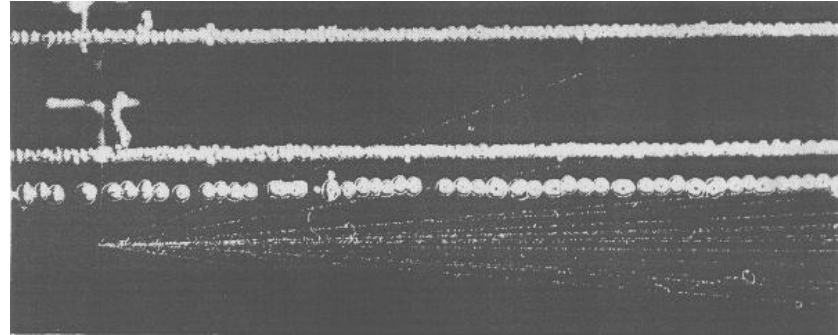

Figure 5.5 - Bubble chamber movies (1952). Glaser first filmed distinct tracks

Bubble Chamber



'old bubbles'



'new bubbles'

Unlike the Cloud Chamber, the Bubble Chamber could not be triggered, i.e. the bubble chamber had to be already in the superheated state when the particle was entering. It was therefore not useful for Cosmic Ray Physics, but as in the 50ies particle physics moved to accelerators it was possible to synchronize the chamber compression with the arrival of the beam.

For data analysis one had to look through millions of pictures.

Bubble Chamber

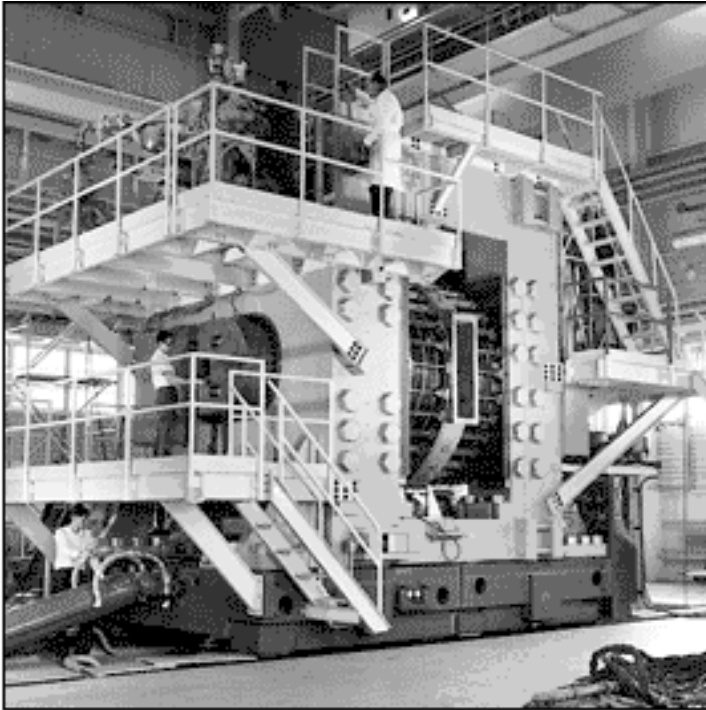

The 80-inch Bubble Chamber

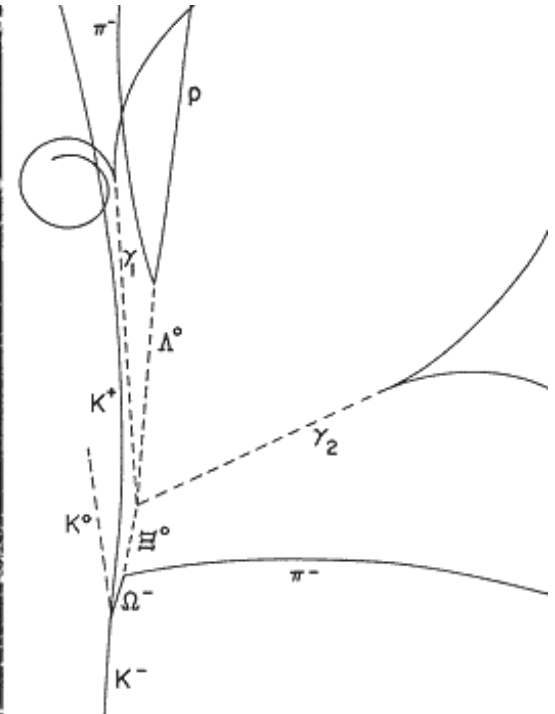
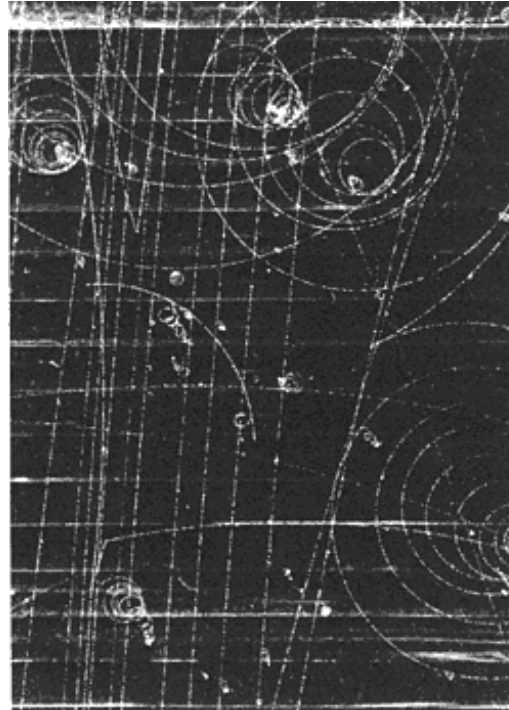

BNL, First Pictures 1963, 0.03s cycle

Discovery of the Ω^- in 1964

Bubble Chamber



Gargamelle, a very large heavy-liquid (freon) chamber constructed at Ecole Polytechnique in Paris, came to CERN in 1970. It was 2 m in diameter, 4 m long and filled with Freon at 20 atm.

With a conventional magnet producing a field of almost 2 T, Gargamelle in 1973 was the tool that permitted the discovery of neutral currents.

Can be seen outside the Microcosm Exhibition

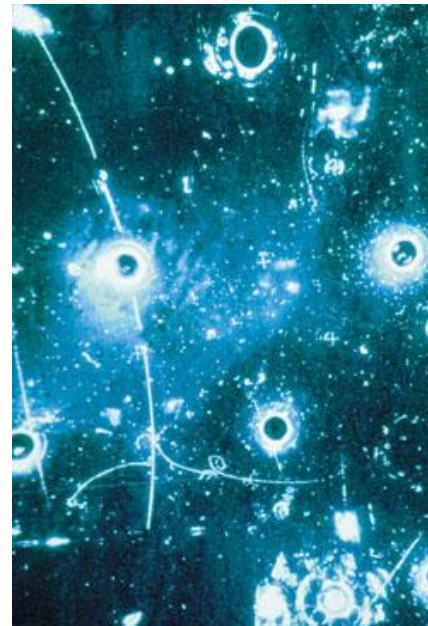

Bubble Chamber

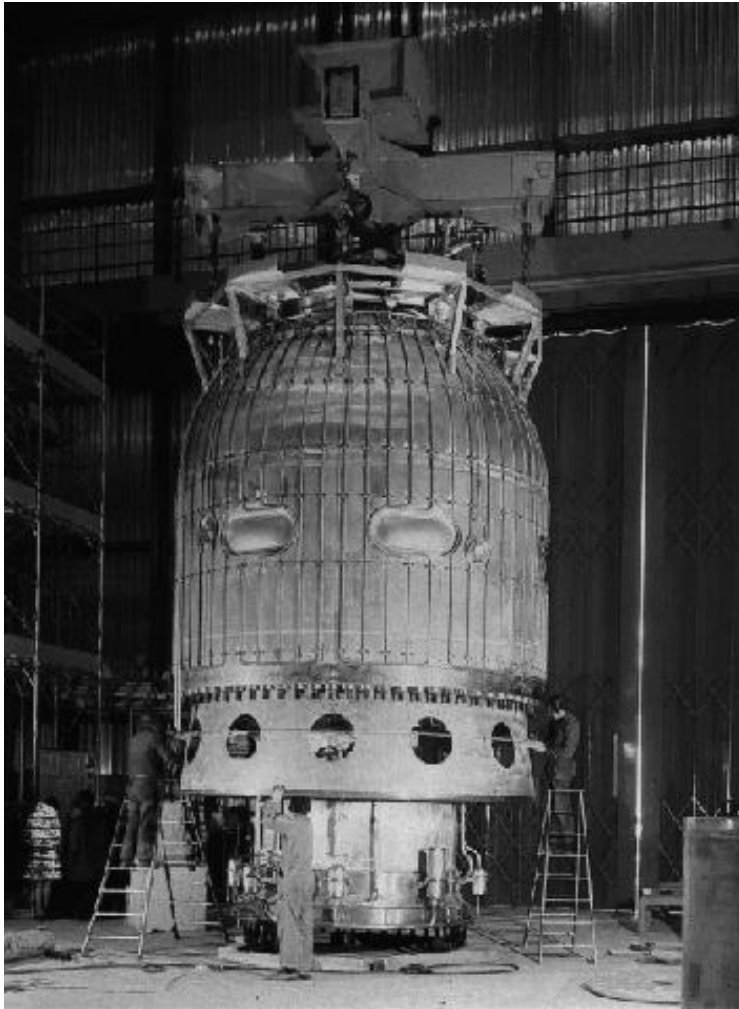

3.7 meter hydrogen bubble chamber at CERN, equipped with the largest superconducting magnet in the world.

During its working life from 1973 to 1984, the "Big European Bubble Chamber" (BEBC) took over 6 million photographs.

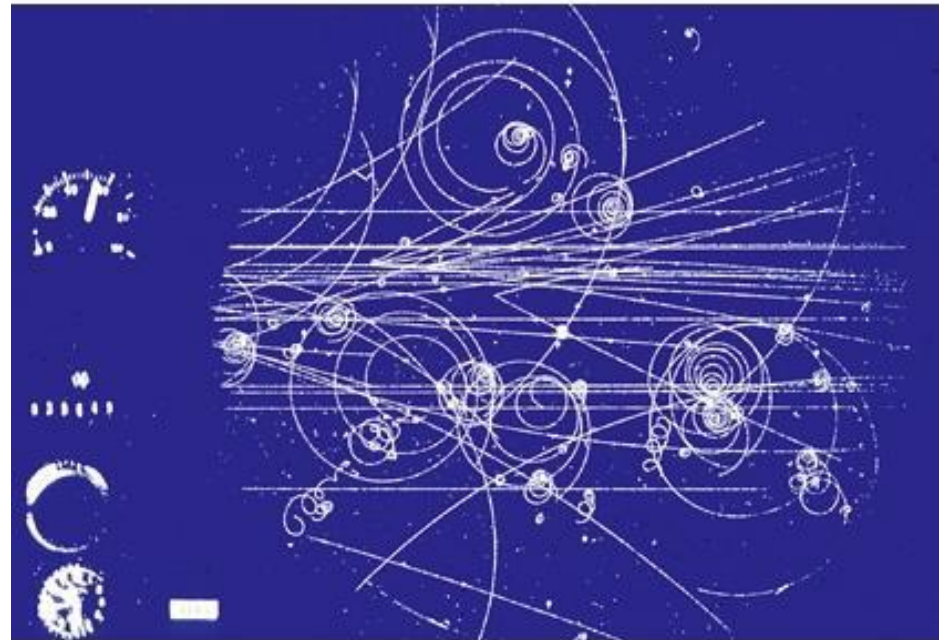

Can be seen outside the Microcosm Exhibition

Bubble Chambers

The excellent position ($5\mu\text{m}$) resolution and the fact that target and detecting volume are the same (H chambers) makes the Bubble chamber almost unbeatable for reconstruction of complex decay modes.

The drawback of the bubble chamber is the low rate capability (a few tens/ second). E.g. LHC 10^9 collisions/s.

The fact that it cannot be triggered selectively means that every interaction must be photographed.

Analyzing the millions of images by 'operators' was a quite laborious task.

That's why electronics detectors took over in the 70ties.

Logic and Electronics

Early Days of 'Logic Detectors'

Scintillating Screen:

Rutherford Experiment 1911, Zinc Sulfide screen was used as detector.

If an alpha particle hits the screen, a flash can be seen through the microscope.

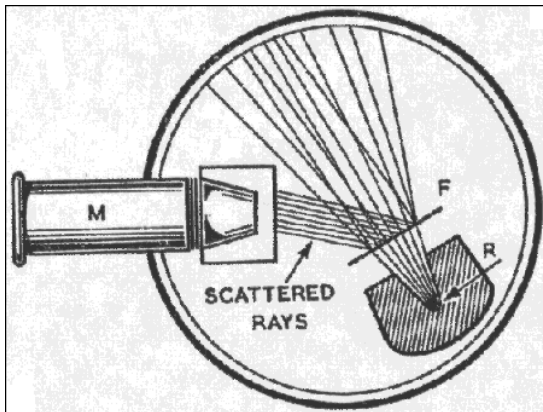

Electroscope:

When the electroscope is given an electric charge the two 'wings' repel each other and stand apart.

Radiation can ionize some of the air in the electroscope and allow the charge to leak away, as shown by the wings slowly coming back together.

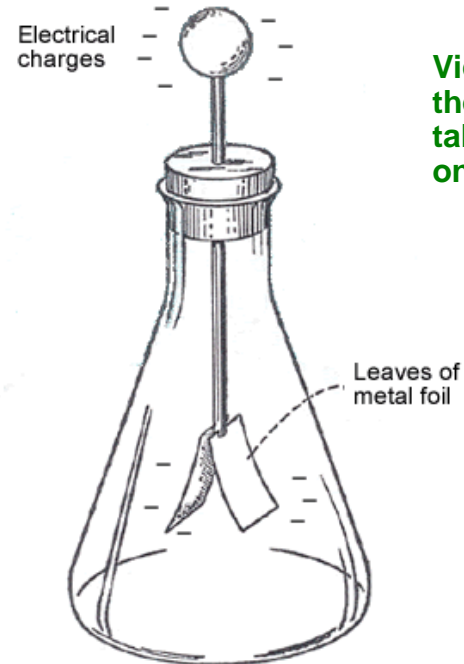

Victor Hess discovered the Cosmic Rays by taking an electroscope on a Balloon

Geiger Rutherford

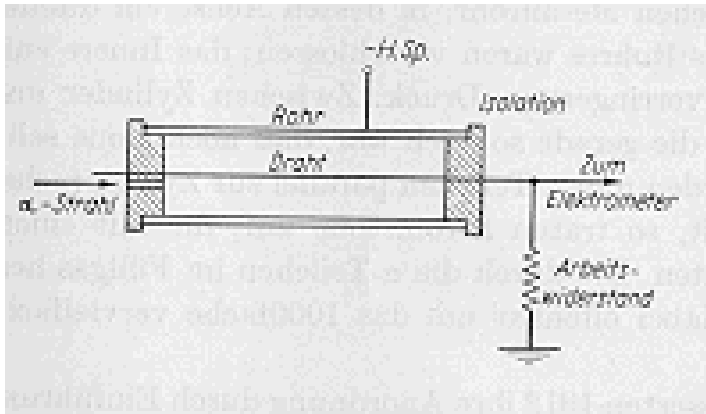

Rutherford and Geiger 1908

In 1908, Rutherford and Geiger developed an electric device to measure alpha particles.

The alpha particles ionize the gas, the electrons drift to the wire in the electric field and they multiply there, causing a large discharge which can be measured by an electroscop.

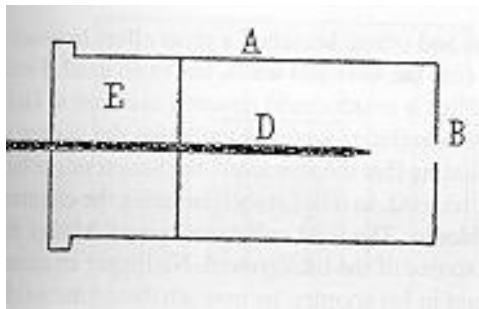

Tip counter, Geiger 1913

The 'random discharges' in absence of alphas were interpreted as 'instability', so the device wasn't used much.

As an alternative, Geiger developed the tip counter, that became standard for radioactive experiments for a number of years.

Detector + Electronics 1929

In 1928 Walther Müller started to study the spontaneous discharges systematically and found that they were actually caused by cosmic rays discovered by Victor Hess in 1911.

By realizing that the wild discharges were not a problem of the counter, but were caused by cosmic rays, the Geiger-Müller counter went, without altering a single screw from a device with 'fundamental limits' to the most sensitive instrument for cosmic rays physics.

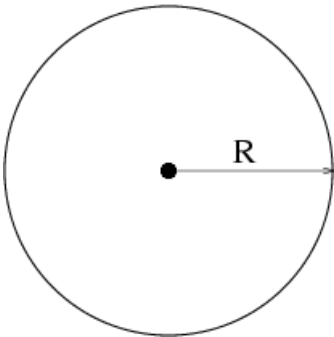

'Zur Vereinfachung von Koinzidenzzählungen'
W. Bothe, November 1929

Coincidence circuit for 2 tubes

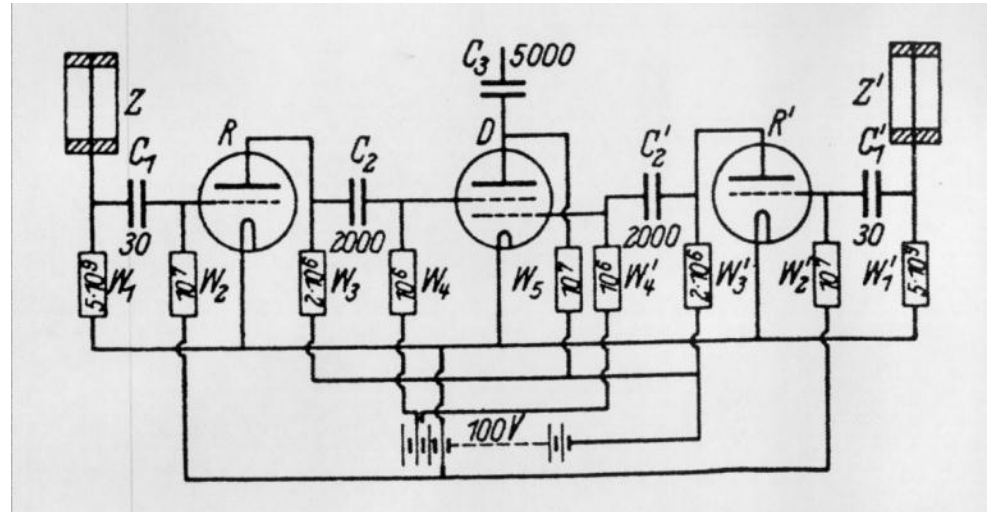

1930 - 1934

Cosmic ray telescope 1934

Rossi 1930: Coincidence circuit for n tubes

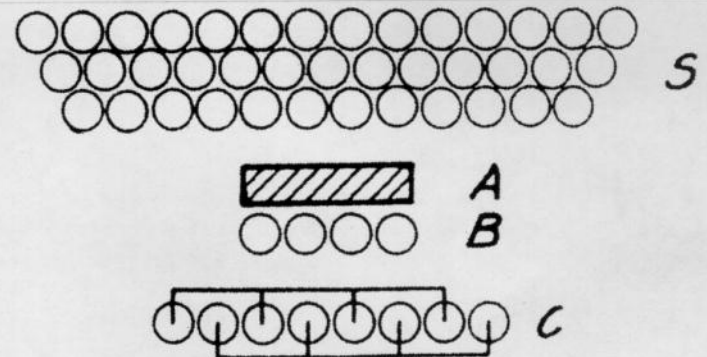
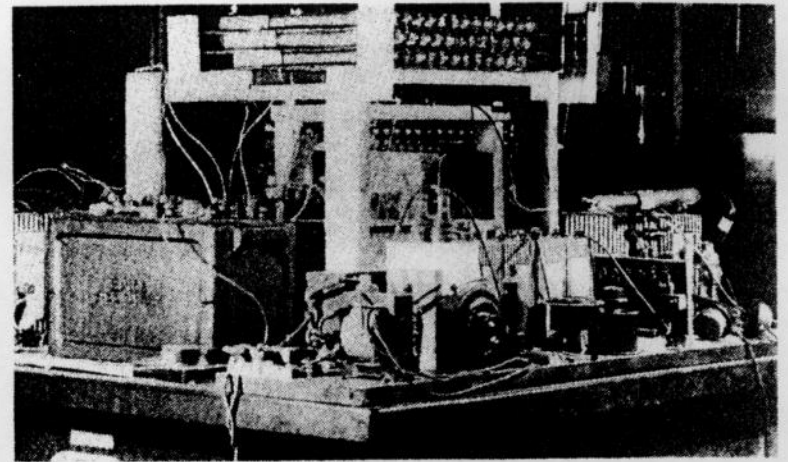
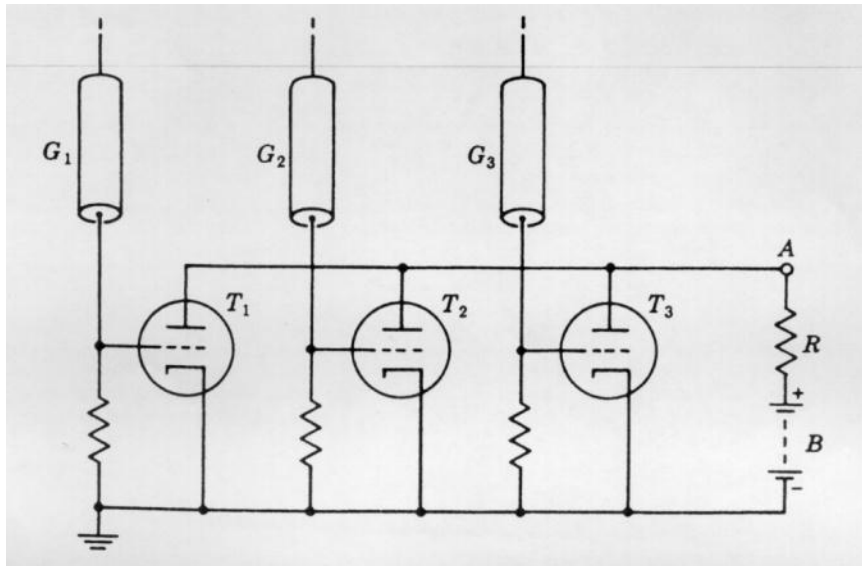

Geiger Counters

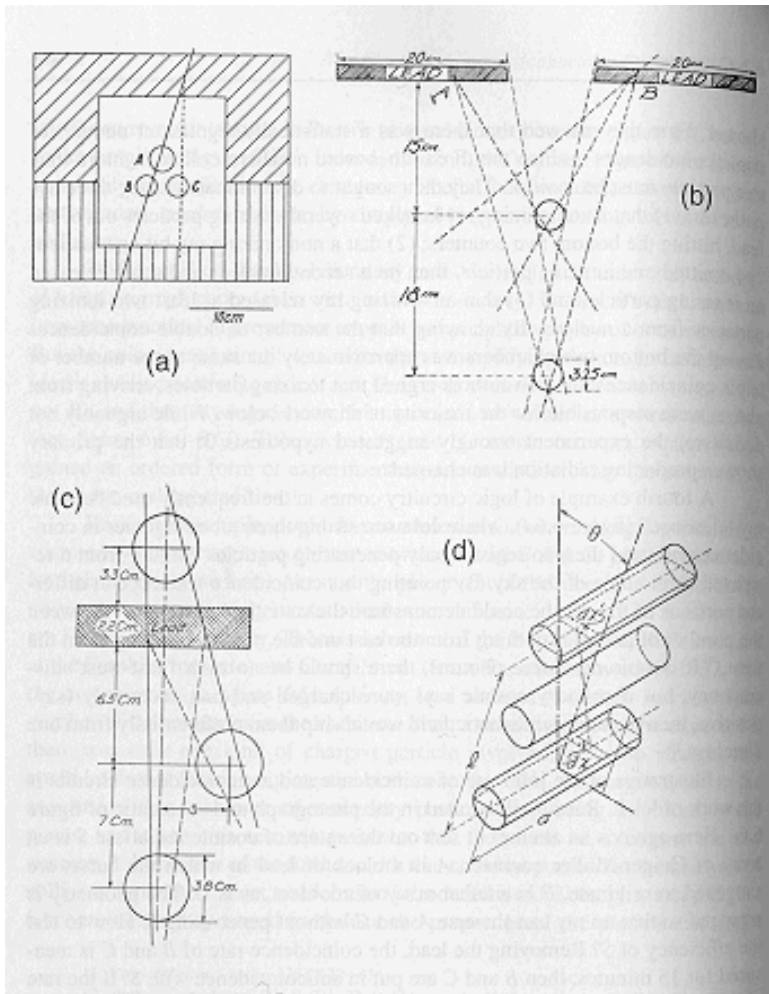

By performing coincidences of Geiger Müller tubes e.g. the angular distribution of cosmic ray particles could be measured.

Scintillators, Cerenkov light, Photomultipliers

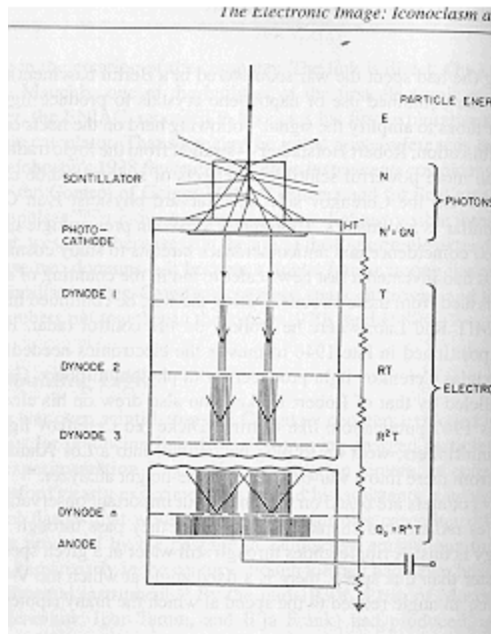

In the late 1940ies, scintillation counters and Cerenkov counters exploded into use.

Scintillation of materials on passage of particles was long known.

By mid 1930 the bluish glow that accompanied the passage of radioactive particles through liquids was analyzed and largely explained (Cerenkov Radiation).

Mainly the electronics revolution begun during the war initiated this development.

High-gain photomultiplier tubes, amplifiers, scalars, pulse-height analyzers.

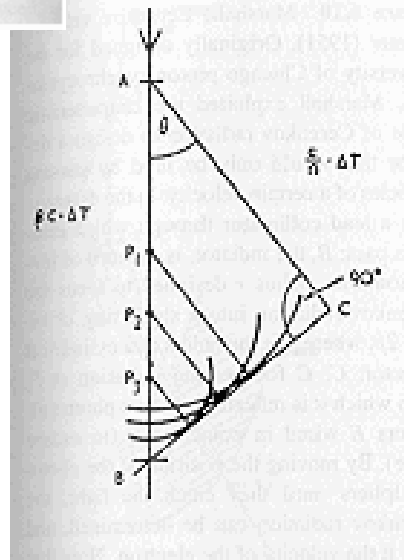

Antiproton

One was looking for a negative particle with the mass of the proton. With a bending magnet, a certain particle momentum was selected ($p=mv\gamma$).

Since Cerenkov radiation is only emitted if $v > c/n$, two Cerenkov counters (C1, C2) were set up to measure a velocity comparable with the proton mass.

In addition the time of flight between S1 and S2 was required to be between 40 and 51 ns, selecting the same mass.

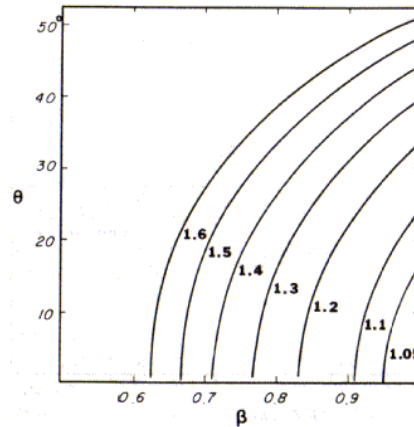
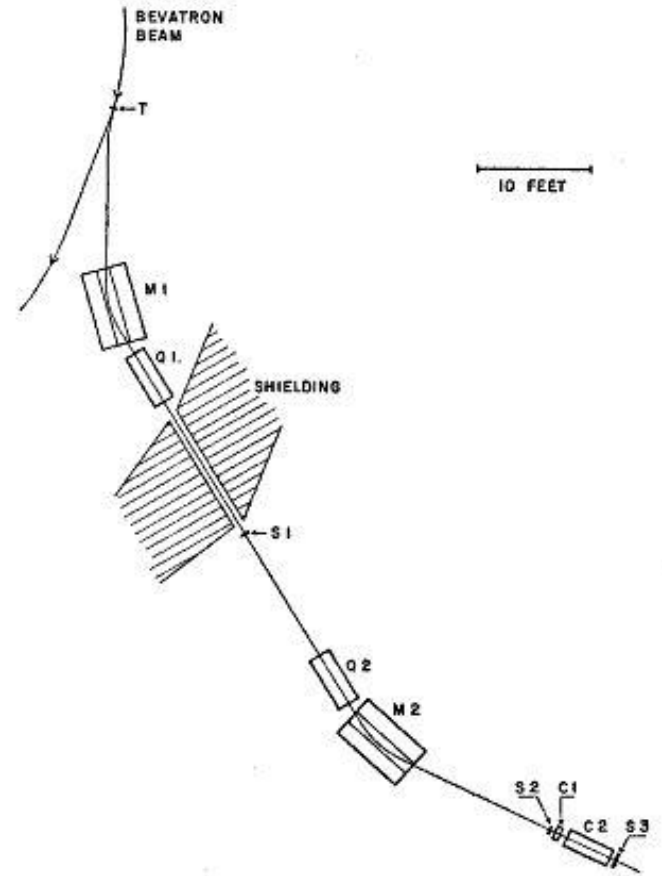

Anti Neutrino Discovery 1959

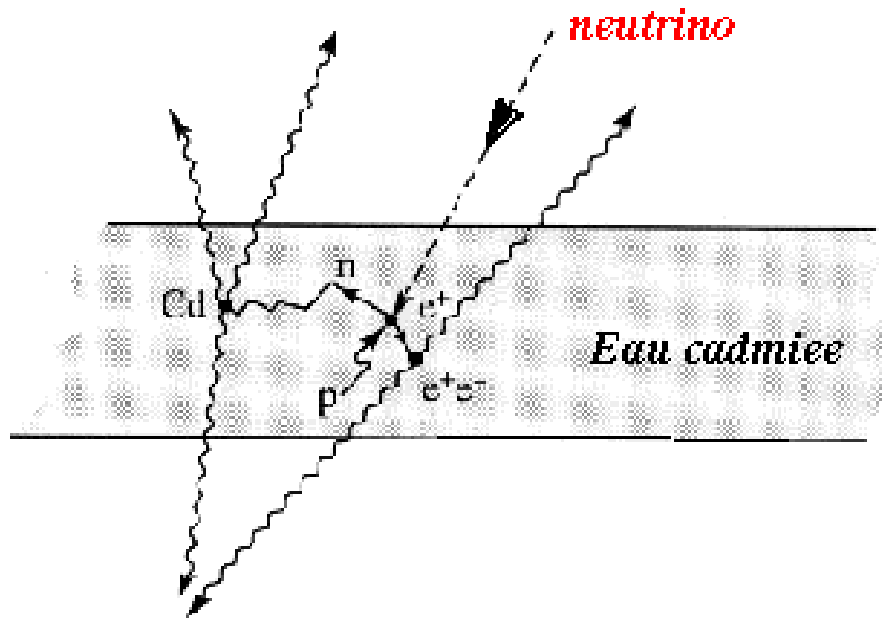

Reines and Cowan experiment principle consisted in using a target made of around 400 liters of a mixture of water and cadmium chloride.

The anti-neutrino coming from the nuclear reactor interacts with a proton of the target matter, giving a positron and a neutron.

The positron annihilates with an electron of the surrounding material, giving two simultaneous photons and the neutron slows down until it is eventually captured by a cadmium nucleus, implying the emission of photons some 15 microseconds after those of the positron annihilation.

Spark Counters

The Spark Chamber was developed in the early 60ies.

Schwartz, Steinberger and Lederman used it in discovery of the muon neutrino

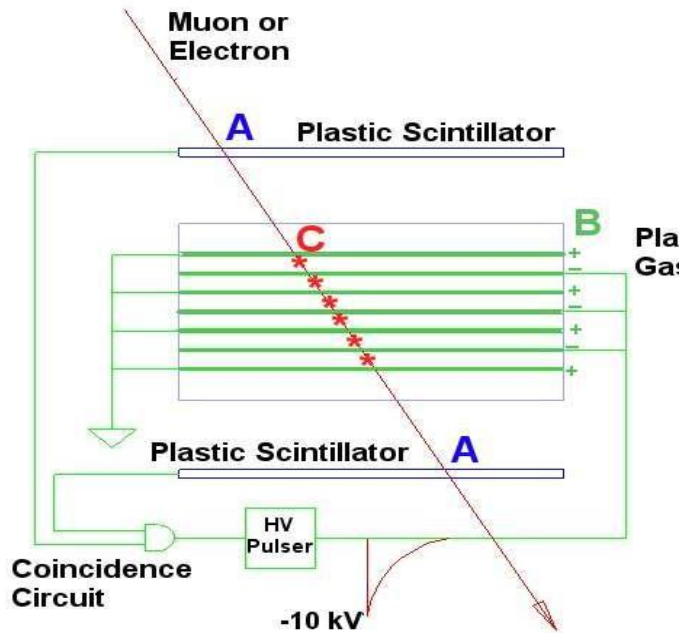

A charged particle traverses the detector and leaves an ionization trail.

The scintillators trigger an HV pulse between the metal plates and sparks form in the place where the ionization took place.

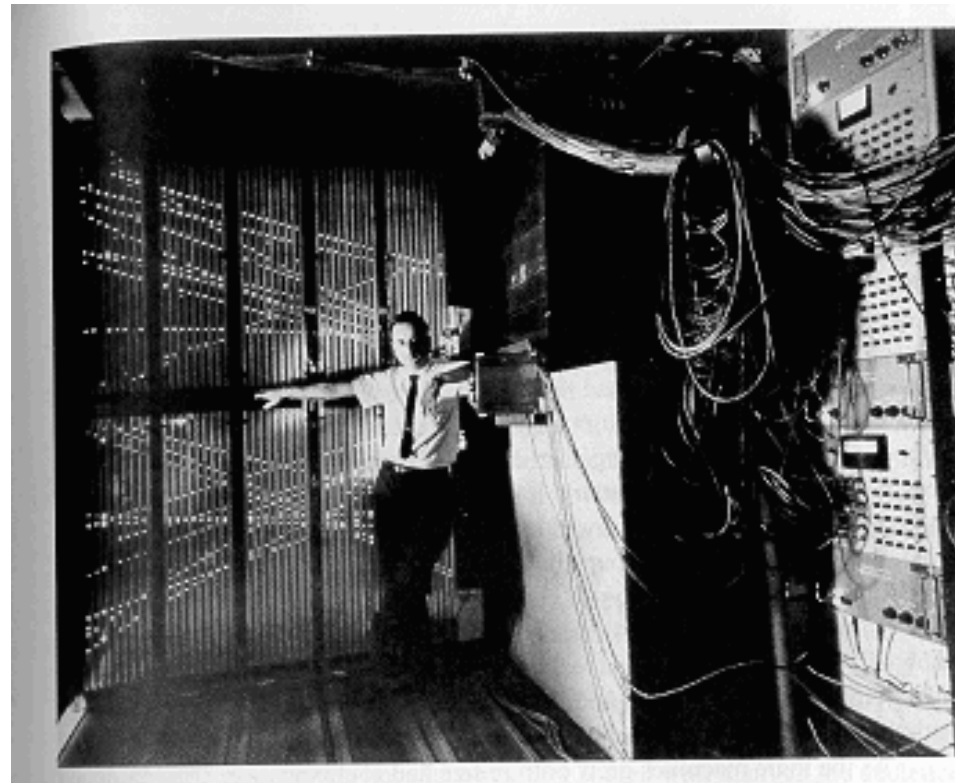

Multi Wire Proportional Chamber

Tube, Geiger- Müller, 1928

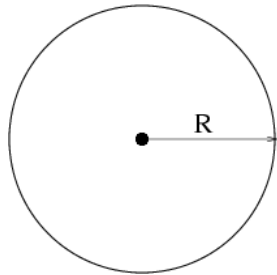

Multi Wire Geometry, in H. Friedmann 1949

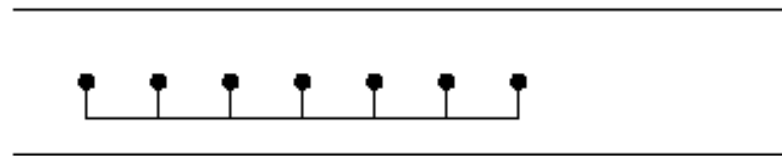

G. Charpak 1968, Multi Wire Proportional Chamber,
readout of individual wires and proportional mode working point.

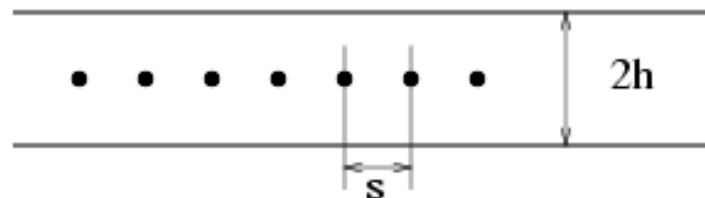

MWPC

Individual wire readout: A charged particle traversing the detector leaves a trail of electrons and ions. The wires are on positive HV. The electrons drift to the wires in the electric field and start to form an avalanche in the high electric field close to the wire. This induces a signal on the wire which can be read out by an amplifier.

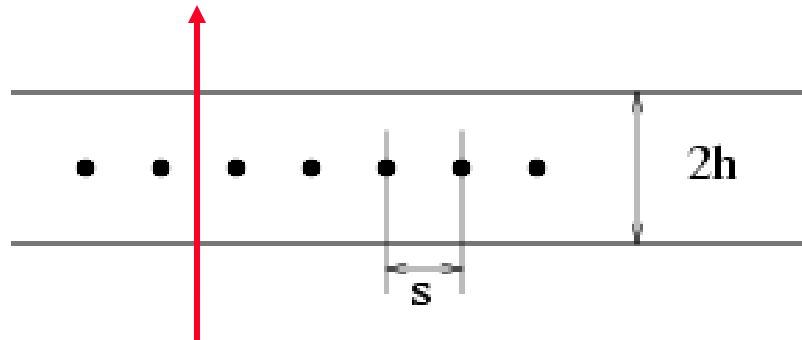

Measuring this drift time, i.e. the time between passage of the particle and the arrival time of the electrons at the wires, made this detector a precision positioning device.

The Electronic Image

**During the 1970ies, the Image and Logic devices merged into
'Electronics Imaging Devices'**

W, Z-Discovery 1983/84

UA1 used a very large wire chamber.



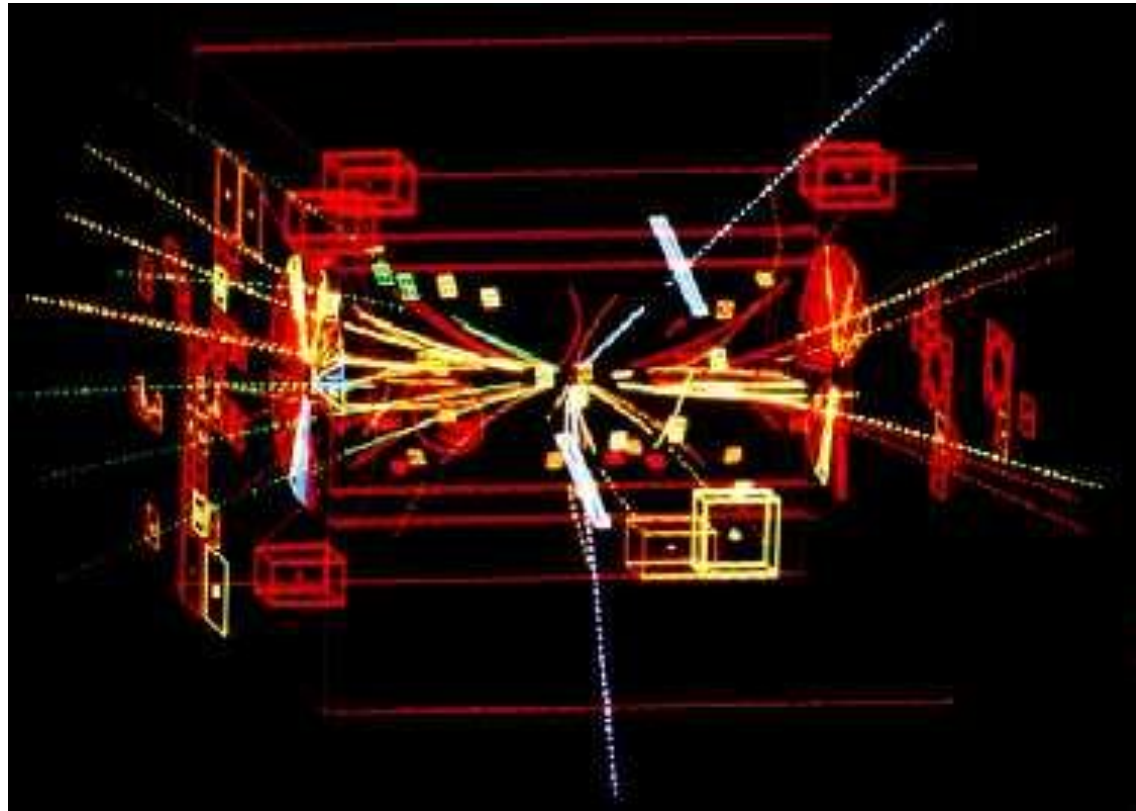



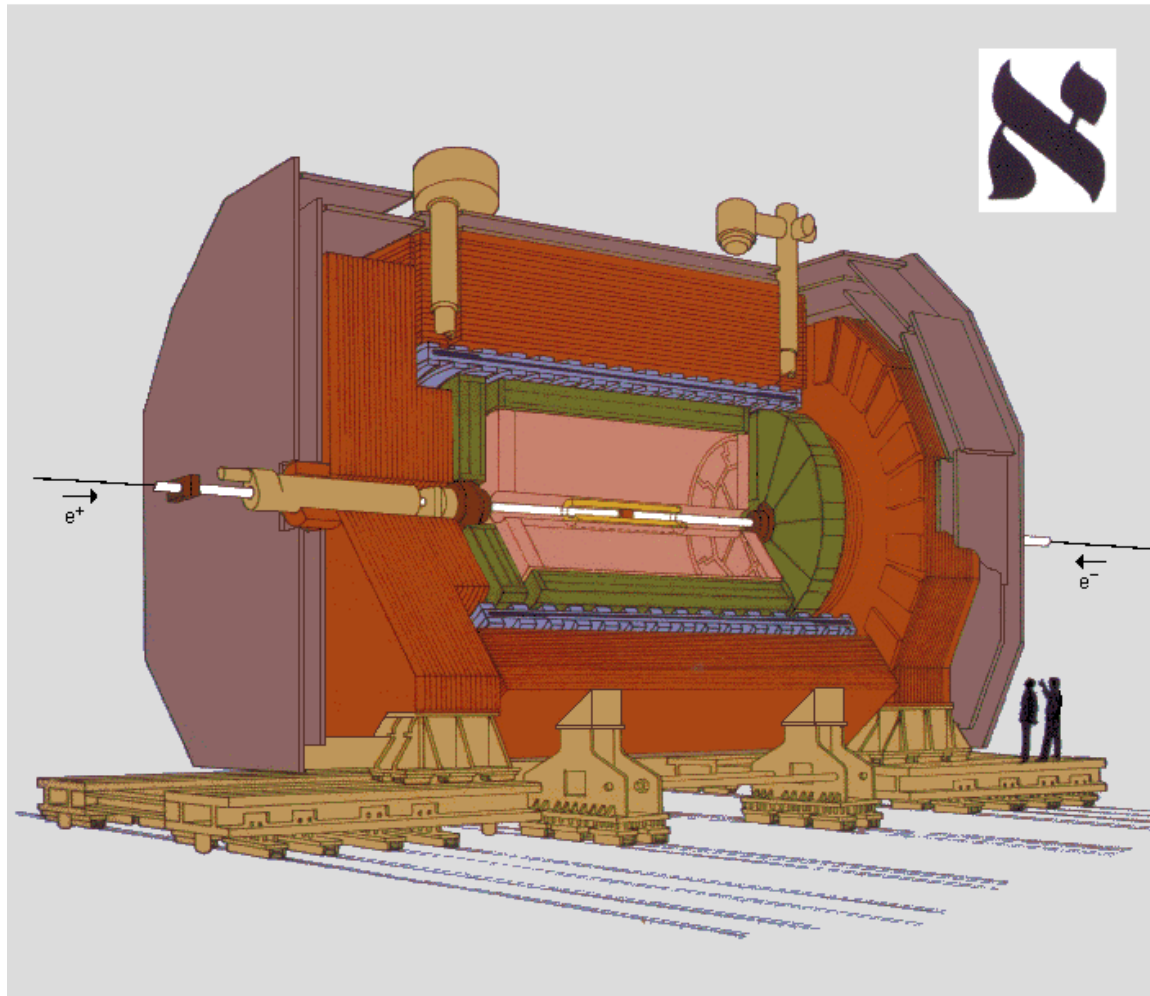

Can now be seen in the CERN Microcosm Exhibition



This computer reconstruction shows the tracks of charged particles from the proton-antiproton collision. The two white tracks reveal the Z's decay. They are the tracks of a high-energy electron and positron.

LEP 1988-2000



-  Vertex Detector
-  Inner Tracking Chamber
-  Time Projection Chamber
-  Electromagnetic Calorimeter
-  Superconducting Magnet Coil
-  Hadron Calorimeter
-  Muon Chambers
-  Luminosity Monitors

The ALEPH Detector
All Gas Detectors

LEP 1988-2000

Aleph Higgs Candidate Event: $e^+ e^- \rightarrow HZ \rightarrow \bar{b}b + jj$

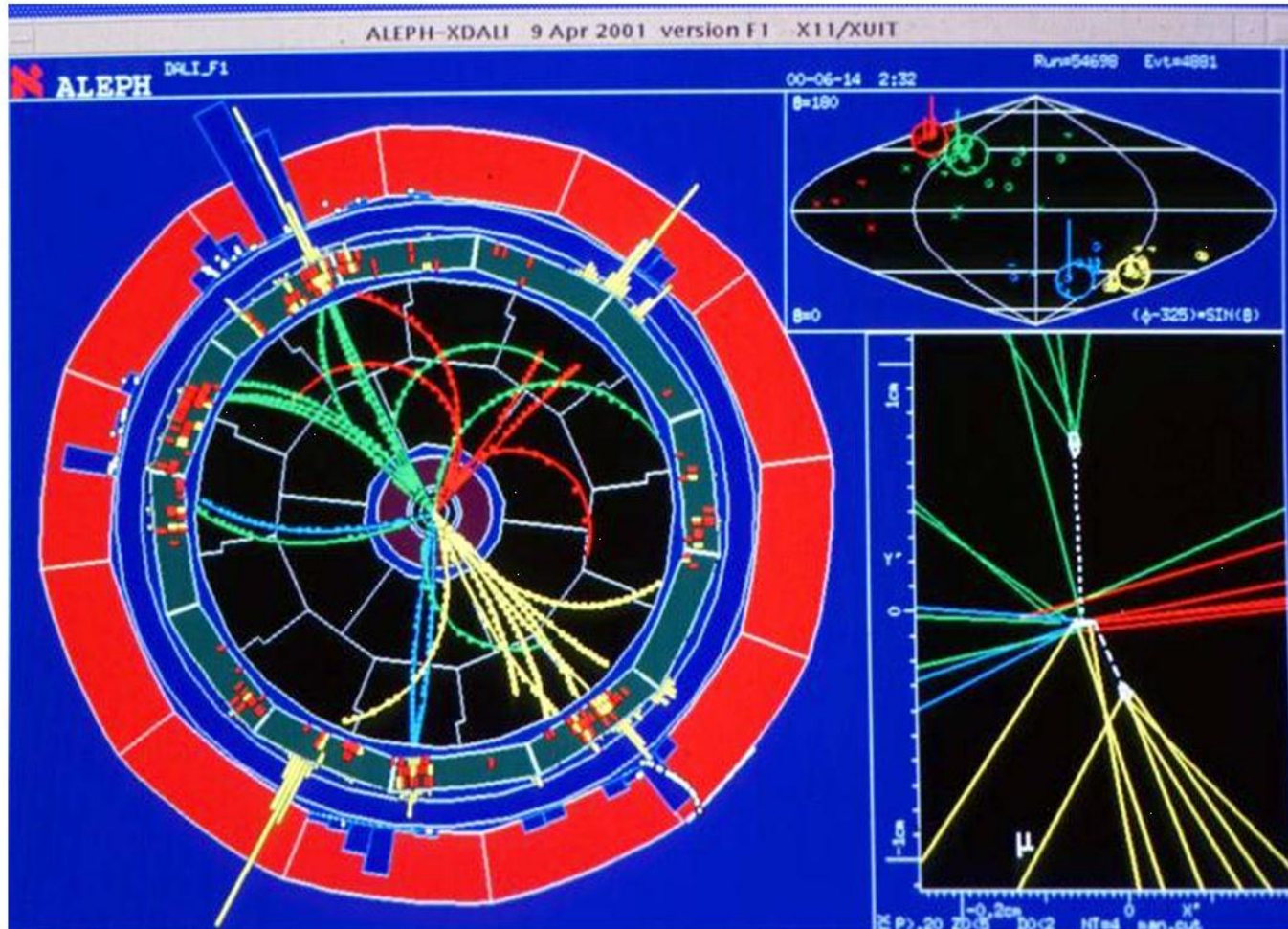

Increasing Multiplicities in Heavy Ion Collisions

**e+ e- collision in the
ALEPH Experiment/LEP.**

**Au+ Au+ collision in the
STAR Experiment/RHIC
Up to 2000 tracks**

**Pb+ Pb+ collision in the
ALICE Experiment/LHC
Up to 10 000 tracks/collision**

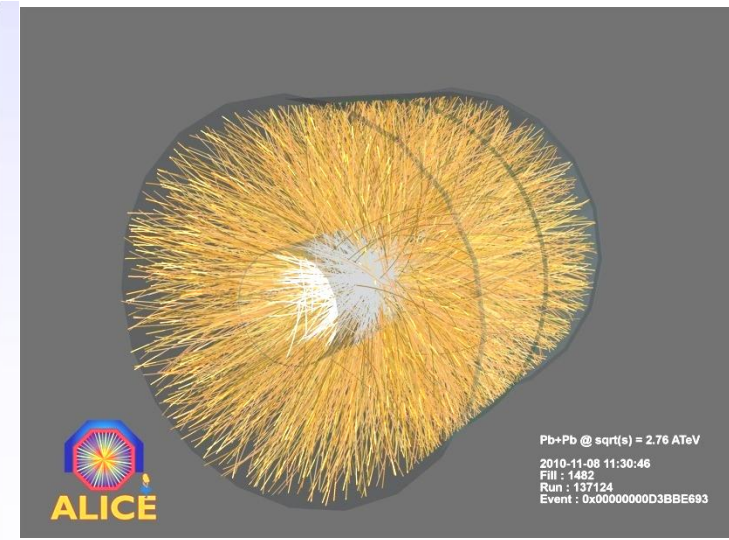
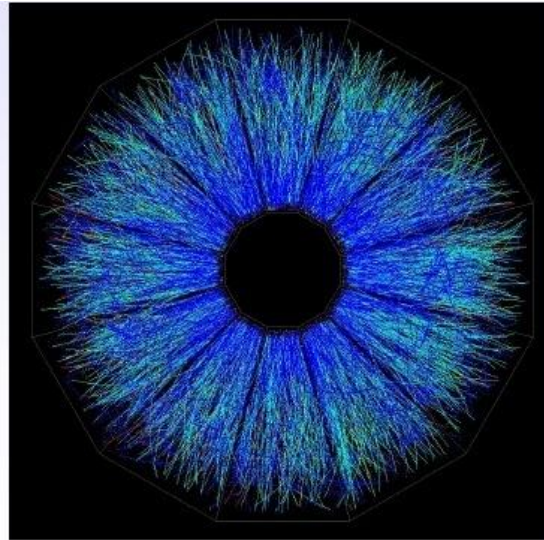
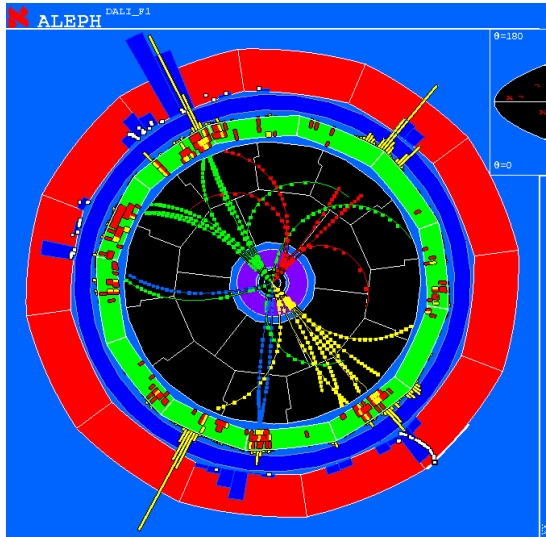

ATLAS at LHC

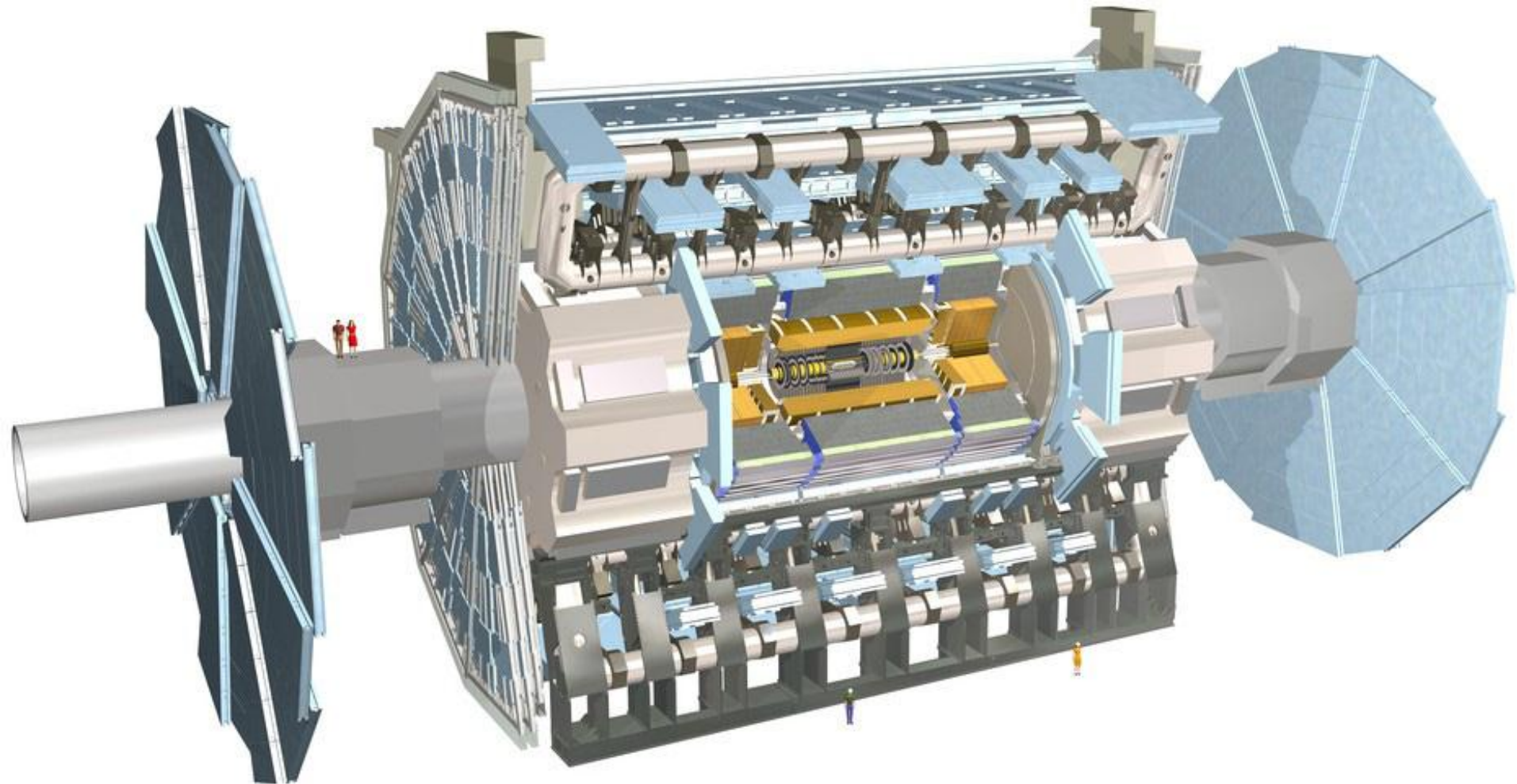

Large Hadron Collider at CERN.

The ATLAS detector uses more than 100 million detector channels.

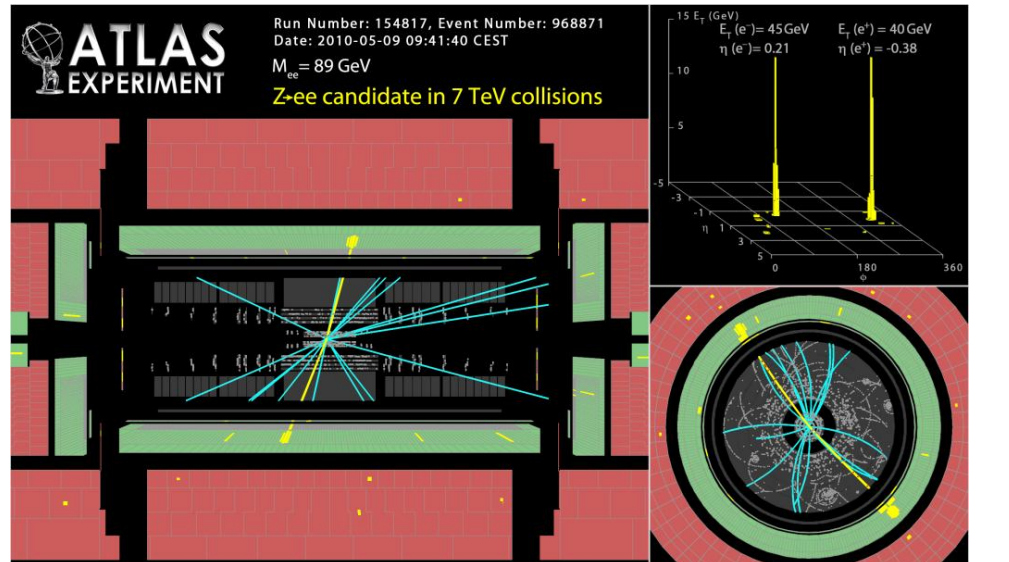
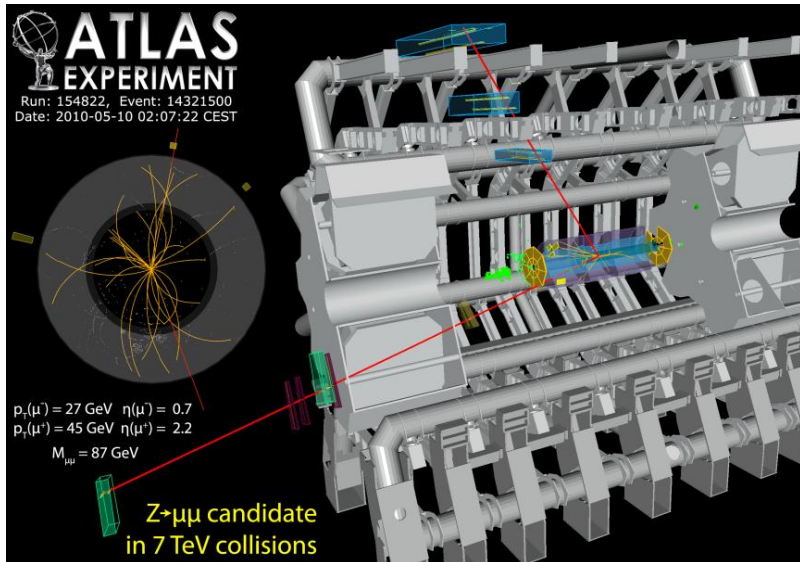
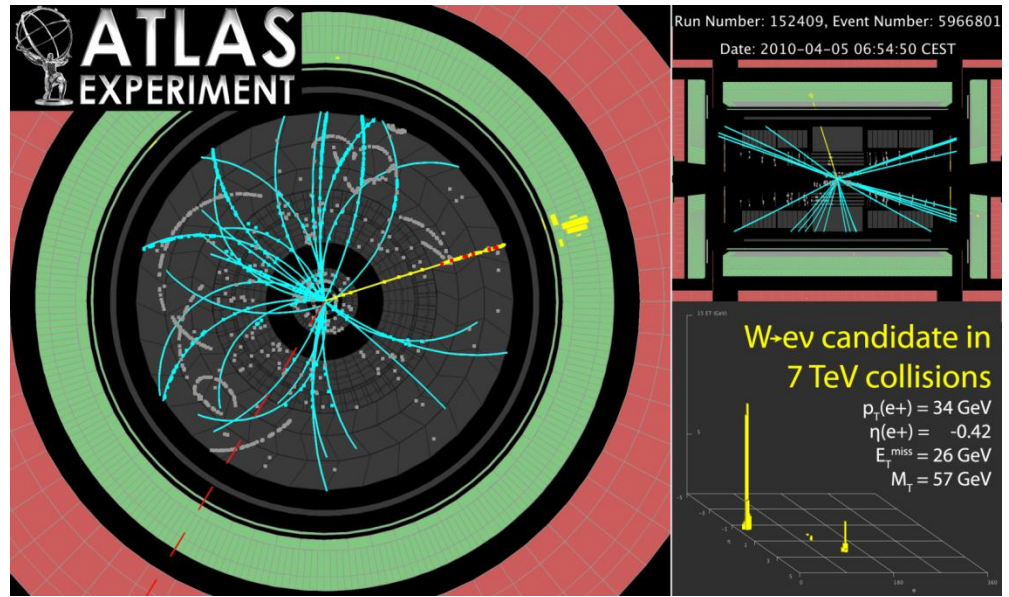
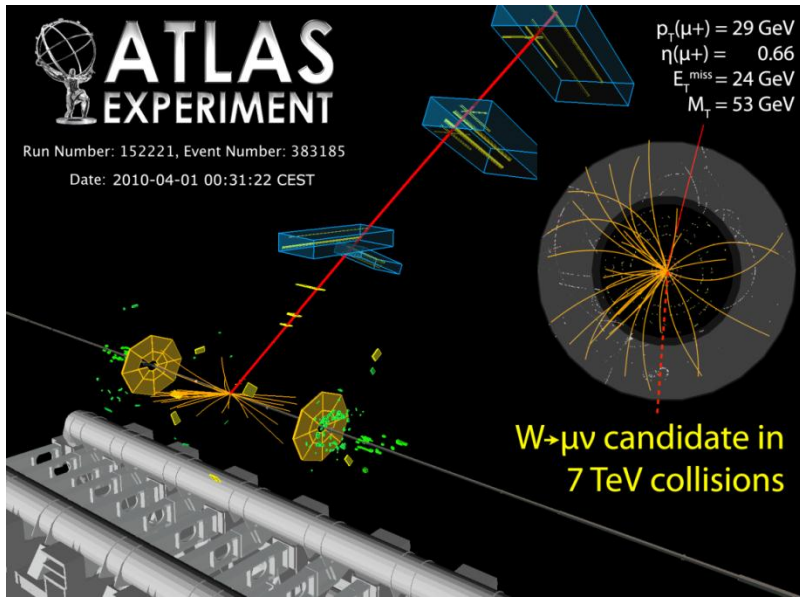

Near Future: CMS Experiment at LHC

CMS A Compact Solenoidal Detector for LHC

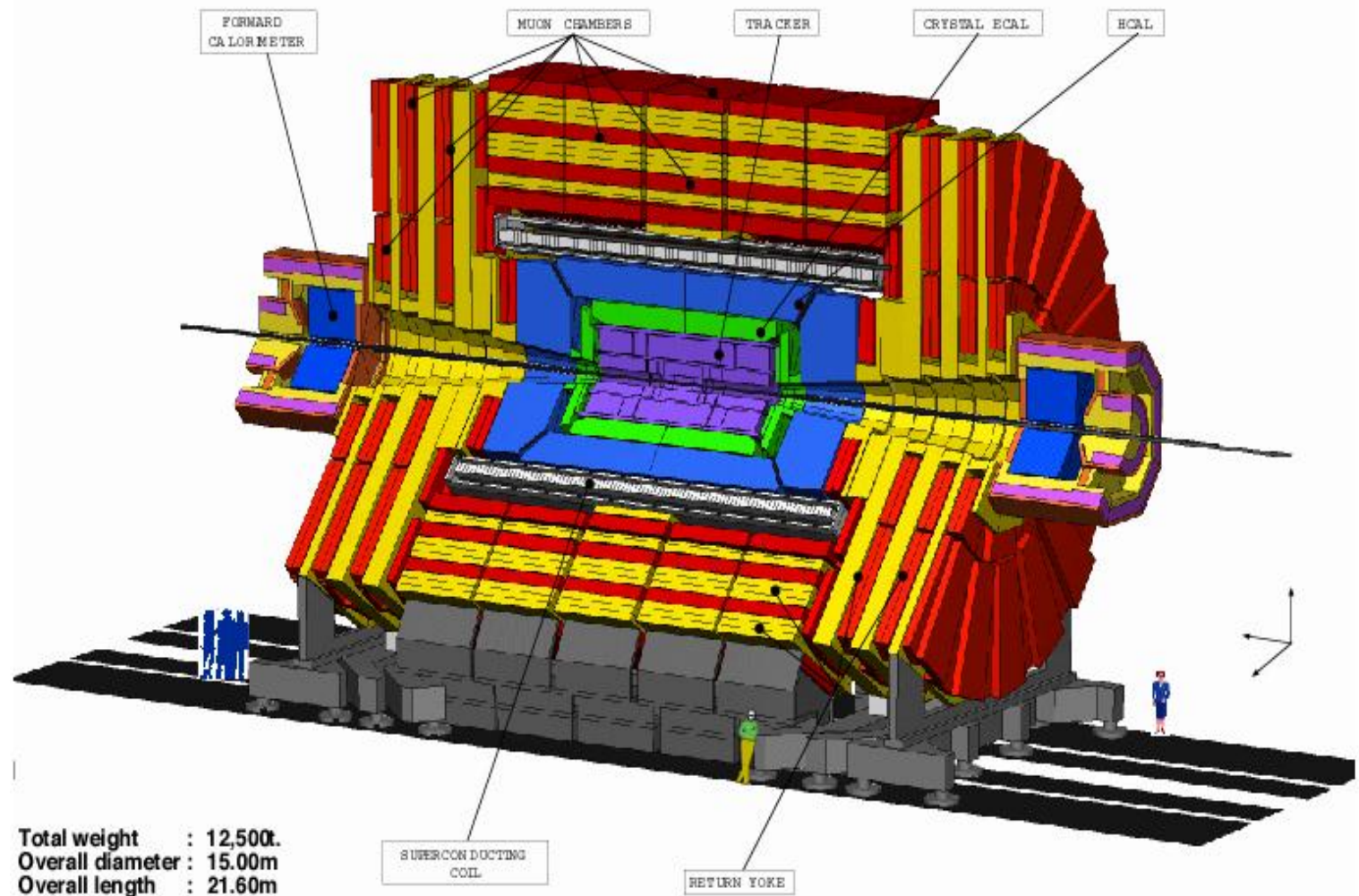

Total weight : 12,500t.
Overall diameter : 15.00m
Overall length : 21.60m
Magnetic field : 4 Tesla

Summary

- ◆ Particle physics, 'born' with the discovery of radioactivity and the electron at the end of the 19th century, has become 'Big Science' during the last 100 years.
- ◆ A large variety of instruments and techniques were developed for studying the world of particles.
- ◆ Imaging devices like the cloud chamber, emulsion and the bubble chamber took photographs of the particle tracks.
- ◆ Logic devices like the Geiger Müller counter, the scintillator or the Cerenkov detector were (and are) widely used.
- ◆ Through the electronic revolution and the development of new detectors, both traditions merged into the 'electronics image' in the 1970ies.
- ◆ Particle detectors with over 100 million readout channels are operating at this moment.