



LHC Injectors Upgrade





LHC Injectors Upgrade

PS Upgrade

Project web page

<https://espace.cern.ch/liu-project/liu-ps/default.aspx>

thanks to everyone for the contributions to this presentation

Simone Gilardoni for the PS-LIU Team

LIU-2011 November 25, 2011 CERN



J. Adams: 25 Nov. 1959 – Second day of PS stable beam operation
Intensity design $\sim 3 \cdot 10^{11}$

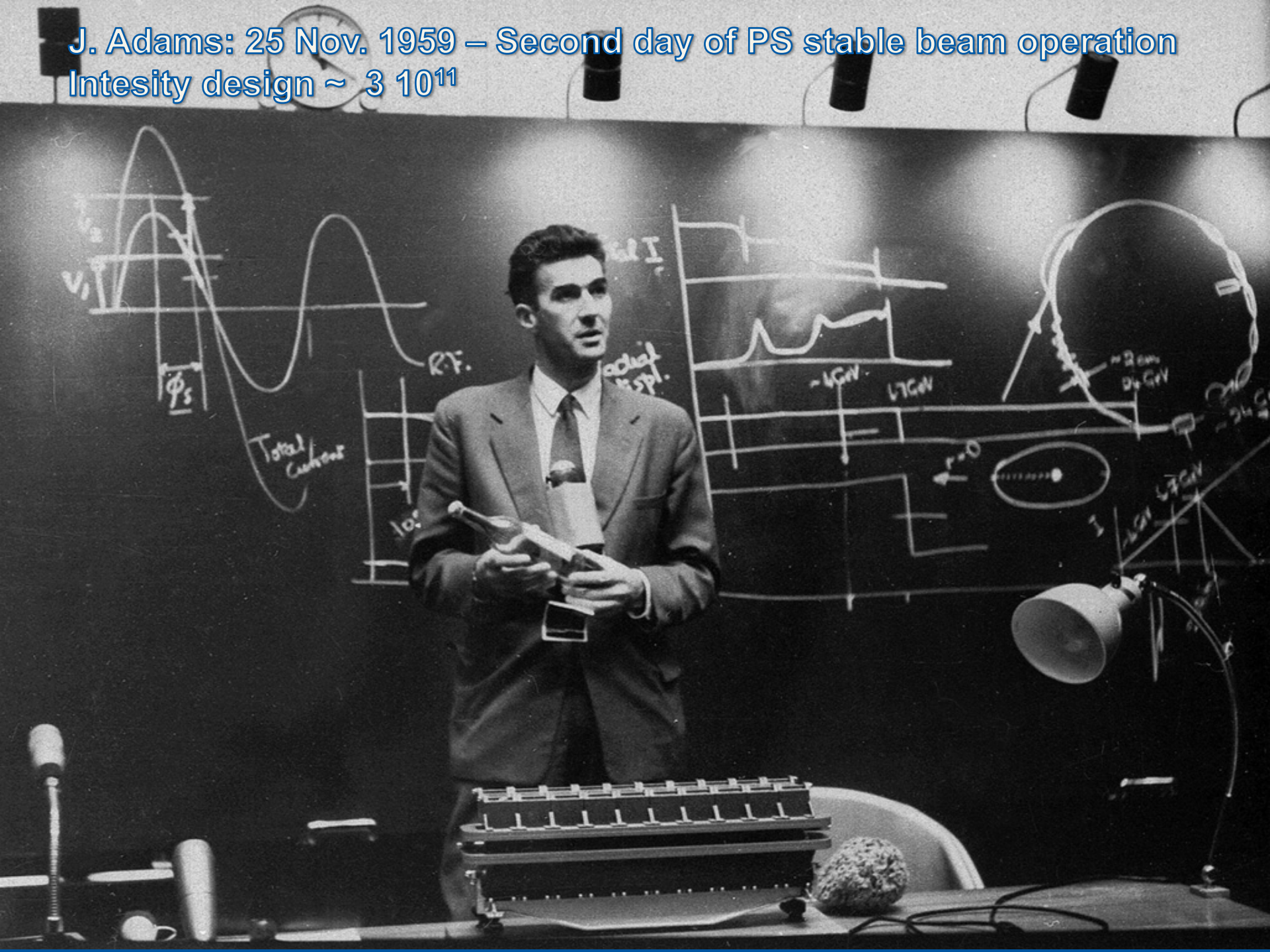



Reminder: Time structure of LHC beam

From LHC Design Report – Vol.3

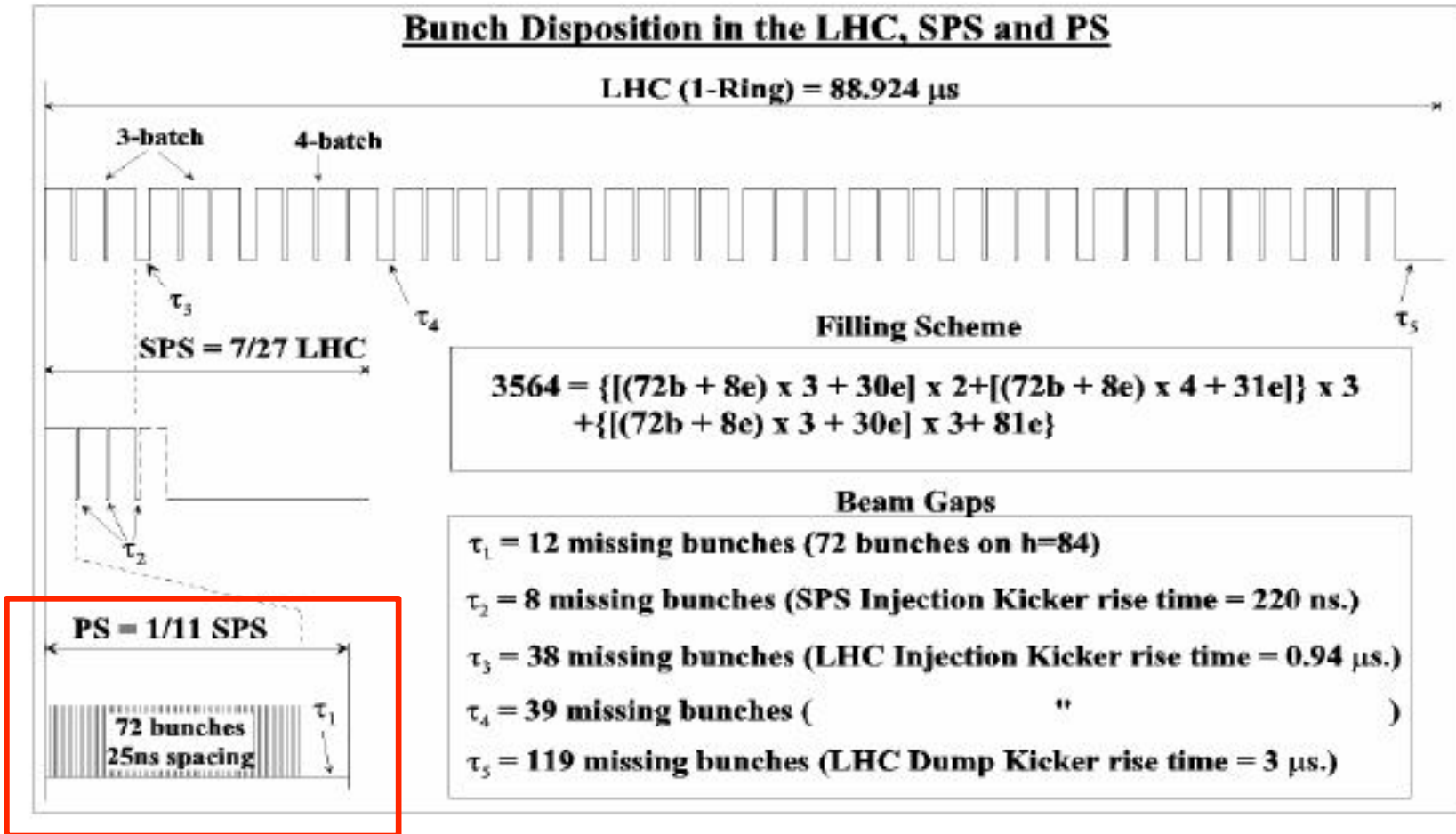

Figure 2.1: Proton bunches in the PS, SPS and one LHC ring. Note the partial filling of the SPS (3/11 or 4/11) and the voids due to kicker rise-time. One LHC ring is filled in ~3 min.



Generation of 25 ns beam in the PS

PS Upgrade
LIU Project

Double batch injection from PSB (4+2 bunches, 6 bunches for PS at $h=7$)
Transverse emittance produced in the PSB, longitudinal in the PS

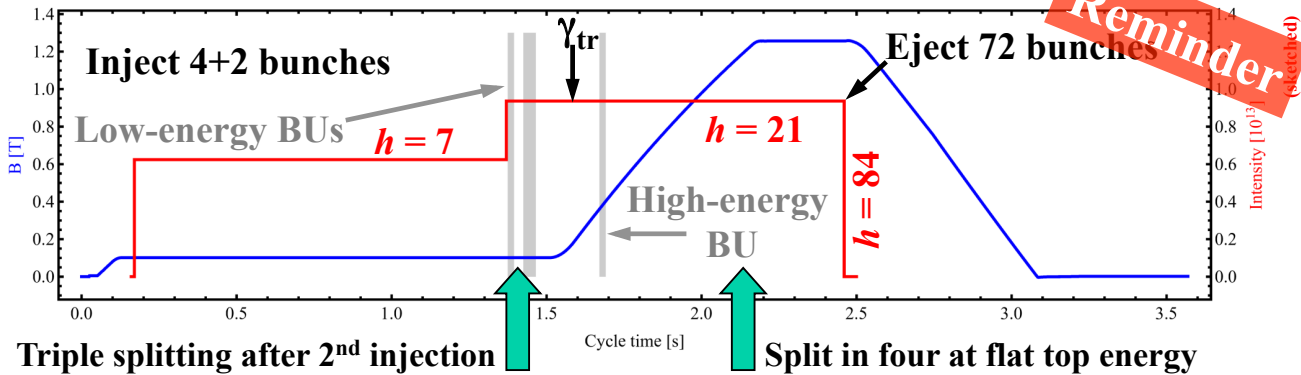

RF gymnastics in PS:

- Triple splitting
- Acceleration
- Double splitting
- Double splitting
- Bunch rotation

With 5 different RF systems

Triple splitting after 2nd injection

Split in four at flat top energy

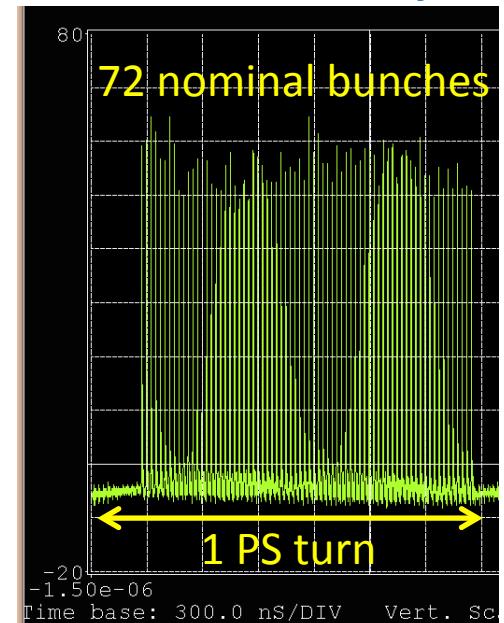
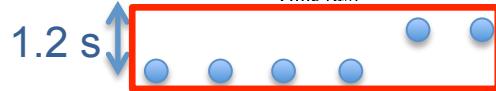
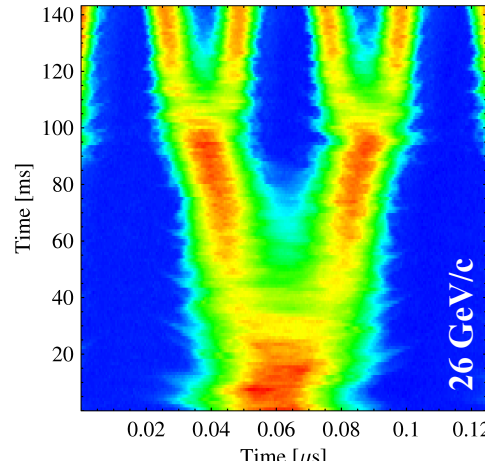
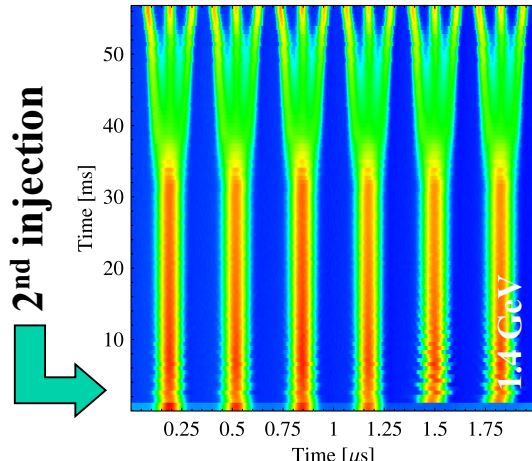

→ Each bunch from the Booster divided by 12 → $6 \times 3 \times 2 \times 2 = 72$

See S. Hancock's presentation

The role of the PS in the LHC beams production

1. Conserve the transverse emittances produced in the PSB:

- Causes of blow-up:
 - **Laslett tune shift due to space charge:** $< |0.3|$
 - Blow-up of first batch waiting for the second batch injection
 - **Can be beaten by increasing the injection energy → 2 GeV**
(Chamonix 2010 proposal from M. Giovannozzi,
reason of the previous PSB extraction energy upgrade from 1 to 1.4 GeV)
- Injection mis-steering/oscillations → *good transverse damper needed*
- Other effects: head-tail instability at injection energy (→ *good transverse damper needed*), TMCI at transition crossing, electron cloud at extraction.

2. Define the longitudinal structure of the beam

- **25-50-75-150 ns** bunch spacings are defined by RF gymnastics in the PS.
- Longitudinal beam quality can be spoiled mainly by coupled-bunch instabilities (ϵ_1) and transient beam loading (bunch-to-bunch equalization).



Today's known limitations

PS Upgrade
LIU Project

Acceleration/Bunch splittings

Longitudinal beam stability

Transient beam loading

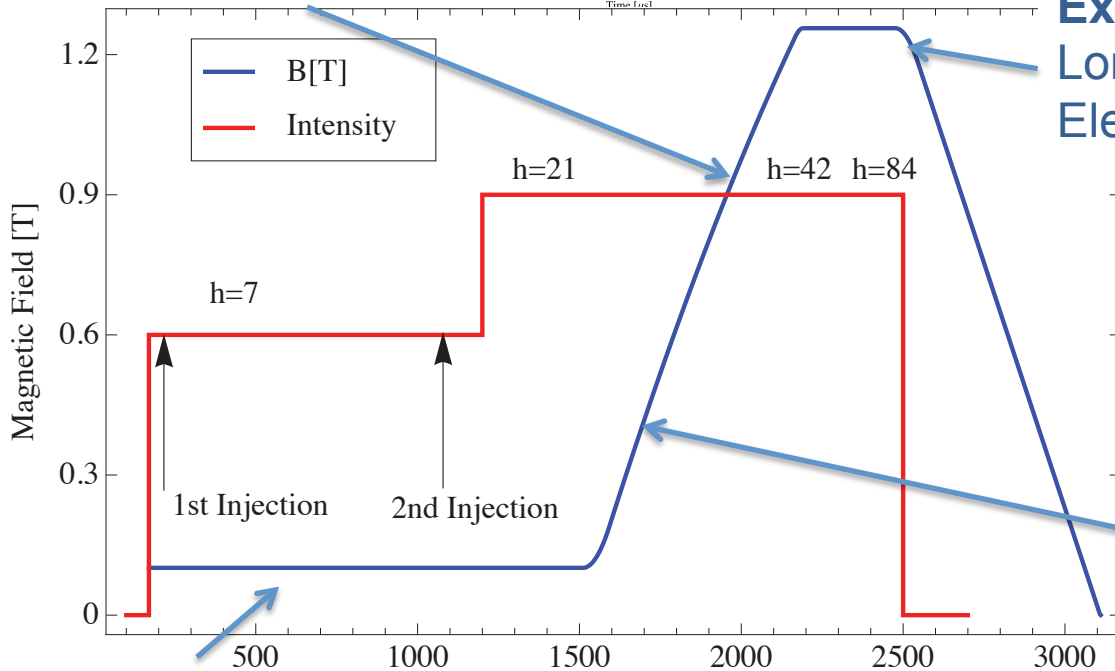
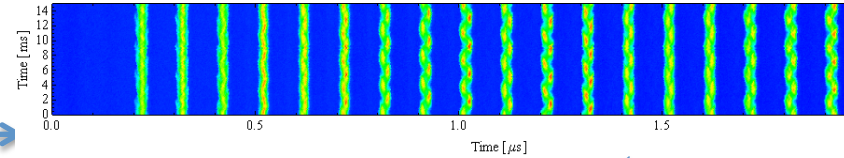
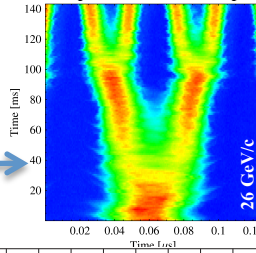

Extraction:
Longitudinal beam stability
Electron cloud

Transition crossing:
TMCI

Injection Transverse flat bottom: Time [ms]

Transverse emittance blow-up due to space charge if beam density too high

Headtail instability

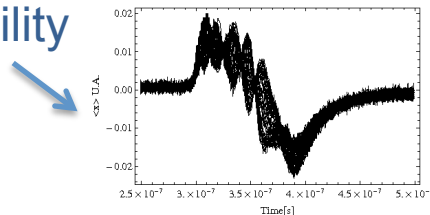

See G. Rumolo and S. Hancock presentations

2 GeV flat bottom

2 GeV injection needed to reduce space-charge-induced transverse emittance blow-up experienced by the first batch on the flat bottom
*(N.B.: fourth injection energy increase since PS construction
50 MeV - 800 MeV - 1 GeV – 1.4 GeV)*

2 GeV injection requires:

- New injection elements and power converters: septum, kicker, injection bumpers

Studies starting in 2012 for installation during LS2

See J. Borburgh's presentation

- New magnets and power converters for orbit correctors and lattice quadrupoles used at low energy

Studies started together with MDs to define the specifications

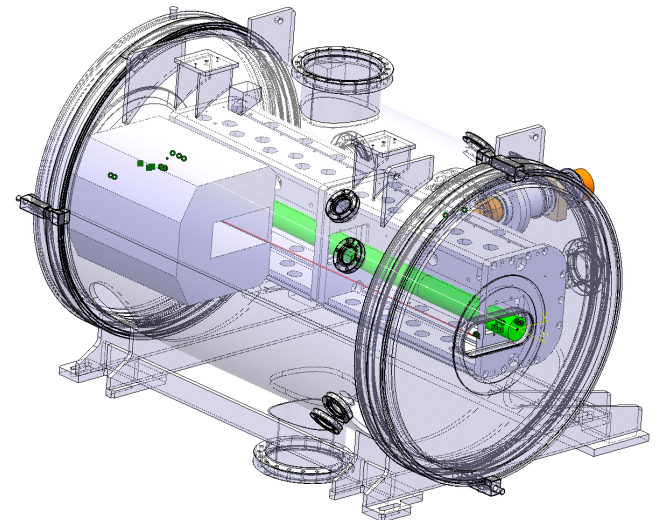

N.B.: *POPS operational, no new MPS required for upgrade.*

Low energy magnets/converters

Large number of power converters and magnets to be replaced to assure operation at 2 GeV but also *a safe +25 year long operation.*



N.B.: The PS “official” birthday was 24/11 of 52 years ago

Magnet	Horizontal correctors	Vertical correctors	Quadrupoles	Skew quadr. (I)	Skew quadr. (II)
Converter	50 linear	20 switching	40 linear	20 linear	20 switching
Built	1974	1999	1975	1969	1999
MTBF	9.8 y	5.6 y	16 y	33 y	

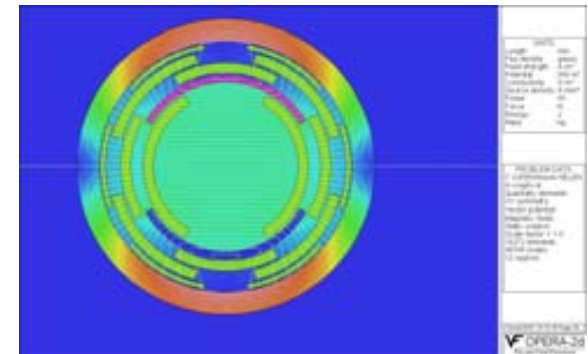
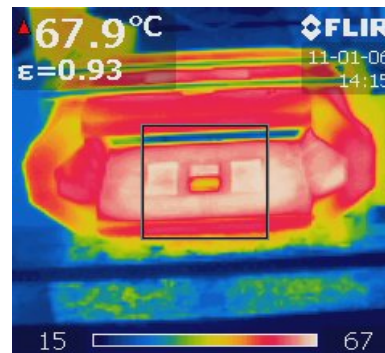
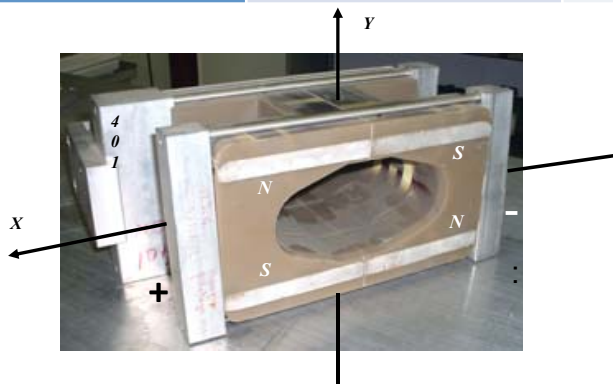

Multi pole magnet example from preliminary Elena studies

Brief excursus: PS main magnets

PS: a) first strong focusing machine ever built; b) combined function magnets
Working point control done with extra windings that generate up to b5

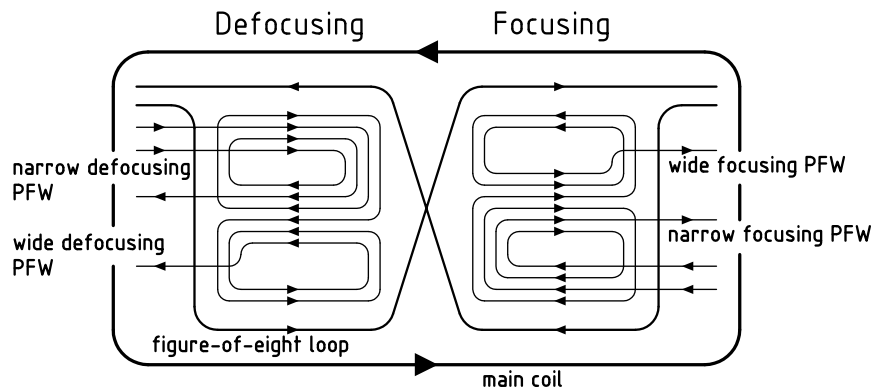
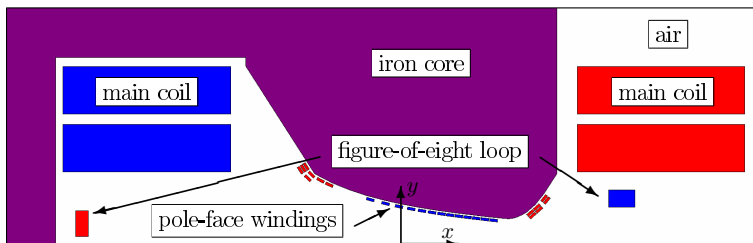
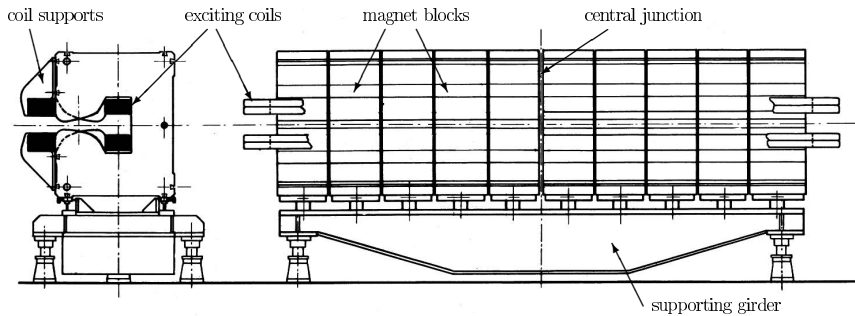

- In the 5-Current Mode WP control there are :
- 4 machine physical parameters to control
 - 5 free currents of the extra coils mounted on the poles of the main magnets (4 PFW + F8L)

- The 5th machine parameter could be:
- Non-linear chromaticity (MTE)
 - minimisation of the RMS F8L current

In normal operations, the working point is programmed by relative variations. Everything is programmed via matrices because the relationship between absolute value of the working point and currents in the extra coils is not known ...yet.

	ΔI_{FN}	ΔI_{FW}	ΔI_{DN}	ΔI_{DW}	ΔI_{8L}
ΔQ_h	$f_{\Delta Q_h}^{FN}(E)$	$f_{\Delta Q_h}^{FW}(E)$	$f_{\Delta Q_h}^{DN}(E)$	$f_{\Delta Q_h}^{DW}(E)$	$f_{\Delta Q_h}^{8L}(E)$
ΔQ_v	$f_{\Delta Q_v}^{FN}(E)$	$f_{\Delta Q_v}^{FW}(E)$	$f_{\Delta Q_v}^{DN}(E)$	$f_{\Delta Q_v}^{DW}(E)$	$f_{\Delta Q_v}^{8L}(E)$
ΔX_{ih}	$f_{\Delta X_{ih}}^{FN}(E)$	$f_{\Delta X_{ih}}^{FW}(E)$	$f_{\Delta X_{ih}}^{DN}(E)$	$f_{\Delta X_{ih}}^{DW}(E)$	$f_{\Delta X_{ih}}^{8L}(E)$
ΔX_{iv}	$f_{\Delta X_{iv}}^{FN}(E)$	$f_{\Delta X_{iv}}^{FW}(E)$	$f_{\Delta X_{iv}}^{DN}(E)$	$f_{\Delta X_{iv}}^{DW}(E)$	$f_{\Delta X_{iv}}^{8L}(E)$



Towards chromaticity control @ PS injection

For the second time in PS history (see late '90), study to correct injection chromaticities (linear) and study control of non-linear working point

- Use of the “nearly-newly available” Pole-Face-Windings
- Experimental studies of non-linearities at injection to optimise chromaticity control and dynamical aperture

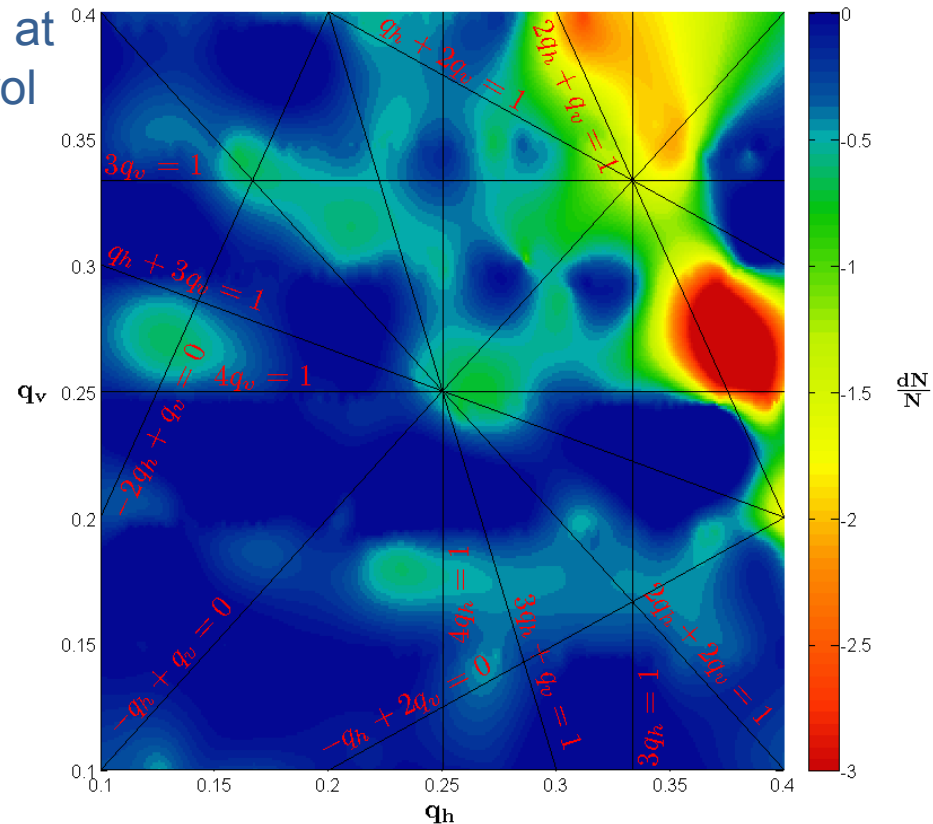
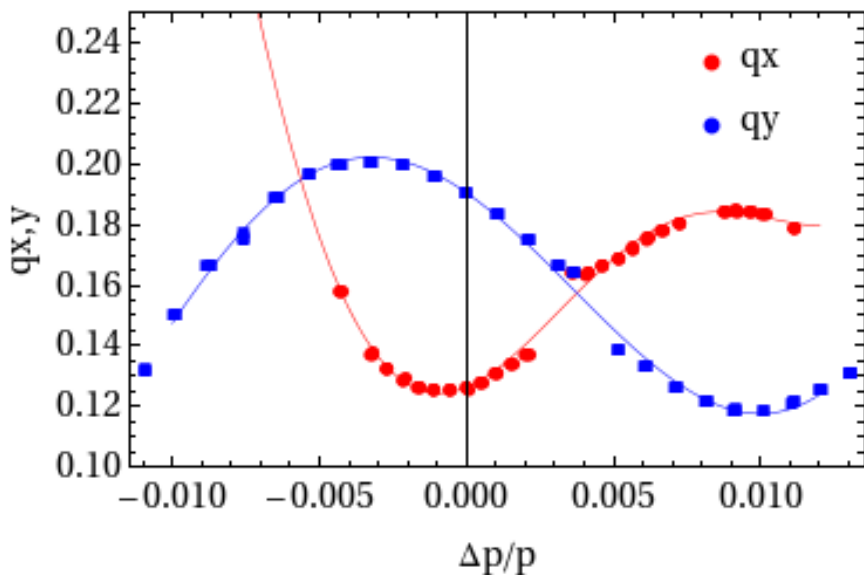



Space-charge studies

PS Upgrade
LIIU Project

- Study of space charge limits at injection combining experimental measurements and simulations to determine maximum Laslett acceptable
- Measurement of tune diagrams at 1.4 GeV and 2 GeV using tune scans (*first in the (long...) PS history*) also with the goal to optimization of working point

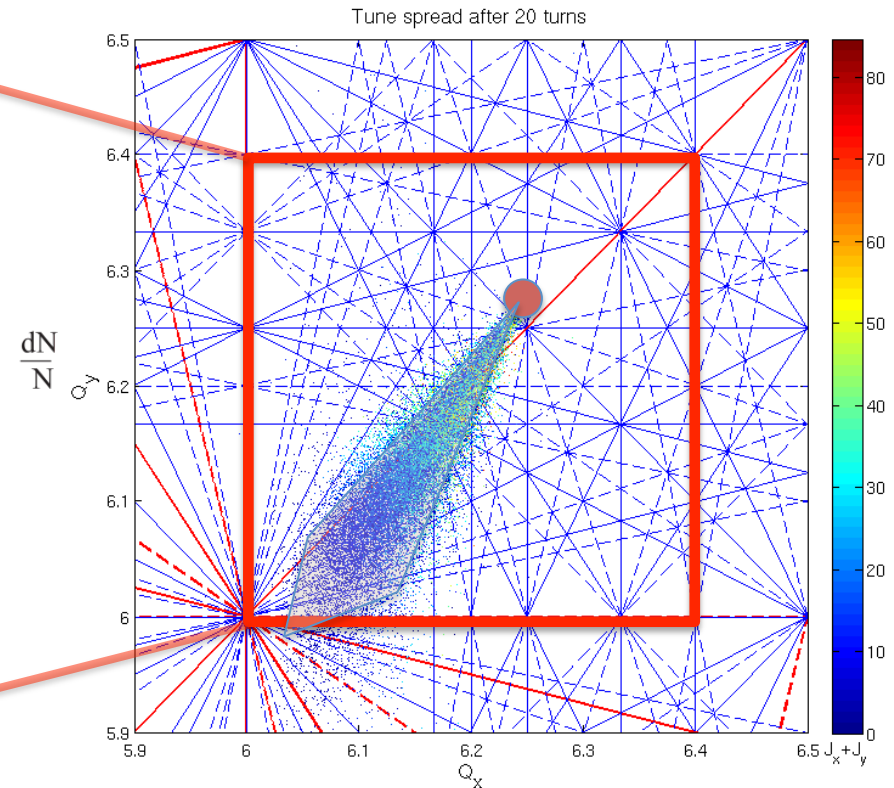
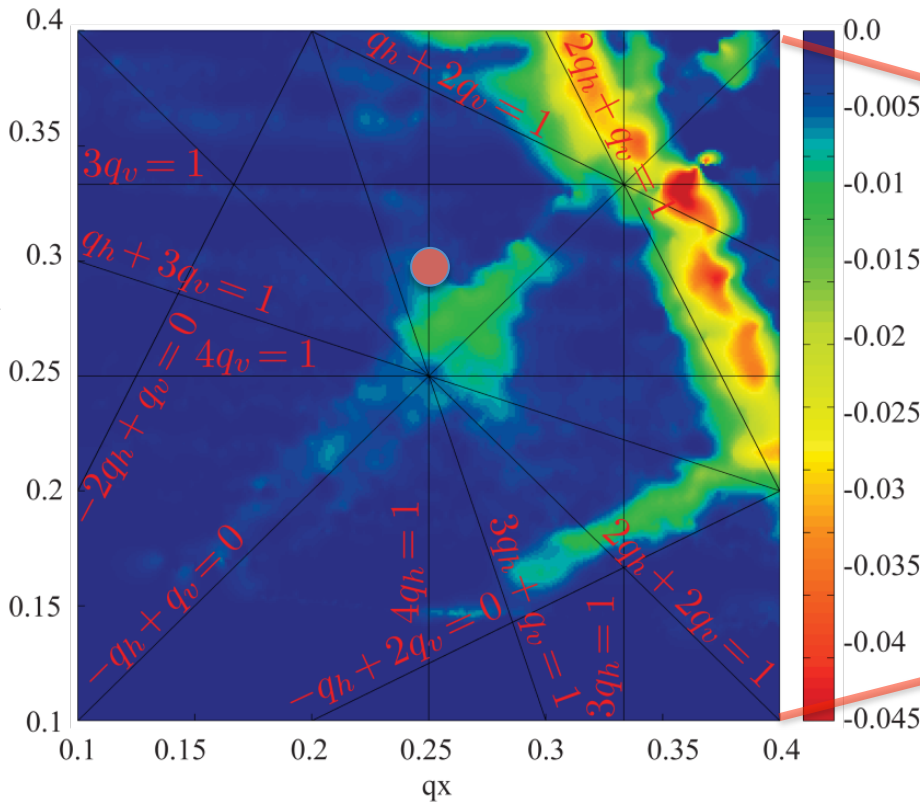

See G. Rumolo's presentation



Low level-RF related studies

PS Upgrade
LIIU Project

See S. Hancock's presentation

2011 studies concentrated on:

- **Maximize beam performances for LHC operation**
- Triple splitting and new RF manipulations tested at 2 GeV
- First attempts to define current limitation and how to combat them via dedicated feedbacks to assure high beam quality:
 - **Transient beam loading causes relative intensity errors of up to 20% ($\pm 10\%$) per splitting**
 - Pattern well understood from RF manipulations.
 - *Distributed problem since all the RF systems are used for splittings*
 - Bunch length and longitudinal emittance also affected with consequences for SPS.
 - **Coupled bunch instability observed during acceleration and at flat top, longitudinal emittance blow-up (MDs in 2011)**

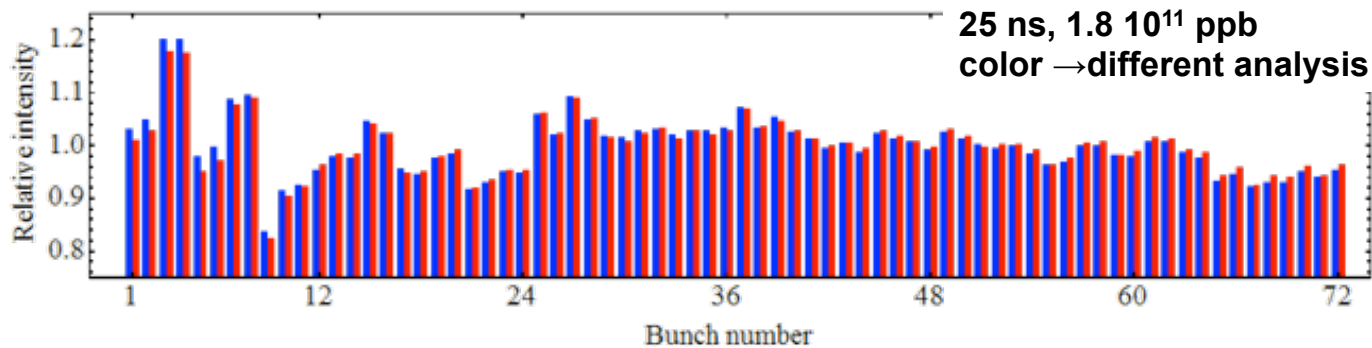



RF systems

PS Upgrade
LIU Project

Five different RF systems all involved in the LHC-beam long. gymnastics

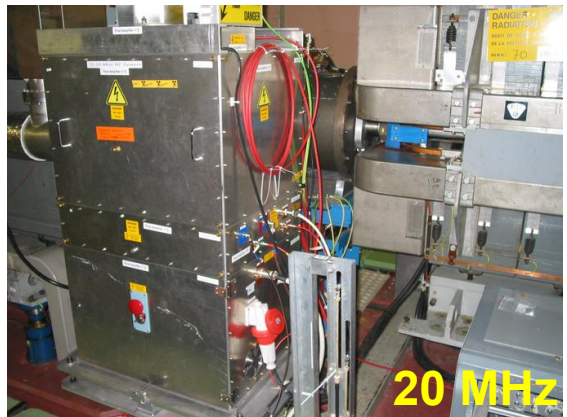
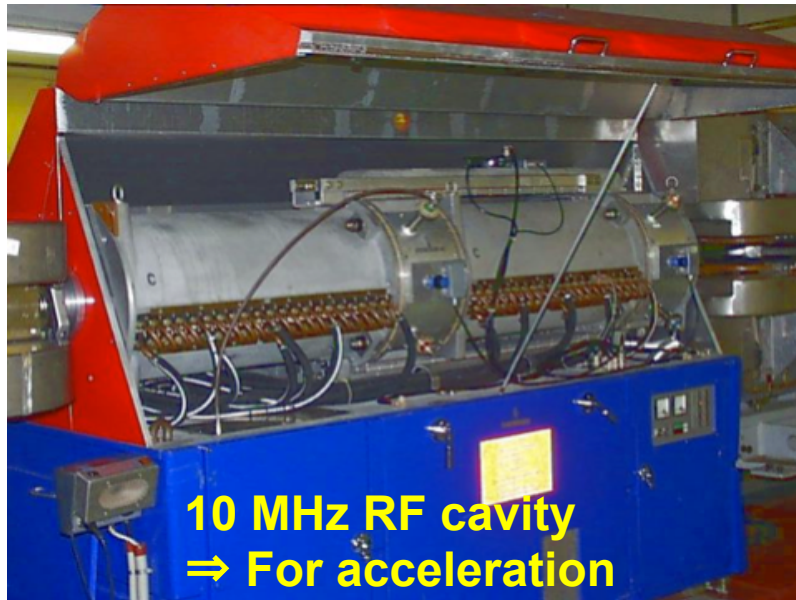

See C. Rossi's presentation



Electron cloud in the PS

PS Upgrade
LIU Project

Electron cloud was observed but not clear yet if any deleterious effect on the beam. Might become more critical with higher brilliance.

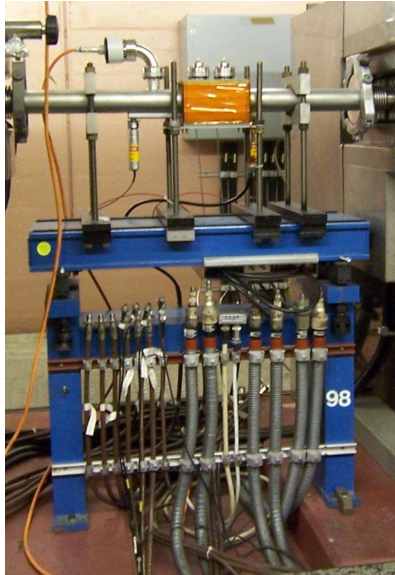

(F. Caspers, T. Kroyer, E. Manner)

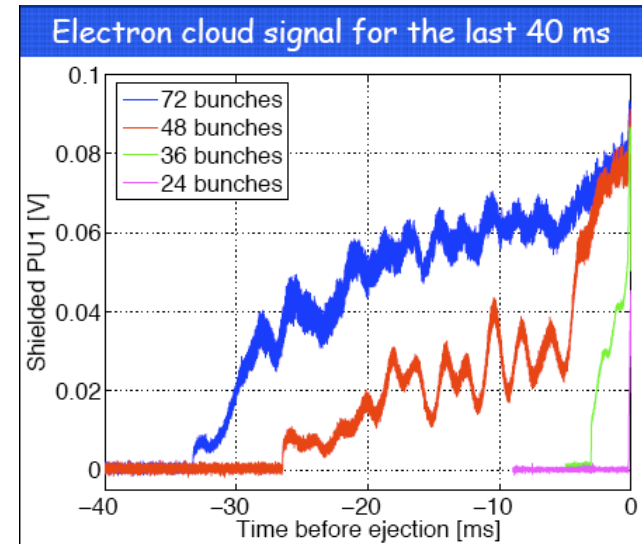
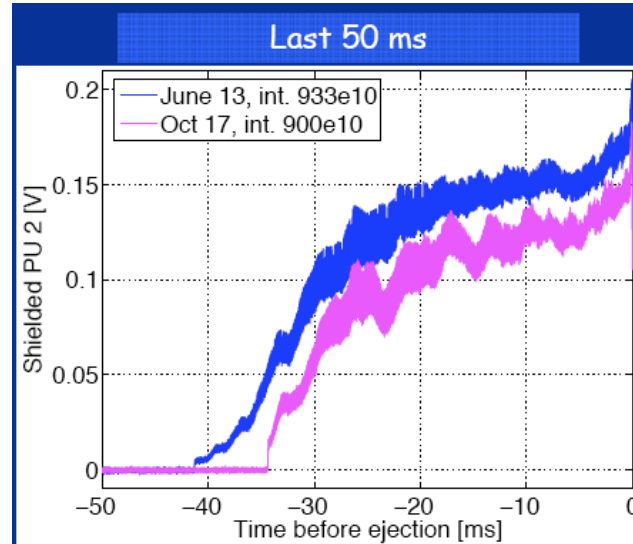

*New studies in 2011 since direct impact on time available for last RF manipulation
Transverse instabilities at flat top observed in 2001, 2004 and again 2006.*

Probably related to ecloud: why mainly horizontal and why not cured by chromaticity?

If solution like coating needed → MU removal → staging the intervention or LS2



Beam instrumentation

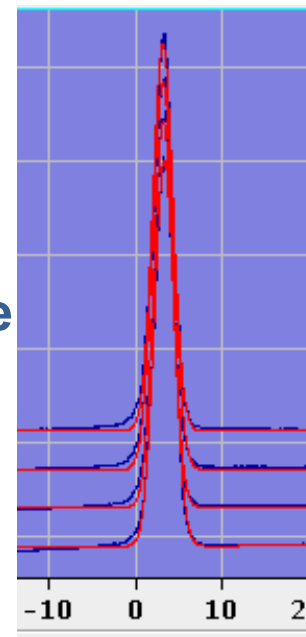

mm

The upgrade aims to smaller emittance to get larger brilliance

- the injectors should be able to precisely measure them
- **only 5% emittance blow up as permitted budget**
- absolute and relative precision will be fundamental

Ongoing revision of emittance measurement devices:

- BWS: precision for small emittance beams much improved this year
- BWS: cannot measure emittance bunch-by-bunch (1 LHC batch is 72 bunches with 25 ns) and *not in a continuous way along the magnetic cycle*

Improve intensity measurement to better evaluate losses

- **only 5% losses as permitted budget**

Need instrumentation to observe ghost bunches (< 1% of nominal int.)

- ghosts can be produced on purpose or not (*S. Hancock's presentation*)

See R. Jones's presentation



Improvement of PS tunnel shielding for LS1

PS Upgrade
LIU Project

- **On Road Goward:** project prepared as recommended by the PS Radiation WG, presented and approved by the IEFC.
- **Above Septum 16:** start of Civil Engineering study.

Top of PS extraction region (16)

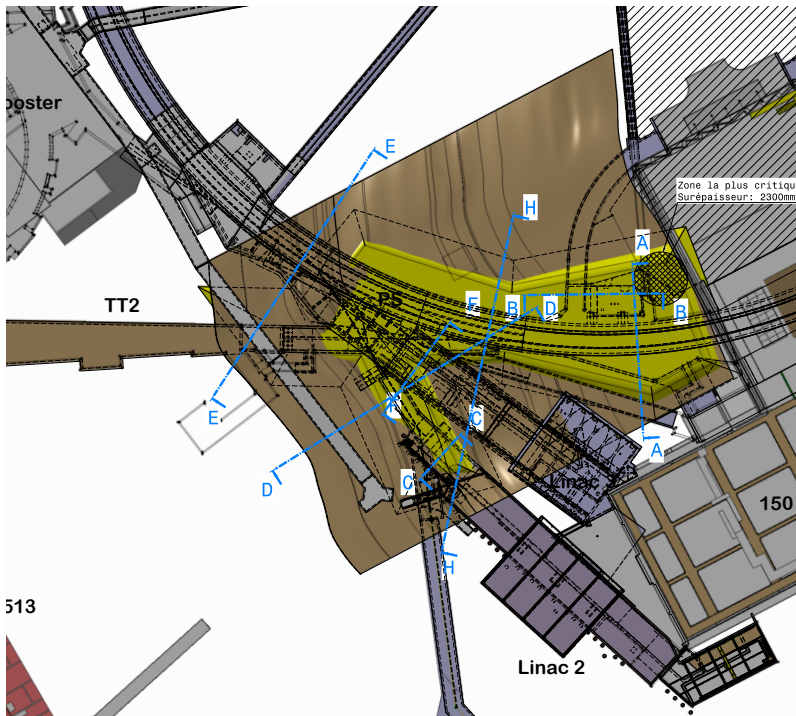

Road Goward

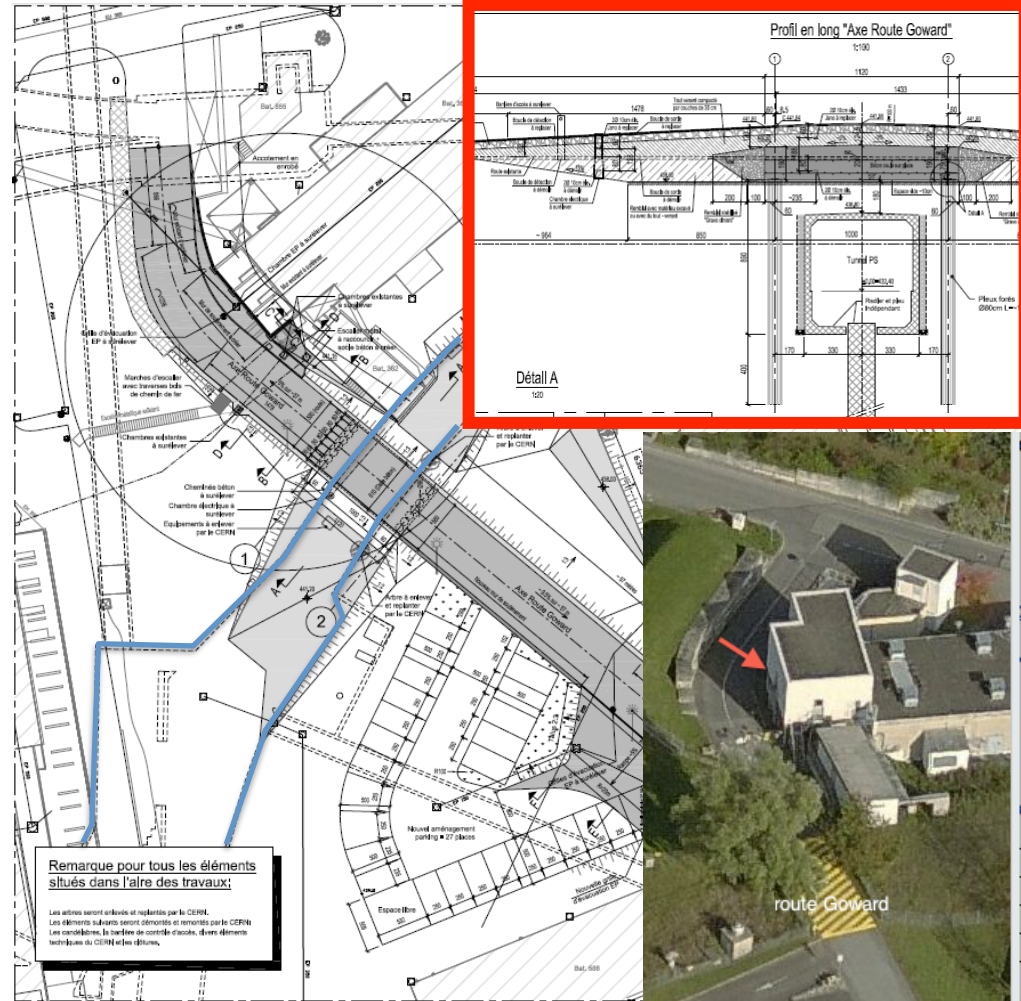



Must not be forgotten...

PS Upgrade
LIU Project

Vacuum System: if electron cloud would become an issue, than we risk to need important intervention as in the SPS. Many intervention during LS2 for installation of new elements.

Controls: PS is profiting of recent renovation of the control system (INCA for example) but new elements will be installed and new systems will be implements (RF digital beam control for example).

Electrical Systems: PS will profit of the consolidation of the electrical network.

Cooling and Ventilation: renovation of various systems, like the ventilation stations, will be fundamental to assure a safe and reliable operation.

Transport: a large number of elements will be installed/removed in a very short amount of time, in particular during LS2.

Survey: realignment of the machine and TL will be done during next shutdowns, starting from LS1. Important to preserve beam quality and minimize losses

Commissioning and Operation: collaboration during the MDs and final commission are two key points of the upgrade.

Alternative schemes

Study of alternative scheme for LHC beam production (not merely trying to upgrade the existing one), one example is Batch Compression in the PS to increase brightness after acceleration to a suitable energy, but other were/will be analyzed (triple batch inj., small emittance-half intensity, etc...)

Batch compression:

Abandon factor 7 in PS harmonics to

- (i) use all four PSB rings (with single batch transfer) and
- (ii) use batch compression to increase brightness

Fill as much as possible of the PS circumference at injection

Batch compression after first acceleration to an appropriate energy to avoid space-charge

Reduced number of bunches per PS cycle

→ Higher intensity per bunch and, thus, brightness

Difficult operation due to many RF harmonics changes

See S. Hancock's presentation

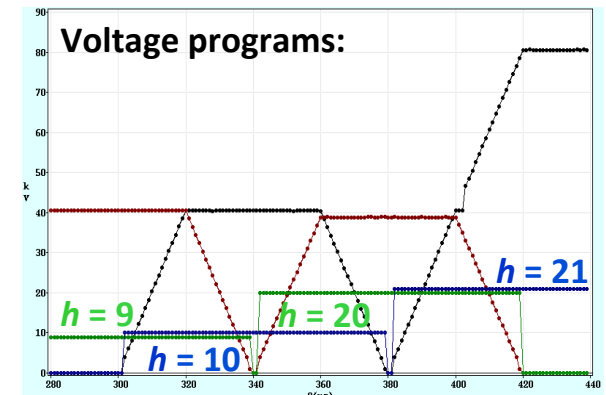

Pure $h = 21$

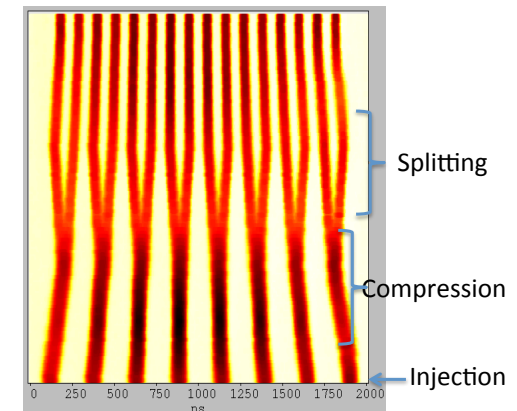

Pure $h = 9$



Future

PS Upgrade
LIU Project

- Continue with Machine and Theoretical studies to improve our understanding of the performances limits
- Design/built new elements, knowing that even if almost all the installation will happen during LS2, this must start basically now
- Stage whenever possible the interventions according to available resources and priorities (LS1 work will be mainly civil engineering)
- Collaborate with the consolidation program to renovate at maximum the first proton synchrotron ever built to remain the beating hear of the CERN injectors ...

N.B. : PS upgrade studies started only about 1 year ago. Thanks to everyone for the impressive amount of work/studies in such a short time.

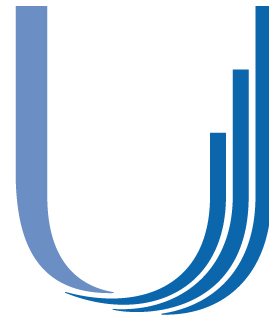

LHC Injectors Upgrade

THANK YOU FOR YOUR ATTENTION!



LHC beams: injector performances

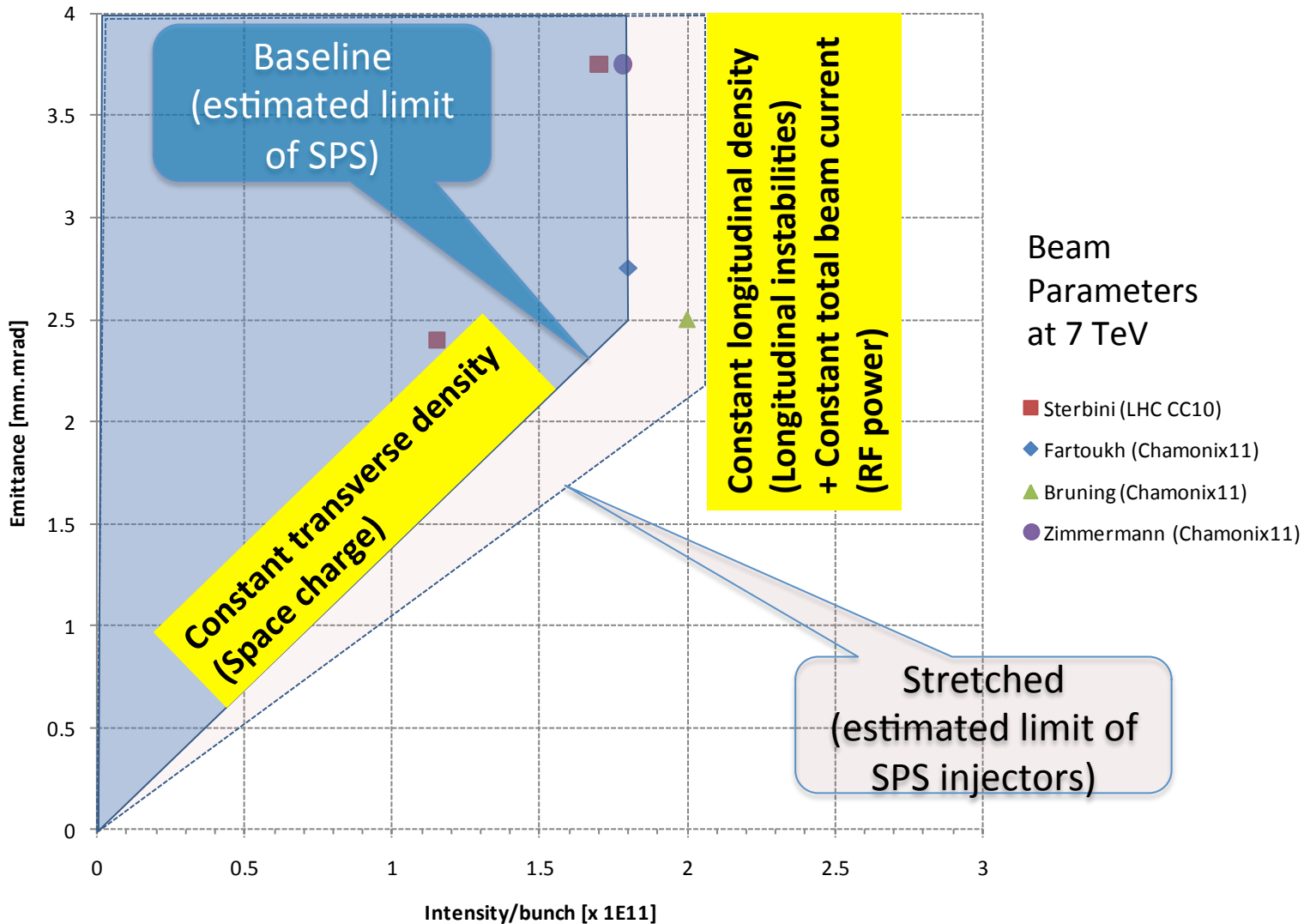

The LHC50 (ns) DB cycle in the PS

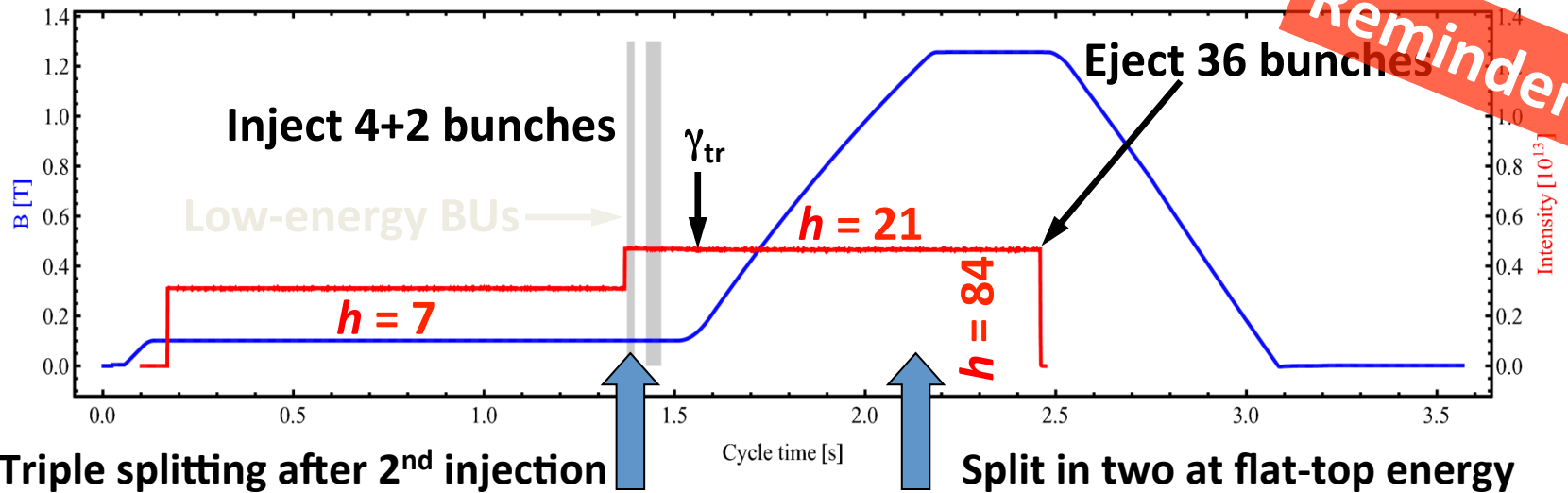

Triple splitting after 2nd injection

Cycle time [s]

Split in two at flat-top energy

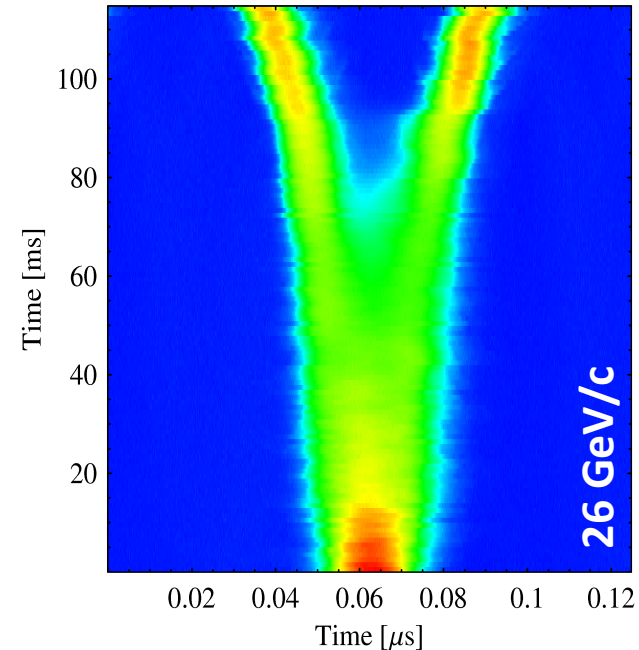
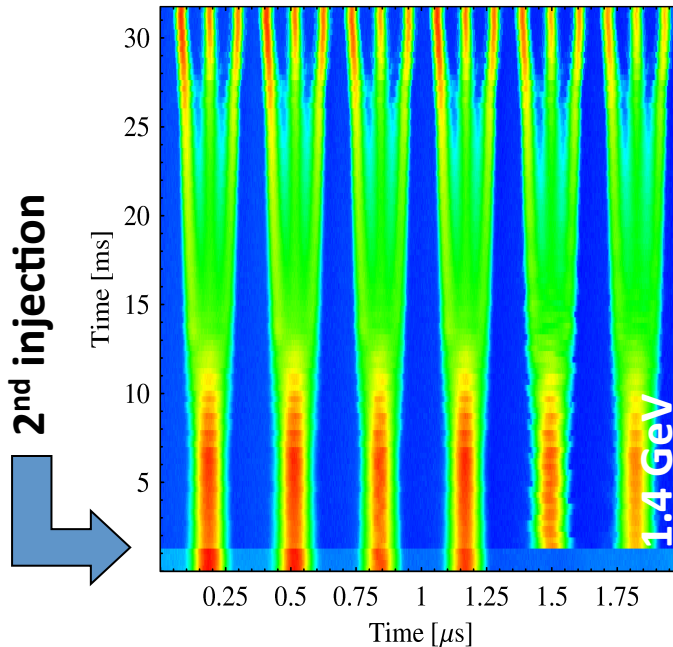

→ Each bunch from the Booster divided by 6 → $6 \times 3 \times 2 = 36$

Beam quality (assuming perfect SPS)

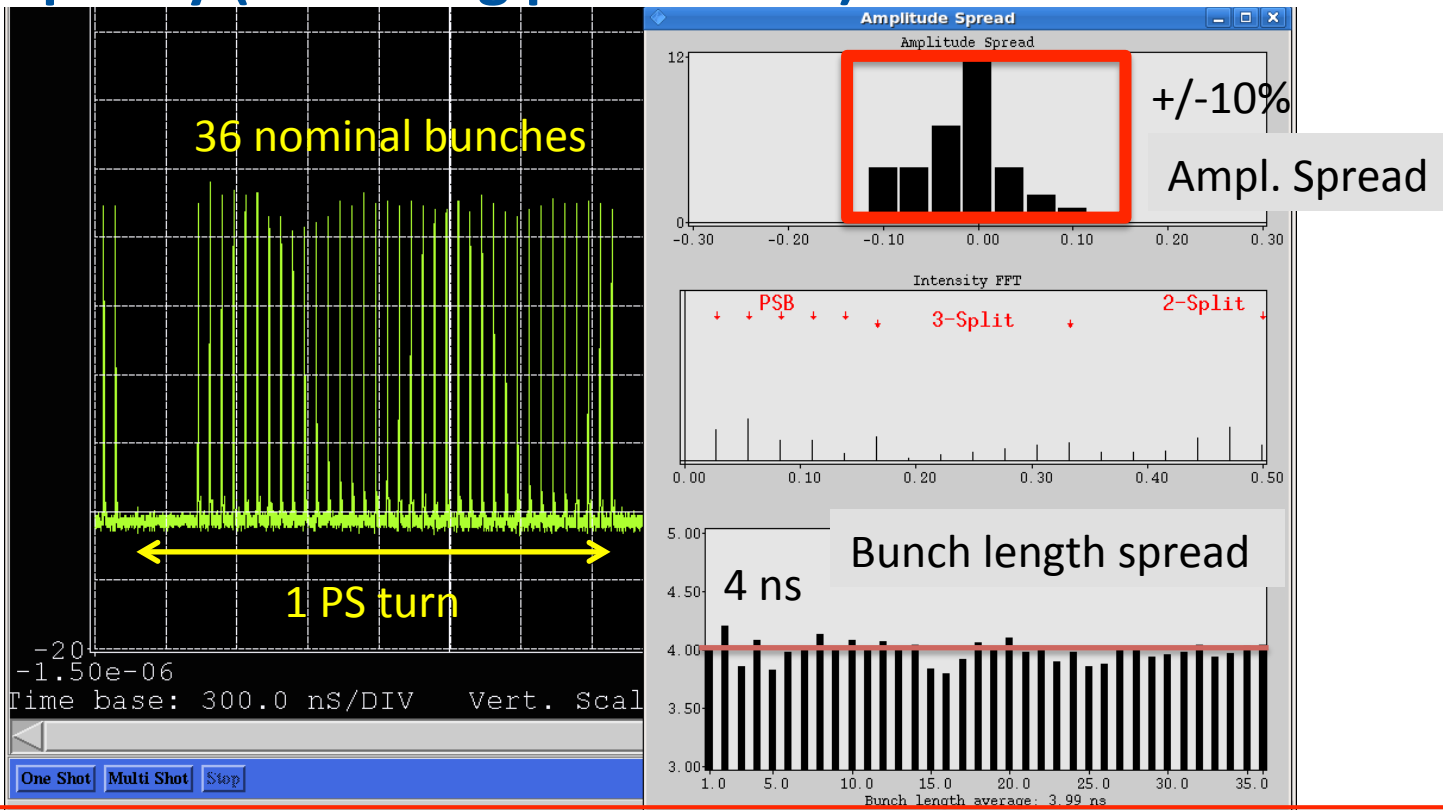

**Nominal conditions
@ PS extraction:**

- ➔ +/- 10% intensity spread along the batch
- ➔ average bunch length about 4 ns within 0.35 eVs, 1.3E11 ppb within 3 μrad (1 σ norm)
- ➔ first bunch always different as first third of batch since affected by transient beam loading
- ➔ satellite bunches ~1% (cannot measure less in the PS), observed to be less than 1% in LHC

Sources of spread

Due to slow drift or wrong adjustment (solvable)

Relative phase settings between RF harmonics

Badly adjusted beam transfer PS-SPS

Big intensity differences of PSB rings or number of rings

Due to beam intensity (difficult to avoid)

Shot-to-shot variations in PSB, also ring-to-ring

Transient beam loading → rel. RF phase diff. along batch

Coupled-bunch instabilities



MU consolidation status I/II

PS Upgrade
LIU Project

- **Preventive maintenance and monitoring of Main Magnets:**
 - **Anticipate degradation of the magnets in order to repair / replace the failed components and avoid down time**
- Yearly monitoring activities:
 - HV tests on the Main Coils, the PFWs, The F8Ws;
 - Audio – visual patrol
 - Inspection of the loose laminations
 - Measurement of the crimping resistance in the old PFWs
 - Internal resistance of the F8W.
- **Everything OK → No MU renovation foreseen**
- **The Pole Face Windings**
 - Procurement of 30 sets of spare PFW launched in 2010 for long term operation of the PS
- **Diagnostic campaign for detection of the weak PFW will be performed during the next shut down.**

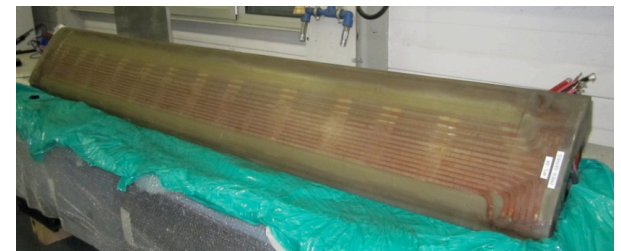
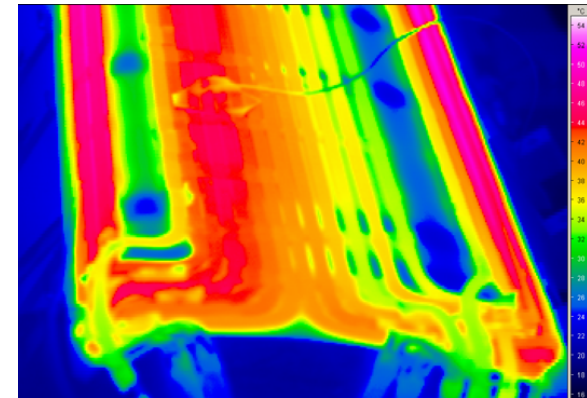



MU consolidation status I/II

PS Upgrade
LIU Project

Actual Status of the Main Bus Bars:

- The design of new PS bus Bars started in 2010 is driven by studies and extensive testing (more than 55 samples)
- Use of cylindrical aluminium conductor with pre-impregnated resin rich tape with Mica flakes as an dielectric insulation not sensitive to the ionizing radiations.
- Manufacturing of eight spare Bus bar set (one of each type) to cover the full machine.

Diagnostic of the accelerator Bus Bar will be started next shut down in order to evaluate their status and to decide if all the Bus Bars must be replaced.

