

QPS upgrade and machine protection during LS1

R. Denz, TE-MPE-EP

Chamonix 2012

Acknowledgements: K. Dahlerup-Petersen, A. Siemko, J. Steckert

- ➔ Major upgrades can only be smoothly implemented during long shutdowns
 - Re-furbished / upgraded systems should be able to run without major overhaul at least for 3 to 4 years
- ➔ No principal change of the protection functionality required for the LHC after LS1
 - Some protection settings to be adapted to higher energy
- ➔ Several requests for enhanced supervision & diagnostic capabilities by equipment owners, experts and users
 - Requested for LHC operation as for hardware commissioning
 - Maintainability of the protection systems to be improved
 - Enhanced remote control options, less accesses, more automatic analysis and maintenance tools, configuration databases



- ➔ Relocation of QPS equipment (see Anne-Laure's presentation)
 - Concerns the inner triplet protection systems installed in UJ14, UJ16 and UJ56
- ➔ Preparation of infrastructure for the deployment of NanoFip based DAQ systems (fieldbus couplers)
 - Reconfiguration of QPS fieldbus networks
 - Number of segments to be doubled

- ➔ Deployment of radiation tolerant hardware (starts already in 2012)
 - Basically required for quench detection systems installed in RR13,17, 53, 57, 73, 77 (re-location not possible during LS1)
 - In addition some potentially vulnerable systems (e.g. splice protection systems) installed in exposed areas of the LHC tunnel should be upgraded

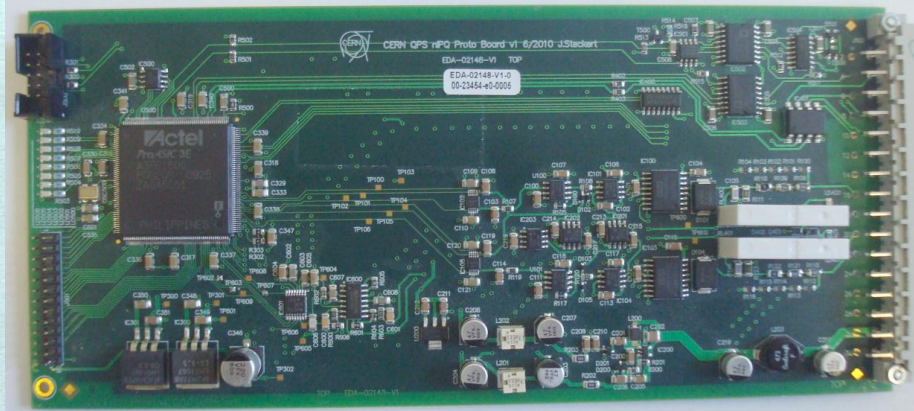

- ➔ Dedicated bus-bar splice supervision allowing permanent monitoring equivalent to the systems in use for the LHC main circuits
 - Baseline is a non-interlocking system (splices are already now very well protected by the global protection system due to the fast discharge time of these circuits)
- ➔ Installation of 102 new protection crates replacing the existing systems used for the protection of the insertion region magnets and inner triplets
 - Quench detection and DAQ systems can be partially re-used
 - Capabilities of the DAQ systems will be enhanced including the means for advanced quench heater diagnostics (see next slides)
- ➔ Instrumentation cables and the proximity equipment installed close to the DFB needs as well to be modified (re-cabling required)
 - Reduced risk of false triggers caused by electrical perturbations especially for magnets Q9 and Q10

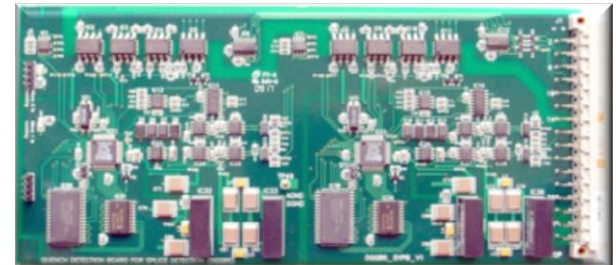

- ➔ The upgrade is driven by the intention to reduce the risk of damage to the quench heater circuits
 - The present system monitoring only the discharge voltage is not sensitive enough to detect all fault states of the quench heater circuits especially failures of the heater strips.
 - All of the few quench heater faults observed so far during LHC operation could be mitigated by disabling the respective heater circuit and switching to a low field heater.
 - There is however a risk of a quench heater fault requiring at least an exchange of the magnet (short to coil, compromised electrical integrity of the magnet)

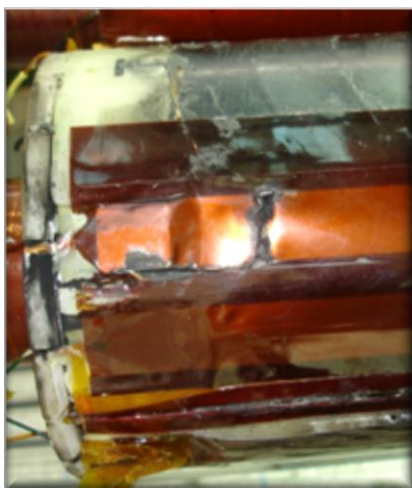

G. D'Angelo

- In order to minimize the risk the test discharge voltage has been reduced to ~10% of nominal (particular test mode)
- For the LHC after LS1 this risk will slightly increase basically due to the magnet training campaign (see Arjan's talk tomorrow)
- The enhanced quench heater supervision is supposed to reveal precursor states of a potential failure

➔ R&D campaign in 2011 evaluating potential extensions of the DAQ systems

- Simultaneous measurement of the discharge voltage and current (using special current transformers) and higher sampling rates than used in the present system (200 Hz → 10 (20) kHz)
- High precision ($\Delta R \approx 100 \mu\Omega$) measurement of the resistance of the quench heater strip
 - Precision automatic measurement system integrated into protection crate
 - This instrument will remain disabled and disconnected from the heater circuits while magnets are powered

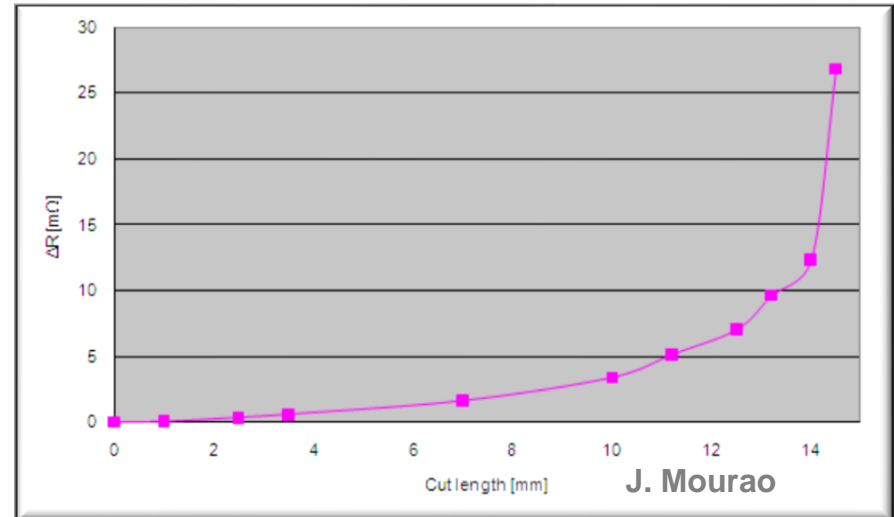
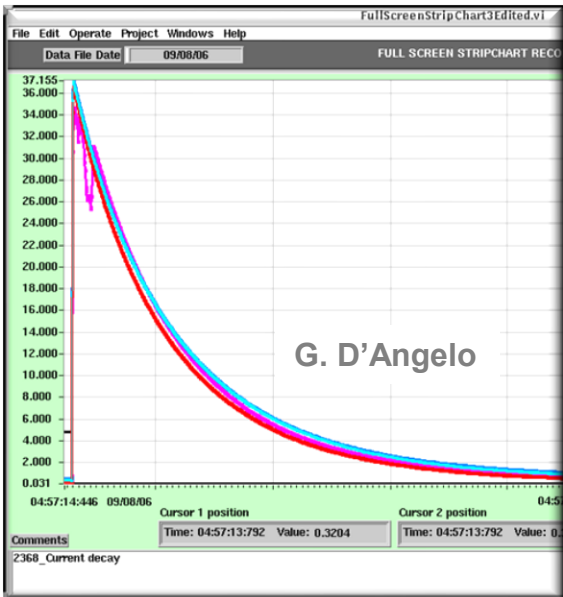

- ➔ Both methods will deliver significantly more information about the state of a quench heater strip but will require a substantial upgrade of the currently installed protection systems
- ➔ The present protection crates cannot be extended to house additional measurement systems
 - The existing quench detection electronics, DAQ systems can be re-used
- ➔ Unless there are strong concerns by the magnet owners/specialists this upgrade will be applied for the LHC main dipoles first
- ➔ In addition the new crates should be adapted to the redundant UPS powering scheme implemented in 2009

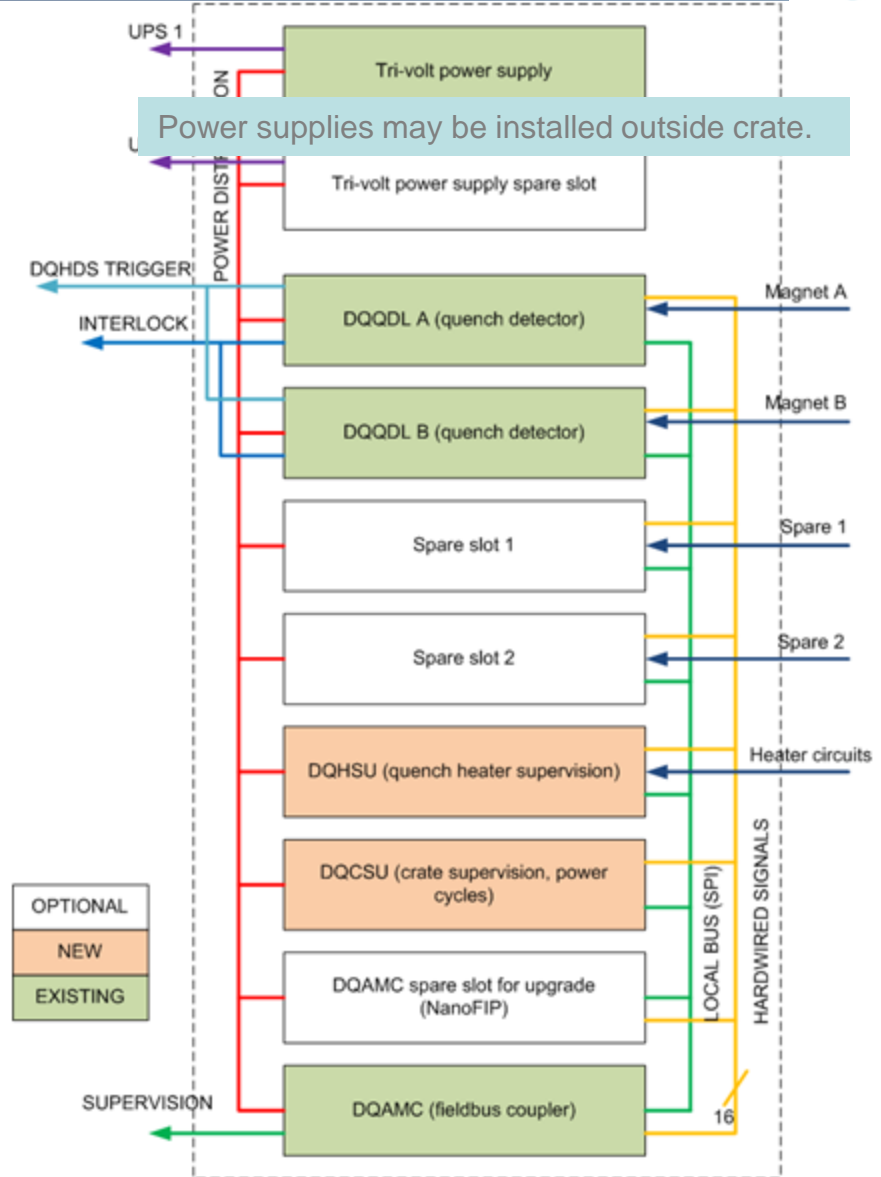

- ➔ The earth voltage feelers will monitor the electrical insulation strength of the LHC main circuits especially during fast discharges
- ➔ The system will as well measure the electrical insulation strength between adjacent bus-bars
- ➔ As all data will be stored in the LHC logging database also the evolution in time can be studied. In case of an eventual earth fault the system will allow to identify the location of the fault position on the half-cell level.
- ➔ This will significantly reduce the occupation time in the LHC tunnel of the teams in charge of the precise localisation and repair.
- ➔ Per sector a maximum of 54 devices for the main dipole circuit and 55 for each of the main quad circuits can be installed (1308 units in total).
- ➔ The installation and commissioning will be staged starting in 2012 with one sector and being completed during LS1.

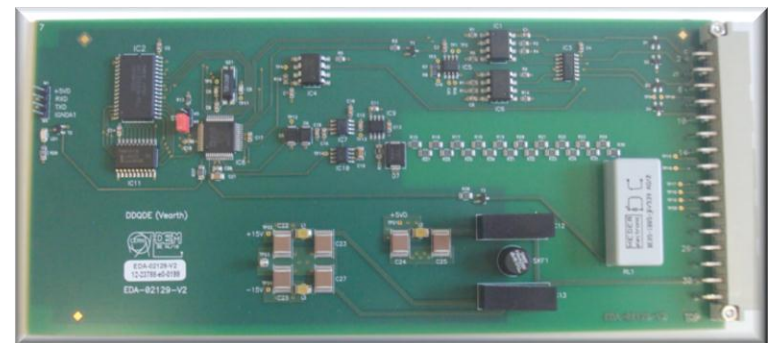

- ➔ Full visibility of redundant circuit boards including post mortem buffers
 - Requires “only” a modification of the QPS firmware
 - Resulting in an increased data flow to the logging database (about a factor 3); PM data volume doubled
- ➔ Update of signal databases and adaption of QPS supervision for all newly installed items
- ➔ Revision of the protection of the undulators in order to allow more transparent operation
 - Automatic enabling of inductive compensation should allow higher ramp rates and operation without re-calibration in between technical stops
- ➔ Quench loop controller upgrade
 - Upgrade of QPS internal interlock loops for LHC main circuits
 - Redundancy of loop current sources
 - Enhanced diagnostics especially with respect to false triggers including the interface to the powering interlock controller

- ➔ Remote power cycle options for those protection systems which are equipped with quench heaters
 - R&D started as not trivial from the equipment safety point of view
 - Risk of unprotected magnet due to accidental activation must be excluded
 - Restriction of the remote power cycle option to the DAQ systems only could be a safe alternative
 - Remote power cycle options are a prerequisite for the implementation of firmware download capabilities

- ➔ Remote control of device parameters
 - Implemented on all new systems (possible extension for some existing units)
 - QPS configuration database to be commissioned as well during LS1
 - Firmware download via the QPS supervision under investigation



- ➔ Arc chamber installation for RQD/RQF extraction switches to be completed in order to increase the maximum operational voltage of these circuits
 - Will allow to keep the discharge time constant of the RQD/RQF circuits short ($t < 20$ s)
 - At the same time the installation of the snubber capacitor banks in the RQF/RQD Circuits (16 installations) will be executed

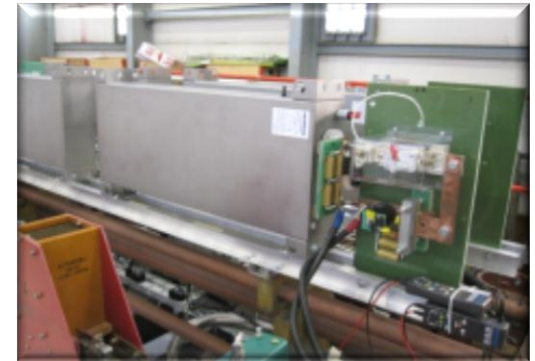

- ➔ 600 A energy extraction systems:
 - Implementation of a general upgrade campaign, including an improved fixation of the holding coils and supervision of the internal current distribution
 - Upgrade of all 48 extraction resistors for accepting double energy deposit



LHC CIRCUIT SUPERVISION v5.0

System Status: 11:20:41 AM 2/2/2012

11:20:40 AM 2/2/2012 2 3 4

BAD	BAD	BAD	BAD	BAD	BAD	BAD	BAD	BAD
BAD	BAD	BAD	BAD	BAD	BAD	BAD	BAD	BAD

Remaining time: _____

Device: _____ Select

Actions Logbook

- The work performed during LS1 by will require a full re-commissioning of all protection systems prior to the powering tests
 - Complete electrical quality assurance for all superconducting circuits
 - Test of all QPS instrumentation cables
 - Quench heater circuit qualification prior to implementation of enhanced supervision
- ☐ Complete individual system tests: interlock tests, quench heater discharge tests etc., verification of data transmission
- The re-commissioning will profit from the experience gained so far but will remain challenging (as usual)
- Additional tests will be required during the powering tests in order to qualify some newly installed items
 - Upgrades of the energy extraction systems, earth voltage feelers

Foreseen upgrades during LS1	Quantity
Protection crates	1334 (main dipole & insertion region magnet protection)
Rack powering and interface module	1232
Detection boards (new)	1300 including replacement of obsolete systems (partly starting in 2012)
DAQ / measurement boards (new)	1334 / 2668 depending on final design and scope
Firmware upgrades	2300 systems (DAQ systems)