

CLIC DDS Baseline and Future Status

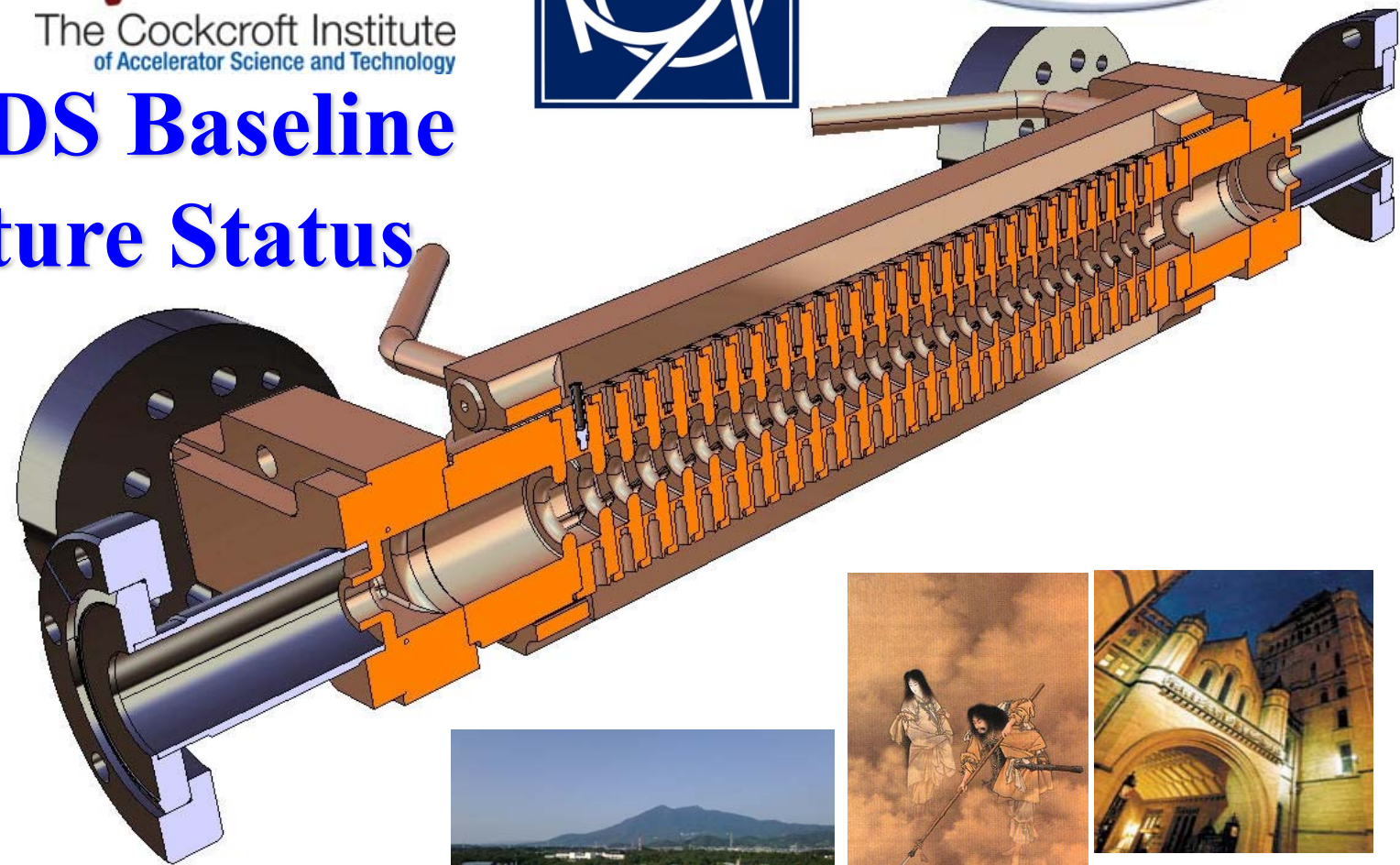

Roger M. Jones
 Cockcroft Institute and
 The University of Manchester

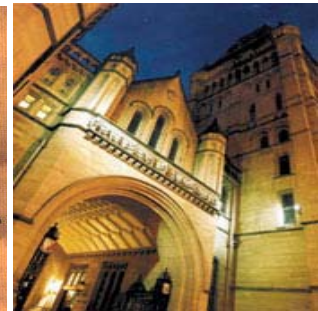

Wake Function Suppression & HG Research for CLIC -Staff

- Roger M. Jones (Univ. of Manchester faculty)
- Alessandro D'Elia (Dec 2008, Univ. of Manchester PDRA based at CERN)
- Vasim Khan (PhD student, Sept 2007)
- Nick Shipman (PhD student Sept 2010, largely focused on breakdown studies)
- Part of EuCARD (European Coordination for Accelerator Research and Development) FP7 NCLinac Task 9.2



V. Khan, CI/Univ. of Manchester Ph.D. student
Grad. April 2011, now CERN Fellow



A. D'Elia, CI/Univ. of Manchester PDRA based at CERN (former CERN Fellow).

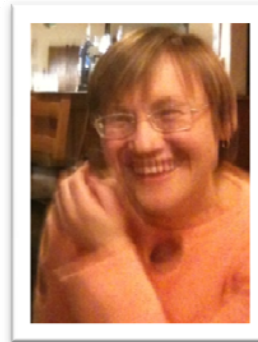

I. Nesmiyan, CI/Univ. of Manchester PDRA.



N. Shipman, CERN/CI/Univ. of Manchester Ph.D. student



L. Carver, Sept 2011 CI/Univ. of Manchester Ph.D. student

- Major Collaborators: W. Wuensch, A. Grudiev, I. Syrachev, R. Zennaro, G. Riddone (CERN)

Overview

Entails:

1. Suppressing long range transverse wakefield
2. Ensuring the e.m. surface fields (corresponding to accel. mode) are minimised

Challenging!!

Three Main Parts:

1. *Review of salient features of manifold damped and detuned linacs.*
2. *Initial designs (three of them). CLIC_DDS_C.*
3. *Further surface field optimisations CLIC_DDS_E(R).*
4. *Finalisation of current design. Based on moderate damping on strong detuning. Single-structure based on the eight-fold interleaved for HP testing CLIC_DDS_A*
5. **Concluding remarks and future plans.**

Introduction –Present CLIC baseline vs. alternate DDS design

- The present CLIC structure relies on linear tapering of cell parameters and heavy damping with a Q of ~ 10 .
- Wake function suppression entails heavy damping through waveguides and dielectric damping materials in relatively close proximity to accelerating cells.
- Choke mode suppression provides an alternative, but may negatively impact R_{sh} and can have a significant impact on breakdown
- **A viable alternative is presented by our CLIC_DDS design - parallels the DDS developed for the GLC/NLC, and entails:**
 - 1. Detuning the dipole bands by forcing the cell parameters to have a precise spread in the frequencies –presently Gaussian K_{dn}/df - and interleaving the frequencies of adjacent structures.**

2. Moderate damping $Q \sim 500-1000$

Features of CLIC DDS Linac

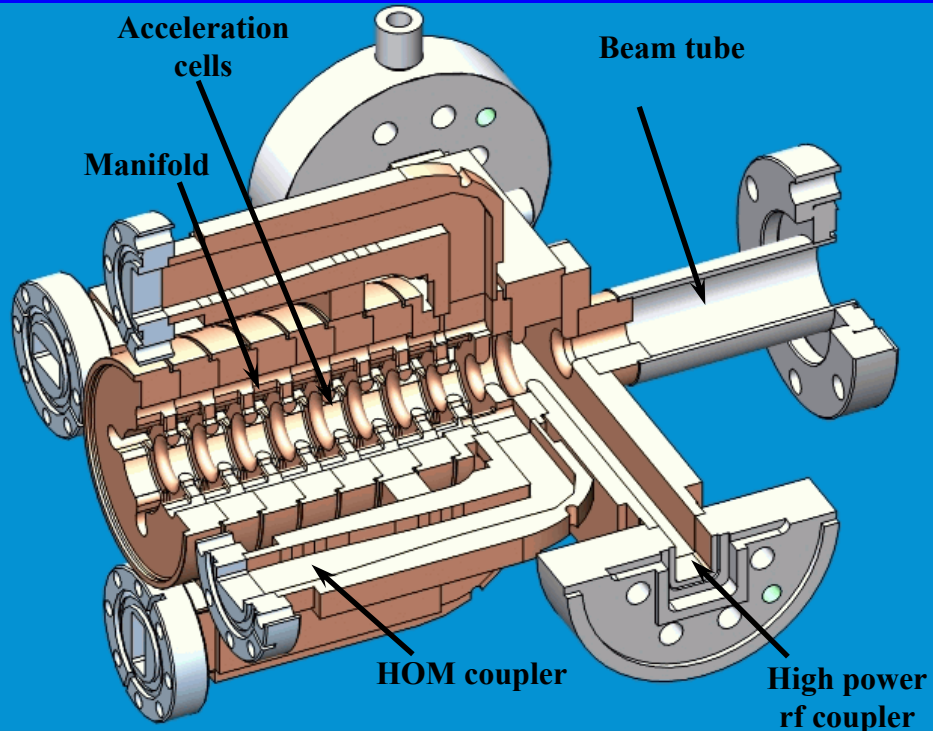

- NLC/G(J)LC SLAC/KEK RDDS structure (left) illustrates the essential features of the conceptual design
- Each of the cells is tapered –iris reduces (with an erf-like distribution –although not unique)
- HOM manifold running alongside main structure removes dipole radiation and damps at remote location (4 in total)
- Each of the HOM manifolds can be instrumented to allow:
 - 1) Beam Position Monitoring
 - 2) Cell alignments to be inferred

- CMM (Coordinate Measurement Machine) data compared to ASSET power minimisation data remapped to frequency
- Dots indicate power minimisation

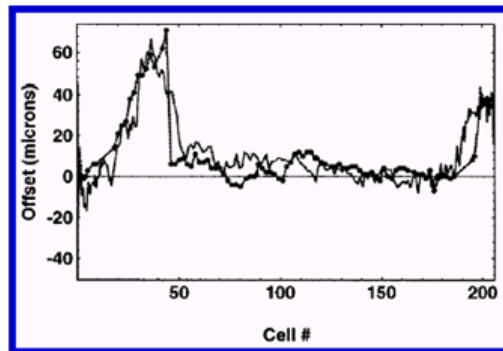

Remote Cell Alignment Diagnostic

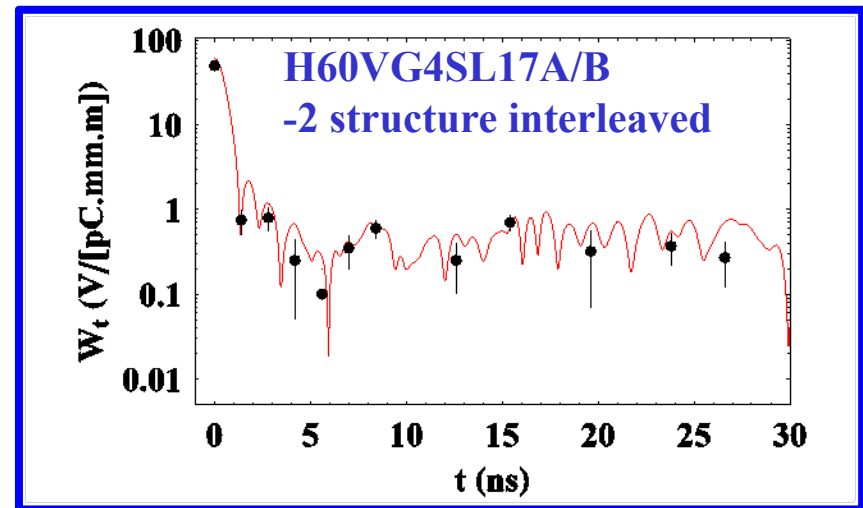

Wake Suppression

CLIC Design Constraints

1) RF breakdown constraint

$$E_{sur}^{\max} < 260MV / m$$

2) Pulsed surface temperature heating

$$\Delta T^{\max} < 56K$$

3) Cost factor

$$P_{in} \sqrt[3]{\tau_p} / C_{in} < 18MW \sqrt[3]{ns} / mm$$

Beam dynamics constraints

1) For a given structure, no. of particles per bunch N is decided by the $\langle a \rangle / \lambda$ and $\Delta a / \langle a \rangle$

2) Maximum allowed wake on the first trailing bunch

$$W_{t1} \leq \frac{6.667 \times 4 \times 10^9}{N} (V / [pC.mm.m])$$

Wake experienced by successive bunches must also be below this criterion

Initial CLIC_DDS Designs

Three designs

- ~~1. Initial investigation of required bandwidth to damp all bunches ($\sim 3\text{GHz}$) –succeeds to suppress wakes, fails breakdown criteria!~~
- ~~2. New design, closely tied to CLIC_G (similar iris Δa), necessitates a bandwidth of $\sim 1\text{GHz}$. Geometry modified to hit bunch zero crossings in the wakefield -succeeds from breakdown perspective, tight tolerances necessary to suppress wakes!~~
3. Relaxed parameters, modify bunch spacing from 6 to 8 rf cycles and modify bunch population. Wake well-suppressed and seems to satisfy surface field constraints. CLIC_DDS_C ($\Delta f \sim 3.6\sigma \sim 13.75\%$) –**SUCCESS (on suppressing wakes and meeting breakdown criteria)**

Initial CLIC_DDS Design – Δf determination

of Accelerator Science and Technology

Structure	CLIC_G
Frequency (GHz)	12
Avg. Iris radius/wavelength $\langle a \rangle / \lambda$	0.11
Input / Output iris radii (mm)	3.15, 2.35
Input / Output iris thickness (mm)	1.67, 1.0
Group velocity (% c)	1.66, 0.83
No. of cells per cavity	24
Bunch separation (rf cycles)	6
No. of bunches in a train	312

Lowest dipole $\Delta f \sim 1\text{GHz}$
 $Q \sim 10$

CLIC_G

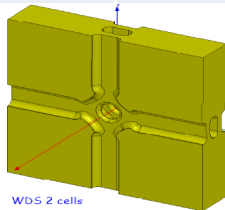

WDS 2 cells

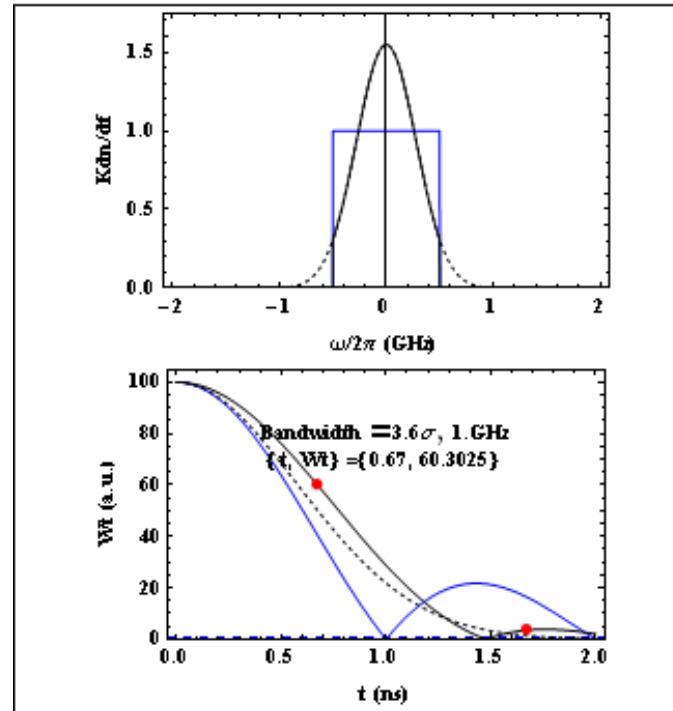

Bandwidth Variation

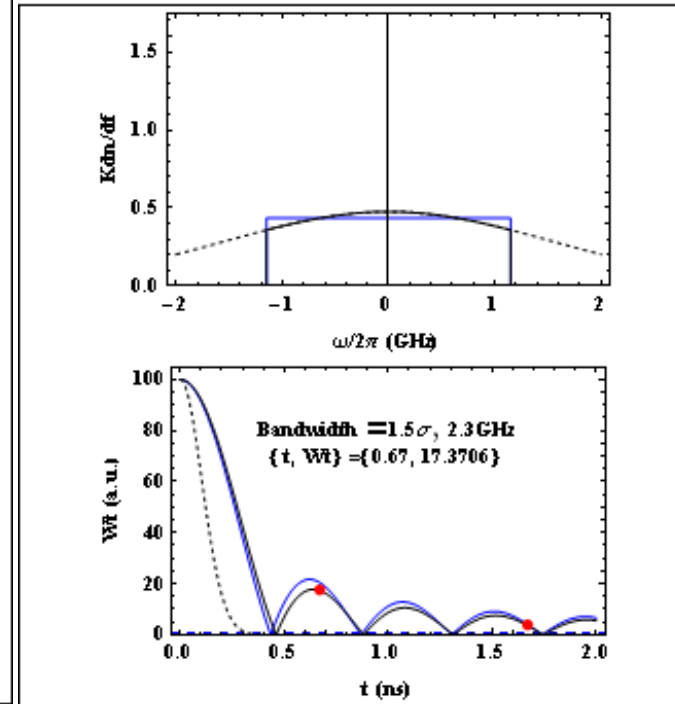

σ Variation

Truncated Gaussian :

$$W_t = 2\bar{K}e^{-2(\sigma\pi t)^2} |\chi(t, \Delta f)|$$

$$\text{where: } \chi(t, \Delta f) = \frac{\text{Re}\left\{\text{erf}\left(\frac{[n_\sigma - 4i\pi\sigma t]}{2\sqrt{2}}\right)\right\}}{\text{erf}(n_\sigma / 2\sqrt{2})}$$

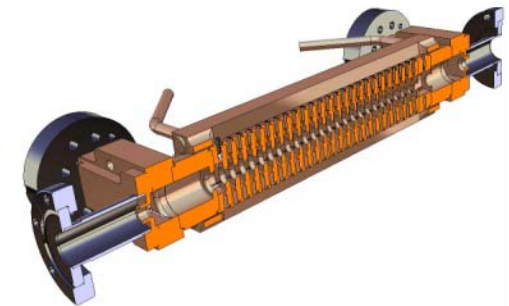

CLIC_DDS Uncoupled Design

Relaxed parameters tied to surface field constraints

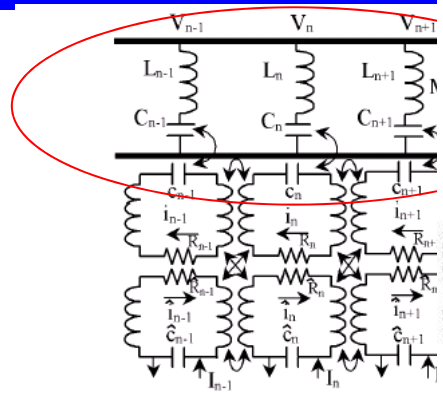
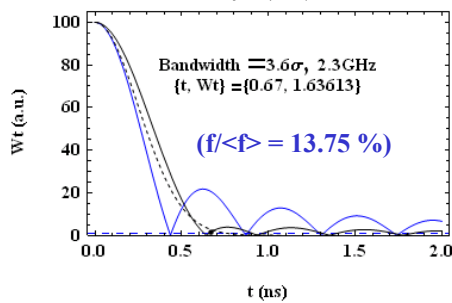
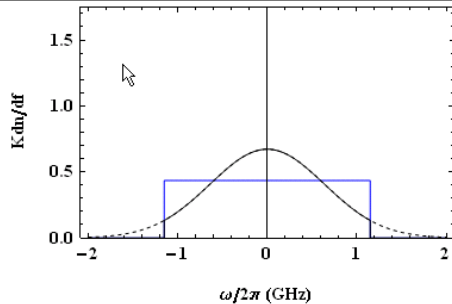

Three cells in the chain are coupled to the beam and TE modes and excited at the manifold is via TE manifold is modeled as a transmission line periodically loaded with L-C elements.

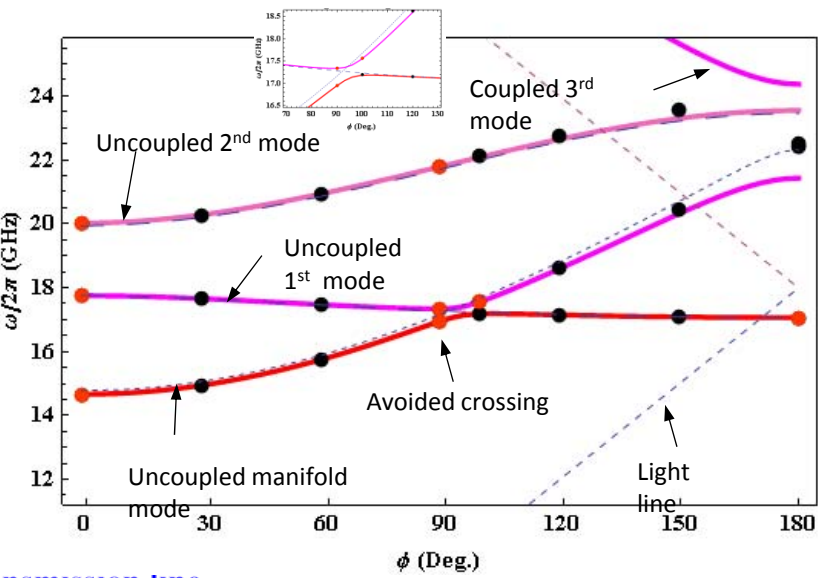

Mid-Cell

- Dispersion curves for select cells are displayed (red used in fits, black reflects accuracy of model)
- Provided the fits to the lower dipole are accurate, the wake function will be well-represented
- Spacing of avoided crossing (inset) provides an indication of the degree of coupling (damping Q)

Cct Model Including Manifold-Coupling

- Spectral Function - including Manifold-Coupling, to calculate overall Wakefunction!
- Not possible by other methods.

Uncoupled parameters

Cell 1

- Iris radius = 4.0 mm
- Iris thickness = 4.0 mm
- ellipticity = 1
- Q = 4771
- R'/Q = 11,640 Ω/m
- vg/c = 2.13 %c

Cell 24

- Iris radius = 2.13 mm
- Iris thickness = 0.7 mm
- ellipticity = 2
- Q = 6355
- R'/Q = 20,090 Ω/m
- vg/c = 0.9 %c

Structure Geometry: Cell Parameters

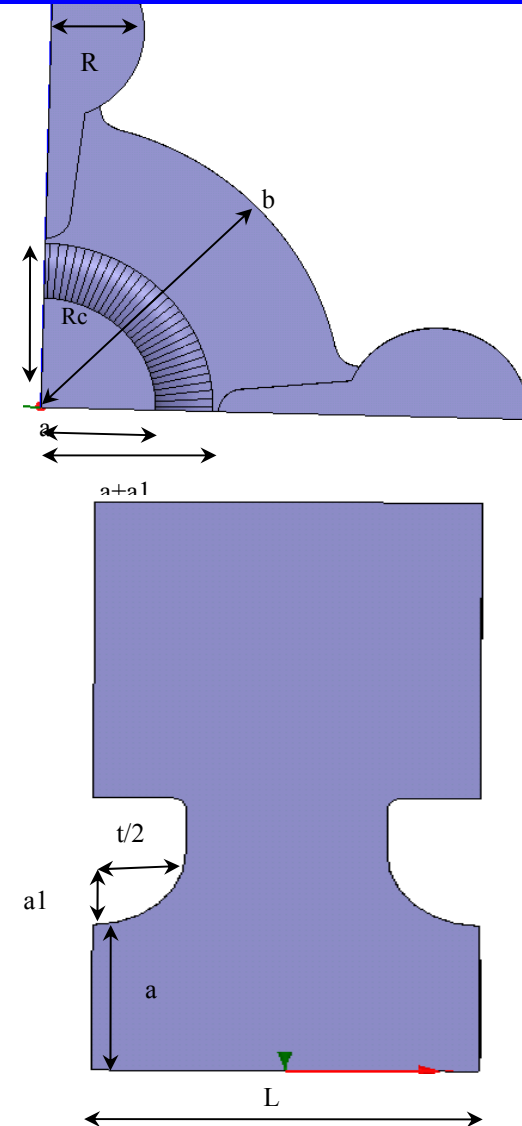
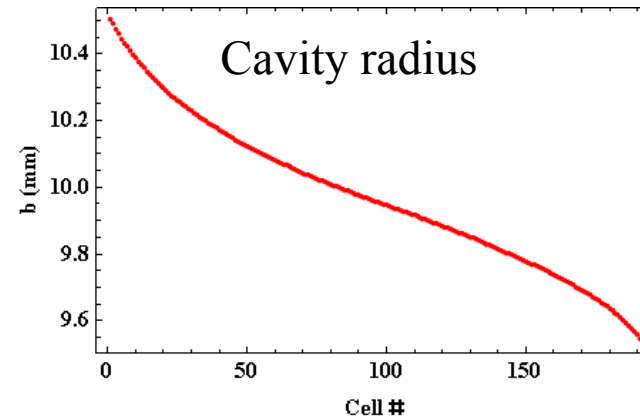
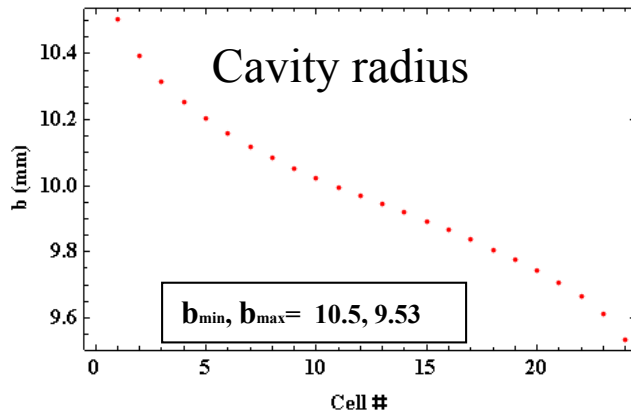
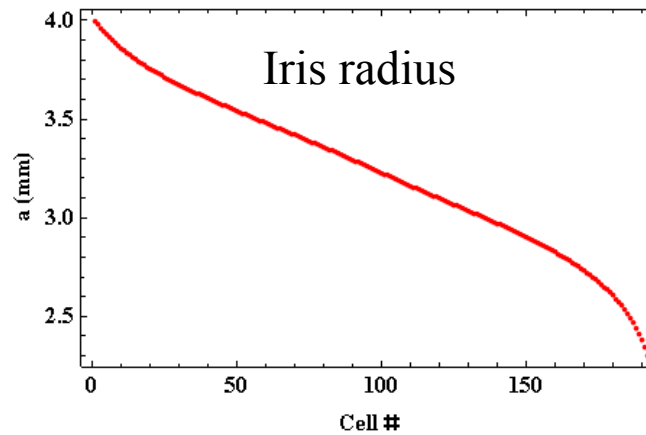
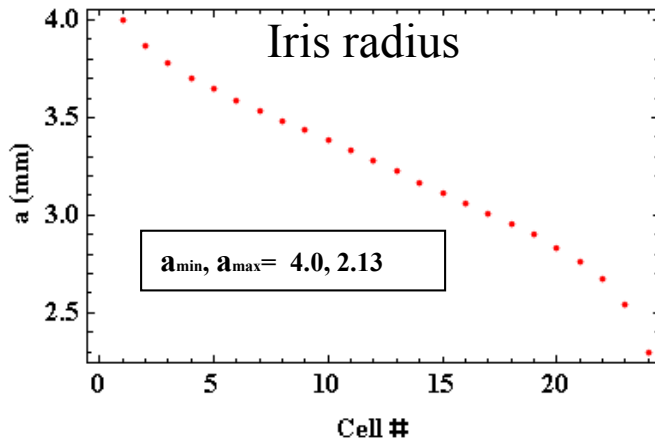

Sparse Sampled HPT
(High Power Test)

Fully Interleaved
8-structures

Summary of CLIC_DDS_C

Dipole mode

Manifold mode

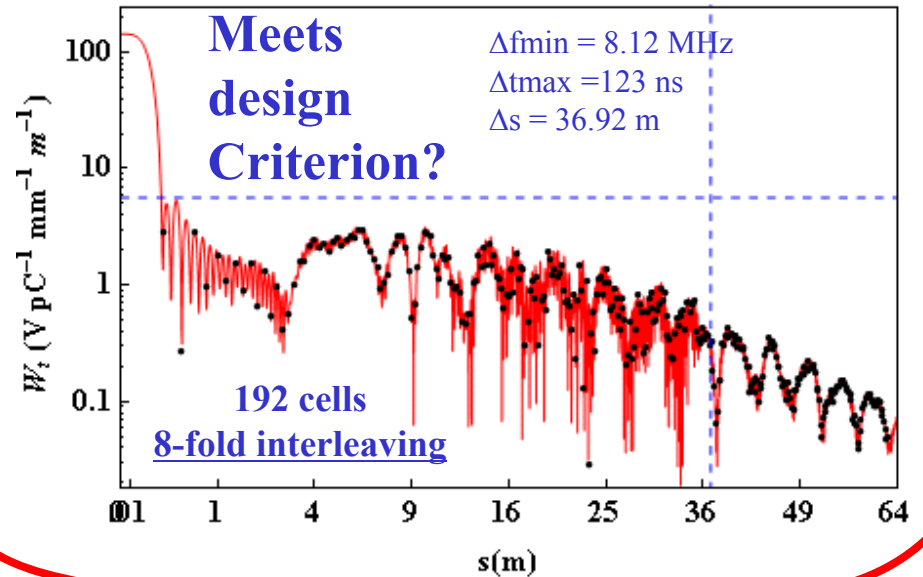
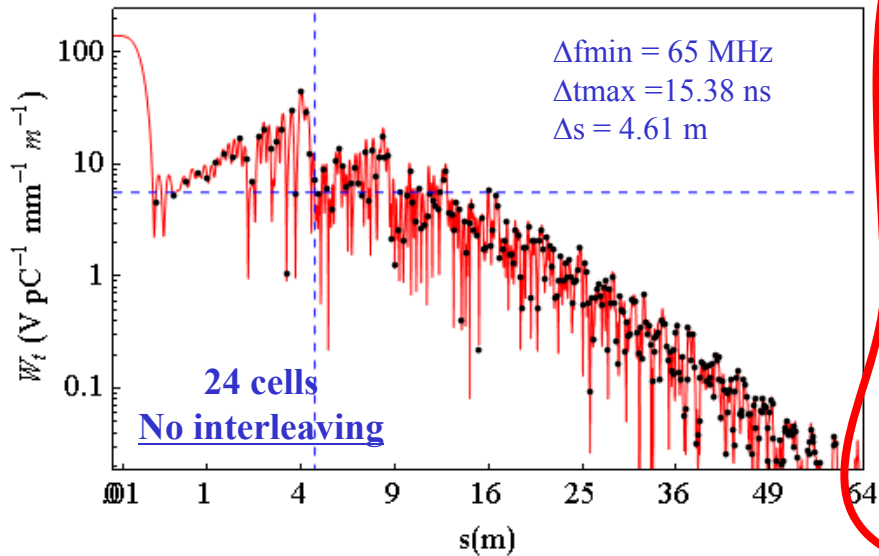
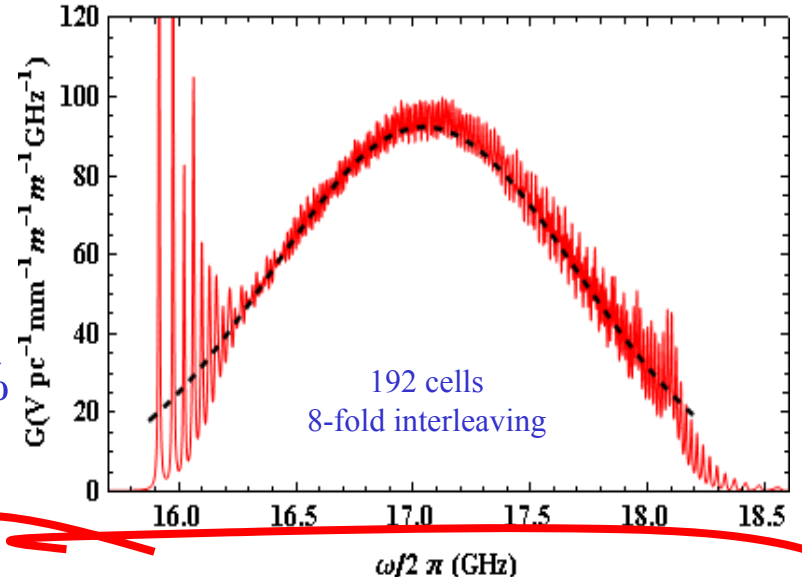
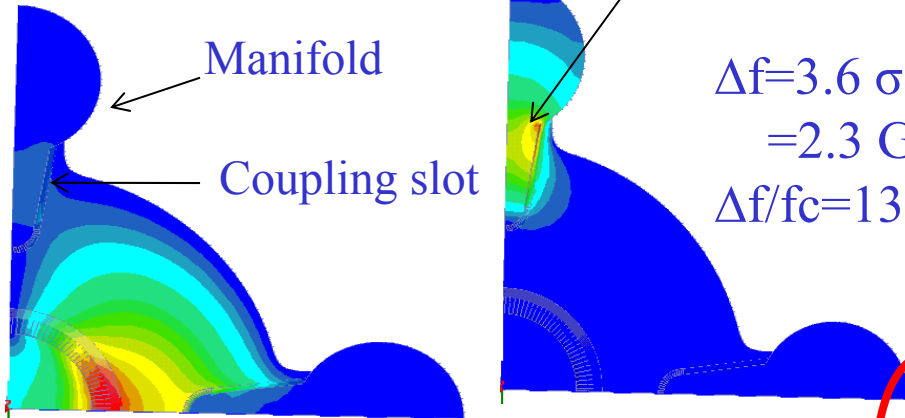

- **Enhanced H-field on various cavity contours results in unacceptable ΔT ($\sim 65^\circ$ K).**
- **Can the fields be redistributed such that a $\sim 20\%$ rise in the slot region is within acceptable bounds?**
Modify cavity wall
- **Explore various ellipticities (R. Zennaro, A. D'Elia, V. Khan)**

Single undamped cell Iris radius=4.0 mm

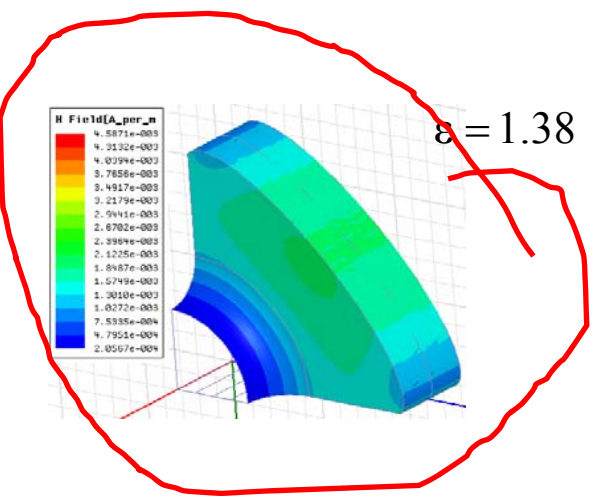
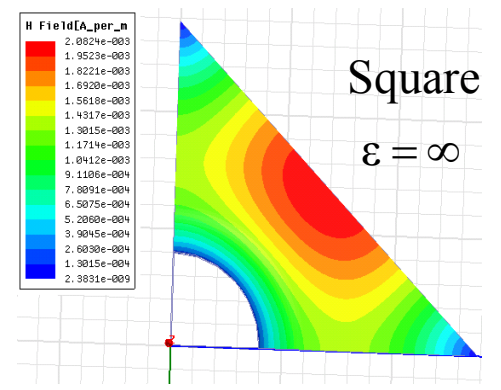
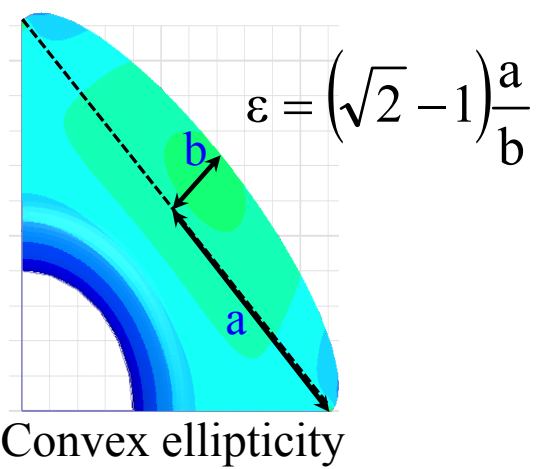
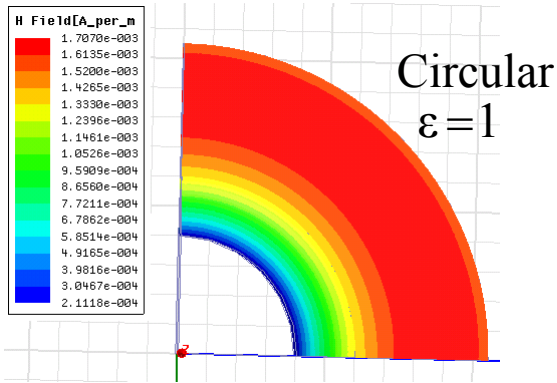

	Circular	Rectangular	Elliptical (Convex)	0	1.38	0.82
ϵ of cavity	1	∞	4.14	2.07	1.38	0.82
f_{acc} (GHz)	12.24	12.09	11.98	12.0	11.99	11.98
E_{acc} (V/m)	0.43	0.43	0.42	0.43	0.43	0.42
H_{max}^{sur}/E_{acc} (mA/V)	3.64	4.86	4.71	4.54	4.29	3.75
E_{max}^{sur}/E_{acc}	2.27	2.27	2.33	2.28	2.28	2.33

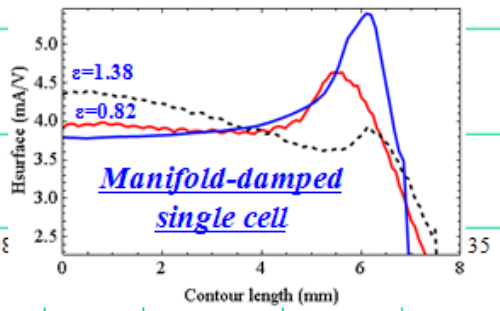

Iris radius = 4.0 mm
Iris thickness = 4.0 mm

Chosen design

CLIC_DDS_E vs CLIC_DDS_ER Wakefield

Spectral Function

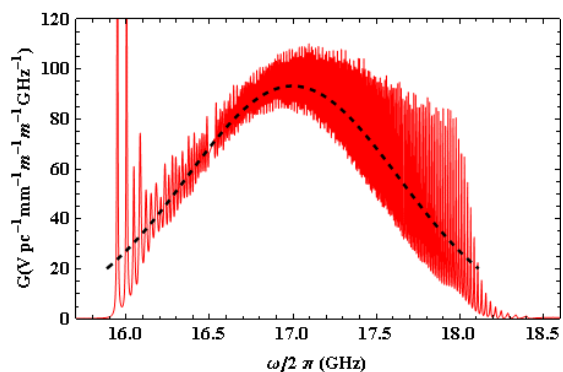

Wakefunction

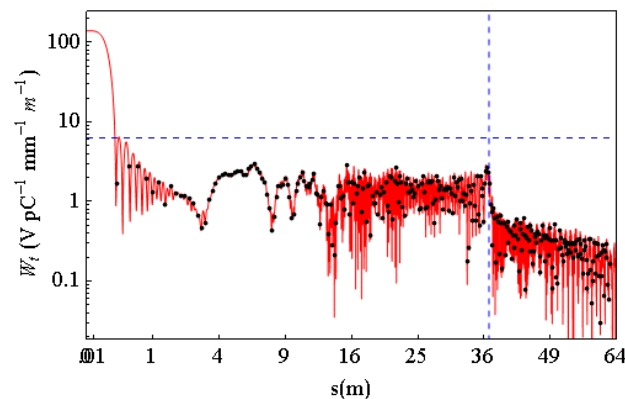

CLIC_DDS_E : $R_c=6.2 - 6.8$ mm (optimised penetration)

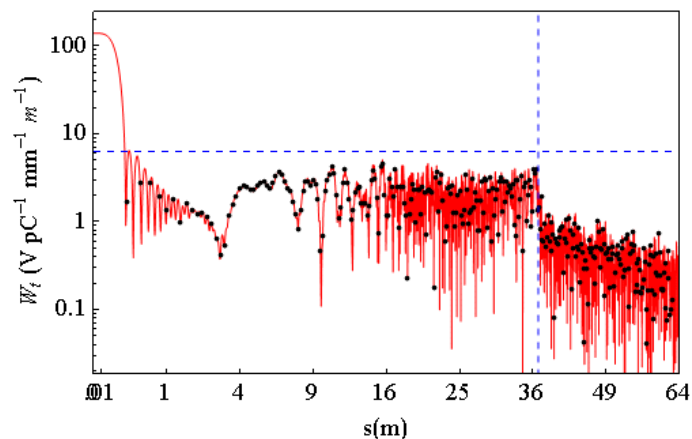
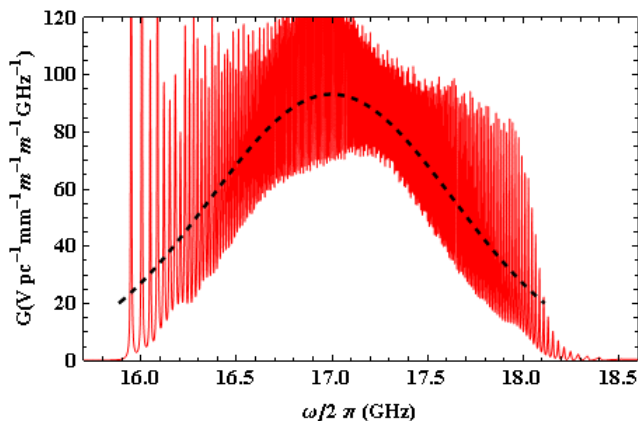

- **CLIC_DDS_ER : $R_c=6.8$ mm const (a single one of these structures constitutes CLIC_DDS_A, being built for HP testing)**
- **Wakefield suppression is degraded but still within acceptable limits.**

Mechanical Eng. Design of DDS_A

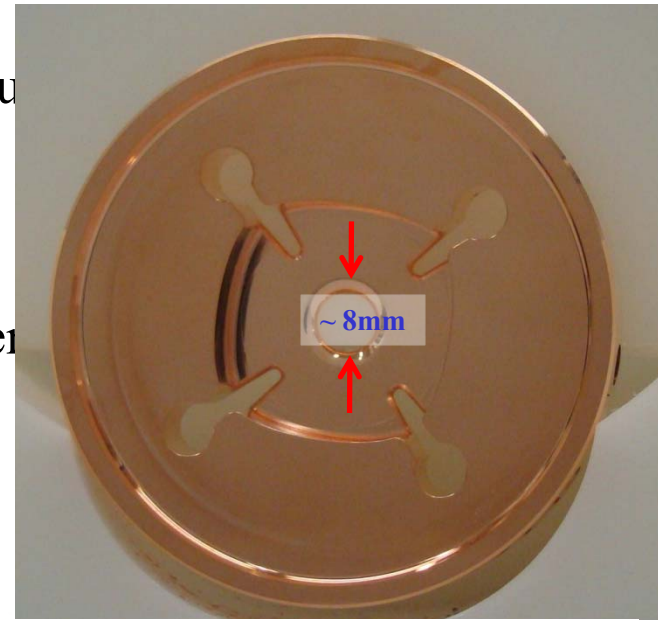
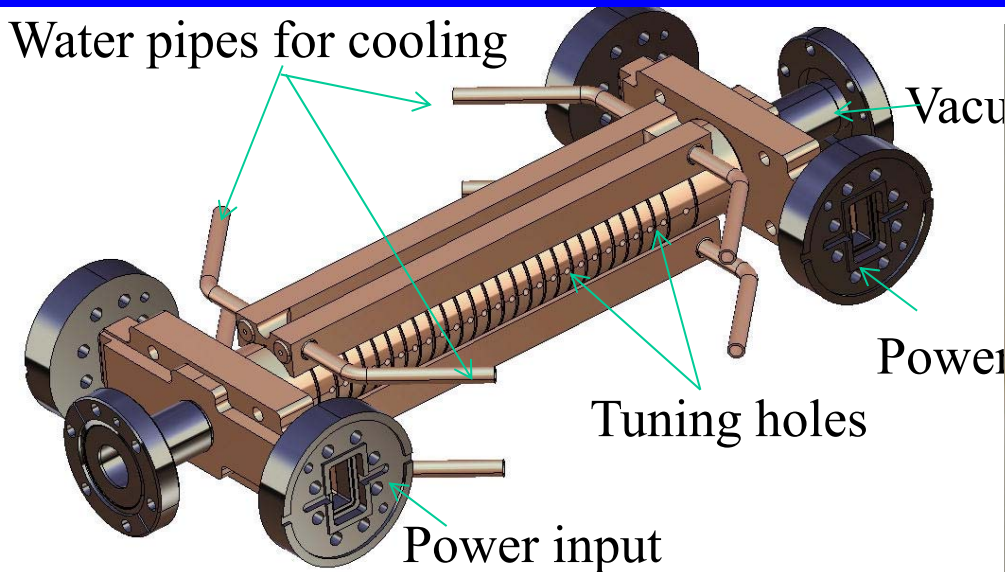

- Info. on the ability of the 8-fold interleaved structure to sustain high e.m. fields and sufficient ΔT can be assessed with a single structure
- Non-interleaved 24 cell structure – first structure of 8-fold interleaved structure chosen.
- High power ($\sim 71\text{MW}$ I/P) and high gradient testing
- To simplify mechanical fabrication, uniform manifold penetration chosen

- Qualification cells complete!
- Metrology and bonding of 4-cell stack tested at CERN
- Encouraging results

G. Riddone, V.Soldatov, CERN

Cell Qualification of CLIC_DDS_A

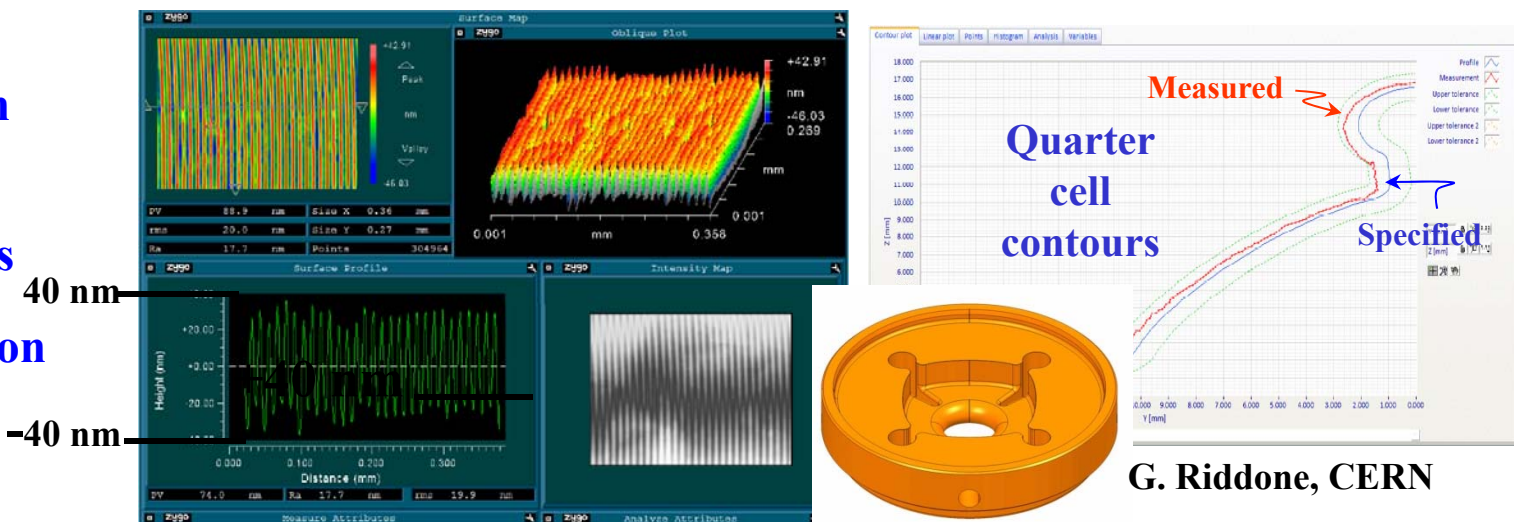

- VDL (Netherlands) have machined and measured several cells –end cells. (recvd by CERN Oct 2010)
- Global profiles made with optical Zygo machine are illustrated for disk 24
- Design, tolerance bounds and achieved profile shown

- Local profile made with an optical Zygo machine
- Local profiles indicate < 50nm variation in surface roughness
- Cell 24 displayed



- We are now using Morikawa (Japan) to fabricate cells –rf test at KEK and CERN
- Fabrication and bonding of complete structure by end of Jan 2012
- HP test of structure in 2012?

Fabrication Status of CLIC_DDS_A

- **MORIKAWA, under direction of KEK (T. Higo), has produced 5 disks - cold RF measurements and metrological control performed in November 20**  
- **Initial measurements on cells performed at KEK (T. Higo)**
- **Five, in principle, identical cells delivered to CERN together with two half cells to be used for measurements –for further measurements a CERN**
- **Cells now completed metrological control**
- **Stack setup for RF measurements built at CERN (next slide)**
- **Measurements made in November 2011**
- **Full production of all cells going ahead in December –expect final bonded structure by end of Jan 2012 (revised June 2012)**

First Comparison Between KEK Measurements & Simulations on Morikawa Cells

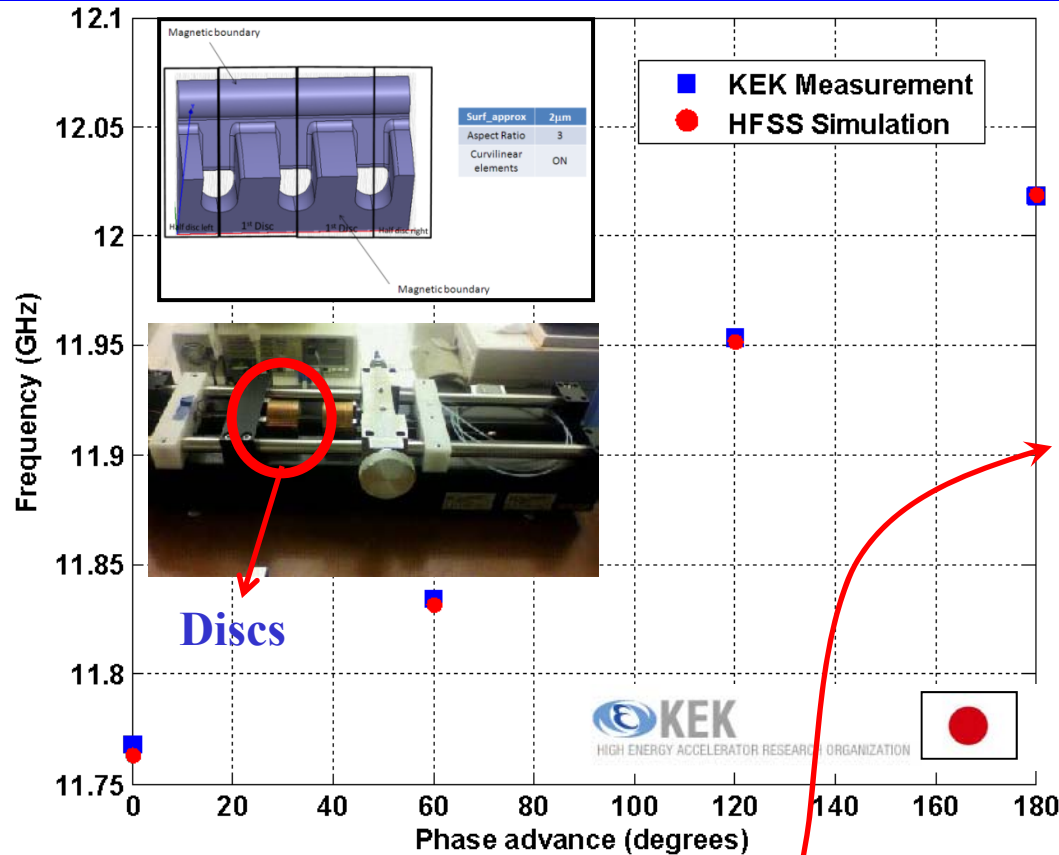

	HFSS*	KEK	Δ
Mode 0 (MHz)	11762.8	11767.5	-4.7
Mode $\pi/3$ (MHz)	11831.6	11833.75	-2.15
Mode $2\pi/3$ § (MHz)	11951.7	11953.75	-2.05
Mode π (MHz)	12019.0	12018.437	0.6

* HFSS scaled in air using $\epsilon_r=1.000618$

§ This cell is the *actual* cell – non-symmetrical and equipped with an averaging of b. This explains the difference in the frequency from the nominal value of 11994.6MHz

Tuning range ~20MHz

Indicative of
~2µm fab tolerance!

Measurements at CERN

Prototype disc produced by Morikawa. Front

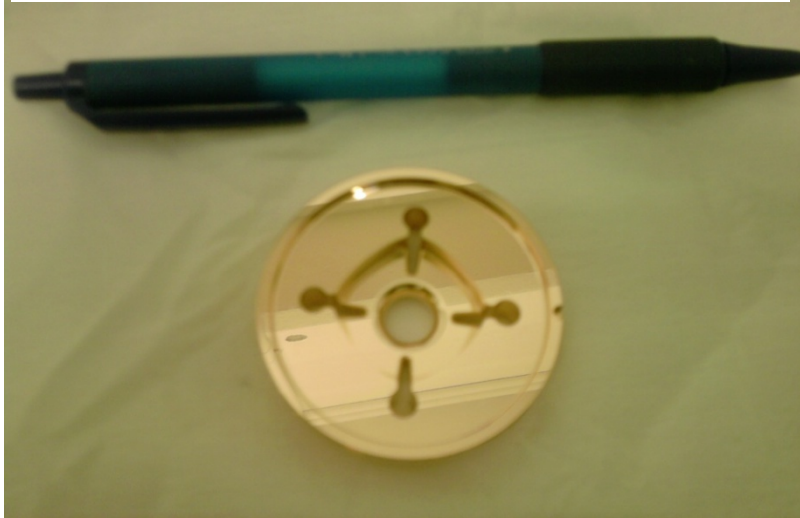

Prototype disc produced by Morikawa. Back



European Organization for Nuclear Research

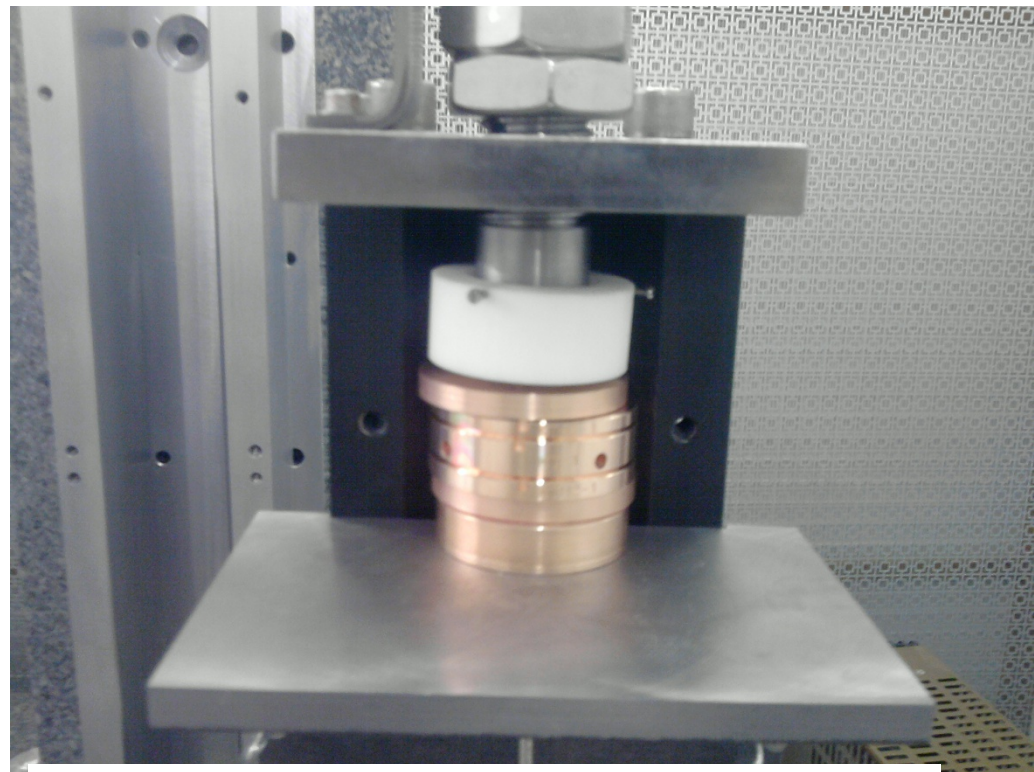

**November CLIC_DDS_A Disks ready for
RF measurements at CERN!**

CLIC_DDS_A Measurements at CERN

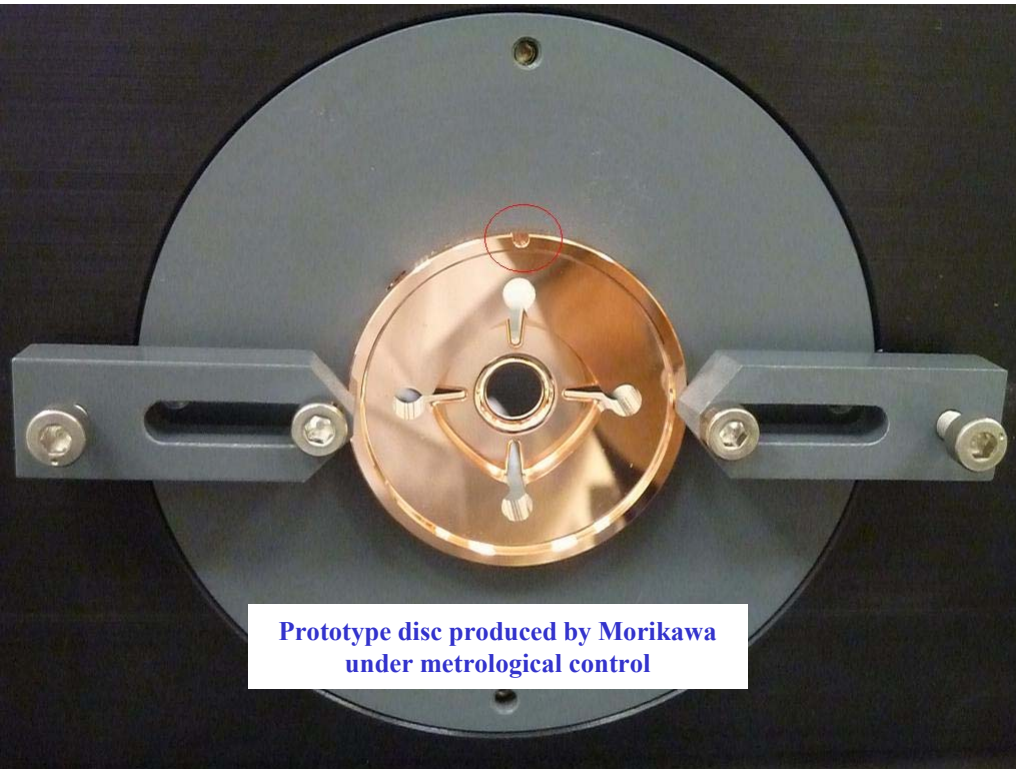

- A stack of 7 discs in total (5 regular discs + 2 halves) at CERN were submitted to:
1. Metrological assessment
 2. RF cold measurements both for Monopole and for first Dipole Band.

- Production of 26 discs (24 regular discs+2 Matching disks) initiated in Japan in December.
- Expected delivery date for complete set the discs, is end of January (revised June?)

Beam Dynamics

Direct Effect

- Assumes bunches are effected one- on-one –usual assumption for many years!
- a is a matrix which describes the wake
- In addition for CLIC_G Q ~ 10 and this effectively enables W_t to be neglected after to nearest neighbours

Indirect Effect

- Assumes bunches are influenced by succeeding bunches –many bunch coupling

Bunch k kicks j:

$$y_j = a_{j-k} y_k$$
$$a_{j,k} = \begin{cases} \frac{LW_t(z_j - z_k, s)Ne^2}{2k_\beta E(s)} & \forall j > k \\ 0 & \forall j \leq k \end{cases}$$

L is the cell length, s is the distance down linac,

N is the number of bunches, k_β is betatron focussing and

E is the energy

At end of linac all bunches in a matrix:

$$y_f = (1 + a)y_i$$

Beam Dynamics

Indirect Effect

- Straightforward to build this up in an iterative process for m bunches –each bunches communicates with its neighbour and this ripples down the chain
- Figures of merit:
 F_c representative of coherent oscillations of the train -the rms over the whole train
 F_{rms} the bunch to bunch rms

$$F_c = \frac{1}{n} \sum_k \left| \sum_j A_{kj} \right|^2$$

$$F_{rms} = \frac{1}{n} \sum_{k=0}^{n-1} \sum_{j=1}^k |A_{j,k}|^2$$

$$y_f = \left(1 + \frac{a}{m} \right)^m y_i$$

In the limit of an infinite number of bunches

$$y_f = Ay_i$$
$$A = \exp(a)$$

Returning to a finite number of bunches Taylor expand:

$$A = \sum_{k=0}^{\infty} \frac{a^k}{k!} = \sum_{k=0}^{n-1} \frac{a^k}{k!}$$

$$(a^n = 0 \text{ since } a_{jk} = 0 \forall j \leq k)$$

Beam Dynamics

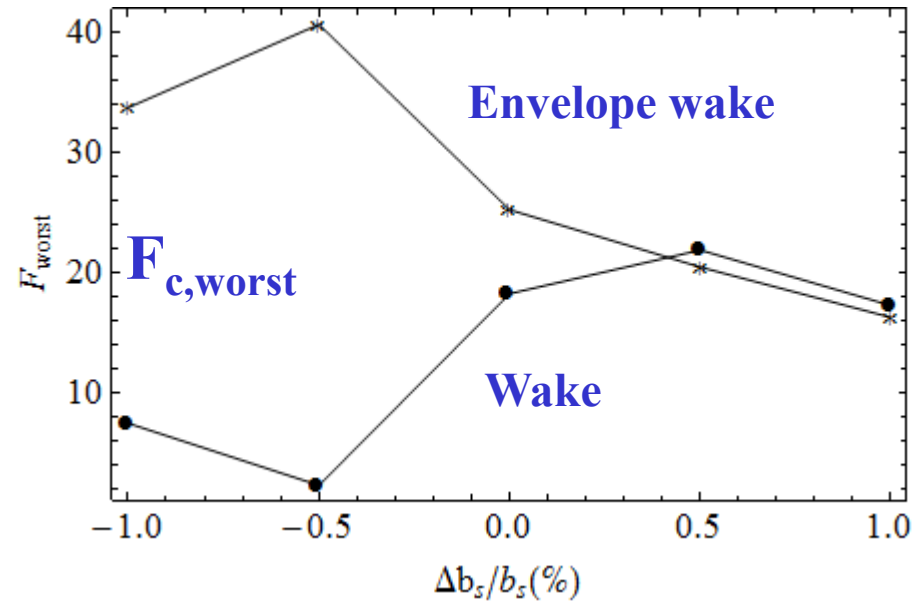
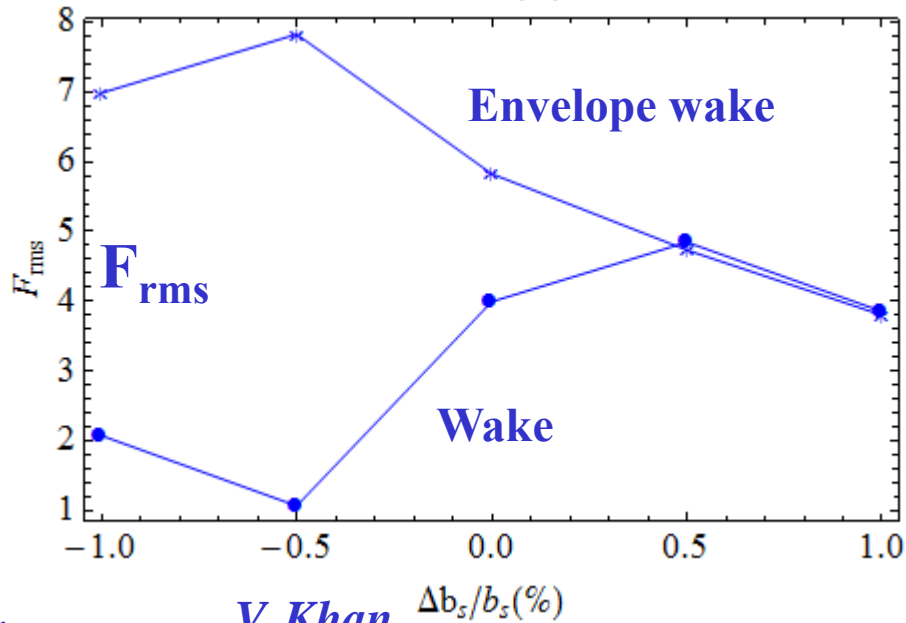
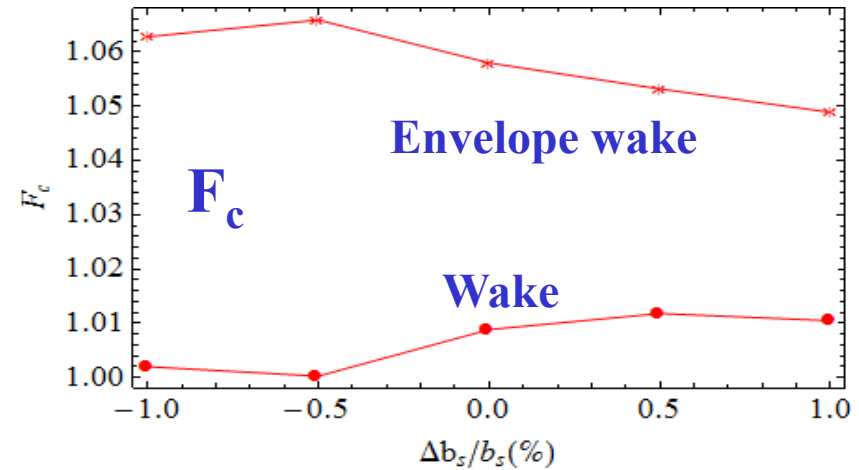
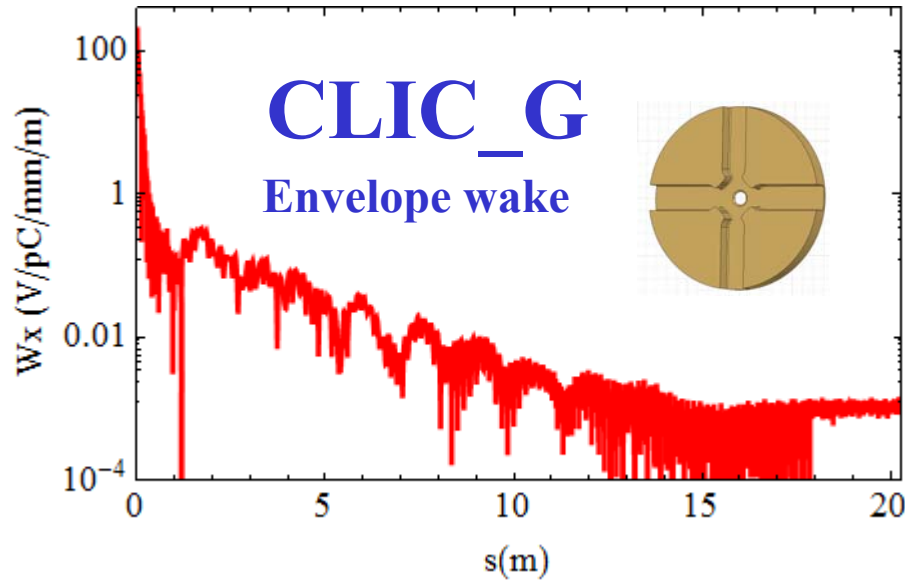

Beam Dynamics

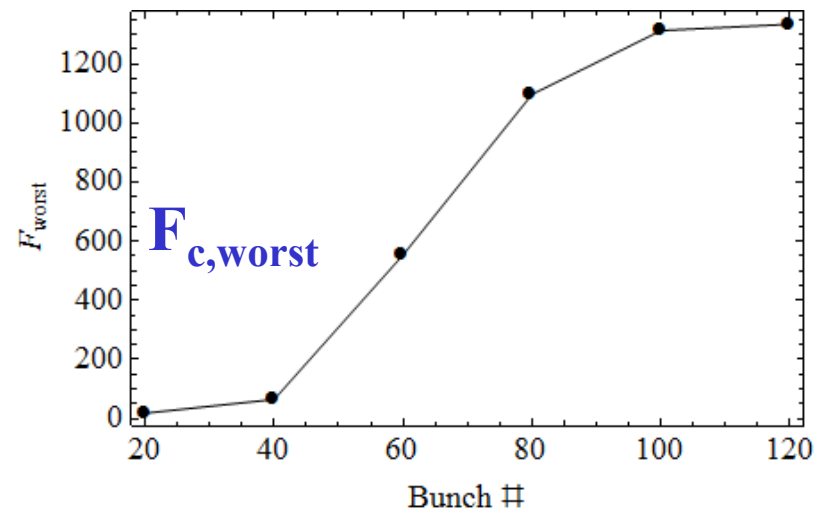
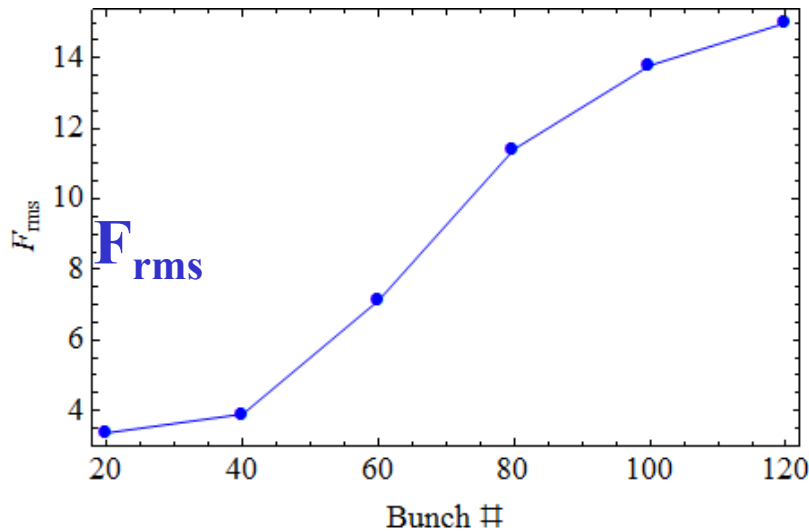
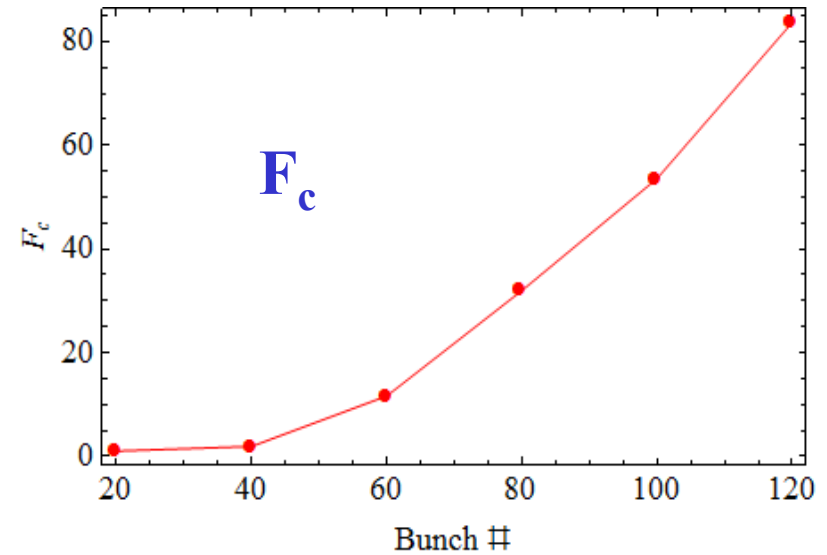
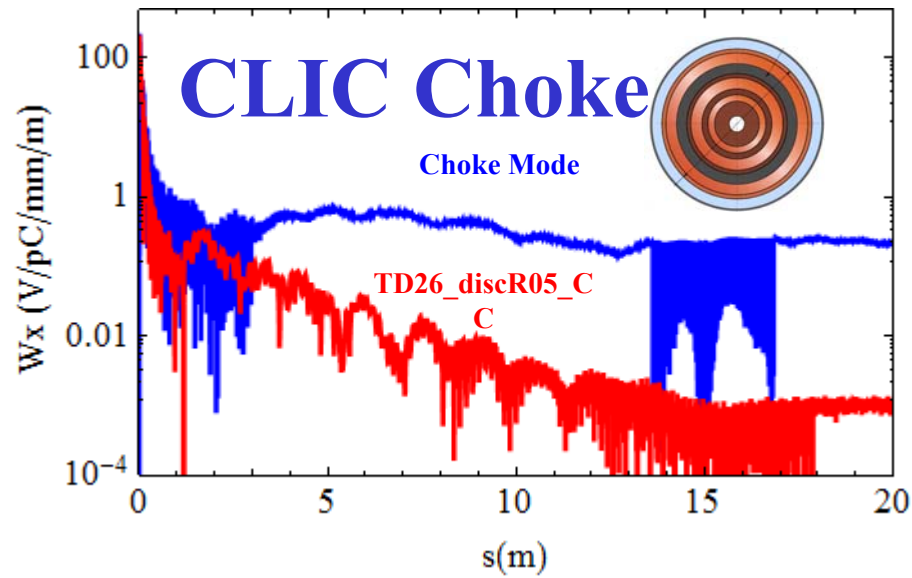

Beam Dynamics

CLIC_DDS

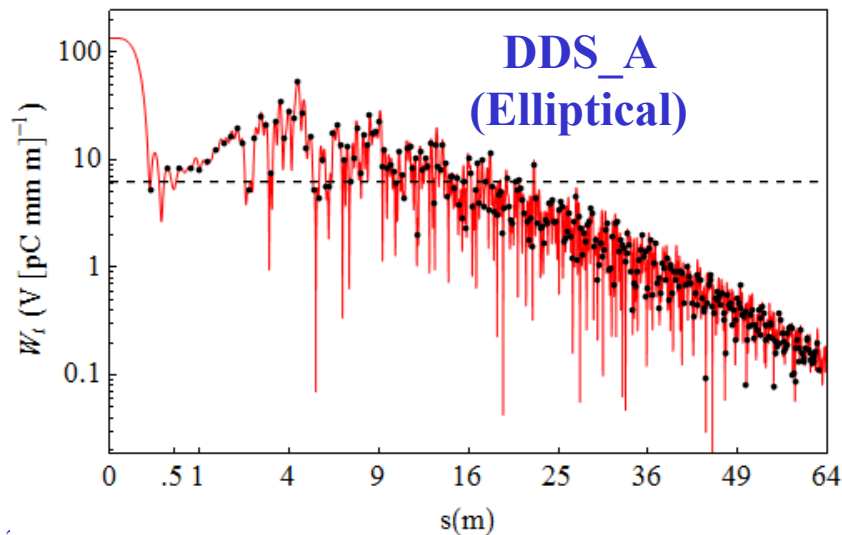
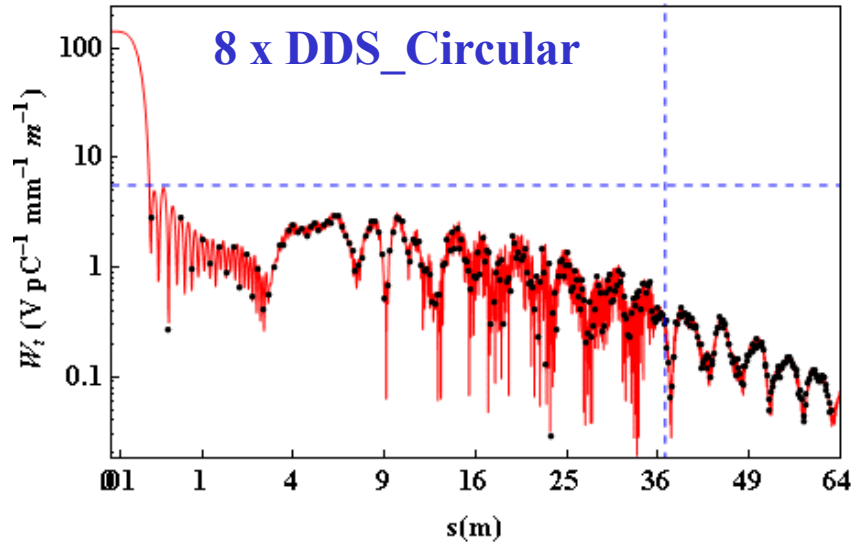
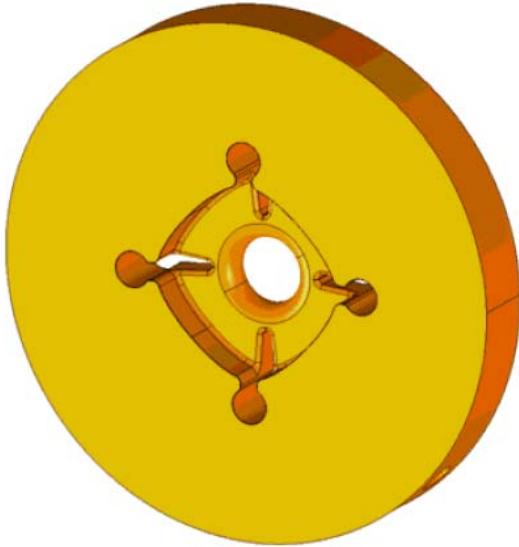

CERN and Uni. Manchester + C.I. collaboration

Structure	Wake (with phase information)		
	F_c	F_{rms}	F_w
DDS_A	1.29×10^{24}	1.25×10^{27}	1.32×10^{28}
8 x DDS_A	3.4×10^5	2.8×10^7	7.5×10^8
8 x DDS (Circular cells)	6573	5×10^6	1.55×10^8

Beam Dynamics – Uncoupled Wake

The Cockcroft Institute

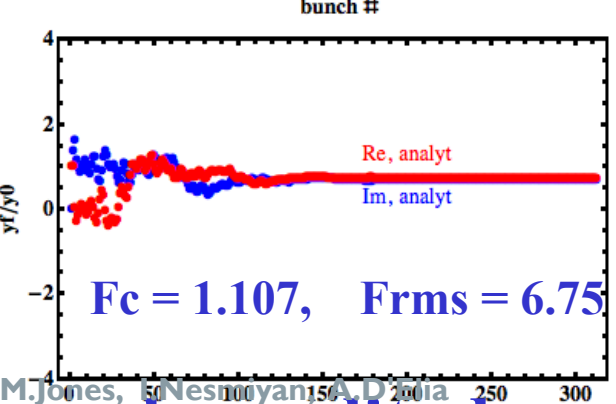
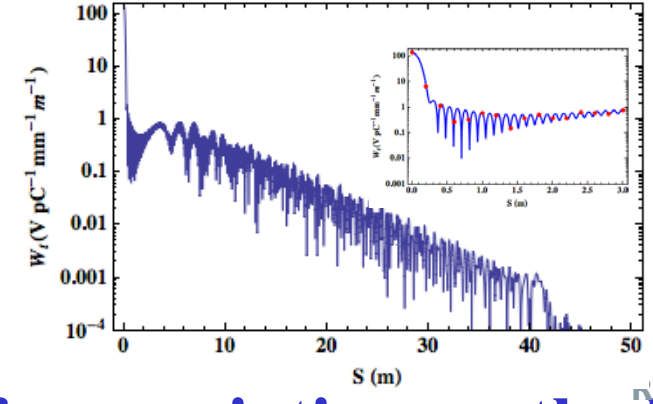
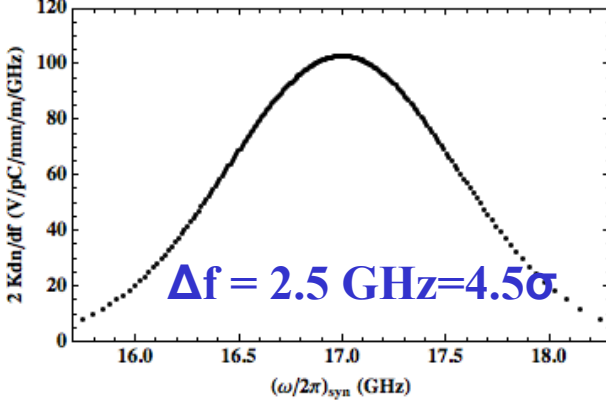
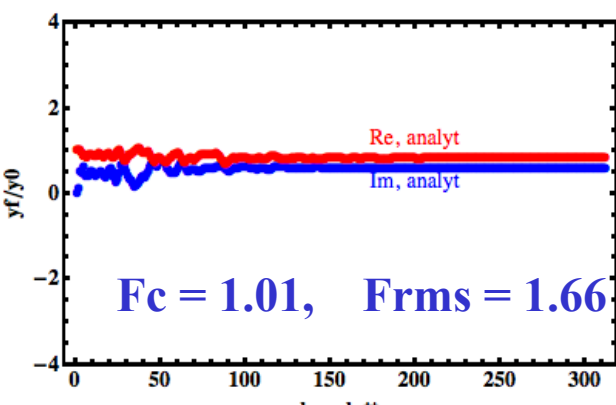
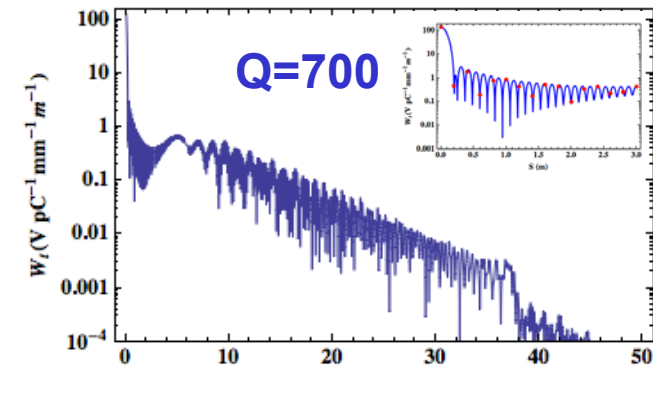
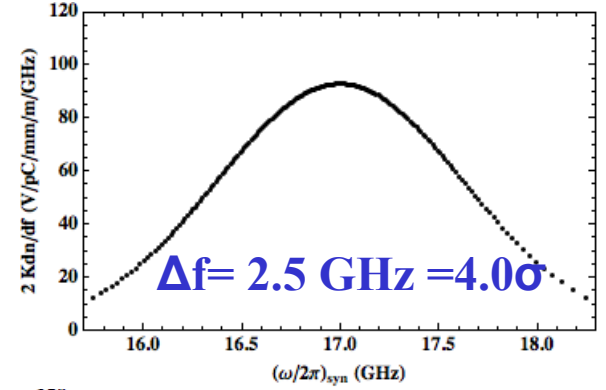
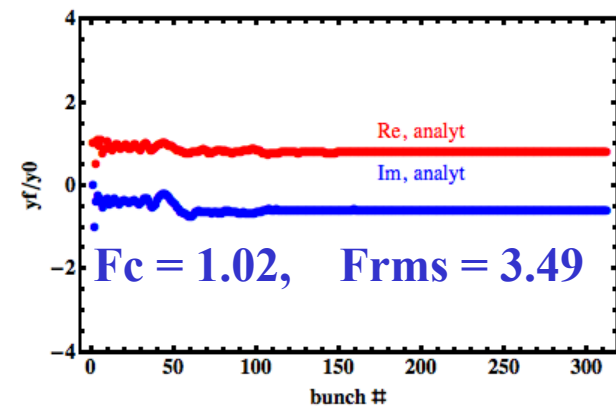
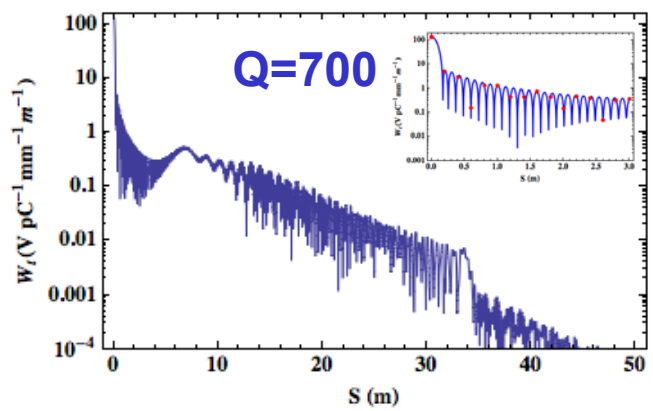
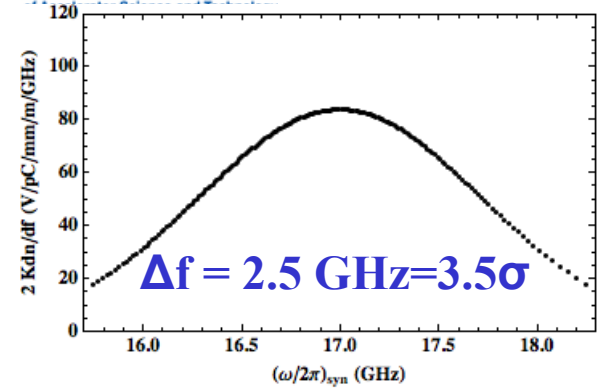

Influence of n_g variation on the bunch amplitude

Beam Dynamics

Tr

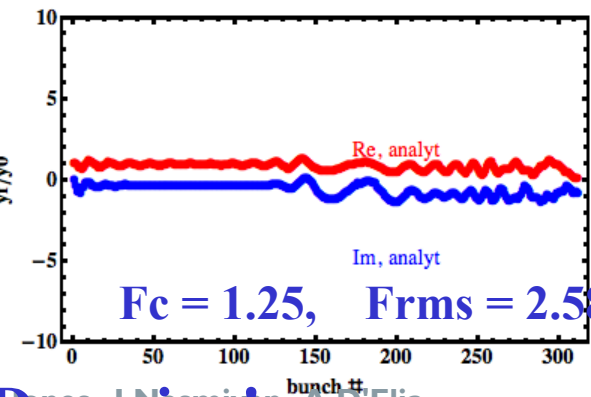
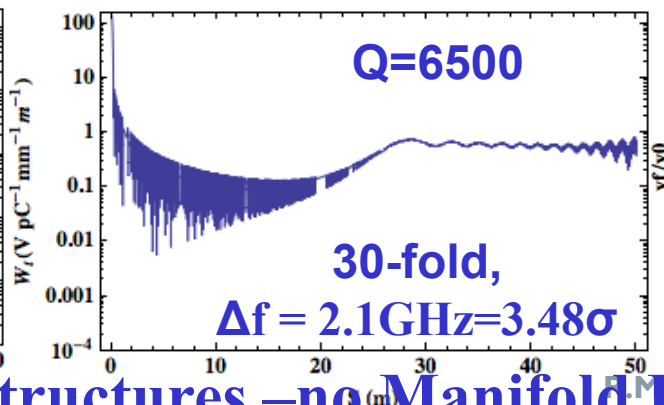
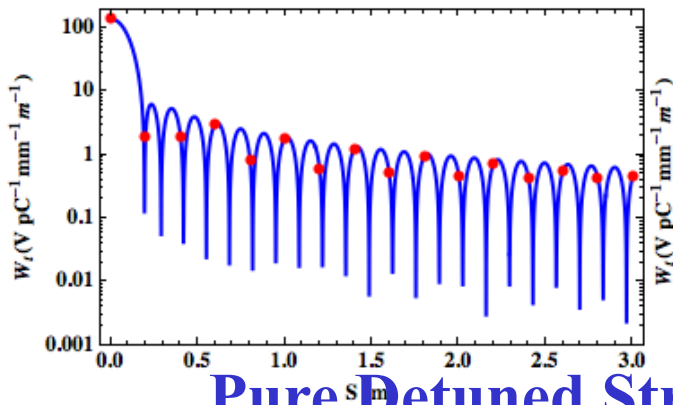
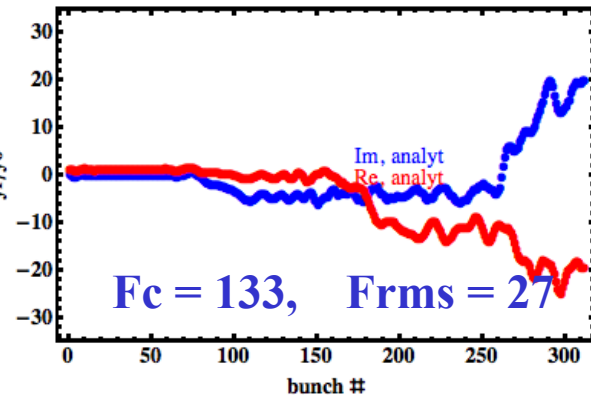
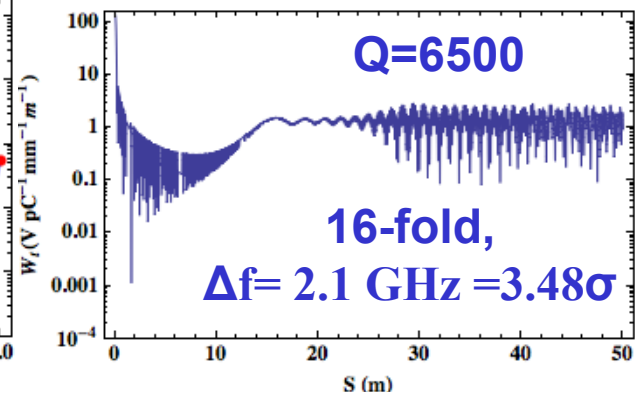
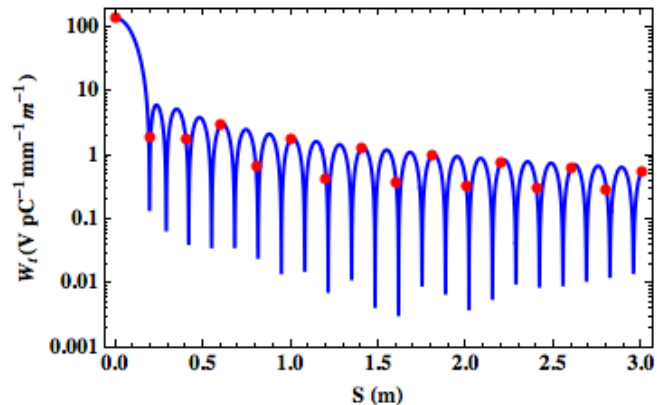
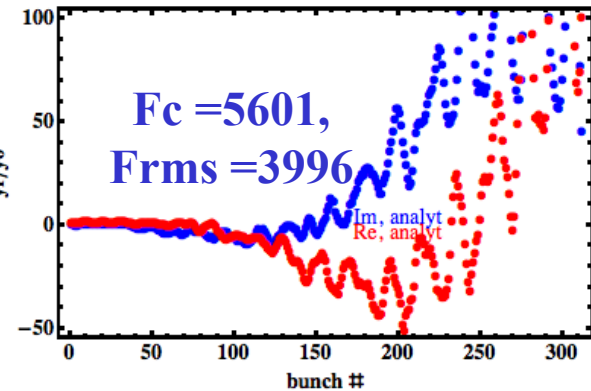
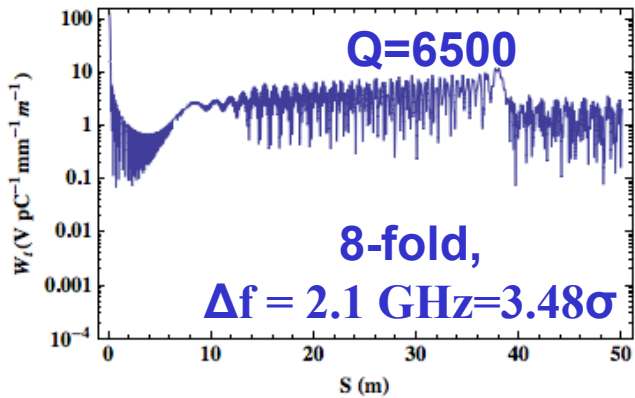
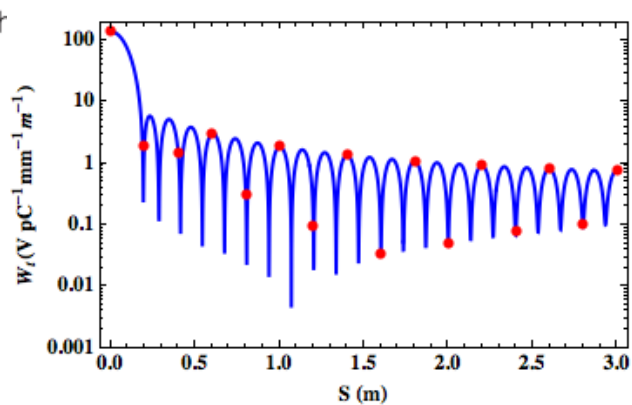

Pure Detuned Structures –no Manifold Damping!

R.M. Jones, I. Neermiyam, A.D'Elia

Beam Dynamics Summary

Design	F_c	F_{rms}
CLIC_G	1.01	4
CLIC_Choke	80	14
DDS x8 (Q~2000)	3×10^4	2×10^6
DDSx8 (Q=700)	1.03	1.5

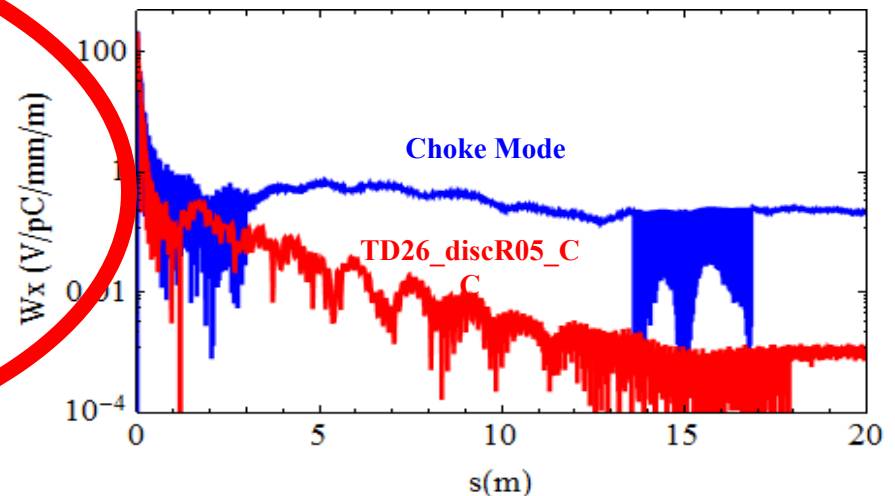
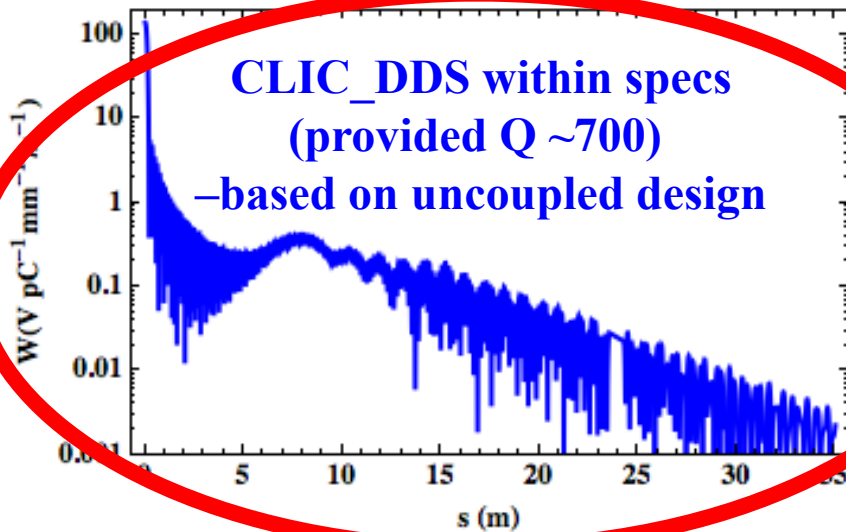
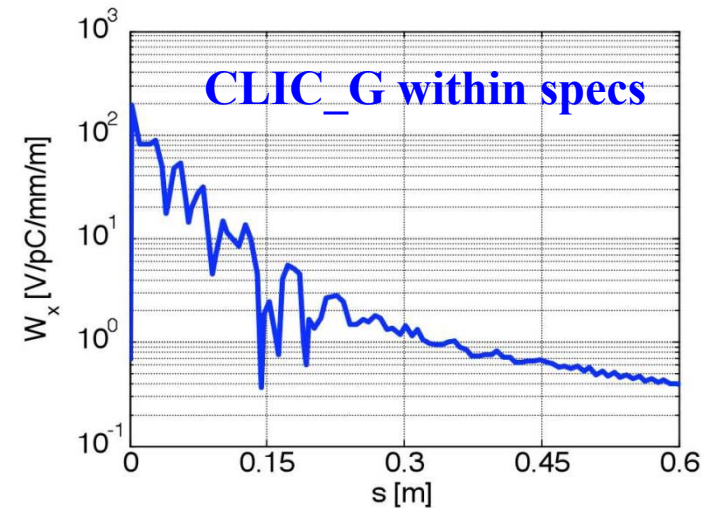

C.f. NLC/JLC design achieved $Q \approx 500$, with 4-fold interleaving (SLAC-PUB- 9868)

Future Structure: CLIC_DDS_B

- Aim is to install in CTF3
- This structure will be based on a revised version of CLIC_DDS_A - equipped with HOM couplers and a compact coupler for fundamental mode
- Both wakefield suppression and high power performance will be tested
- Circuit model used to assess influence of HOM couplers on wakefields
- GdfidL simulations in progress – sans HOM coupler

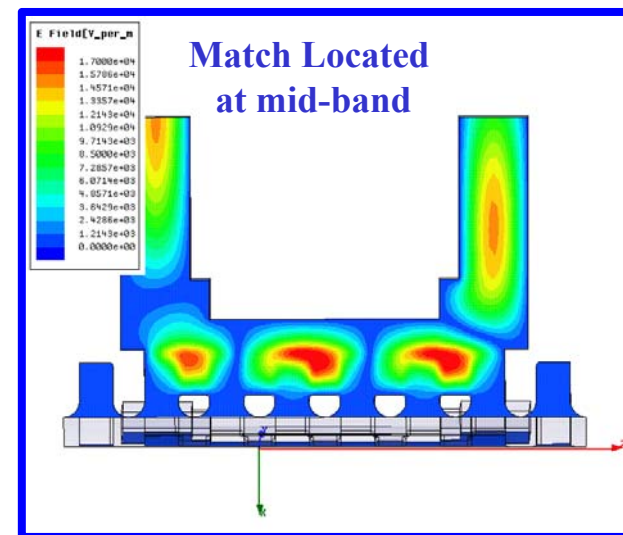
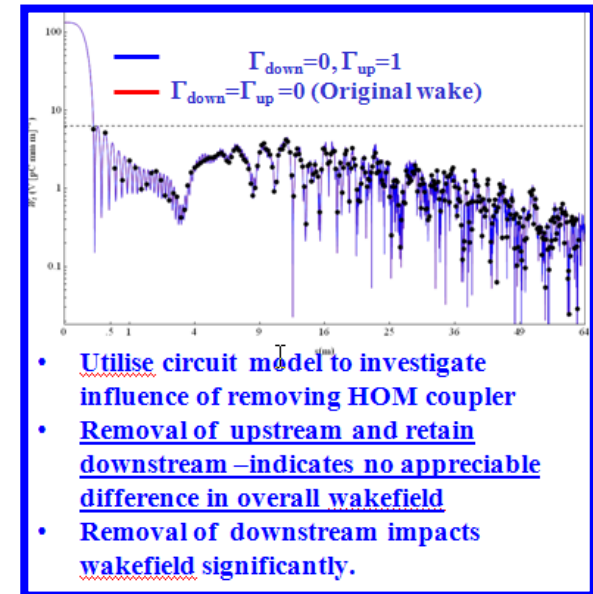

Final Remarks

□ CLIC_DDS_A

- Full rf and mechanical design for structure equipped with mode-launcher couplers (based on 8-fold interleaving with full wakefield damping)
- Fabrication of cells expected to be complete at end of Feb 2012 (modified to June?) –and high power tested in 2012
- High power measurement at CERN/KEK in 2012?
- ASSET measurement of structures at SLAC in 2012?
- GdfidL and circuit model used to simulate structure

□ CLIC_DDS_B

- Modification of regular cell design –beam dynamics study and enhanced damping profile under investigation
- Design of HOM and FP couplers for the new structure – progress (but a modified distribution needed to satisfied beam dynamics constraints)

□ Additional Research Ongoing

- Increased damping (additional manifolds), hybrid (between heavy damping and manifold damped) structures –initial encouraging results but further work needed (See poster by Alessandro D’Elia).

Acknowledgements

- I am pleased to acknowledge a strong and fruitful collaboration between many colleagues and in particular, from those at CERN, University of Manchester, Cockcroft Inst., SLAC and KEK

CLIC DDS Selected Pubs.

1. R. M. Jones, *et. al*, PRST-AB, 9, 102001, 2006.
2. V. F. Khan and R.M. Jones, EPAC08, 2008.
3. V. F. Khan and R.M. Jones, LINAC08, 2008.
4. V. F. Khan and R.M. Jones, Proceedings of XB08, 2008.
5. R. M. Jones, PRST-AB, 12, 104801, 2009.
6. R. M. Jones, *et. al*, NJP, 11, 033013, 2009.
7. V. F. Khan and R.M. Jones, PAC09, 2009.
8. V. F. Khan, *et. al*, IPAC10, 2010.
9. V. F. Khan, *et. al*, LINAC10, 2010.
10. R.M. Jones, NIMA, 2011.
11. V.F. Khan *et. al*, NIMA, 2011.
12. V.F. Khan, PhD thesis, 2011.

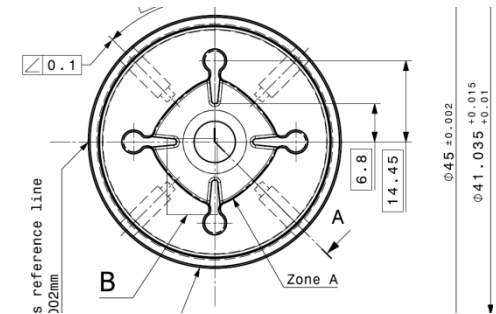
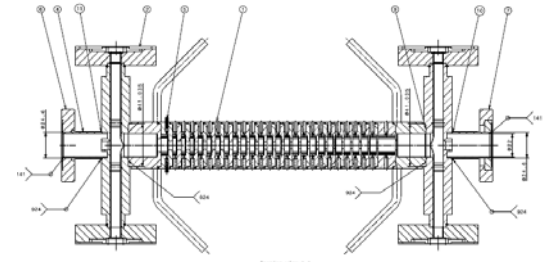
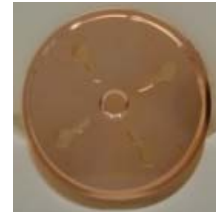

Thank you for your attention!

**International Workshop on
Breakdown Science and
High Gradient Technology***



Date: 18-20 April, 2012
**Venue: Kobayashi-hall (updated),
 Kenkyu Honkan Bldg. 1F,
 KEK, Tsukuba, Japan**

Meeting Chair
 Higo, Toshiyasu (KEK)

International Organizing Committee
 Higo, Toshiyasu (KEK)
 Tantawi, Sami (SLAC)
 Wuensch, Walter (CERN)

Local Organizing Committee
 Matsumoto, Shuji
 Abe, Tetsuo
 Higashi, Yasuo
 Oka, Michiyo
 Shirakata, Tomiko
 Sudo, Tomiko
 Takatomi, Toshikazu
 Ueno, Kenji
 Yamanaka, Masashi

Information and Registration:
 E-mail: highgrad@ml.post.kek.jp
<https://indico.cern.ch/conferenceDisplay.py?confId=185513>

The original picture of this background is "Thunder God" drawn by Utagawa Kuniya, collection of Tokyo National Museum (Image: TNA Image Archives). All rights reserved.

*This is an ICFA mini-workshop, supported by KEK and Particle Accelerator Society of Japan.





Supplementary Slides!

Beam Dynamics vs Analytical Model

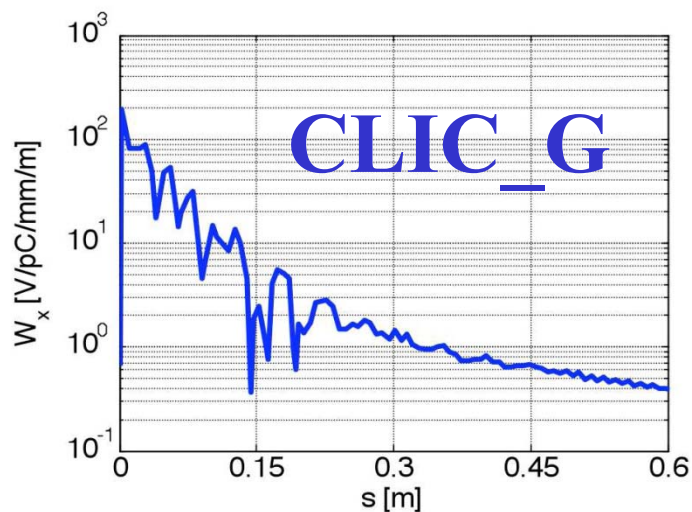
Tools: D.Schulte's formalism, PLACET
 (6.6kV/pC/m² first trailing bunch)

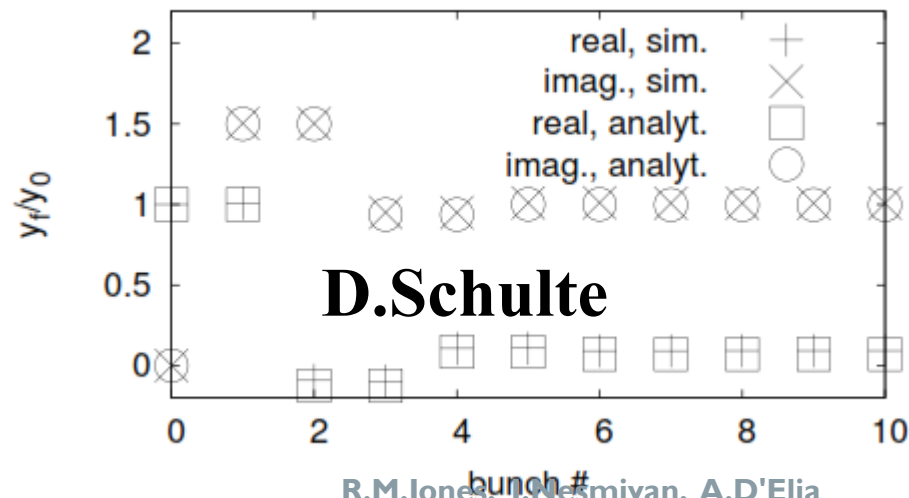
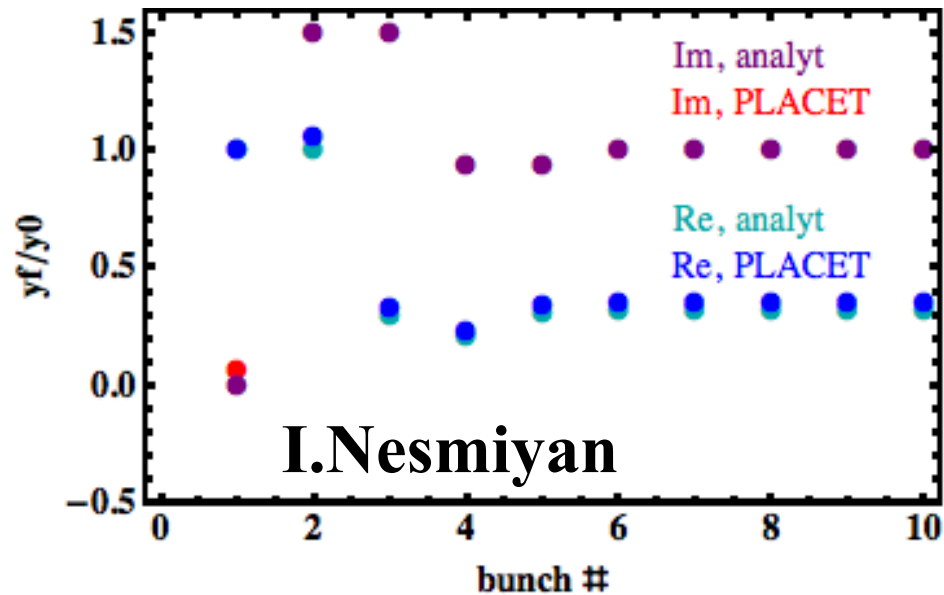

$F_c = 1.01$, $F_{rms} = 4.86$



R.M.Jones, I.Nesmiyan, A.D'Elia

CLIC_DDS_A Mechanical Eng. Design

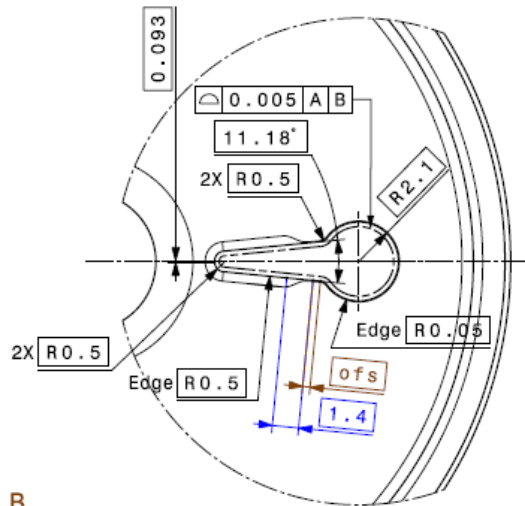
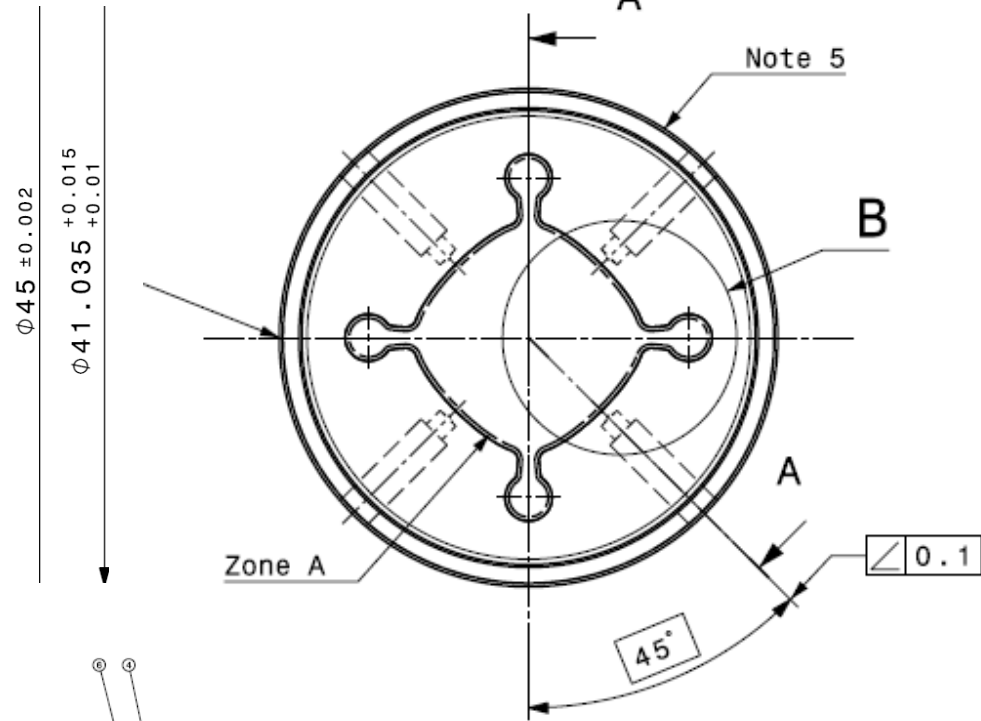
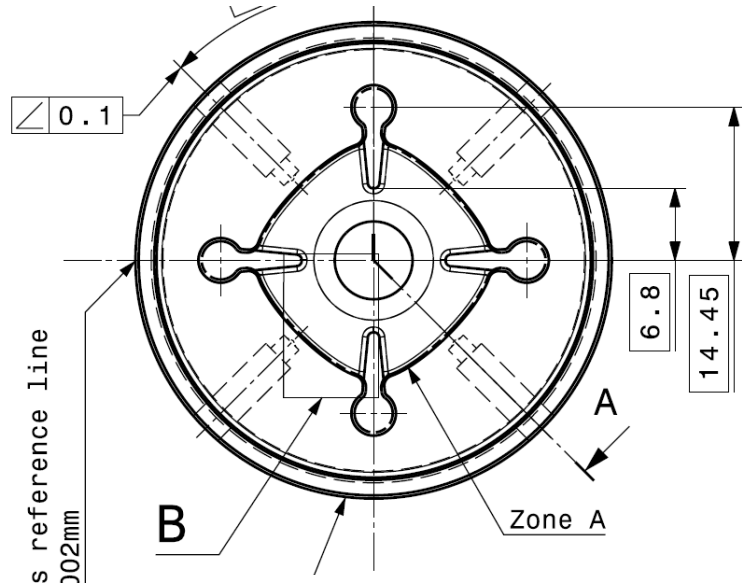

B
Auxiliary view B
Scale: 5:1

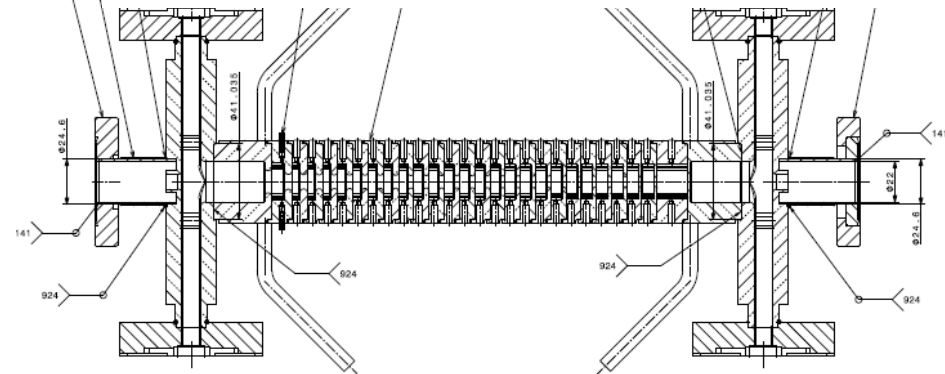

Section view A-A
Scale: 1:1

1. Physics of Manifold Mode Coupling to Dipole Modes

How Does Manifold Damping Work?

The fig. illustrates the dispersion curves from 3 cells of 55-cell accelerating DDS

* Strong coupling to the manifold occurs where dipole and manifold curves of the same color cross

* For mode 27 this occurs at ~15.03 GHz (green dashed line) at ~95.9 deg.

* Interpolation between the dipole curves shown at 0 and 180 suggests the mode is localized to cells: 20 to 34

* Also, from where the light line crosses 15.03 at ~162.6 deg.: the mode is excited at cell 20

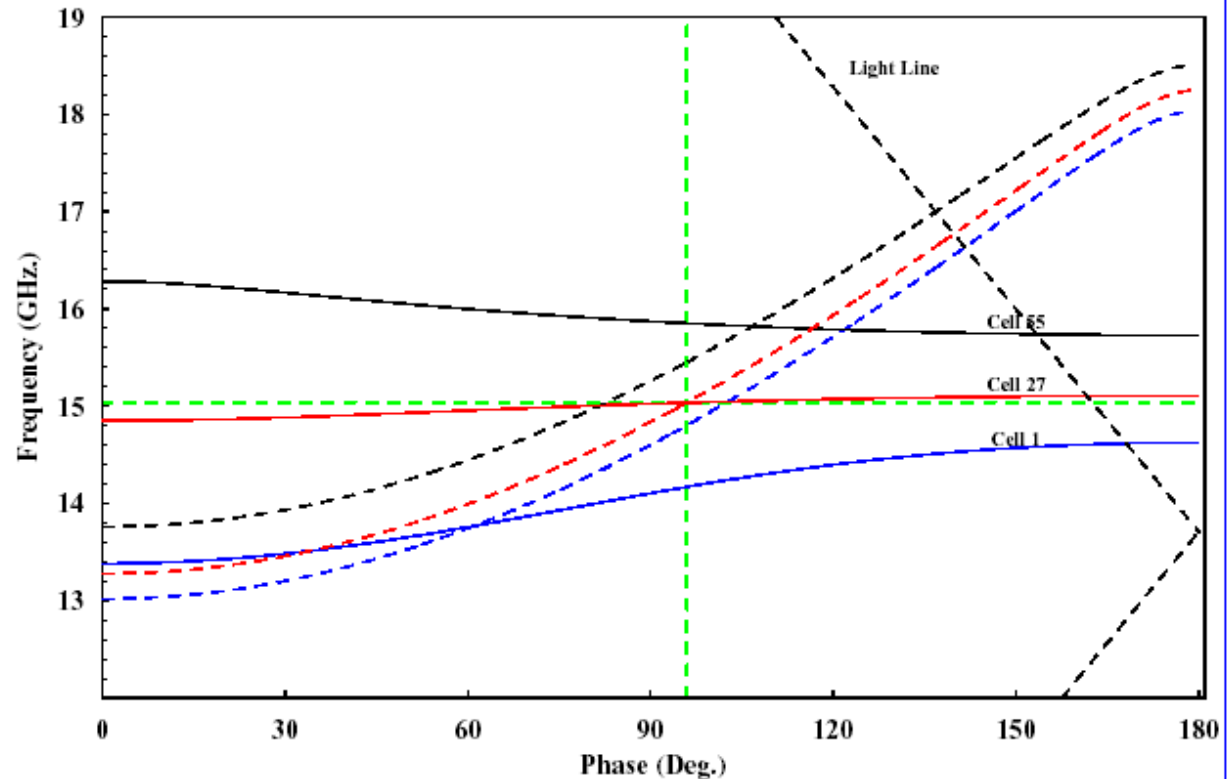
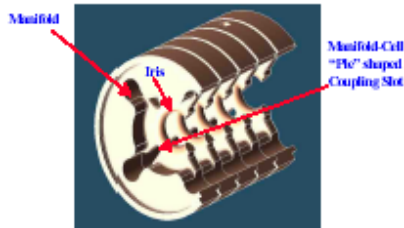

2.4 Cell Qualification of CLIC DDS_A

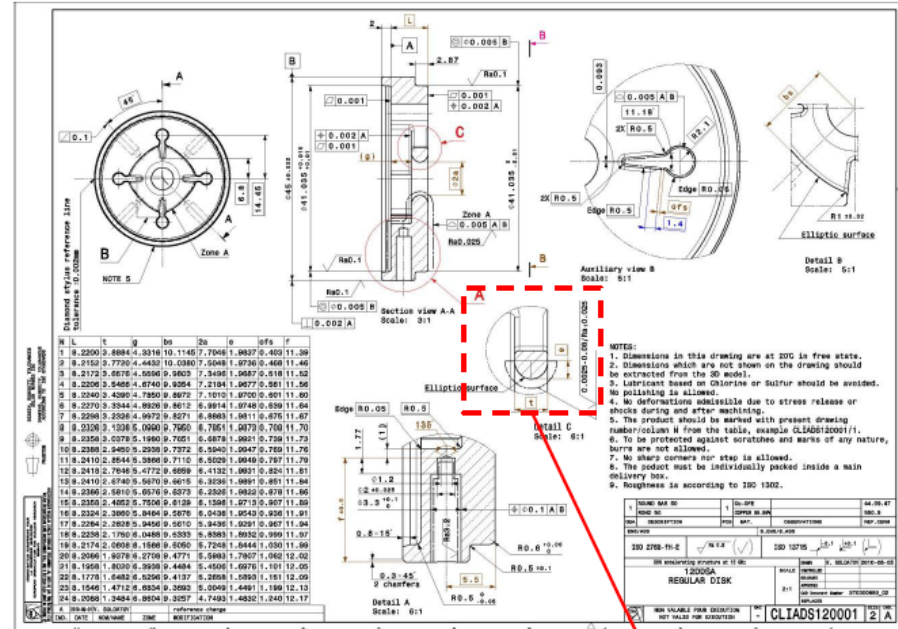
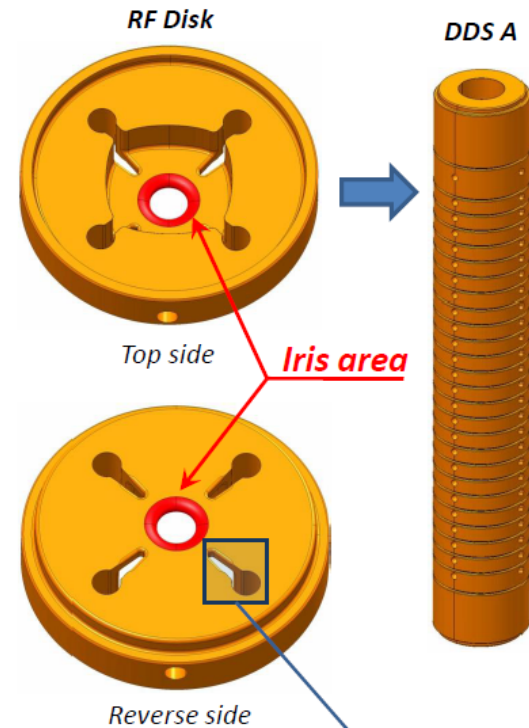

Geometrical tolerances of the critical zones

	0.005	A B
	0.002	A
	0.001	

Roughness is according to ISO 1302

Elliptic surface

Detail C
Scale: 6:1

C. 0.0025-0.08/Ra, 0.025

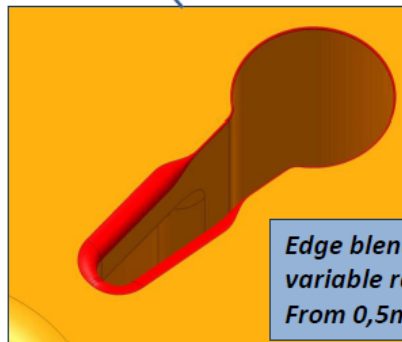

Prepared by Vadim Soldatov

