

INTRODUCTION TO ACCELERATORS

(Presented in 2 lectures)

***CAS Granada, October 2012
P.J. Bryant***

Contents

- ❖ **Comment on accelerators**
- ❖ **Pre-accelerator era**
- ❖ **The main history line**
- ❖ **A second history line**
- ❖ **And another history line, but fainter**
- ❖ **Classification by Maxwell**
- ❖ **Status in 1940**
- ❖ **After 1940 in a nutshell...**
- ❖ **Classification of accelerators**
- ❖ **Where to next?**
- ❖ **A closer look at cyclotrons**
- ❖ **Recognising synchrotron lattices**
- ❖ **The FFAG.**

Comment on accelerators

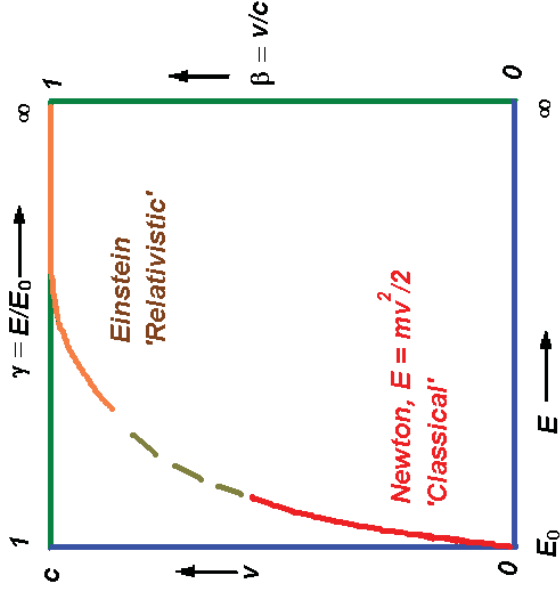

- ❖ Modern accelerators can accelerate particles to speeds very close to that of light.
- ❖ At low energies, the velocity of the particle increases with the square root of the kinetic energy (Newton).
- ❖ At relativistic energies, the velocity increases very slowly asymptotically approaching that of light (Einstein).
- ❖ It is as if the velocity of the particle 'saturates'.
- ❖ One can pour more and more energy into the particle, giving it a shorter De Broglie wavelength so that it probes deeper into the sub-atomic world.

What's in the name ?

- ❖ What does special relativity tell us, e.g. for an electron?

Energy	1 MeV	→	1 GeV
$\beta = v/c$	0.95	0.99	0.999 999 9
$\gamma = m/m_0$	3	7	2200

- ❖ Yes, the speed increases, but not as spectacularly as the mass. In fact, it would be more correct to speak of the momentum (mv) increasing.
- ❖ Ginzton, Hansen and Kennedy* suggested, **‘Ponderator’ or ‘Mass Agrandiser’**, but this did not become fashionable and we are left with **‘Accelerator’**.

* Rev. Sci. Instr., Vol.19, No.2, Feb. 1948.

Pre-accelerator era

- ❖ **<100 keV electrons from Wimshurst-type machines:**
 - 1895 Lenard electron scattering on gases (Nobel Prize 1905 for work on cathode rays).
 - 1913 Franck and Hertz excited electron shells by electron bombardment.
- ❖ **Few MeV from natural alpha particles:**
 - 1906 Rutherford bombards mica sheet with natural alphas.
 - 1919 Rutherford induces a nuclear reaction with natural alphas.

Build-your-own Wimshurst machine (1903)

100 years ago physics experimentation was very popular with the general public who often built their own equipment.

HOW TO MAKE A WIMSHURST MACHINE. 95

centre of the diameter of the semicircle. Two similar $\frac{1}{2}$ -in. holes are also to be put through the centres of the wider extremities of these standards, at 33 ins. up from the shoulders of the tenon. From

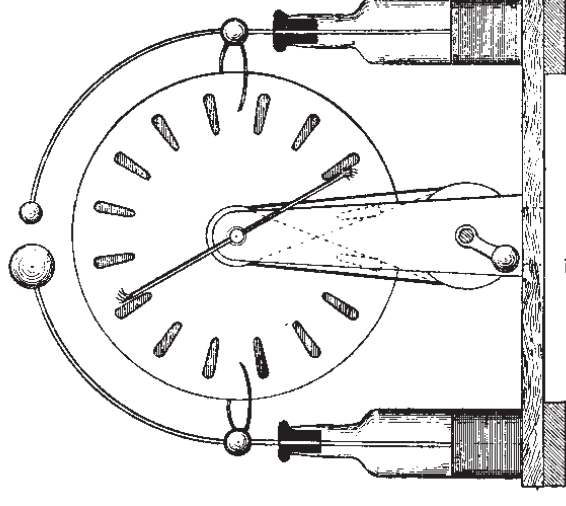
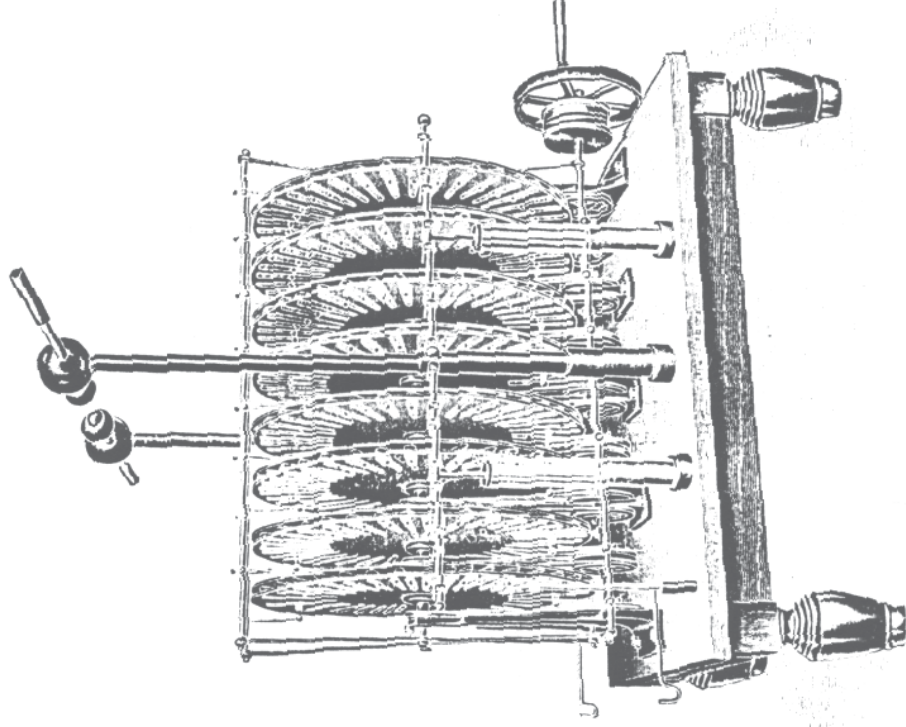

Fig. 1.

GUILBERT PYTMAN
Cecil Court, St. Martin's Lane, W.C.
1903

A commercial Wimshurst-type machine



The main history line

- ❖ ...Rutherford believes that he needs a source of many MeV to continue his research on the nucleus. This is far beyond the electrostatic machines then existing, but in ...
- ❖ 1928 Gamov predicts 'tunneling' and perhaps 500 keV would suffice ???
- ❖ ...and so the first accelerator was built for physics research:
- ❖ 1928 Cockcroft & Walton start designing an 800 keV generator encouraged by Rutherford.
- ❖ 1932 the generator reaches 700 keV and Cockcroft & Walton split the lithium atom with only 400 keV protons. They received the Nobel Prize in 1951.

Cockcroft-Walton generators became standard equipment

The Cockcroft-Walton generator supplying the ion source which injected protons into NIMROD, the 7 GeV synchrotron at Rutherford laboratory.

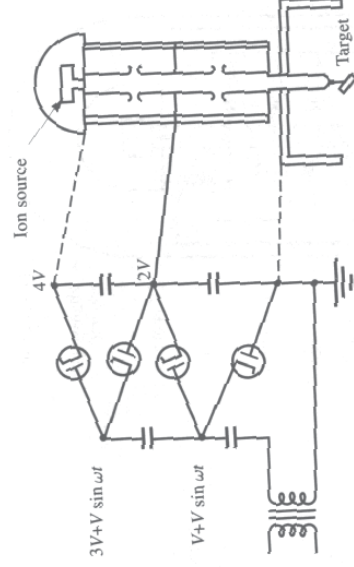
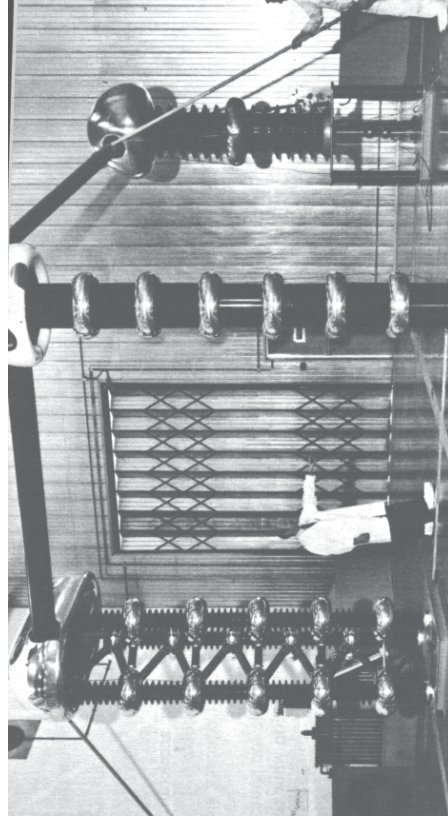

Van de Graaff, a competitor

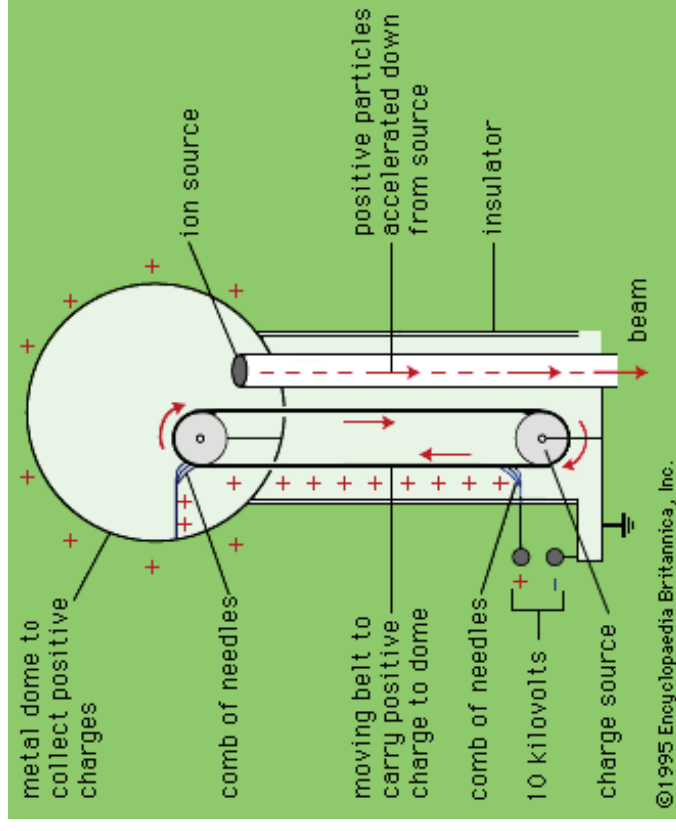

DC voltage generator:

Van de Graaff was an American Rhodes scholar in Oxford, UK in 1928 when he became aware of the need for a high-voltage generator. His first machine reached 1.5 MV in Princeton, USA, in the early 1930s.

These generators typically operate at 10 MV and provide stable low-momentum spread beams.

[Robert Van de Graaff 20/12/1901-1967]

The players

❖ Gustaf Ising:



❖ Rolf Wideröe:

Born 11/7/1902 in Oslo, Norway.

Died 1996.

Also contributed to the fields of power lines and cancer therapy.



❖ Ernest Orlando Lawrence:

Born 8/8/1901 in South Dakota, USA. Third generation Norwegian.

Died 27/8/1958.

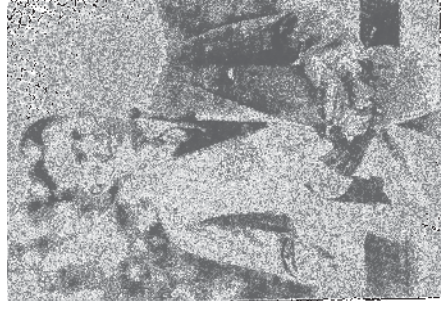

Livingston's demonstration cyclotron

-54-

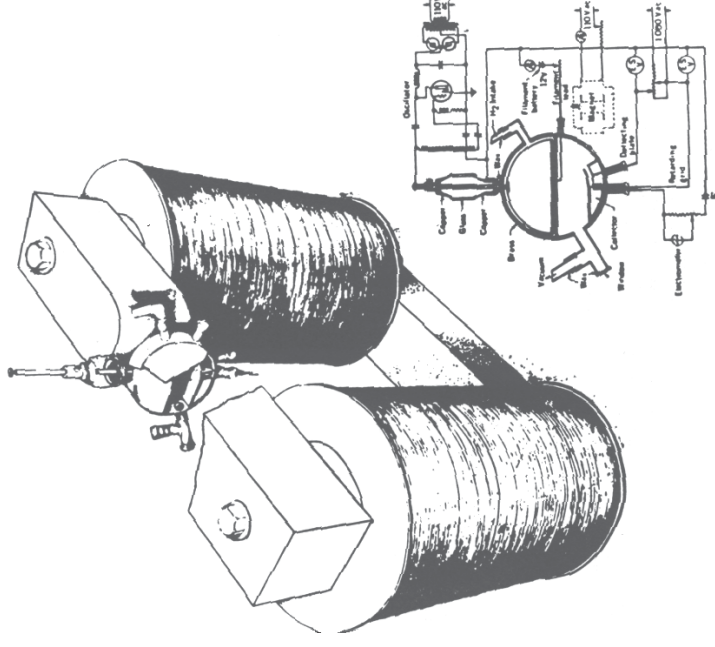

❖ A glass envelope made from a flattened flask and silvered on the inside with a single 'Dee'.

Cyclotron

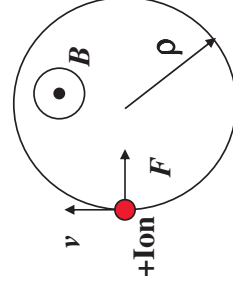
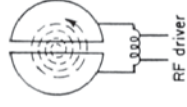
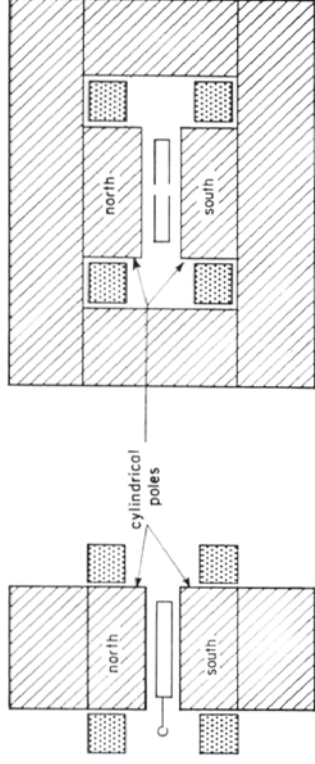

Centripetal force

$$F = evB = \frac{mv^2}{\rho}$$

Constant revolution frequency

$$f_{rev} = \frac{v}{2\pi\rho} = \frac{v}{2\pi m v} = \frac{eB}{2\pi m}$$

Radius of gyration

$$\rho = \frac{mv}{eB}$$

One of Lawrence's cyclotrons

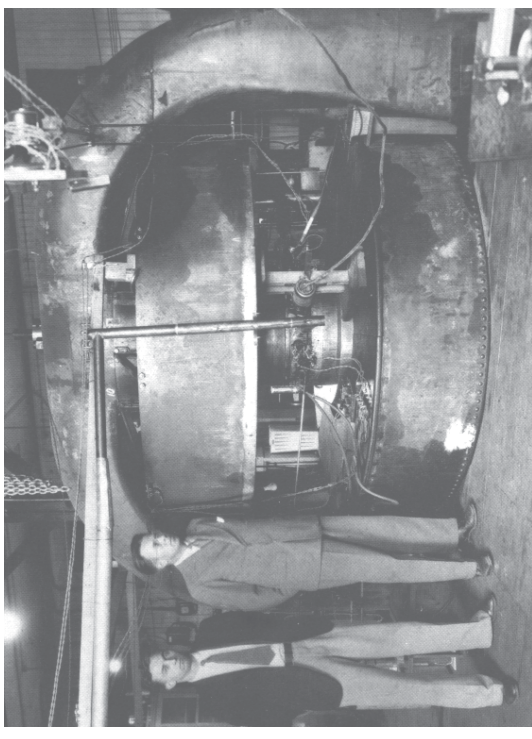

Stanley Livingston and Ernest O. Lawrence (left to right) beside the 27 inch cyclotron at Berkeley circa 1933. The peculiar shape of the magnet's yoke arises from its conversion from a Poulson arc generator of RF current, formerly used in radio communication.

The first 'true' accelerator

-50-

Prinzip einer Methode zur Herstellung von Kanalstrahlen hoher Voltzahl.

Von

GUSTAF ISING.

Mit 2 Figuren im Texte.

Mitgeteilt am 12. März 1924 durch C. W. OSSSEN und M. SIZILARD.

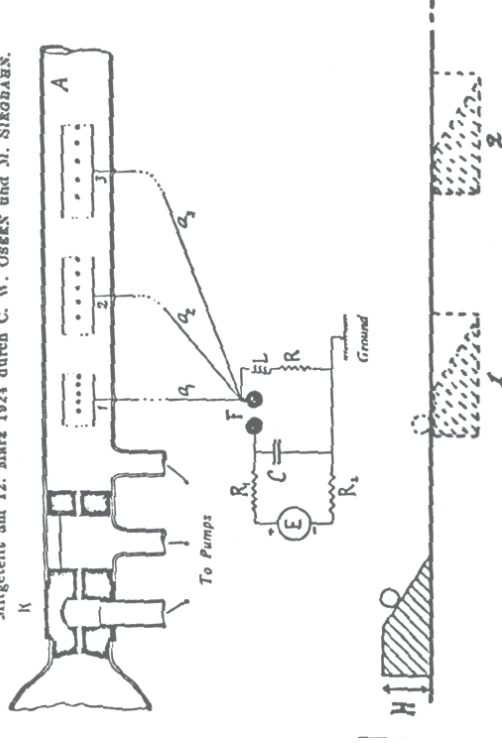

- ❖ This principle is used in almost all of today's accelerators. The ions can reach energies above the highest voltage in the system.

Leo Szilard was too late

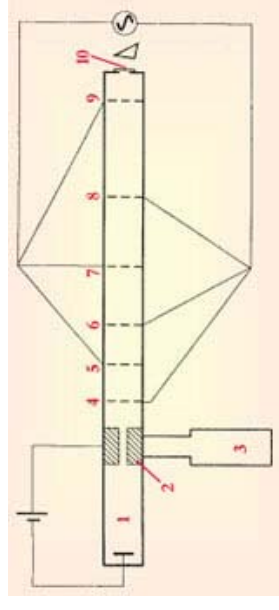

- ❖ The first accelerator proposed by L. Szilard was a linac, appearing in a German patent application entitled "Acceleration of Corpuscles" and filed on 17 December 1928. The Figure shows the proposed layout. Though Szilard writes of "canal rays" in the patent application, he also refers to "corpuscles, e.g. ions or electrons." Considering the low-frequency RF sources available in those days, an apparatus of modest length would have worked only for rather heavy ions.
- ❖ Leo Szilard was a professional inventor. He dropped the above patent perhaps because of 'prior art' by Ising.

Wideröe's Linac

❖ Wideröe's first linac

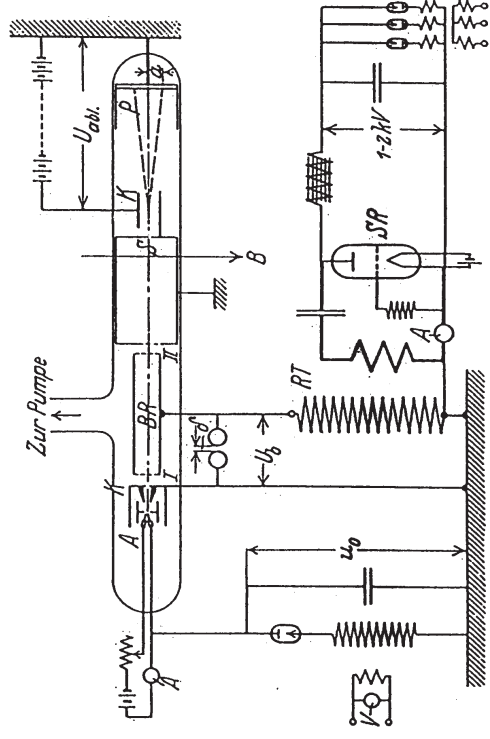

Alvarez Linac

- ❖ Alvarez linac – the first practical linac 32 MeV at Berkeley 1946:
 - ❖ Particle gains energy at each gap.
 - ❖ Drift tube lengths follow increasing velocity.
 - ❖ The periodicity becomes regular as $v \Rightarrow c$.
 - ❖ His choice of 200 MHz became a *de facto* standard for many decades.

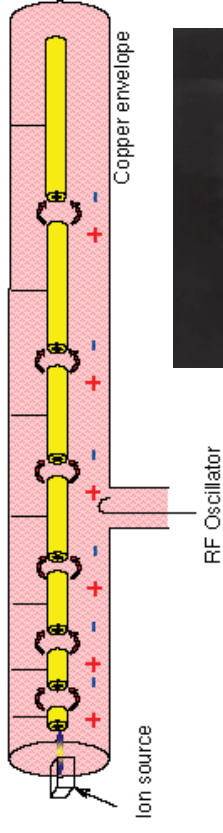

- ❖ Luis W. Alvarez was born in San Francisco, CA., on 13/6/1911. Died 1/9/1988. He received the Nobel physics prize in 1968.

And another history line, but fainter

- ❖ **Also the birth of a 'true' accelerator:**
 - ❖ 1923 Widerøe, a young Norwegian Ph.D. student draws in his laboratory notebook the design of the betatron with the well-known **2-to-1 rule**. Two years later he adds the condition for radial stability, but does not publish.
 - ❖ 1927 in Aachen, Widerøe makes a model betatron, but it does not work. Discouraged he changes course and builds the world's first linac (see previous history line).
- ❖ **All is quiet until 1940...**
 - ❖ 1940 Kerst re-invents the betatron and builds the first working machine for 2.2 MeV electrons (University of Illinois).
 - ❖ 1950 Kerst also builds the world's largest betatron (300 MeV).

Widerøe's betatron

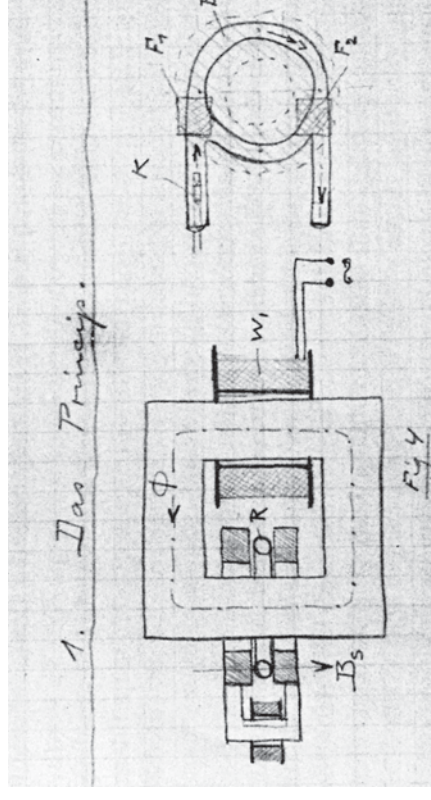

Continuous acceleration – betatron:

Widerøe called this device a “strahlung transformer” because the beam effectively forms the secondary winding on a transformer. The above diagram is taken from his unpublished notebook (1923). This device is insensitive to relativistic effects and is therefore ideal for accelerating electrons. It is also robust and simple. The idea re-surfaced in 1940 with Kerst and Serber, who wrote a paper describing the beam oscillations. Subsequently the term ‘betatron oscillation’ was adopted for these oscillations in all devices.

Betatron

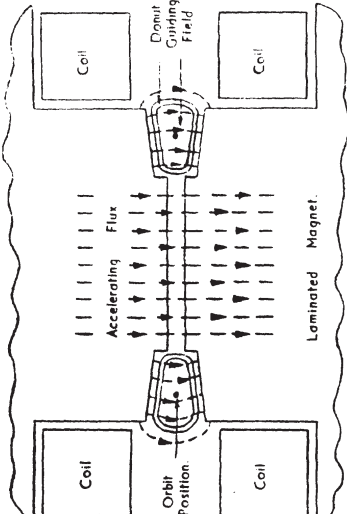

Classification by Maxwell

❖ Accelerators must use electric fields to transfer energy to/from an ion, because the force exerted by a magnetic field is always perpendicular to the motion.

❖ Mathematically speaking, the force exerted on an ion is:

$$F = eE + e(\mathbf{v} \times \mathbf{B})$$

so that the rate at which work can be done on the ion is:

$$F \cdot \mathbf{v} = eE \cdot \mathbf{v} + e(\mathbf{v} \times \mathbf{B}) \cdot \mathbf{v}$$

but $(\mathbf{v} \times \mathbf{B}) \cdot \mathbf{v} = 0$.

❖ Each 'history line' can be classified according to how the electric field is generated and used.

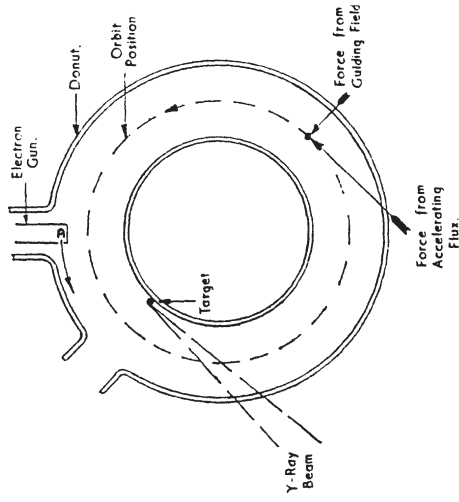

Use of the electric field

$$E = -\nabla\phi - \partial A/\partial t$$

Acceleration by DC voltages:

- Cockcroft & Walton rectifier generator
- Van de Graaff electrostatic generator
- Tandem electrostatic accelerator

Acceleration by time-varying fields:

$$\nabla \times E = -\partial B/\partial t$$

'Betatron' or 'unbunched' acceleration

The diagram shows a cylindrical particle path with a central axis. An ion is shown at the top of the cylinder. Two vertical arrows labeled 'B' represent the magnetic field. A horizontal arrow labeled 'E' represents the electric field. The ion's path is shown as a dashed cylinder.

'Resonant' or 'bunched' acceleration

- Linear accelerator (linac).
- Synchrotron.
- Cyclotron ('coiled' linac).

The diagram shows a cylindrical particle path with a central axis. An ion is shown at the top of the cylinder. Two vertical arrows labeled 'B' represent the magnetic field. A horizontal arrow labeled 'E' represents the electric field. The ion's path is shown as a dashed cylinder.

Status in 1940

- ❖ Three acceleration methods had been exploited:
 - ❖ DC voltage (e.g. Cockcroft and Walton),
 - ❖ 'Resonant/bunched' acceleration (e.g. cyclotron)
 - ❖ 'Betatron/unbunched' acceleration.

❖ Try to think of other possibilities for accelerating ions. *

❖ Progress now turns to applying these basic concepts more efficiently and to improving the technology.

* This is an important question for the future.

After 1940 in a nutshell...

- ❖ 1943 Once again, Wideröe is a pioneer and patents colliding beams (pub. 1953).
- ❖ 1944 McMillan and Veksler independently propose synchronous acceleration with phase stability. They use an electron synchrotron, as example.
- ❖ 1946 Goward and Barnes are first to make the synchrotron work in the UK.
- ❖ 1947 Oliphant and Hyde start a 1 GeV machine in Birmingham, UK, but an American group overtakes them and is first with the 3 GeV Cosmotron at BNL.
- ❖ 1952 Christofilos, and Courant, Livingston and Snyder independently invent strong focusing. CERN immediately drops its design for a weak-focusing, 10 GeV FFAG in favour of a strong-focusing, 28 GeV synchrotron.
- ❖ 1956 MURA, US proposes particle stacking to increase beam intensity, opening the way for circular colliders.

Trick Question: Why did McMillan receive the Nobel Prize and not Veksler?

Components of a synchrotron

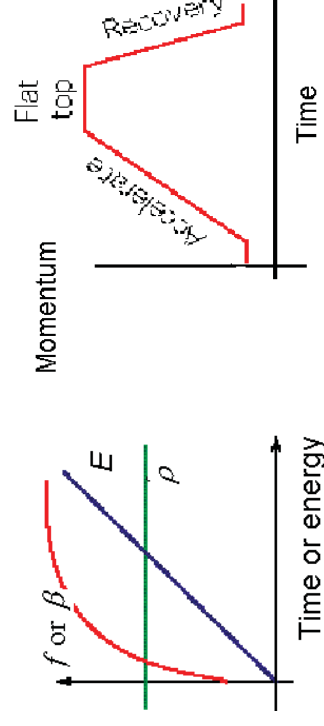
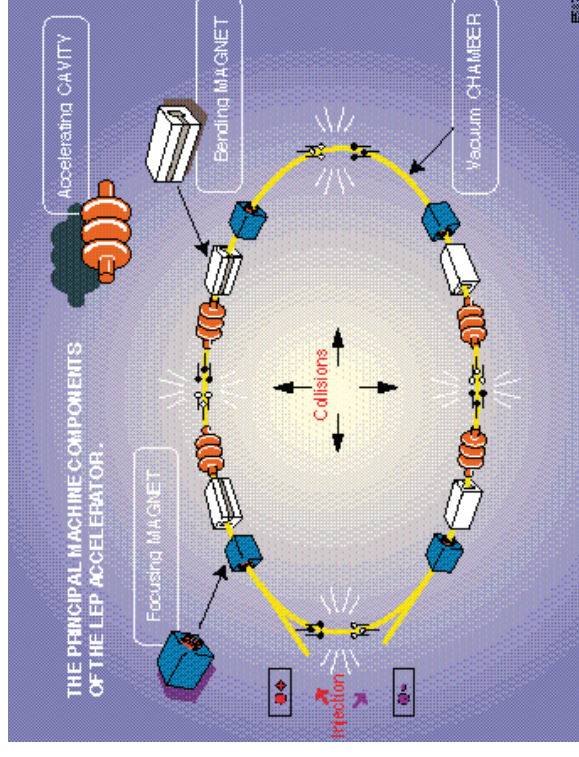

More progress...

- ❖ 1956 Tigner proposes linear colliders for high-energy electron machines.
- ❖ 1961 AdA, an electron-positron storage ring is built in Frascati, Italy. This is the first single-ring, particle-antiparticle collider (first operated in Orsay, France).
- ❖ 1966 Budker and Skrinsky propose electron cooling.
- ❖ 1970 Kapchinski & Teplyakov propose the RFQ (radiofrequency quadrupole).
- ❖ 1971 CERN operates the ISR proton-proton collider. This is the first, particle-particle, intersecting-ring collider.
- ❖ 1971 Blewett proposes the twin-bore superconducting magnet design. Now used in LHC.
- ❖ 1972 van der Meer invents stochastic beam cooling opening the way for hadron, particle-antiparticle colliders.
- ❖ 1978 The CERN ISR operates the first superconducting magnets (quads) to be used in a synchrotron ring. They are industrially built.

And more...

- ❖ 1982 CERN converts its SPS to a single-ring proton-antiproton collider.
- ❖ 1984 C. Rubbia and S. van der Meer receive the Nobel physics prize for *W & Z* discoveries.
- ❖ 1989 CERN starts LEP, the world's highest energy electron-positron collider.
- ❖ 1991 HERA at DESY becomes the first major facility for colliding protons with electrons or positrons.
- ❖ 1995 CERN runs superconducting rf cavities in LEP for physics.
- ❖ 1999 RHIC at BNL becomes the world facility for colliding ions.
- ❖ 10th September 2008 CERN starts the LHC, the world's highest energy proton-proton collider (superconducting, twin-bore dipoles).
- ❖ 20?? CERN has plans for a TeV linear collider, CLIC.

In the beginning there was HEP, but

more money now passes through non-HEP applications...

❖ Accelerator applications:

- ❖ Synchrotron light sources.
- ❖ Spallation sources.
- ❖ Isotope production.
- ❖ Radiography.
- ❖ Cancer therapy.
- ❖ Ion implantation and surface metallurgy.
- ❖ Sterilisation.
- ❖ ...

❖ Proposed accelerator applications:

- ❖ Inertial fusion drivers.
- ❖ Nuclear incinerators.
- ❖ Rocket motors.
- ❖ ...

❖ Spin-offs from HEP and accelerators:

- ❖ PET scanners.
- ❖ NMR scanners.
- ❖ CAT scanners.
- ❖ Superconducting wires, cables and devices.
- ❖ Large-scale UHV systems.
- ❖ Large-scale cryogenic systems.
- ❖

Where to next?

❖ Today's HEP accelerators are nearing practical limits. What can be done?

- ❖ 1982 ECFA held the first workshop of a series on advanced accelerating techniques 'Challenge of Ultra-high Energies' New College, Oxford, UK.
- ❖ The goal was a new acceleration technique capable of reaching PeV energies and higher with equipment of a practical size.

❖ Four essential ingredients are:

- ❖ A new acceleration mechanism.
- ❖ Transverse stability.
- ❖ Longitudinal (phase) stability.
- ❖ Stability against collective effects.

❖ The candidates were:

- ❖ Plasma-beat-wave accelerator.
- ❖ Wake-field accelerator.
- ❖ Lasers with gratings.
- ❖ Lasers on dense bunches.

❖ But the search is still on for a new HEP accelerator.

How far is beyond?

- ❖ The CERN LHC will operate 2×7 TeV (1 TeV $\equiv 10^{12}$ eV) beams in head-on collision.
- ❖ Only cosmic rays provide a glimpse of what lies beyond.
- ❖ The cosmic ray spectrum is expected to extend up to the **Planck energy** (1.22×10^{28} eV **about 10^{15} times higher than the LHC**), above which the universe is thought to be opaque.
- ❖ The Planck energy is the order of magnitude expected for the energy of a vibrating string in string theory.
- ❖ The Planck energy is roughly 2 billion joules, the energy supplied when tanking up a car.

A closer look at cyclotrons

- ❖ Cyclotrons started in HEP, but today they are important for their industrial and medical applications.
- ❖ The cyclotron's success is due to its robust and compact design with adequate intensity and quasi-continuous beam.

Cyclotron road map

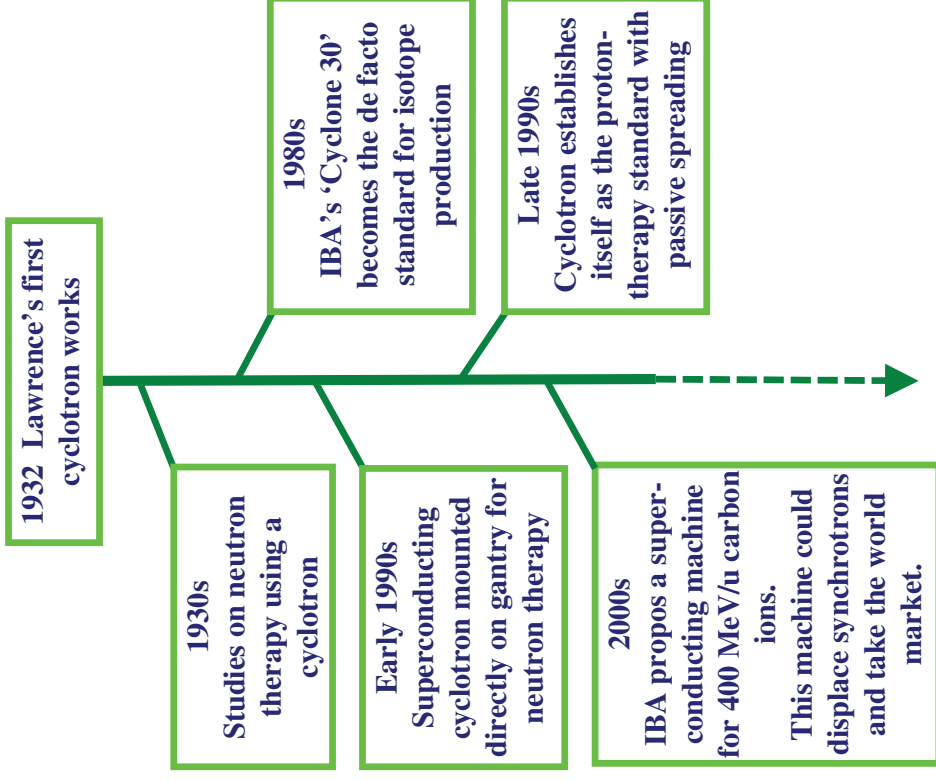

Evolution of cyclotrons

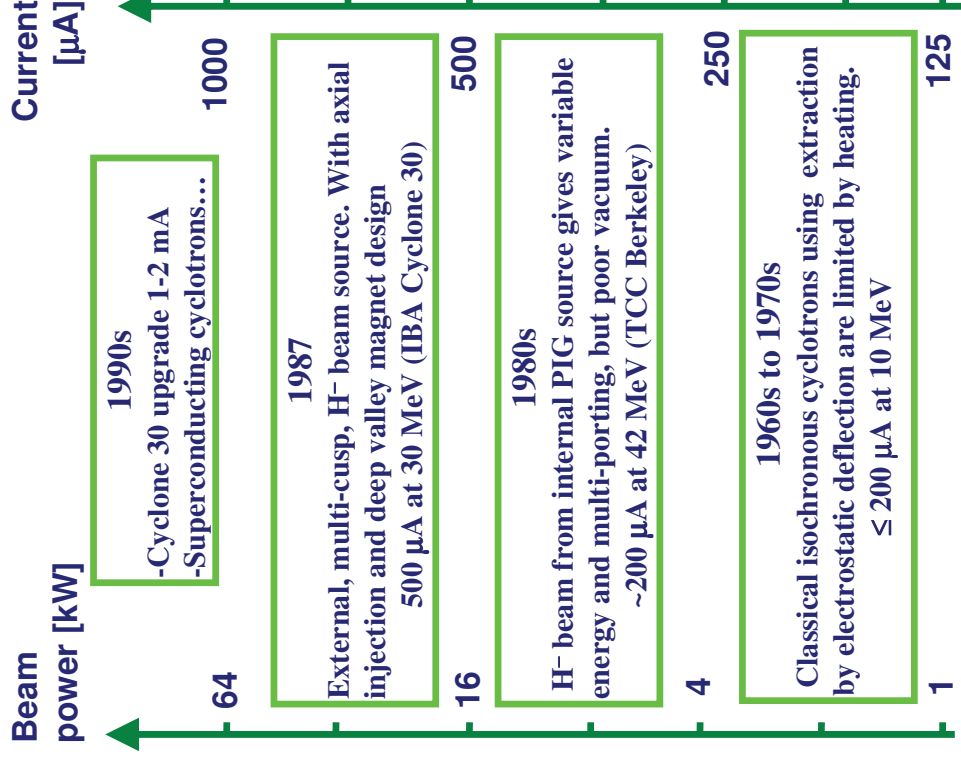

Cyclones 30 and 235 (courtesy IBA)



Gantry-mounted sc cyclotron

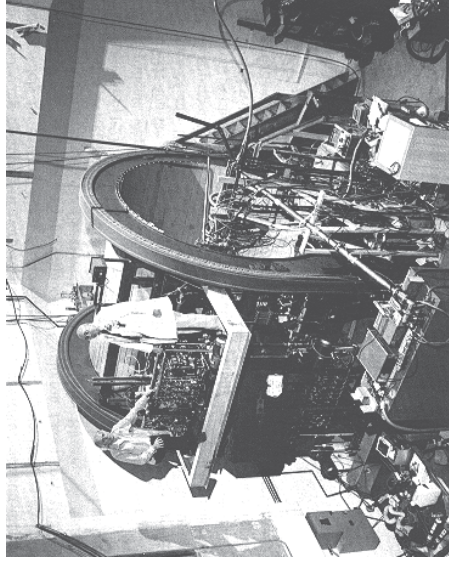

- ❖ Gantry-mounted, superconducting, deuteron cyclotron for neutron therapy
- ❖ Harper Hospital, Detroit
- ❖ H. Blosser et al, Hadrontherapy in Onc, 1994

Recognising synchrotron lattices

- ❖ Can we recognise the types of lattice and guess the application of a synchrotron from its lattice design?
- ❖ Lets look at typical examples:
 - ❖ Early accelerators for physics
 - ❖ More recent accelerators for physics
 - ❖ Spallation sources
 - ❖ Synchrotron light sources
 - ❖ Cancer therapy machines

An early synchrotron

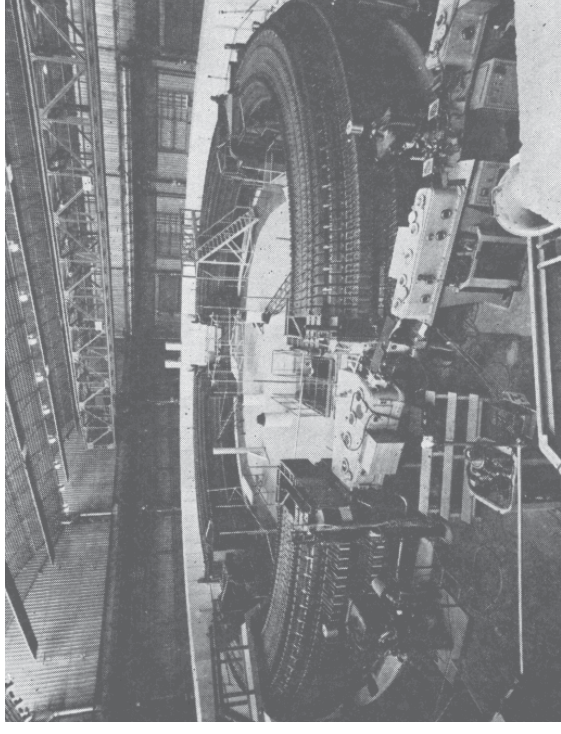

- ❖ 3 GeV proton synchrotron “Saturne” at Saclay. A Van de Graaff injector lies out of view front-right.
- ❖ The magnet structure is quasi-continuous because the designers were not skilled in the design of long drift spaces.
- ❖ These machines are invariably plain accelerators for physics research with the experiments external to the machine.

A more advanced AG accelerator

- ❖ Uses a basic FODO cell with the F and D quads split into 2 units. Between the 'split' quadrupoles, the betatron amplitude functions are quasi constant.
- ❖ The dipoles are placed between the F quads to have minimum vertical beam size (i.e. min. cost).
- ❖ However, the drift spaces are still short.

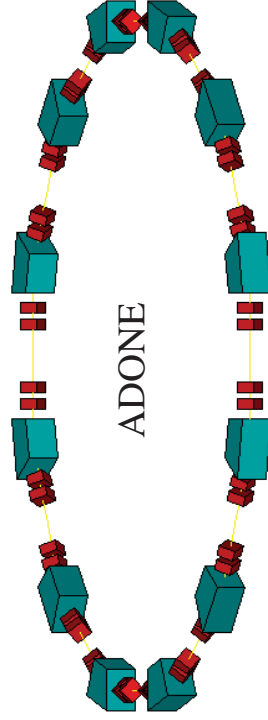
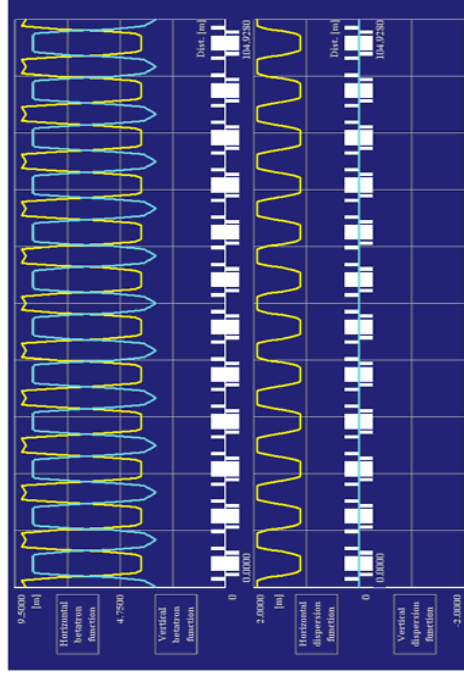

Controlling dispersion

- ❖ The rings shown so far simply repeat a standard cell n times to reach 2π of bending.
- ❖ This works for plain accelerators and often leads to an economical solution in which all quadrupoles for example are powered by a single power converter.
- ❖ In more advanced lattices, we would like to have regions with zero dispersion e.g. in RF cavities. This is done in small rings by closing the dispersion in bumps.
- ❖ To close a dispersion bump one needs 180° to 360° of phase advance in the plane of bending.
- ❖ This leads to solutions for rings with two, or three or four or more closed dispersion bumps separated by dispersion-free sections.
- ❖ Each closed bump forms a 'corner' and the ring looks 'triangular' or 'square' or 'pentagonal' and so on.

A 'triangular' ring using a triplet

- ❖ A triplet is another possible cell for a ring.
- ❖ In this case, the large horizontal phase advance at the centre of the triplet is used to make 3 closed dispersion bumps.
- ❖ The 'waist' in the vertical betatron amplitude in long straight sections is used for the dipoles. This keeps the aperture requirements and cost down.

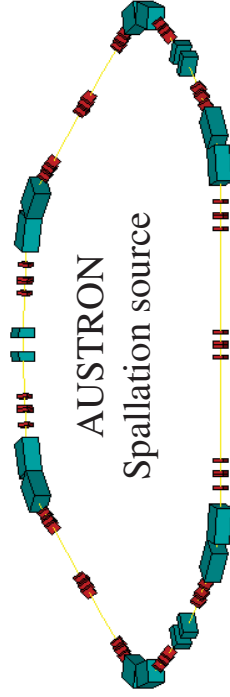
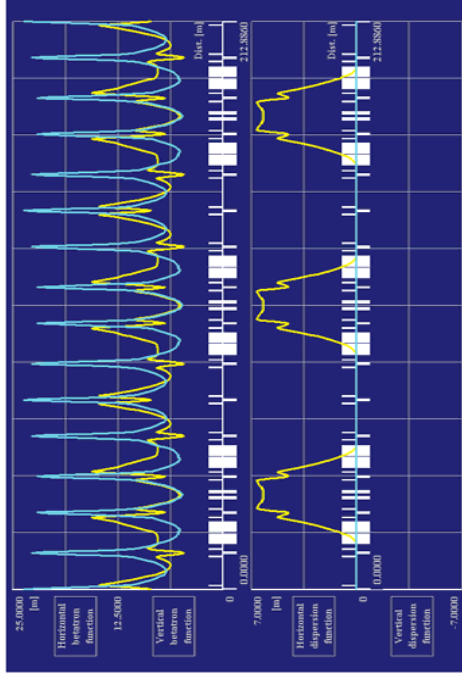

H minus stripping - a special feature of spallation sources

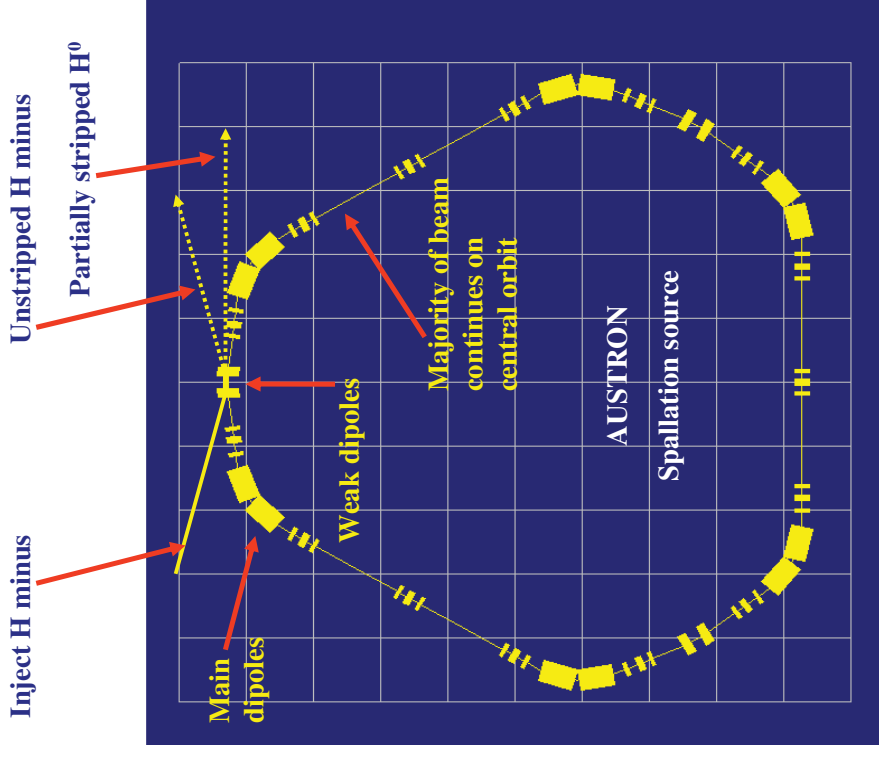

Light source lattice

- ❖ Chasman-Greene, double-bend achromat, high-brightness lattice. The aim is to minimise $D_x(s)$ and $\beta_x(s)$ in the dipoles.
- ❖ Each cell supports a closed dispersion bump. There are 4 bumps making a 'square' ring.

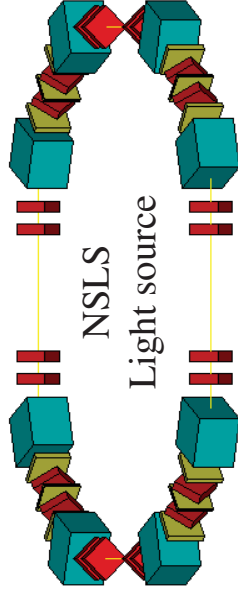
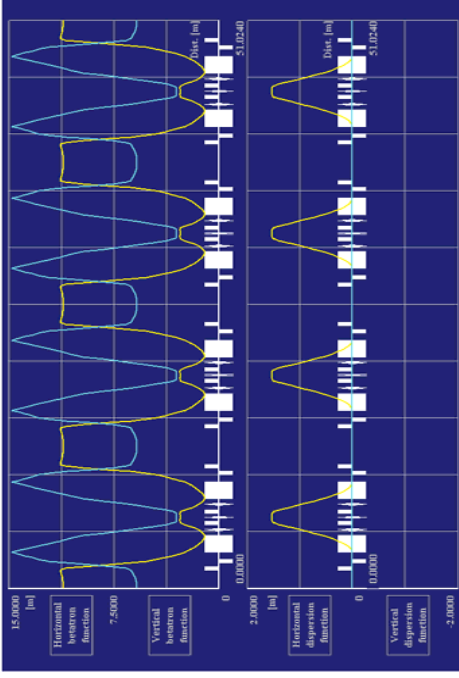

A medical synchrotron

- ❖ The PIMMS medical synchrotron is an example of a lattice customised for a particular use.
- ❖ Injection and extraction use electrostatic septa for quasi-continuous operation.
- ❖ The long straight sections have zero dispersion for rf cavities and minimum beam size at injection/extraction.
- ❖ Phase advances are designed for the slow extraction.

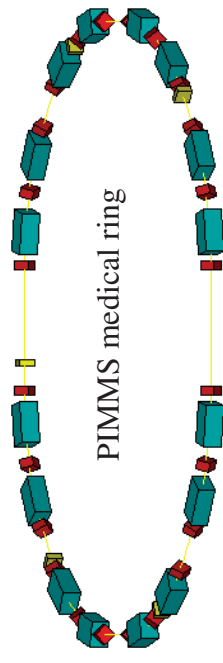
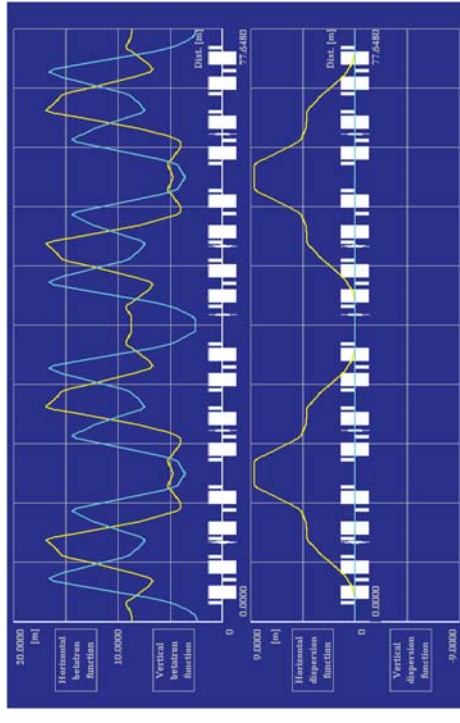

Large rings

- ❖ Large rings, such as the LHC, often have a basic FODO cell in the arcs.
- ❖ The overall ring has an n -fold symmetry containing the n -arcs and n straight regions in which the physics experiments are mounted.
- ❖ Between the arcs and the straight regions there is the so-called *dispersion suppressor* that brings the dispersion function to zero in the straight region in a controlled way. There are several schemes for dispersion suppressors (see one example on next slide).
- ❖ The straight regions contain the injection and extraction and the RF cavities, which, in an electron machine like LEP, can occupy hundreds of metres.
- ❖ A dispersion-free straight region may also contain a low- β insertion for physics.

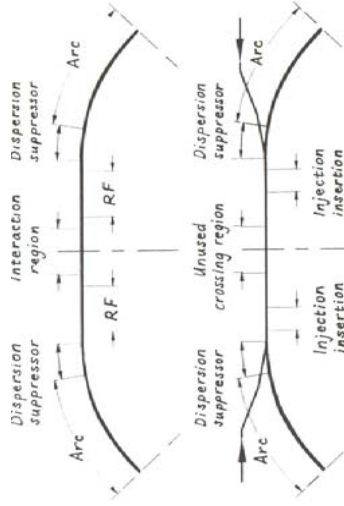

Missing-magnet suppressor

- ❖ Lattice functions of missing-magnet suppressor for a 60° FODO cell. Note how β_x and β_z hardly 'notice' the suppression of D_x .

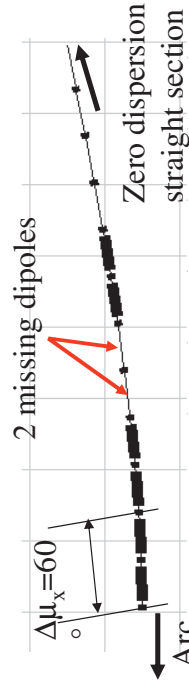
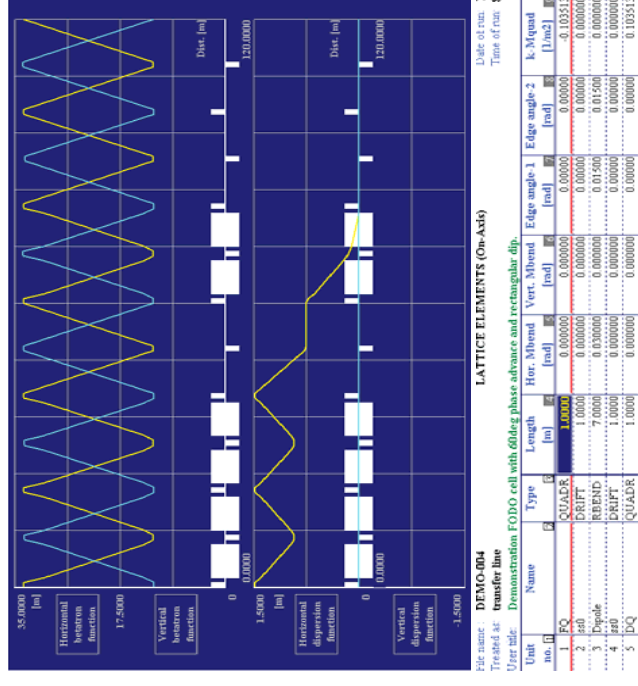

The FFAG

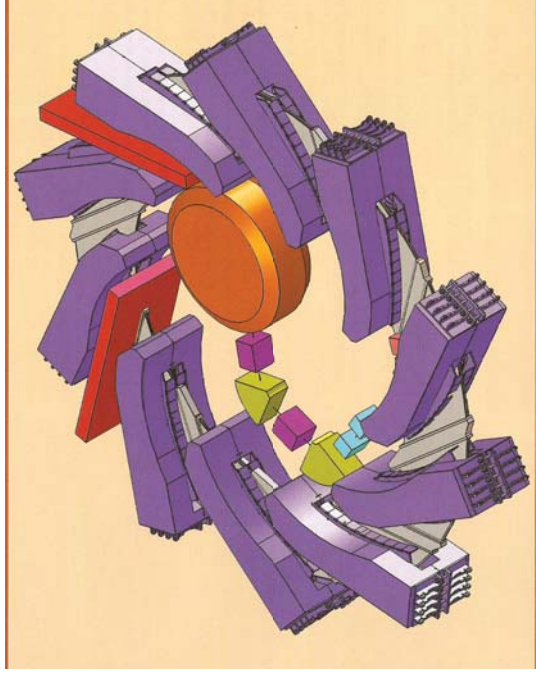

- ❖ **FFAG = Fixed Field Alternating Gradient**
- ❖ **FFAGs are experiencing a rebirth, since their conception in the 1950s.**
- ❖ **One could describe them as a solution looking for an application.**
- ❖ **FFAGs have a large “momentum acceptance” when considered as a single aperture fixed-field magnet, but a small “momentum range” when considered as an accelerator. Fast cycling synchrotrons can approach a range of 1:10, while slow ramping synchrotrons can approach a ratio of 1:20, whereas FFAGs may approach a range of 1:5.**