

# Invenio Status: Versions and Features

Tibor Šimko

`<tibor.simko@cern.ch>`

Department of Information Technology  
CERN

Invenio User Group Workshop 2012  
CERN, May 7–9 2012

1 Releases

2 Modules

3 Summary

1 Releases

2 Modules

3 Summary

## major.minor.patchlevel

### ■ major

- important rewrites and new functionality
- APIs undergo major changes

### ■ minor

- new features
- APIs evolve but *usually* stay backward compatible

### ■ patchlevel

- bug fixes only
- no change to APIs or DB structure

# Releases and Branches

$C_1$

**master**

# Releases and Branches

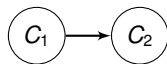

**master**

# Releases and Branches

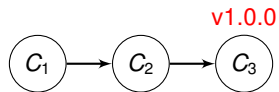

**master**

# Releases and Branches

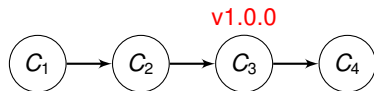

**master**



# Releases and Branches

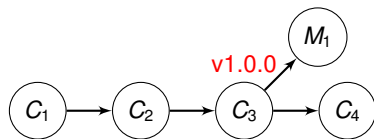

**maint-1.0**

**master**

# Releases and Branches

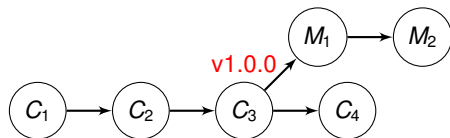

**maint-1.0**

**master**

# Releases and Branches

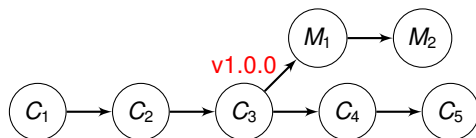

**maint-1.0**

**master**

# Releases and Branches

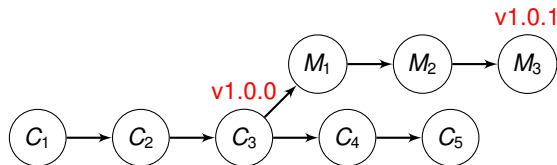

**maint-1.0**

**master**

# Releases and Branches

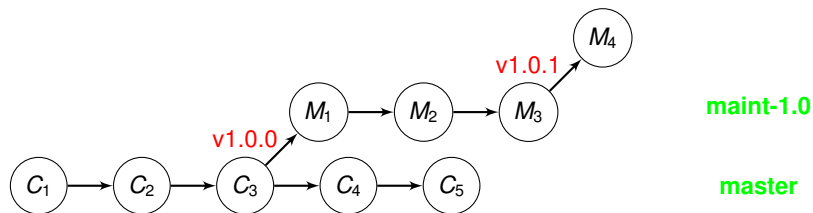

# Releases and Branches

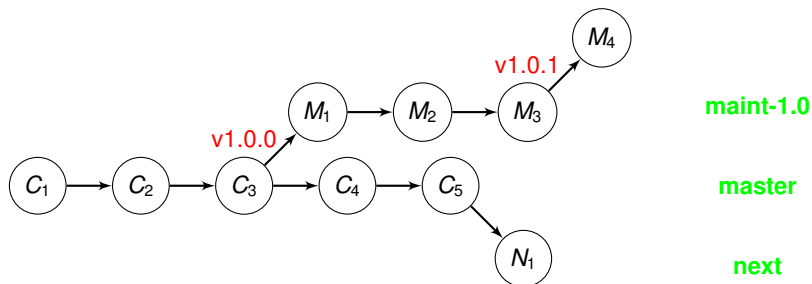

# Releases and Branches

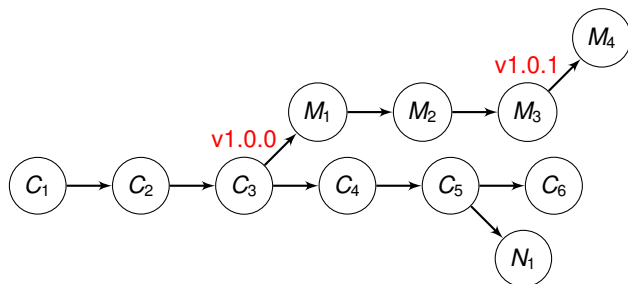

**maint-1.0**

**master**

**next**

# Releases and Branches

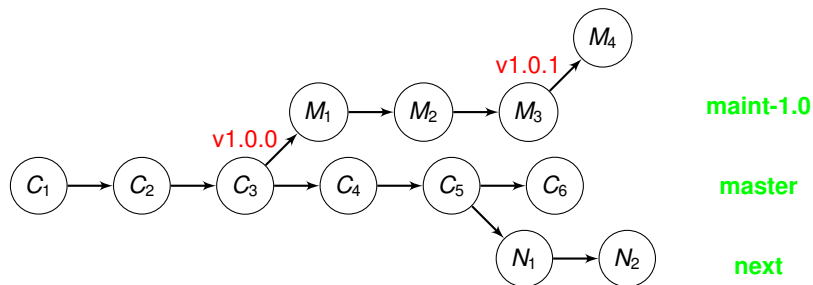



# Releases and Branches

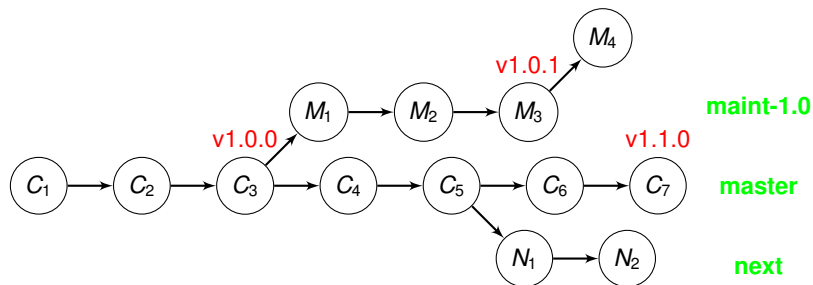

# Releases and Branches

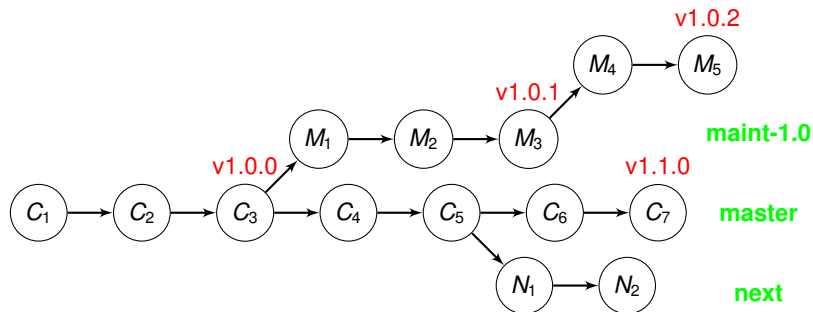

# Releases and Branches

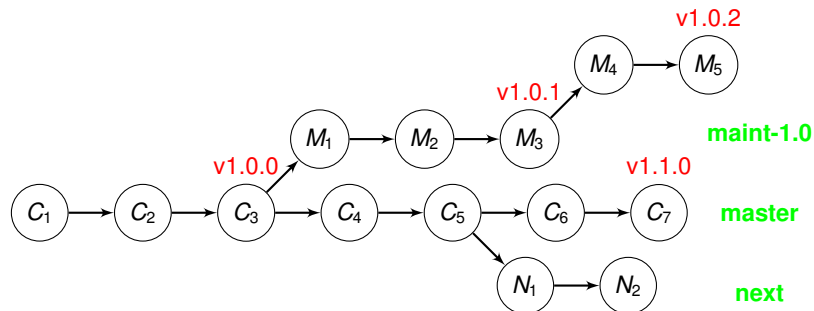

- **maint-X.Y** — release maintenance branches
- **master** — new feature branch
- **next** — things not yet release-ready

# Invenio v0.99 series

<b>release</b>	<b>date</b>	<b>commits</b>	<b>files</b>	<b>LOCs changed</b>
v0.99.0	2008-03-27	1940	1087	218997+ 137053-
v0.99.1	2008-07-10	813	278	94047+ 57109-
v0.99.2	2010-10-20	29	58	30389+ 28978-
v0.99.3	2010-12-13	9	33	191+ 85-
v0.99.4	2011-12-19	4	31	170+ 120-
v0.99.5	2012-02-21	3	29	486+ 298-
<i>maint-0.99 tip</i>	<i>2012-04-06</i>	<i>0</i>	<i>0</i>	<i>0+ 0-</i>

- stability: security fixes and bug fixes are provided long-term
- safety: upgrade within v0.99 release series if you haven't

<b>release</b>	<b>date</b>	<b>commits</b>	<b>files</b>	<b>LOCs changed</b>
v1.0.0-rc0	2010-12-21	1631	1396	430044+ 306259-
v1.0.0	2012-02-29	126	127	87728+ 79904-
<i>maint-1.0 tip</i>	<i>2012-04-06</i>	<i>24</i>	<i>19</i>	<i>297+ 78-</i>

- list of new features: see [RELEASE-NOTES](#)
- v1.0.0 is recommended for production
- v1.0.1 release approaching

# What's Next? Invenio Master

<b>release</b>	<b>date</b>	<b>commits</b>	<b>files</b>	<b>LOCs changed</b>
<i>master tip</i>	<i>2012-04-06</i>	<i>977</i>	<i>1248</i>	<i>271250+ 140023-</i>

## ■ list of new features:

- new video treatment module (BibEncode)
- new author disambiguation and claiming module (BibAuthorID)
- new fast sorting module (BibSort)
- many new features! (*see throughout workshop*)

## ■ ... will become Invenio v1.1 release series

# What's After Next? Invenio Next

release	date	commits	files	LOCs changed
<i>next tip</i>	<i>2012-04-06</i>	<i>73</i>	<i>297</i>	<i>98808+ 82008-</i>

- mostly used so far for:
  - improvements to circulation and holdings
  - refactoring of search API for MontySolr
  - refactoring of record editor and jQuery
- coming soon, notably-visible changes:
  - improvements to searching in restricted collections
  - new “Add To Search” UI (*here or in later series*)
  - new faceted search UI (*here or in later series*)
- important especially if you use circulation
- ... will become Invenio v1.2 release series

# What's After After Next? Flask/SQLAlchemy

- technology stack consolidation under way in 2012
  - **Flask** web development framework
  - **Jinja** templates with strict separation of presentation layer
  - **SQLAlchemy** for DB independence and ORM
- status
  - WebSession, WebStyle, WebMessage example modules ported
  - WebSearch and WebSubmit to follow
- see Wednesday's session for more
- . . . will become Invenio v2.0 release series



# Time-Based Release Model

- DSCM permits to juggle with many branches at the time
  - periodical upward merge `maintA` -> `maintB` -> `master` -> `next`
- release schedule models
  - (a) feature-based: “release when it’s ready”
  - (b) time-based: “release when July comes”
- targeting 3 or 4 minor release series per year
  - merge window in May
  - stabilise in June
  - release in July
- pros
  - quicker *maint-X.Y* turnaround
  - possibility to “live off” and “jump between” *maint-X.Y*
- cons
  - *master* temporarily unstable during merge fest (watch out if you track it; we do for CDS, INSPIRE)

1 Releases

**2 Modules**

3 Summary

# Invenio Modules: Overview

*Author*

# Invenio Modules: Overview

*Author*

*Sources*

# Invenio Modules: Overview

*Author*

*Sources*

*Librarian*

# Invenio Modules: Overview



# Invenio Modules: Overview

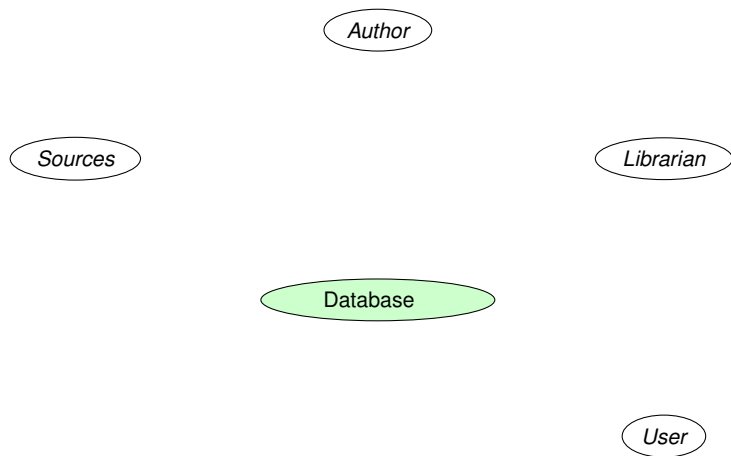

# Invenio Modules: Overview

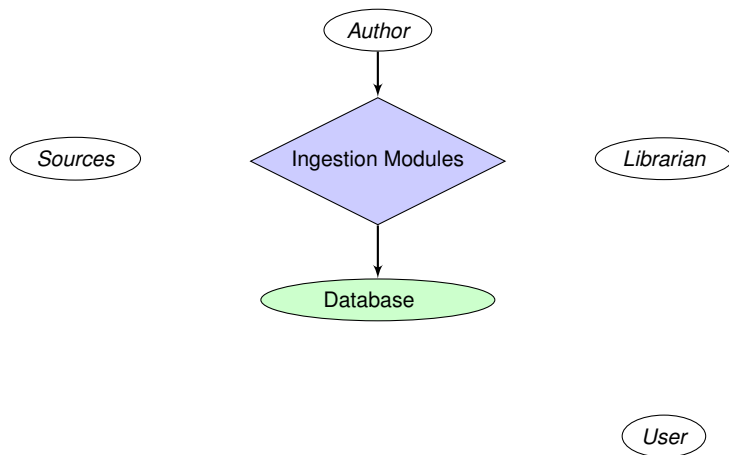



# Invenio Modules: Overview

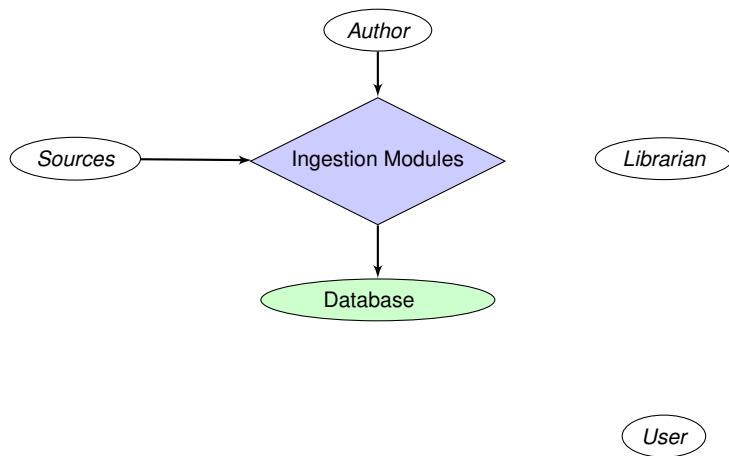

# Invenio Modules: Overview

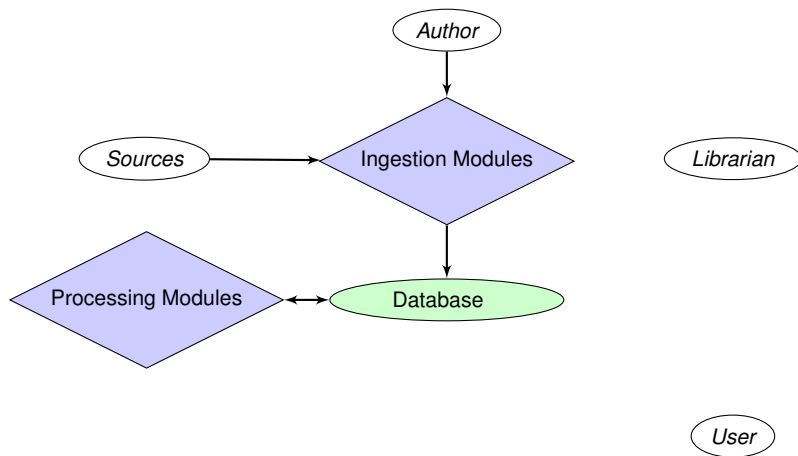

# Invenio Modules: Overview

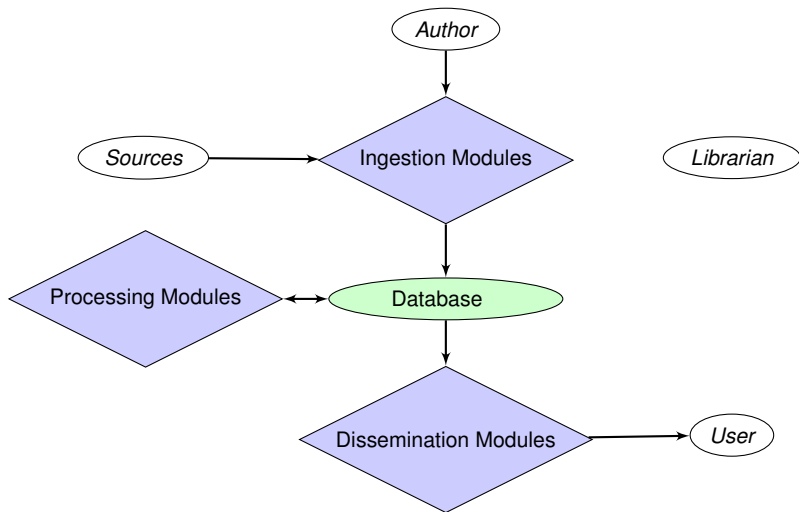

# Invenio Modules: Overview

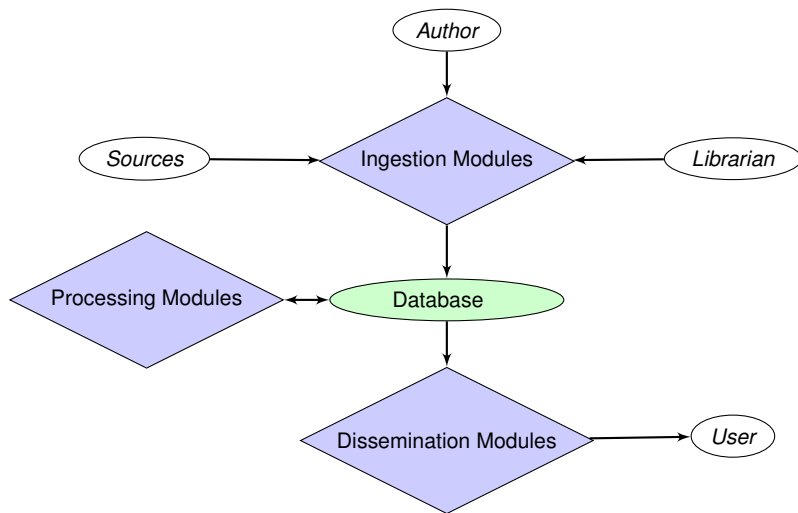

# Invenio Modules: Overview

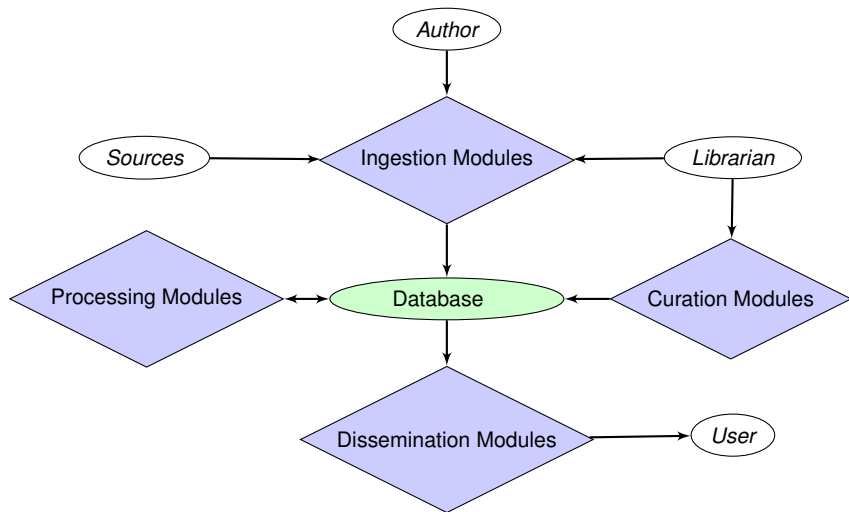

# Invenio Modules: Overview

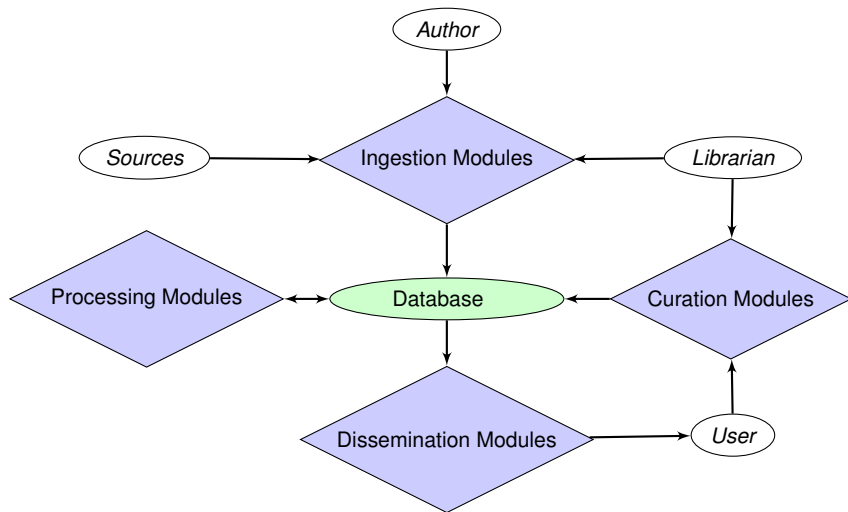

*Author*

# Invenio Modules: Ingestion

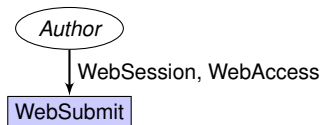



# Invenio Modules: Ingestion

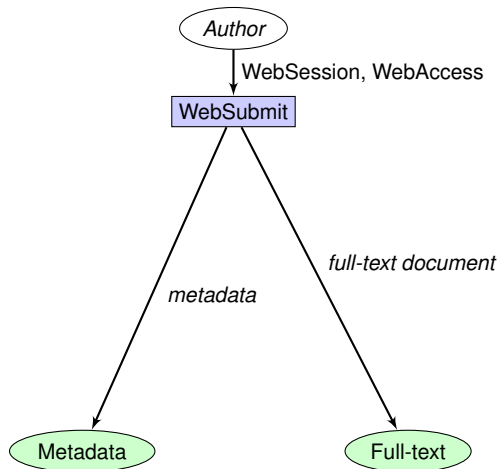

# Invenio Modules: Ingestion

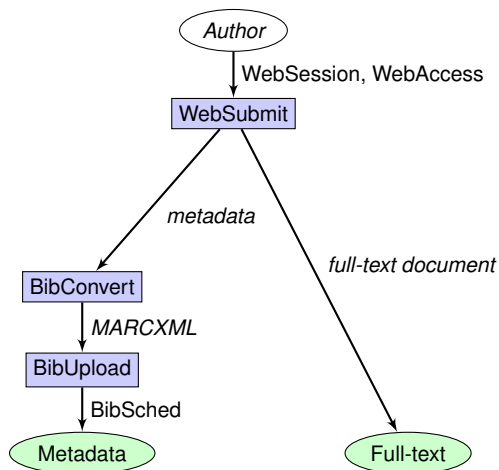

# Invenio Modules: Ingestion

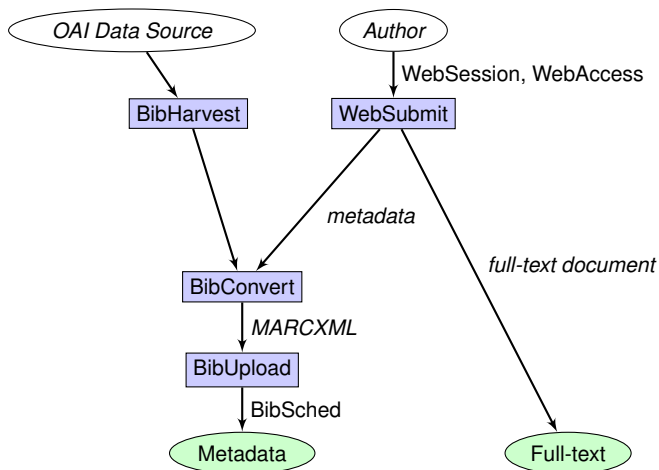

# Invenio Modules: Ingestion

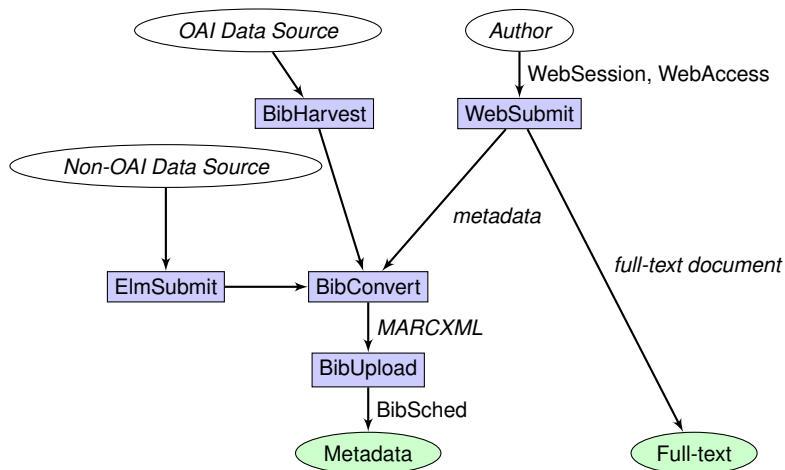

# Invenio Modules: Processing

Metadata

Full-text

# Invenio Modules: Processing



# Invenio Modules: Processing

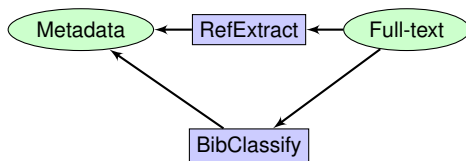

# Invenio Modules: Processing

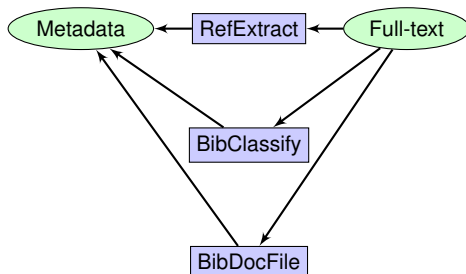



# Invenio Modules: Processing

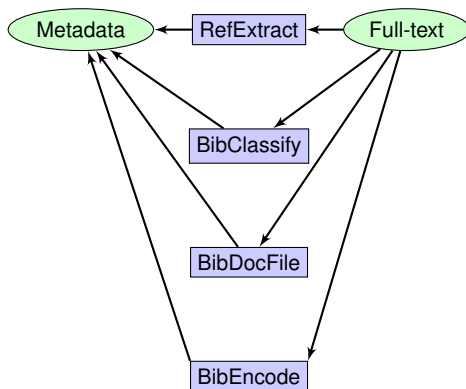

# Invenio Modules: Processing

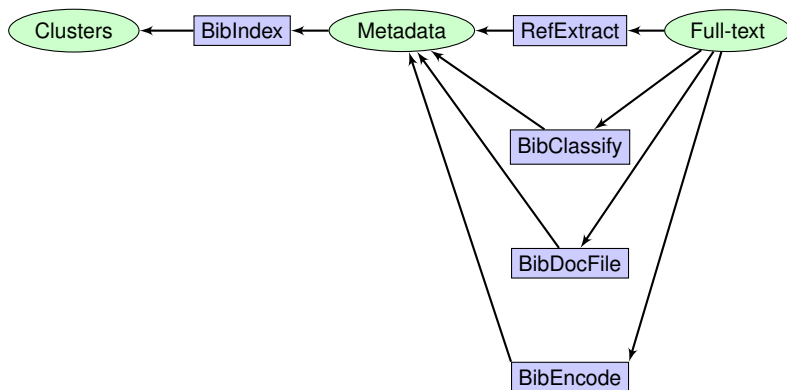

# Invenio Modules: Processing

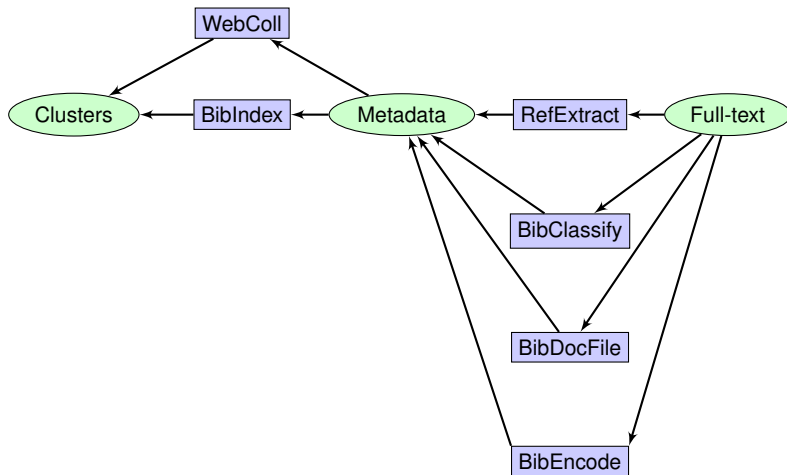

# Invenio Modules: Processing

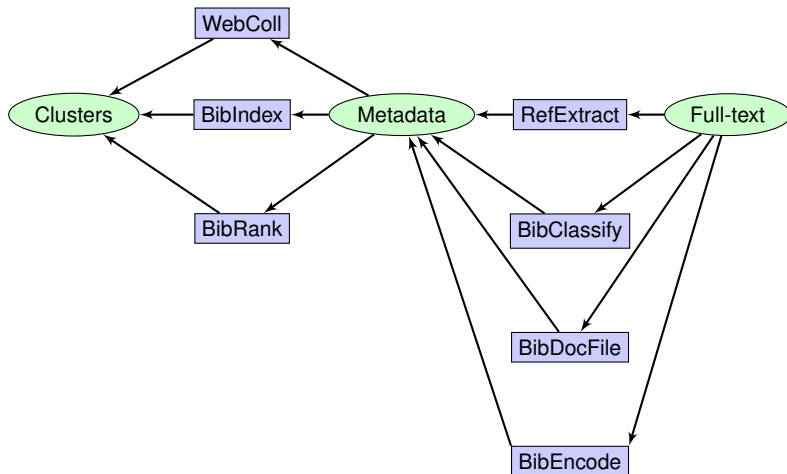

# Invenio Modules: Processing

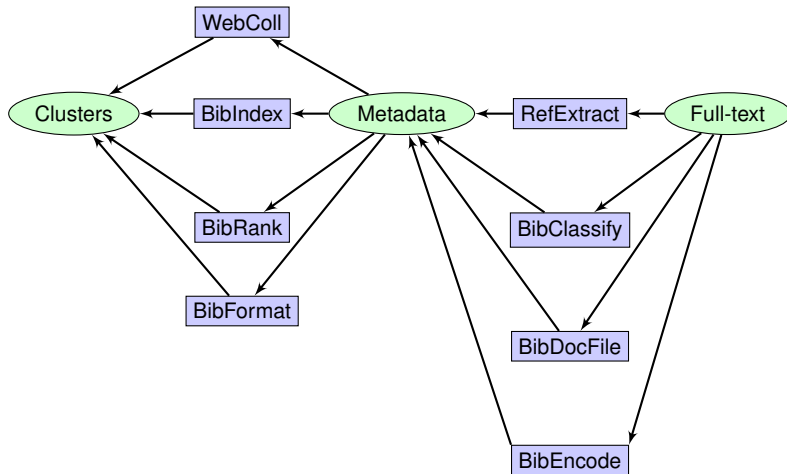

# Invenio Modules: Processing

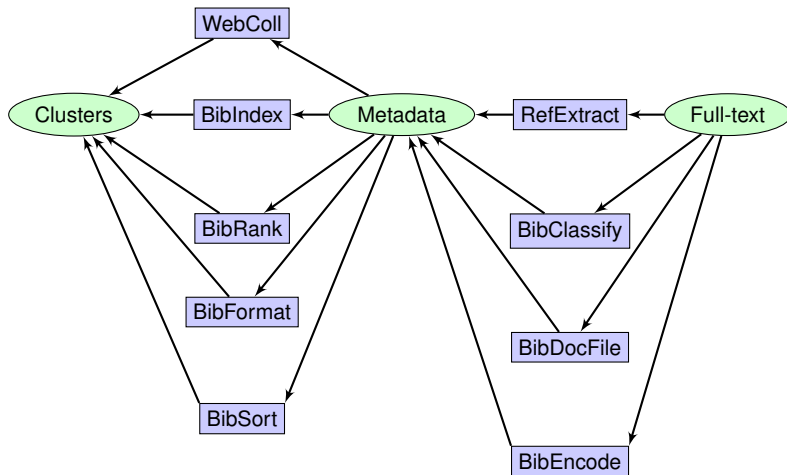

# Invenio Modules: Processing

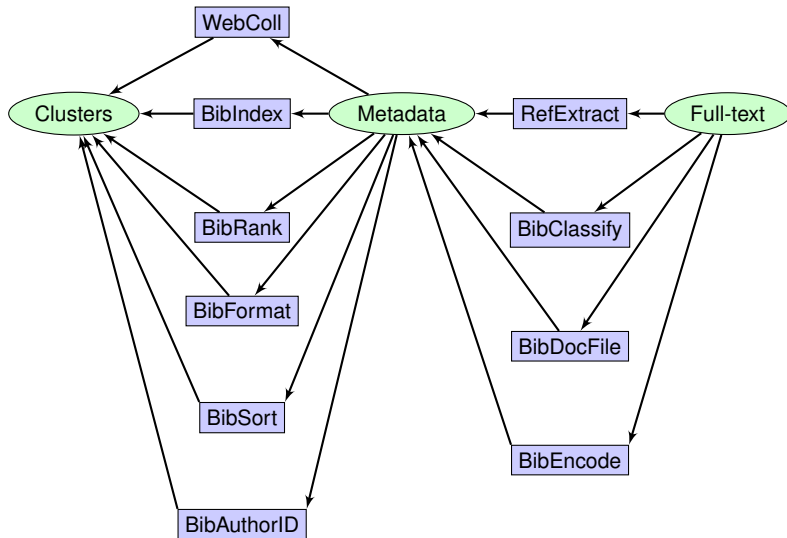

# Invenio Modules: Dissemination

Clusters

Metadata

Full-text



# Invenio Modules: Dissemination

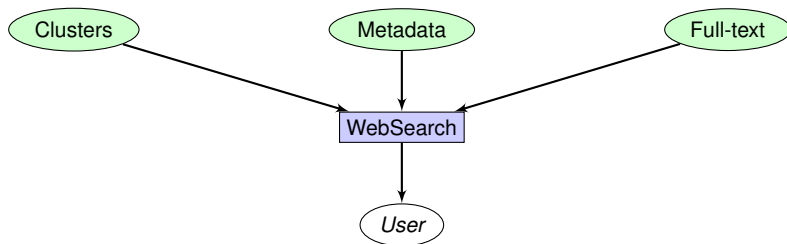

# Invenio Modules: Dissemination

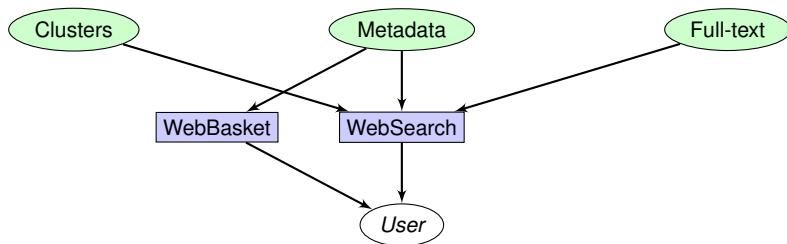

# Invenio Modules: Dissemination

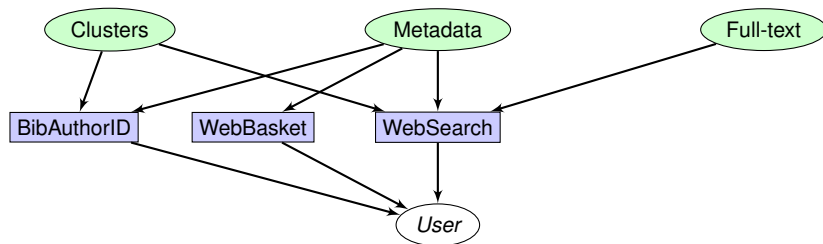

# Invenio Modules: Dissemination

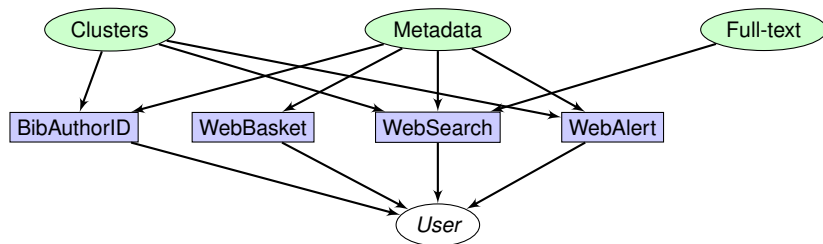

# Invenio Modules: Dissemination

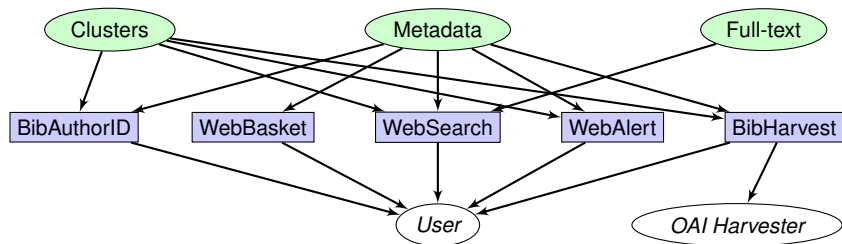

# Invenio Modules: Dissemination

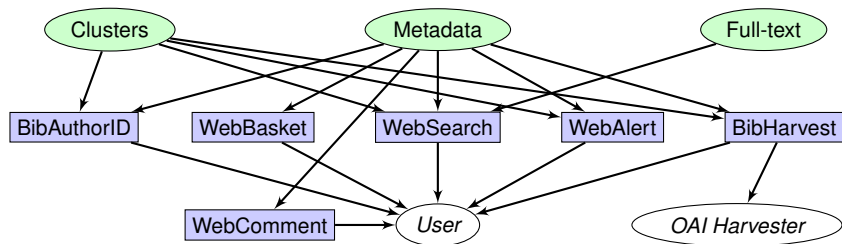

# Invenio Modules: Dissemination

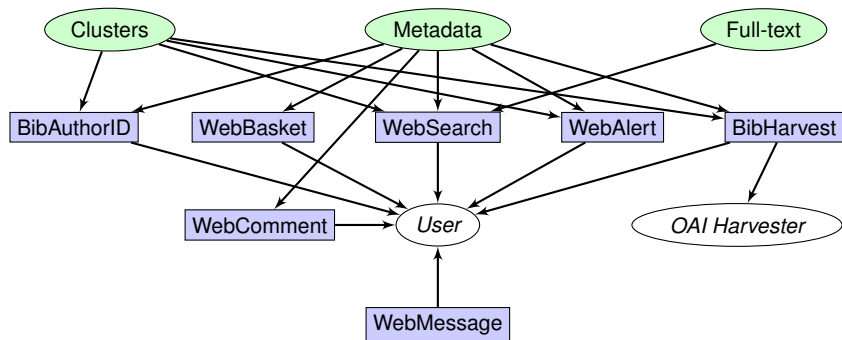

# Invenio Modules: Dissemination

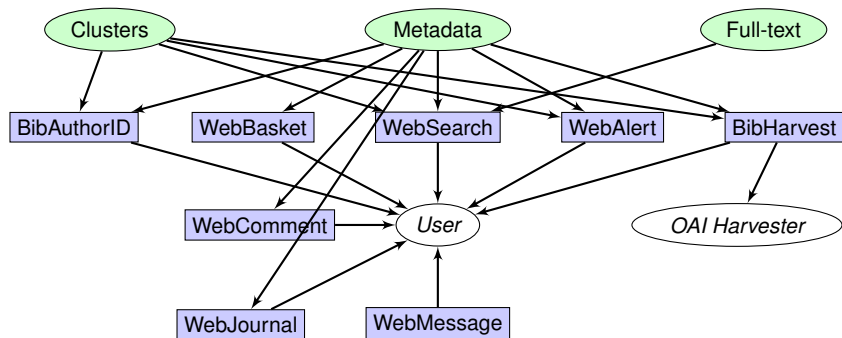



# Invenio Modules: Dissemination

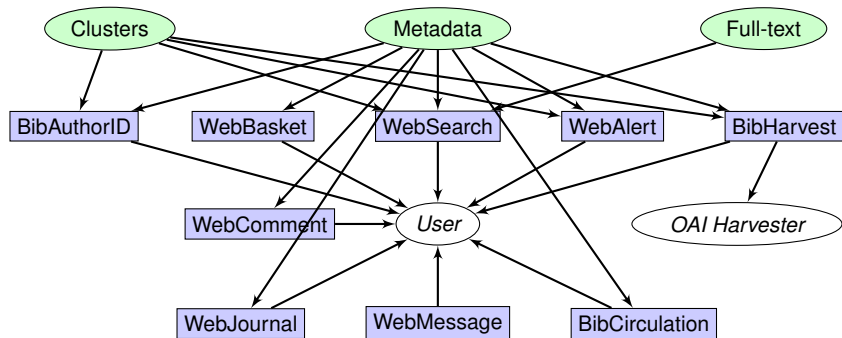

# Invenio Modules: Dissemination

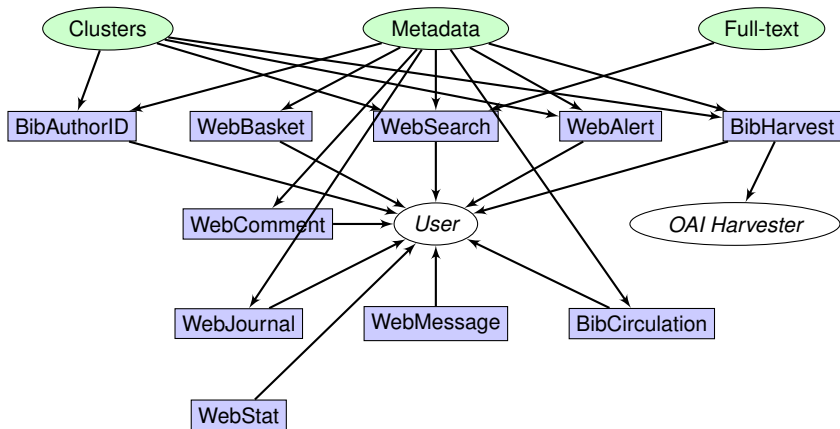

# Invenio Modules: Dissemination

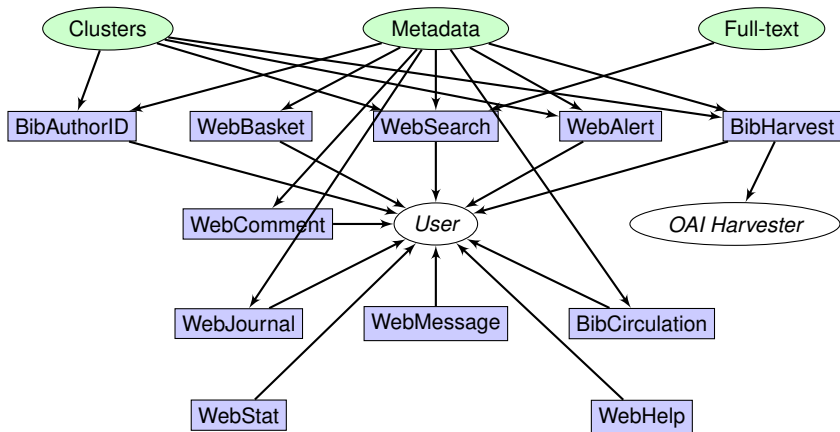

# Invenio Modules: Curation

Metadata

*Librarian*

Full-text

# Invenio Modules: Curation

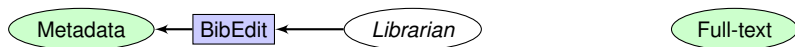

# Invenio Modules: Curation

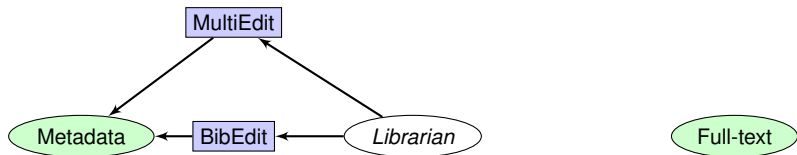

# Invenio Modules: Curation

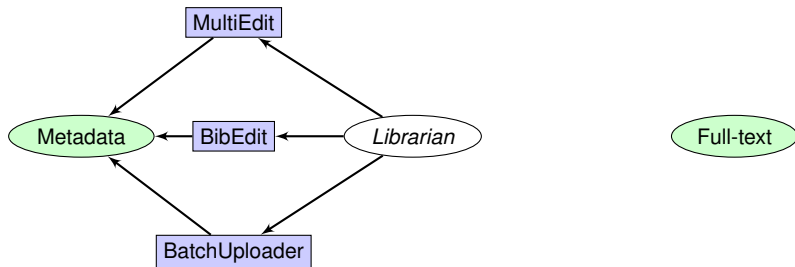

# Invenio Modules: Curation

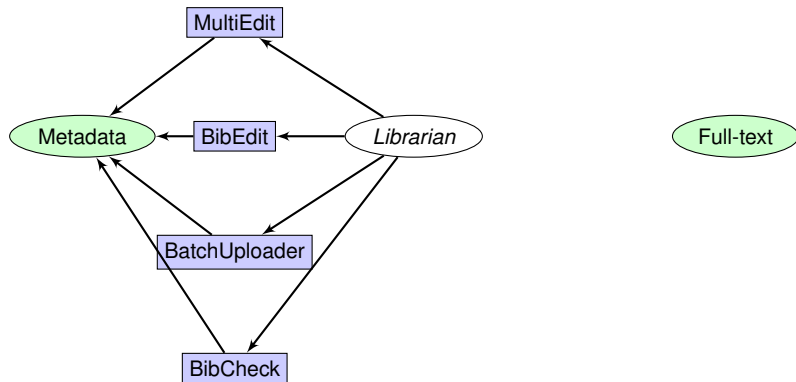



# Invenio Modules: Curation

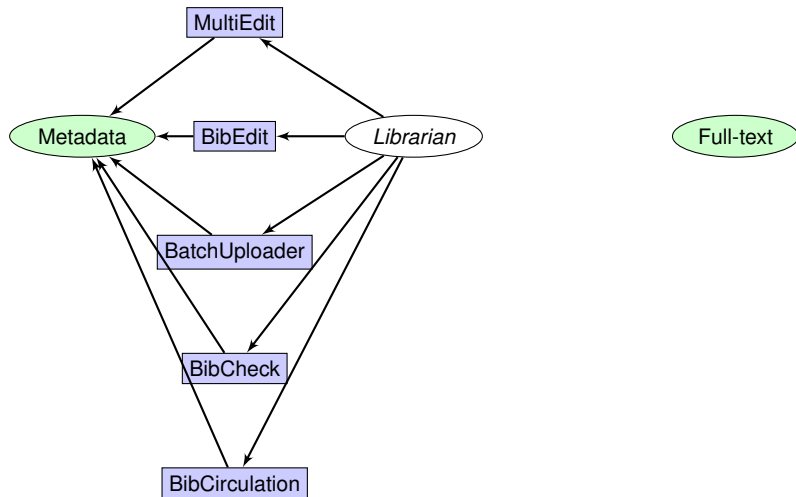

# Invenio Modules: Curation

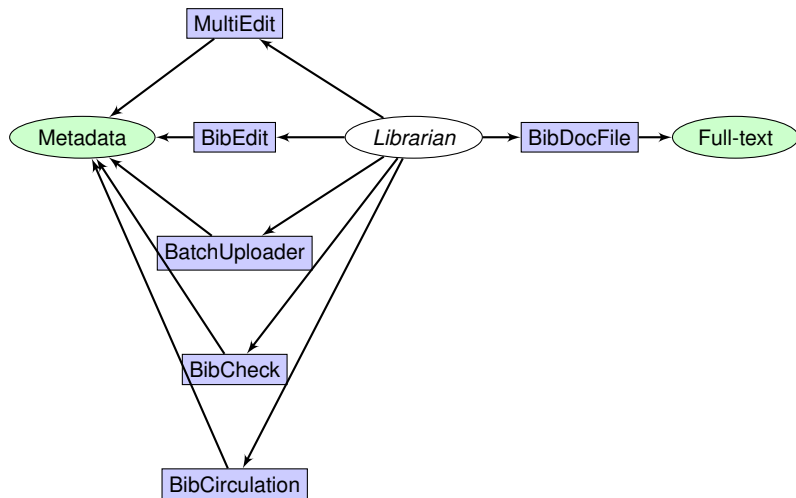

# Invenio Modules: Curation

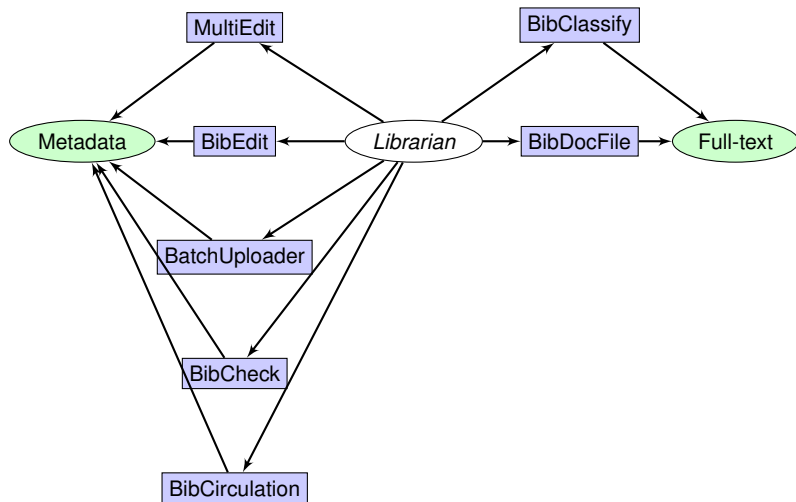

# Invenio Modules: Curation

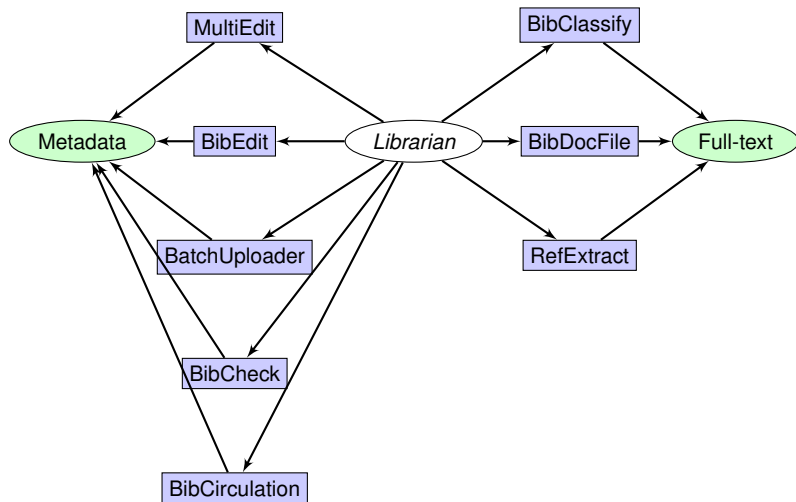

# Invenio Modules: Curation

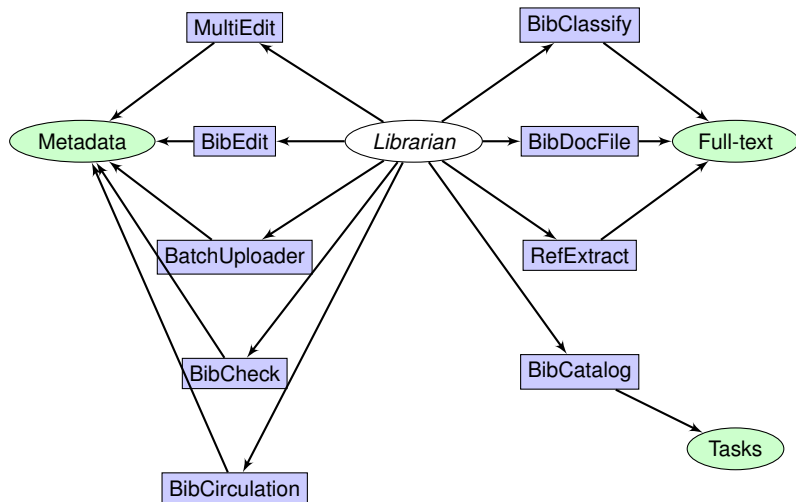

# Invenio Modules: Curation

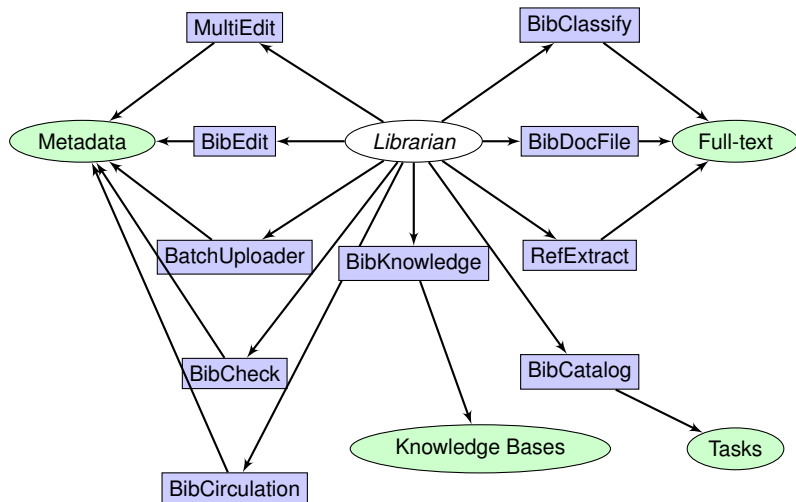

# Invenio Modules: Curation

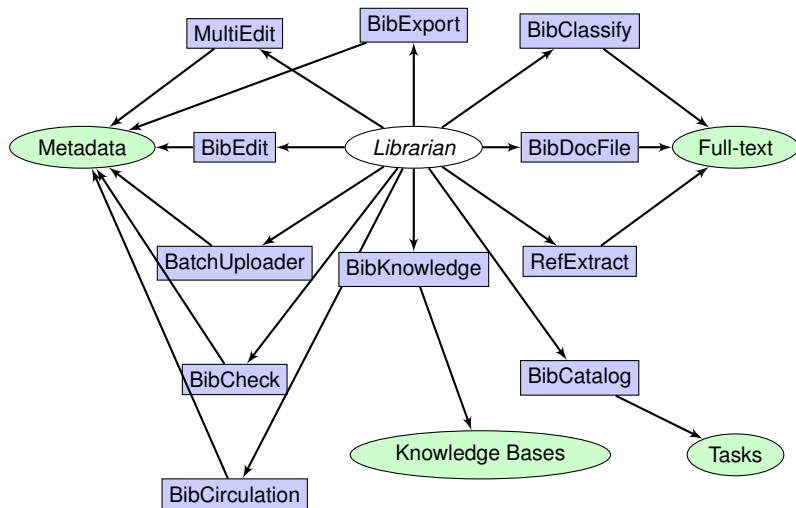

# Invenio Modules: Curation

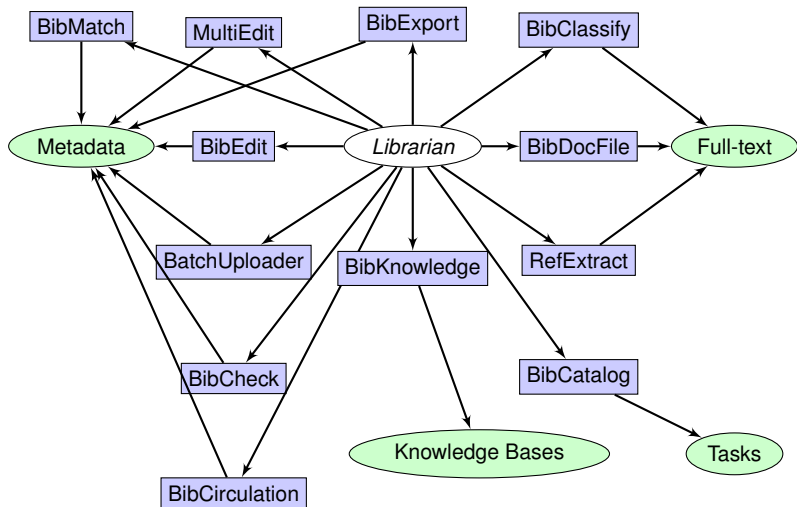



# Invenio Modules: Curation

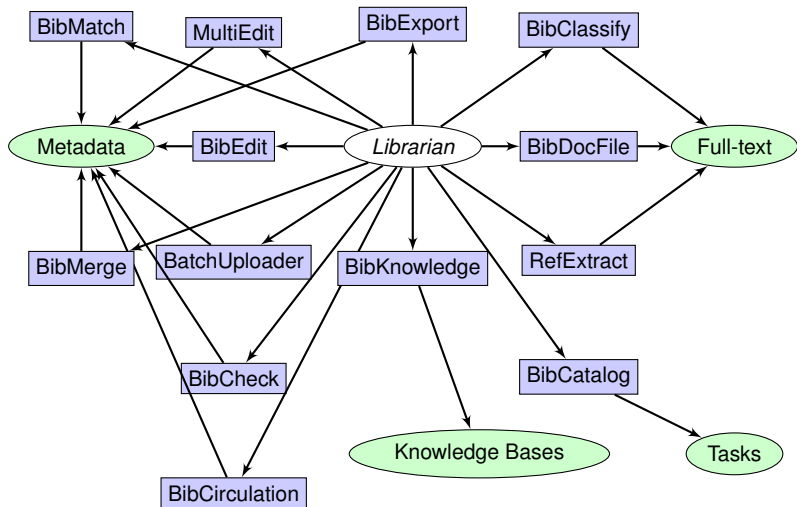

1 Releases

2 Modules

**3 Summary**

## Releases:

- `major.minor.patchlevel` release numbering scheme
- *maint-X.Y*, *master*, *next* source branches
- switching to time-based release model
  - targeting 3 or 4 minor releases per year
- v1.0 series current
- v1.1 and v1.2 around the corner
- v2.0 based on Flask/SQLAlchemy technology revamp

## Modules:

- 35+ modules with 320,000+ lines of code
- ingestion, processing, dissemination, curation families
- ... detailed module treatment throughout the workshop