

# Calibration System with Notched Fibres

Jan Smolík <sup>1</sup>, Ivo Polák <sup>1</sup>, Jiří Kvasnička <sup>1</sup>, Jaroslav Cvach <sup>1</sup>  
Josef Zuklín <sup>1</sup>, Ladislav Šašek <sup>2</sup>

<sup>1</sup>Institute of Physics ASCR  
Czech Republic

<sup>2</sup>Safibra, s. r. o.  
Czech Republic

June , 4 , 2014

# Outline

- 1 Introduction
- 2 First Physical Prototype
- 3 Full Calorimeter
- 4 Production of notched fibres
- 5 LED Driver
- 6 Test
- 7 Conclusions

## Is a dedicated calibration system needed?

- Huge number of channels
- Long time of detector exploitation
- High radiation environment
- Measuring rare process
- Novel types of photodetectors - SiPM, MAPD, MPPC

—> It is still good idea to have a dedicated calibration system which allows to measure single-photon peaks spectra and saturation curves

# AHCAL Design, CALICE Collaboration

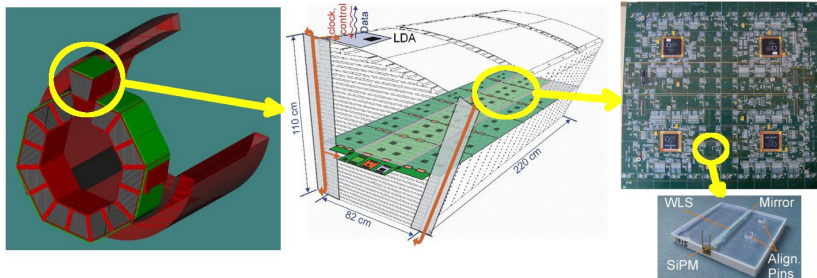

- Hadronic calorimeter for future linear collider ( $\sigma/E \sim 3\%$ )
- Designed for Particle Flow Algorithm
- Sandwich of absorber, active material and PCB with readout electronics
- Signal detection based on SiPM inside 3x3cm scintillator tiles, around  $8 \times 10^6$  channels

# AHCAL Physics Prototype

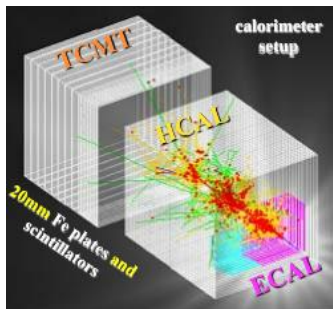

- The prototypes tested at DESY, CERN and Fermilab from 2006 till 2010.
- The PFA algorithm was approved.
- The simulation and reconstruction algorithm was tested

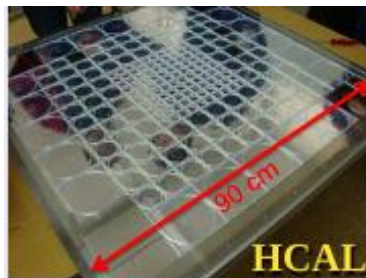

- 38 layers with 2cm Fe plates and 5mm scintillating tiles
- one layer consists of 216 tiles, 3x3, 6x6, 12x12  $cm^2$
- light collected by WLS fibre to photodetector - SiPM with 1156 pixels and gain  $\sim 10^5$

# Calibration Monitoring Board

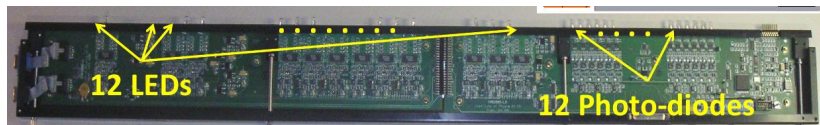

- 12 LED drivers with UV LED
- 12 PIN-Diode preamplifiers
- 1 LED  $\rightarrow$  19 fibres  $\rightarrow$  18 tiles + 1 PIN-Diode
- Configurable rectangle pulse length and amplitude
- 2 LVDS inputs for T-Calib and V-Calib
- CANbus controller
- Temperature readout

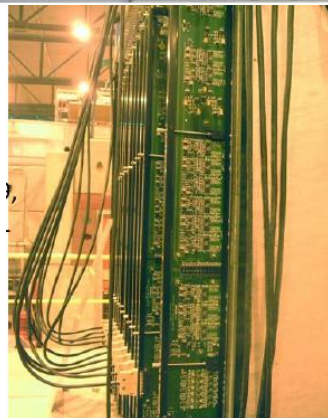

# Calibration

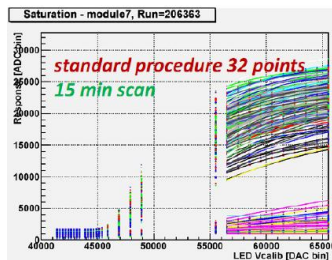
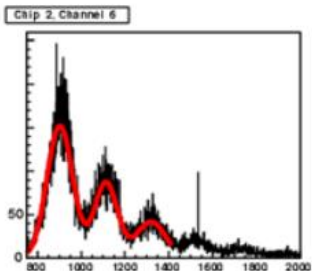

## Performance

- Measure single photon spectra
- Scan saturation curves
- Long-term reliability - it works for several years without problems
- Significant EM cross talk between LED drivers and PIN preamplifiers mainly due to metal frame

# Calibration System Design for Full Calorimeter

## Tasks

- Check single photon spectra
- Scan of saturation curves
- Production and installation simplicity

Two optional solutions

## Integrated

SMD LED and driver integrated in PCB over each of scintillating tiles

## External with fibres

External LED driver with simple optical distribution system. (Three notched fibres for one row of 72 tiles)



# Notched Fibres Distribution System

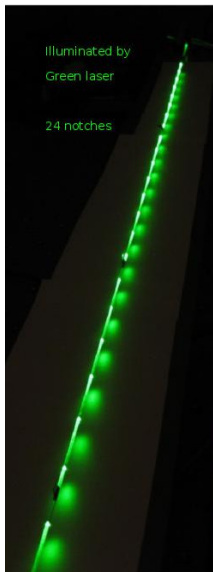

## Distribution of light: Notched fiber

- Plastic optical fibre, 1 mm in diameter
- Light is emitted from the **notches**
- The **notch** is a special scratch to the fibre, which reflects the light to the opposite direction
- The size of the notch varies from the beginning to the end of the fibre to maintain homogeneity of the light emitted by the notches
- Performance will be shown in this talk

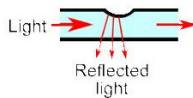

Emission from the fiber (side view)

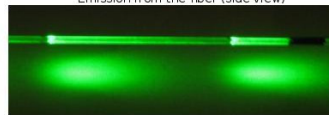

First notch

Middle notch

End position notch

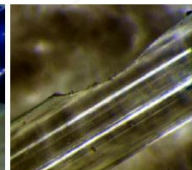
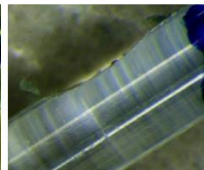
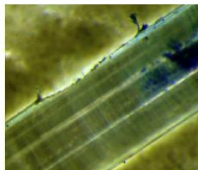

# Machine Production - Milling Machine

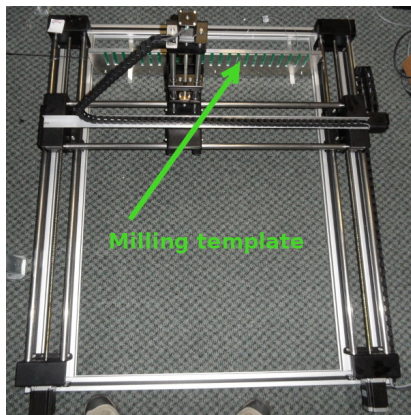

## CNC milling machine

- ML 1000F from CNC-multitool
- three dimension movement
- precision  $15\mu m$
- step  $10\mu m$

## Milling template

- allows direct measurement
- configured for AHCAL geometry

# Rough Algorithm

Simple trimming till the light output achieves desired value.

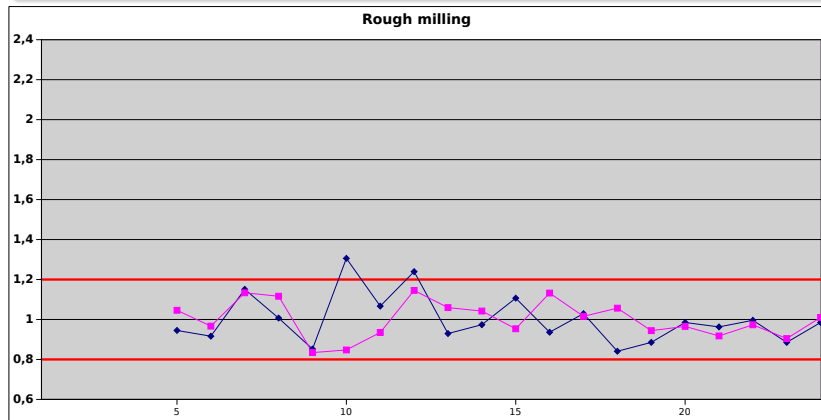

# Light Output During Milling Process

The dependence of measured light on position of the cutter during production process

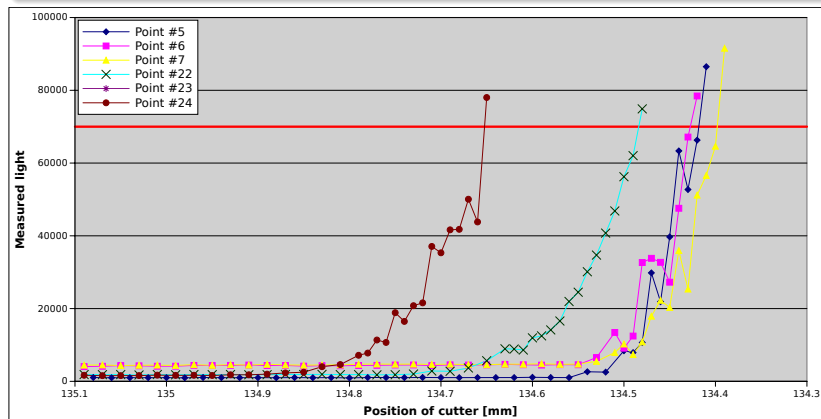

# Fine-grain Algorithm

Imitation of “sub-step” of milling machine by repetitive approach to the same milling position

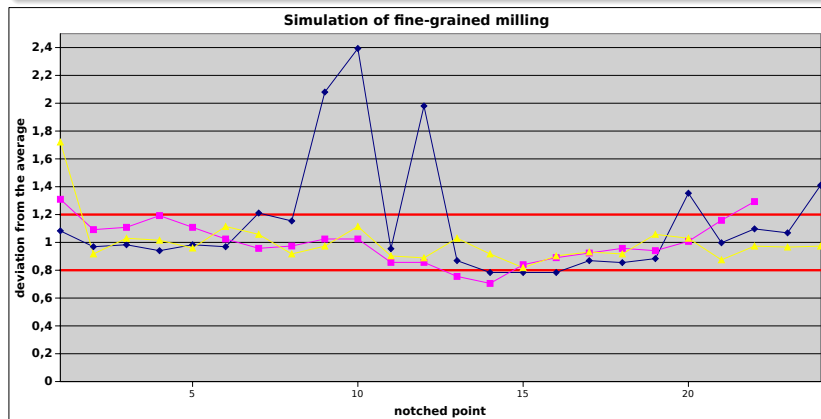

# LED Pulse Driver - QMB1

- Modular systems
- Low EM emission
- One driver - one LED
- CANbus controller
- LVDS trigger

## Main Parameters

- Smooth pulse shape (half-sine shape)
- Variable amplitude ( 1A peak)
- Repetition rate up to 100 kHz
- Fixed pulse width (2.4–3.5 ns)
- PCB size  $30 \times 140\text{mm}^2$
- High stability in static magnetic field

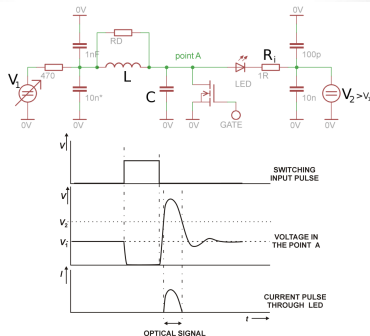
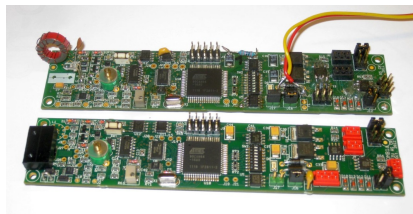

# Full Setup Test

Full slab of 6HBUs with installed three sets of notched fibres

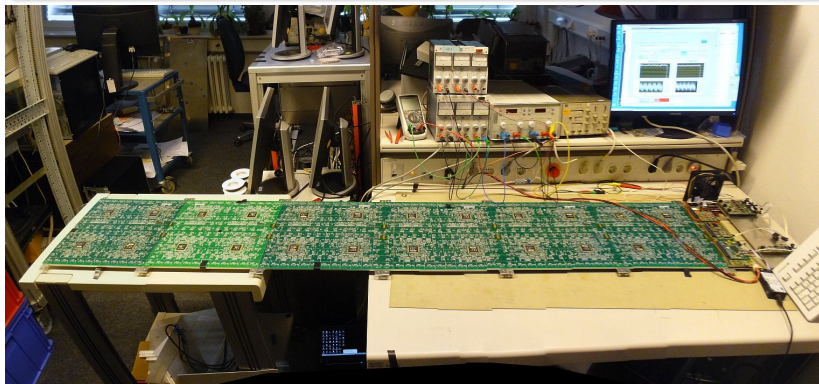

# Full Setup Test

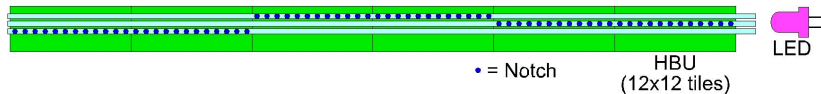

- the system tested using 3 row of 72 tiles
- one row illuminated by one LED drive and three notched fibres

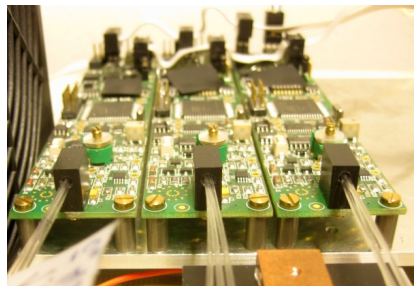



# Full Setup Test Results - Set of Three Fibre Performance

Response of one row of 72 scintillating tiles on low level calibration light generated by one QMB1 LED driver and distributed by set of three notched fibres.

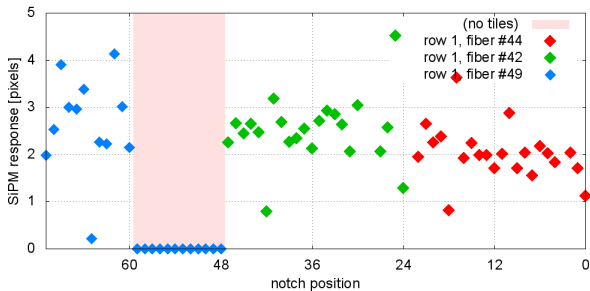

# Full Setup Test Results

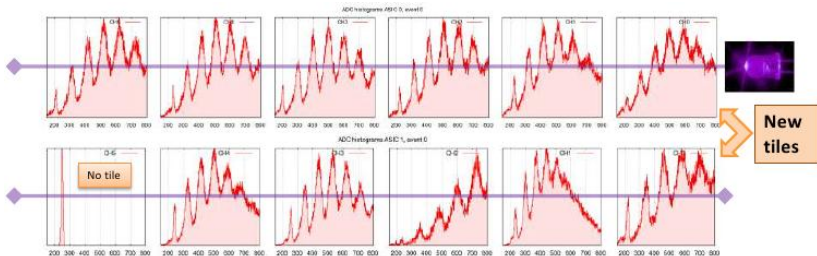

row 1, fibre #36

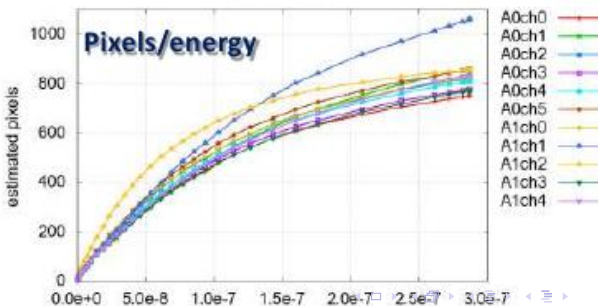

# Conclusions

## LED drivers are ready to use

- They can be adapted to different experiments (COMPASS)

## What we need for real production of notched fibres

- Precision and stability play crucial role
- Fixed milling position - fibre carrier
- Cutter with a diameter of 1-2 mm
- More accuracy machine with repeatability and minimal step at level  $\sim 1\mu m$
- Implementation of distance measurement between cutter and fibre
- Implementation of fibre fan-cleaning

For huge application the system for automatic installation of fibres must be developed!

## Main conclusion

The “industrial” production of notched fibres with reasonable parameters is possible.

# The End

Thank you for your attention

# Optical output versus V1

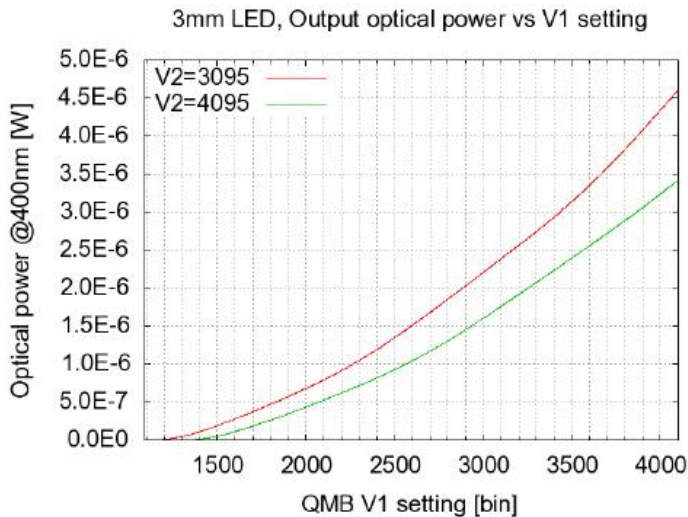

# QMB6 Tests in Magnetic Field

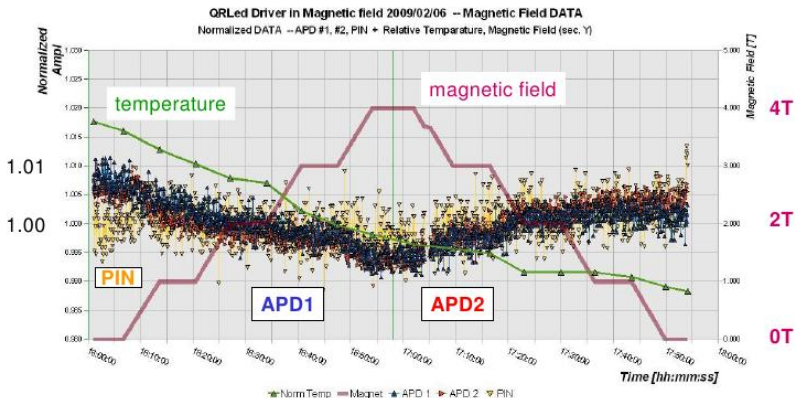

## Results

Very high stability in static magnetic field - amplitude change less than 1% in 0-4T magnetic field