

# Superconductor Stability



CERN Accelerator School  
Superconductivity for Accelerators

Erice, April 25<sup>th</sup> – May 4<sup>th</sup>, 2013

[Luca.Bottura@cern.ch](mailto:Luca.Bottura@cern.ch)



# Plan of the lecture

---

- Training and degradation
- Perturbation spectrum overview
- Heat balance
- Stabilization strategies and criteria
- A summary and more complex topics

focus on LTS magnets  
adiabatic, or helium cooled



# Plan of the lecture

---

- **Training and degradation**
- Perturbation spectrum overview
- Heat balance
- Stabilization strategies and criteria
- A summary and more complex topics

# Training...

- Superconducting solenoids built from NbZr and Nb<sub>3</sub>Sn in the early 60's **quenched** much below the rated current ...
- ... the quench current increased gradually quench after quench: ***training***

NbZr solenoid  
Chester, 1967

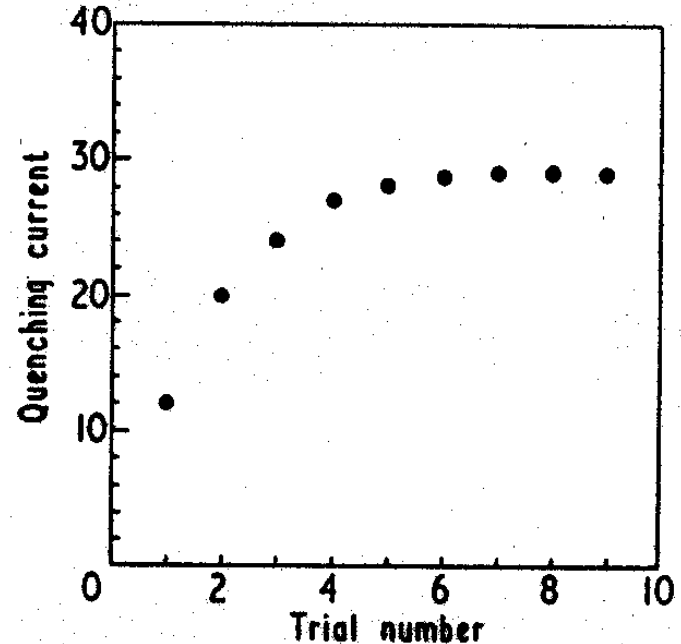

M.A.R. LeBlanc, Phys. Rev., **124**, 1423, 1961.

P.F. Chester, Rep. Prog. Phys., **XXX**, II, 561, 1967.

# ... and degradation

- ... but did not quite reach the expected maximum current for the superconducting wire !
- This was initially explained as a local damage of the wire: **degradation**, a very misleading name.
- All this had to do with **stability**

NbZr solenoid vs. wire  
Chester, 1967

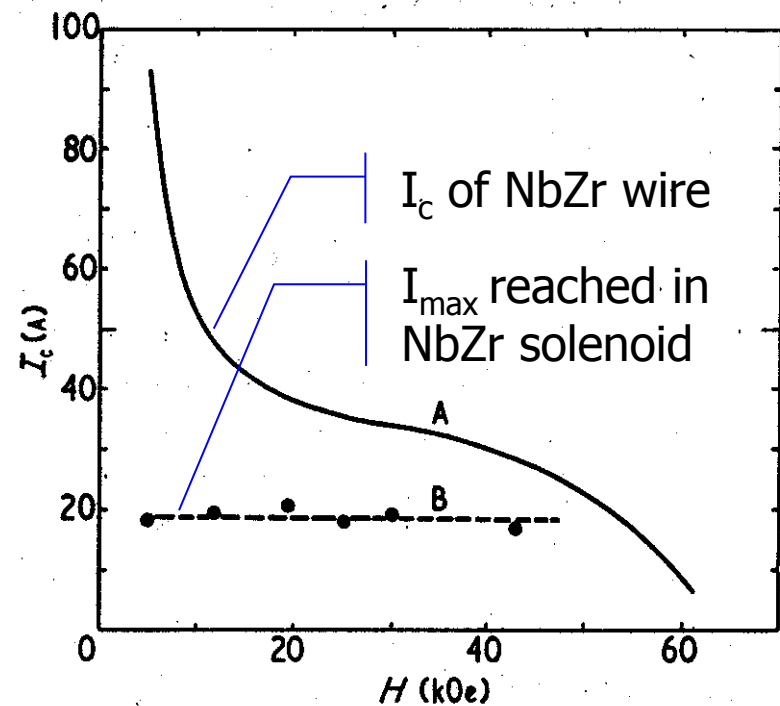

# Training today

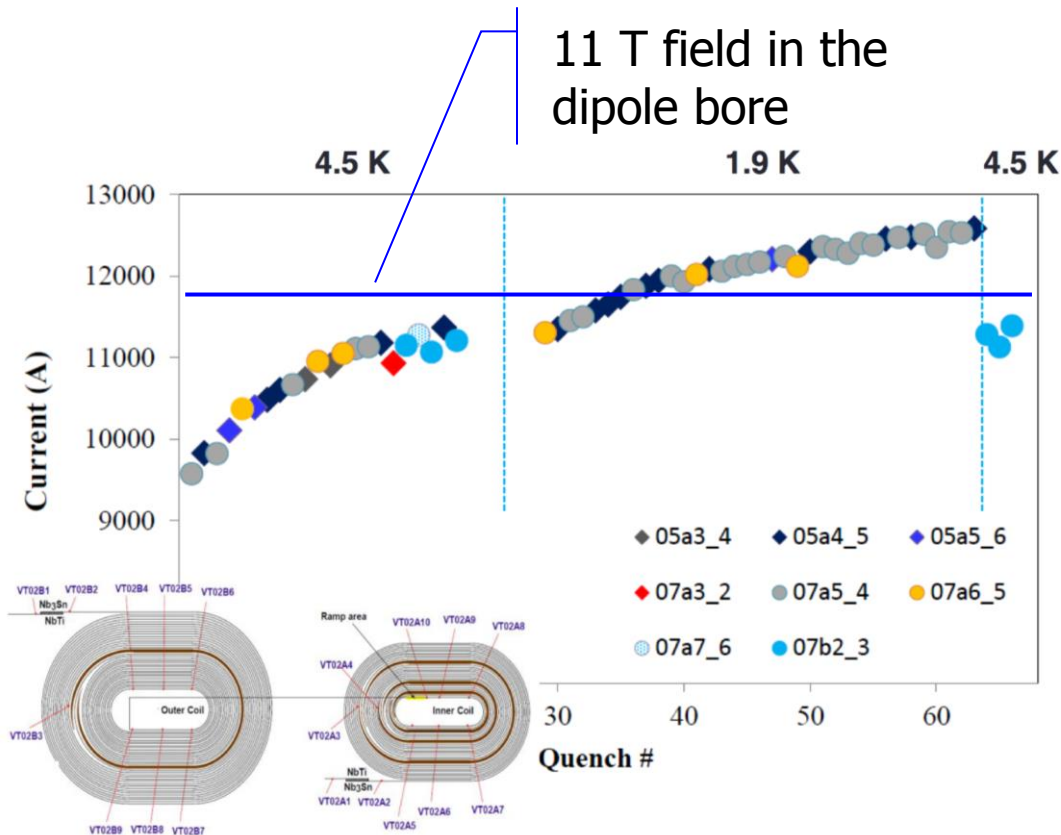

- Training of an model  $\text{Nb}_3\text{Sn}$  11 T dipole for the LHC upgrade in liquid and superfluid helium
  - Still, training may be necessary to reach nominal operating current
  - Short sample limit is not reached, even after a long training sequence

Courtesy of G. Chlachidze, Fermilab, April 2013, unpublished

**stability is (still)  
important !**

# Dealing with early instabilities

*"Those tiny, primitive magnets were, of course, terribly unstable [...] One had to have faith to believe that these erratic toys of the low temperature physicist would ever be of any consequence as large engineered devices"* (J. Hulm, ASC 1982)

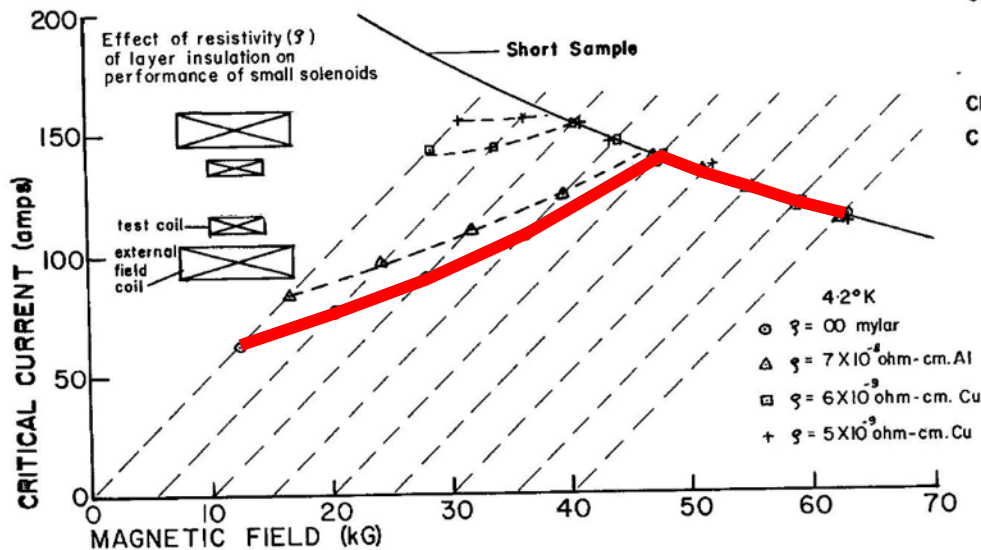
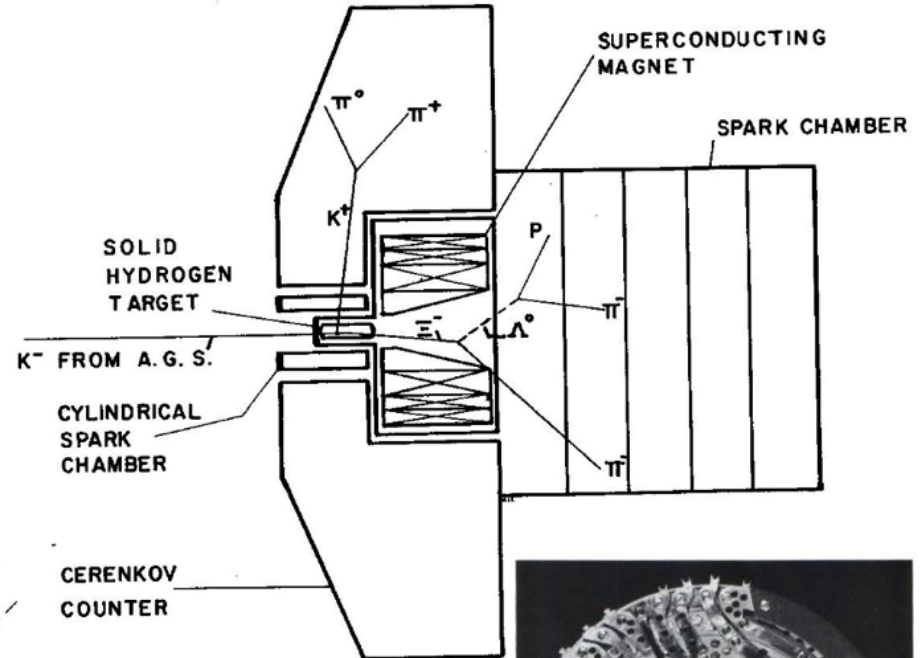

# A *Woodstock* for SC accelerator magnets

BNL 50155 (C-55)

PROCEEDINGS OF THE 1968 SUMMER STUDY  
ON SUPERCONDUCTING DEVICES AND ACCELERATORS  
Part I (pp. 1-376)

BROOKHAVEN NATIONAL LABORATORY  
June 10 - July 19, 1968



M. Morpurgo B. Montgomery W. Sampson P. Smith P. Lazeyras R. Wittgenstein

J. Hale Y. Iwasa



- A six weeks summer study organized and hosted by BNL in 1968
- The *crème de la crème* addressed material and engineering issues of superconducting accelerators, among them:
  - **Stability**, training and degradation
  - **Flux-jumps** in composite superconductors
  - Twisting of multi-filamentary wires and cables



# An event tree for stability (and quench)

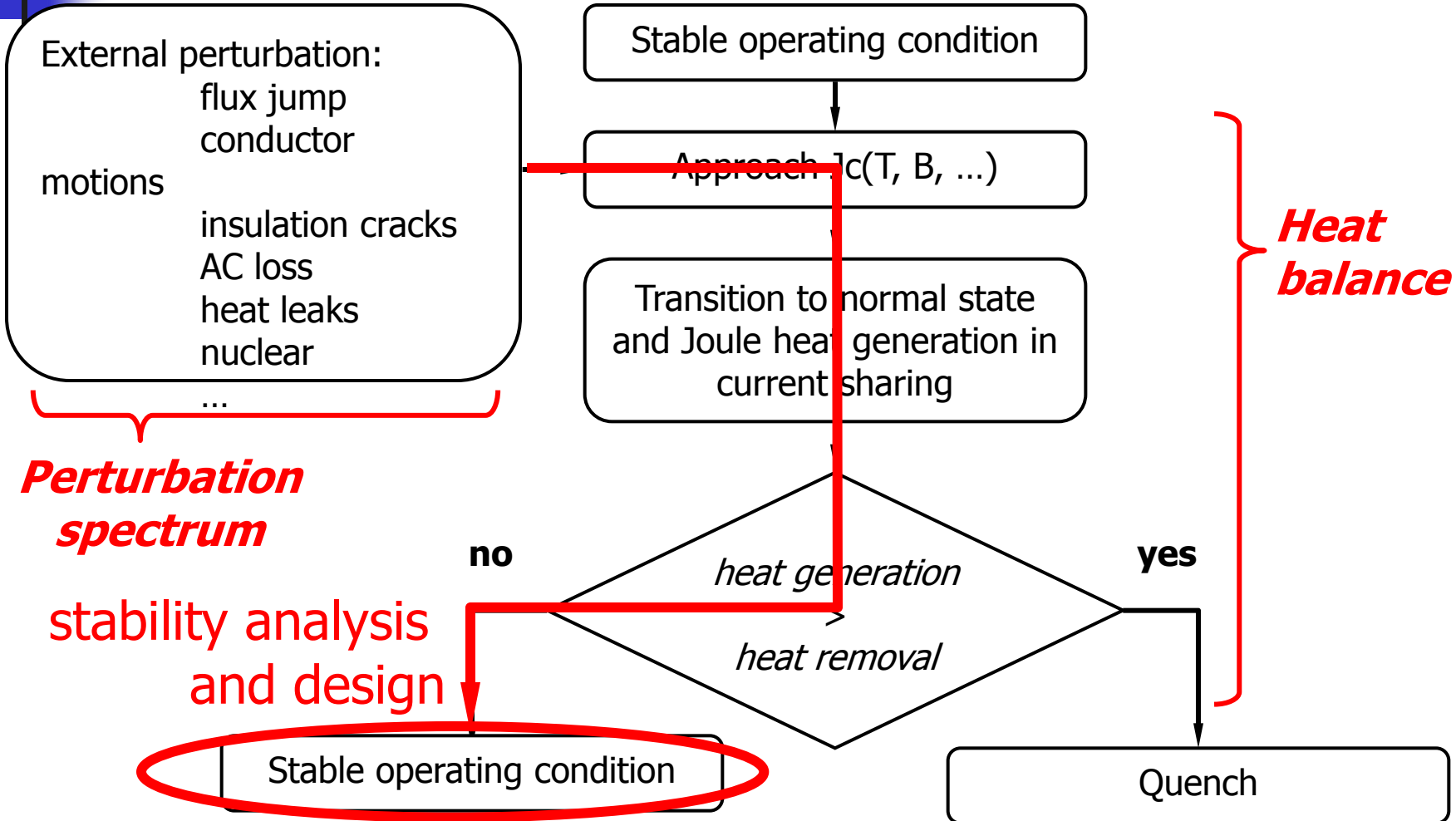



# Plan of the lecture

---

- Training and degradation
- **Perturbation spectrum overview**
- Heat balance
- Stabilization strategies and criteria
- A summary and more complex topics



# Perturbation spectrum

---

- Mechanical *events*
  - Wire motion under Lorentz force, micro-slips
  - Winding deformations
  - Failures (at insulation bonding, material yield)
- Electromagnetic *events*
  - Flux-jumps (important for large filaments, old story ?)
  - AC loss (most magnet types)
  - Current sharing in cables through distribution/redistribution
- Thermal *events*
  - Current leads, instrumentation wires
  - Heat leaks through thermal insulation, degraded cooling
- Nuclear *events*
  - Particle showers in particle accelerator magnets
  - Neutron flux in fusion experiments



# Perturbation scales

---

- Transient (stability concern)
  - point  $Q$  [Joules]
  - distributed  $Q'''$  [Joules/m<sup>3</sup>] → [mJ/cm<sup>3</sup>]
  
- Continuous (sizing of cooling system)
  - point  $q$  [Watts]
  - distributed  $q'''$  [Watts/m<sup>3</sup>]

# Perturbation overview

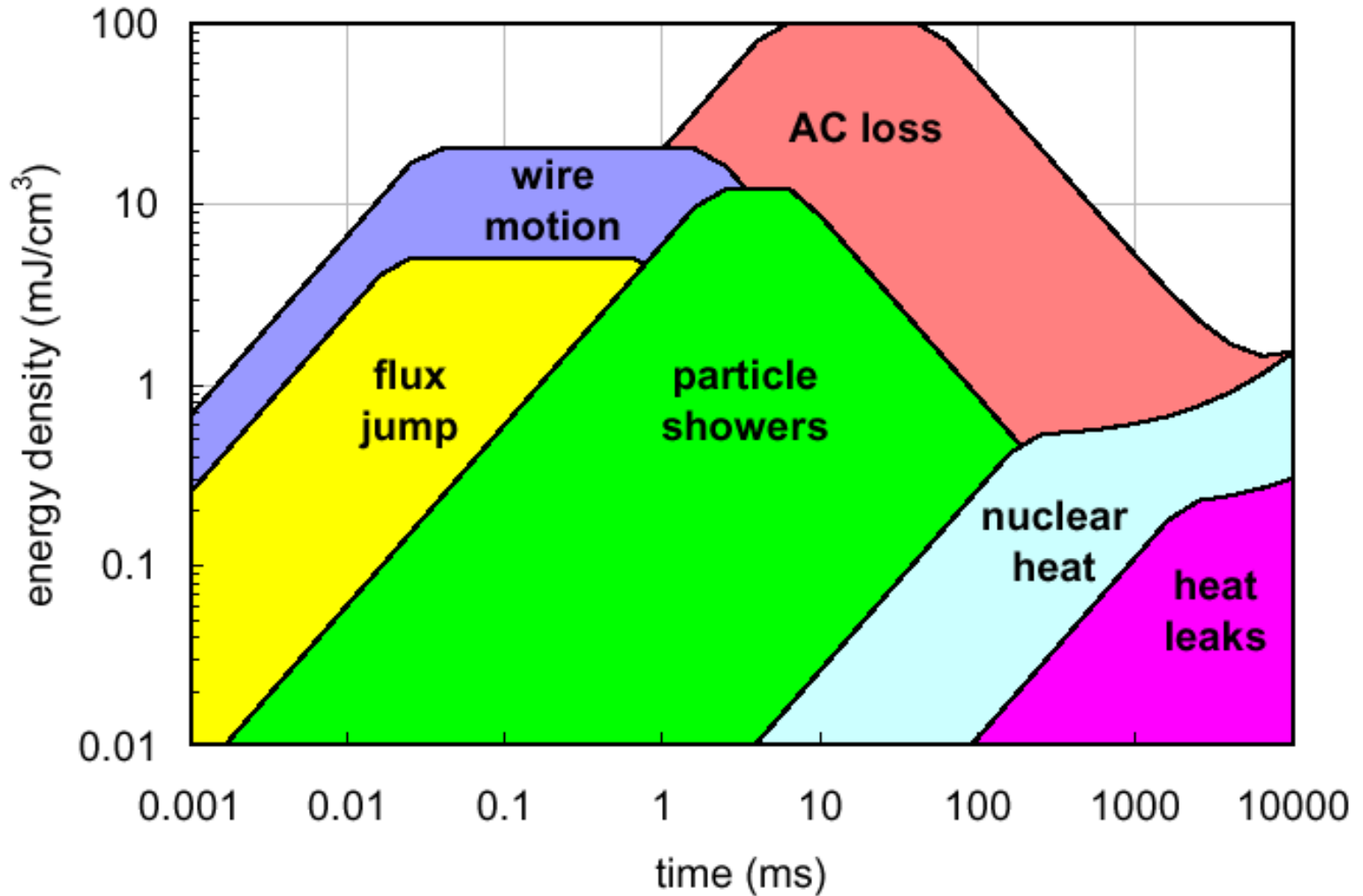

# Flux jump mechanism

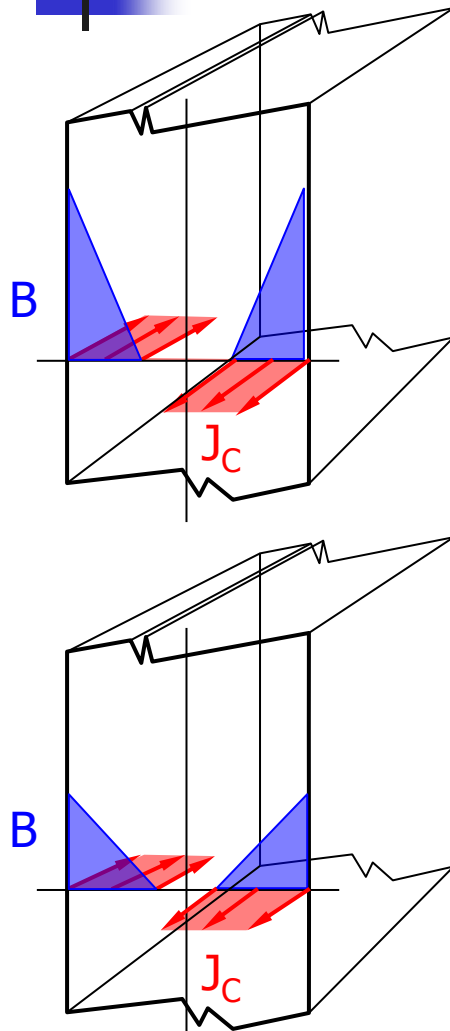

External field change induces screening *persistent* currents ( $J_c$ ) in the superconductor

A small perturbation induces a temperature increase

Critical current density decreases at increasing temperature

A drop in screening current causes the field profile to enter in the superconductor

Energy is dissipated (flux motion)

Thermal diffusivity and heat capacity is small in the superconductor and the temperature increases

# Flux-jumps energy

- During a complete flux-jump the field profile in a superconducting filament becomes flat:
  - e.g.: field profile in a fully penetrated superconducting slab

$$dB = m_0 J_c x$$

- energy stored in the magnetic field profile:

$$Q''' = \frac{2}{D} \int_0^{D/2} \frac{dB^2}{2m_0} dx = \frac{m_0 J_c^2 D^2}{24}$$

$$D = 50 \mu\text{m}, J_c = 10000 \text{ A/mm}^2$$

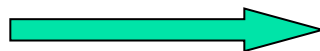

$$Q''' \approx 6 \text{ mJ/cm}^3$$

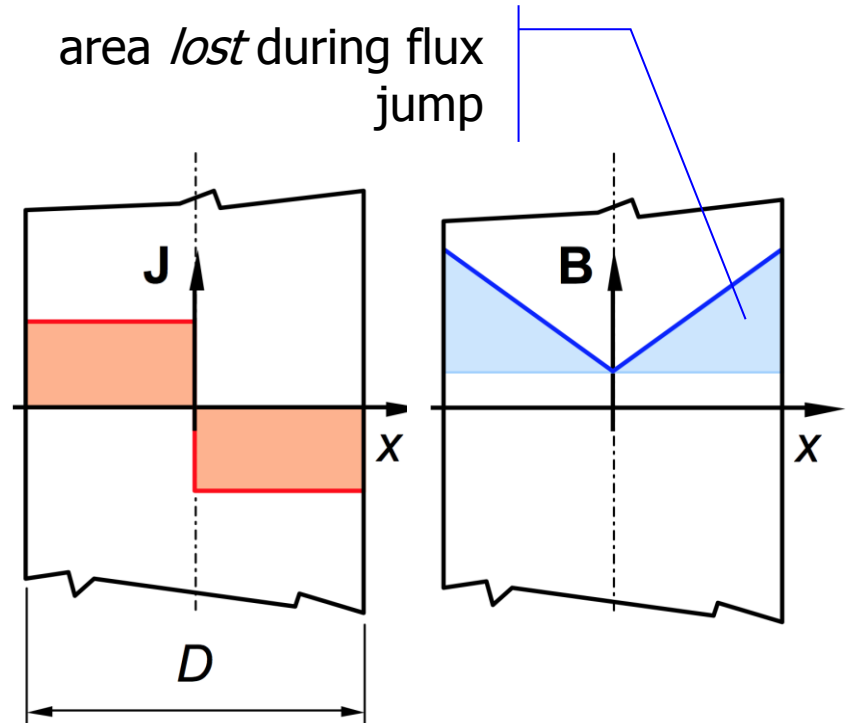

**NOTE: to decrease  $Q'''$ , one can decrease  $D$**

# Flux jumps then and now

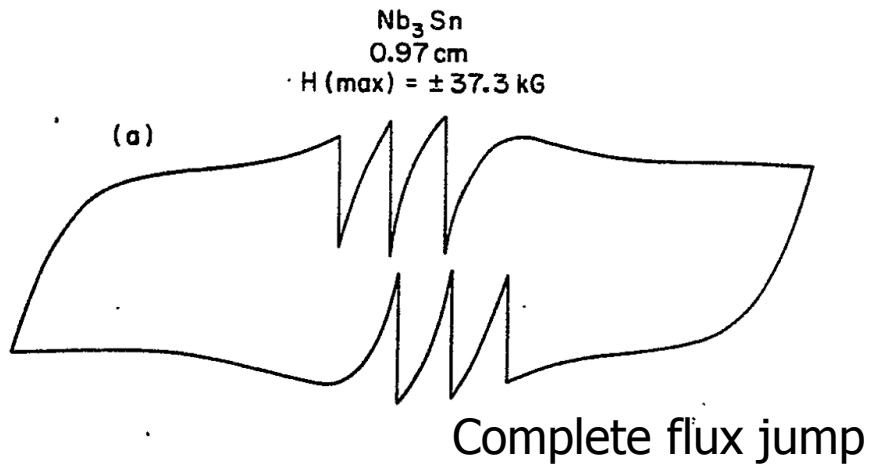

A.D. McInturf, *Composite Materials*,  
Proceedings of the **1968** Summer  
School on Superconducting Devices  
and Accelerators, BNL 50155 (C-55)

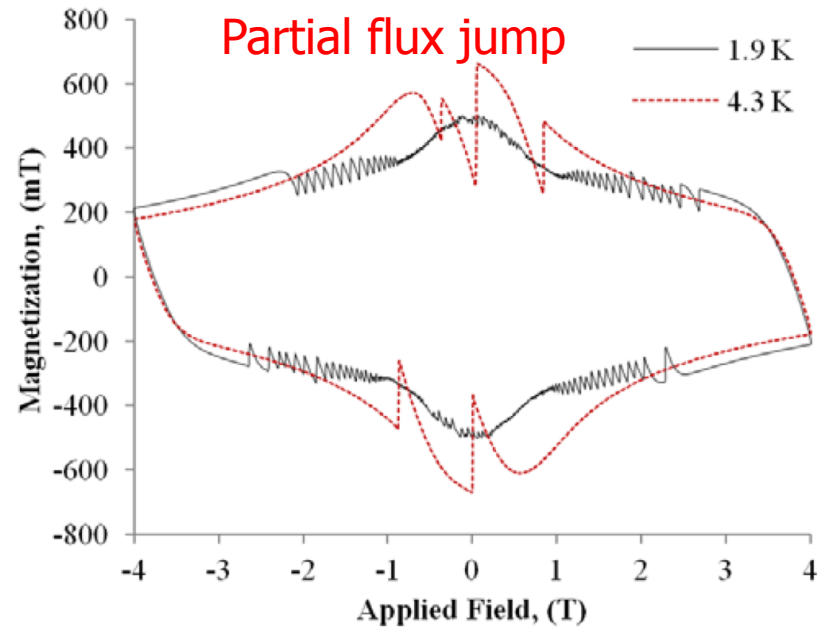

B. Bordini, et al., *Magnetization  
Measurements of High- $J_C$   $\text{Nb}_3\text{Sn}$   
Strands*, CERN-ATS-**2013**-029

Flux jumps is **not** an old story, we still suffer from magnetic instabilities when pushing for high conductor  $J_C$





# Plan of the lecture

---

- Training and degradation
- Perturbation spectrum overview
- **Heat balance**
- Stabilization strategies and criteria
- A summary and more complex topics

# Prototype heat balance

Perturbation

Joule heating

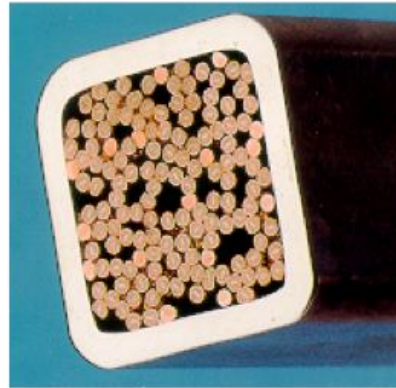

superconducting cable

heat capacity

conduction

cooling

$$C \frac{\partial T}{\partial t} = \underbrace{q_{ext}}_{\text{Heat source}} + \underbrace{q_J}_{\text{Joule heat}} + \underbrace{\frac{\partial}{\partial x} \left( k \frac{\partial T}{\partial x} \right)}_{\text{Conduction}} - \underbrace{\frac{wh}{A} (T - T_{he})}_{\text{cooling}}$$

Heat capacity

generation

Heat transfer

# Temperature transient

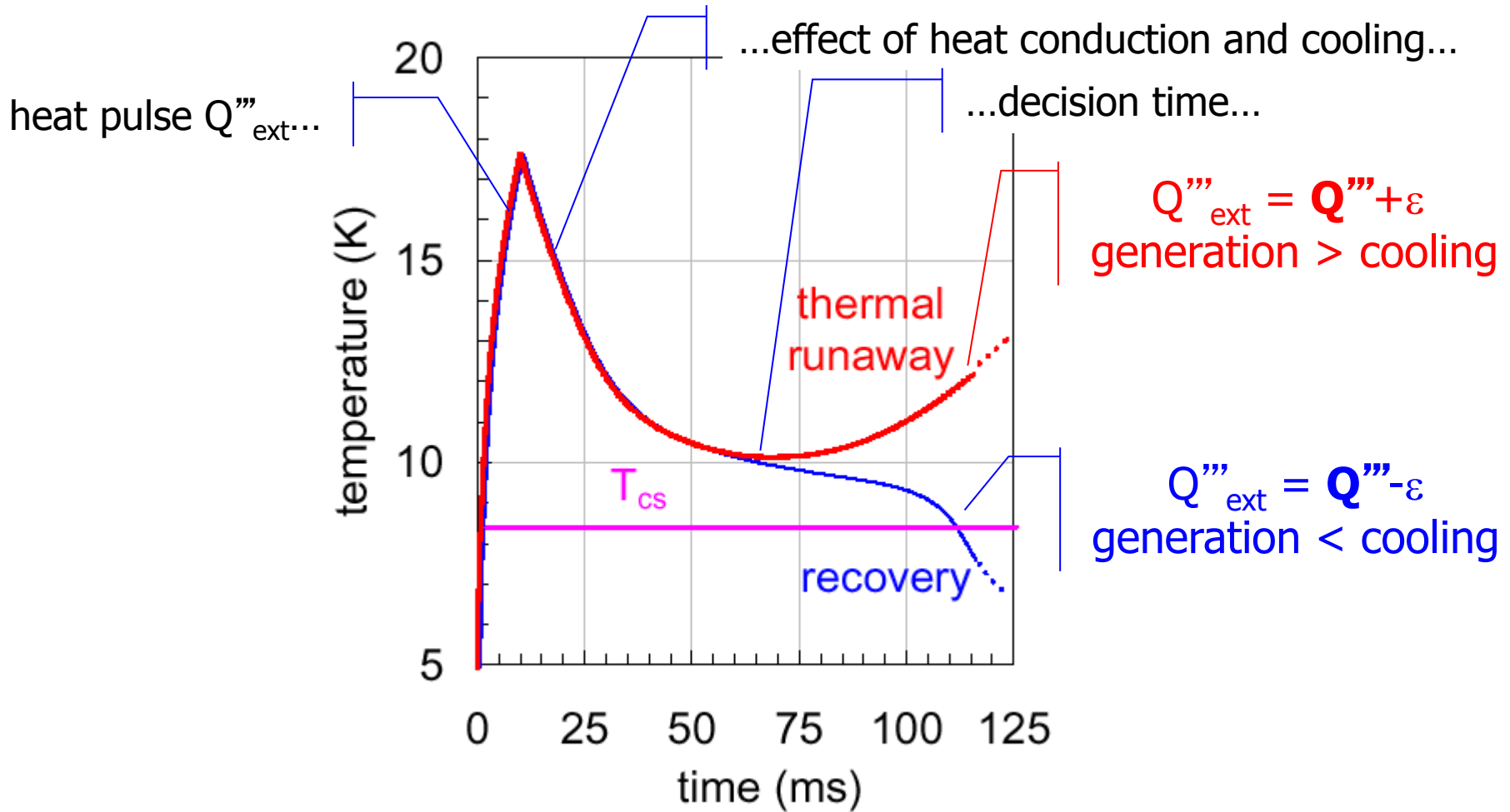



# Energy margin...

---

- $Q''''$ , energy margin
  - Minimum energy density that leads to a quench
  - Maximum energy density that can be tolerated by a superconductor, still resulting in recovery
    - Simple and experimentally measurable quantity (...)
    - Measured in [mJ/cm<sup>3</sup>] for convenience (values  $\approx 1...1000$ )
    - Also called *stability margin*
    - Compared to the energy spectrum to achieve stable design
- $Q$ , quench energy
  - Better adapted for disturbances of limited space extension
  - Measured in [ $\mu$ J] to [mJ]

# ... and other useful margins

*typical NbTi*

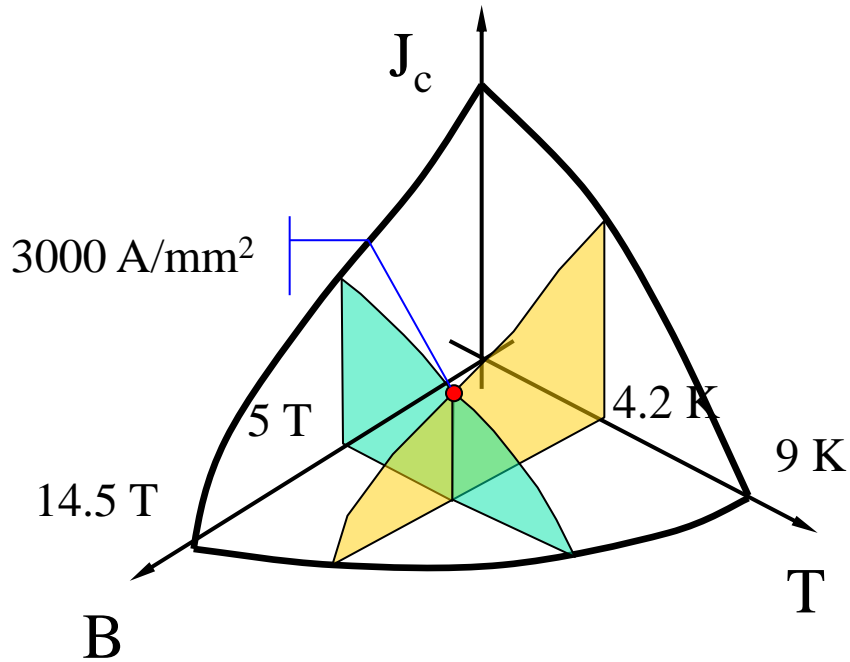

$$J_{op}/J_c \approx 0.5$$

$$B_{op}/B_{max} \approx 0.8 \text{ (Todesco's 80 \%)}$$

$$T_{cs} - T_{op} \approx 1...2 \text{ K}$$

operating plane

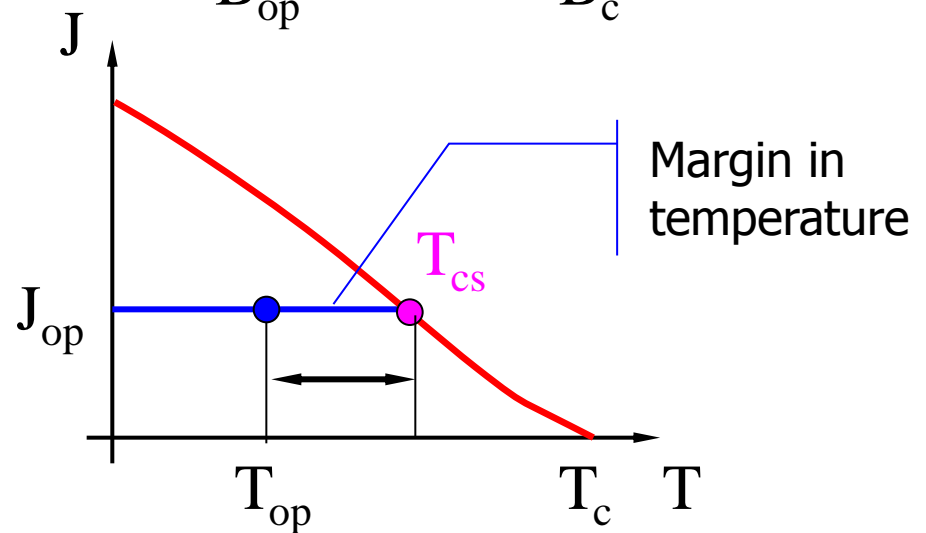
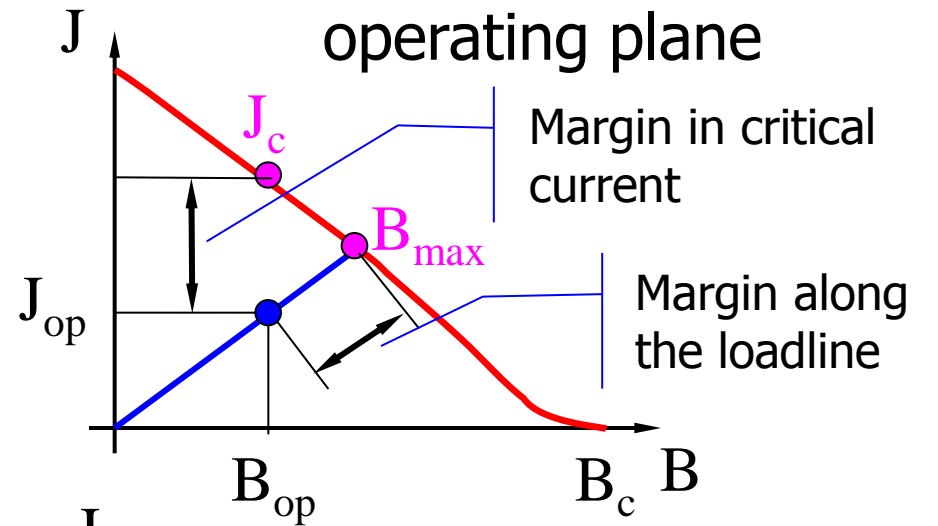

# A measured *stability transient*

(LHC dipole magnet training)

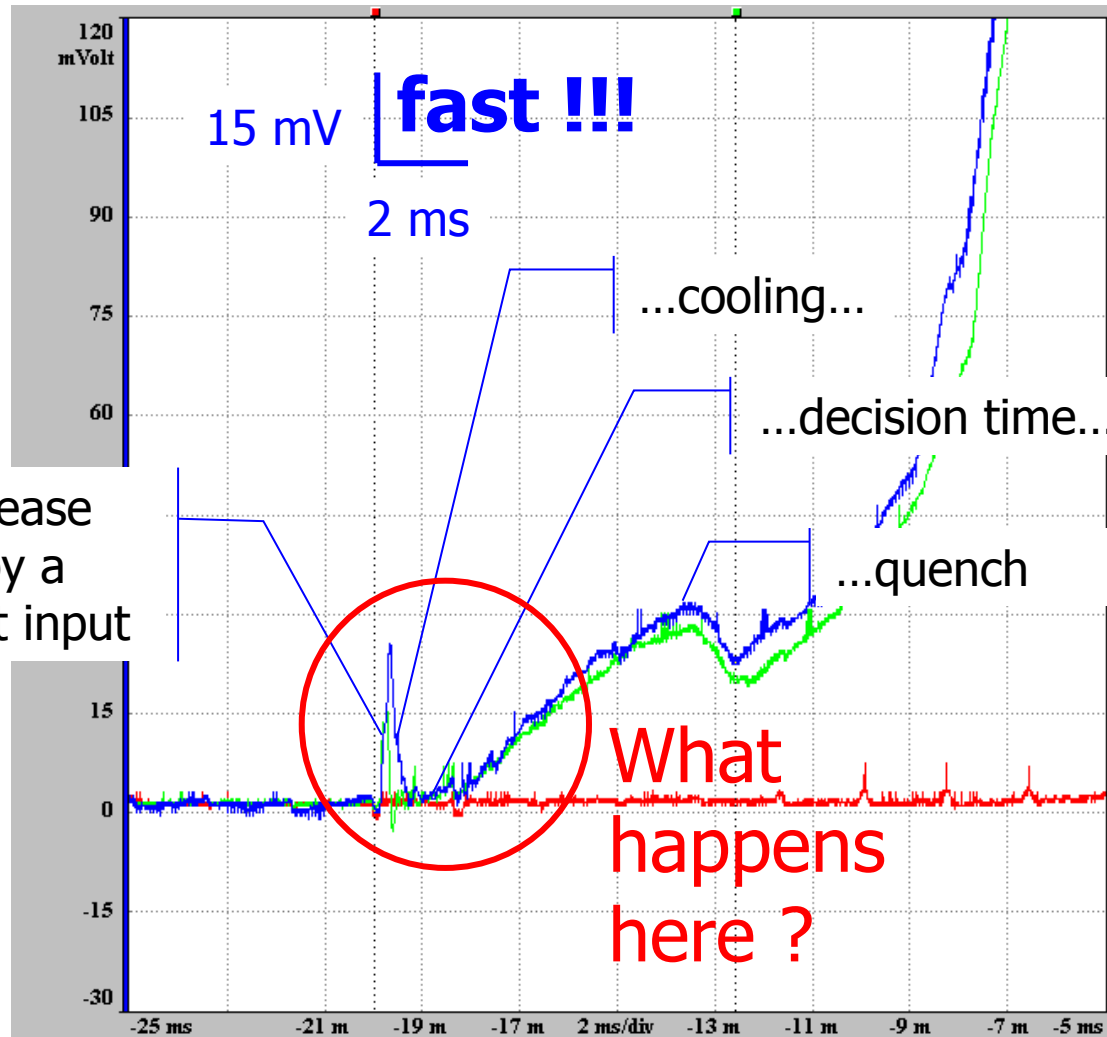

Voltage increase generated by a sudden heat input

What happens here ?

# Current sharing

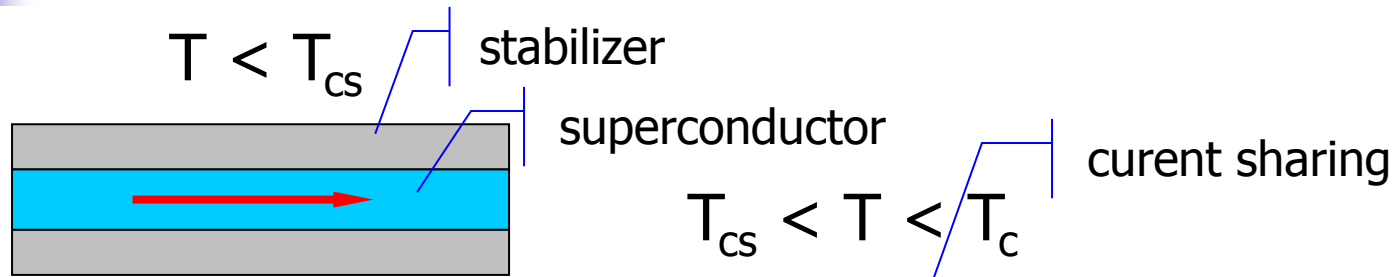

$$E_{sc} = E_{st} = 0$$

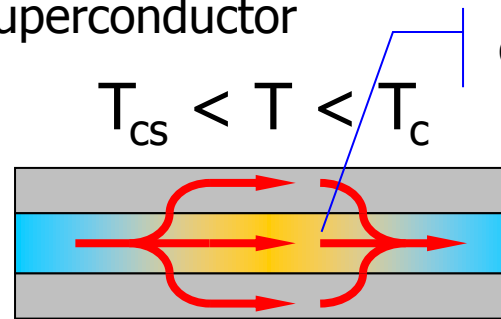

$$E_{sc} = E_{st} = I_{st} \frac{h_{st}}{A_{st}}$$

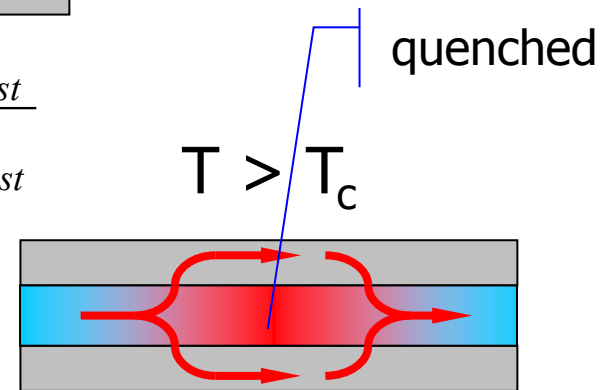
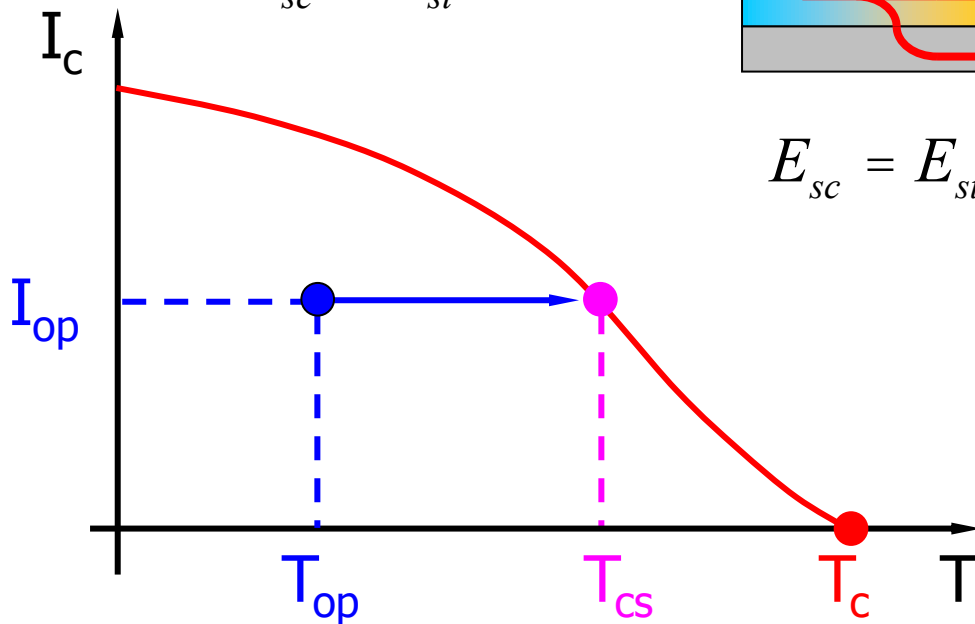

$$E_{sc} = E_{st} = I_{op} \frac{h_{st}}{A_{st}}$$

# Joule heating

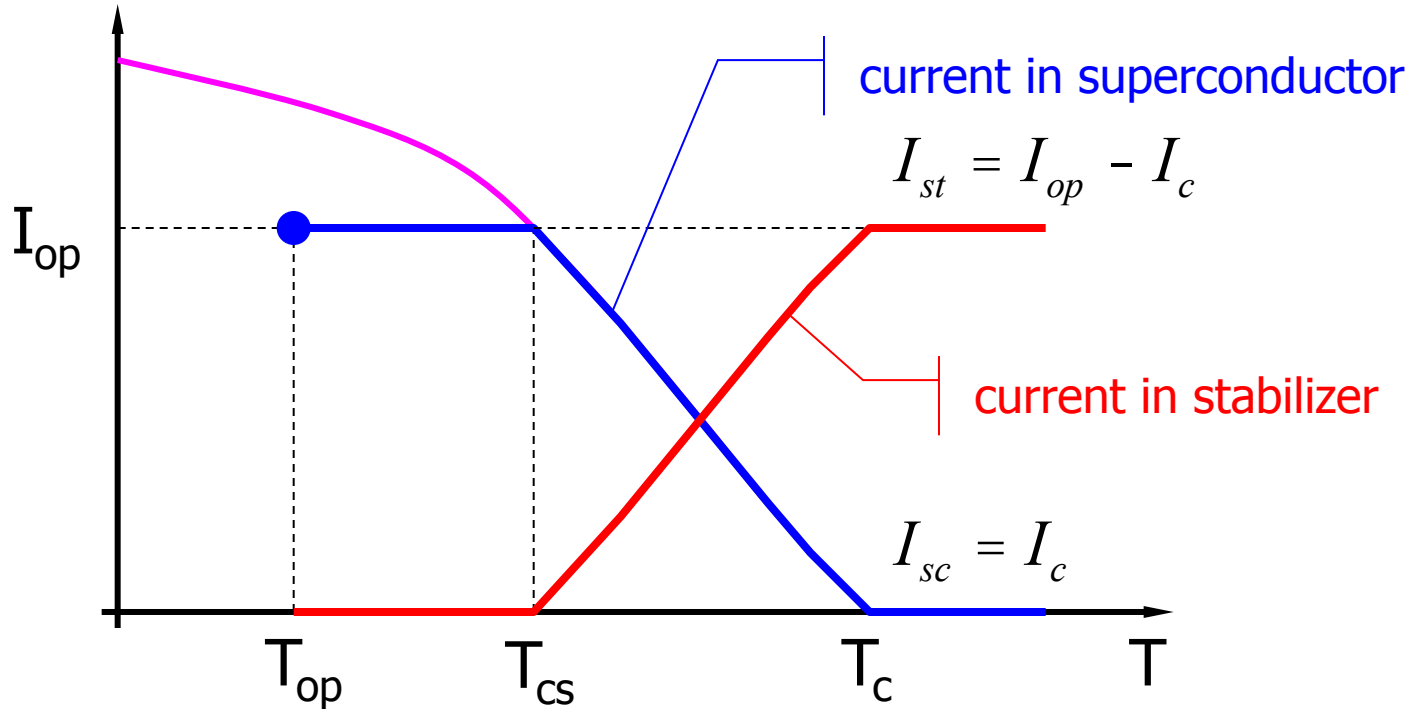

$$q_{\mathcal{J}} = \frac{EI_{st} + EI_{sc}}{A} = \frac{EI_{op}}{A} = \frac{h_{st}}{A_{st}} \frac{I_{op} (I_{op} - I_c)}{A}$$

$$q_{\mathcal{J} \max} = \frac{h_{st}}{A_{st}} \frac{I_{op}^2}{A}$$



# Joule heating (cont' d)

- Linear approximation for  $I_c(T)$ :  $I_c \gg I_{op} \frac{T_c - T}{T_c - T_{cs}}$

- Joule heating

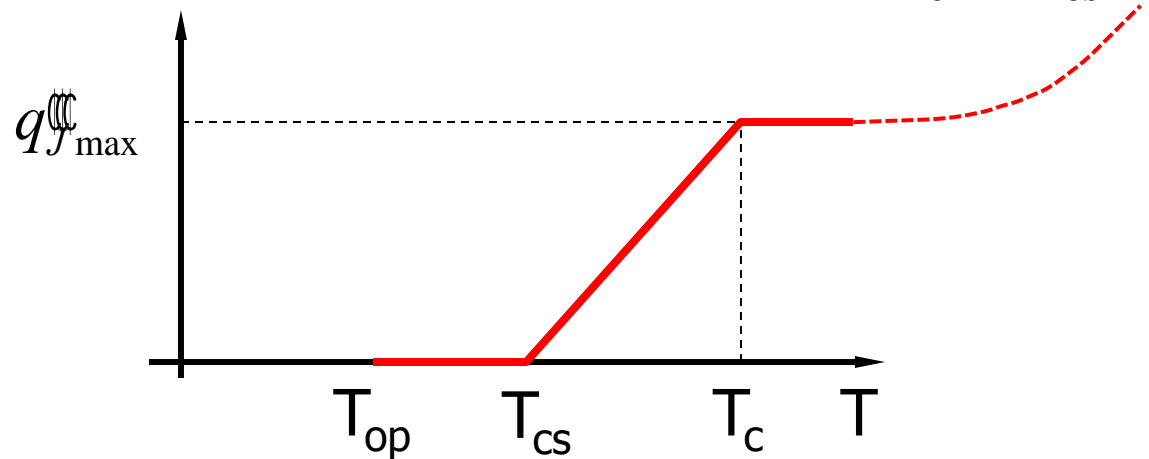

$$q_{J_{max}} = \begin{cases} 0 & \text{for } T < T_{cs} \\ q_{J_{max}} \frac{T - T_{cs}}{T_c - T_{op}} & \text{for } T_{cs} < T < T_c \\ q_{J_{max}} & \text{for } T > T_c \end{cases}$$

$$\begin{aligned} & \text{for } T < T_{cs} \\ & \text{for } T_{cs} < T < T_c \\ & \text{for } T > T_c \end{aligned}$$

$$q_{J_{max}} = \frac{h_{st}}{A_{st}} \frac{I_{op}^2}{A}$$



# Cooling: many options

---

- Indirect: (adiabatic, no cooling)
  - Contact to a heat sink through conduction (e.g. to a cryo-cooler)
  - In practice, no cooling on the time scale of interest for stability
- Direct: (cooling by heat transfer at the surface)
  - Bath cooling, to a pool of liquid helium at atmospheric pressure and saturation temperature (4.2 K)
  - Force-flow cooling to a supercritical or two-phase flow
  - Superfluid cooling to a stagnant bath of He-II



# Plan of the lecture

---

- Training and degradation
- Perturbation spectrum overview
- Heat balance
- **Stabilization strategies and criteria**
- A summary and more complex topics

# Adiabatic stability

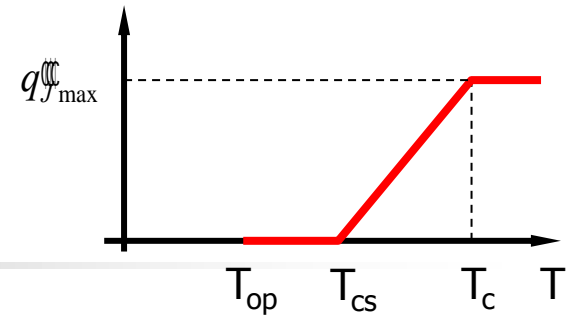

## ■ Adiabatic conditions:

- No cooling (dry or impregnated windings)
- Energy perturbation over large volume (no conduction)

$$C \frac{dT}{dt} = q'''_{ext} + \cancel{q'''_{cool}} + \cancel{\frac{w}{x} \frac{dT}{dt}} - \frac{wh}{A} (T - T_{he})$$

## ■ Stable only if $q'''_{Joule} = 0$ ( $T \leq T_{cs}$ ) !

energy margin

$$\int_0^{T_{cs}} q'''_{ext} dt = \int_{T_{op}}^{T_{cs}} C dT$$

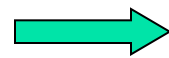

$$Q''' = H(T_{cs}) - H(T_{op})$$

volumetric enthalpy

$$H(T) = \int_0^T C(T) dT$$

# Specific enthalpy

$$H(T) = \int_0^T C(T) dT$$

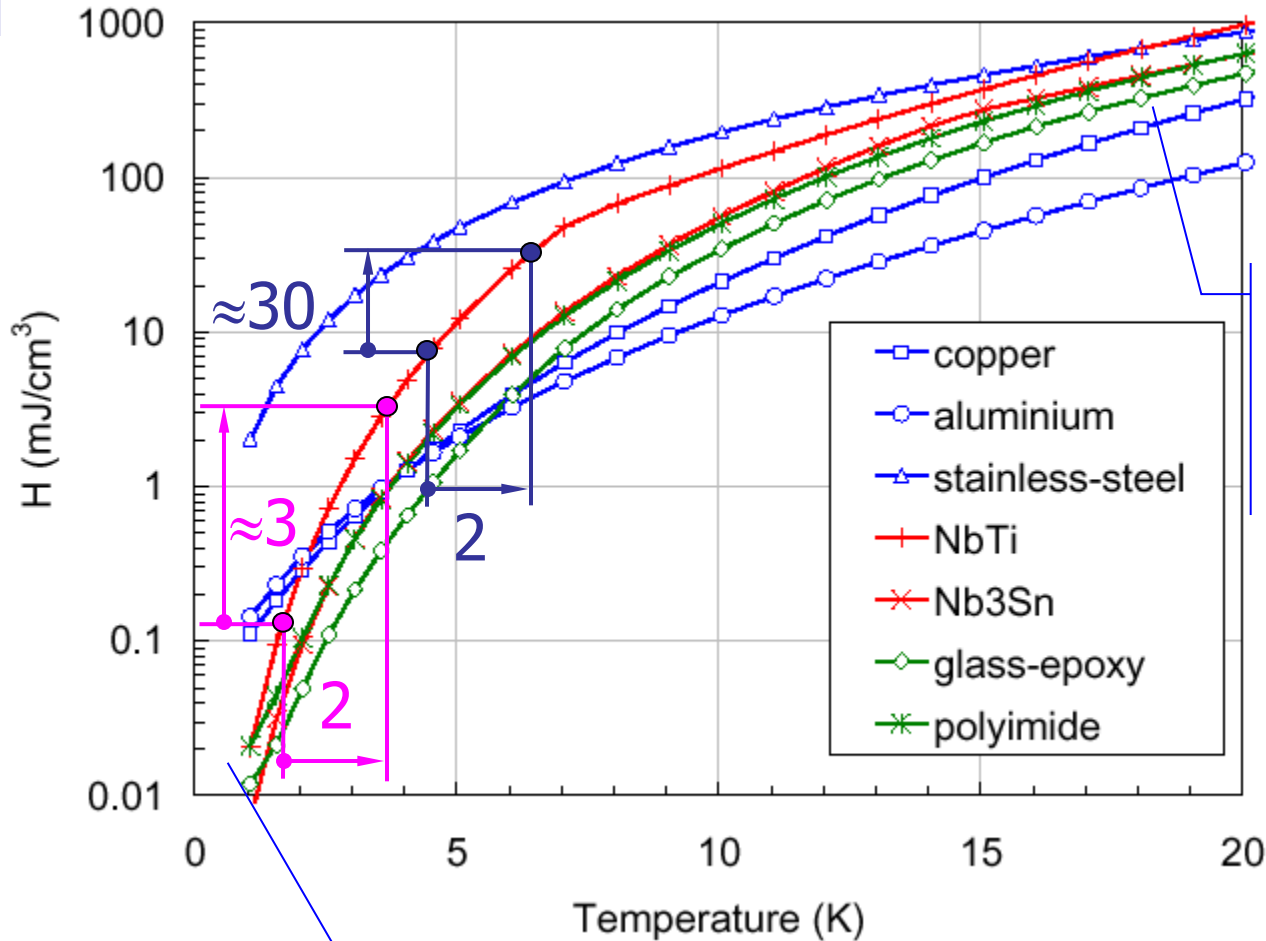

*enthalpy reserve*  
increases at  
increasing T  
(Note: HTS !)

do not sub-cool !  
(if you can only avoid it...)



# Adiabatic stability re-cap

---

- Applies to:
  - Adiabatic, compact, **high current density** windings (*dry* or indirectly cooled)
  - Very fast heat perturbations (flux-jumps)
- The heat capacity of the conductor absorbs the external heat perturbation
- Stability (at equal temperature margin) improves as the temperature increases (**HTS !**)
- Choose materials with high heat capacity (**e.g. loading of epoxy**)
- **Relatively small energy margin: 1...10 mJ/cm<sup>3</sup>**

# Cryostability

- Cooling in a bath of pool boiling helium
  - Ignore conduction for large energy perturbations volumes
  - Request steady state stability in all conditions

$$\cancel{C \frac{dT}{dt}} = \cancel{q_{\text{rest}}} + q_J + \cancel{\frac{I^2 R}{A}} - \frac{wh}{A} (T - T_{he})$$

$$q_J \in \frac{wh}{A} (T - T_{op})$$

worst possible case

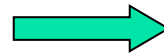

$$\frac{h_{st}}{wA_{st}} I_{op}^2 \in h (T_c - T_{op})$$

cooling

generation

# Heat balance (*ideal case*)

constant heat transfer to the helium

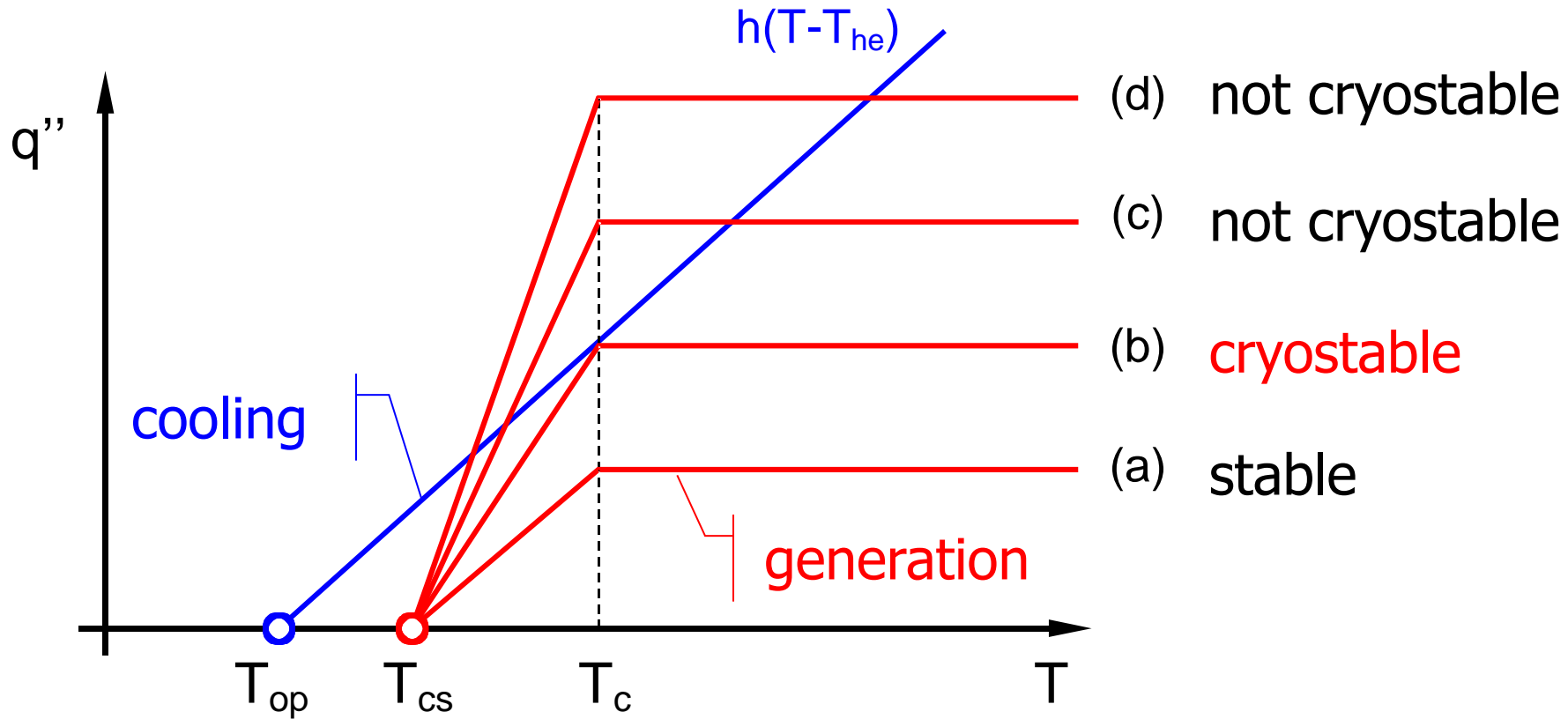



# Stekly- $\alpha$

- Stekly cryostability condition:

$$\frac{h_{st}}{wA_{st}} I_{op}^2 \leq h(T_c - T_{op})$$

- can be formulated as  $\alpha_{Stekly} \leq 1$  :

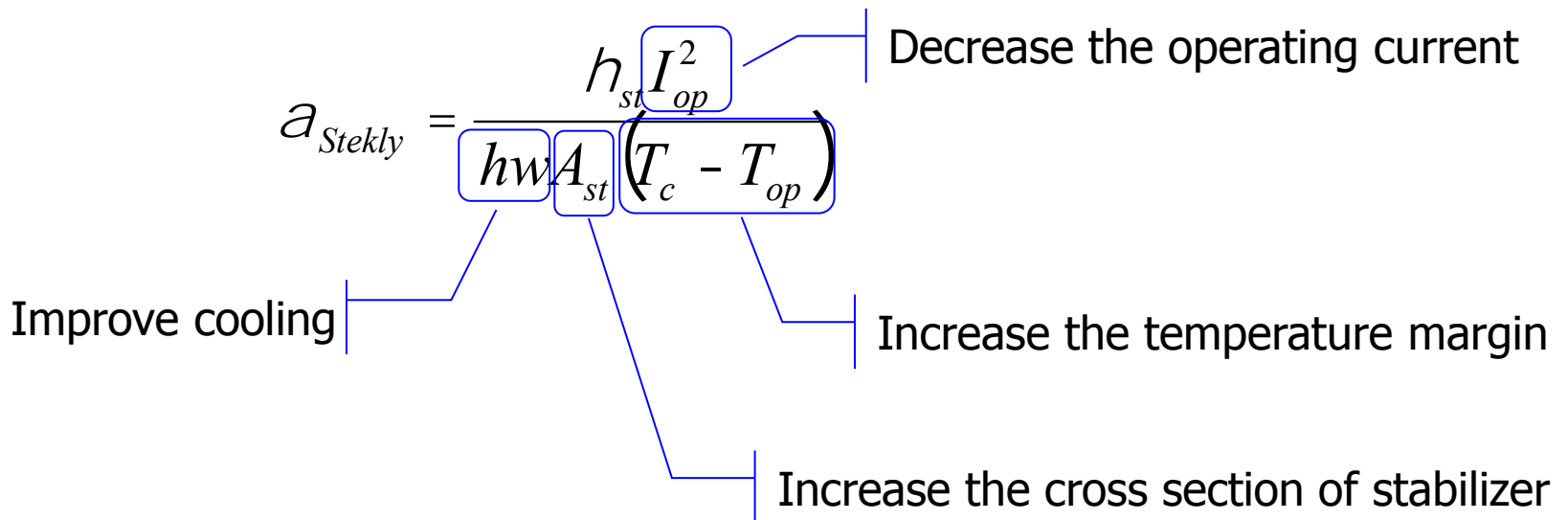



# Cryo-stability recap

---

- Applies to:
  - Well-cooled, **low current density** windings (pool-boiling)
  - Any type of heat perturbations, all time and space scales
- The coolant can take the Joule heating under all possible conditions
- **Ideally infinite energy margin**

# Cold-end effects – 1

- Assume that the normal zone is *long* and above cryostable operating conditions
- The temperature will reach an *equilibrium* temperature

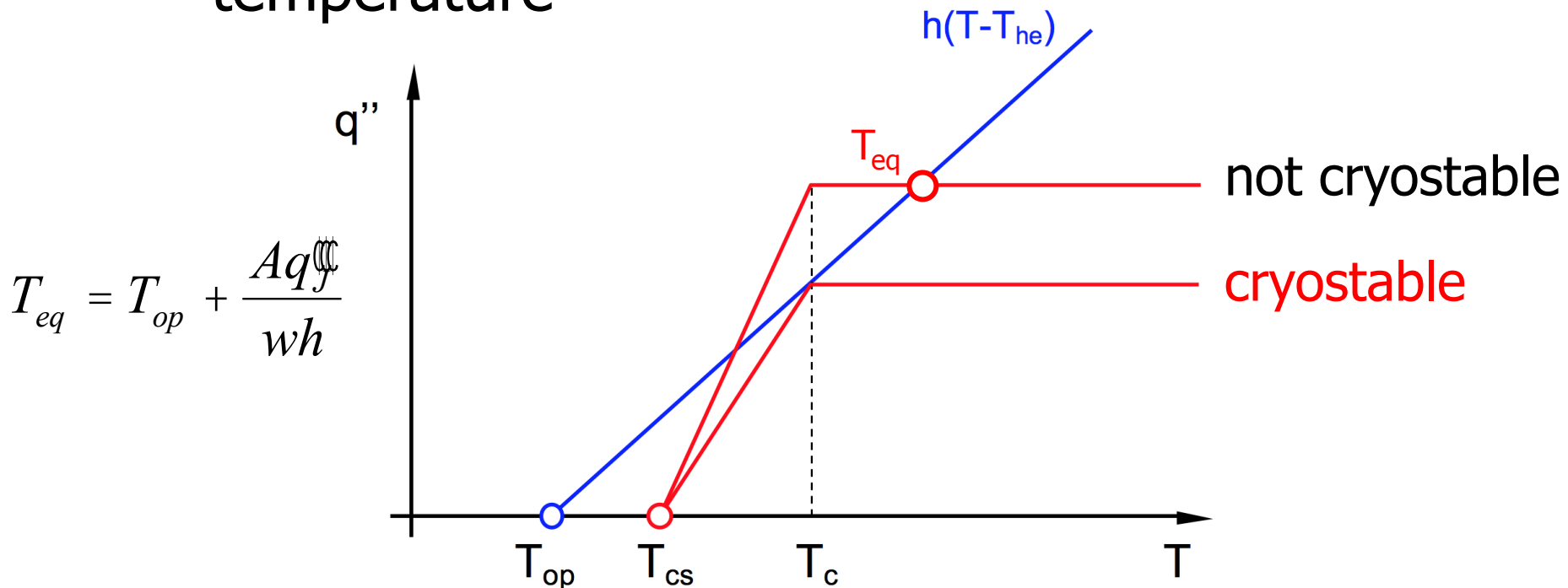

# Cold-end effects – 2

- What happens if the ends are *cold*?

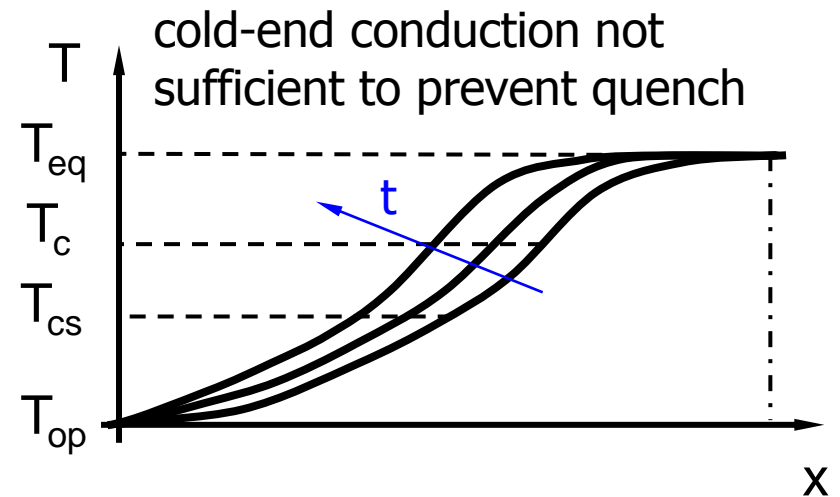
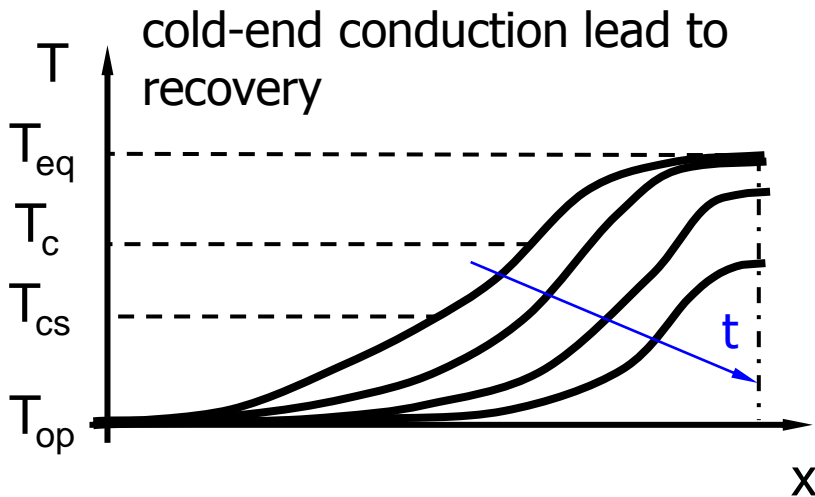

- Request steady state stability in all conditions

~~$$C \frac{\partial T}{\partial t} = q_{ext} + q_{gen} + \frac{\partial}{\partial x} \left( k \frac{\partial T}{\partial x} \right) - \frac{wh}{A} (T - T_{he})$$~~

# Cold-end effects – 3

- introduce a new variable  $S$ :  $S = k \frac{dT}{dx}$

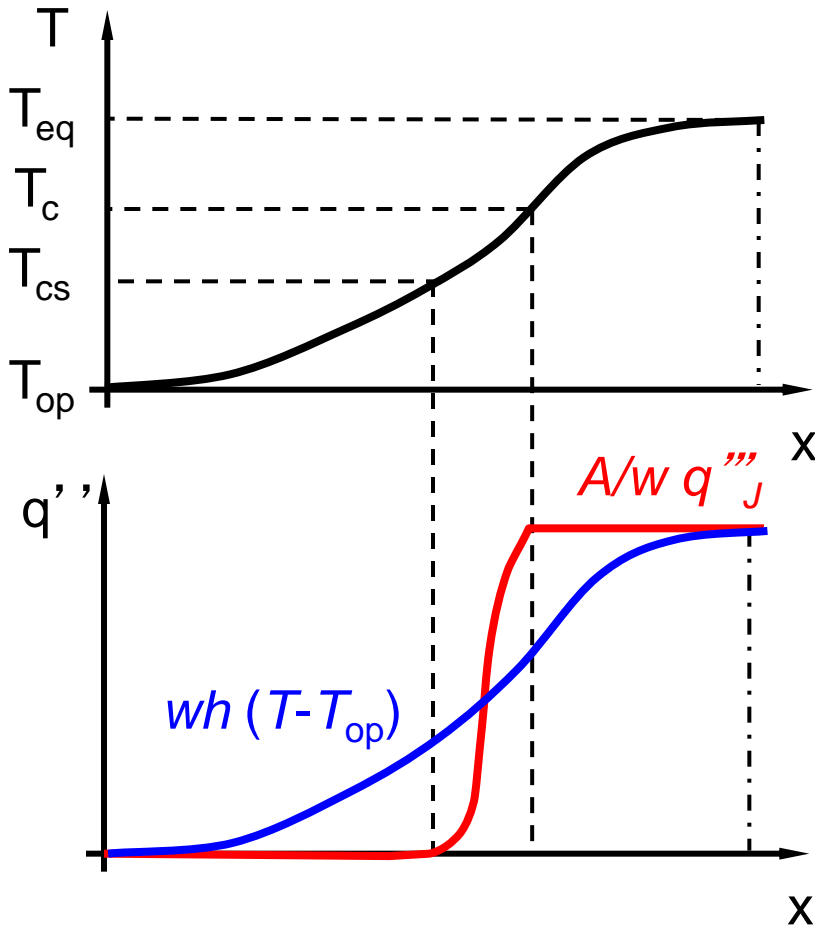

$$k \frac{d}{dx} \left( \frac{wh}{A} (T - T_{he}) - q'' \right) = S \frac{dS}{dT}$$

$$\int_{T_{op}}^{T_{eq}} k \frac{d}{dx} \left( \frac{wh}{A} (T - T_{he}) - q'' \right) dT = \int_{S_{op}}^{S_{eq}} S dS$$

$S_{op} = 0 \quad \downarrow \quad S_{eq} = 0$

$$\int_{T_{op}}^{T_{eq}} \frac{d}{dx} \left( \frac{wh}{A} (T - T_{he}) - \frac{A}{w} q'' \right) dT = 0$$

# An equal area theorem

$$\int_{T_{op}}^{T_{eq}} h(T - T_{he}) - \frac{A}{w} q'' dT = 0$$

Stable conditions are obtained when the net area between generation and cooling curves is zero

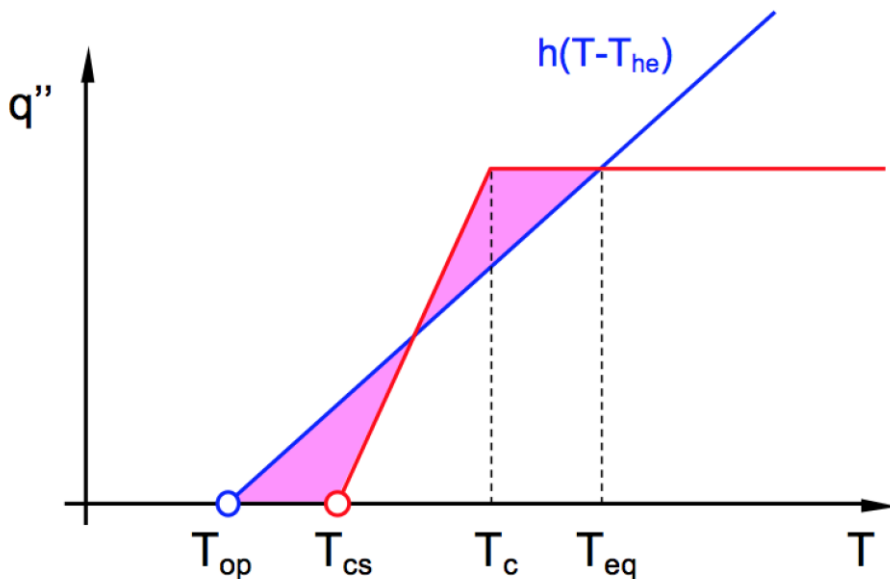

$$\alpha \approx 1 + \frac{(T_{cs} - T_{op})}{(T_c - T_{op})} \gg 2 - f_{op}$$

Values of  $\alpha$  nearly twice as large as from the Stekly criterion are possible !

Stekly:  $\alpha \leq 1$

Maddock:  $\alpha \leq 2 - f_{op}$



# Cold-end effects recap

---

- Applies to:
  - Well-cooled, **low current density** windings (pool-boiling)
  - Any type of heat perturbations, all time and space scales
- The coolant and the cold ends take the Joule heating under all possible conditions
- **Ideally infinite energy margin**
- Improved stability with respect to the cryostability condition, allow operation at higher current



# Meta-stable conductors

---

- Adiabatically stabilized conductors:
  - High  $J_{op}$  (good for cost)
  - Small  $Q'''$  (bad for large magnets)
- Cryo-stabilized conductors (including cold-ends):
  - Large  $Q'''$ , ideally infinite (good for large magnets)
  - Low  $J_{op}$  (bad for cost)

**Is there a compromise ?**



# Idea-1: helium !

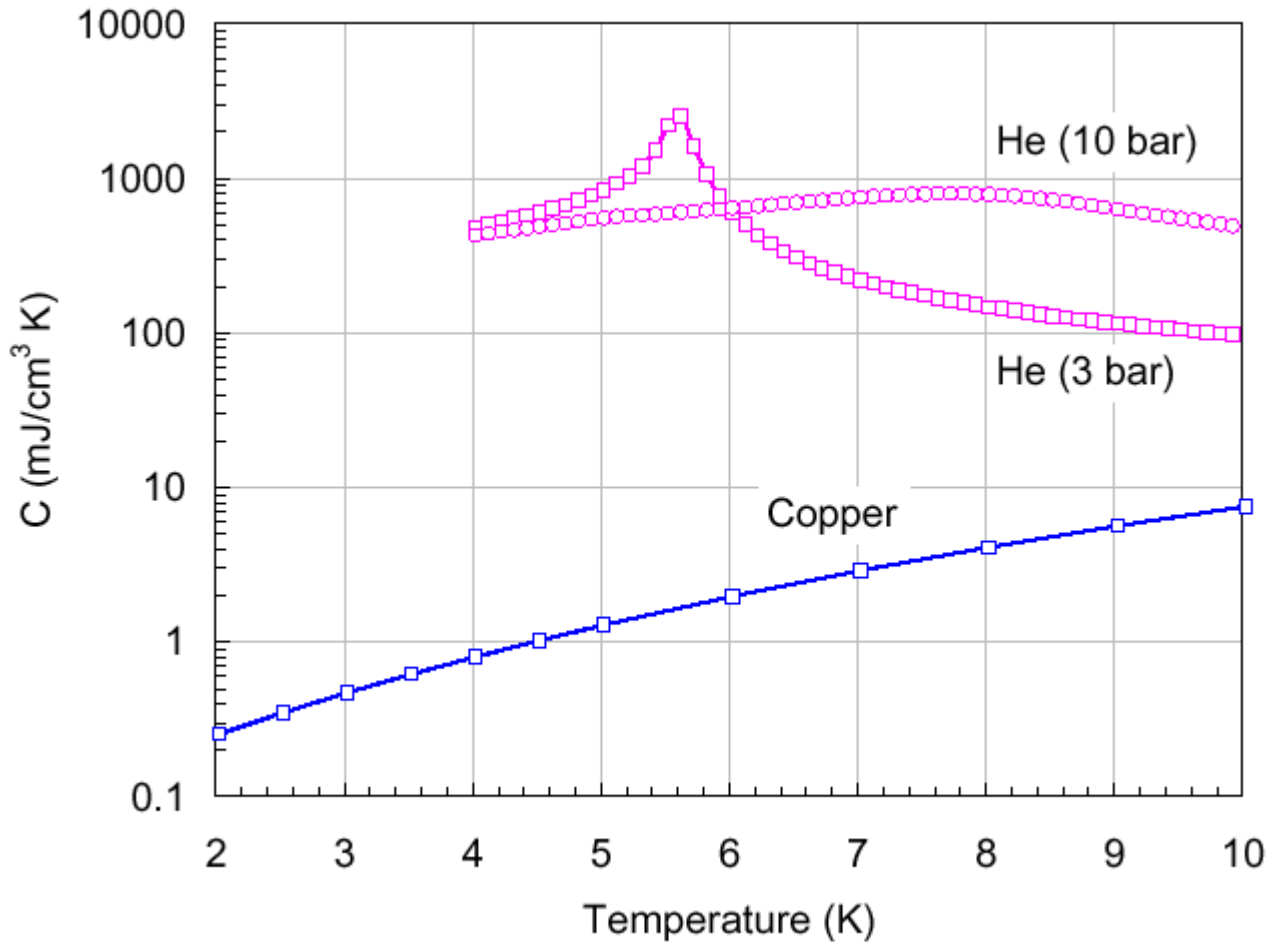

The helium heat capacity is orders of magnitude larger than for metals at low temperature

Add helium in intimate contact with the cable

# ICS' s and CICC' s

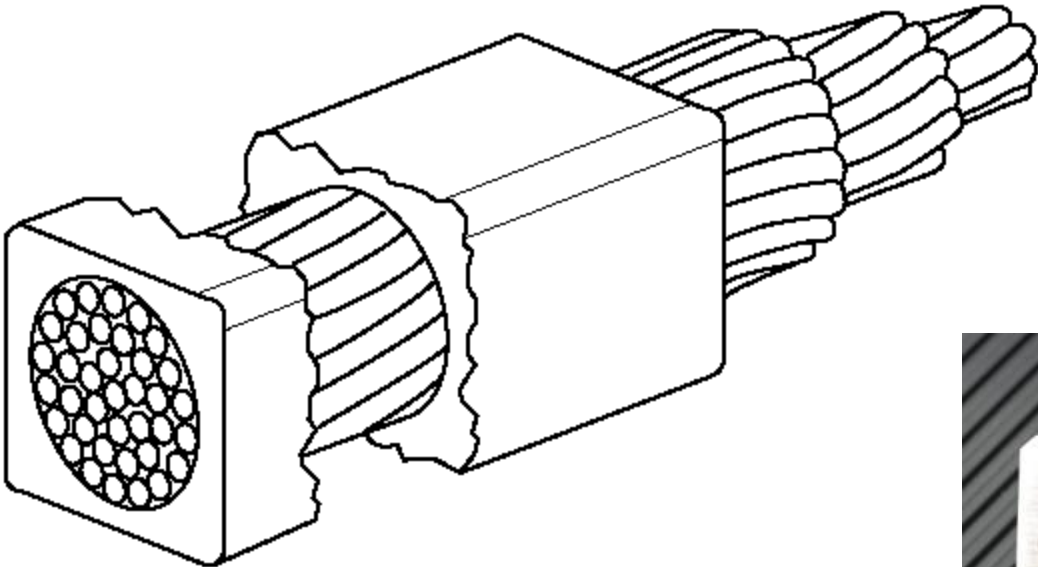

ROUND BUNDLE WITH 37 STRANDS ENCLOSED IN RECT  
CONDUIT - SHOWING TRANSPOSITION OF STRAN

# Heat balance for CICC's

- Conductor temperature:

$$C \frac{dT}{dt} = q_{ext} + q_J + \frac{\rho_c}{\rho} k \frac{dT}{dx} - \frac{wh}{A} (T - T_{he})$$

- But the helium temperature evolves as well:

$$C_{he} \frac{dT_{he}}{dt} = \frac{wh}{A_{he}} (T - T_{he})$$

- Under which conditions the heat capacity is effectively used ?

**NOTE:** at large enough  $h$ ,  $T \approx T_{he}$

# Stability of CICC's

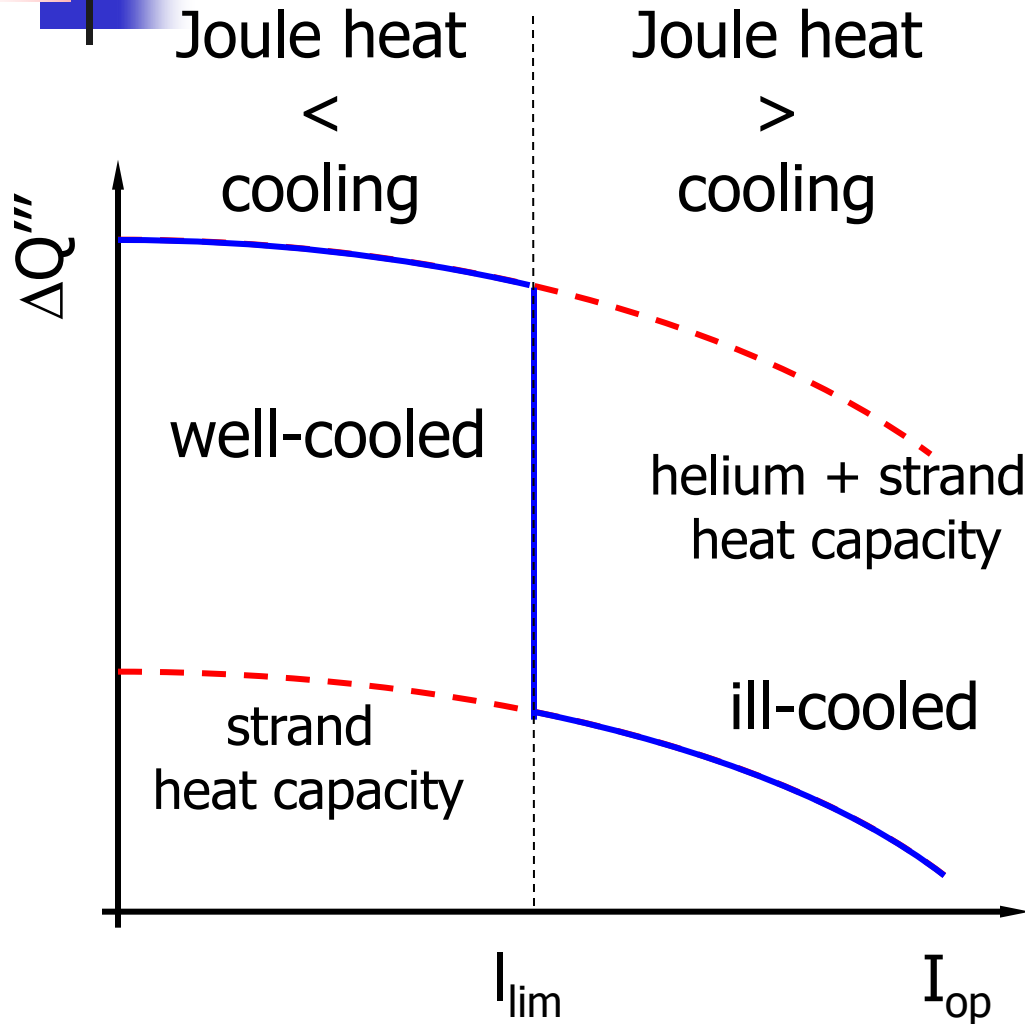

balance of Joule heat and cooling at:

$$I_{lim} = \sqrt{\frac{A_{st} w h (T_c - T_{op})}{h_{st}}}$$

equivalent to  $\alpha_{Stekly} = 1$

In this case however the CICC is **meta-stable** as a large enough energy input will cause a quench !

# Idea-2: heat conduction !

Short normal zone

$S=0$  at the boundaries

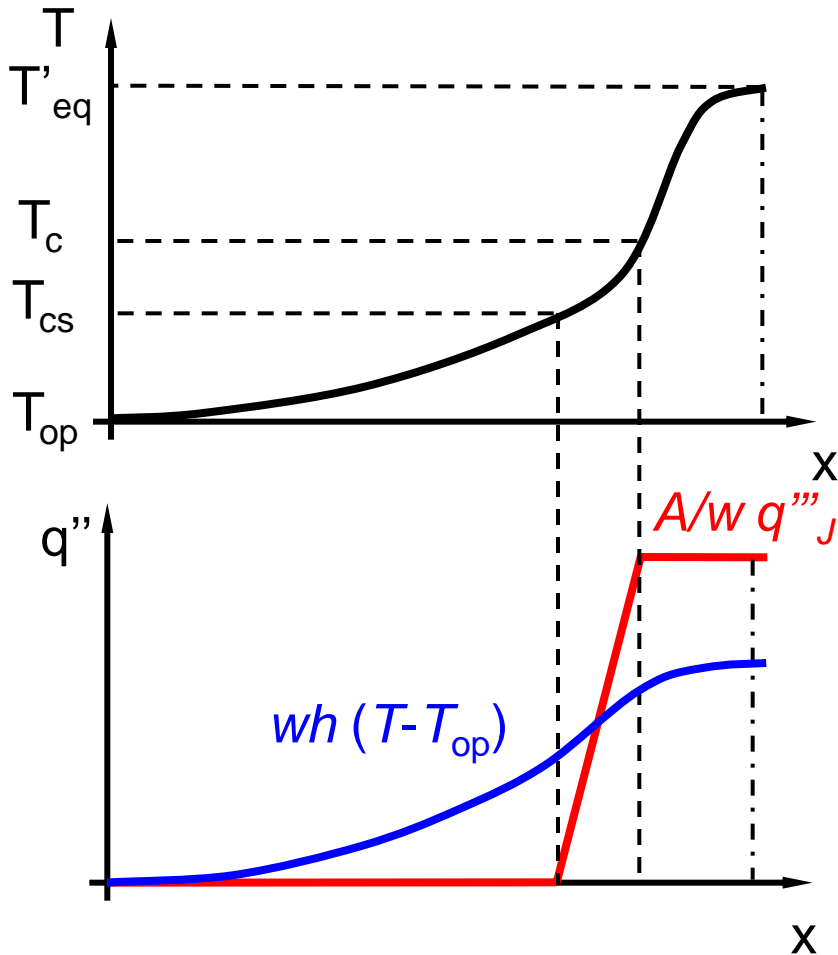

$$\int_{T_{op}}^{T_{eq}} h(T - T_{he}) - \frac{A}{w} q''_J dT = 0$$

*equal area* still possible  
but implies lower  $T'_{eq} < T_{eq}$

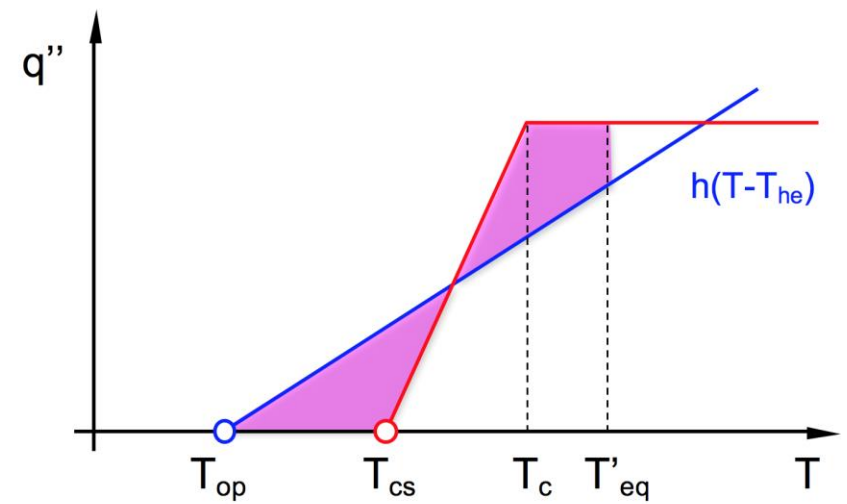

# Normal zone temperature

- The temperature profile can be traced by numerical integration of the *equal area* balance
- This is an unstable equilibrium temperature profile, and defines the minimum length of superconductor that could grow and develop into a quench:  
**Minimum Propagating Zone (MPZ)**
- The energy required to form the MPZ is the **Minimum Quench Energy (MQE)**

M.N. Wilson, Y. Iwasa, Cryogenics, 18, 17-25, 1978

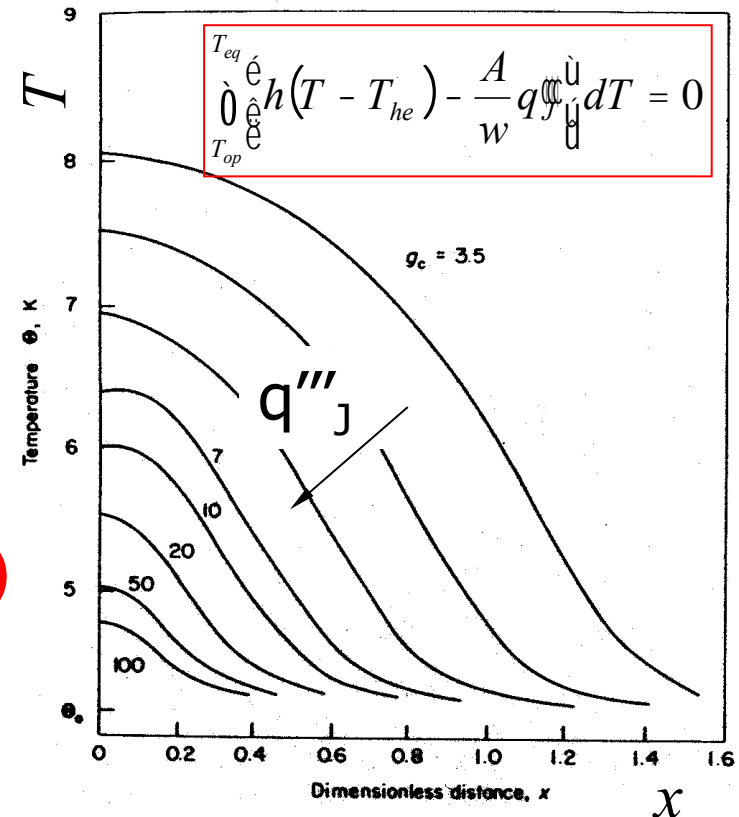

# MPZ estimates

- To estimate the size of the MPZ we can solve the heat balance approximately
  - Steady state conditions and no cooling

$$\cancel{C \frac{dT}{dt}} = \cancel{q_{ext}} + q_j + \frac{\eta}{\rho} \frac{d^2 T}{dx^2} - \frac{wh}{A} (T - T_{he})$$

$$0 = \bar{\eta}_{st} J_{op}^2 + \frac{d}{dx} \left( \bar{k} \frac{dT}{dx} \right)$$

$$0 \approx \bar{\eta}_{st} J_{op}^2 L_{MPZ} - \bar{k} \frac{(T_C - T_{op})}{L_{MPZ} / 2}$$

$$\begin{aligned}
 J_{op} &= 400 \text{ A/mm}^2 \\
 k &= 500 \text{ W/m K} \\
 \eta &= 1 \text{ n}\Omega \text{ m} \\
 T_C - T_{op} &= 2 \text{ K}
 \end{aligned}$$

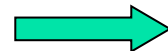

$$L_{MPZ} \approx \sqrt{\frac{2\bar{k} (T_C - T_{op})}{\bar{\eta}_{st} J_{op}^2}}$$

$$\begin{aligned}
 \text{MPZ} &\approx 3.5 \text{ mm} \\
 \text{MQE} &\approx 10 \mu\text{J}
 \end{aligned}$$



# Plan of the lecture

---

- Training and degradation
- Perturbation spectrum overview
- Heat balance
- Stabilization strategies and criteria
- **A summary and more complex topics**



# Summary

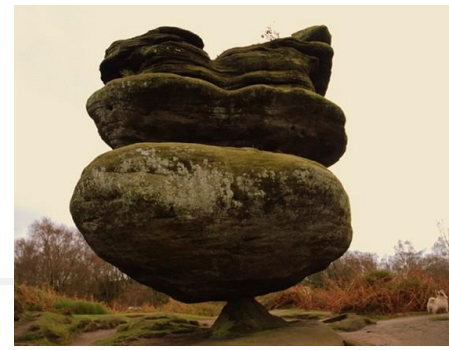

- Superconductor stability is the art of balancing large stored energies (and potential for energy release) with a little capital (aka: “leveraging” for our US colleagues)
  - Extremely important in LTS-based magnet to reach the desired performance (10 MJ vs 10 mJ)
  - Generally not an issue for HTS-based magnets
- Stability is not *absolute*, it implies **comparing the perturbation spectrum to the available margin**
- Several strategies can be applied to achieve stable operating conditions under the envelope of foreseeable perturbation spectrum

# A summary of strategies

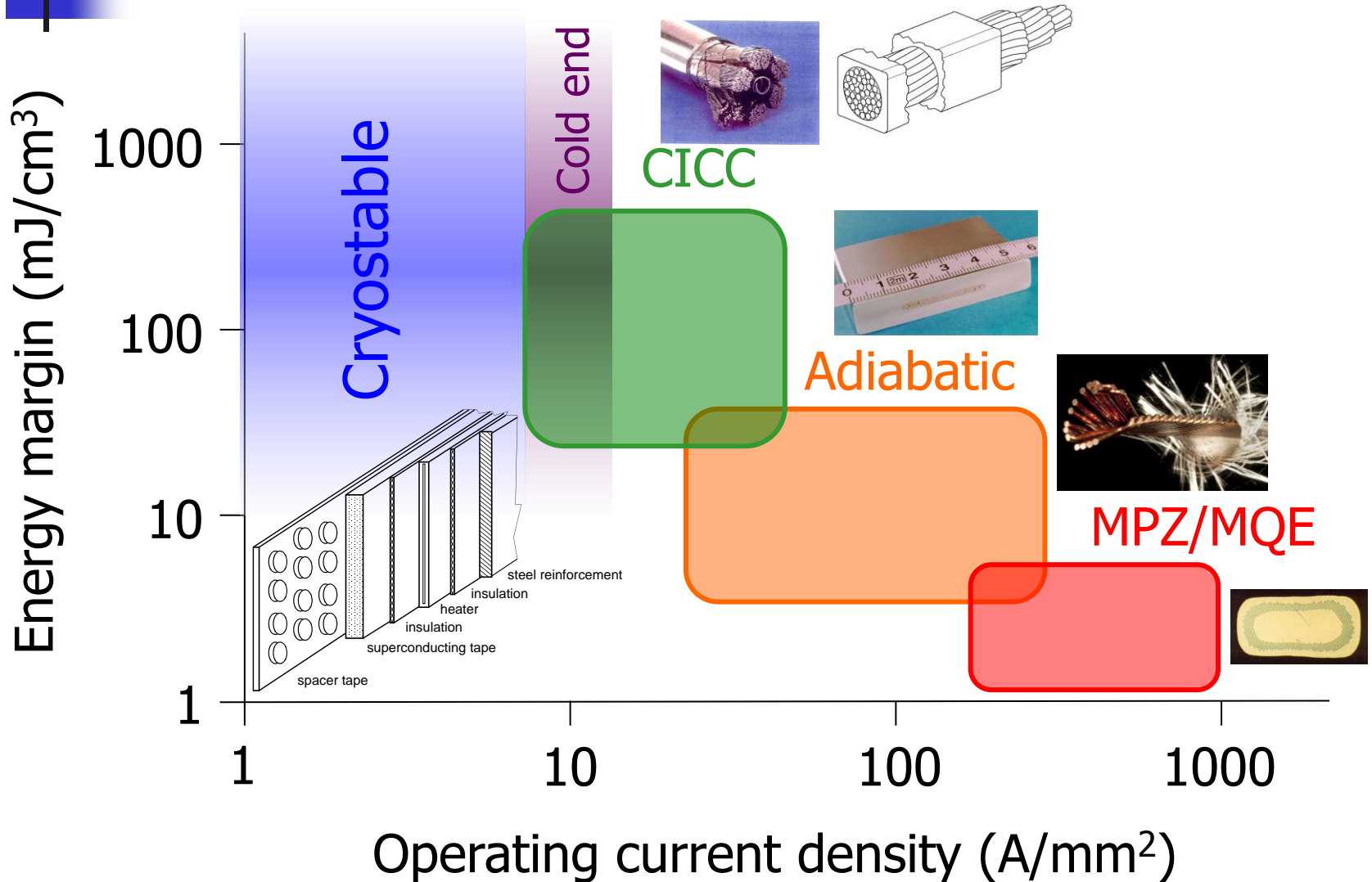

There are more things in heaven and earth,  
Horatio, Than are dreamt of in your philosophy.



# Advanced topics

- Current distribution and RRL
  - Ramp-rate quenches
  - Holding quenches
- Magneto-thermal instabilities
  - Dynamic stability
  - Self-field instability

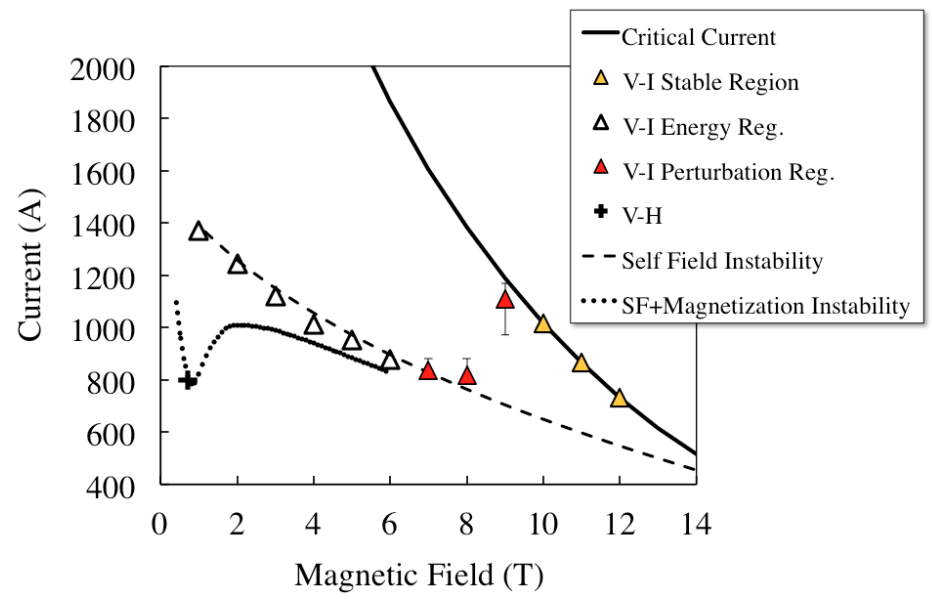
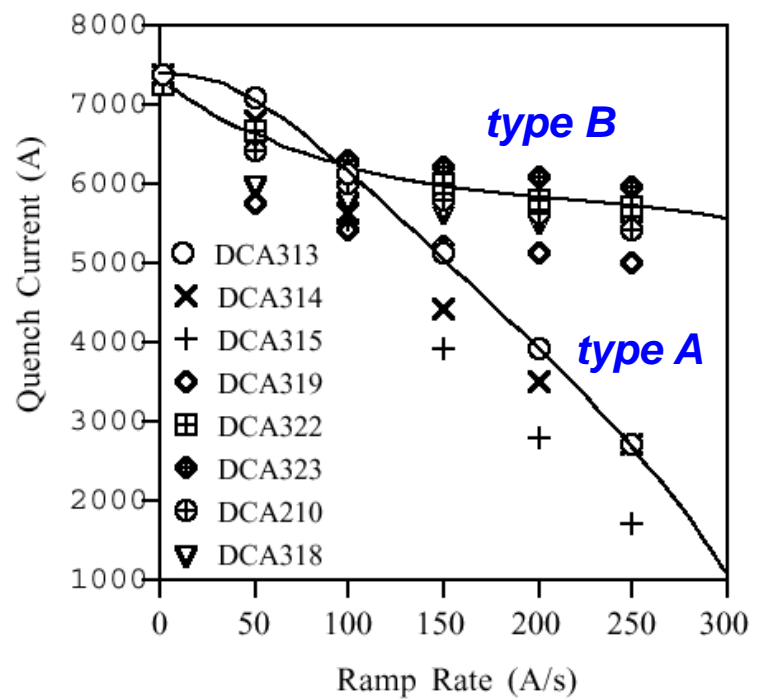

A. Devred, T. Ogitsu, *Frontiers of Accelerator Magnet Technology*, World Scientific, 184, 1996

B. Bordini and L. Rossi, *IEEE TAS*, 19, 2470 (2009).

Ah, and... what if it falls ???



Then, you need  
to **protect** !





# Where to find out more

---

- Papers, reviews and proceedings:
  - A.R. Krantowitz, Z.J.J. Stekly, *A New Principle for the Construction of Stabilized Superconducting Coils*, Applied Physics Letters, 6, 3, 56-57, 1965.
  - P.F. Chester, *Superconducting Magnets*, Rep. Prog. Phys., **XXX**, Part II, 561-614, 1967.
  - B.J. Maddock, G.B. James, W.T. Norris, *Superconductive Composites: Heat Transfer and Steady State Stabilization*, Cryogenics, 9, 261-273, 1969.
  - M.N. Wilson, Y. Iwasa, *Stability of Superconductors against Localized Disturbances of Limited Magnitude*, Cryogenics, 18, 17-25, 1978.
  - L. Dresner, *Superconductor Stability 1983: a Review*, Cryogenics, 24, 283, 1984.
- Books:
  - M.N. Wilson, *Superconducting Magnets*, Plenum Press, 1983.
  - L. Dresner, *Stability of Superconductors*, Plenum Press, 1995.
  - P.J. Lee ed., *Engineering Superconductivity*, J. Wiley & Sons, 2001.
  - B. Seeber ed., *Handbook of Applied Superconductivity*, IoP, 1998.
  - Y. Iwasa, *Case Studies in Superconducting Magnets*, Plenum Press, 1994.