

Flavour Physics in the LHC Era

Lecture 2 of 3

Tim Gershon
University of Warwick & CERN

SUSSP 2012

24th August 2012



Contents

- Part 1
 - Why is flavour physics interesting?
- Part 2
 - What do we know from previous experiments?
- Part 3
 - What do we hope to learn from current and future heavy flavour experiments?

Today hope to cover Part 2 & start Part 3

(but let's see how we go)

What do we know about heavy quark flavour physics as of today?

CKM Matrix : parametrizations

- Many different possible choices of 4 parameters
- PDG: 3 mixing angles and 1 phase

PRL 53 (1984) 1802

$$V = \begin{pmatrix} V_{ud} & V_{us} & V_{ub} \\ V_{cd} & V_{cs} & V_{cb} \\ V_{td} & V_{ts} & V_{tb} \end{pmatrix} = \begin{pmatrix} c_{12}c_{13} & s_{12}c_{13} & s_{13}e^{-i\delta} \\ -s_{12}c_{23} - c_{12}s_{23}s_{13}e^{i\delta} & c_{12}c_{23} - s_{12}s_{23}s_{13}e^{i\delta} & s_{23}c_{13} \\ s_{12}s_{23} - c_{12}c_{23}s_{13}e^{i\delta} & -c_{12}s_{23} - s_{12}c_{23}s_{13}e^{i\delta} & c_{23}c_{13} \end{pmatrix}$$

- Apparent hierarchy: $s_{12} \sim 0.2$, $s_{23} \sim 0.04$, $s_{13} \sim 0.004$

– [Wolfenstein parametrization](#) (expansion parameter $\lambda \sim \sin \theta_c \sim 0.22$)

PRL 51 (1983) 1945

$$V = \begin{pmatrix} 1 - \frac{1}{2}\lambda^2 & \lambda & A\lambda^3(\rho - i\eta) \\ -\lambda & 1 - \frac{1}{2}\lambda^2 & A\lambda^2 \\ A\lambda^3(1 - \rho - i\eta) & -A\lambda^2 & 1 \end{pmatrix} + \mathcal{O}(\lambda^4)$$

- Other choices, eg. based on CP violating phases

Hierarchy in quark mixing

$$V = \begin{pmatrix} 1 - \frac{1}{2}\lambda^2 & \lambda & A\lambda^3(\rho - i\eta) \\ -\lambda & 1 - \frac{1}{2}\lambda^2 & A\lambda^2 \\ A\lambda^3(1 - \rho - i\eta) & -A\lambda^2 & 1 \end{pmatrix} + \mathcal{O}(\lambda^4)$$

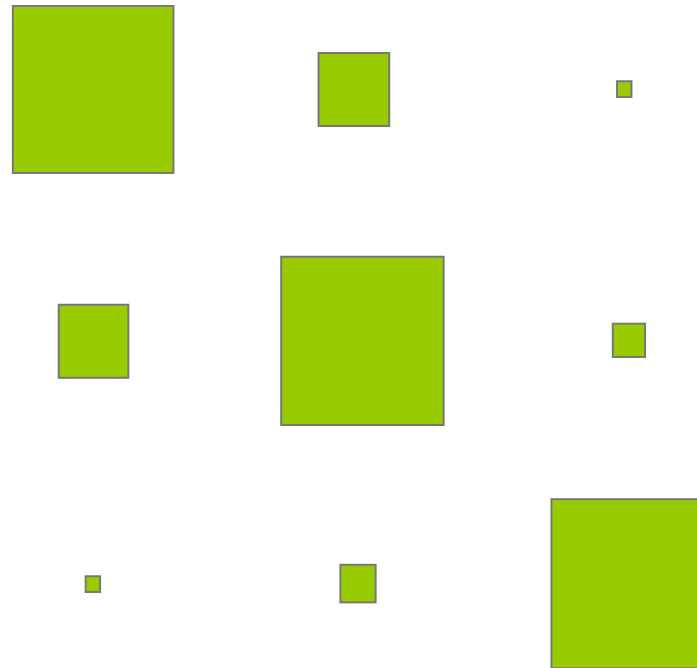

Very suggestive pattern
 No known underlying reason
 Situation for leptons (vs) is completely different

CKM matrix to $O(\lambda^5)$

$$V_{\text{CKM}} = \begin{pmatrix} 1 - \frac{1}{2}\lambda^2 - \frac{1}{8}\lambda^4 & \lambda & A\lambda^3(\rho - i\eta) \\ -\lambda + \frac{1}{2}A^2\lambda^5[1 - 2(\rho + i\eta)] & 1 - \frac{1}{2}\lambda^2 - \frac{1}{8}\lambda^4(1 + 4A^2) & A\lambda^2 \\ A\lambda^3[1 - (1 - \frac{1}{2}\lambda^2)(\rho + i\eta)] & -A\lambda^2 + \frac{1}{2}A\lambda^4[1 - 2(\rho + i\eta)] & 1 - \frac{1}{2}A^2\lambda^4 \end{pmatrix}$$

Diagram illustrating the CKM matrix elements and their imaginary parts:

- Red oval: $-\lambda + \frac{1}{2}A^2\lambda^5[1 - 2(\rho + i\eta)]$ (imaginary part at $O(\lambda^5)$)
- Blue oval: $A\lambda^3(\rho - i\eta)$ (imaginary part at $O(\lambda^3)$)
- Green oval: $-A\lambda^2 + \frac{1}{2}A\lambda^4[1 - 2(\rho + i\eta)]$ (imaginary part at $O(\lambda^4)$)
- Blue oval: $A\lambda^2$ (imaginary part at $O(\lambda^3)$)

Remember – only *relative* phases are observable

Unitarity Tests

- The CKM matrix must be unitary

$$V_{CKM}^+ V_{CKM} = V_{CKM} V_{CKM}^+ = 1$$

- Provides numerous tests of constraints between independent observables, such as

$$\begin{aligned} |V_{ud}|^2 + |V_{us}|^2 + |V_{ub}|^2 &= 1 \\ V_{ud} V_{ub}^* + V_{cd} V_{cb}^* + V_{td} V_{tb}^* &= 0 \end{aligned}$$

CKM Matrix – Magnitudes

PDG 2010

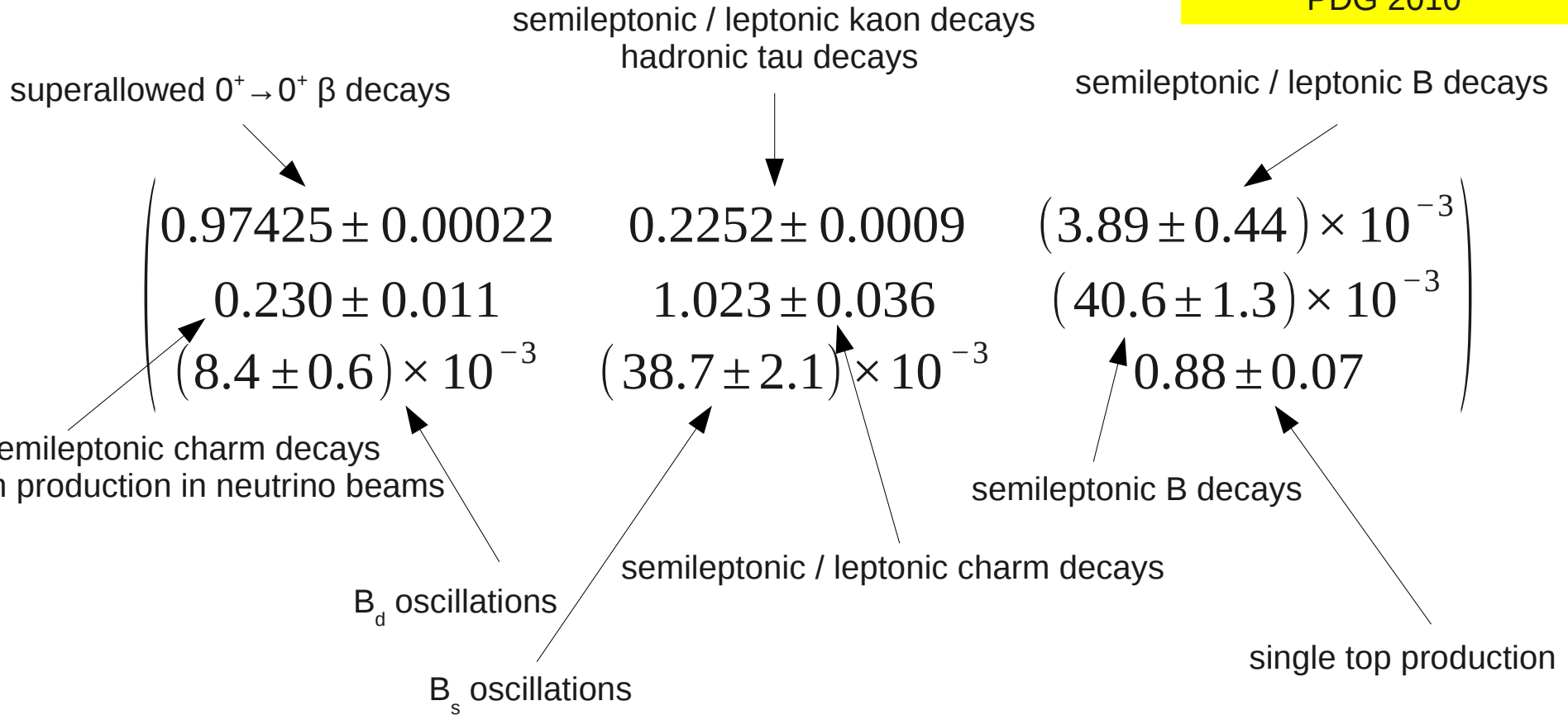

theory inputs (eg., lattice calculations) required

The Unitarity Triangle

$$V_{ud} V_{ub}^* + V_{cd} V_{cb}^* + V_{td} V_{tb}^* = 0$$



Three complex numbers add to zero
 \Rightarrow triangle in Argand plane

Axes are $\bar{\rho}$ and $\bar{\eta}$ where

$$\bar{\rho} + i\bar{\eta} \equiv -\frac{V_{ud}V_{ub}^*}{V_{cd}V_{cb}^*}$$

$$\rho + i\eta = \frac{\sqrt{1 - A^2\lambda^4}(\bar{\rho} + i\bar{\eta})}{\sqrt{1 - \lambda^2} [1 - A^2\lambda^4(\bar{\rho} + i\bar{\eta})]}$$

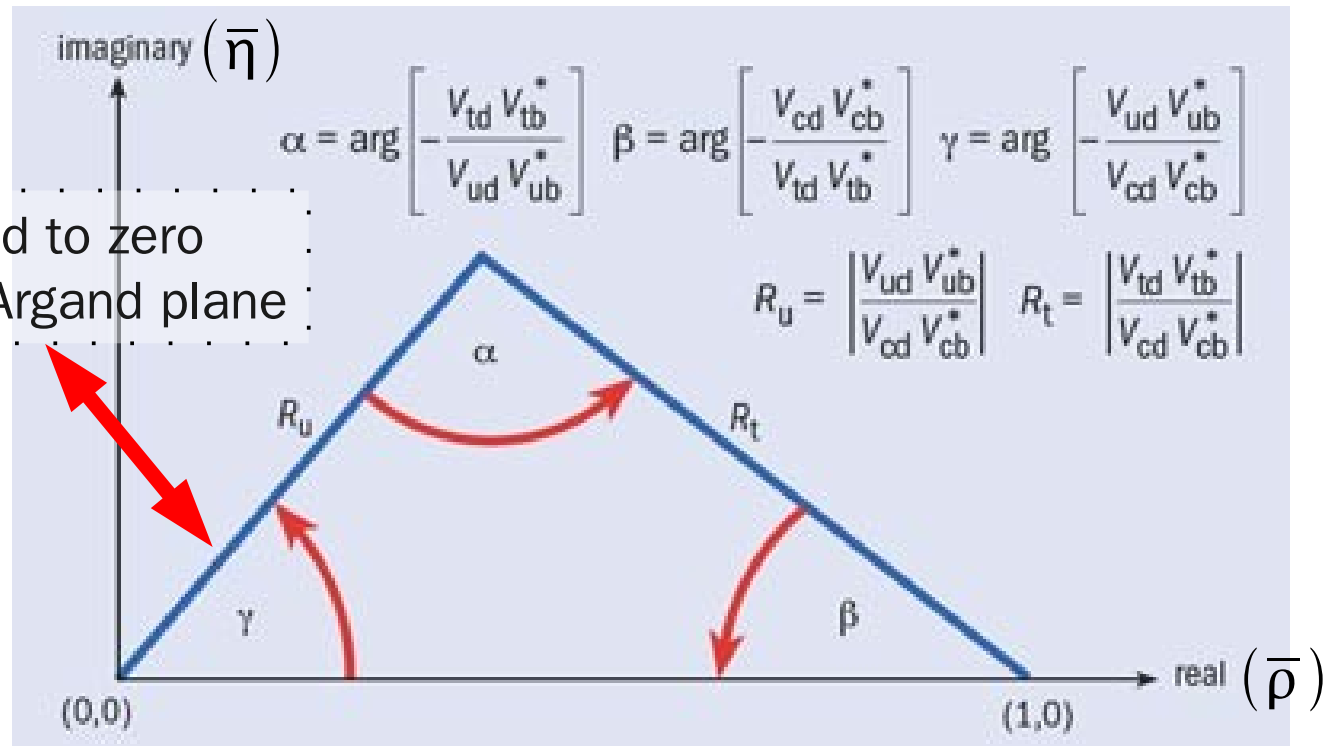

Predictive nature of KM mechanism

In the Standard Model the KM phase is the **sole origin of CP violation**

Hence:

all measurements must agree on the position of the apex of the Unitarity Triangle

(Illustration shown assumes no experimental or theoretical uncertainties)

EPJC 41 (2005) 1

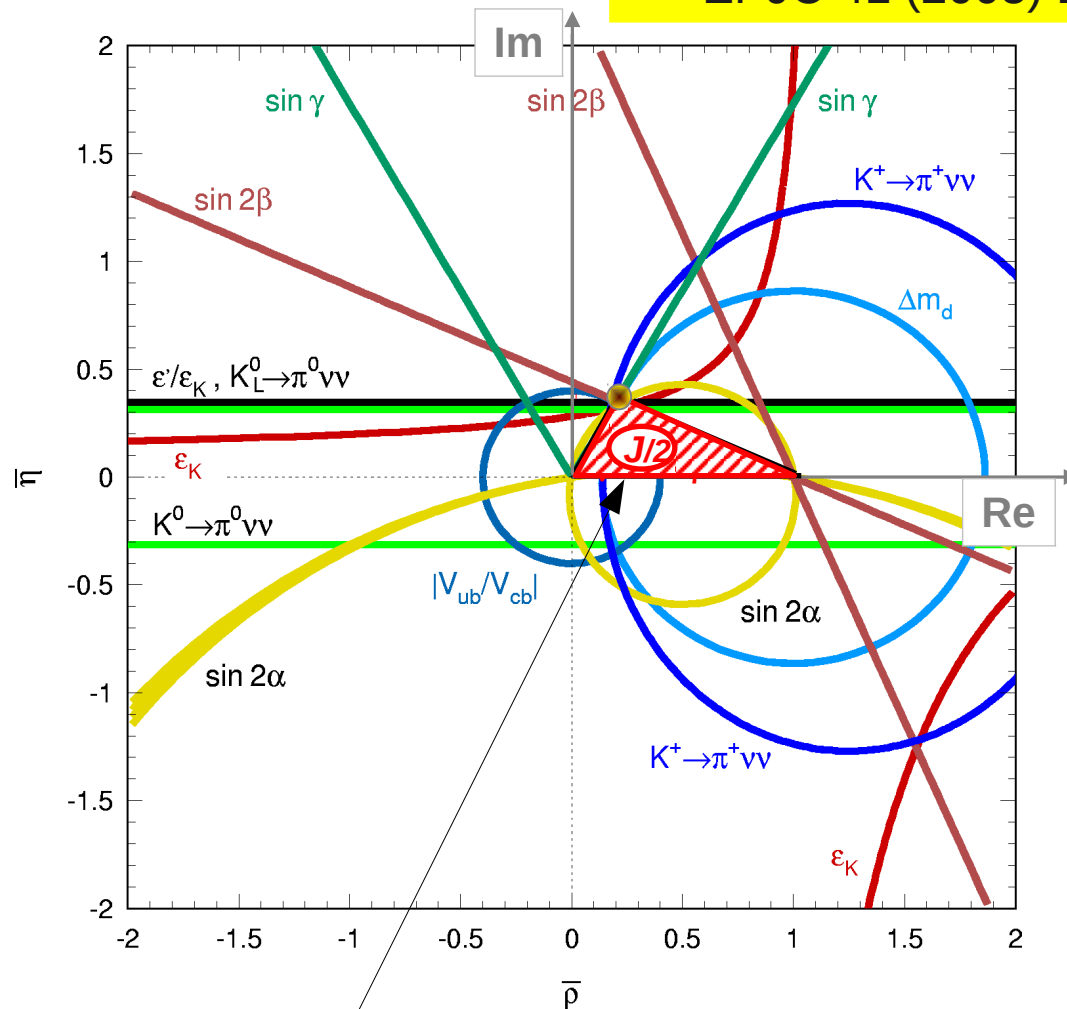

Area of (all of) the Unitarity Triangle(s) is given by the Jarlskog invariant

Time-Dependent CP Violation in the $B^0-\bar{B}^0$ System

- For a B meson known to be 1) B^0 or 2) \bar{B}^0 at time $t=0$, then at later time t :

$$\Gamma(B_{phys}^0 \rightarrow f_{CP}(t)) \propto e^{-\Gamma t} (1 - (S \sin(\Delta m t) - C \cos(\Delta m t)))$$

$$\Gamma(\bar{B}_{phys}^0 \rightarrow f_{CP}(t)) \propto e^{-\Gamma t} (1 + (S \sin(\Delta m t) - C \cos(\Delta m t)))$$

here assume $\Delta\Gamma$ negligible – will see full expressions later

$$S = \frac{2\Im(\lambda_{CP})}{1 + |\lambda_{CP}^2|} \quad C = \frac{1 - |\lambda_{CP}^2|}{1 + |\lambda_{CP}^2|} \quad \lambda_{CP} = \frac{q}{p} \frac{\bar{A}}{A}$$

For $B^0 \rightarrow J/\psi K_S$, $S = \sin(2\beta)$, $C=0$

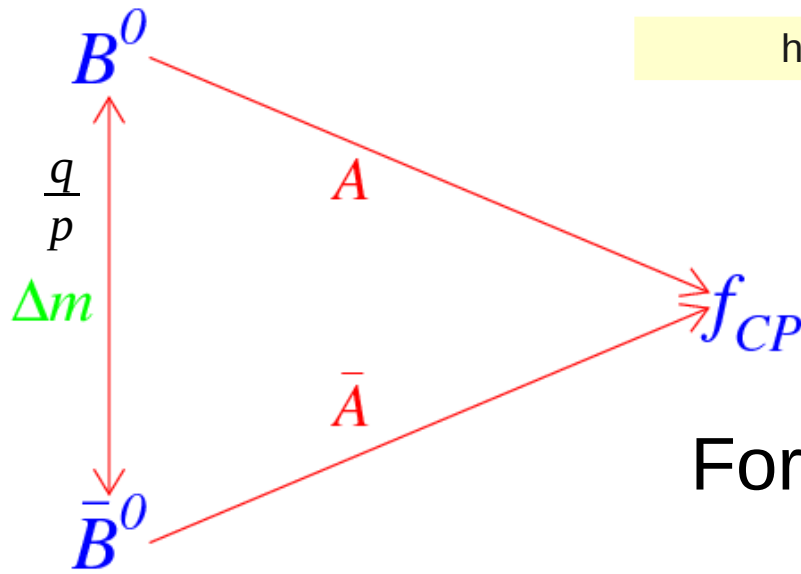

NPB 193 (1981) 85

Categories of CP violation

- Consider decay of neutral particle to a CP eigenstate

$$\lambda_{CP} = \frac{q}{p} \frac{\bar{A}}{A}$$

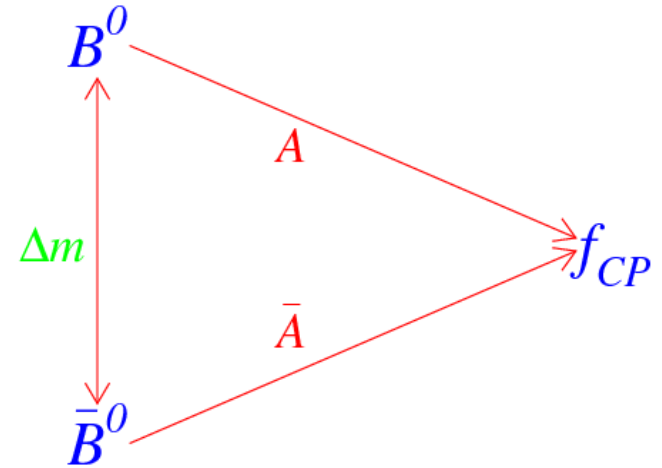

$$\left| \frac{q}{p} \right| \neq 1$$

CP violation in mixing

$$\left| \frac{\bar{A}}{A} \right| \neq 1$$

CP violation in decay (direct CPV)

$$\Im \left(\frac{q}{p} \frac{\bar{A}}{A} \right) \neq 0$$

CP violation in interference between mixing and decay

Asymmetric B factory principle

To measure t require B meson to be moving

→ e^+e^- at threshold with asymmetric collisions (Odone)

Other possibilities considered

→ fixed target production?

→ hadron collider?

→ e^+e^- at high energy?

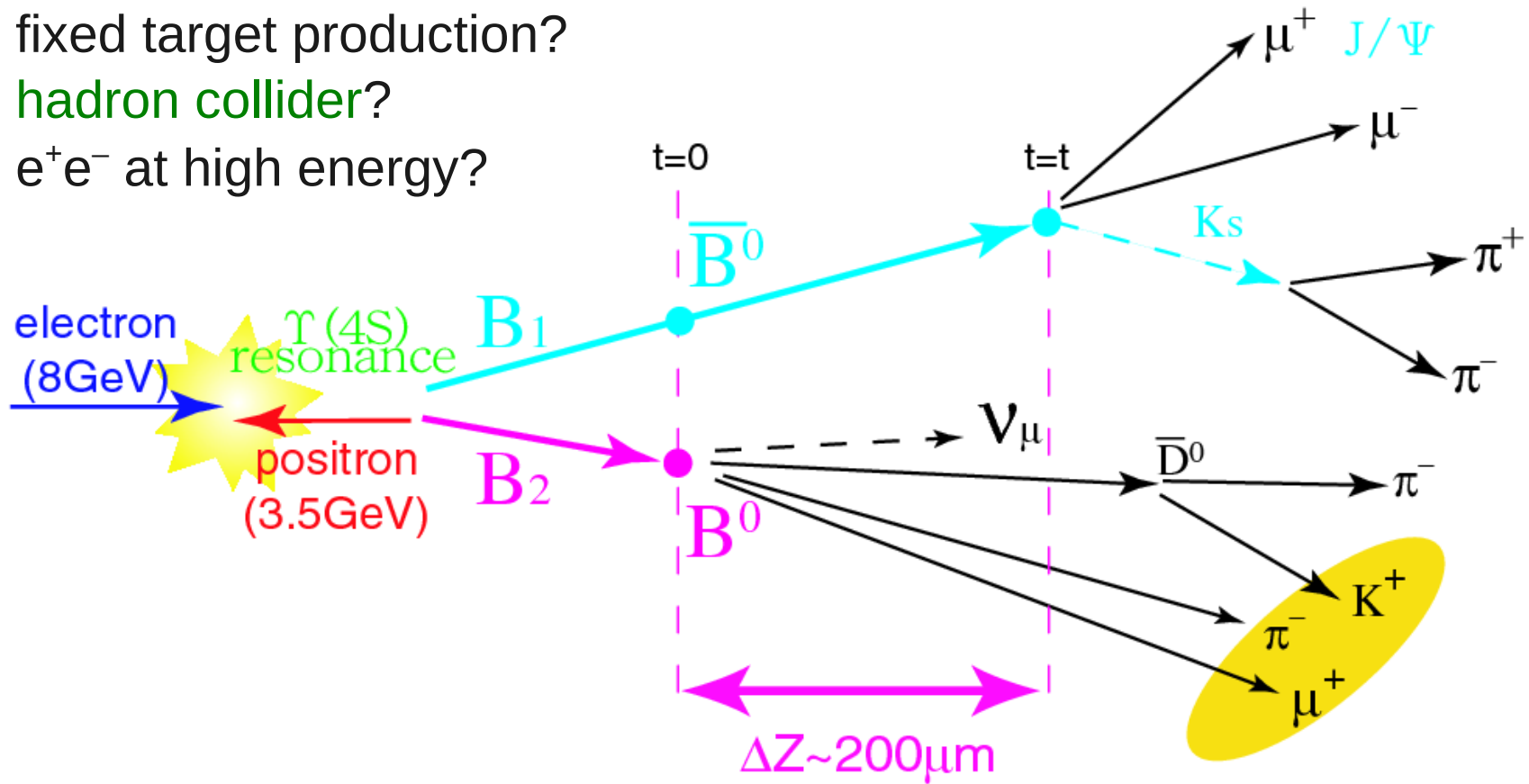

Asymmetric B Factories

PEP-II at SLAC

9.0 GeV e^- on 3.1 GeV e^+

KEKB at KEK

8.0 GeV e^- on 3.5 GeV e^+

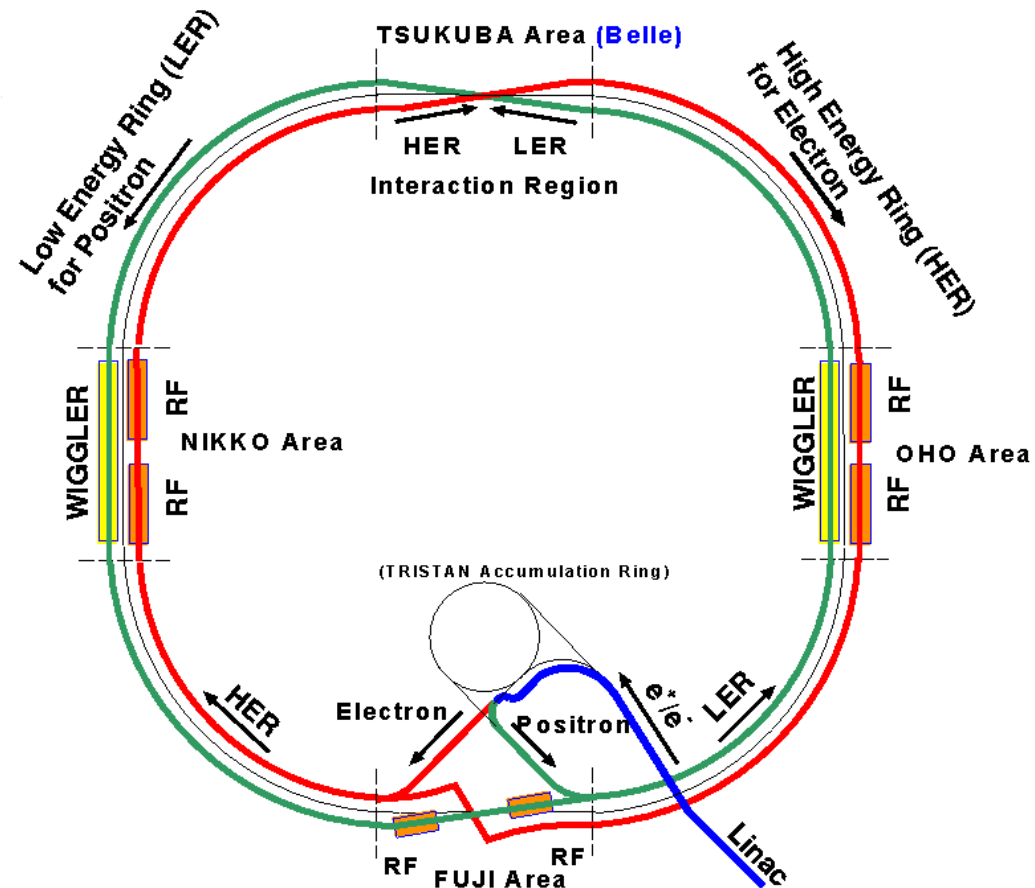
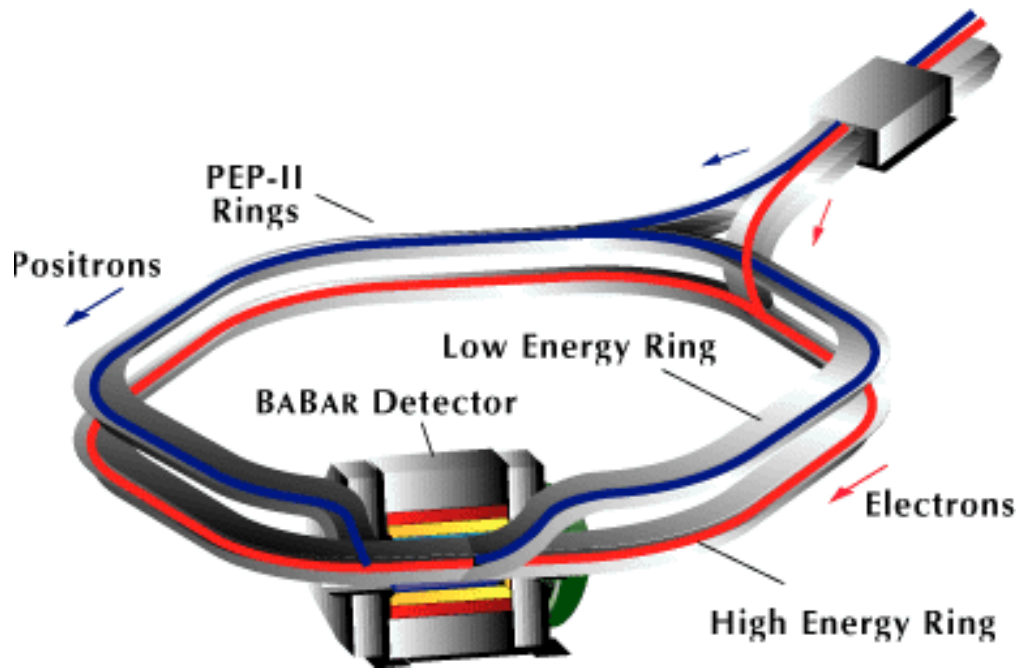

B factories – world record luminosities

As of 2008/04/09 00:00

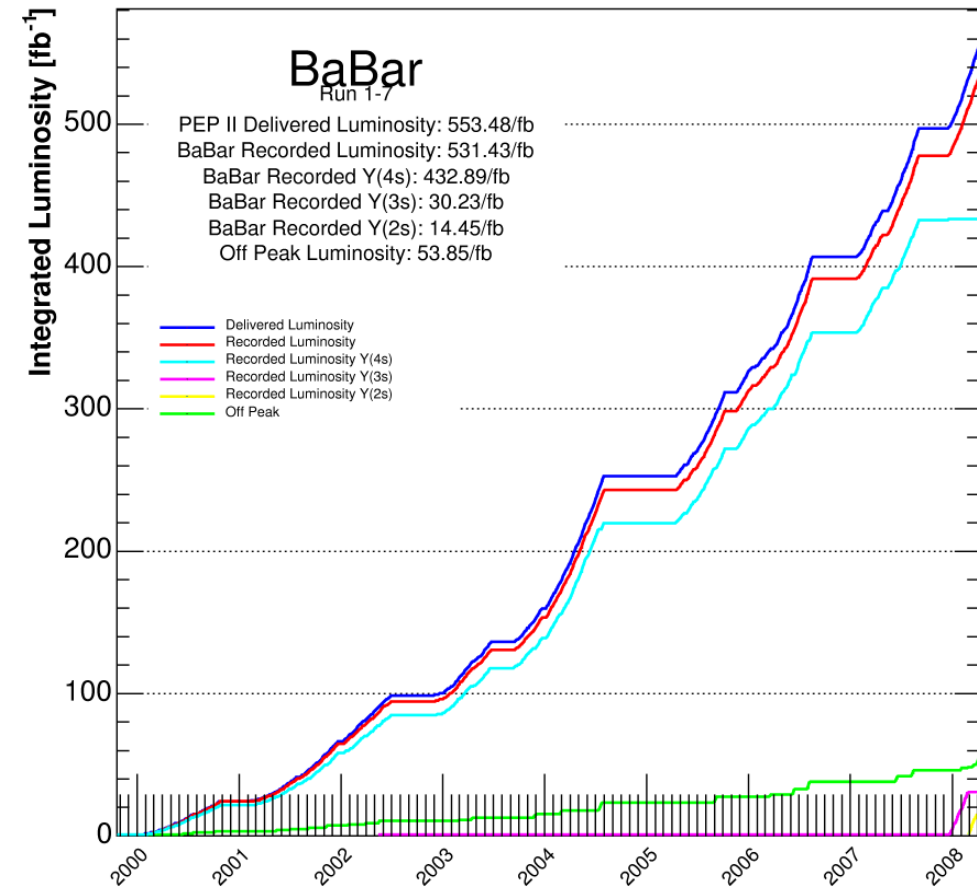

~ 433/fb on Y(4S)

Offline+Online Luminosity (pb^{-1}) (/day)

2008/12/23 14:01

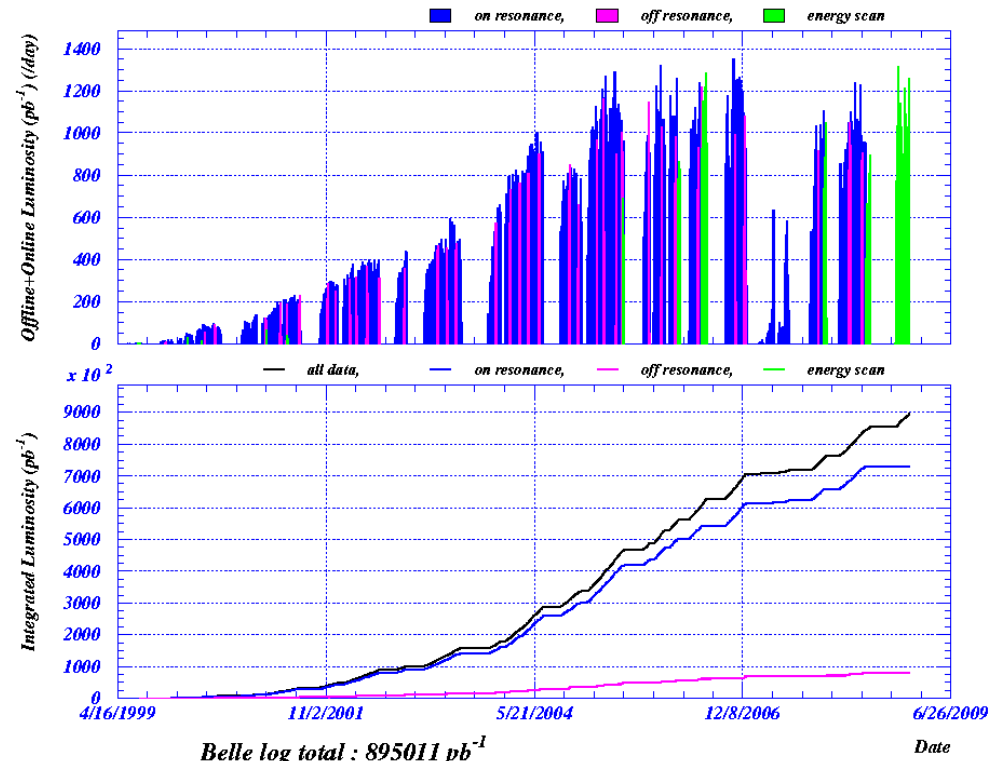

~ 711/fb on Y(4S)

World record luminosities (2)

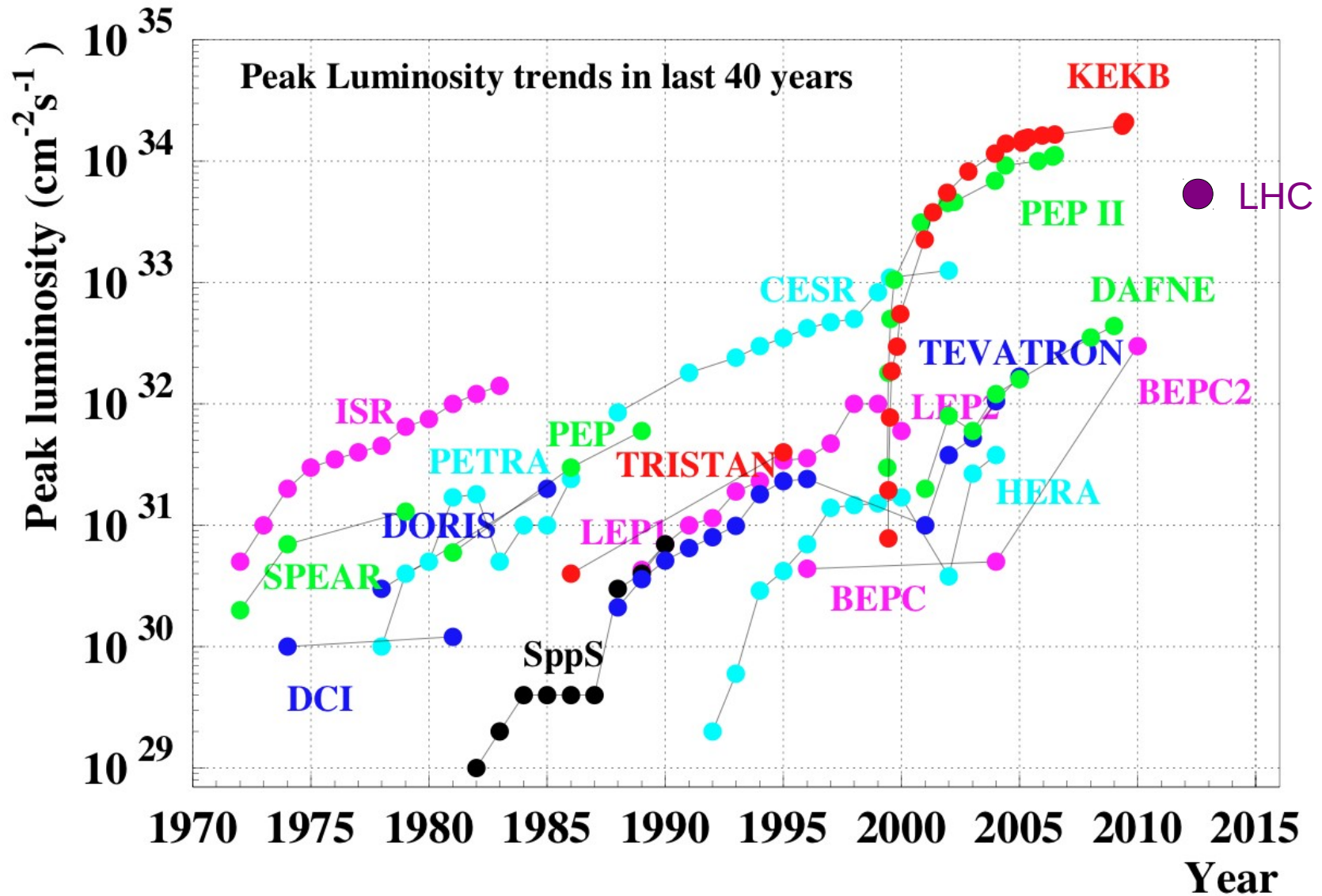

BaBar Detector

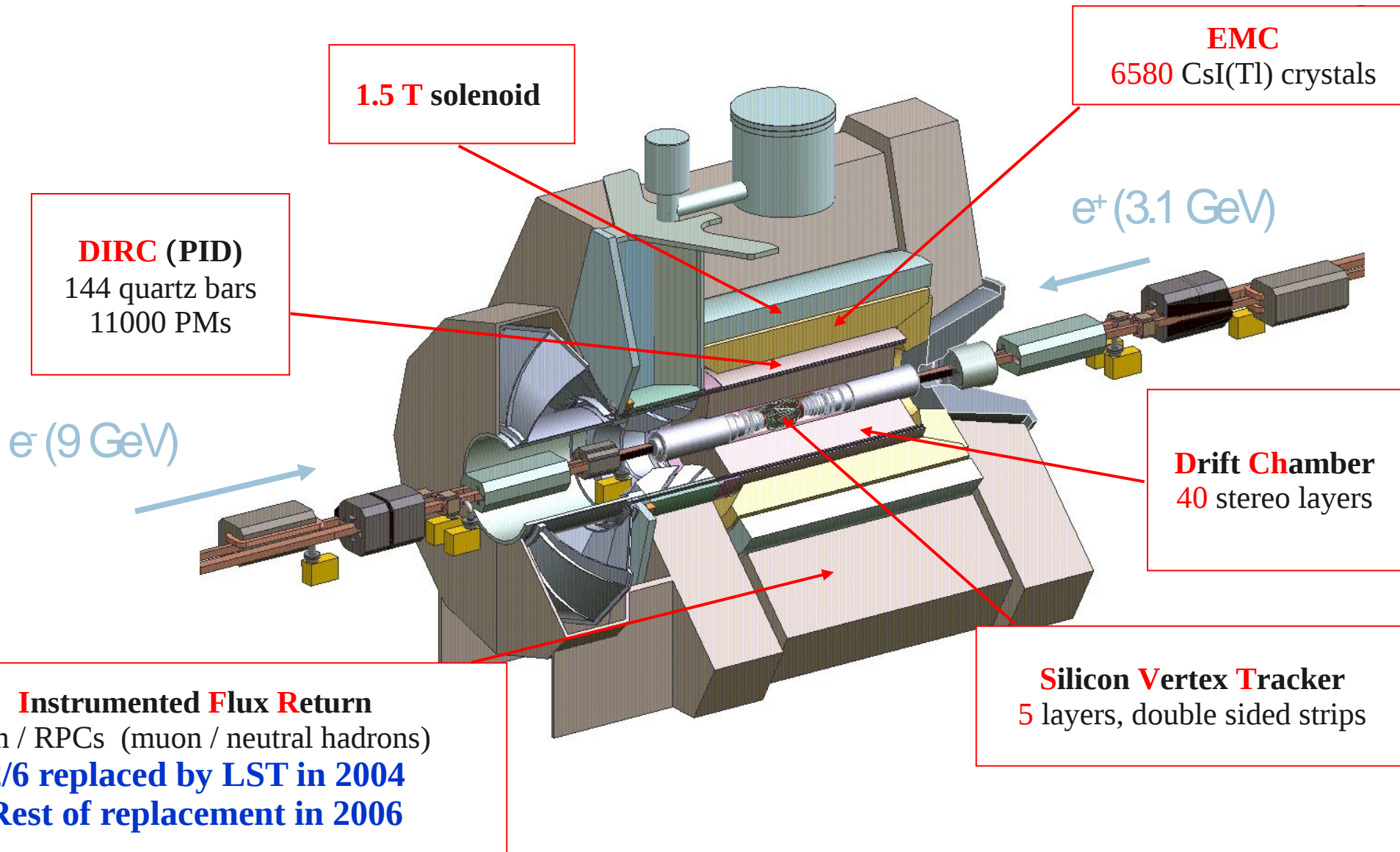

Belle Detector

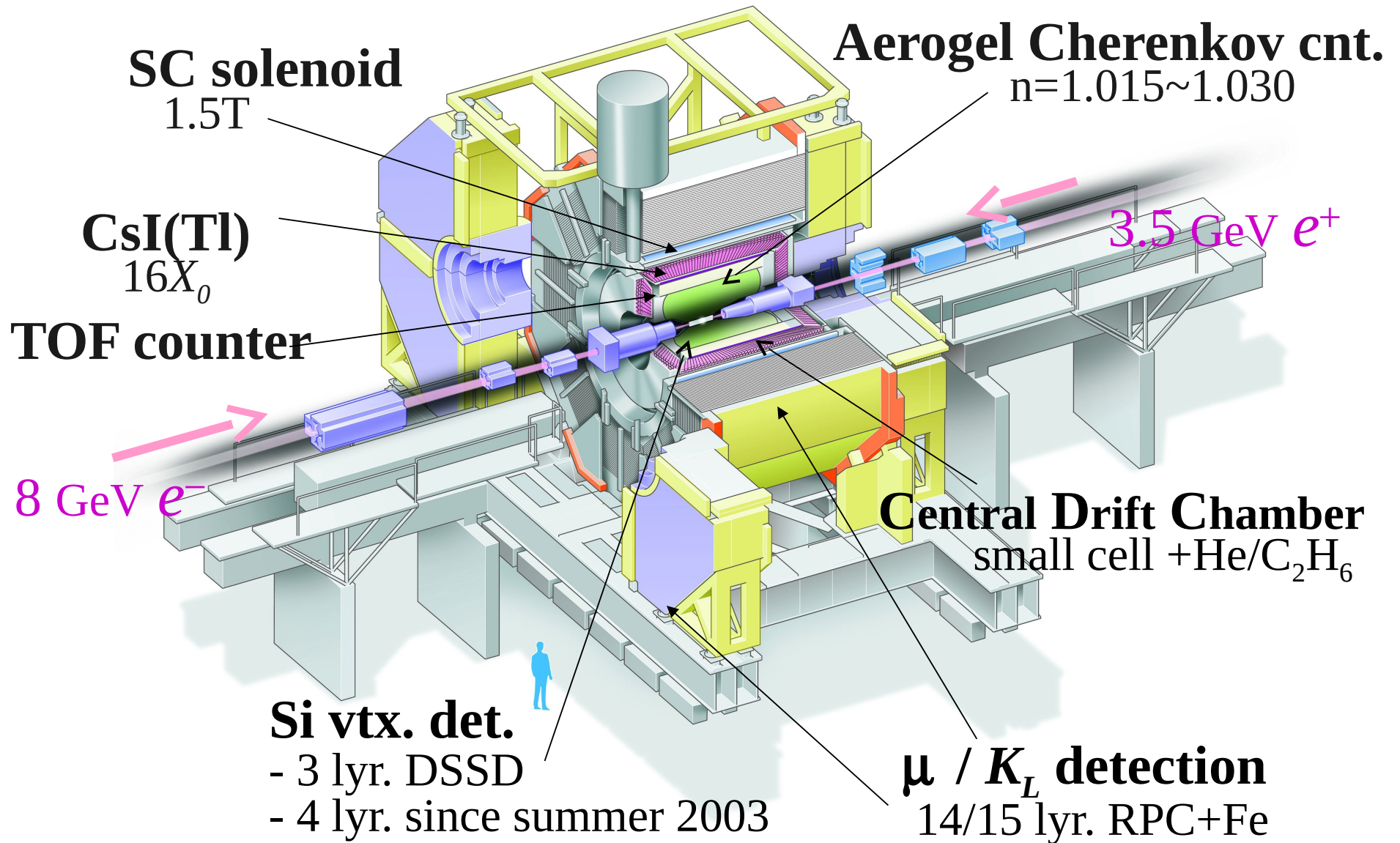

Results for the golden mode



BABAR

BELLE

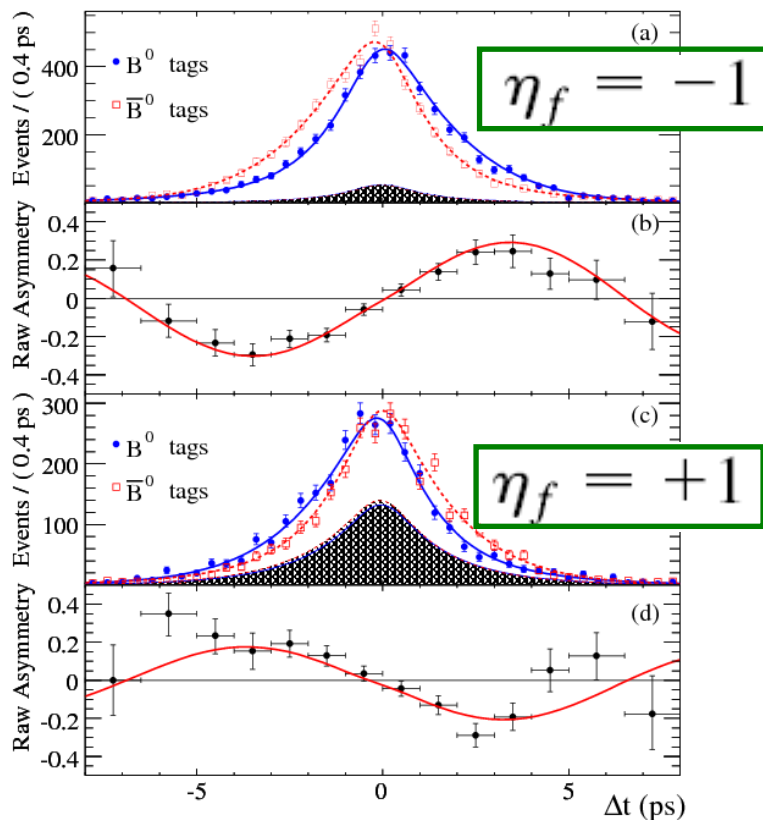

PRD 79 (2009) 072009

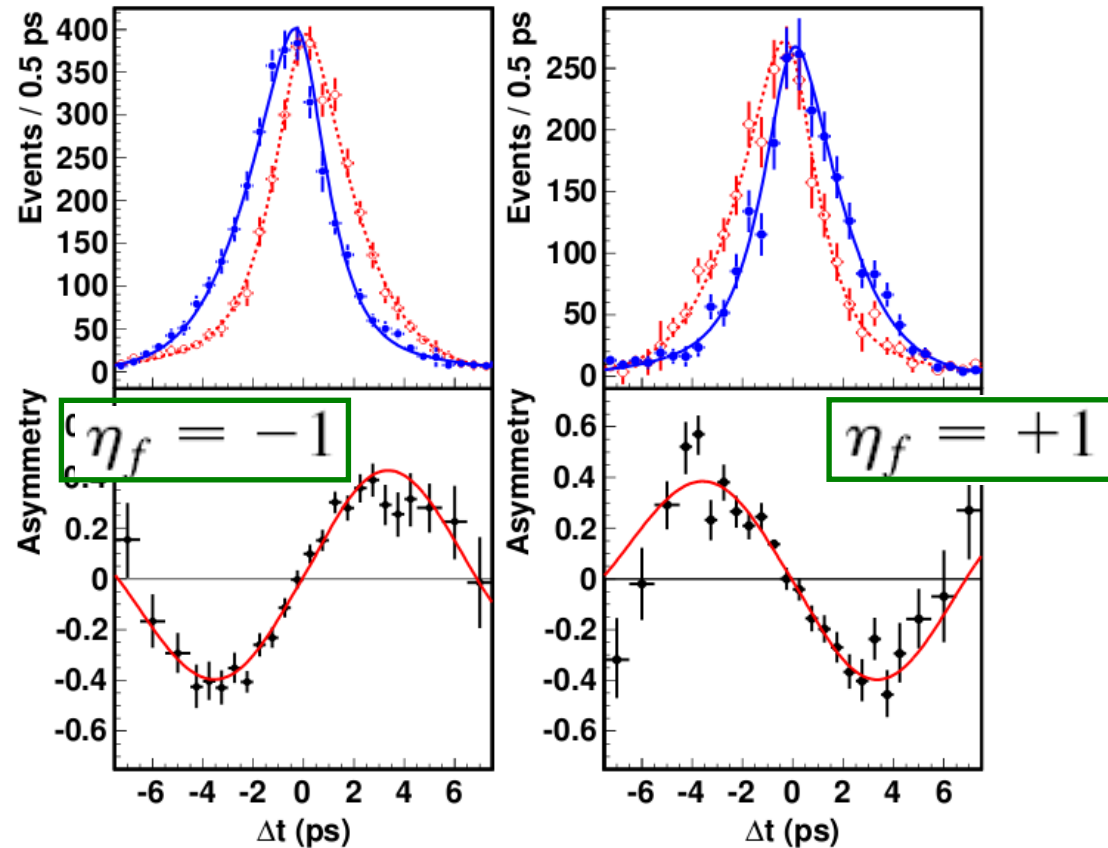

PRL 108 (2012) 171802

Compilation of results

$$\sin(2\beta) \equiv \sin(2\phi_1)$$

HFAG
Moriond 2012
PRELIMINARY

Everything
is here

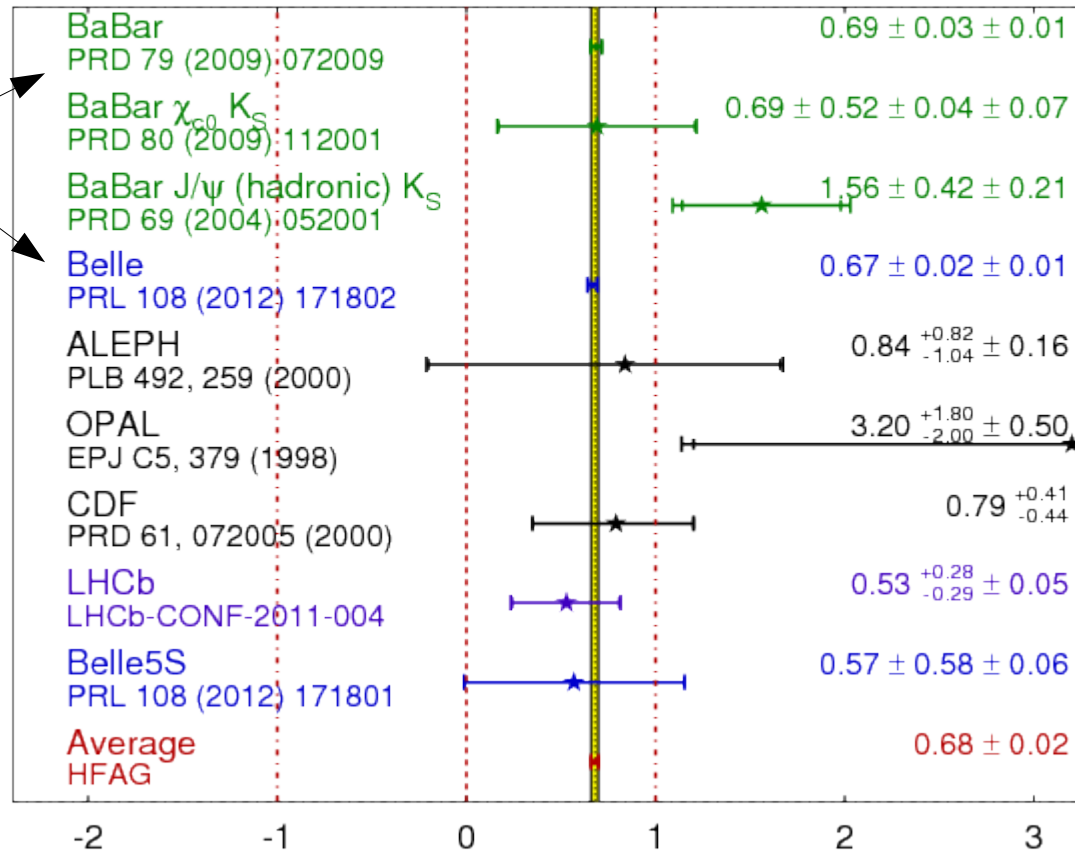

Compilation of results

$$\sin(2\beta) \equiv \sin(2\phi_1)$$

HFAG
Moriond 2012
PRELIMINARY

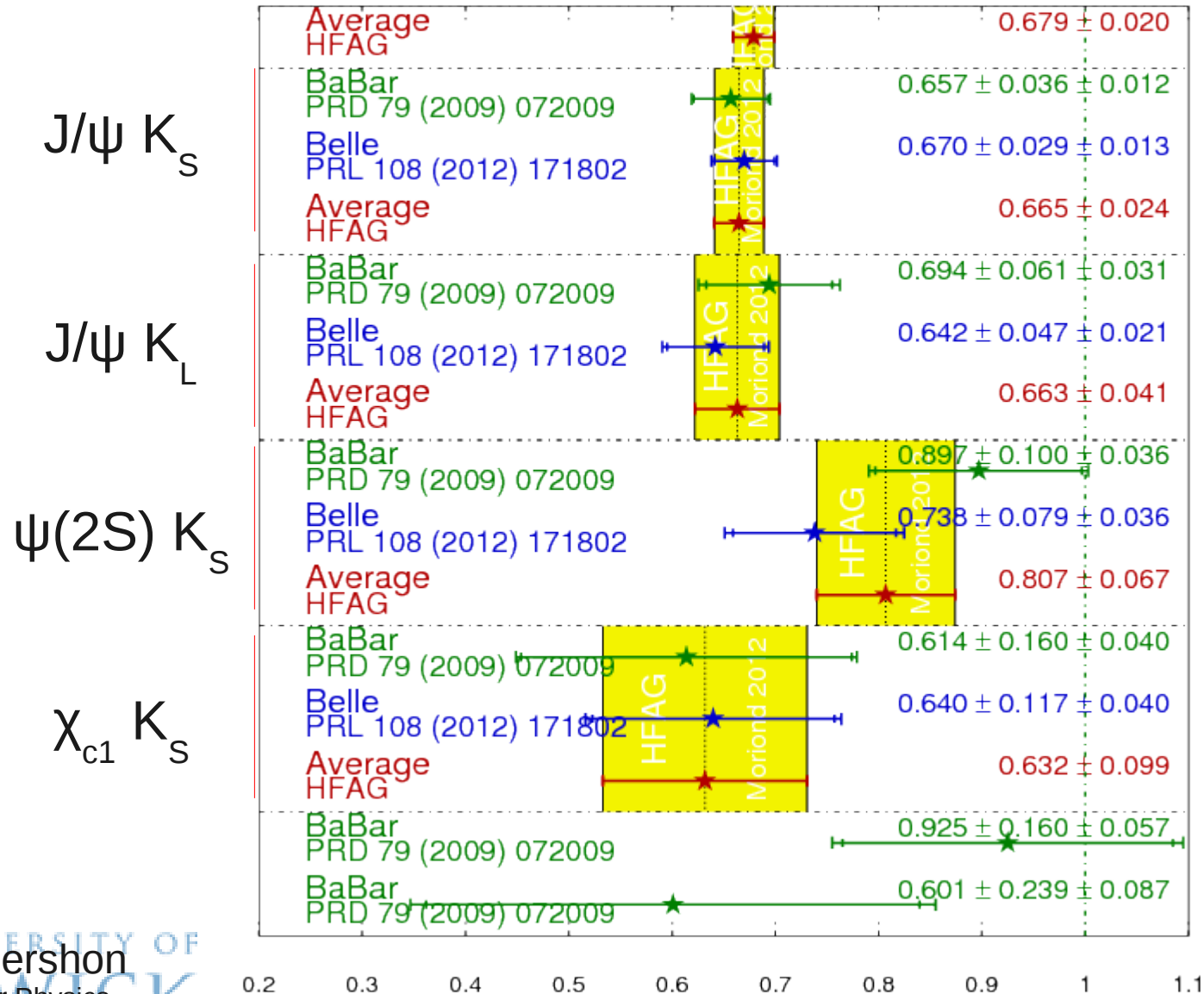

Measurement of α

- Similar analysis using $b \rightarrow u\bar{u}d$ decays (e.g. $B_d^0 \rightarrow \pi^+\pi^-$) probes $\pi - (\beta + \gamma) = \alpha$
 - but $b \rightarrow du\bar{u}$ penguin transitions contribute to same final states \Rightarrow “penguin pollution”
 - $C \neq 0 \Leftrightarrow$ direct CP violation can occur
 - $S \neq +\eta_{CP} \sin(2\alpha)$
- Two approaches (optimal approach combines both)
 - try to use modes with small penguin contribution
 - correct for penguin effect (isospin analysis)

PRL 65 (1990) 3381

Experimental Situation

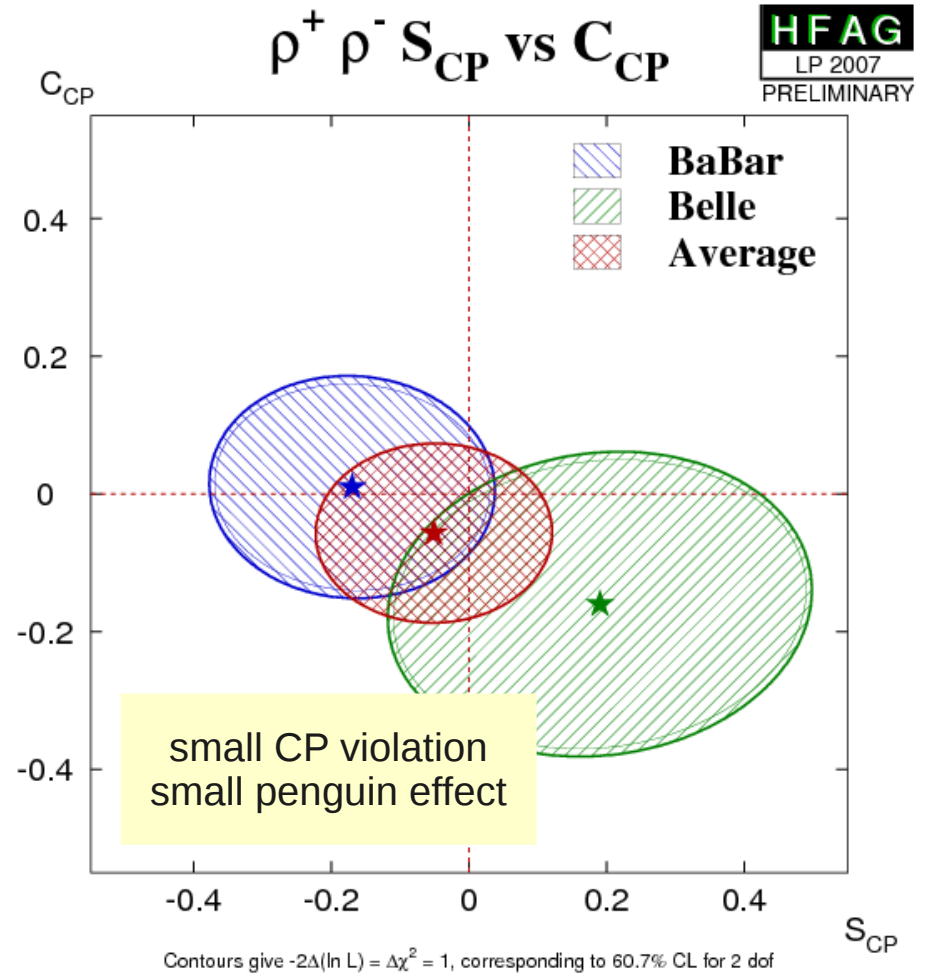
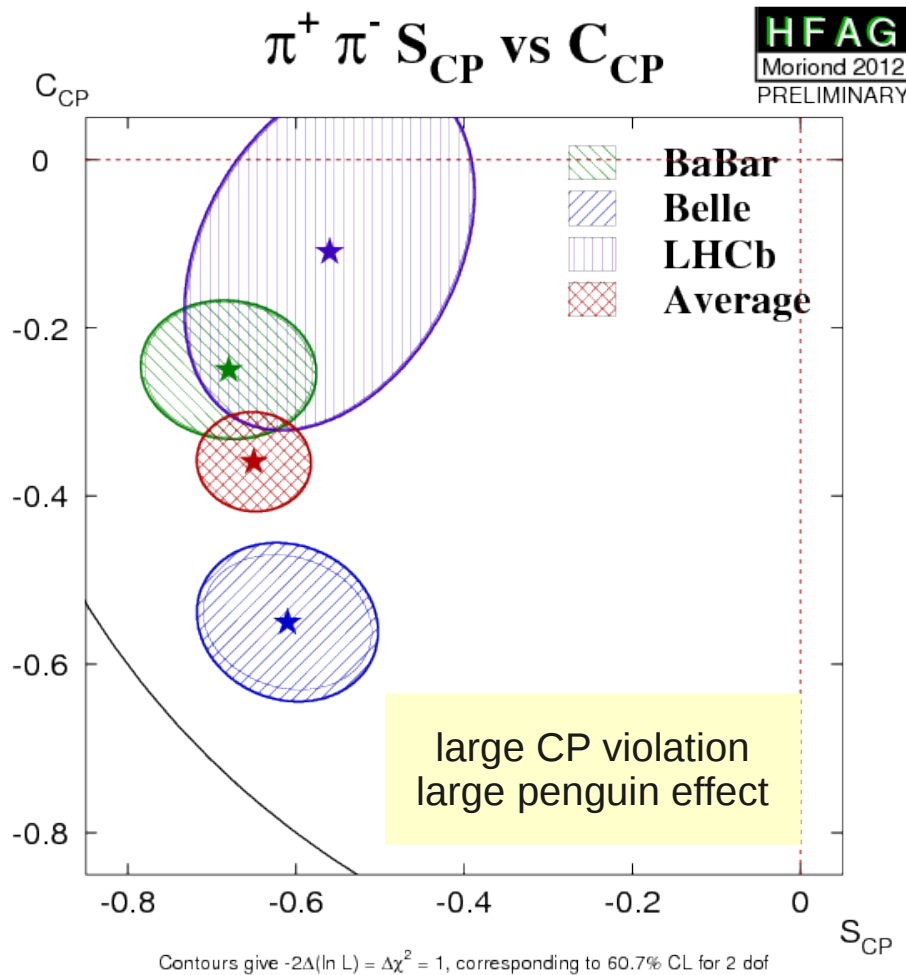

improved measurements needed!

Measurement of α

THESE SOLUTIONS RULED OUT BY OBSERVATION OF DIRECT CP VIOLATION IN $B^0 \rightarrow \pi^+\pi^-$

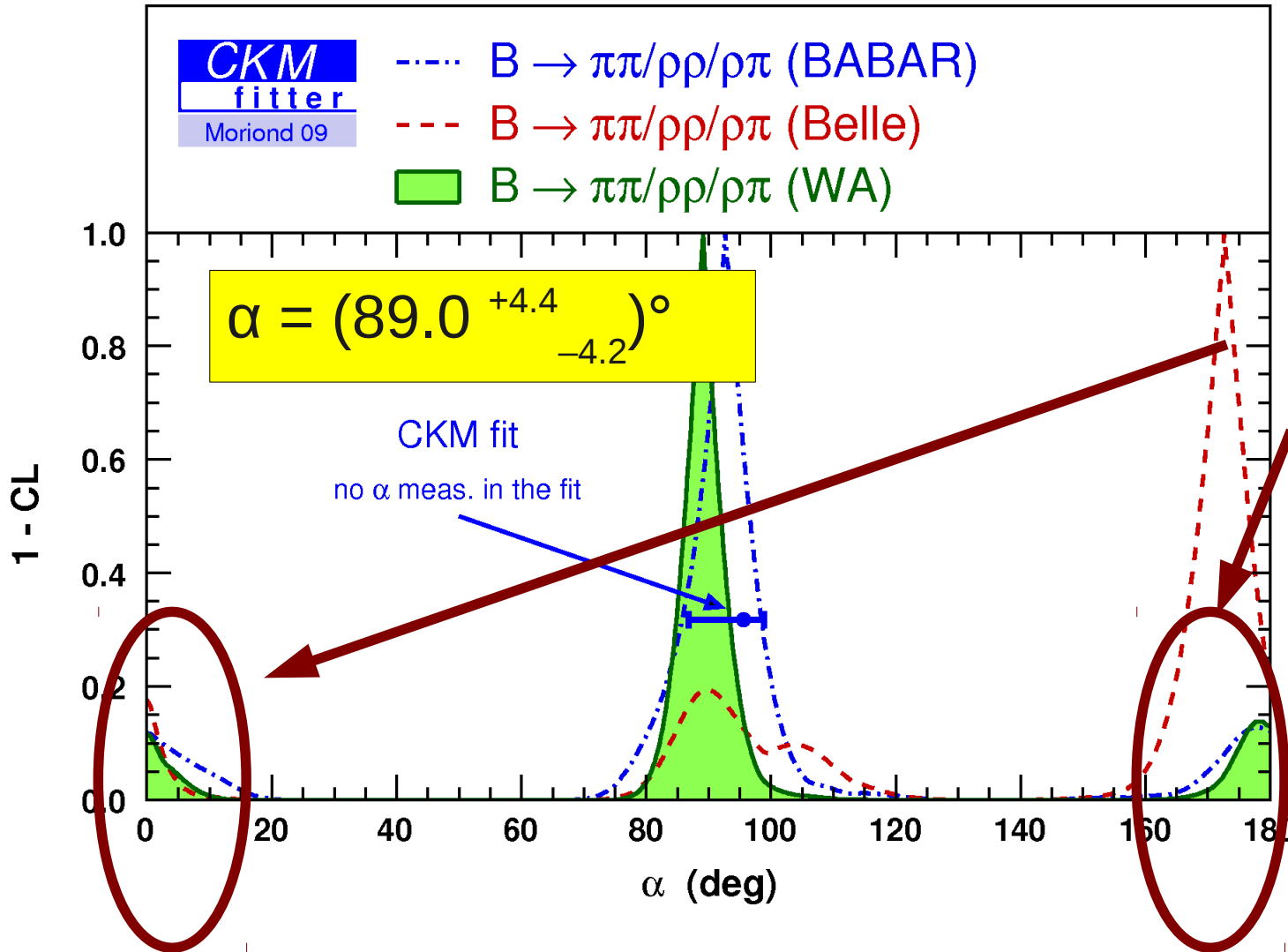

Is there any physical significance in the fact that $\alpha \approx 90^\circ$?

R_t side from B^0-B^0 mixing

$$R_t = \left| \frac{V_{td} V_{tb}^*}{V_{cd} V_{cb}^*} \right| \quad \& \quad \frac{\Delta m_d}{\Delta m_s} = \frac{m_{B_d} f_{B_d}^2 \hat{B}_{B_d} |V_{td}|^2}{m_{B_s} f_{B_s}^2 \hat{B}_{B_s} |V_{ts}|^2}$$

World average based on many measurements

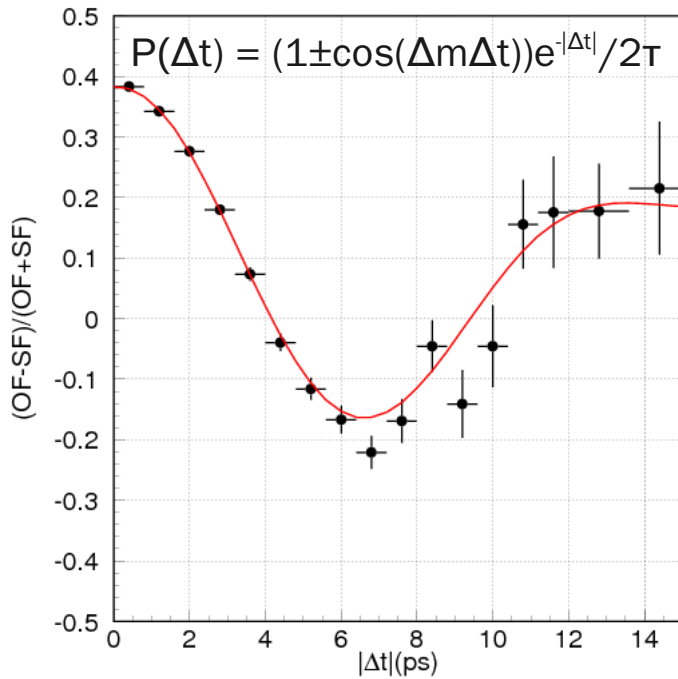

$$\Delta m_d = (0.511 \pm 0.005 \pm 0.006) \text{ ps}^{-1}$$

PRD 71, 072003 (2005)

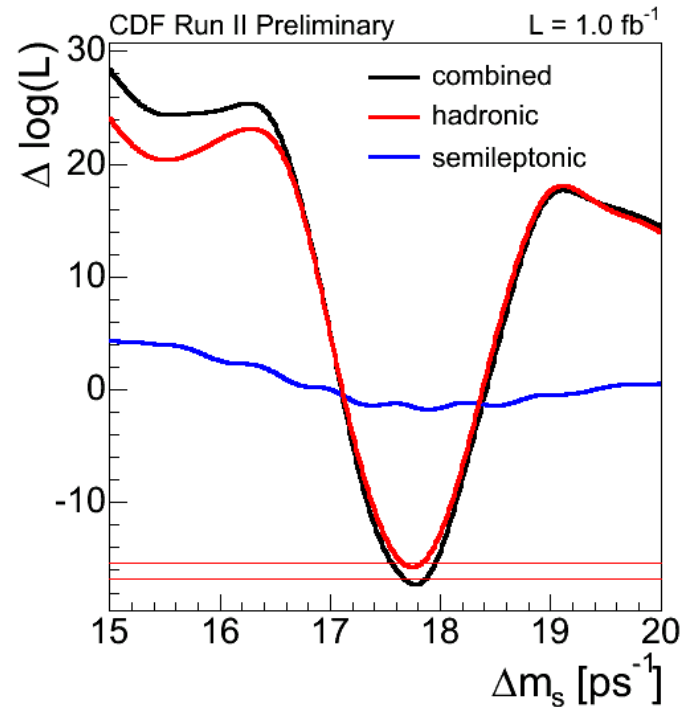

$$\Delta m_s = (17.77 \pm 0.10 \pm 0.07) \text{ ps}^{-1}$$

PRL 97, 242003 (2006)

$$\left| V_{td}/V_{ts} \right| = 0.211 \pm 0.001 \pm 0.005$$

↑ experimental uncertainty ↑ theoretical uncertainty

R_t side from B^0-B^0 mixing

World average based on many measurements

$$R_t = \left| \frac{V_{td} V_{tb}^*}{V_{cd} V_{cb}^*} \right| \quad \& \quad \frac{\Delta m_d}{\Delta m_s} = \frac{m_{B_d} f_{B_d}^2 \hat{B}_{B_d} |V_{td}|^2}{m_{B_s} f_{B_s}^2 \hat{B}_{B_s} |V_{ts}|^2}$$

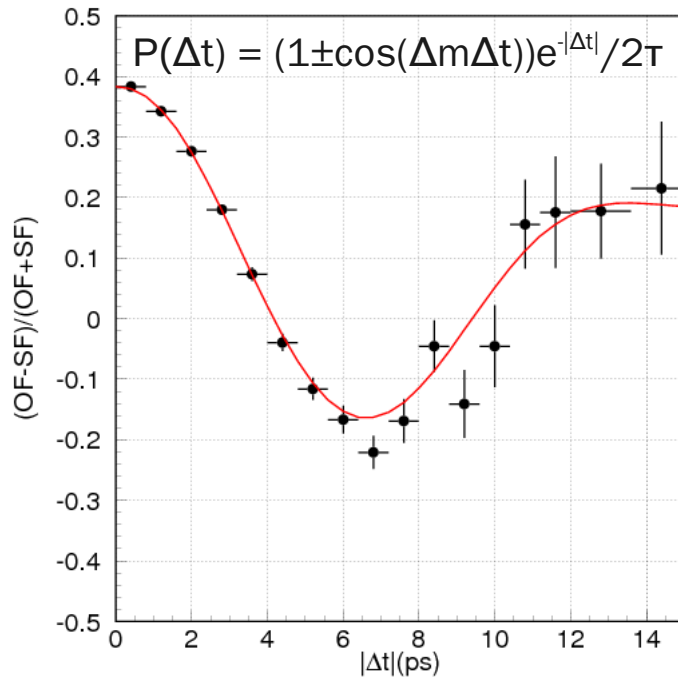

$$\Delta m_d = (0.511 \pm 0.005 \pm 0.006) \text{ ps}^{-1}$$

PRD 71, 072003 (2005)

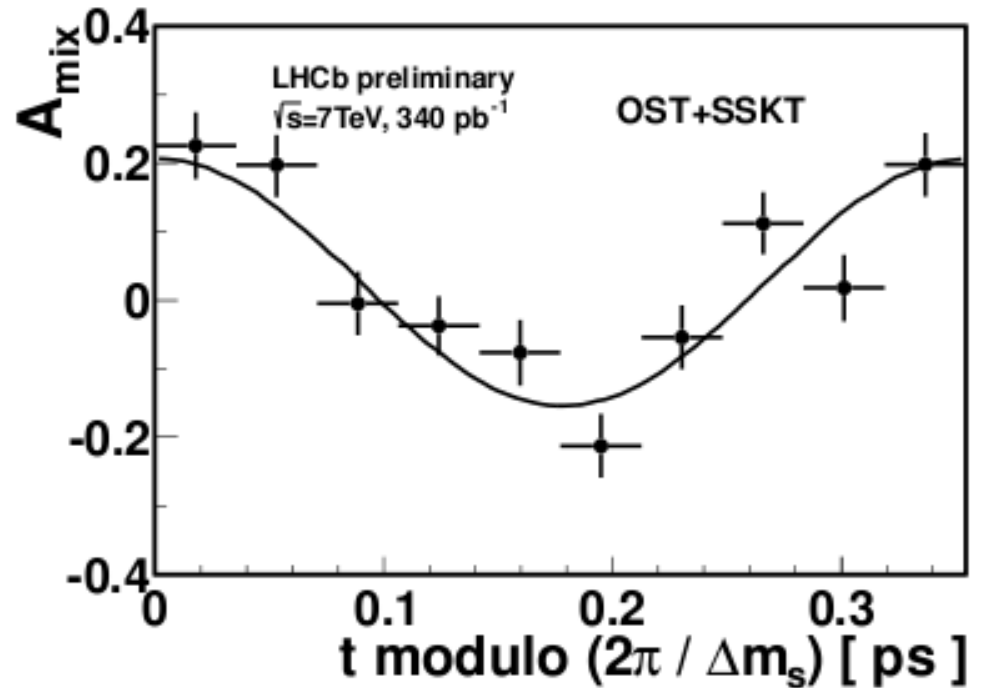

$$\Delta m_s = (17.725 \pm 0.041 \pm 0.026) \text{ ps}^{-1}$$

LHCb-CONF-2011-050

$$\left| V_{td}/V_{ts} \right| = 0.211 \pm 0.001 \pm 0.005$$

↑ experimental uncertainty ↑ theoretical uncertainty

R_u side from semileptonic decays

$$R_u = \left| \frac{V_{ud} V_{ub}^*}{V_{cd} V_{cb}^*} \right|$$

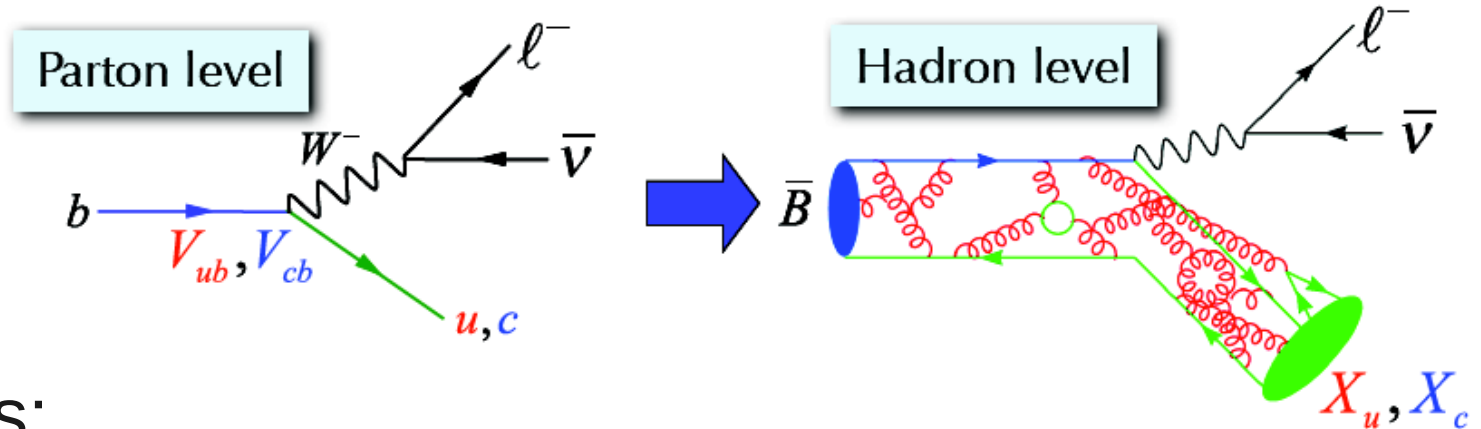

- Approaches:

- **exclusive semileptonic B decays**, eg. $B^0 \rightarrow \pi^- e^+ \nu$

- require knowledge of form factors

- can be calculated in lattice QCD at kinematical limit

- **inclusive semileptonic B decays**, eg. $B \rightarrow X_u e^+ \nu$

- clean theory, based on **O**perator **P**roduct **E**xpansion

- experimentally challenging:

- need to reject $b \rightarrow c$ background

- cuts re-introduce theoretical uncertainties

$|V_{ub}|$ from exclusive semileptonic decays

Current best measurements use $B^0 \rightarrow \pi^- l^+ \nu$

BaBar experiment
PRD 83 (2011) 052011
PRD 83 (2011) 032007

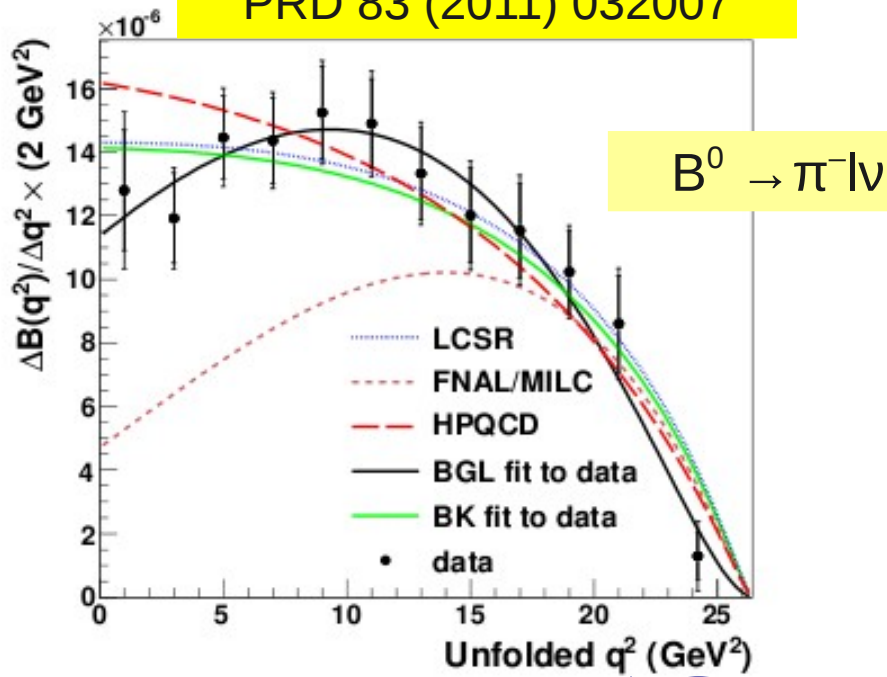

Belle experiment
PRD 83 (2011) 071101(R)

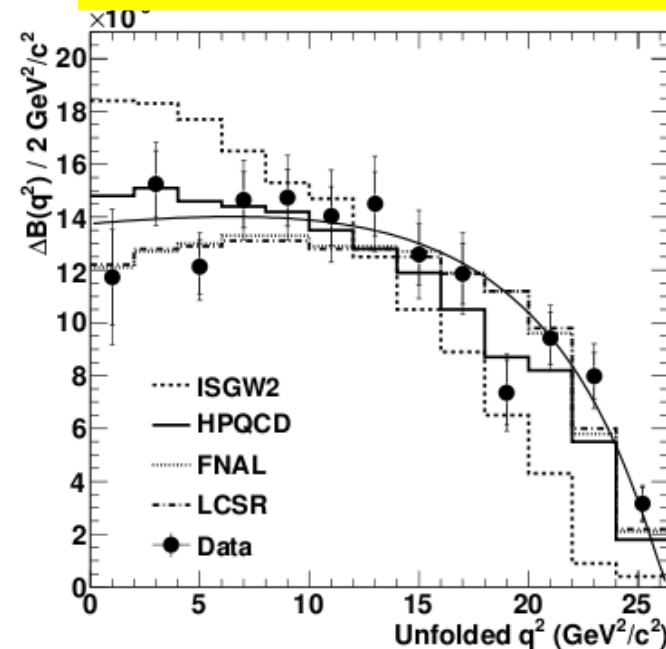

$$|V_{ub}| = (3.09 \pm 0.08 \pm 0.12^{+0.35}_{-0.29}) \times 10^{-3}$$

$$|V_{ub}| = (3.43 \pm 0.33) \times 10^{-3}$$

$|V_{ub}|$ from inclusive semileptonic decays

- Main difficulty to measure inclusive $B \rightarrow X_u l^+ \nu$
 - background from $B \rightarrow X_c l^+ \nu$
- Approaches
 - cut on E_l (lepton endpoint), q^2 ($l\nu$ invariant mass squared), $M(X_u)$, or some combination thereof
- Example: endpoint analysis

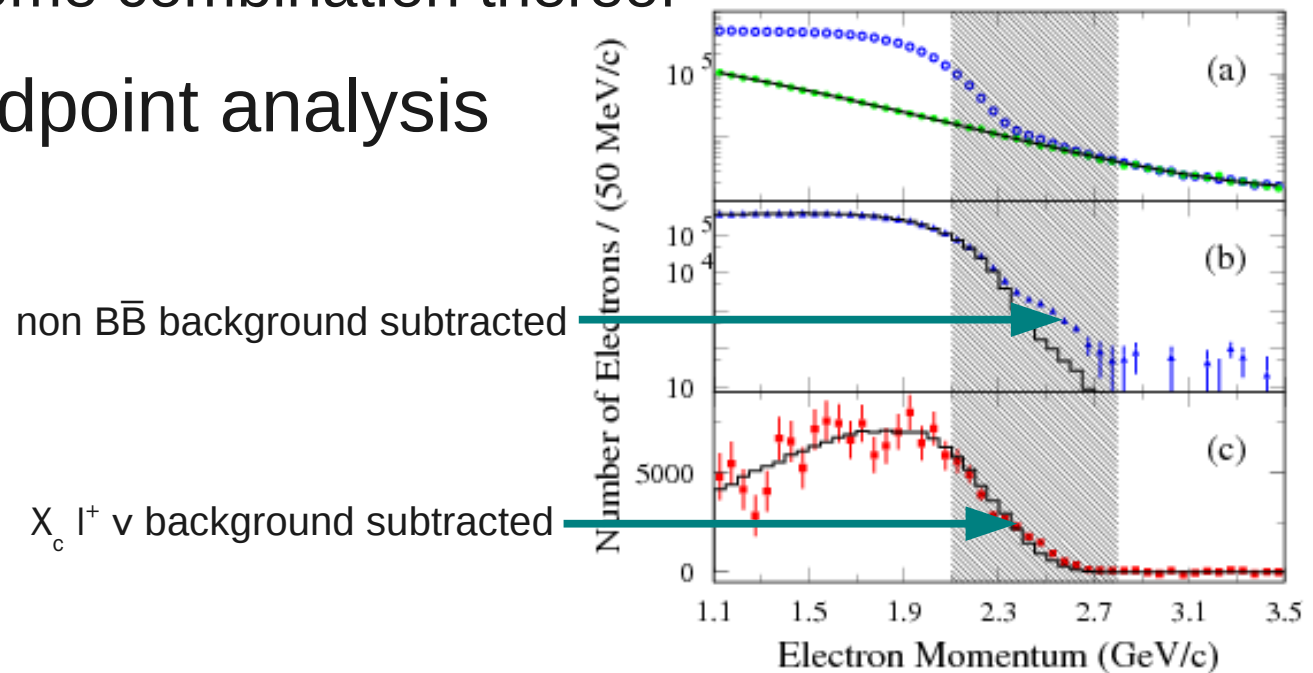

$|V_{ub}|$ inclusive - compilation

Different theoretical approaches (2 of 4 used by HFAG)

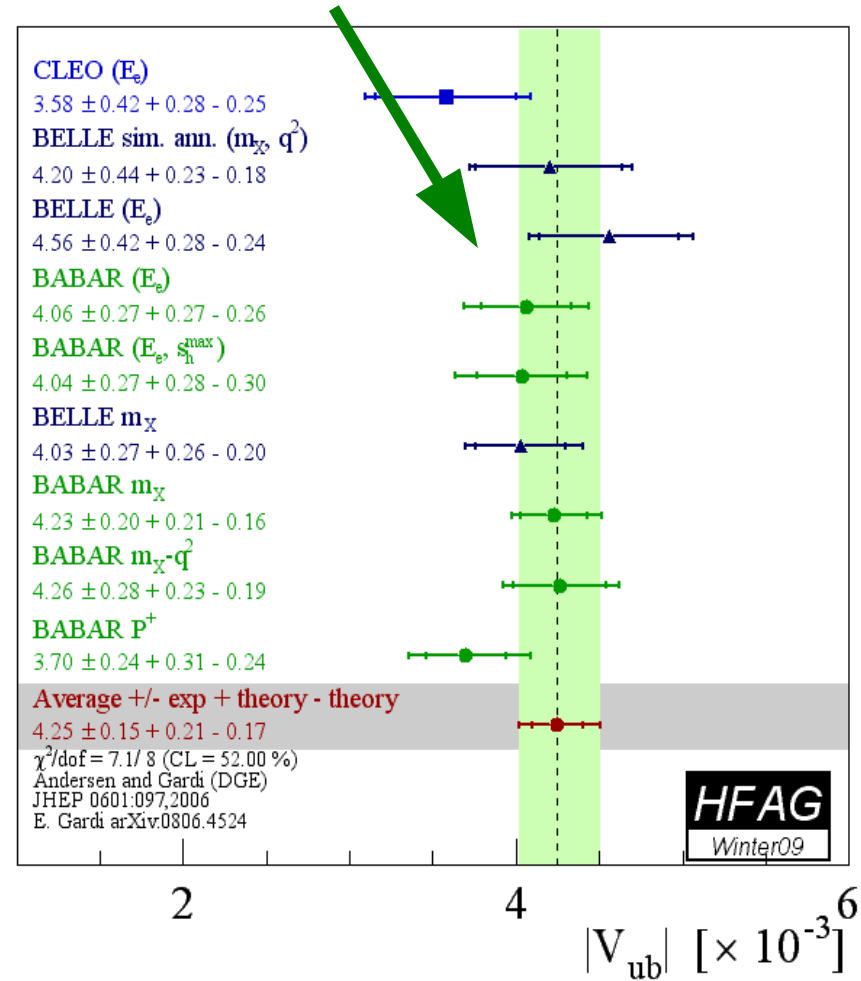
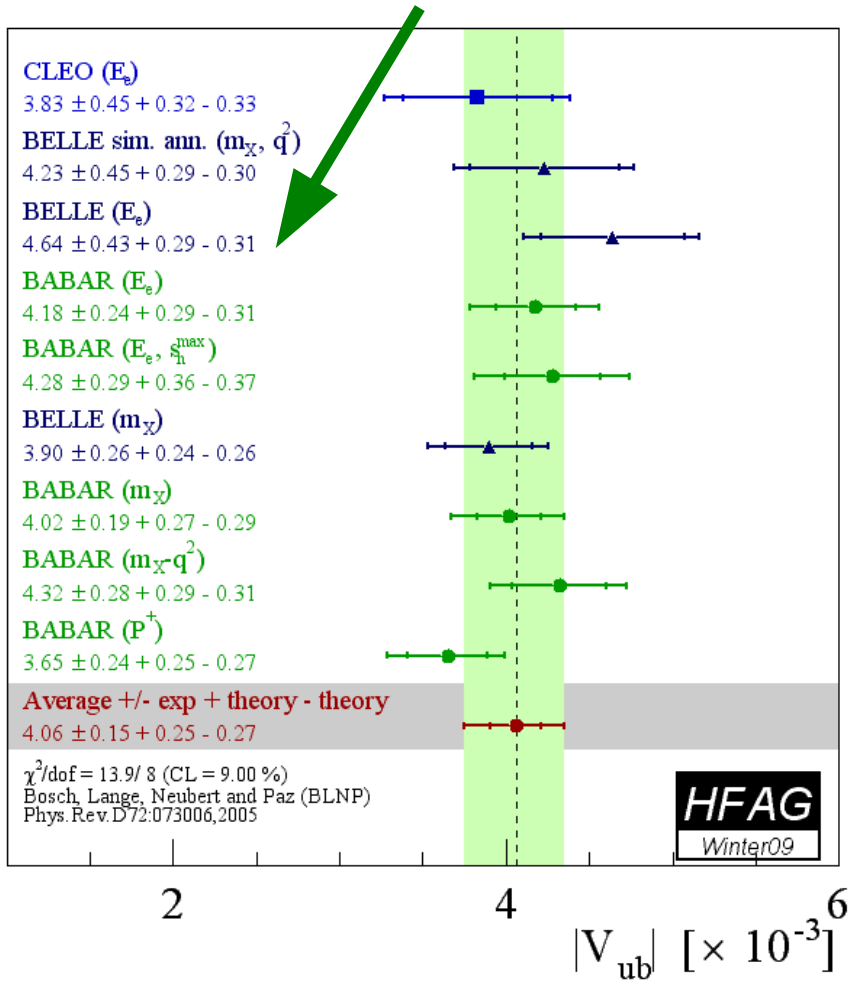

$|V_{ub}|$ average

- Averages on $|V_{ub}|$ from both exclusive and inclusive approaches
 - exclusive: $|V_{ub}| = (3.23 \pm 0.31) \times 10^{-3}$
 - inclusive: $|V_{ub}| = (4.41 \pm 0.22) \times 10^{-3}$
 - slight tension between these results
 - in both cases theoretical errors are dominant
 - but some “theory” errors can be improved with more data
 - PDG2012 does naïve average rescaling due to inconsistency to obtain $|V_{ub}| = (4.15 \pm 0.49) \times 10^{-3}$

Partial summary

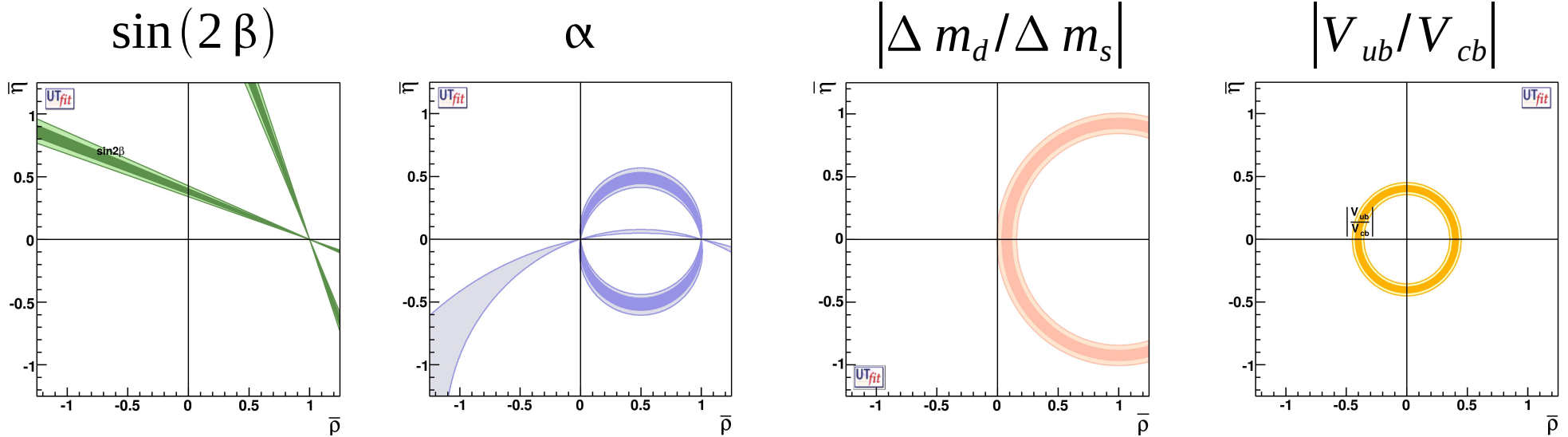

Adding a few other constraints we find

$$\bar{\rho} = 0.132 \pm 0.020$$

$$\bar{\eta} = 0.358 \pm 0.012$$

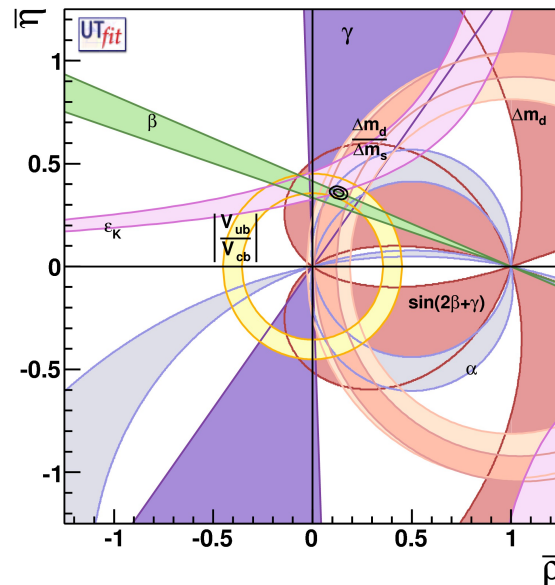

Consistent with Standard Model fit

- some “tensions”

Still plenty of room for new physics

Flavour physics at hadron colliders

	$e^+e^- \rightarrow \Upsilon(4s) \rightarrow B\bar{B}$ PEP-II, KEK-B	$p\bar{p} \rightarrow b\bar{b}X$ ($\sqrt{s} = 2$ TeV) TeVatron	$pp \rightarrow b\bar{b}X$ ($\sqrt{s} = 14$ TeV) LHC
prod	1 nb	$\sim 100 \mu\text{b}$	$\sim 500 \mu\text{b}$
typ. $b\bar{b}$ rate	10 Hz	~ 100 kHz	~ 500 kHz
purity	$\sim 1/4$	$\sigma_{b\bar{b}}/\sigma_{\text{inel}} \approx 0.2\%$	$\sigma_{b\bar{b}}/\sigma_{\text{inel}} \approx 0.6\%$
pile-up	0	1.7	0.5-20
B content	B^+B^- (50%), $B^0\bar{B}^0$ (50%)	B^+ (40%), B^0 (40%), B_s (10%), B_c ($< 1\%$), b-baryons (10%)	
B boost	small, $\beta\gamma \sim 0.56$	large, decay vertices are displaced	
event structure	BB pair alone	many particles non-associated to $b\bar{b}$	
prod. vertex	Not reconstructed	reconstructed with many tracks	
$B^0\bar{B}^0$ mixing	coherent	incoherent \rightarrow flavour tagging dilution	

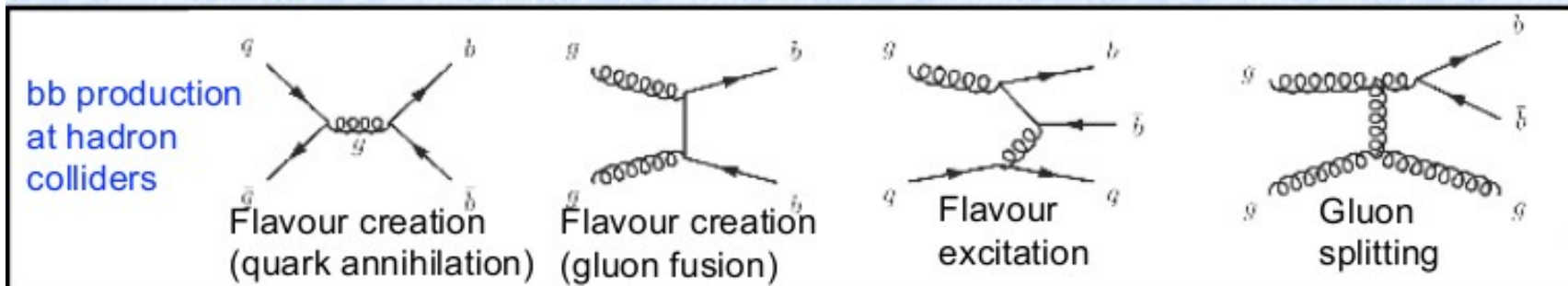

Geometry

- In high energy collisions, $b\bar{b}$ pairs produced predominantly in forward or backward directions
- LHCb is a forward spectrometer

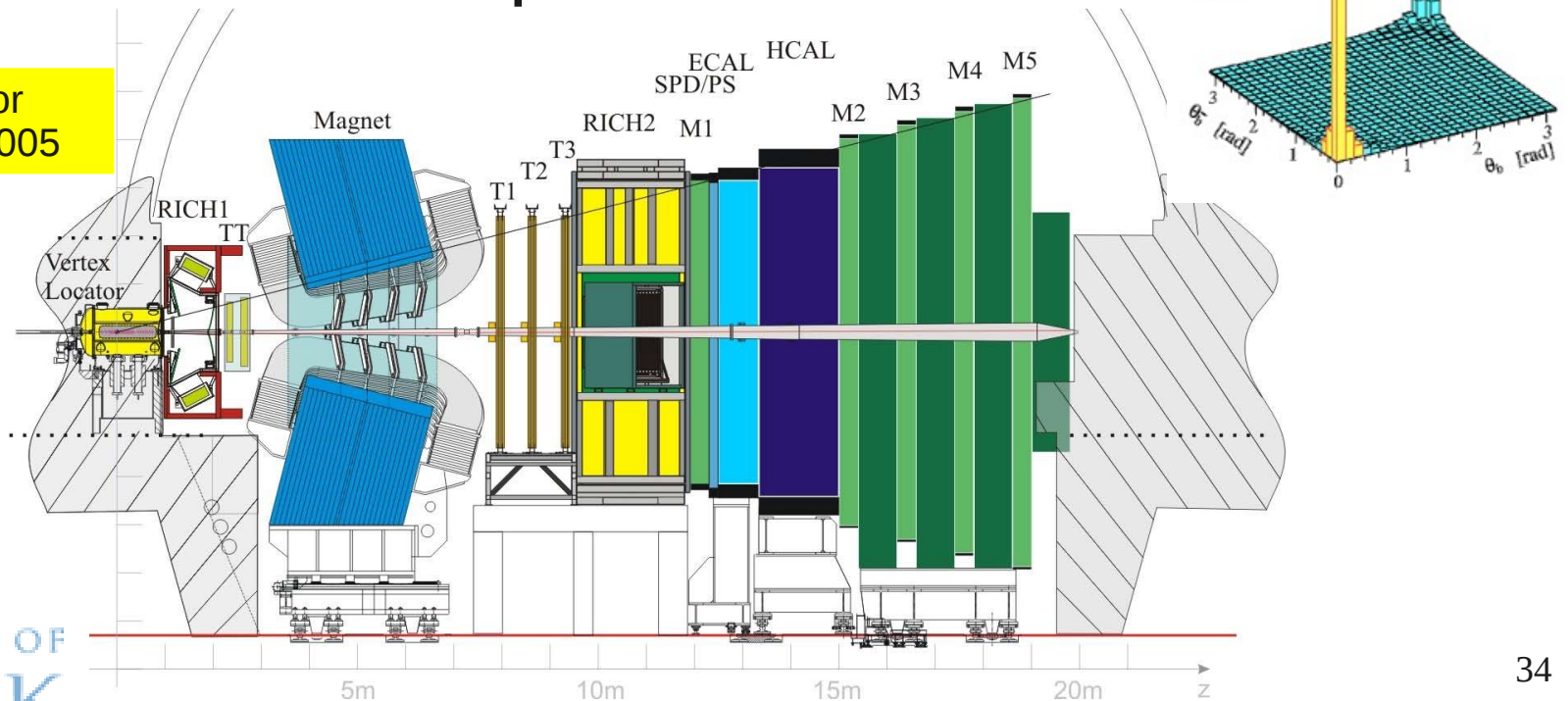

LHCb detector features

- Tracking and calorimetry
 - basic essentials of any collider experiment!
 - muon chambers
- VELO
 - reconstruct displaced vertices
- RICH
 - particle ID (K/ π separation)
- Trigger
 - fast and efficient

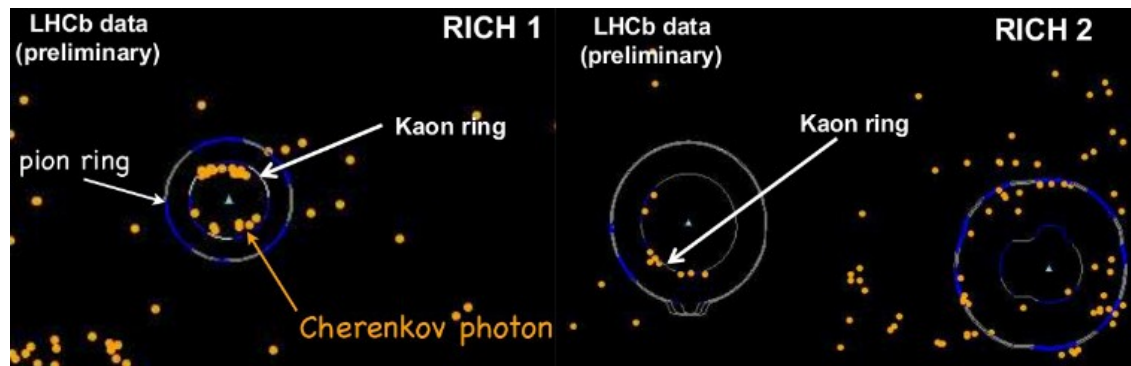
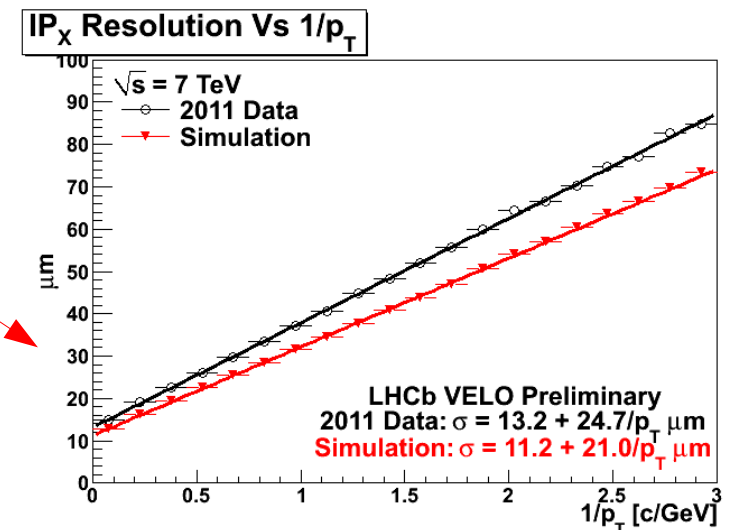

LHC performance 2011

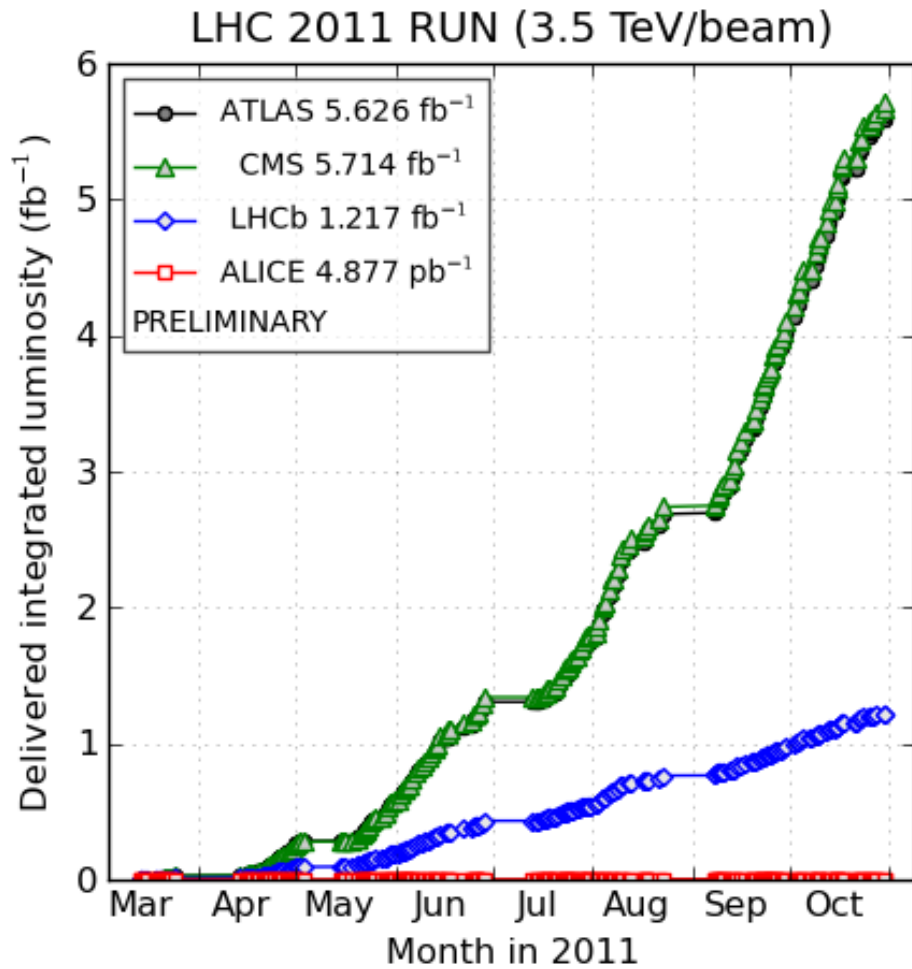

(generated 2011-12-01 19:35 including fill 2267)

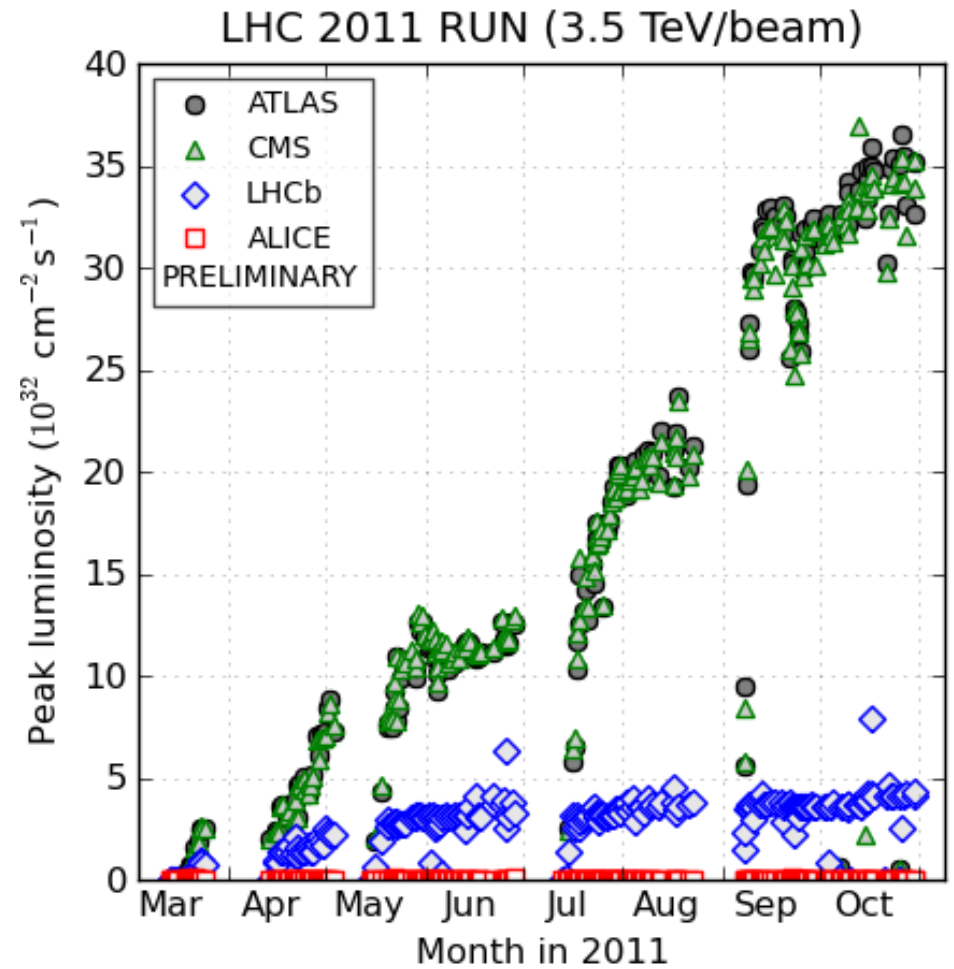

(generated 2011-12-01 19:35 including fill 2267)

PROTON PHYSICS: STABLE BEAMS

Energy:

3500 GeV

I(B1):

1.63e+14

I(B2):

1.61e+14

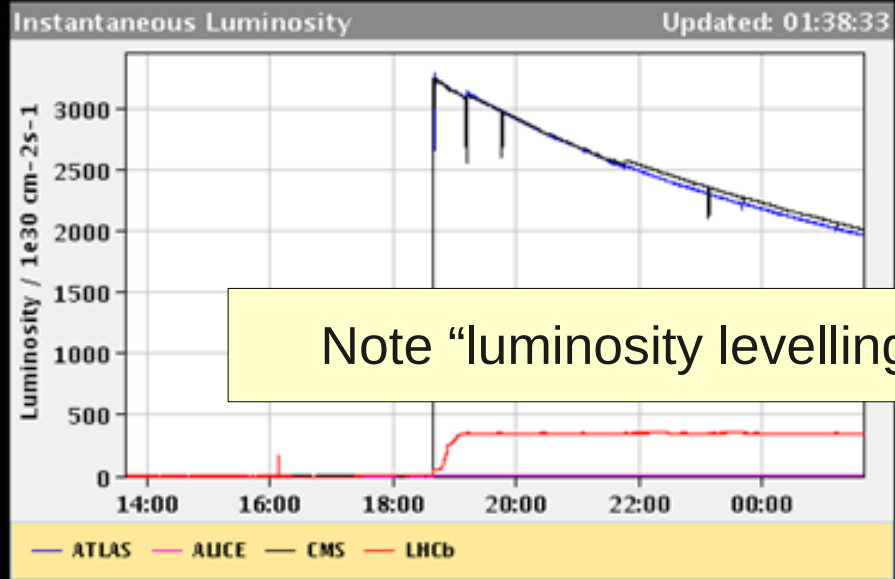
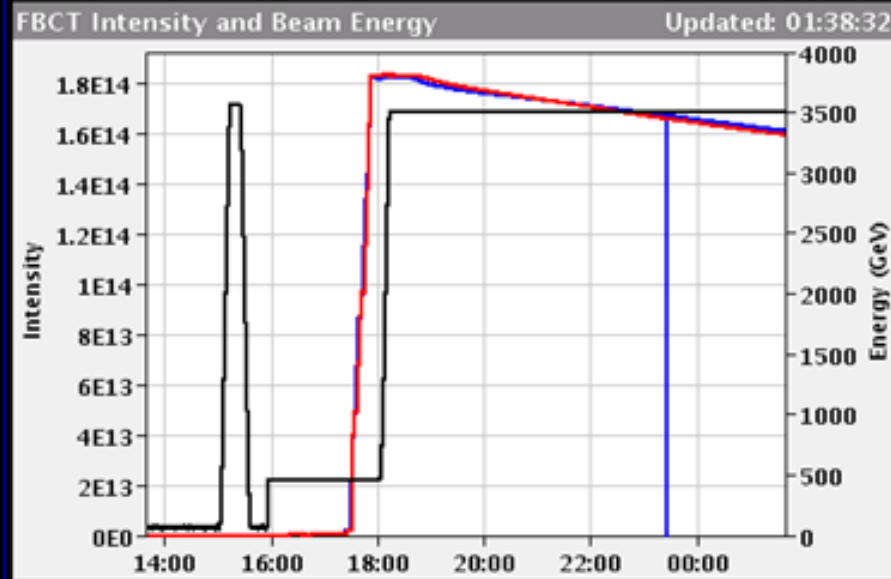

Comments 03-10-2011 01:37:51 :

*** STABLE BEAMS ***

!!! CONGRATULATIONS TO LHCb !!!

!!! FOR THEIR 1ST 1.00/fb !!!

BIS status and SMP flags

B1

B2

Link Status of Beam Permits

true true

Global Beam Permit

true true

Setup Beam

false false

Beam Presence

true true

Moveable Devices Allowed In

true true

Stable Beams

true true

PM Status B1

ENABLED

PM Status B2

ENABLED

2011 data taking

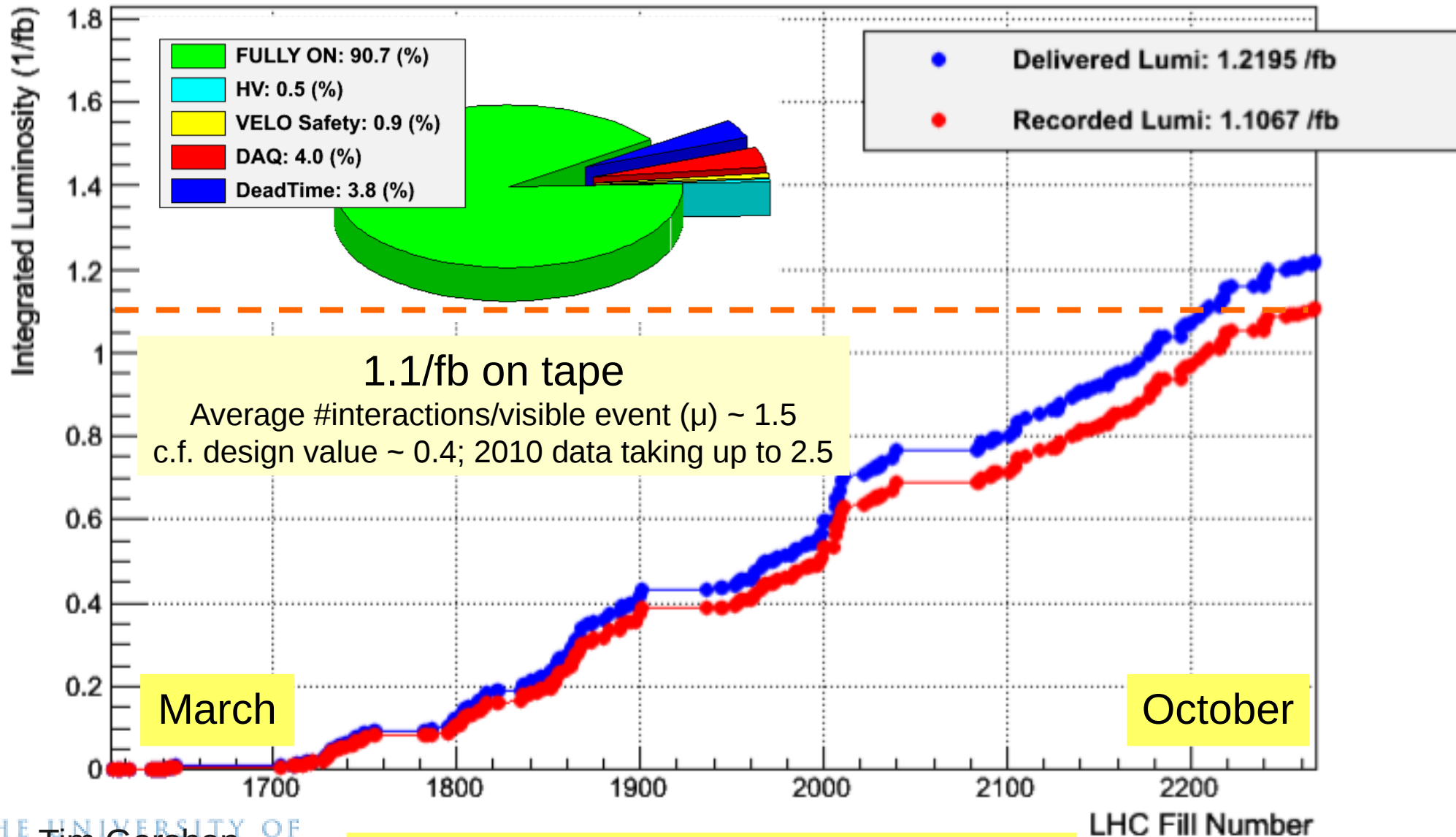

Data taking efficiency close to 91 %

2011 data reprocessing

Running reprocessing jobs, by site

8 Weeks from Week 38 of 2011 to Week 47 of 2011

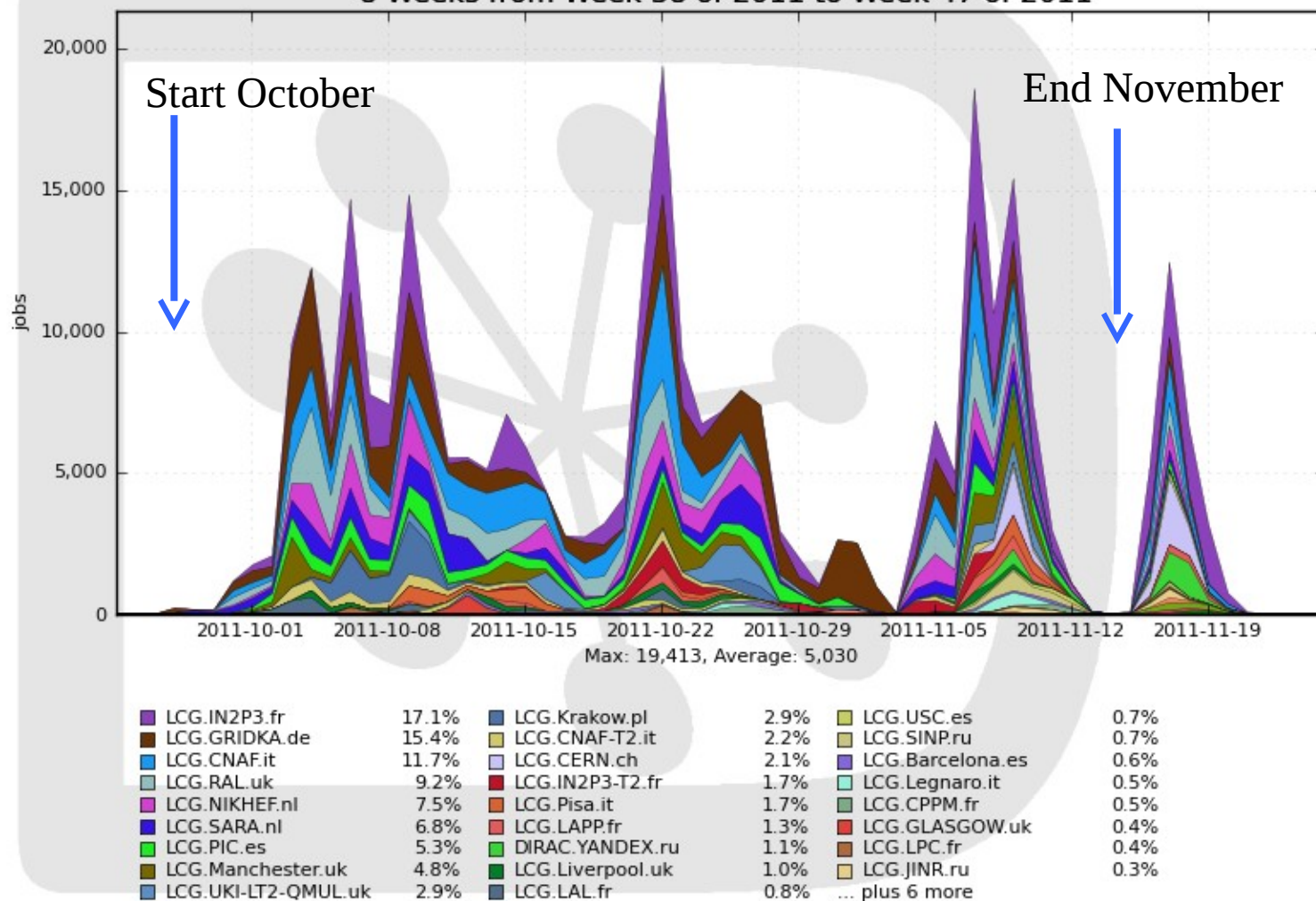

Generated on 2011-11-25 07:46:26 UTC

2012 data taking

LHCb Integrated Luminosity at 4 TeV in 2012

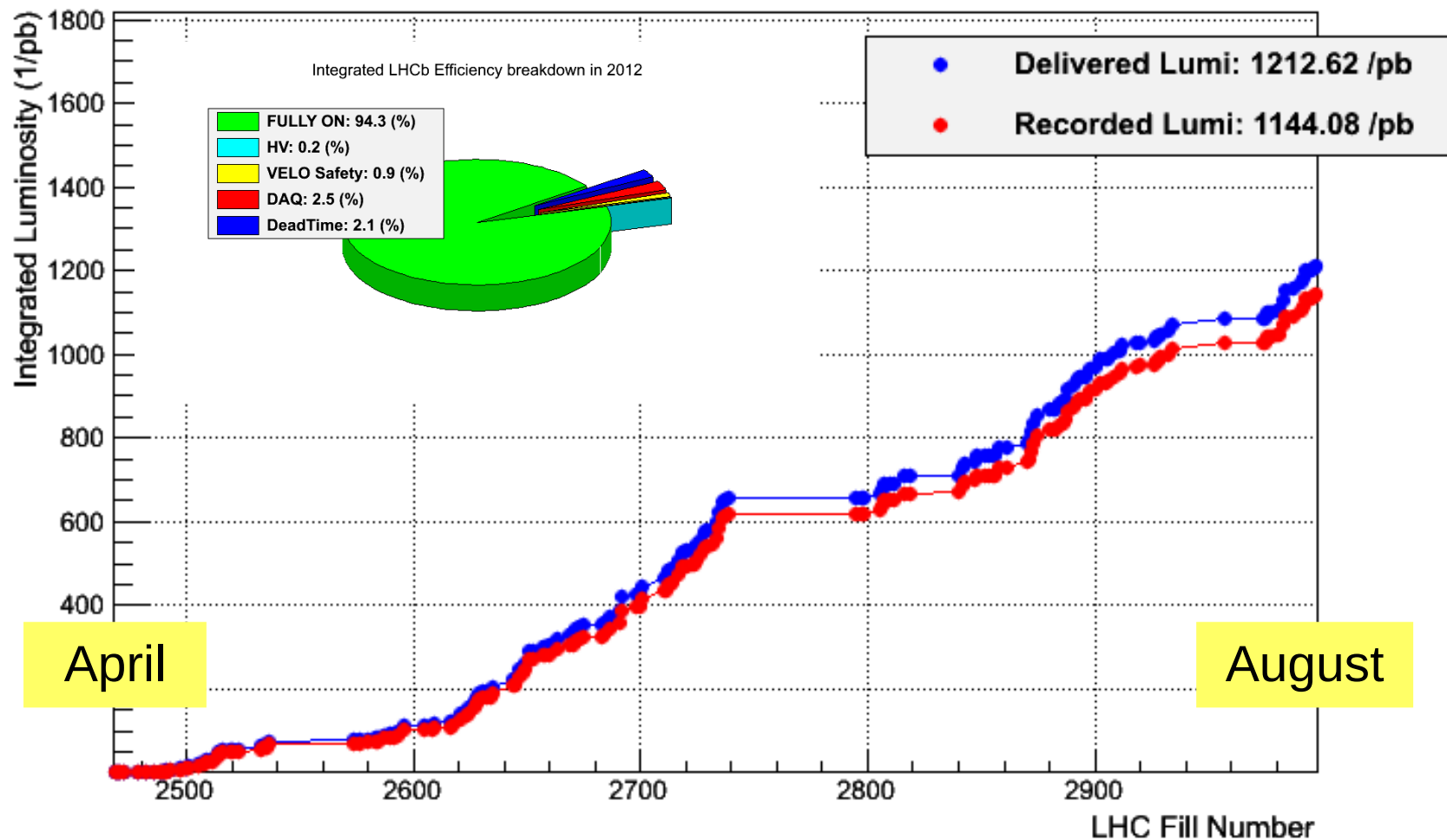

Heavy flavour production @ LHCb

“Prompt charm production in pp collisions at $\sqrt{s} = 7$ TeV”
LHCb-CONF-2010-013

“Measurement of J/ψ production in pp collisions at $\sqrt{s} = 7$ TeV”
Eur. Phys. J. C 71 (2011) 1645

$D^0+c.c.$ cross-section

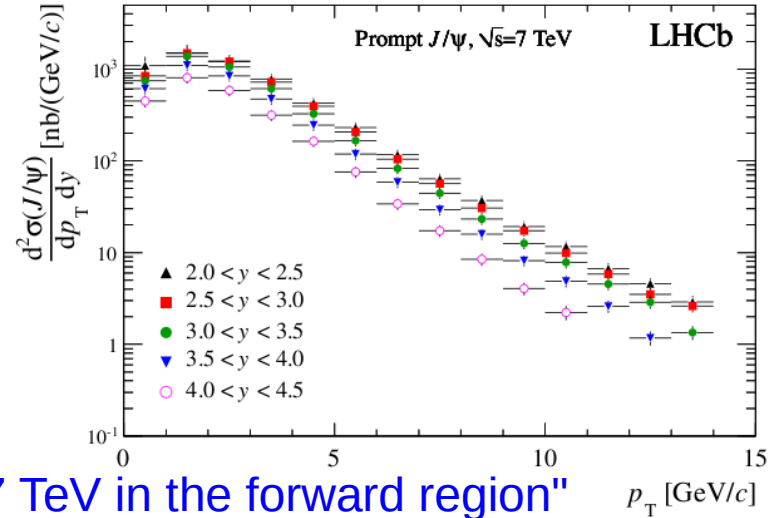
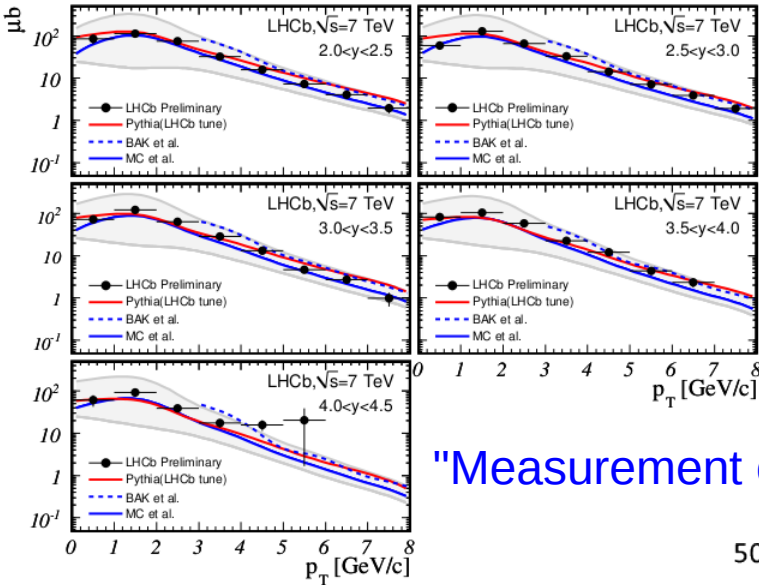

“Measurement of $\sigma(pp \rightarrow b\bar{b}X)$ at $\sqrt{s} = 7$ TeV in the forward region”
Physics Letters B 694 (2010) 209

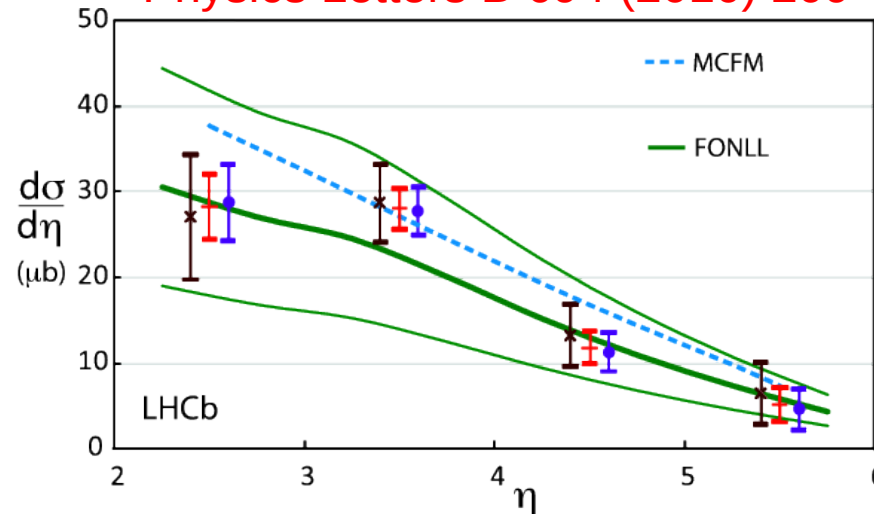

What does $\int L dt = 1/\text{fb}$ mean?

- Measured cross-section, in LHCb acceptance

$$\sigma(pp \rightarrow b\bar{b}X) = (75.3 \pm 5.4 \pm 13.0) \mu\text{b}$$

PLB 694 (2010) 209

- So, number of $b\bar{b}$ pairs produced

$$10^{15} \times 75.3 \times 10^{-6} \sim 10^{11}$$

- Compare to combined data sample of e^+e^- “B factories” BaBar and Belle of $\sim 10^9$ $B\bar{B}$ pairs

for any channel where the (trigger, reconstruction, stripping, offline) efficiency is not too small, LHCb has world's largest data sample

- p.s.: for charm, $\sigma(pp \rightarrow c\bar{c}X) = (6.10 \pm 0.93) \text{mb}$

LHCb-CONF-2010-013

The all important trigger

Challenge is

- to efficiently select most interesting B decays
- while maintaining manageable data rates

Main backgrounds

- “minimum bias” inelastic pp scattering
- other charm and beauty decays

Handles

- high p_T signals (muons)
- displaced vertices

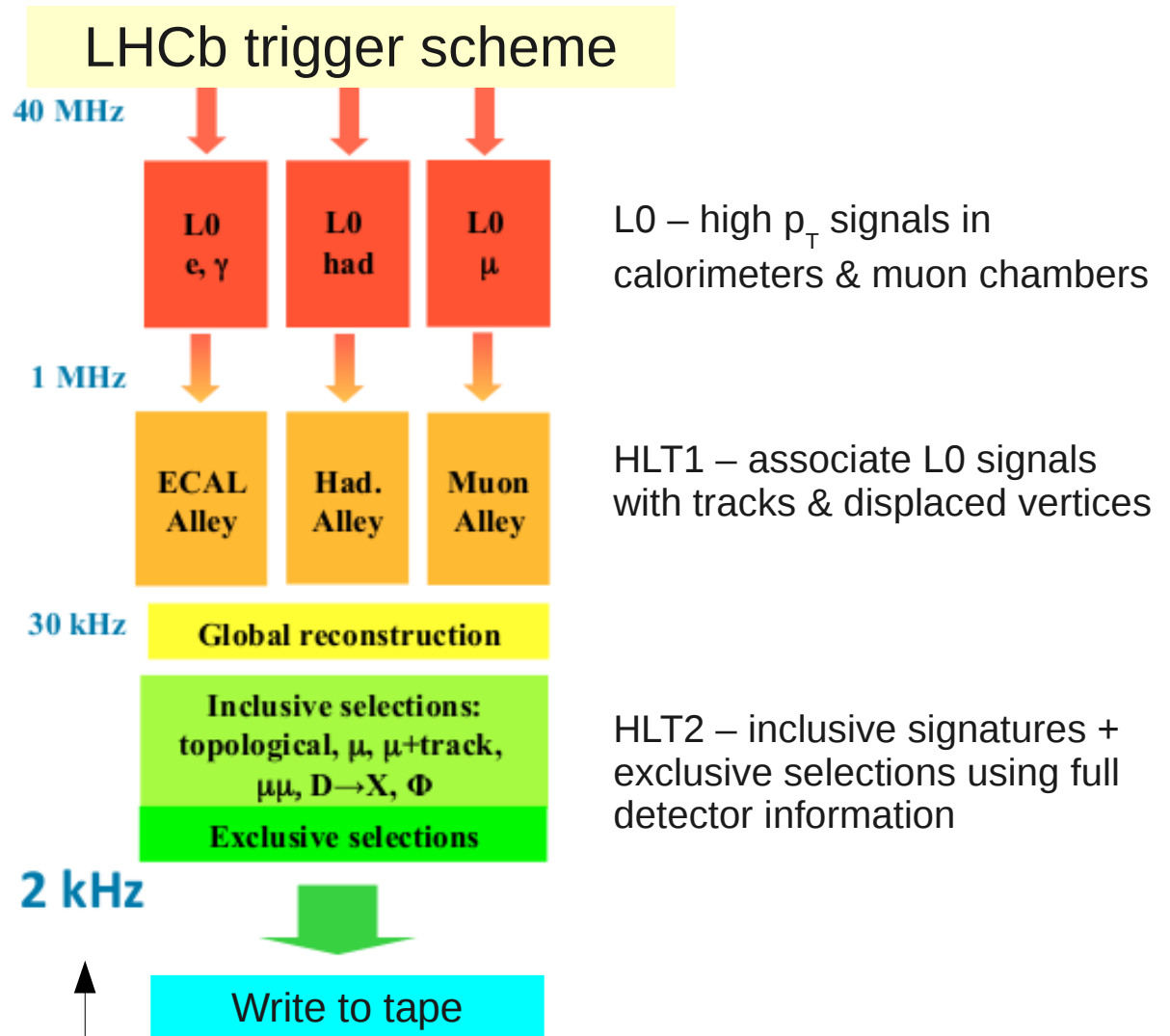

Increased up to 3 kHz in 2011 & 4.5 kHz in 2012

Spectroscopy

- I've talked about the headline items of flavour physics
 - CP violation, searches for new physics
 - what we tell the funding agencies, and the press
- But, much of the physics performed by flavour experiments is the study of properties of hadronic states
 - lifetimes, masses, decay channels, quantum numbers
 - and the discoveries of new ones

[1\] Observation of a narrow meson decaying to D+\(s\) pi0 at a mass of 2.32-GeV/c**2.](#)
By BABAR Collaboration (Bernard Aubert *et al.*). SLAC-PUB-9711, BABAR-PUB-03-011, Apr 2003. 7pp.
[Press Release from SLAC.](#)
Published in *Phys.Rev.Lett.*90:242001,2003.
e-Print: [hep-ex/0304021](#)

TOPCITE = 500+

[References](#) | [LaTeX\(US\)](#) | [LaTeX\(EU\)](#) | [Harvmac](#) | [BibTeX](#) | [Keywords](#) | Cited [521 times](#)
[Abstract](#) and [Postscript](#) and [PDF](#) from arXiv.org (mirrors: [au](#) [br](#) [cn](#) [de](#) [es](#) [fr](#) [il](#) [in](#) [it](#) [jp](#) [kr](#) [ru](#) [tw](#) [uk](#) [za](#) [aps](#) [lanl](#))
Journal Server [doi:[10.1103/PhysRevLett.90.242001](#)]
[BaBar Publications Database](#)
[BaBar Password Protected Publications Database](#)
[CERN Library Record](#)
[pdgLive \(measurements quoted by PDG\)](#)
[Press Release about this paper](#)
[SLAC Document Server](#)
[EXP SLAC-PEP2-BABAR](#)
[Bookmarkable link to this information](#)

[Observation of a narrow charmonium - like state in exclusive B+ - -> K+ - pi+ pi- J / psi decays.](#)
By Belle Collaboration (S.K. Choi *et al.*). Sep 2003. 10pp.
[Press release.](#)
Published in *Phys.Rev.Lett.*91:262001,2003.
e-Print: [hep-ex/0309032](#)

TOPCITE = 500+

[References](#) | [LaTeX\(US\)](#) | [LaTeX\(EU\)](#) | [Harvmac](#) | [BibTeX](#) | [Keywords](#) | Cited [514 times](#)
[Abstract](#) and [Postscript](#) and [PDF](#) from arXiv.org (mirrors: [au](#) [br](#) [cn](#) [de](#) [es](#) [fr](#) [il](#) [in](#) [it](#) [jp](#) [kr](#) [ru](#) [tw](#) [uk](#) [za](#) [aps](#) [lanl](#))
Journal Server [doi:[10.1103/PhysRevLett.91.262001](#)]
[pdgLive \(measurements quoted by PDG\)](#)
[Press Release about this paper](#)
[EXP KEK-BF-BELLE](#)
[Bookmarkable link to this information](#)

Most highly cited papers from BaBar and Belle

Why wasn't the η_b discovered at a hadronic experiment?

- Remember: $Y(1S)$ discovered at FNAL in 1977

- fixed target experiment: p on Be

PRL 39 (1977) 252

- η_b is lighter
- Hadron collisions produce all types of b hadrons
- So why couldn't the η_b be discovered, e.g., at the Tevatron?

Why wasn't the η_b discovered at a hadronic experiment?

- Remember: $Y(1S)$ discovered at FNAL in 1977
 - fixed target experiment: p on Be
- η_b is lighter
- Hadron collisions produce all types of b hadrons
- So why couldn't the η_b be discovered, e.g., at the Tevatron?
- **It's all about the trigger!**
 - need clean signature for trigger and reconstruction
 - CDF search used $\eta_b \rightarrow J/\psi J/\psi$ decay, with predicted BF $\sim 0!$

PRL 39 (1977) 252

Digression on a digression: The “Oops Leon”

Observation of High-Mass Dilepton Pairs in Hadron Collisions at 400 GeV

D. C. Hom, L. M. Lederman, H. P. Paar, H. D. Snyder, J. M. Weiss, and J. K. Yoh
Columbia University, New York, New York 10027*

and

J. A. Appel, B. C. Brown, C. N. Brown, W. R. Innes, and T. Yamanouchi
Fermi National Accelerator Laboratory, Batavia, Illinois 60510†

and

D. M. Kaplan
State University of New York at Stony Brook, Stony Brook, New York 11794*
(Received 28 January 1976)

We report preliminary results on the production of electron-positron pairs in the mass range 2.5 to 20 GeV in 400-GeV p -Be interactions. 27 high-mass events are observed in the mass range 5.5–10.0 GeV corresponding to $\sigma = (1.2 \pm 0.5) \times 10^{-35}$ cm² per nucleon. Clustering of 12 of these events between 5.8 and 6.2 GeV suggests that the data contain a new resonance at 6 GeV.

PRL 36 (1976) 1236

Homework exercise:

1. Read this paper
2. Do you find the “discovery” convincing?
3. Explain what's wrong

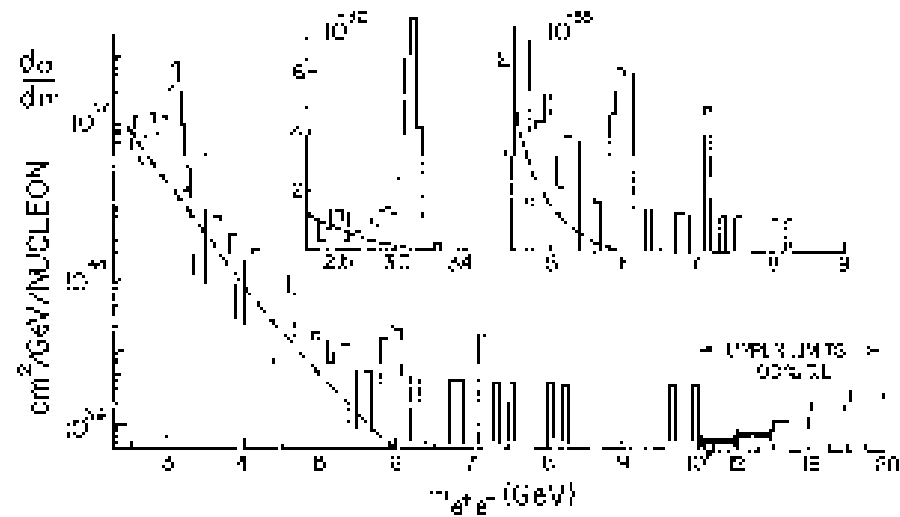
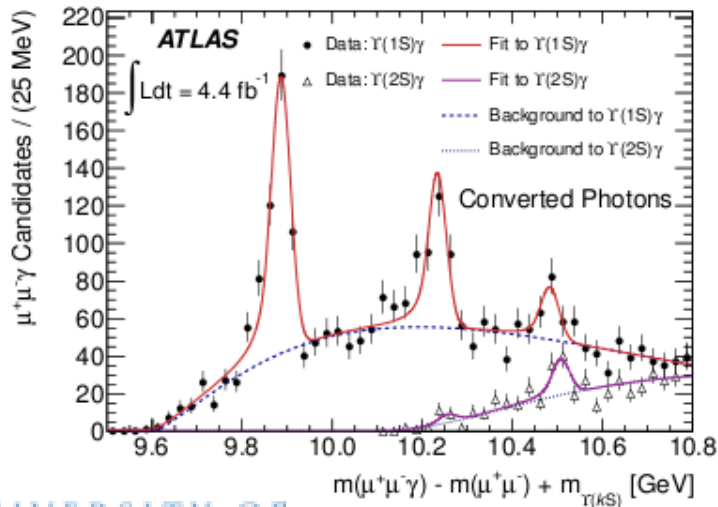
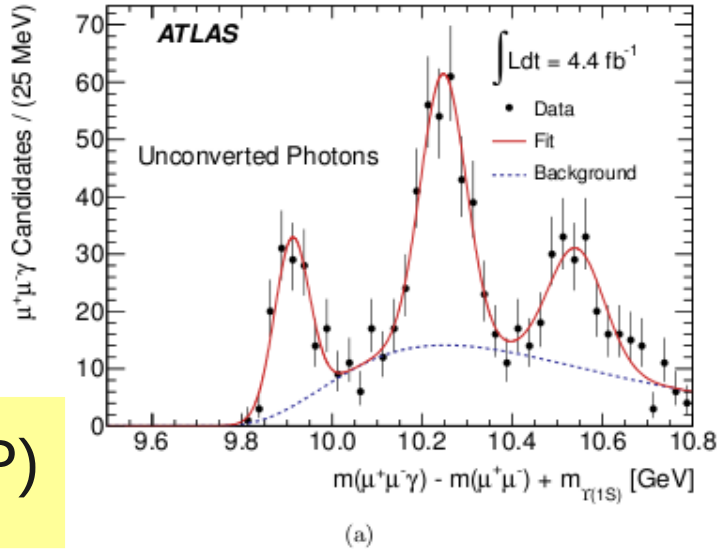

FIG. 2. Electron-positron mass spectrum: $d\sigma/dm$ per nucleon versus the effective mass. A linear Λ dependence is assumed. Note bin-width changes.

More new particles

ATLAS arXiv:1112.5154

$\chi_b(3P)$



CMS arXiv:1204.5955

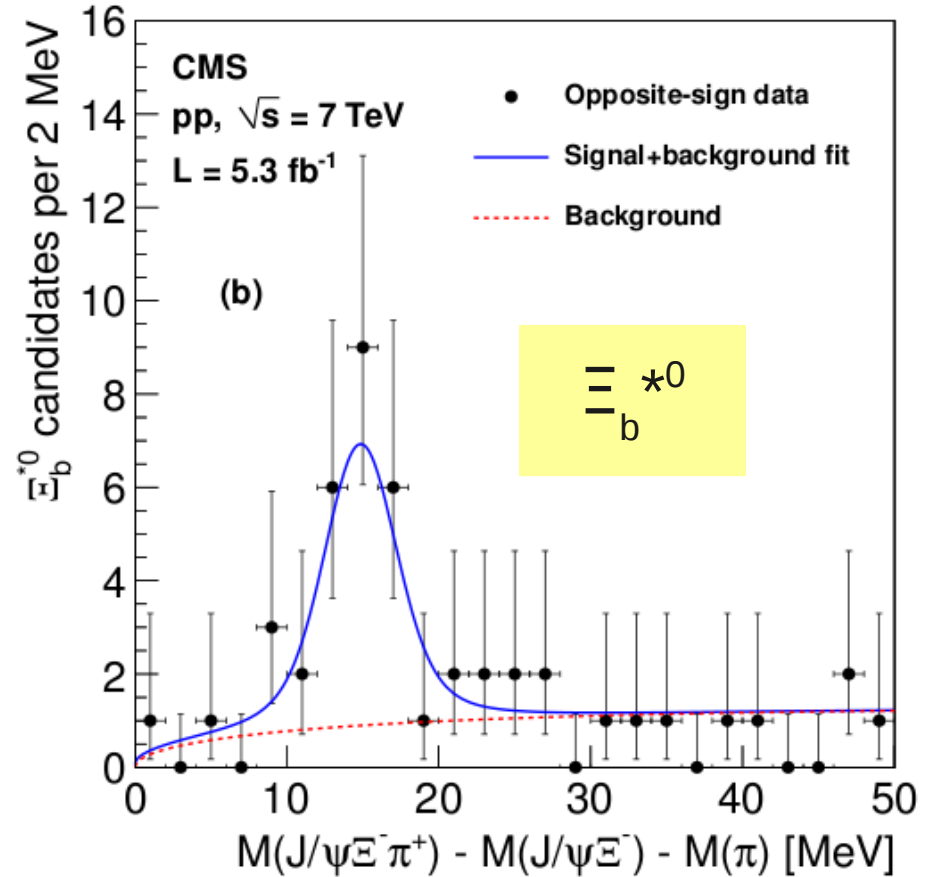

The smoking gun exotic hadron: A charged charmonium-like state

$$B^0 \rightarrow Z(4430)^- K^+, Z(4430)^- \rightarrow \psi' \pi^-$$

Belle PRL 100 (2008) 142001

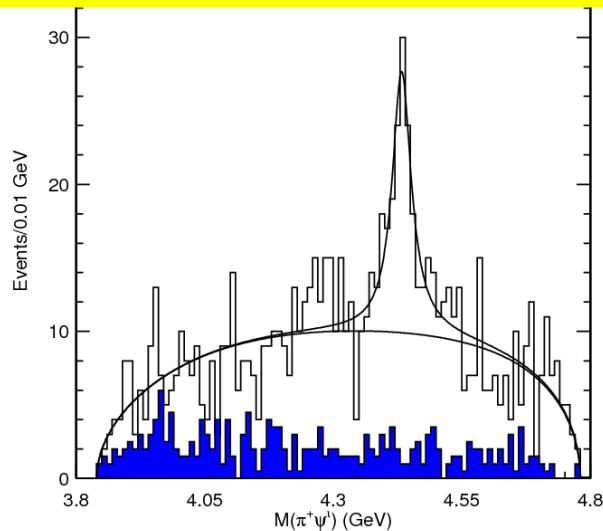

Clear peak

Still there in more detailed analysis

PRD 80 (2009) 031104

BABAR PRD 79 (2009) 112001

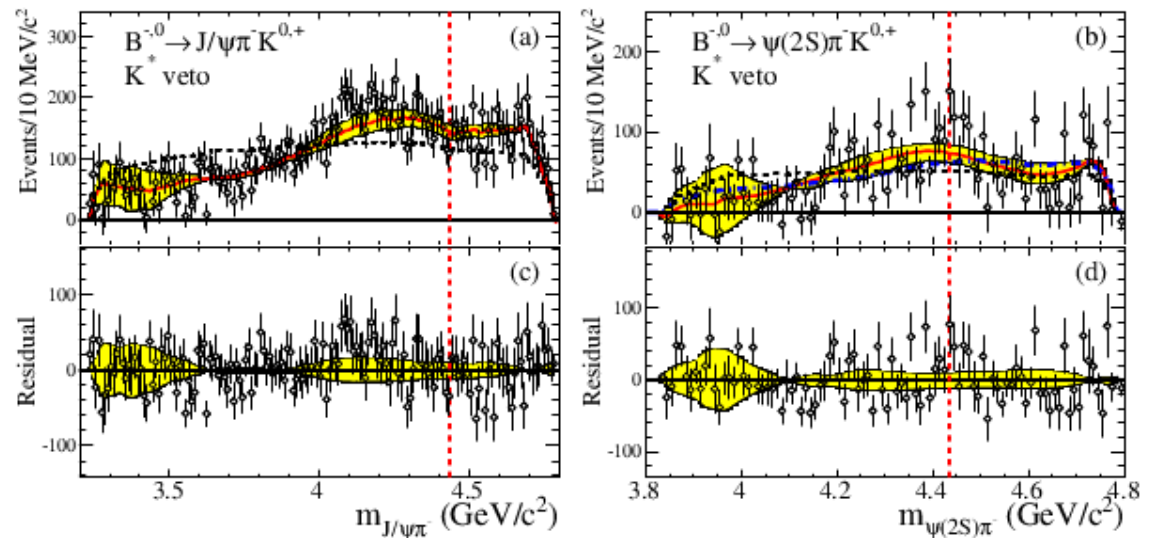

Data consistent with $K\pi$ reflections

Slight peak but no evidence for new state

But also consistent with Belle

Need more experimental input
(CDF, D0, ATLAS, CMS or LHCb)

Charged bottomonium-like states

Belle
PRL 108 (2012) 122001

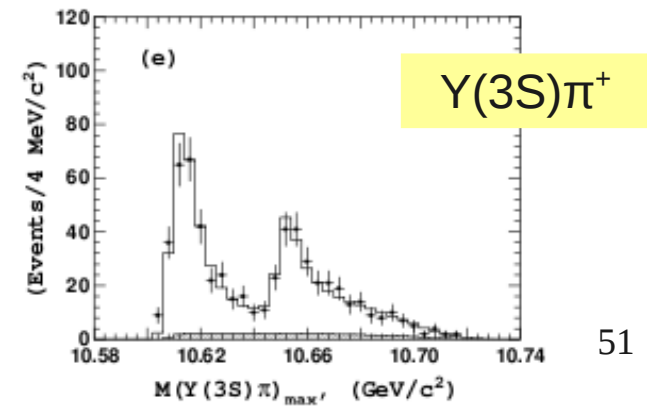
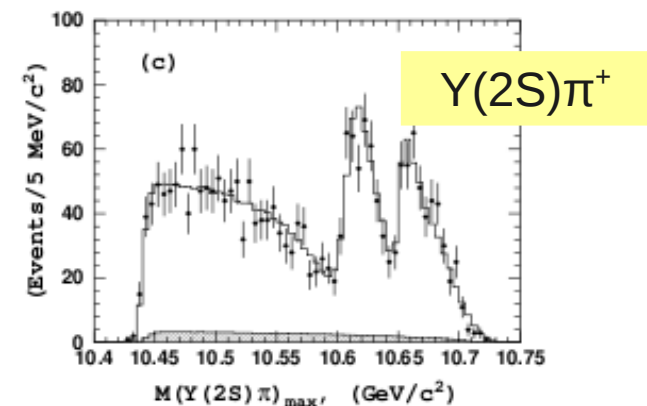
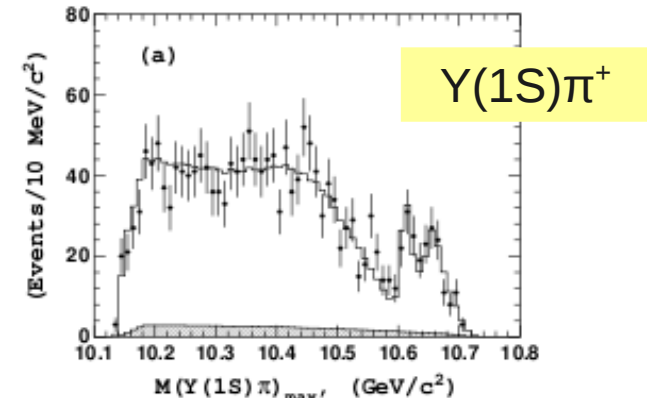
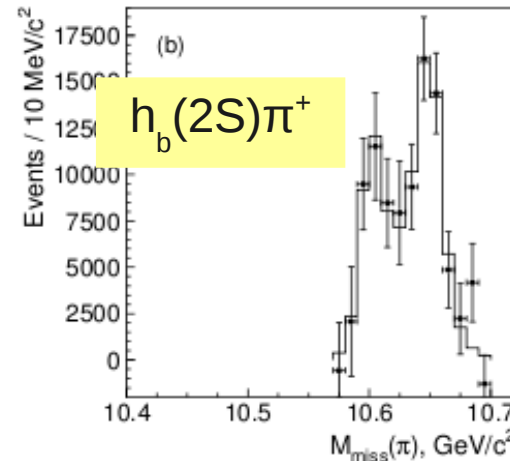
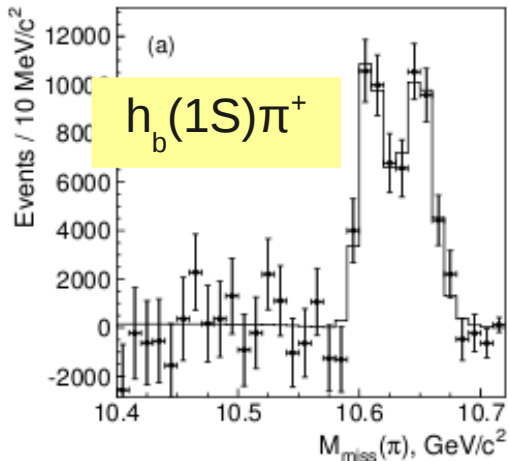

Final state	$\Upsilon(1S)\pi^+\pi^-$	$\Upsilon(2S)\pi^+\pi^-$	$\Upsilon(3S)\pi^+\pi^-$	$h_b(1P)\pi^+\pi^-$	$h_b(2P)\pi^+\pi^-$
$M[Z_b(10610)], \text{MeV}/c^2$	$10611 \pm 4 \pm 3$	$10609 \pm 2 \pm 3$	$10608 \pm 2 \pm 3$	$10605 \pm 2^{+3}_{-1}$	10599^{+6+5}_{-3-4}
$\Gamma[Z_b(10610)], \text{MeV}$	$22.3 \pm 7.7^{+3.0}_{-4.0}$	$24.2 \pm 3.1^{+2.0}_{-3.0}$	$17.6 \pm 3.0 \pm 3.0$	$11.4^{+4.5+2.1}_{-3.9-1.2}$	13^{+10+9}_{-8-7}
$M[Z_b(10650)], \text{MeV}/c^2$	$10657 \pm 6 \pm 3$	$10651 \pm 2 \pm 3$	$10652 \pm 1 \pm 2$	$10654 \pm 3^{+1}_{-2}$	10651^{+2+3}_{-3-2}
$\Gamma[Z_b(10650)], \text{MeV}$	$16.3 \pm 9.8^{+6.0}_{-2.0}$	$13.3 \pm 3.3^{+4.0}_{-3.0}$	$8.4 \pm 2.0 \pm 2.0$	$20.9^{+5.4+2.1}_{-4.7-5.7}$	$19 \pm 7^{+11}_{-7}$
Rel. normalization	$0.57 \pm 0.21^{+0.19}_{-0.04}$	$0.86 \pm 0.11^{+0.04}_{-0.10}$	$0.96 \pm 0.14^{+0.08}_{-0.05}$	$1.39 \pm 0.37^{+0.05}_{-0.15}$	$1.6^{+0.6+0.4}_{-0.4-0.6}$
Rel. phase, degrees	$58 \pm 43^{+4}_{-9}$	$-13 \pm 13^{+17}_{-8}$	$-9 \pm 19^{+11}_{-26}$	187^{+44+3}_{-57-12}	$181^{+65+74}_{-105-109}$