



**EUROPEAN ORGANISATION FOR NUCLEAR RESEARCH
EUROPEAN LABORATORY FOR PARTICLE PHYSICS**

TECHNICAL NOTE

CERN-SC-2005-139-RP-TN

HIGH-ENERGY HADRON FLUENCES IN THE LHCb CAVERN

C.Theis, D. Forkel-Wirth, S. Roesler, H. Vincke

Abstract

In the LHCb cavern cryogenic equipment that is required for the cooling of magnets between Point 1 and Point 7 was installed next to the LHCb detector. Due to the vicinity to the detector, radiation hardness of the used equipment is crucial, as possible failures would significantly affect the operational efficiency of the LHC. High-energy hadrons above 20 MeV are predominantly responsible for the occurrence of Single Event Effects that result in corrupted memories or even destructive failure. Consequently, FLUKA Monte Carlo simulations were performed to calculate the respective fluence values in order to evaluate the current locations and identify potential locations for a possible relocation.

CERN, Geneva, Switzerland
03.12.2007

1 INTRODUCTION

In order to cool superconducting magnets that are located between Point 1 and Point 7 of the Large Hadron Collider (LHC), cryogenic equipment has been installed in the experimental cavern of the LHCb experiment (UX85). The installation of the hardware, which includes control electronics, was performed in the vicinity of the LHCb detector on three different floor levels. For a detailed description about the type of electronics and the respective locations please refer to Ref. [1]. As a consequence, the electronics boards are exposed to significant particle fluences and the question arises, whether the failure rate is low enough for an efficient operation of the LHC.

As briefly described in Ref. [1] various types of damage to electronic circuits can be caused by radiation. Among them so called Single Event Effects (SEE) are triggered by hadrons of high energies. In order to estimate the effect integrated fluences above 20 MeV are typically considered. This stochastic effect is related to strong local ionization and the consequences range from corrupted memory or signal values to destructive failures. Various tests regarding the radiation hardness of different components have been performed by the TS group and it was estimated that, for example, an annual fluence of 1×10^8 hadrons/cm² would cause one failure per two operational days of the LHC in the electro-pneumatic valve positioners (WEKA) [2]. Previous studies of the radiation environment in the LHCb cavern were performed by the LHCb collaboration [**Error! Reference source not found.**], but they concentrated on the vicinity of the detector and did not include the locations of the cryogenic equipment. Therefore, FLUKA Monte Carlo calculations [**Error! Reference source not found.,Error! Reference source not found.**] were performed in which the high-energy hadron fluence in the UX85 and the neighbouring US85 cavern was investigated. The results should indicate locations that are suitable candidates for a possible relocation of the equipment in order to decrease the failure rate.

2 SIMULATION OF THE HADRON FLUENCES

For previous studies of the shielding design a model of the geometry was implemented in FLUKA [6]. This setup included the entire cavern and a simplified model of the LHCb detector. The applied simplifications resulted in a detector geometry that is accurate in terms of structural setup, dimensions and materials. However, not all of the details of the various detector parts were taken into account, as the geometry was implemented for the purpose of radiation protection studies and the major emphasis was put into the details of the radiation shielding. As can be seen subsequently the performed simplifications have a negligible effect for these calculations, which can be deduced from the good agreement with previous results [**Error! Reference source not found.**].

Figure 1 illustrates the actual FLUKA geometry that was used. This version was updated to comply with the latest modifications of the cavern. In order to consider a “worst-case scenario” the wall between the UX85 and US85 cavern was removed in the calculations, as it is made of very light material and 20cm thick only.

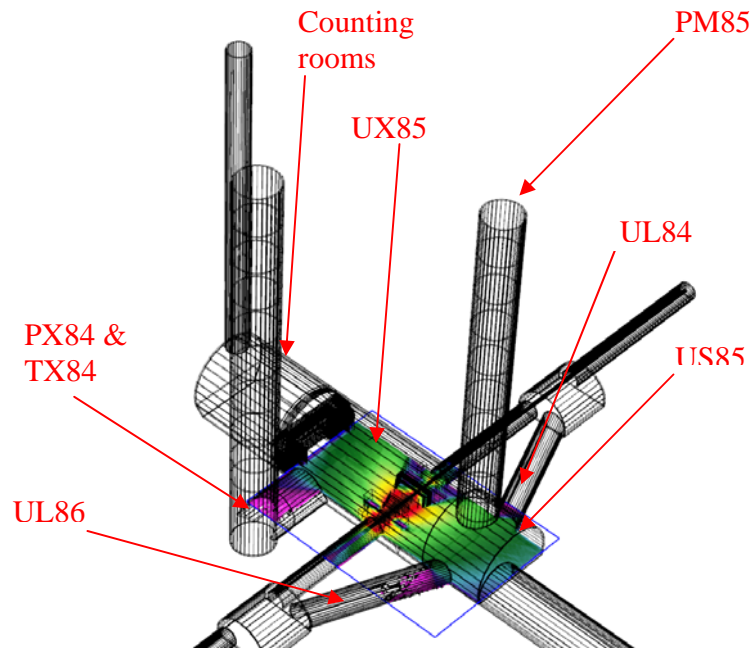

Figure 1 Sketch of the FLUKA geometry of the LHCb cavern that was used for the calculations.

The investigated scenario was based on the assumption of normal operation and thus, the radiation fields are caused by proton-proton collisions of 7 TeV at the interaction point of the LHCb detector. All particles produced by these interactions were calculated using version 3.0.4 of the event generator DPMJET-III [7]. With the help of user-developed FORTRAN routines the interaction products of 150000 proton-proton collisions were loaded into the 2005.6 version of FLUKA for further transport. The required normalization to the number of primary collisions was performed automatically by these routines. The statistical error of the obtained hadron fluences is illustrated in Figure 2. As can be seen the deviation from the mean is below 10% for most parts of the cavern, which indicates that the statistics of the FLUKA calculations are sufficient.

Due to the fact that only hadrons above 20 MeV were of interest electron and photon transport was switched off and the lower transport thresholds for hadrons were set to 20 MeV. Additionally, a magnetic field of the LHCb dipole (1.05 T) was assumed between the pole shims [8]. No biasing was used to avoid any statistical artifacts. All results shown below were obtained by superimposing a Cartesian grid of 50 x 50 x 50 cm on top of the geometry and averaging the fluence in the respective cell.

All values obtained by FLUKA calculations are normalized per p-p collision. Therefore, the data was scaled with an appropriate normalization factor which takes the parameters of LHC operation into account. A nominal luminosity of $L = 2 \times 10^{32}$ collisions/(cm² s) and an inelastic cross-section of $\sigma = 80$ mbarn was assumed. This yields a collision rate of 1.6×10^7 collisions/s. The data taking period for one year of LHC operation is stated to be 10^7 s. In agreement with previous studies [**Error! Reference source not found.**] a safety factor of 2 was taken into account, which is reasonable due to

unknown factors in the estimation of the radiation hardness of electronics. This yields a normalization factor of 3.2×10^{15} collisions for a period of 10 years.

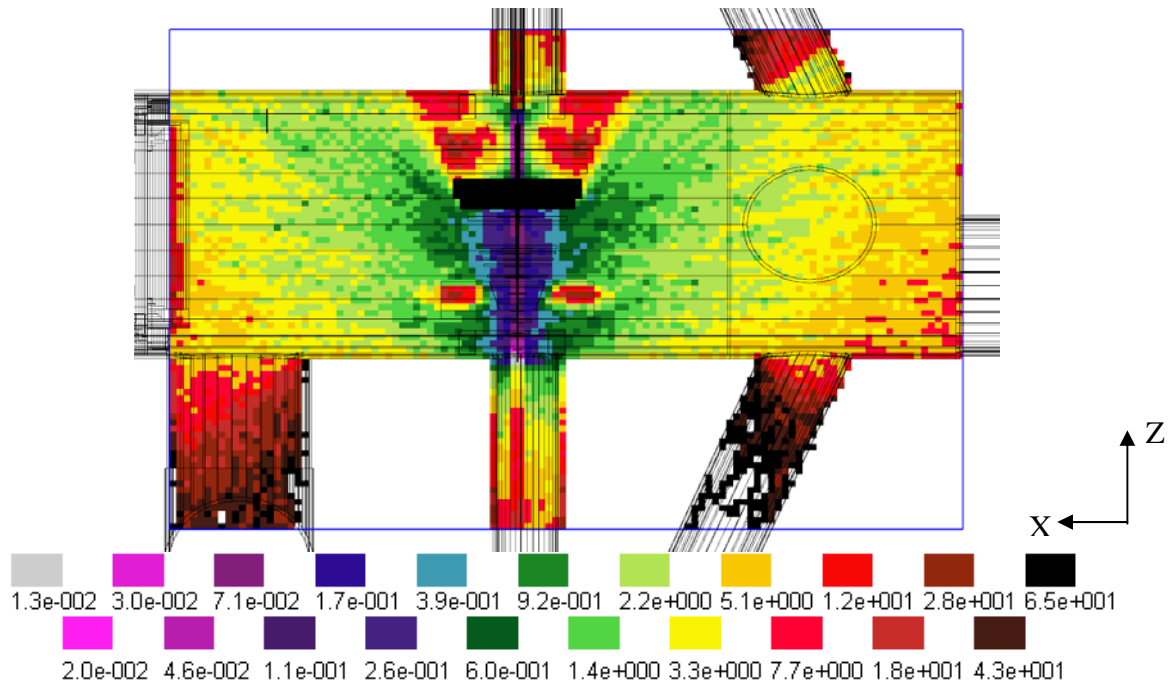

Figure 2 Plot of the relative statistical errors given in percent. It can be seen that the error of the calculated hadron fluences for the area of the cavern UX85/US85 is below 10%.

3 RESULTS

The installation of various electronic components for the cryogenics was performed on three different floor levels in the LHCb cavern: floor 0 at the level of the beam line, floor -1 at the floor of the UX cavern and floor 1 at 3m above the beam line. For a detailed layout and description of the components please refer to [1]. Figures 3 – 5 illustrate the obtained results of the high energetic hadron fluences on the different floors for an operation period of 10 years. In the area of the US85 cavern no fluences can be observed in the respective plot for floor -1 (Figure 4) because the level of this floor coincides with the beam-level (floor 0). As can be seen the cryogenic equipment is exposed to fluences ranging from $3.7 \times 10^9/\text{cm}^2 / 10$ years at the floor -1 up to $2.7 \times 10^{10}/\text{cm}^2 / 10$ years at floor 0 and floor 1.

Due to the conical propagation of the cascade lower fluence values of about $1 \times 10^9/\text{cm}^2 / 10$ years can be expected in the corner of the US85 cavern in the direction of the interaction point (IP). Furthermore, a significant decrease to a range from $10^7/\text{cm}^2 / 10$ years up to $10^8/\text{cm}^2 / 10$ years is visible in the areas that are shielded by the detector's calorimeter or in the doglegs UL86 and UL84 (see Figures 3 and 5).

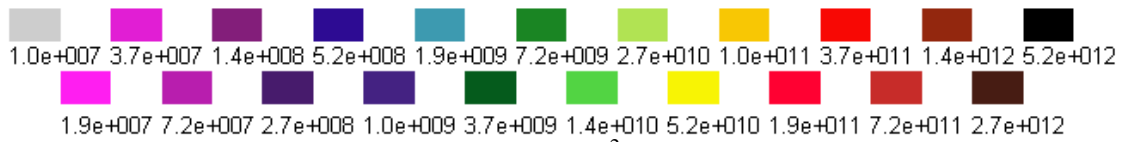
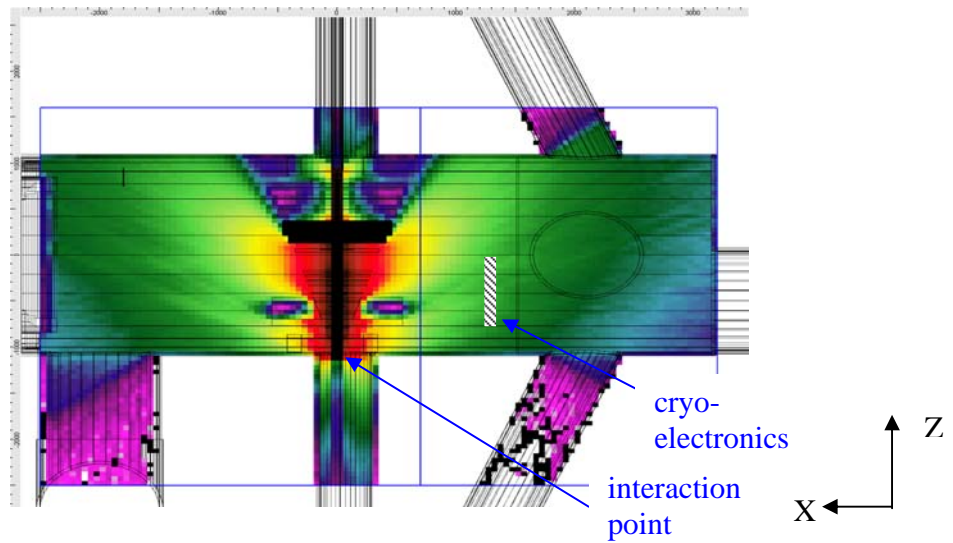

Figure 3 Hadron fluence ($E > 20$ MeV) [cm^{-2}] at the beam level (floor 0) after 10 years of LHC operation. A safety factor of 2 was included in the normalization.

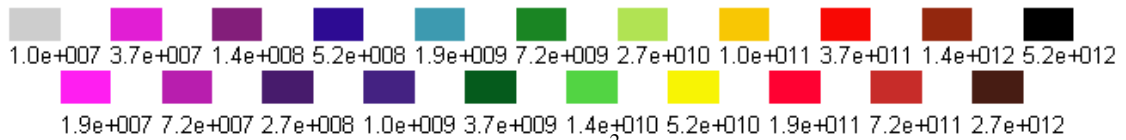
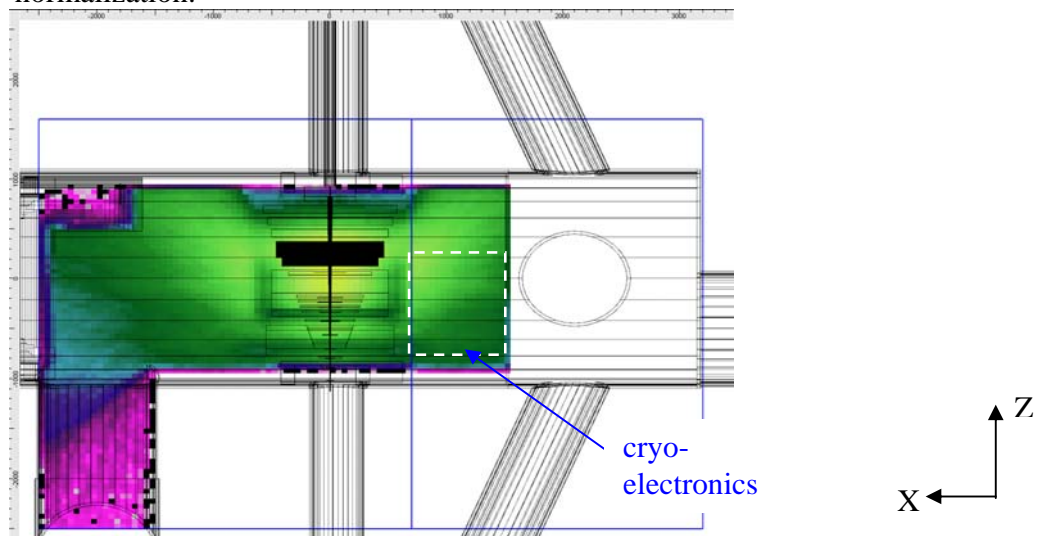

Figure 4 Hadron fluence ($E > 20$ MeV) [cm^{-2}] at 1 m above the floor of the UX85 cavern (floor -1), after 10 years of LHC operation. A safety factor of 2 was included in the normalization. The area of the UX85 cavern does not show any fluence in this plot because this floor coincides with the altitude of the beam level (floor 0).

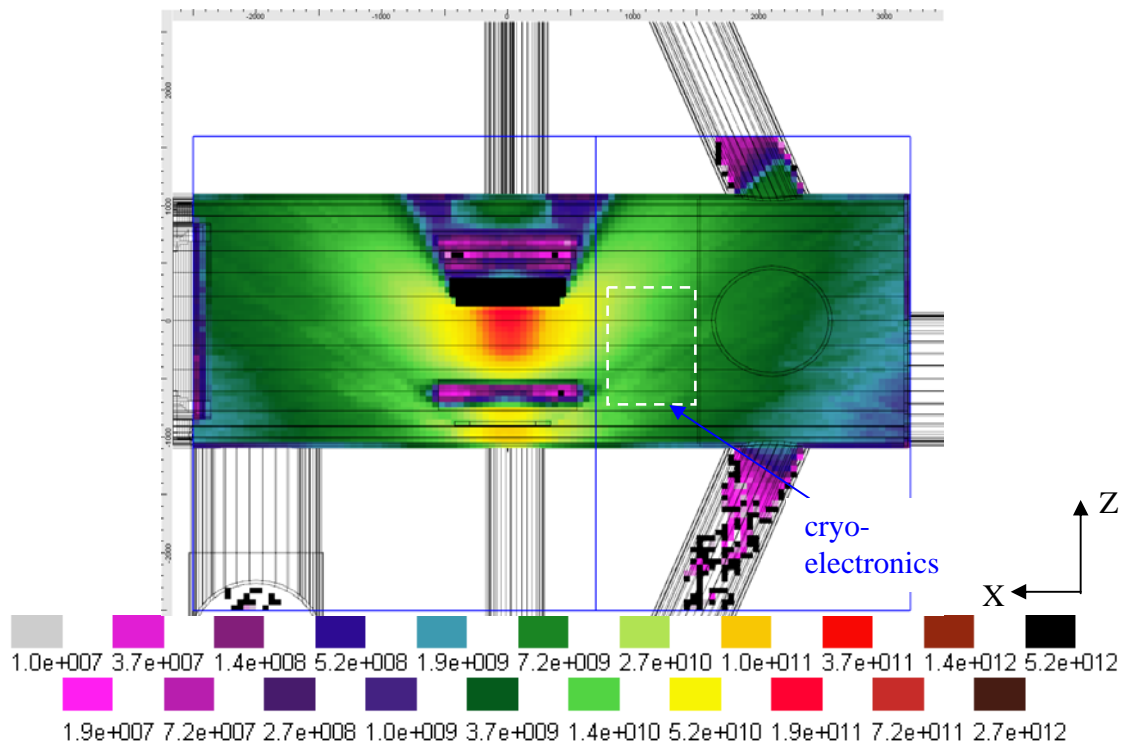

Figure 5 Hadron fluence ($E > 20 \text{ MeV}$) [cm^{-2}] at 3 m above the beam level of the UX85 cavern (floor 1), after 10 years of LHC operation. A safety factor of 2 was included in the normalization.

In order to see whether locations near the floor or the ceiling of the cavern can be considered as potential candidates for a possible relocation of the equipment, the fluences parallel to the beamline (Z direction) were investigated for different altitudes with respect to the cavern floor (Y direction). The results are illustrated in Figures 6 – 9 for a transverse distance of 8m and 13m from the beamline. The chosen distances correspond to the locations of the cryo-equipment [1] on the respective floor levels. It can be seen in Figure 6 that along the beamline, as well as with increasing vertical distance a notable gradient is only visible in the vicinity of the beamline. Farther away at 13m this gradient is already negligible, but the fluence values are still of the order of $10^{10}/\text{cm}^2 / 10 \text{ years}$ (see Figure 8).

Figures 10 – 13 depict the fluence values for transverse sections through UX85 and US85 caverns, at different distances downstream of the interaction point. It can be clearly seen that the lowest values are found in the upper right corner of Figure 10. The asymmetry of the fluence propagation near the beamline, that is visible in Figure 10, can be attributed to the fact that the beamline is not located in the center of the beam-tunnel. At further distances from the tunnel-mouth into the cavern this effect cannot be seen anymore (Figures 11 and 12).

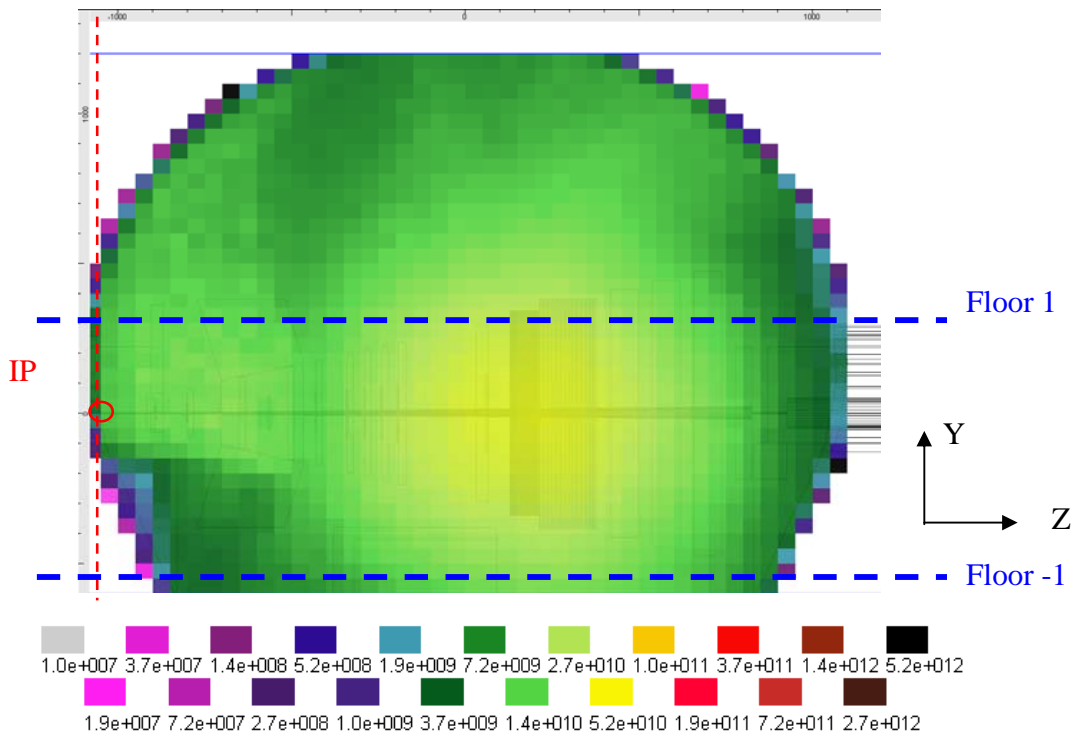

Figure 6 Hadron fluence ($E > 20$ MeV) [cm^{-2}] in the cavern at the location of the cryogenic equipment on floor 1 ($x = -800$ cm distance from the beamline) along the beamline.

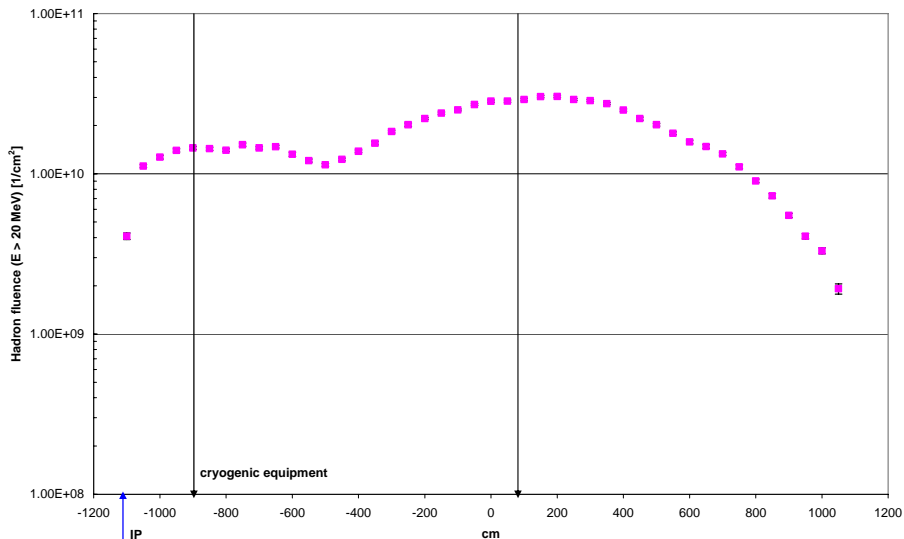

Figure 7 Hadron fluence ($E > 20$ MeV) [cm^{-2}] in the cavern at the location of the cryogenic equipment on floor 1 ($x = -800$ cm distance from the beamline, $y = 300$ cm above the beamline) parallel to the beam line. The errors are smaller than the size of the symbols.

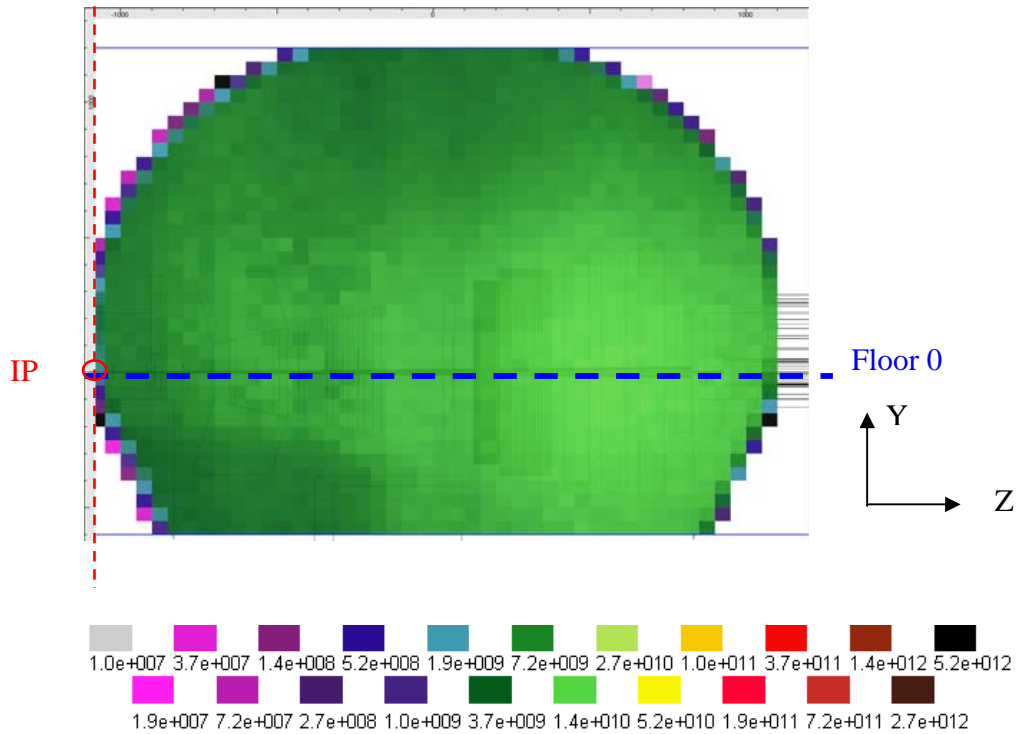

Figure 8 Hadron fluence (E > 20 MeV) [cm⁻²] in the cavern at the location of the cryogenic equipment on floor 0 (x = -1300 cm distance from the beamline) parallel to the beamline.

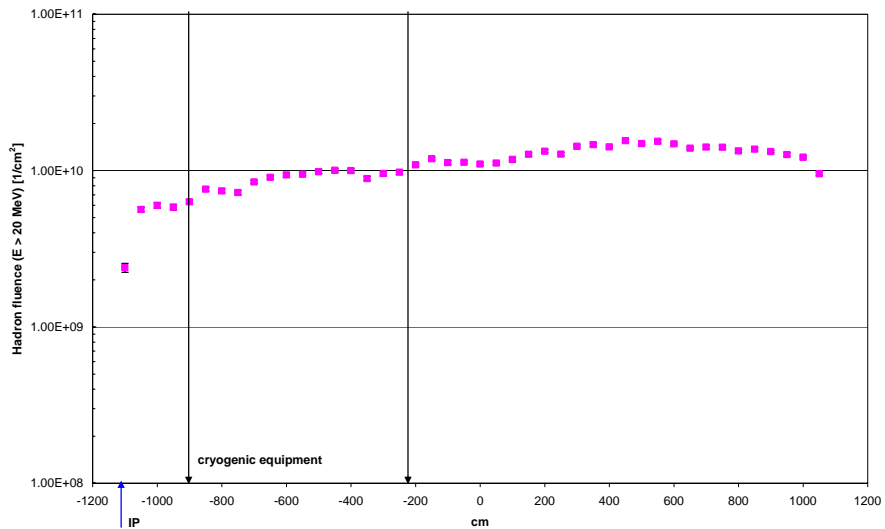

Figure 9 Hadron fluence (E > 20 MeV) [cm⁻²] in the cavern at the location of the cryogenic equipment (x = 1300 cm distance from the beamline) at the level of the beamline/ floor 0 (y = 0 cm) along the beam line. The errors are smaller than the size of the symbols.

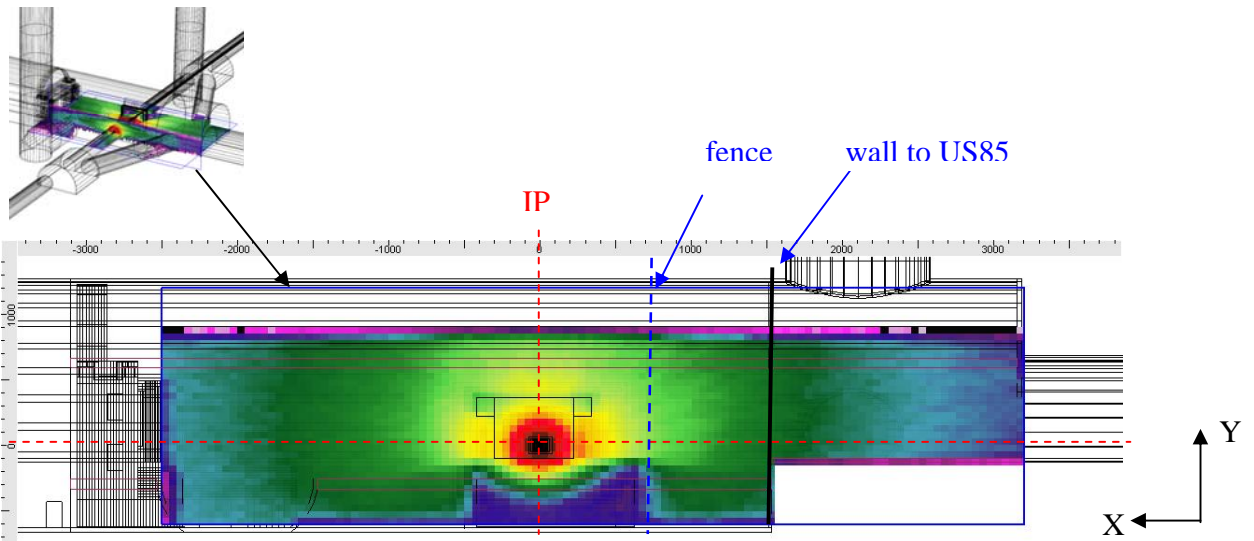

Figure 10 Hadron fluence ($E > 20$ MeV) [cm^{-2}] in the cavern at 200 cm downstream of the interaction point in transversal direction to the beamline.

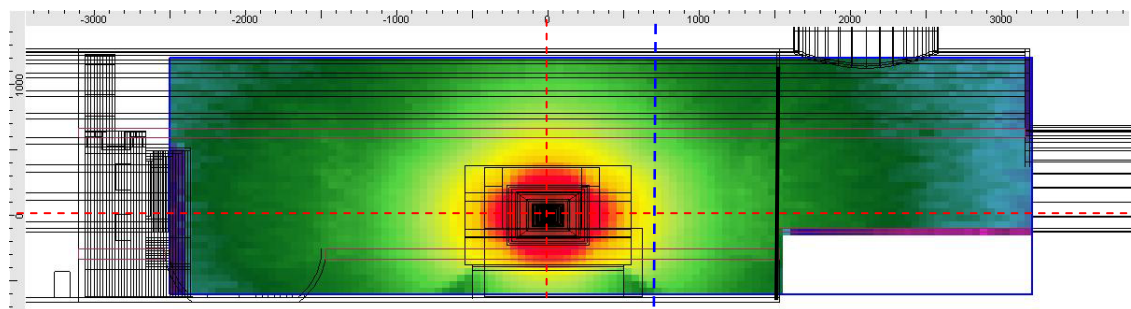

Figure 11 Hadron fluence ($E > 20$ MeV) [cm^{-2}] in the cavern at 900 cm downstream of the interaction point in transversal direction to the beamline.

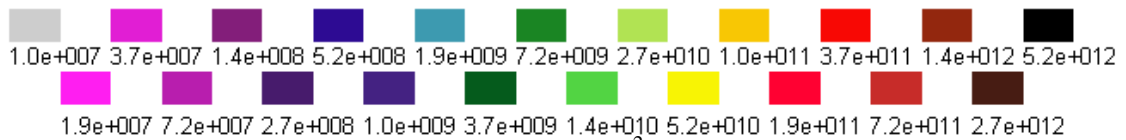
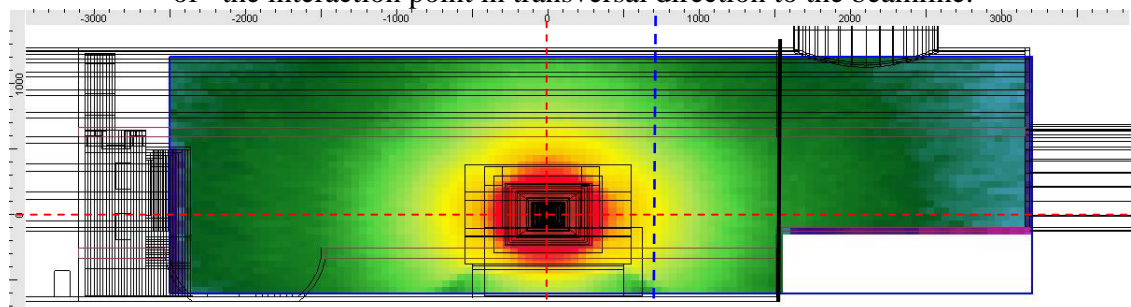

Figure 12 Hadron fluence ($E > 20$ MeV) [cm^{-2}] in the cavern at 1200 cm downstream of the interaction point in transversal direction to the beamline.

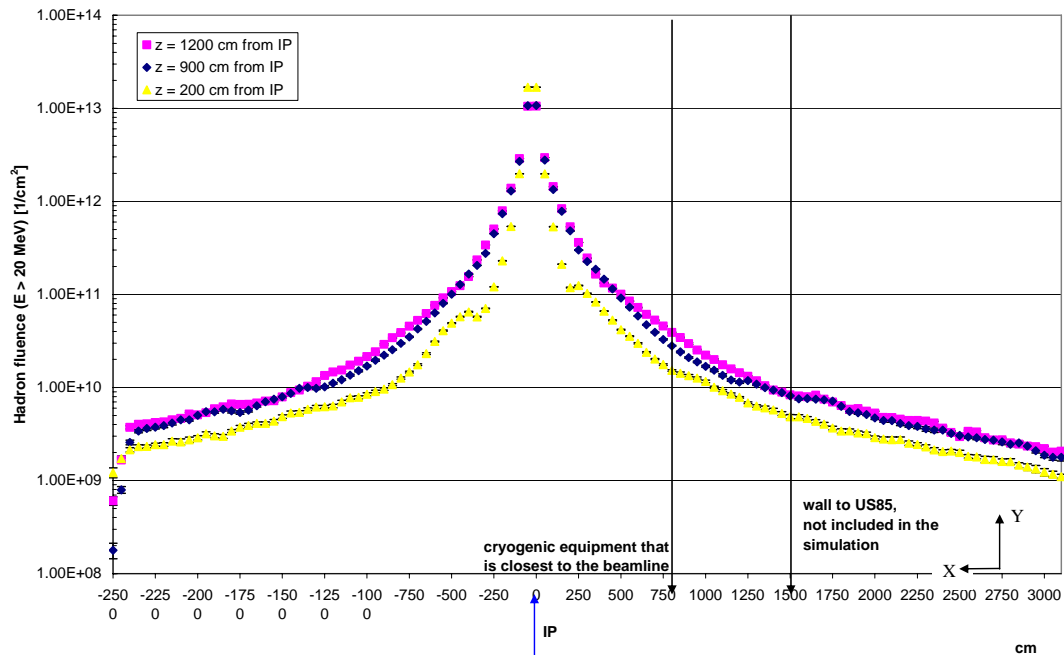

Figure 13 Hadron fluence ($E > 20$ MeV) [cm^{-2}] in the cavern at the level of the beamline (floor 0), in transversal direction to the beamline. The results are given for distances in Z to the interaction point. The errors are smaller than the size of the symbols.

Summary and conclusions

Next to the LHCb detector in the UX85 cavern cryogenic equipment was installed that is required for the cooling of magnets between Point 1 and Point 7. Due to the vicinity to the detector radiation hardness of the used equipment is crucial as possible failure would affect the operational efficiency of the LHC. Consequently, FLUKA Monte Carlo simulations were performed to calculate the fluence of high-energy hadrons above 20 MeV. These particles are predominantly responsible in the occurrence of Single Event Effects that result in corrupted memories or even destructive failure. Previous studies of the TS group have yielded failure rates estimates as a function of the hadron fluence. Taking these estimates into account the results of the FLUKA simulations indicate that relocation or shielding of radiation sensitive hardware is advisable to reduce the risk of operational failure, which would in turn affect the LHC. The most suitable location could be the UL86 passage, as one expects a reduction of the fluences by approximately a factor of up to 20. Whether this is a viable solution from a technical point of view with respect to the limitations in cable lengths and from a civil engineering point of view, has to be decided by the respective responsible groups.

Acknowledgements

The authors would like to thank Gloria Corti and Thijs Wijnands for providing technical specifications and very helpful discussions.

References

- 1 A. L. Perrot, T. Wijnands, *Radiation tolerance of the cryogenic equipment installed in the LHCb experimental cavern*, CERN Technical Note, TS-Note-2006-001, (2006).
- 2 T. Wijnands, *private communication*, (2006).
- 3 G. Corti, L. Shektman, *Radiation background in the LHCb experiment*, CERN Technical Note, LHCb-2003-083, (2003).
- 4 A. Fassò, A. Ferrari, J. Ranft, and P.R. Sala, *FLUKA: a multi-particle transport code*, CERN Yellow Report, INFN/TC_05/11, SLAC-R-773, (2005).
- 5 A. Fassò, A. Ferrari, S. Roesler, P.R. Sala, G. Battistoni, F. Cerutti, E. Gadioli, M.V. Garzelli, F. Ballarini, A. Ottolenghi, A. Empl and J. Ranft, *The physics models of FLUKA: status and recent developments*, Computing in High Energy and Nuclear Physics 2003 Conference (CHEP2003), La Jolla, CA, USA, March 24-28, 2003, (paper MOMT005) eConf C0303241 (2003), arXiv:hep-ph/0306267.
- 6 S. Roesler, G. R. Stevenson, *Radiation studies for LHC point 8*, CERN Internal report, CERN/TIS-RP/IR/99-22, (1999).
- 7 S. Roesler, R. Engel and J. Ranft, *The Monte Carlo event generator DPMJET-III*, Proc. Monte Carlo 2000 Conference, Lisbon, October 23-26 2000, A. Kling, F. Barao, M. Nakagawa, L. Tavora, P. Vaz eds., Springer-Verlag Berlin, pp. 1033-1038, (2001).
- 8 G. Corti, *private communication*, (2006).