



BASICS OF QCD FOR THE LHC

LECTURE I

Fabio Maltoni

Center for Particle Physics and Phenomenology (CP3)
Université Catholique de Louvain



CLAIMS AND AIMS

There has been a number of key theoretical results recently in the quest of achieving the best possible **predictions** and **description** of events at the LHC.

Perturbative QCD applications to LHC physics in conjunction with Monte Carlo developments are **VERY** active lines of theoretical research in particle phenomenology.

In fact, **new dimensions** have been added to
Theory \Leftrightarrow Experiment interactions



CLAIMS AND AIMS

Four lectures:

1. Intro and QCD fundamentals
2. QCD in the final state
3. QCD in the initial state
4. From accurate QCD to useful QCD

basics

apps



CLAIMS AND AIMS

- perspective: the big picture
- concepts: QCD from high- Q^2 to low- Q^2 , asymptotic freedom, infrared safety, factorization
- tools & techniques: Fixed Order (FO) computations, Parton showers, Monte Carlo's (MC)
- recent progress: merging MC's with FO, new jet algorithms
- sample applications at the LHC: Drell-Yan, Higgs, Jets, BSM,...



CLAIMS AND (YOUR) AIMS



Think



Ask



Work

Mathematica notebooks on a “simple” NLO calculation and other exercises on QCD applications to LHC phenomenology available on the MadGraph Wiki.

<https://cp3.irmp.ucl.ac.be/projects/madgraph/wiki/CernSchool13>



MINIMAL REFERENCES

- Ellis, Stirling and Webber: The Pink Book
- Excellent lectures on the archive by M. Mangano, P. Nason, and more recently by G. Salam, P. Skands.

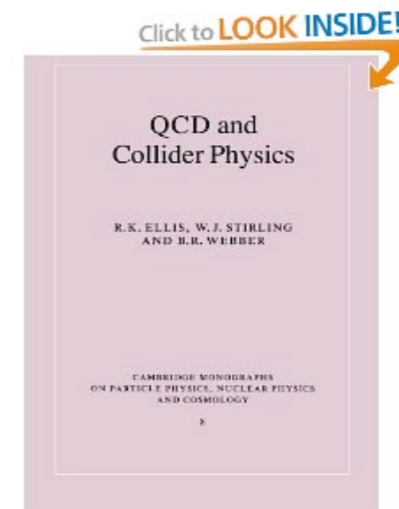



QCD : THE FUNDAMENTALS

1. QCD is a good theory for strong interactions: facts
2. From QED to QCD: the importance of color
3. Renormalization group and asymptotic freedom



STRONG INTERACTIONS

Strong interactions are characterized at moderate energies by a single* dimensionful scale, Λ_s , of few hundreds of MeV:

$$\sigma_h \cong 1/\Lambda_s^2 \cong 10 \text{ mb}$$

$$\Gamma_h \cong \Lambda_s$$

$$R \cong 1/\Lambda_s \cong 1 \text{ fm}$$

No hint to the presence of a small parameter! Very hard to understand and many attempts...

*neglecting quark masses...!!!



STRONG INTERACTIONS

Nowadays we have a satisfactory model of strong interactions based on a non-abelian gauge theory, QCD.

Why is QCD a good theory?

1. Hadron spectrum
2. Scaling
3. QCD: a consistent QFT
4. Low energy symmetries
5. MUCH more....



HADRON SPECTRUM

- Hadrons are made up of spin 1/2 quarks, of different flavors (d,u,s,c,b,[t])
- Each flavor comes in three colors, thus quarks carry a flavor and a color index

$$\psi_i^{(f)}$$

- The SU(3) symmetry acting on color is exact:

$$\psi_i \rightarrow \sum_k U_{ik} \psi_k$$
$$\sum_k \psi_k^* \psi_k \quad \leftarrow \text{Mesons}$$
$$\sum_{ijk} \epsilon^{ijk} \psi_i \psi_j \psi_k \quad \leftarrow \text{Baryons}$$



HADRON SPECTRUM

Note that physical states are classified in multiplets of the FLAVOR $SU(3)_f$ group!

$$3_f \otimes \bar{3}_f = 8_f \oplus 1_f$$

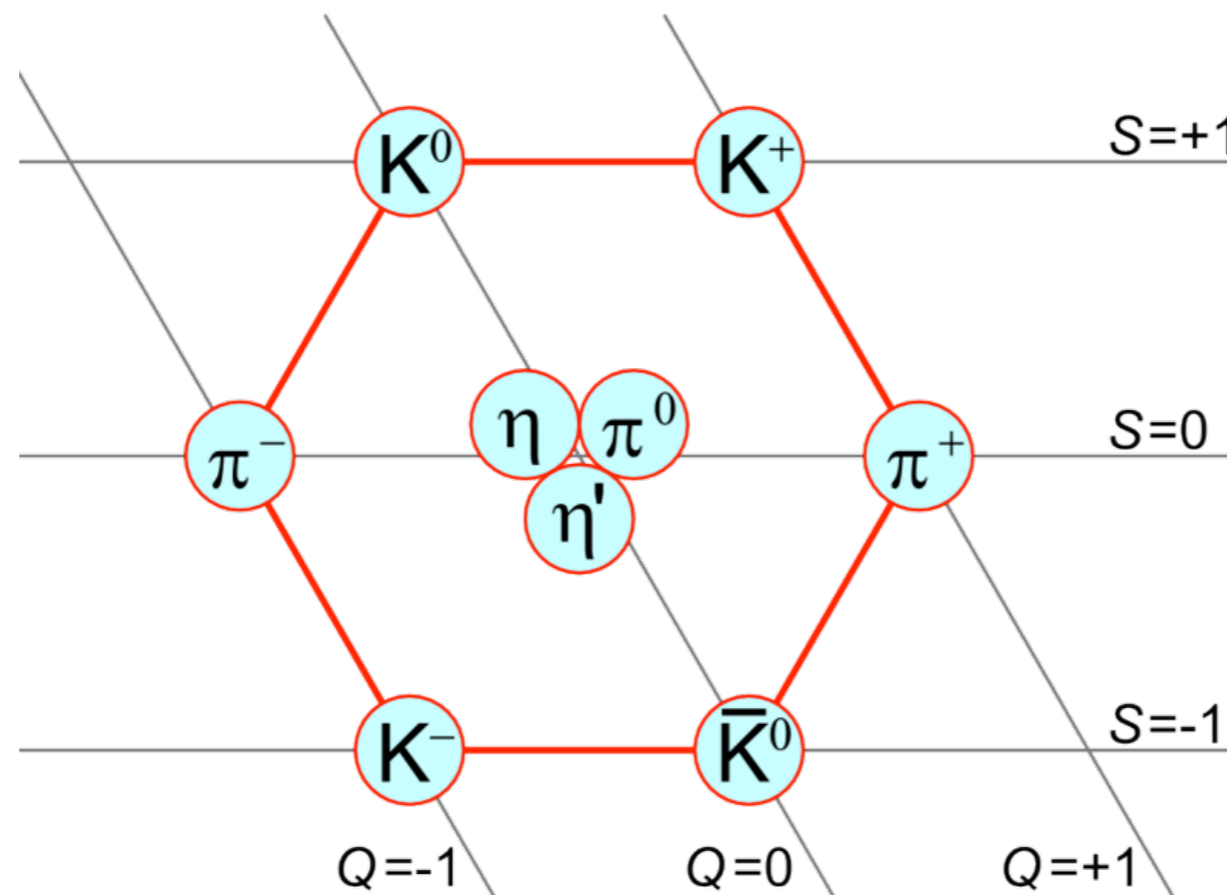



HADRON SPECTRUM

Note that physical states are classified in multiplets of the FLAVOR $SU(3)_f$ group!

$$3_f \otimes 3_f \otimes 3_f = 10_S \oplus 8_M \oplus 8_M \oplus 1_A$$

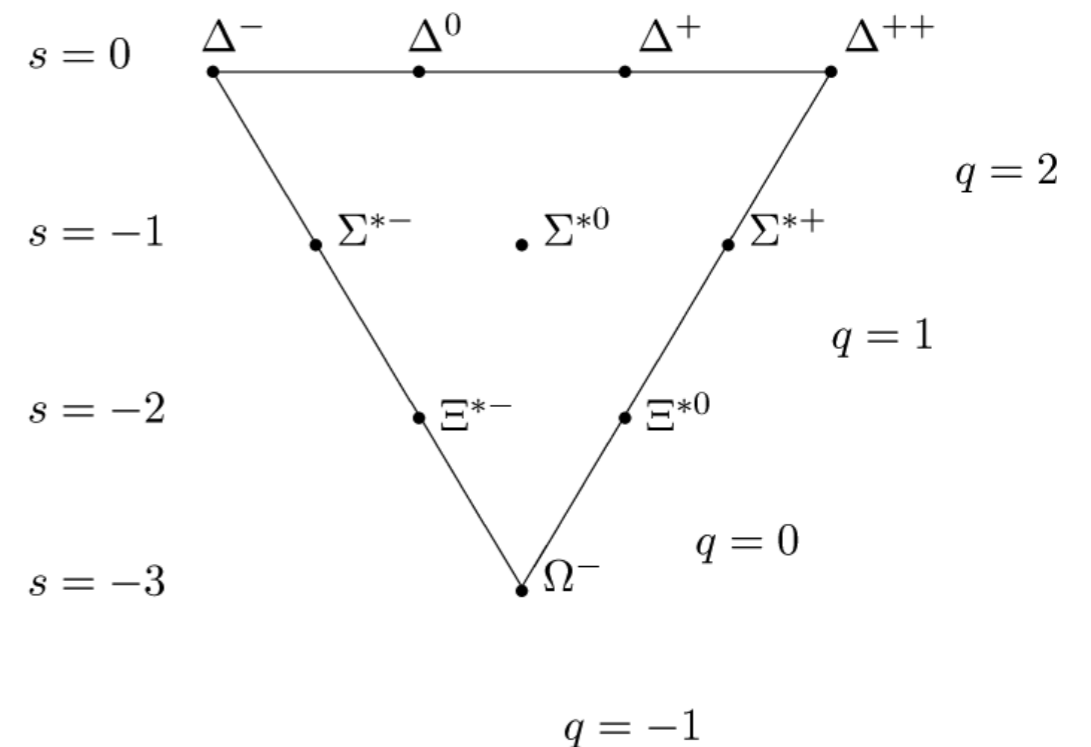
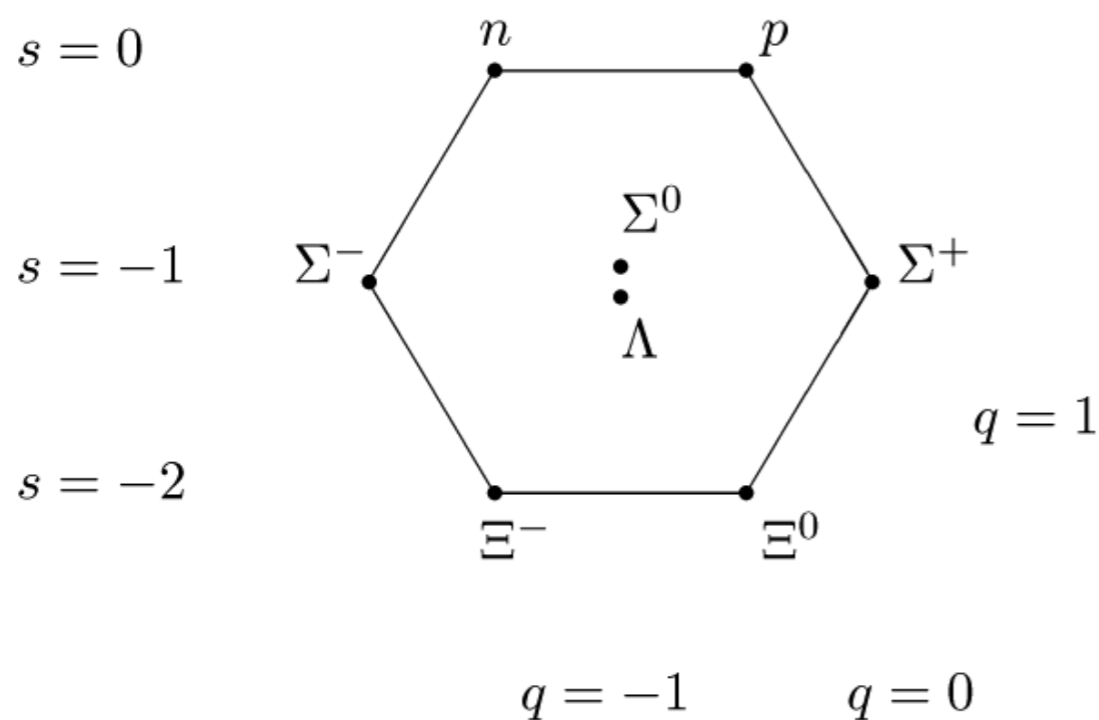

We need an extra quantum number (color) to have the Δ^{++} with similar properties to the Σ^0 . All particles in the multiplet have symmetric spin, flavour and spatial wave-function. Check that $n_q - n_{qbar} = n \times N_c$, with n integer.



HOW MANY COLORS?

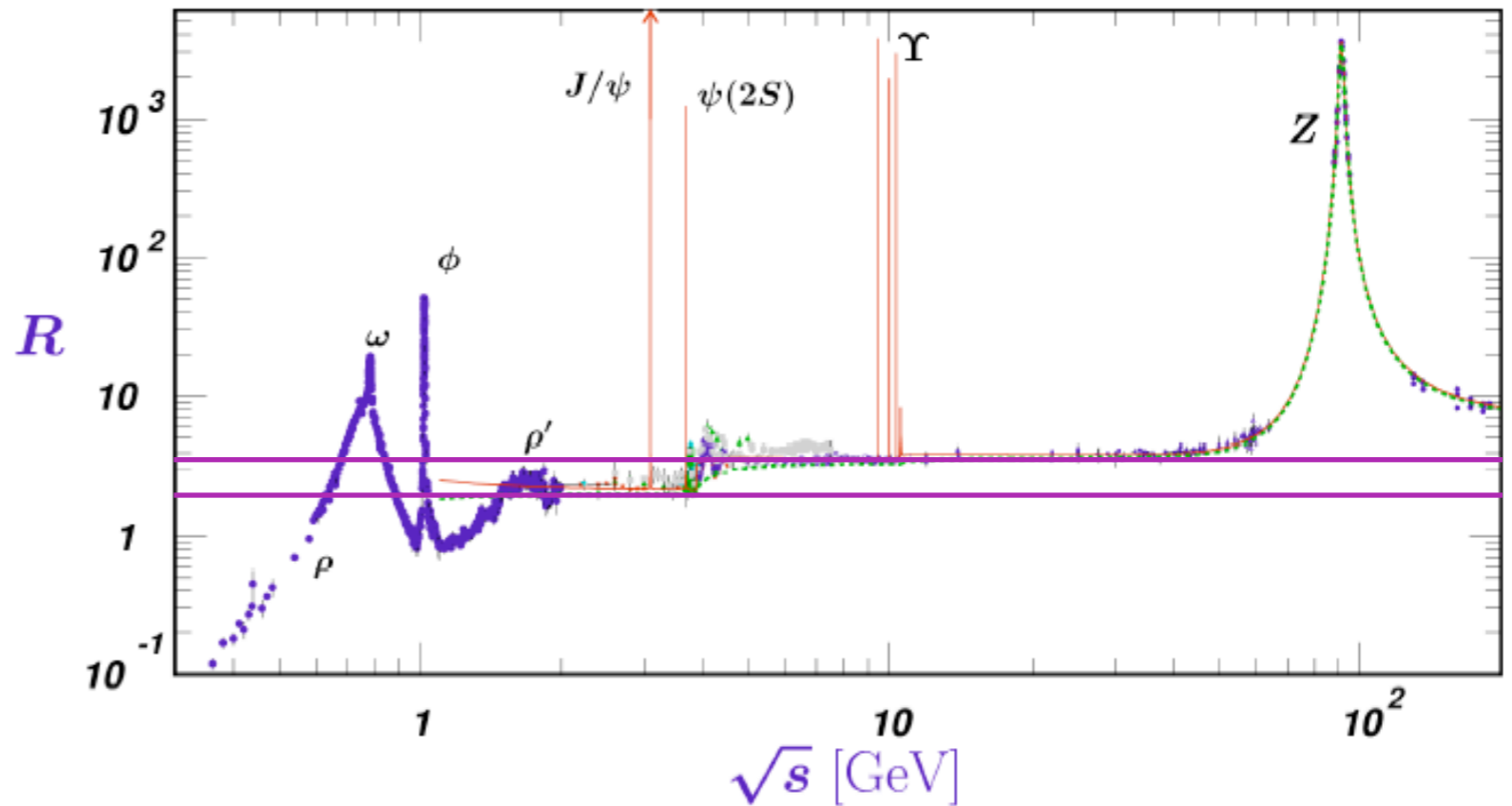
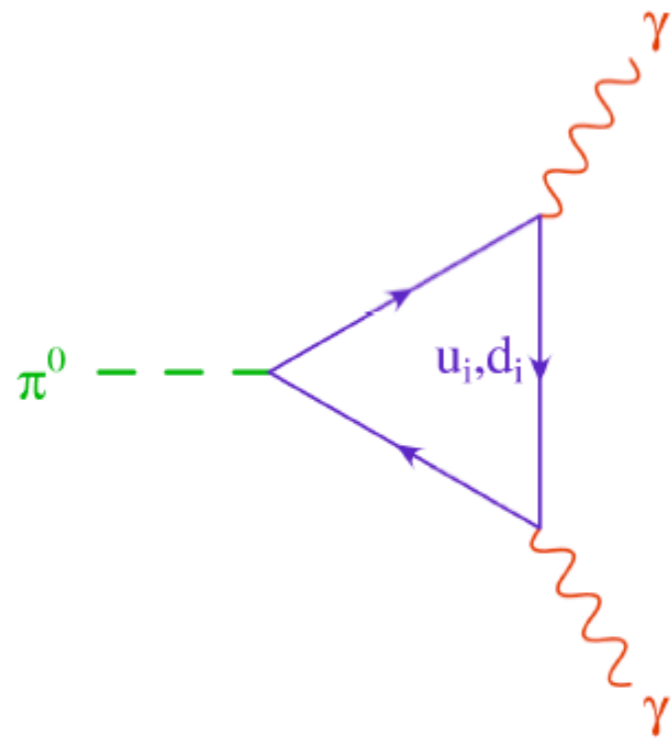

$$\Gamma \sim N_c^2 [Q_u^2 - Q_d^2]^2 \frac{m_\pi^3}{f_\pi^2}$$

$$\Gamma_{TH} = \left(\frac{N_c}{3}\right)^2 7.6 \text{ eV}$$

$$\Gamma_{EXP} = 7.7 \pm 0.6 \text{ eV}$$

$$R = \frac{\sigma(e^+e^- \rightarrow \text{hadrons})}{\sigma(e^+e^- \rightarrow \mu^+\mu^-)} \sim N_c \sum_q e_q^2$$

$$= 2(N_c/3) \quad q = u, d, s$$

$$= 3.7(N_c/3) \quad q = u, d, s, c, b$$

SCALING

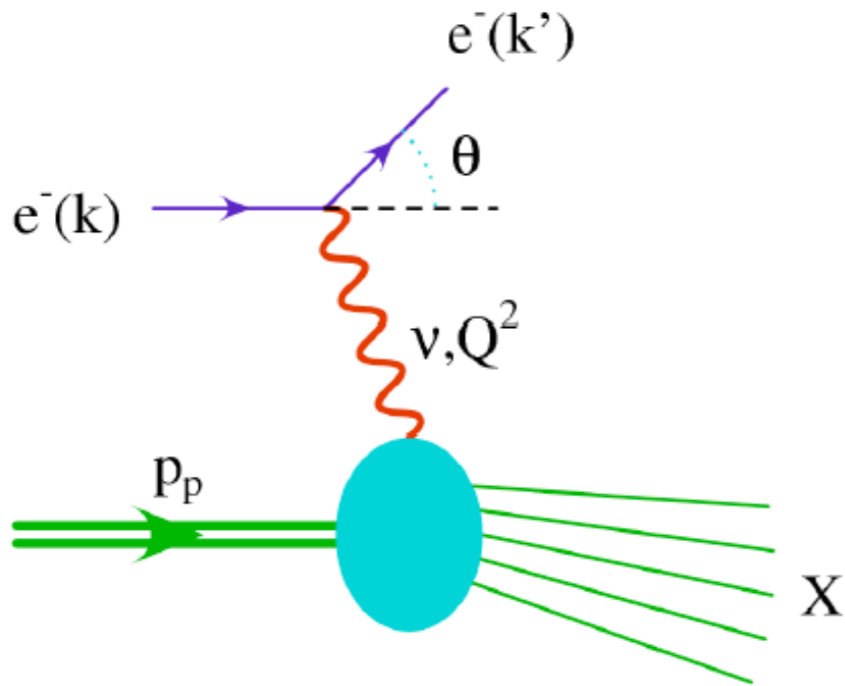

$$s = (P + k)^2 \quad \text{cms energy}^2$$

$$Q^2 = -(k - k')^2 \quad \text{momentum transfer}^2$$

$$x = Q^2 / 2(P \cdot q) \quad \text{scaling variable}$$

$$\nu = (P \cdot q) / M = E - E' \quad \text{energy loss}$$

$$y = (P \cdot q) / (P \cdot k) = 1 - E' / E \quad \text{rel. energy loss}$$

$$W^2 = (P + q)^2 = M^2 + \frac{1-x}{x} Q^2 \quad \text{recoil mass}$$

$$\frac{d\sigma_{\text{elastic}}}{dq^2} = \left(\frac{d\sigma}{dq^2} \right)_{\text{point}} \cdot F_{\text{elastic}}^2(q^2) \delta(1-x) dx$$

$$\frac{d\sigma_{\text{inelastic}}}{dq^2} = \left(\frac{d\sigma}{dq^2} \right)_{\text{point}} \cdot F_{\text{inelastic}}^2(q^2, x) dx$$

What should we expect for $F(q^2, x)$?



SCALING

Two plausible and one *crazy* scenarios for the $|q^2| \rightarrow \infty$ (Bjorken) limit:

1. Smooth electric charge distribution:

(classical picture)

$$F_{\text{elastic}}^2(q^2) \sim F_{\text{inelastic}}^2(q^2) \ll 1$$

i.e., external probe penetrates the proton as knife through the butter!

2. Tightly bound point charges inside the proton:

(bound quarks)

$$F_{\text{elastic}}^2(q^2) \sim 1 \text{ and } F_{\text{inelastic}}^2(q^2) \ll 1$$

i.e., quarks get hit as single particles, but momentum is immediately redistributed as they are tightly bound together (confinement) and cannot fly away.

3. And now the crazy one:

(free quarks)

$$F_{\text{elastic}}^2(q^2) \ll 1 \text{ and } F_{\text{inelastic}}^2(q^2) \sim 1$$

i.e., there are points (quarks!) inside the protons, however the hit quark behaves as a free particle that flies away without feeling or caring about confinement!!!

SCALING

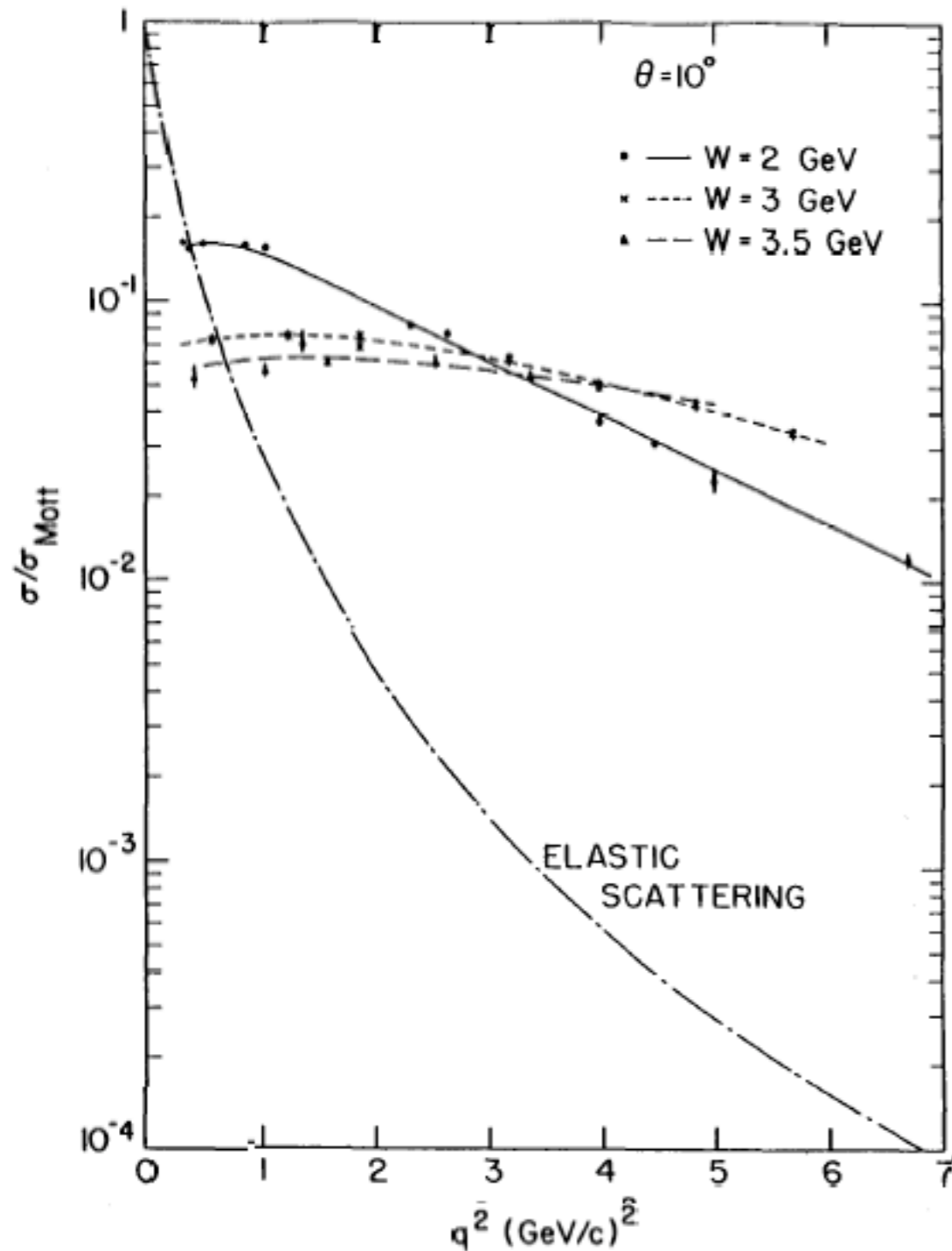

$$\frac{d^2\sigma^{\text{EXP}}}{dx dy} \sim \frac{1}{Q^2}$$

Remarkable!!! Pure dimensional analysis!

The right hand side does not depend on Λ_s !

This is the same behaviour one may find in a renormalizable theory like in QED.

Other stunning example is again $e^+e^- \rightarrow$ hadrons.

This motivated the search for a weakly-coupled theory at high energy!



ASYMPTOTIC FREEDOM

Among QFT theories in 4 dimension only the non-Abelian gauge theories are “asymptotically free”.

It becomes then natural to promote the global color SU(3) symmetry into a local symmetry where color is a charge.

This also hints to the possibility that the color neutrality of the hadrons could have a dynamical origin

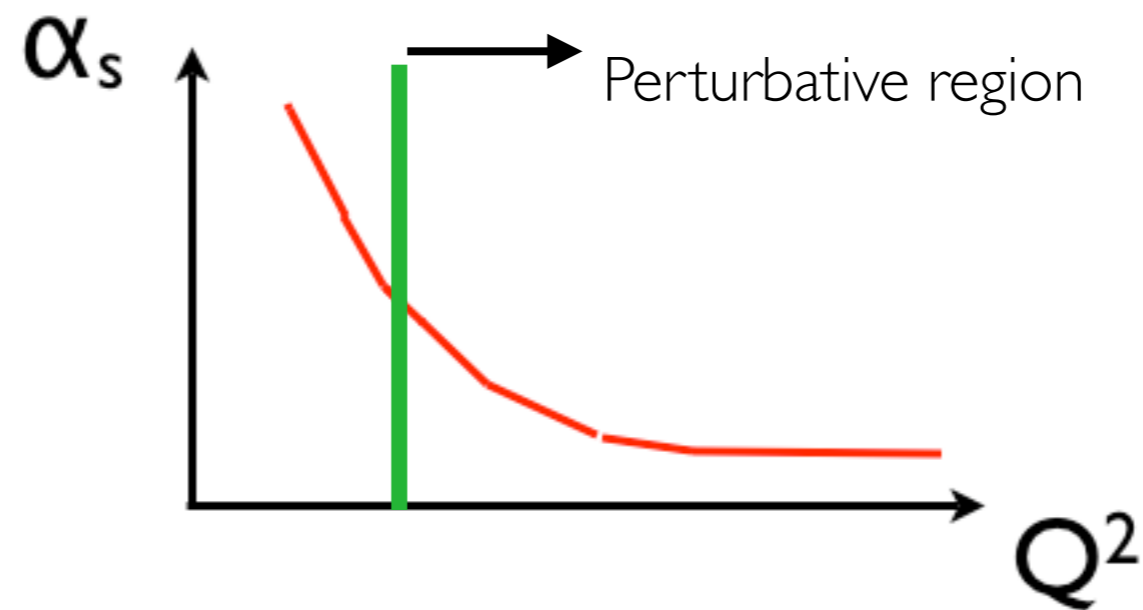

In renormalizable QFT's scale invariance is broken by the renormalization procedure and couplings depend logarithmically on scales.



THE QCD LAGRANGIAN

$$\mathcal{L} = \underbrace{-\frac{1}{4} F_{\mu\nu}^a F_a^{\mu\nu}}_{\text{Gauge Fields}} + \sum_f \underbrace{\bar{\psi}_i^{(f)} (i\not{\partial} - m_f) \psi_i^{(f)}}_{\text{Matter}} - \underbrace{\bar{\psi}_i^{(f)} (g_s t_{ij}^a A_a) \psi_j^{(f)}}_{\text{Interaction}}$$

$$[t^a, t^b] = i f^{abc} t^c$$

→ Algebra of SU(N)

$$\text{tr}(t^a t^b) = \frac{1}{2} \delta^{ab}$$

→ Normalization

Very similar to the QED Lagrangian.. we'll see in a moment where the differences come from!



THE SYMMETRIES OF THE QCD LAGRANGIAN

Now we know that strong interacting physical states have very good symmetry properties like the isospin symmetry: particles in the same multiplets (n,p) or (π^+ , π^- , π^0) have nearly the same mass. Are these symmetries accounted for?

$$\mathcal{L}_F = \sum_f \bar{\psi}_i^{(f)} [(i\partial - m_f)\delta_{ij} - g_s t_{ij}^a A_a] \psi_j^{(f)}$$

$$\psi^{(f)} \rightarrow \sum_{f'} U^{ff'} \psi^{(f')}$$

Isospin transformation acts only f=u,d.

It is a simple EXERCISE to show that the lagrangian is invariant if $m_u=m_d$ or $m_u, m_d \rightarrow 0$. It is the second case that is more appealing. If the masses are close to zero the QCD lagrangian is MORE symmetric:

CHIRAL SYMMETRY



THE SYMMETRIES OF THE QCD LAGRANGIAN

$$\mathcal{L}_F = \sum_f \left\{ \bar{\psi}_L^{(f)} (i\partial - g_s t^a A_a) \psi_L^{(f)} + \bar{\psi}_R^{(f)} (i\partial - g_s t^a A_a) \psi_R^{(f)} \right\} \quad \psi_L = \frac{1}{2}(1 - \gamma_5)\psi$$

$$- \sum_f m_f \left(\bar{\psi}_R^{(f)} \psi_L^{(f)} + \bar{\psi}_L^{(f)} \psi_R^{(f)} \right) \quad \psi_R = \frac{1}{2}(1 + \gamma_5)\psi$$

Do these symmetries have counterpart in the real world?

$$\psi_L^{(f)} \rightarrow e^{i\phi_L} \sum_{f'} U_L^{ff'} \psi_L^{(f')}$$

$$\psi_R^{(f)} \rightarrow e^{i\phi_R} \sum_{f'} U_R^{ff'} \psi_R^{(f')}$$

- The vector subgroup is realized in nature as the isospin
- The corresponding U(1) is the baryon number conservation
- The axial U_A(1) is not there due the axial anomaly
- The remaining axial transformations are spontaneously broken and the goldstone bosons are the pions.

$$SU_L(N) \times SU_R(N) \times U_L(1) \times U_R(1)$$

This is amazing! Without knowing anything about the dynamics of confinement we correctly describe isospin, the small mass of the pions, the scattering properties of pions, and many other features.



WHY DO WE BELIEVE QCD IS A GOOD THEORY OF STRONG INTERACTIONS?

- QCD is a non-abelian gauge theory, is renormalizable, is asymptotically free, is a one-parameter theory [Once you measure α_s (and the quark masses) you know everything **fundamental** about (perturbative) QCD].
- It explains the low energy properties of the hadrons, justifies the observed spectrum and catch the most important dynamical properties.
- It explains scaling (and BTW anything else we have seen up to now!!) at high energies.
- It leaves EW interaction in place since the $SU(3)$ commutes with $SU(2) \times U(1)$. There is no mixing and there are no enhancements of parity violating effect or flavor changing currents.

ok, then. Are we done?



WHY DO MANY PEOPLE CARE ABOUT QCD?

At “low” energy:

I. QCD Thermodynamics with application to cosmology, astrophysics, nuclei.

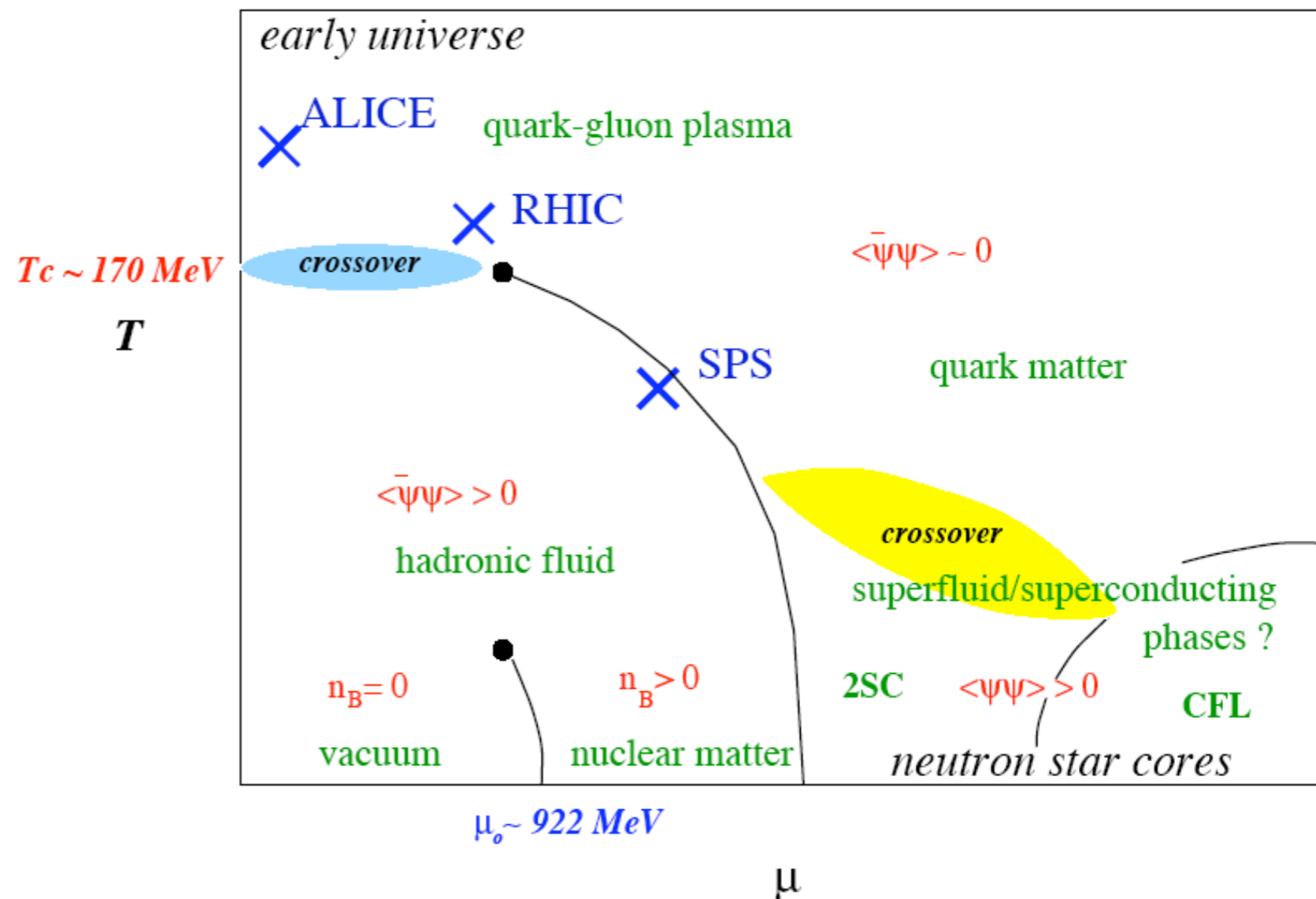



WHY DO MANY PEOPLE CARE ABOUT QCD?

At “low” energy:

1. QCD Thermodynamics with application to cosmology, astrophysics , nuclei.
2. Confinement still to be proved 10^6 \$ (millenium) prize by the Clay Mathematics Institute.

Yang–Mills Existence and Mass Gap. *Prove that for any compact simple gauge group G , a non-trivial quantum Yang–Mills theory exists on \mathbb{R}^4 and has a mass gap $\Delta > 0$. Existence includes establishing axiomatic properties at least as strong as those cited in [45, 35].*



WHY DO MANY PEOPLE CARE ABOUT QCD?

At “low” energy:

1. QCD Thermodynamics with application to cosmology, astrophysics , nuclei.
2. Confinement still to be proved 10^6 \$ (millenium) prize by the Clay Mathematics Institute.
3. Measurement of quark masses, mixings and CP violation parameters essential to understand the Flavor structure of the SM. Requires accurate predictions of non-perturbative form factors and matrix elements. Need for lattice...

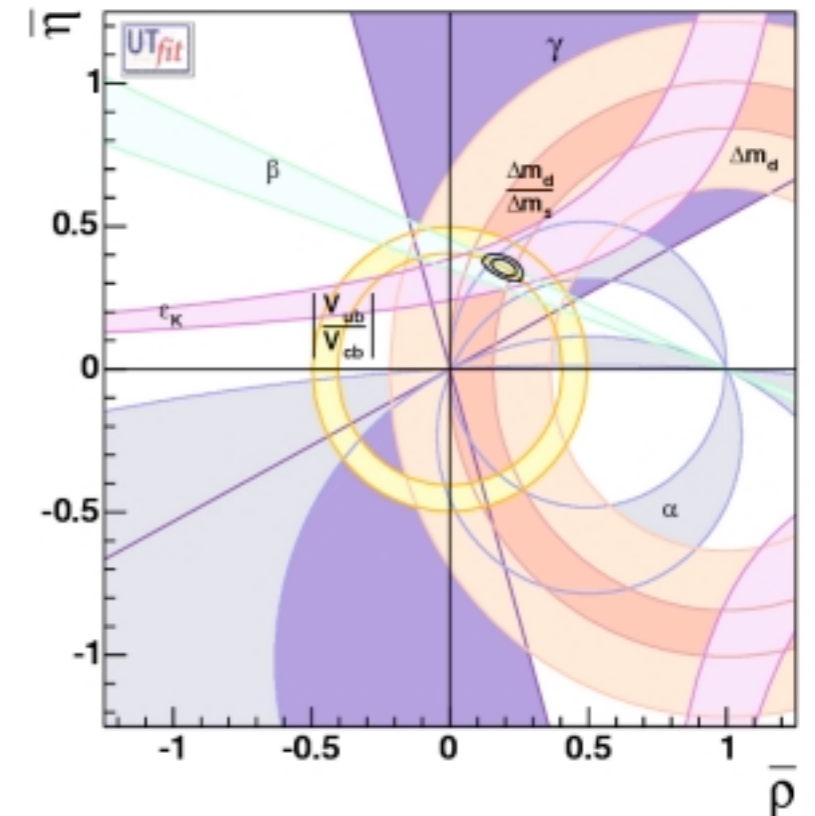

WHY DO WE CARE ABOUT QCD?

At high energy:

QCD is a necessary tool to decode most hints that Nature is giving us on the fundamental issues!

*Measurement of α_s , $\sin^2\theta_W$ give information on possible patterns of unification.

*Measurements and discoveries at hadron colliders need accurate predictions for QCD backgrounds!

BTW, is this really true?

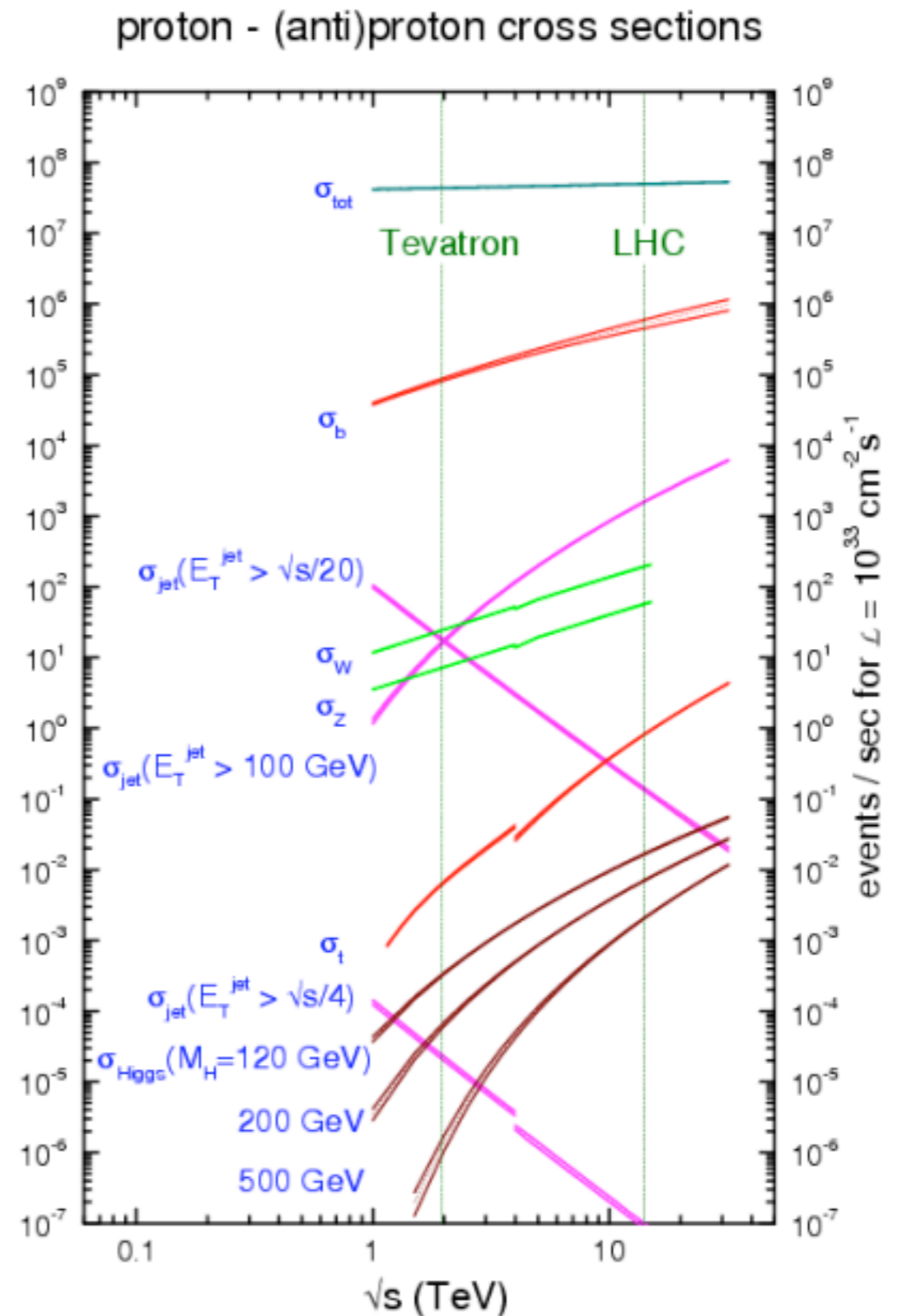
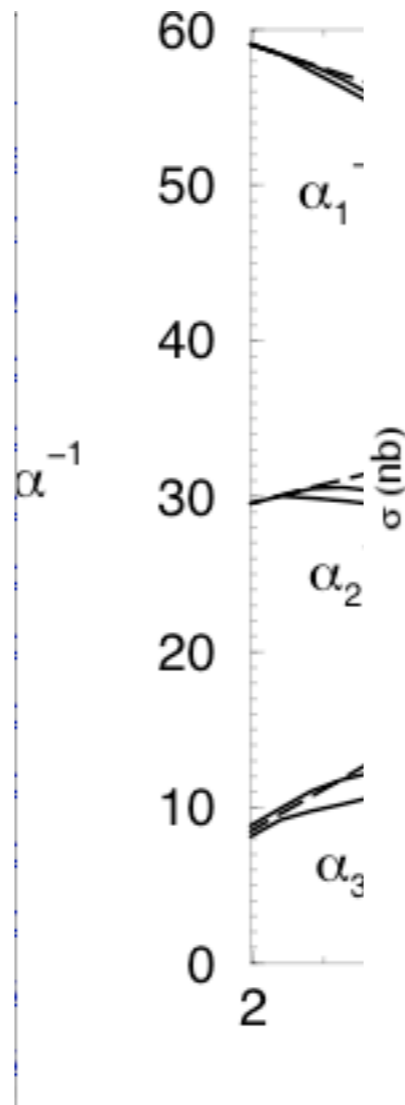

DISCOVERIES AT HADRON COLLIDERS

peak

$$pp \rightarrow Z' \rightarrow e^+ e^-$$

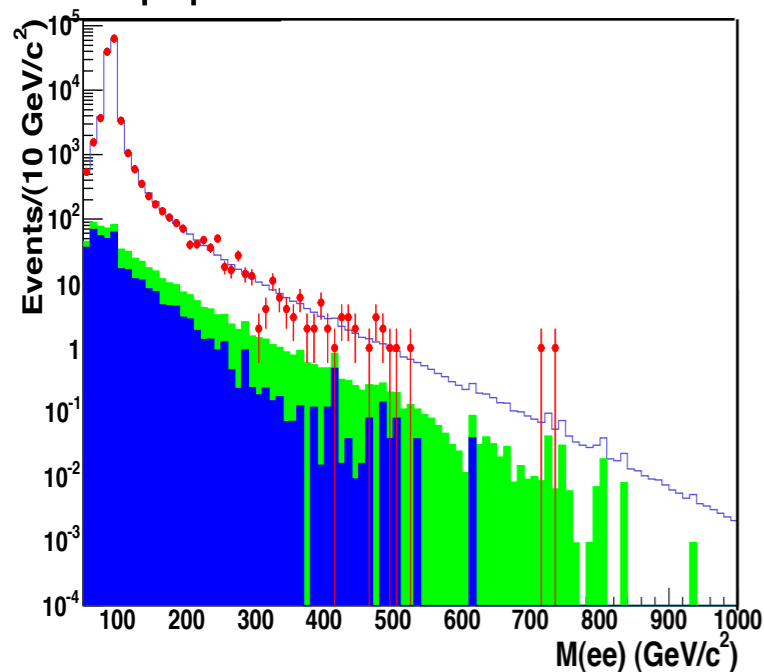

“easy”

Background directly measured from data. TH needed only for parameter extraction (Normalization, acceptance,...)

shape

$$pp \rightarrow \tilde{g}\tilde{g}, \tilde{g}\tilde{q}, \tilde{q}\tilde{q} \rightarrow \text{jets} + \cancel{E}_T$$

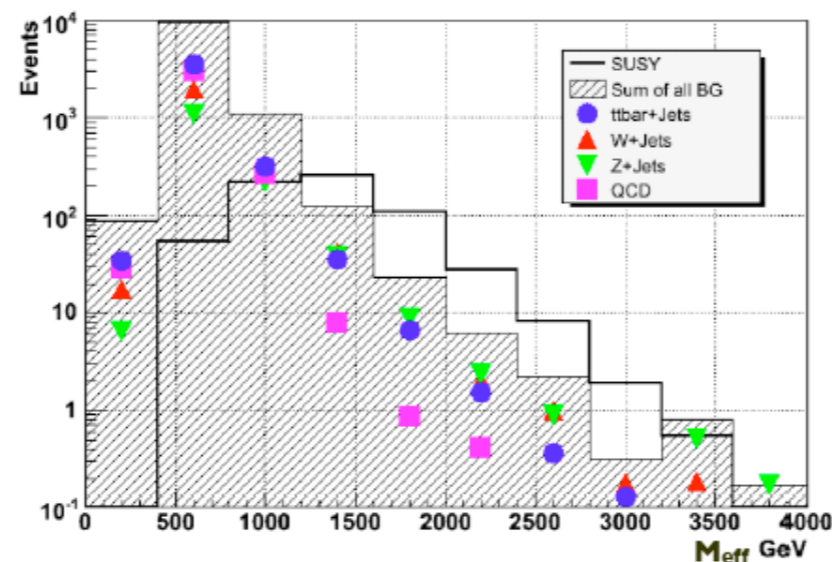

hard

Background shapes needed. Flexible MC for both signal and background tuned and validated with data.

rate

$$pp \rightarrow H \rightarrow W^+ W^-$$

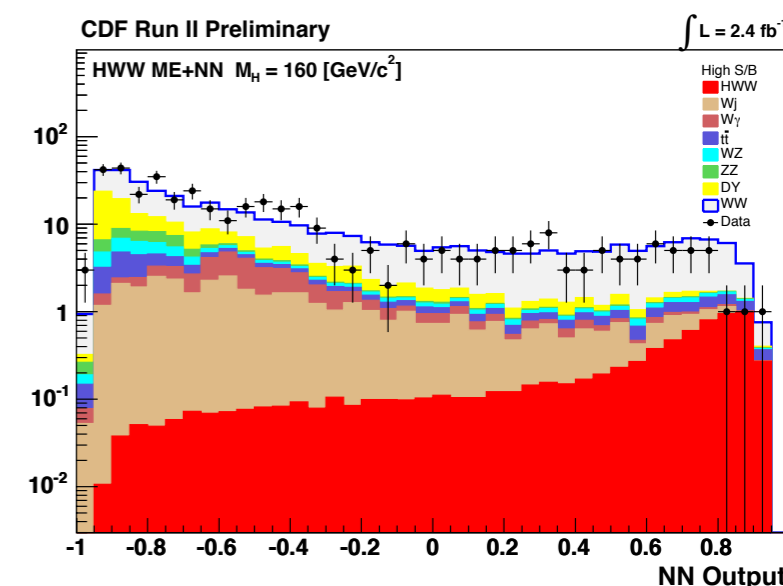

very hard

Background normalization and shapes known very well. Interplay with the best theoretical predictions (via MC) and data.



MOTIVATIONS FOR QCD PREDICTIONS

- **Accurate** and **experimental** friendly predictions for collider physics range from being very useful to strictly necessary.
- Confidence on possible excesses, evidences and eventually discoveries builds upon an intense (and often non-linear) process of description/prediction of data via MC's.
- Measurements and exclusions always rely on accurate predictions.
- Predictions for both SM and BSM on the same ground.

no QCD \Rightarrow no PARTY !



QCD : THE FUNDAMENTALS

1. QCD is a good theory for strong interactions: facts
2. From QED to QCD: the importance of color
3. Renormalization group and asymptotic freedom



FROM QED TO QCD

$$\mathcal{L} = -\frac{1}{4}F_{\mu\nu}F^{\mu\nu} + \bar{\psi}(i\partial - m)\psi - eQ\bar{\psi}A\psi$$

where $F_{\mu\nu} = \partial_\mu A_\nu - \partial_\nu A_\mu$

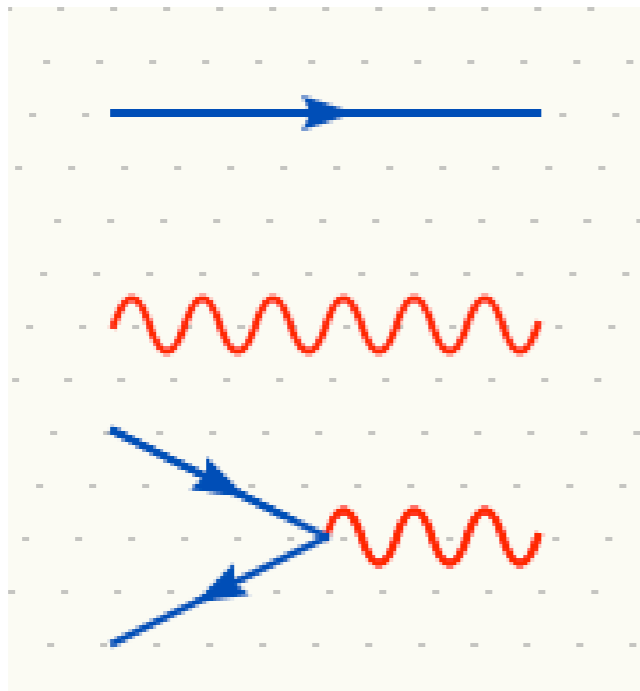

$$\begin{aligned} &= \frac{i}{\not{p} - m + i\epsilon} \\ &= \frac{-ig_{\mu\nu}}{p^2 + i\epsilon} \\ &= -ie\gamma_\mu Q \end{aligned}$$



FROM QED TO QCD

We want to focus on how gauge invariance is realized in practice.

Let's start with the computation of a simple process $e^+e^- \rightarrow \gamma\gamma$. There are two diagrams:

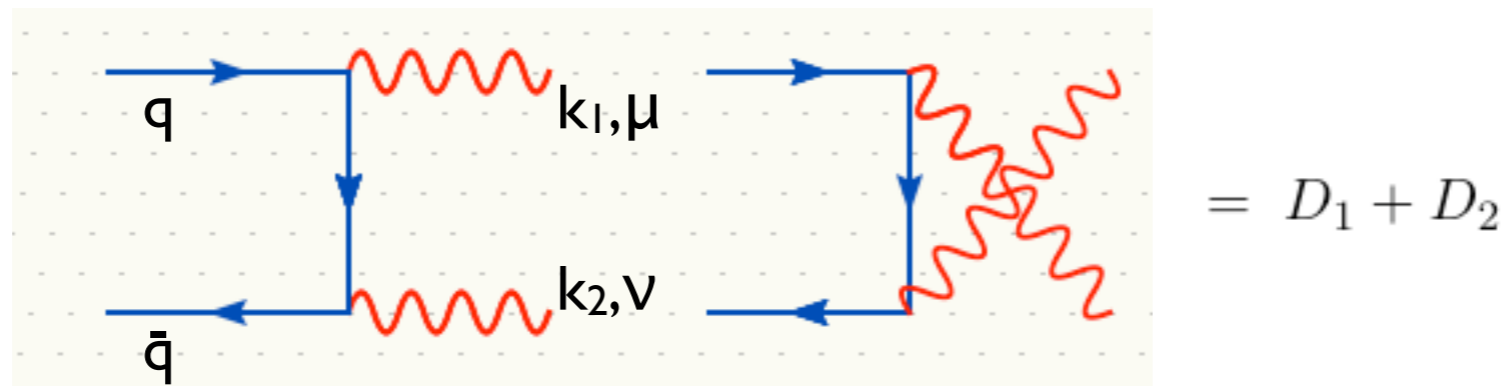

$$i\mathcal{M} = \mathcal{M}_{\mu\nu} \epsilon_1^{*\mu} \epsilon_2^{*\nu} = D_1 + D_2 = e^2 \left(\bar{v}(\bar{q}) \not{\epsilon}_2 \frac{1}{\not{q} - \not{k}_1} \not{\epsilon}_1 u(q) + \bar{v}(\bar{q}) \not{\epsilon}_1 \frac{1}{\not{q} - \not{k}_2} \not{\epsilon}_2 u(q) \right)$$

Gauge invariance requires that:

$$\epsilon_1^{*\mu} k_2^\nu \mathcal{M}_{\mu\nu} = \epsilon_2^{*\nu} k_1^\mu \mathcal{M}_{\mu\nu} = 0$$



FROM QED TO QCD

$$\begin{aligned} \mathcal{M}_{\mu\nu} k_1^{*\mu} \epsilon_2^{*\nu} &= D_1 + D_2 = e^2 \left(\bar{v}(\bar{q}) \not{\epsilon}_2 \frac{1}{\not{q} - \not{k}_1} (\not{k}_1 - \not{q}) u(q) + \bar{v}(\bar{q}) (\not{k}_1 - \not{q}) \frac{1}{\not{k}_1 - \not{q}} \not{\epsilon}_2 u(q) \right) \\ &= -\bar{v}(\bar{q}) \not{\epsilon}_2 u(q) + \bar{v}(\bar{q}) \not{\epsilon}_2 u(q) = 0 \end{aligned}$$

Only the sum of the two diagrams is gauge invariant. For the amplitude to be gauge invariant it is enough that one of the polarizations is longitudinal. The state of the other gauge boson is irrelevant.

Let's try now to generalize what we have done for SU(3). In this case we take the (anti-)quarks to be in the (anti-)fundamental representation of SU(3), 3 and 3*. Then the current is in a $3 \otimes 3^* = 1 \oplus 8$. The singlet is like a photon, so we identify the gluon with the octet and generalize the QED vertex to :

$$\text{with } [t^a, t^b] = i f^{abc} t^c \quad -ig_s t_{ij}^a \gamma^\mu$$

So now let's calculate $qq \rightarrow gg$ and we obtain

$$\begin{aligned} \frac{i}{g_s^2} M_g &\equiv (t^b t^a)_{ij} D_1 + (t^a t^b)_{ij} D_2 \\ M_g &= (t^a t^b)_{ij} M_\gamma - g^2 f^{abc} t_{ij}^c D_1 \end{aligned}$$

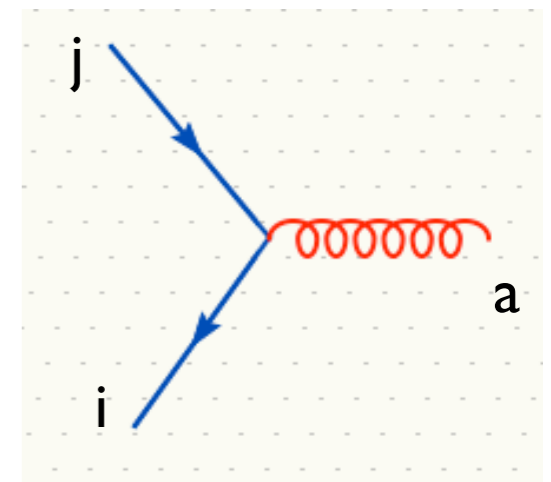



FROM QED TO QCD

To satisfy gauge invariance we still need:

$$k_1^\mu \epsilon_2^\nu M_g^{\mu,\nu} = k_2^\nu \epsilon_1^\mu M_g^{\mu,\nu} = 0.$$

But in this case one piece is left out

$$k_{1\mu} M_g^\mu = -g_s^2 f^{abc} t_{ij}^c \bar{v}_i(\bar{q}) \not{\epsilon}_2 u_i(q)$$

$$k_{1\mu} M_g^\mu = i(-g_s f^{abc} \epsilon_2^\mu) (-ig_s t_{ij}^c \bar{v}_i(\bar{q}) \gamma_\mu u_i(q))$$

We indeed see that we interpret as the normal vertex times a new 3 gluon vertex:

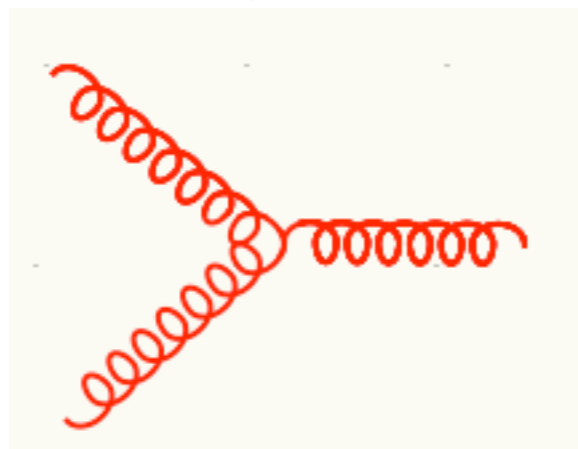
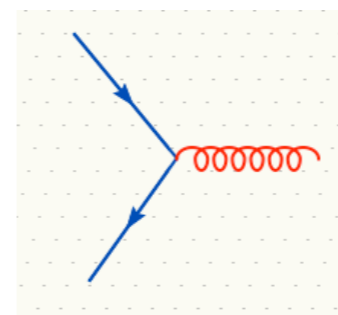

$$-g_s f^{abc} V_{\mu_1 \mu_2 \mu_3}(p_1, p_2, p_3)$$

FROM QED TO QCD

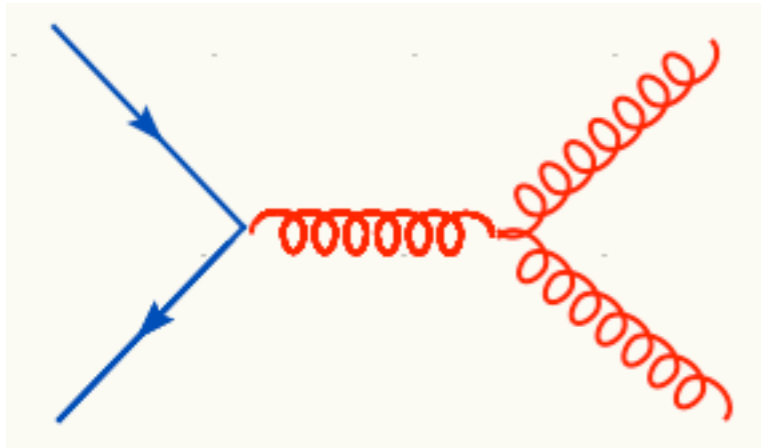

$$-ig_s^2 D_3 = \left(-ig_s t_{ij}^a \bar{v}_i(\bar{q}) \gamma^\mu u_j(q) \right) \times \left(\frac{-i}{p^2} \right) \times \left(-g f^{abc} V_{\mu\nu\rho}(-p, k_1, k_2) \epsilon_1^\nu(k_1) \epsilon_2^\rho(k_2) \right)$$

How do we write down the Lorentz part for this new interaction? We can impose

1. Lorentz invariance : only structure of the type $g_{\mu\nu} p_\rho$ are allowed
2. fully anti-symmetry : only structure of the type remain $g_{\mu_1\mu_2} (k_1)_{\mu_3}$ are allowed...
3. dimensional analysis : only one power of the momentum.

that uniquely constrain the form of the vertex:

$$V_{\mu_1\mu_2\mu_3}(p_1, p_2, p_3) = V_0 \left[(p_1 - p_2)_{\mu_3} g_{\mu_1\mu_2} + (p_2 - p_3)_{\mu_1} g_{\mu_2\mu_3} + (p_3 - p_1)_{\mu_2} g_{\mu_3\mu_1} \right]$$

With the above expression we obtain a contribution to the gauge variation:

$$k_1 \cdot D_3 = g^2 f^{abc} t^c V_0 \left[\bar{v}(\bar{q}) \not{\epsilon}_2 u(q) - \frac{k_2 \cdot \epsilon_2}{2k_1 \cdot k_2} \bar{v}(\bar{q}) \not{k}_1 u(q) \right]$$

The first term cancels the gauge variation of $D_1 + D_2$ if $V_0=1$, the second term is zero IFF the other gluon is physical!!

One can derive the form of the four-gluon vertex using the same heuristic method.



THE QCD LAGRANGIAN

By direct inspection and by using the form non-abelian covariant derivation, we can check that indeed non-abelian gauge symmetry implies self-interactions. This is not surprising since the gluon itself is charged (In QED the photon is not!)

$$\mathcal{L} = -\frac{1}{4} F_{\mu\nu}^a F_a^{\mu\nu} + \sum_f \bar{\psi}_i^{(f)} (i\partial - m_f) \psi_i^{(f)} - \bar{\psi}_i^{(f)} (g_s t_{ij}^a A_a) \psi_j^{(f)}$$

Gauge
Fields and
their
interact.

➔

$F_{\mu\nu}^a = \partial_\mu A_\nu^a - \partial_\nu A_\mu^a - g f^{abc} A_\mu^b A_\nu^c$



THE FEYNMAN RULES OF QCD

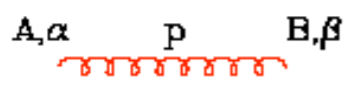

$$\delta^{AB} \left[-g^{\alpha\beta} + (1-\lambda) \frac{p^\alpha p^\beta}{p^2 + i\epsilon} \right] \frac{i}{p^2 + i\epsilon}$$

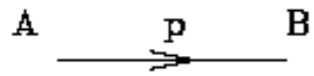

$$\delta^{AB} \frac{i}{(p^2 + i\epsilon)}$$

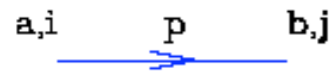

$$\delta^{ab} \frac{i}{(\not{p} - m + i\epsilon)_\mu}$$

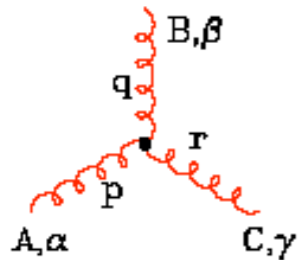

$$-g f^{ABC} [(p-q)^\gamma g^{\alpha\beta} + (q-r)^\alpha g^{\beta\gamma} + (r-p)^\beta g^{\gamma\alpha}]$$

(all momenta incoming)

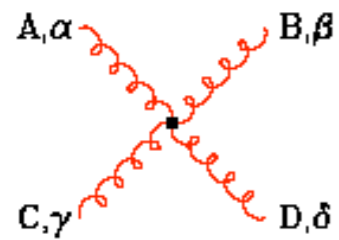

$$-ig^2 f^{XAC} f^{XBD} [g^{\alpha\beta} g^{\gamma\delta} - g^{\alpha\delta} g^{\beta\gamma}]$$

$$-ig^2 f^{XAD} f^{XBC} [g^{\alpha\beta} g^{\gamma\delta} - g^{\alpha\gamma} g^{\beta\delta}]$$

$$-ig^2 f^{XAB} f^{XCD} [g^{\alpha\gamma} g^{\beta\delta} - g^{\alpha\delta} g^{\beta\gamma}]$$

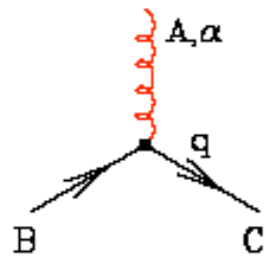
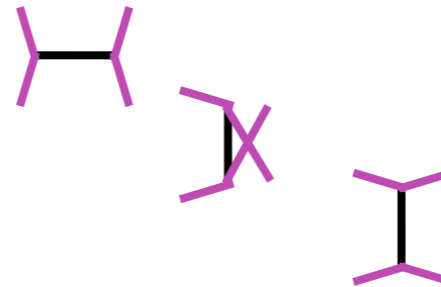

$$g f^{ABC} q^\alpha$$

← what is this?

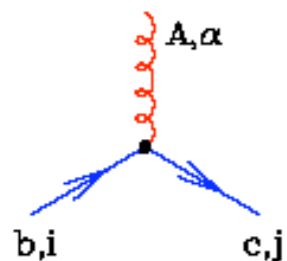

$$-ig (t^A)_{cb} (\gamma^a)_{ji}$$



FROM QED TO QCD: PHYSICAL STATES

In QED, due to abelian gauge invariance, one can sum over the polarization of the external photons using:

$$\sum_{pol} \epsilon_i^\mu \epsilon_i^{*\nu} = -g_{\mu\nu}$$

In fact the longitudinal and time-like component cancel each other, no matter what the choice for ϵ_2 is. The production of any number of unphysical photons vanishes.

In QCD this would give a wrong result!!

We can write the sum over the polarization in a convenient form using the vector $k=(k_0, 0,0,-k_0)$.

$$\sum_{phys\ pol} \epsilon_i^\mu \epsilon_i^{*\nu} = -g_{\mu\nu} + \frac{k_\mu \bar{k}_\nu + k_\nu \bar{k}_\mu}{k \cdot \bar{k}}$$

For gluons the situation is different, since $k_1 \cdot M \sim \epsilon_2 \cdot k_2$. So the production of two unphysical gluons is not zero!!



FROM QED TO QCD: PHYSICAL STATES

In the case of non-Abelian theories it is therefore important to restrict the sum over polarizations (and the off-shell propagators) to the physical degrees of freedom.

Alternatively, one has to undertake a formal study of the implications of gauge-fixing in non-physical gauges. The outcome of this approach is the appearance of **two color-octet scalar degrees of freedom that have the peculiar property that behave like fermions.**

Ghost couple only to gluons and appear in internal loops and as external states (in place of two gluons). Since they break the spin-statistics theorem their contribution can be negative, which is what is required to cancel the non-physical dof in the general case.

Adding the ghost contribution gives

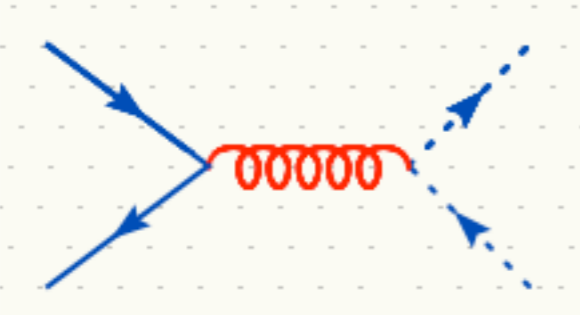
$$\Rightarrow - \left| i g_s^2 f^{abc} t^a \frac{1}{2k_1 \cdot k_2} \bar{v}(\bar{q}) \not{k}_1 u(q) \right|^2$$

which exactly cancels the non-physical polarization in a covariant gauge.



THE COLOR ALGEBRA

$$\text{Tr}(t^a) = 0$$



$$\text{Tr}(t^a t^b) = T_R \delta^{ab}$$

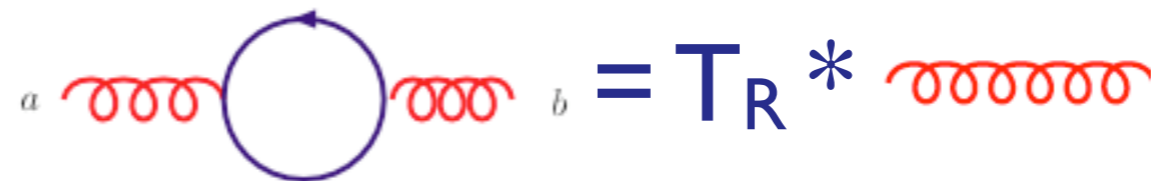

$$(t^a t^a)_{ij} = C_F \delta_{ij}$$



$$\sum_{cd} f^{acd} f^{bcd}$$

$$= (F^c F^c)_{ab} = C_A \delta_{ab}$$

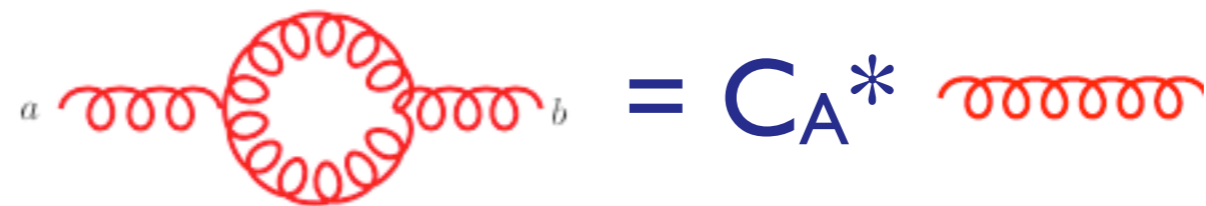



THE COLOR ALGEBRA

$$[t^a, t^b] = i f^{abc} t^c$$

$$[F^a, F^b] = i f^{abc} F^c$$

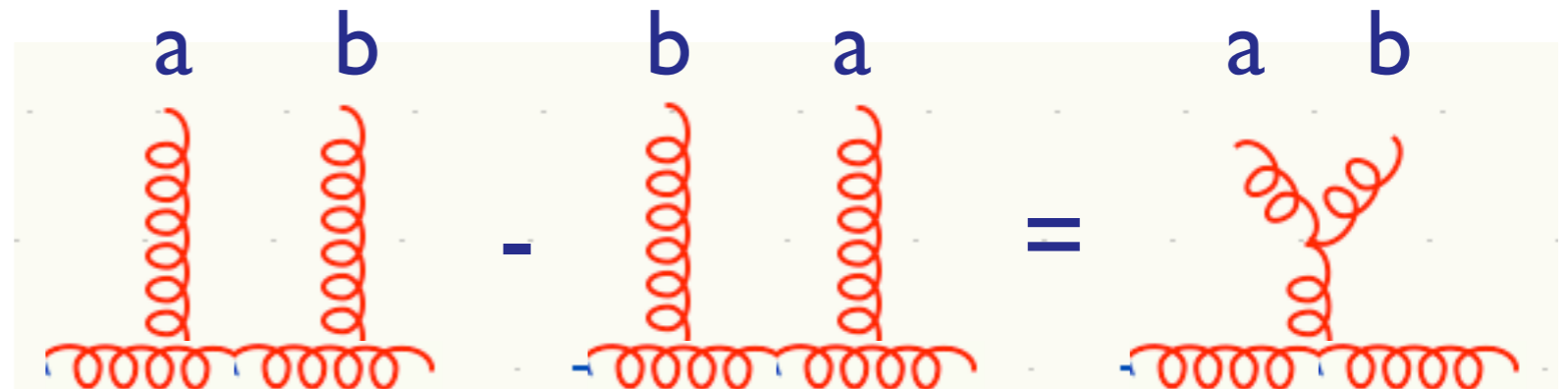

1-loop vertices

$$i f^{abc} (t^b t^c)_{ij} = \frac{C_A}{2} t^a_{ij}$$

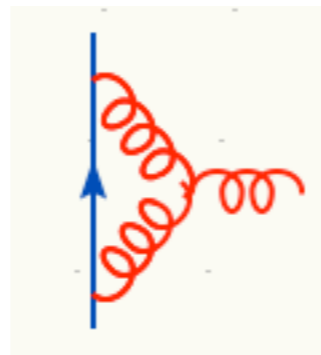

$$= C_A/2 *$$

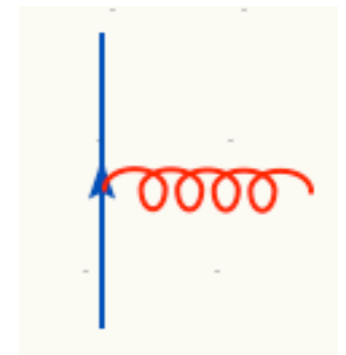

$$(t^b t^a t^b)_{ij} = (C_F - \frac{C_A}{2}) t^a_{ij}$$

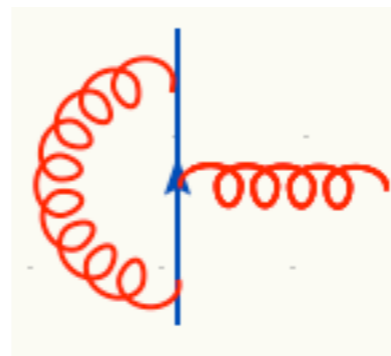

$$= -1/2/N_c *$$

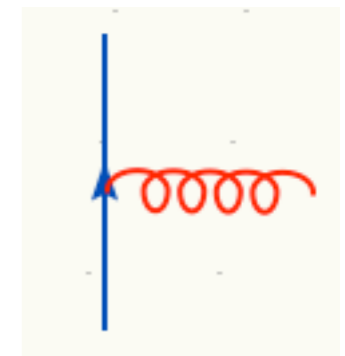



THE COLOR ALGEBRA

$$t_{ij}^a t_{kl}^a = \frac{1}{2} (\delta_{il} \delta_{kj} - \frac{1}{N_c} \delta_{ij} \delta_{kl})$$

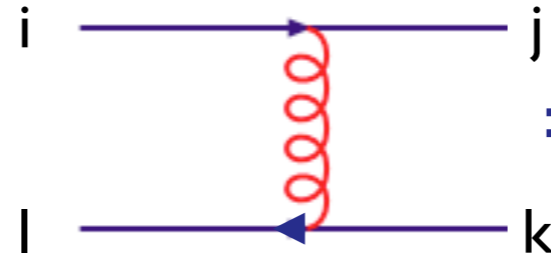

$$= 1/2 *$$

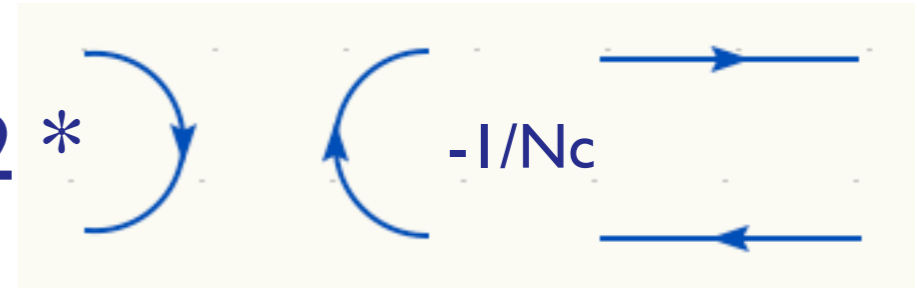

Problem: Show that the one-gluon exchange between quark-antiquark pair can be attractive or repulsive. Calculate the relative strength.

Solution: a q qb pair can be in a singlet state (photon) or in octet (gluon) : $3 \otimes \bar{3} = 1 \oplus 8$

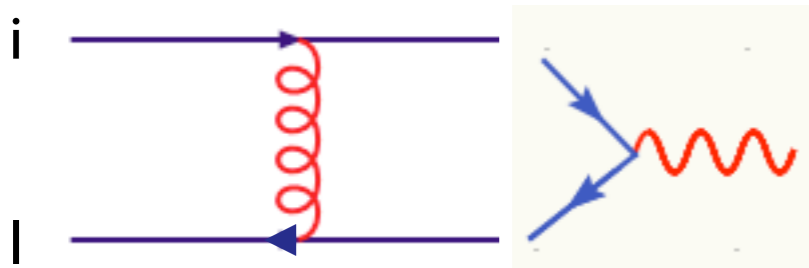

$$\frac{1}{2} (\delta_{ik} \delta_{lj} - \frac{1}{N_c} \delta_{ij} \delta_{lk}) \delta_{ki} = \frac{1}{2} \delta_{lj} (N_c - \frac{1}{N_c}) = C_F \delta_{lj}$$

>0, attractive

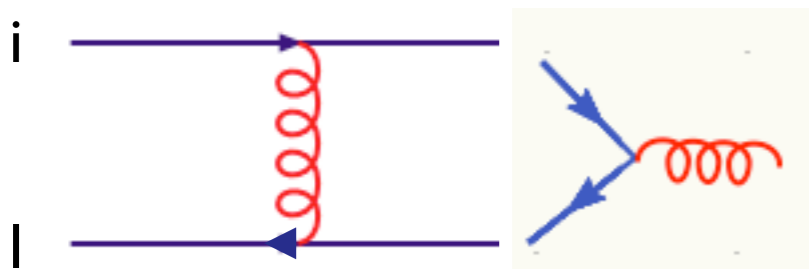

$$\frac{1}{2} (\delta_{ik} \delta_{lj} - \frac{1}{N_c} \delta_{ij} \delta_{lk}) t_{ki}^a = -\frac{1}{2N_c} t_{lj}^a$$

<0, repulsive



QUARKONIUM STATES

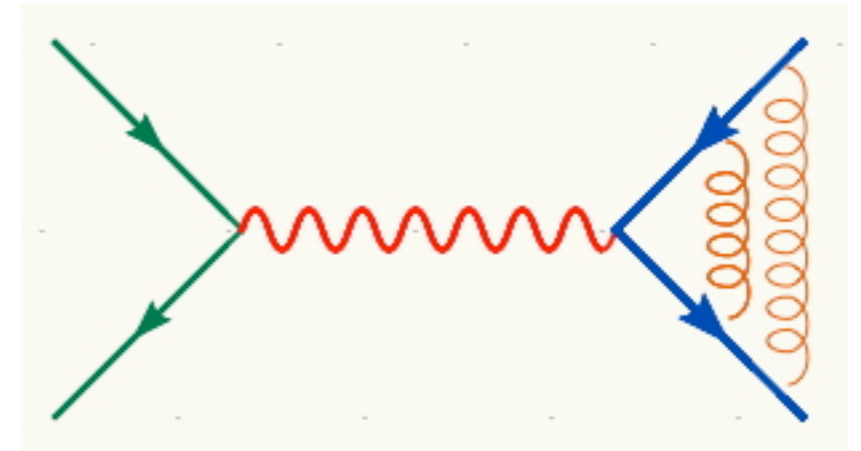
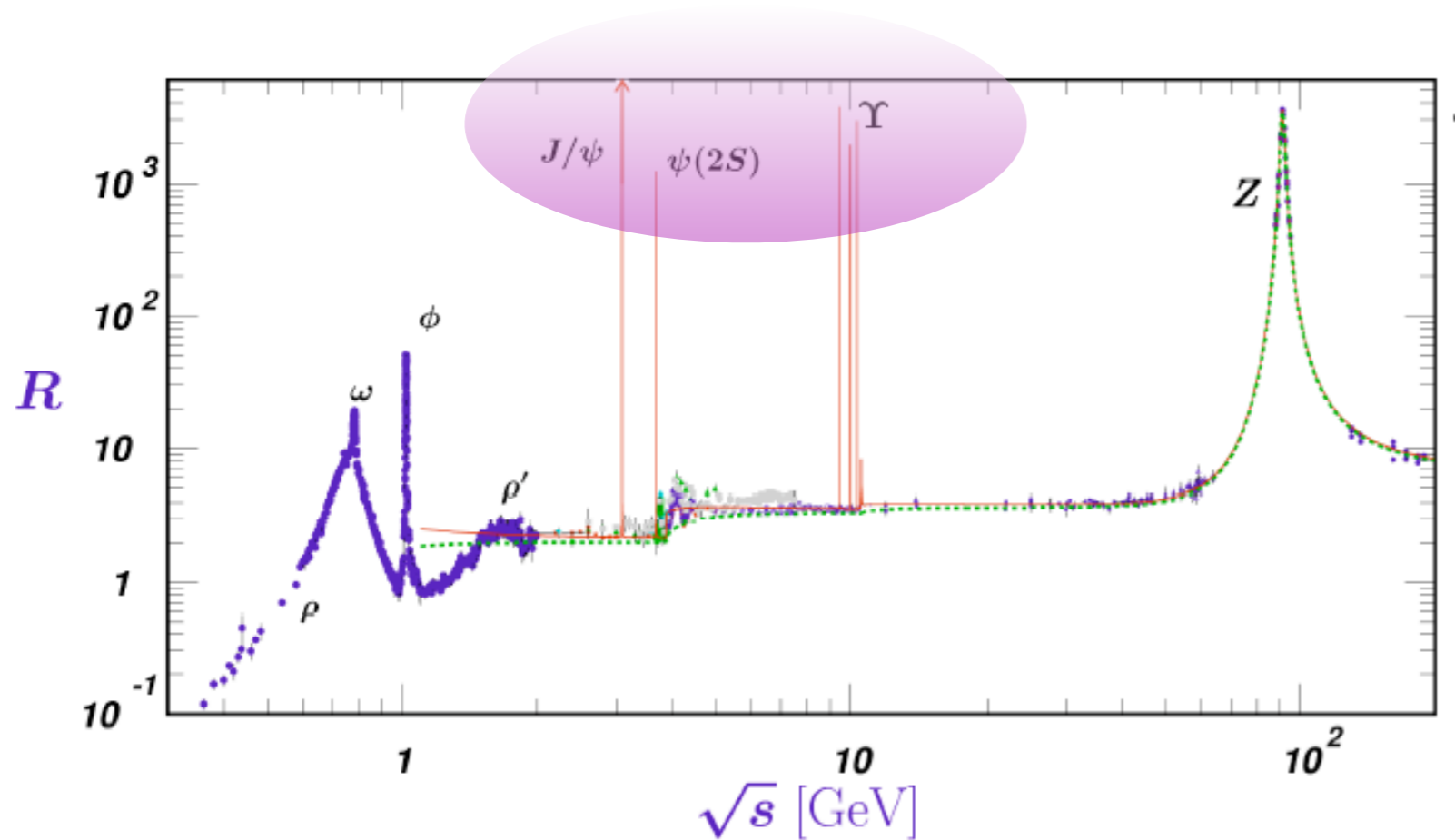

Very sharp peaks \Rightarrow small widths (~ 100 KeV) compared to hadronic resonances (100 MeV) \Rightarrow very long lived states. QCD is “weak” at scales $\gg \Lambda_{\text{QCD}}$ (asymptotic freedom), non-relativistic bound states are formed like positronium!

The QCD-Coulomb attractive potential is like:
$$V(r) \simeq -C_F \frac{\alpha_s(1/r)}{r}$$



COLOR ALGEBRA: 'T HOOFT DOUBLE LINE

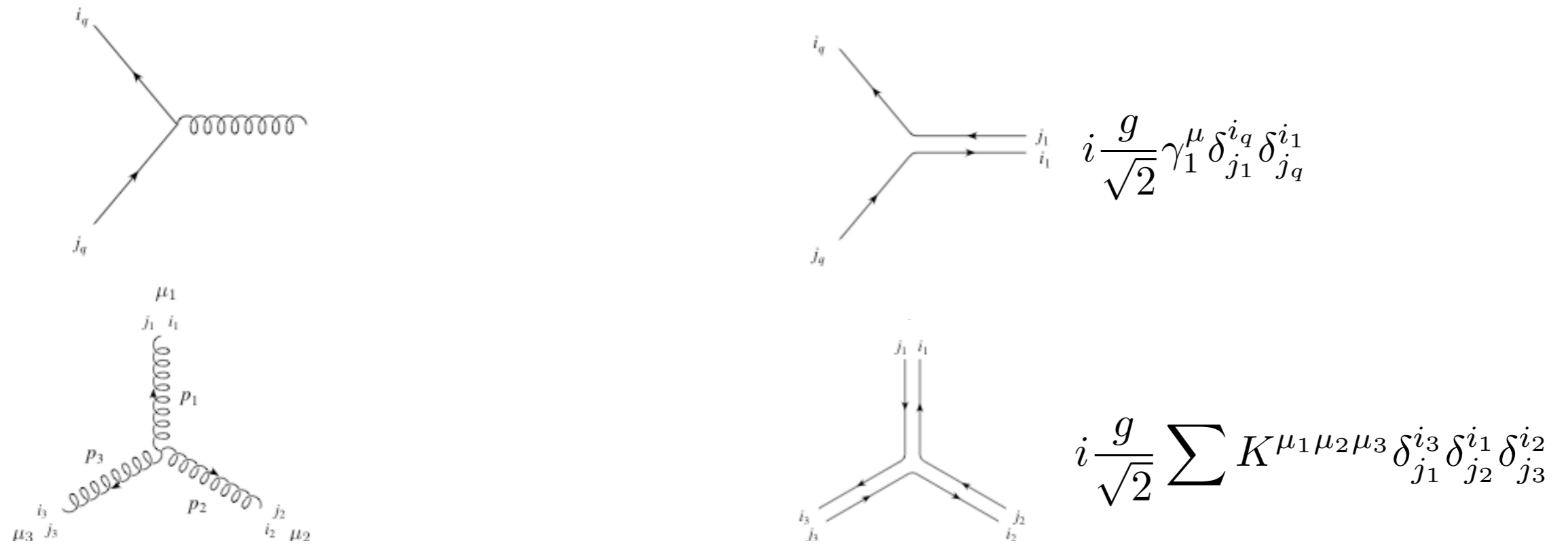

This formulation leads to a graphical representation of the simplifications occurring in the large N_c limit, even though it is exactly equivalent to the usual one.

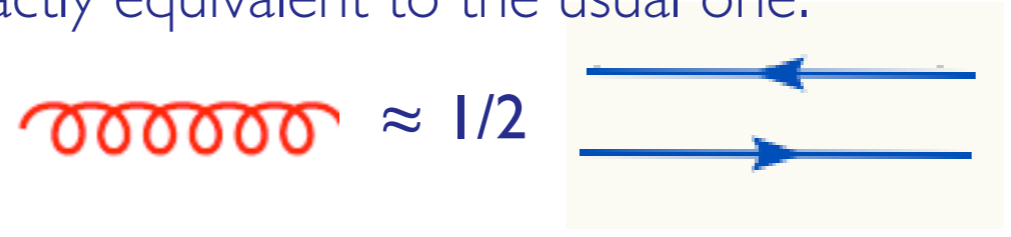

In the large N_c limit, a gluon behaves as a quark-antiquark pair. In addition it behaves classically, in the sense that quantum interference, which are effects of order $1/N_c^2$ are neglected. Many QCD algorithms and codes (such as the parton showers) are based on this picture.



EXAMPLE: VBF FUSION

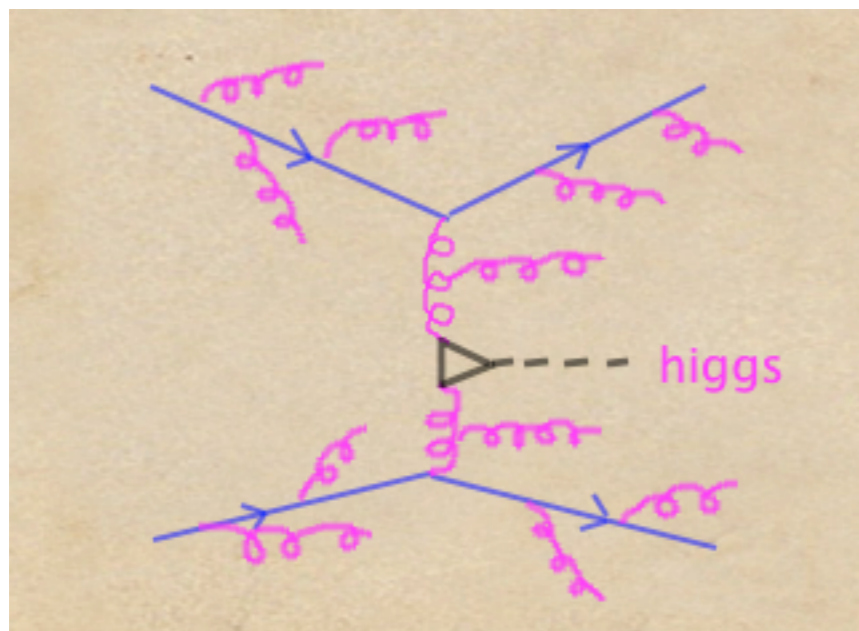
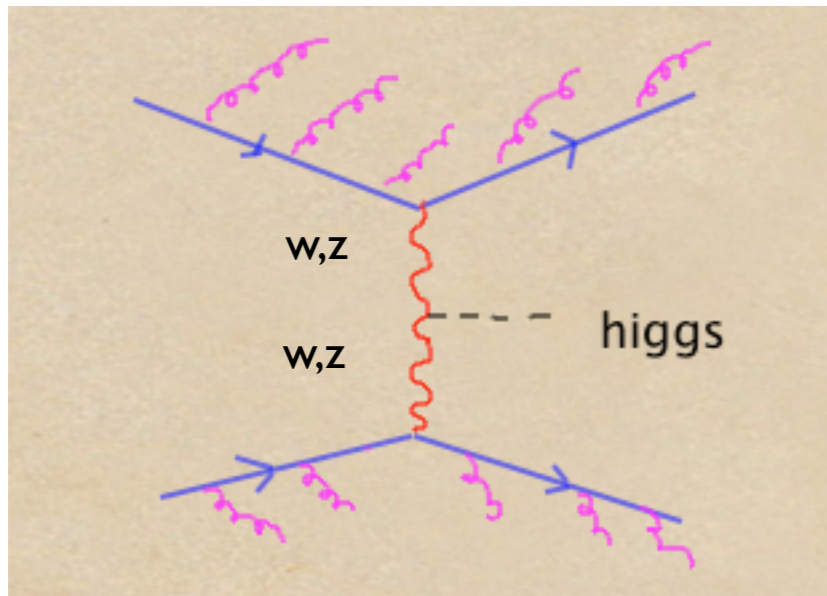

Facts:

1. Important channel for light Higgs both for discovery and measurement
2. Color singlet exchange in the t-channel
3. Characteristic signature: forward-backward jets + RAPIDITY GAP
4. QCD production is a background to precise measurements of couplings



EXAMPLE: VBF FUSION

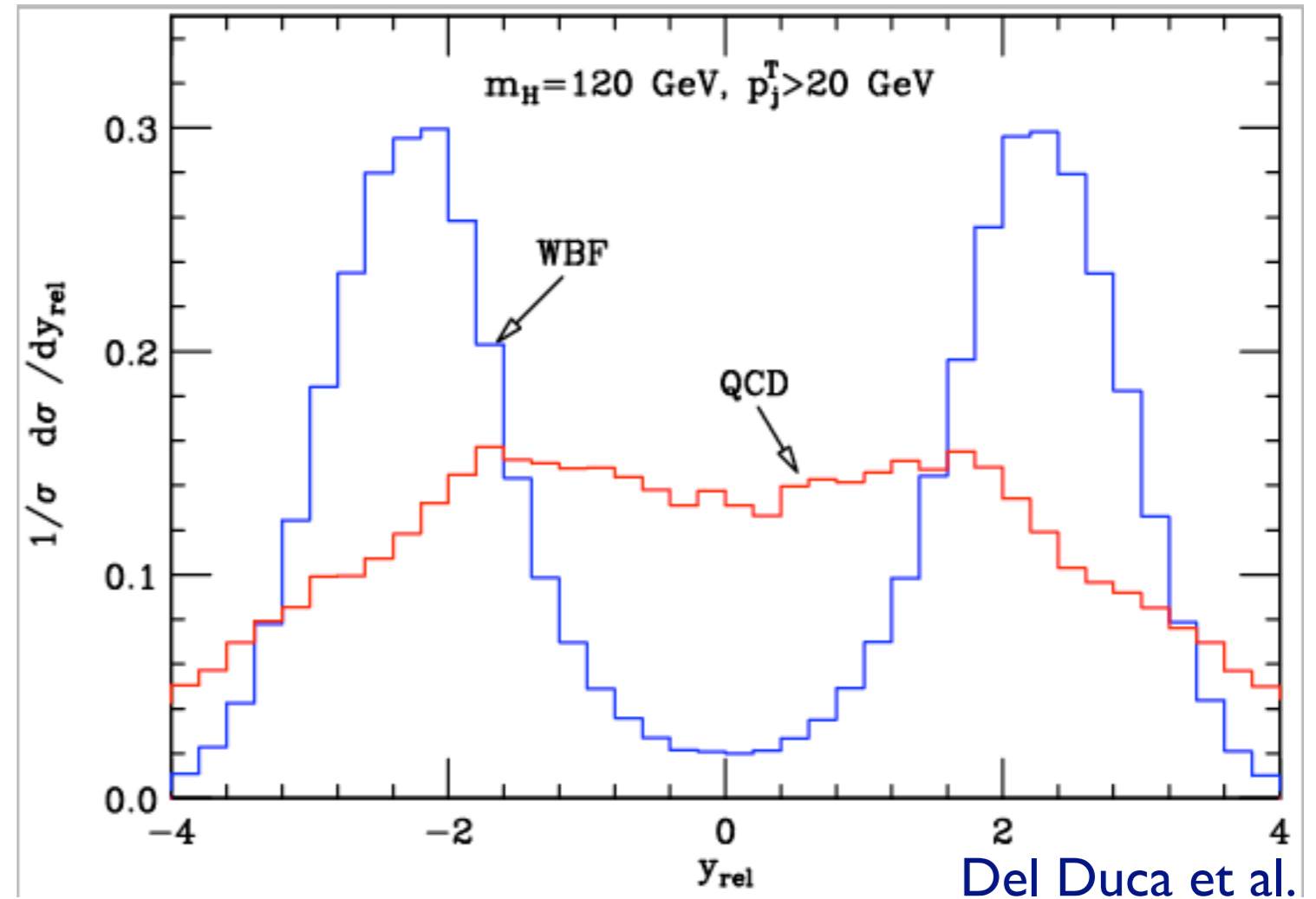
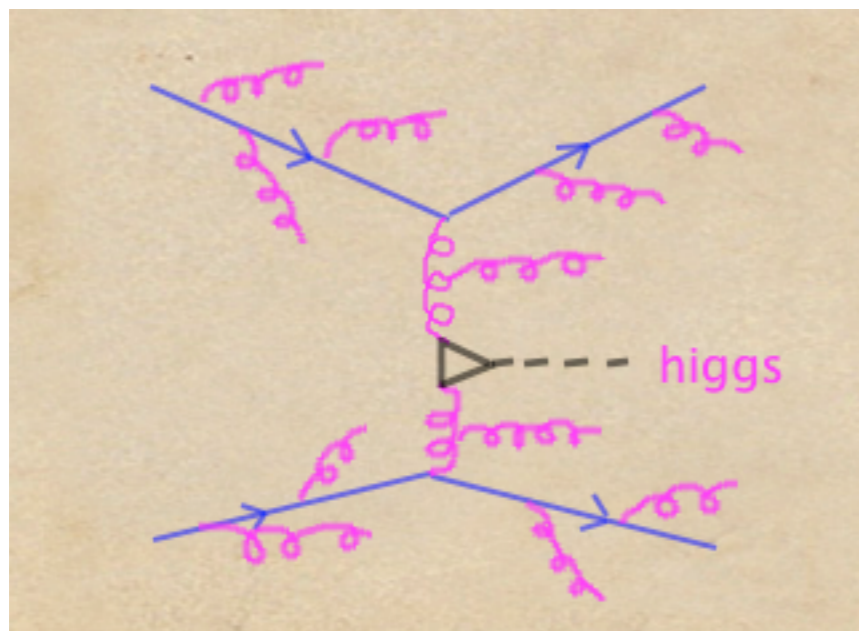
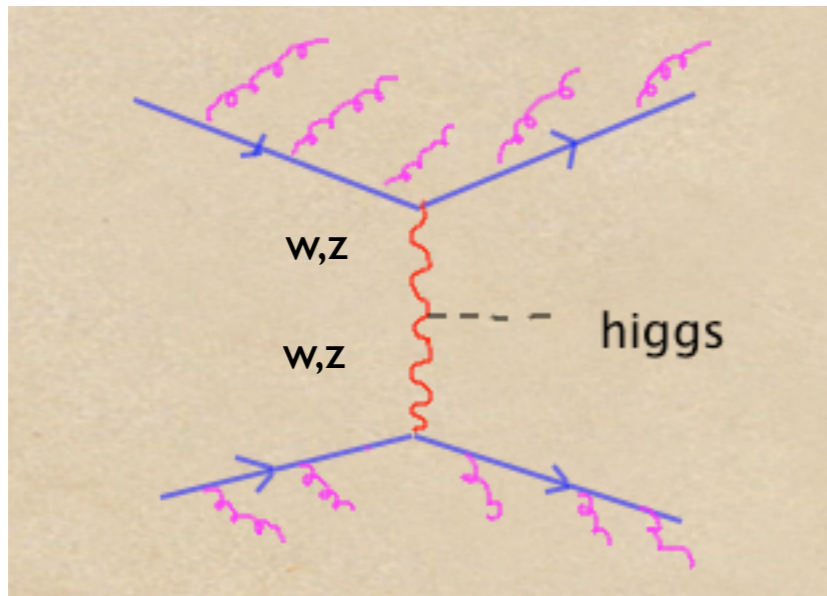

Third jet distribution



EXAMPLE: VBF FUSION

Consider VBF: at LO there is no exchange of color between the quark lines:

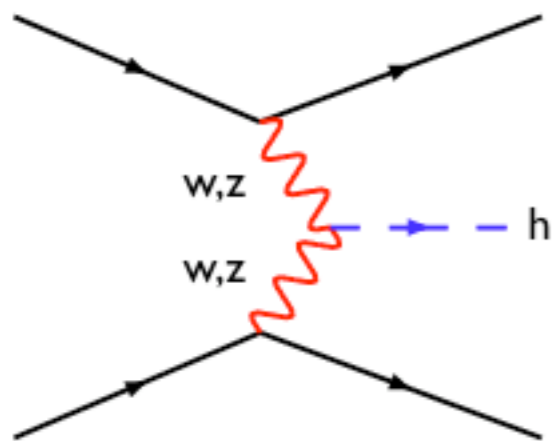

$$\delta_{ij}\delta_{kl}$$

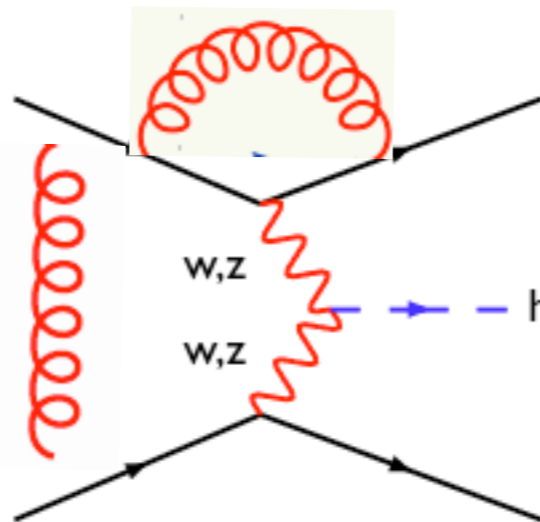

$$C_F \delta_{ij} \delta_{kl} \Rightarrow$$

$$M_{\text{tree}} M_{1\text{-loop}}^* = C_F N_c^2 \simeq N_c^3$$

$$\frac{1}{2} (\delta_{ik} \delta_{lj} - \frac{1}{N_c} \delta_{ij} \delta_{kl}) \Rightarrow$$

$$M_{\text{tree}} M_{1\text{-loop}}^* = 0$$

Also at NLO there is no color exchange! With one little exception....

At NNLO exchange is possible but it suppressed by $1/N_c^2$



QCD : THE FUNDAMENTALS

1. QCD is a good theory for strong interactions: facts
2. From QED to QCD: the importance of color
3. Renormalization group and asymptotic freedom

REN. GROUP AND ASYMPTOTIC FREEDOM

Let us consider the process:

$e^-e^+ \rightarrow \text{hadrons}$ and for a $Q^2 \gg \Lambda_s$.

At this point (though we will!) we don't have an idea how to calculate the details of such a process.

So let's take the most inclusive approach ever: we just want to count how many events with hadrons in the final state there are wrt to a pair of muons.

Zeroth Level: $e^+e^- \rightarrow qq$

$$R_0 = \frac{\sigma(e^+e^- \rightarrow \text{hadrons})}{\sigma(e^+e^- \rightarrow \mu^+\mu^-)} = N_c \sum_f Q_f^2$$

Very simple exercise. The calculation is exactly the same as for the $\mu^+\mu^-$.

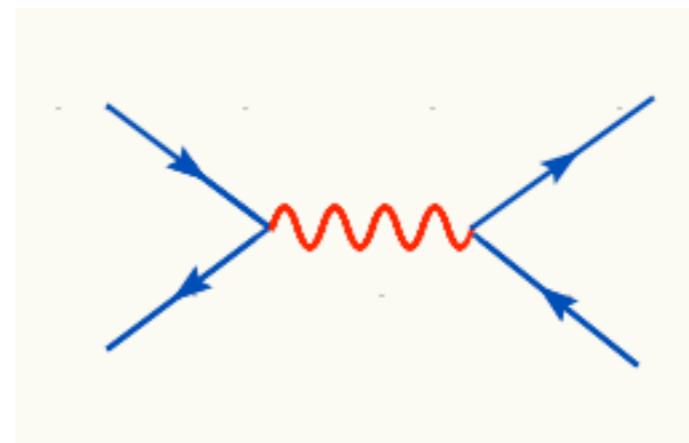
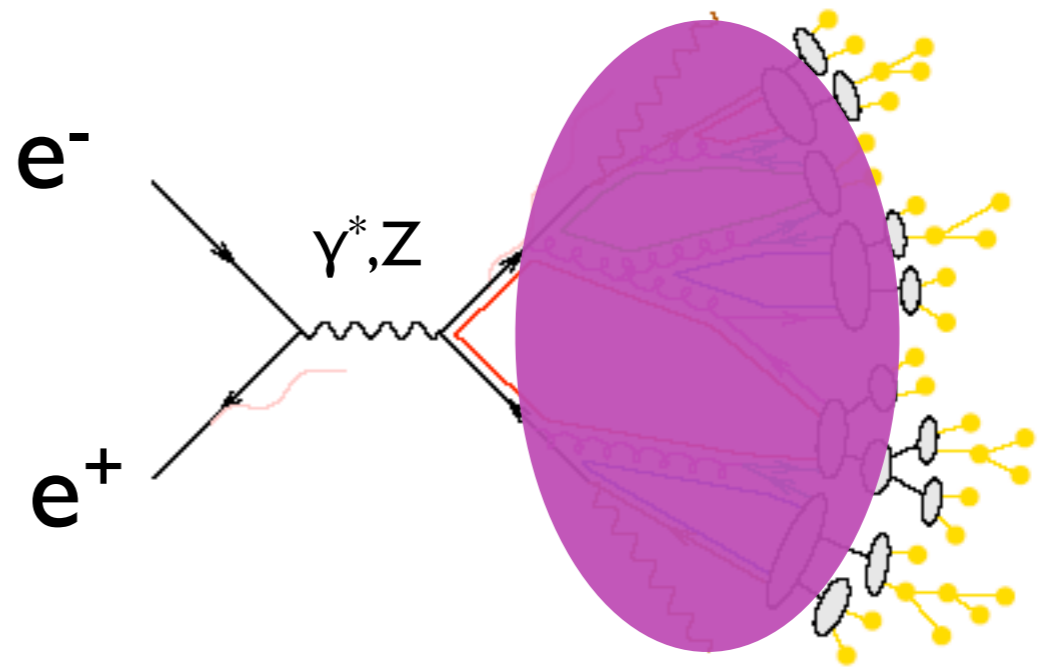

REN. GROUP AND ASYMPTOTIC FREEDOM

Let us consider the process:

$e^-e^+ \rightarrow \text{hadrons}$ and for a $Q^2 \gg \Lambda_s$.

At this point (though we will!) we don't have an idea how to calculate the details of such a process.

So let's take the most inclusive approach ever: we just want to count how many events with hadrons in the final state there are wrt to a pair of muons.

First improvement: $e^+e^- \rightarrow qq$ at NLO

Already a much more difficult calculation!

There are real and virtual contributions.

There are:

- * UV divergences coming from loops
- * IR divergences coming from loops and real diagrams. Ignore the IR for the moment (they cancel anyway) We need some kind of trick to regulate the divergences. Like dimensional regularization or a cutoff M . At the end the result is VERY SIMPLE:

No renormalization is needed! Electric charge is left untouched by strong interactions!

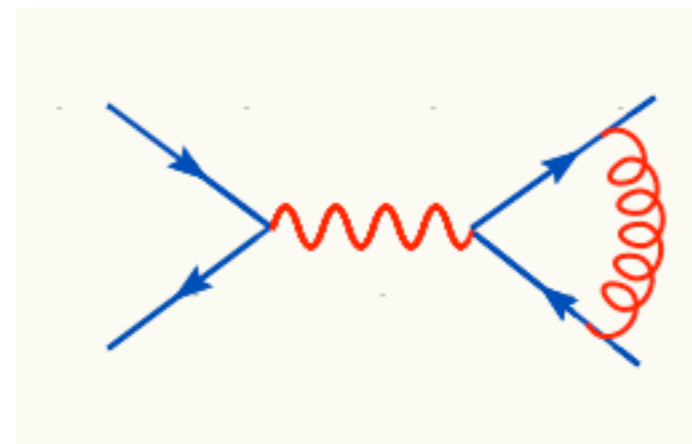
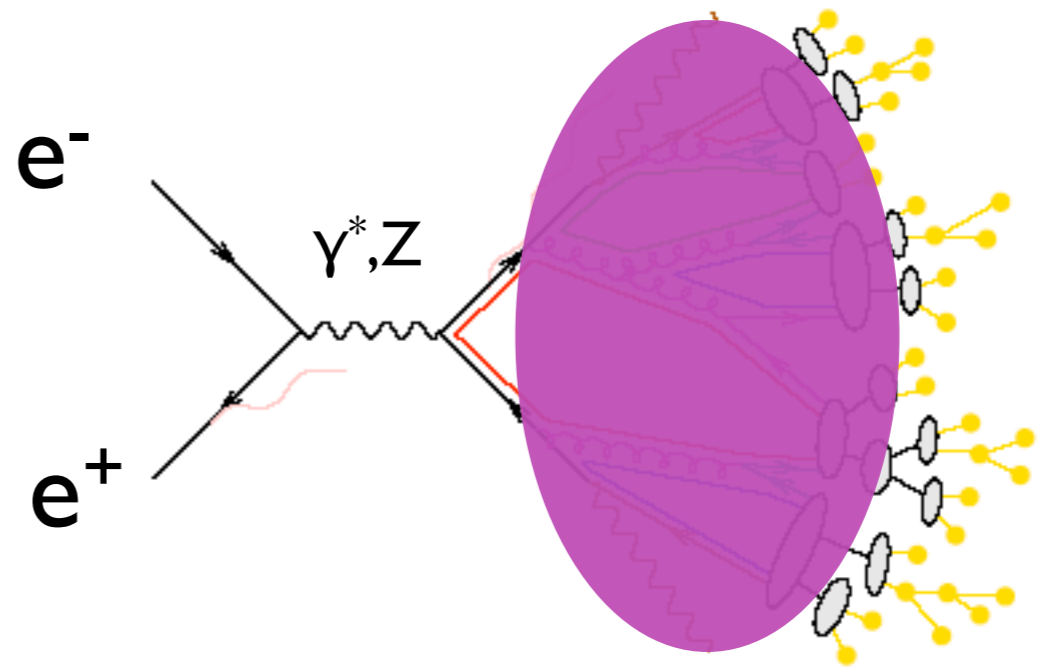

$$R_1 = R_0 \left(1 + \frac{\alpha_s}{\pi} \right)$$

REN. GROUP AND ASYMPTOTIC FREEDOM

Let us consider the process:

$e^-e^+ \rightarrow \text{hadrons}$ and for a $Q^2 \gg \Lambda_s$.

At this point (though we will!) we don't have an idea how to calculate the details of such a process.

So let's take the most inclusive approach ever: we just want to count how many events with hadrons in the final state there are wrt to a pair of muons.

Second improvement: $e^+e^- \rightarrow qq$ at NNLO

Extremely difficult calculation!

Something new happens:

$$R_2 = R_0 \left(1 + \frac{\alpha_S}{\pi} + \left[c + \pi b_0 \log \frac{M^2}{Q^2} \right] \left(\frac{\alpha_S}{\pi} \right)^2 \right)$$

The result is explicitly dependent on the arbitrary cutoff scale. We need to perform normalization of the coupling and since QCD is renormalizable we are guaranteed that this fixes all the UV problems at this order.

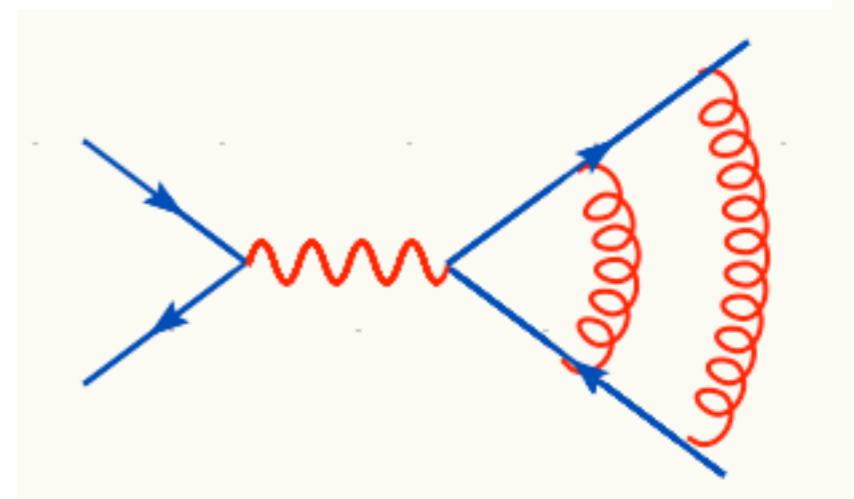
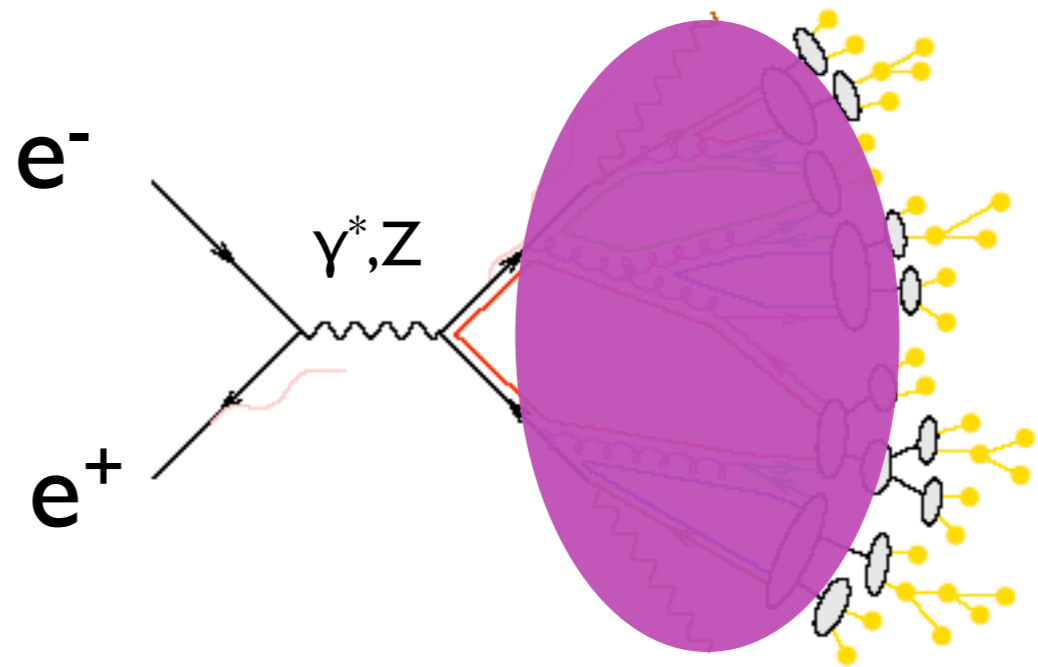

$$\alpha_S(\mu) = \alpha_S + b_0 \log \frac{M^2}{\mu^2} \alpha_S^2$$



REN. GROUP AND ASYMPTOTIC FREEDOM

$$(1) \quad R_2^{\text{ren}}(\alpha_S(\mu), \frac{\mu^2}{Q^2}) = R_0 \left(1 + \frac{\alpha_S(\mu)}{\pi} + \left[c + \pi b_0 \log \frac{\mu^2}{Q^2} \right] \left(\frac{\alpha_S(\mu)}{\pi} \right)^2 \right)$$

$$(2) \quad \alpha_S(\mu) = \alpha_S + b_0 \log \frac{M^2}{\mu^2} \alpha_S^2 \quad b_0 = \frac{11N_c - 2n_f}{12\pi} > 0$$

Comments:

1. Now R_2 is finite but depends on an arbitrary scale μ , directly and through α_S . We had to introduce μ because of the presence of M .

2. Renormalizability guarantees that any physical quantity can be made finite with the SAME substitution. If a quantity at LO is $A\alpha_S^N$ then the UV divergence will be $N A b_0 \log M^2 \alpha_S^{N+1}$.

3. R is a physical quantity and therefore cannot depend on the arbitrary scale μ !! One can show that at order by order:

$$\mu^2 \frac{d}{d\mu^2} R^{\text{ren}} = 0 \Rightarrow R^{\text{ren}}(\alpha_S(\mu), \frac{\mu^2}{Q^2}) = R^{\text{ren}}(\alpha_S(Q), 1)$$

which is obviously verified by Eq. (1). Choosing $\mu \approx Q$ the logs ...are resummed!



REN. GROUP AND ASYMPTOTIC FREEDOM

$$(2) \quad \alpha_S(\mu) = \alpha_S + b_0 \log \frac{M^2}{\mu^2} \alpha_S^2 \quad b_0 = \frac{11N_c - 2n_f}{12\pi} > 0$$

4. From (b) one finds that:

$$\beta(\alpha_S) \equiv \mu^2 \frac{\partial \alpha_S}{\partial \mu^2} = -b_0 \alpha_S^2 \quad \Rightarrow \quad \alpha_S(\mu) = \frac{1}{b_0 \log \frac{\mu^2}{\Lambda^2}}$$

This gives the running of α_S . Since $b_0 > 0$, this expression make sense for all scale $\mu > \Lambda$.

In general one has:

$$\frac{d\alpha_S(\mu)}{d \log \mu^2} = -b_0 \alpha_S^2(\mu) - b_1 \alpha_S^3(\mu) - b_2 \alpha_S^4(\mu) + \dots$$

where all b_i are finite (renormalization!). At present we know the b_i up to b_3 (4 loop calculation!!). b_1 and b_2 are renormalization scheme independent. Note that the expression for $\alpha_S(\mu)$ changes accordingly to the loop order. At two loops we have:

$$\alpha_S(\mu) = \frac{1}{b_0 \log \frac{\mu^2}{\Lambda^2}} \left[1 - \frac{b_1}{b_0^2} \frac{\log \log \mu^2 / \Lambda^2}{\log \mu^2 / \Lambda^2} \right]$$



WHY IS THE BETA FUNCTION NEGATIVE IN QCD?

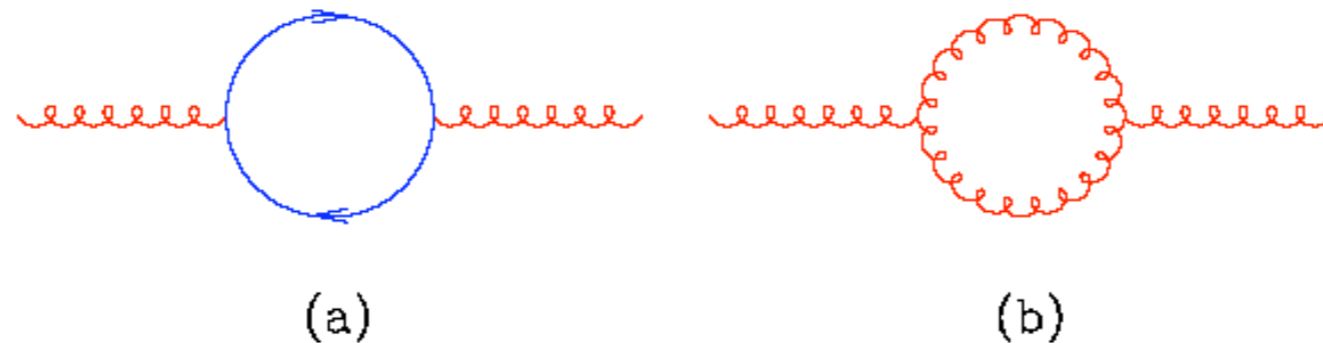

Roughly speaking, quark loop diagram (a) contributes a negative N_f term in b_0 , while the gluon loop, diagram (b) gives a positive contribution proportional to the number of colors N_c , which is dominant and make the overall beta function negative.

$$b_0 = \frac{11N_c - 2n_f}{12\pi} > 0 \quad \Rightarrow \quad \beta(\alpha_s) < 0 \text{ in QCD}$$

$$b_0 = -\frac{n_f}{3\pi} < 0 \quad \Rightarrow \quad \beta(\alpha_s) > 0 \text{ in QED}$$

$$\alpha_{EM}(\mu) = \frac{1}{b_0 \log \frac{\mu^2}{\Lambda_{QED}^2}}$$

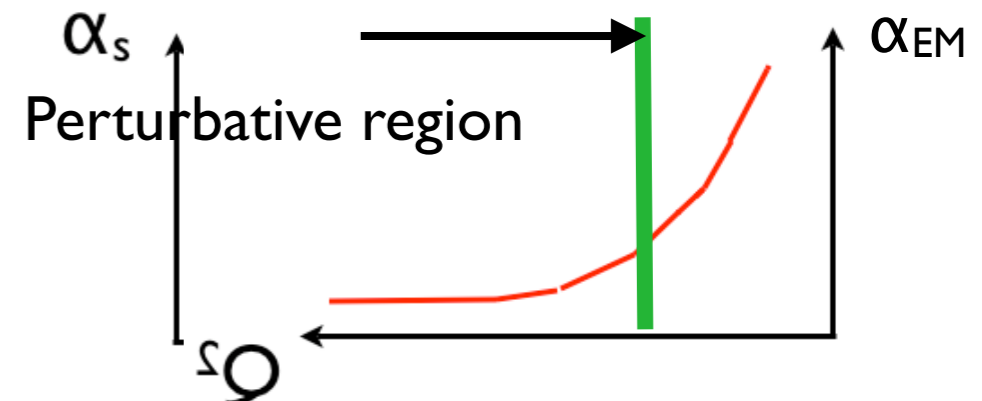



WHY IS THE BETA FUNCTION NEGATIVE IN QCD?



(a)

Roughly speaking, quark loop diagram (a) contributes loop, diagram (b) gives a positive contribution proportional to the number of colors, which is dominant and makes the overall beta function negative.

$$b_0 = \frac{11N_c - 2n_f}{12\pi} > 0 \Rightarrow$$

$$b_0 = -\frac{n_f}{3\pi} < 0 \Rightarrow$$

$$\alpha_{EM}(\mu) = \frac{1}{b_0 \log \frac{\mu^2}{\Lambda_{QED}^2}}$$

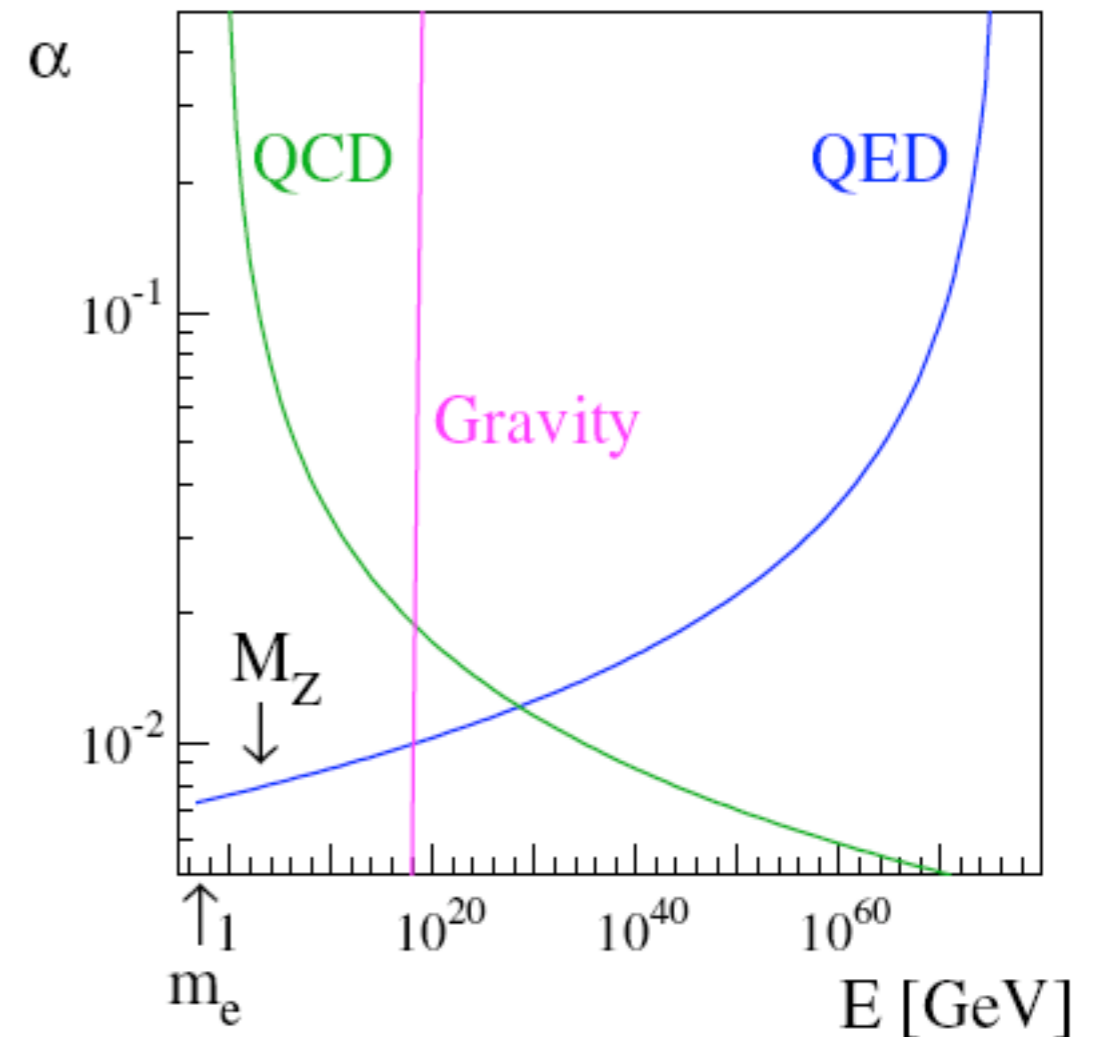

WHY IS THE BETA FUNCTION NEGATIVE IN QCD?

QED

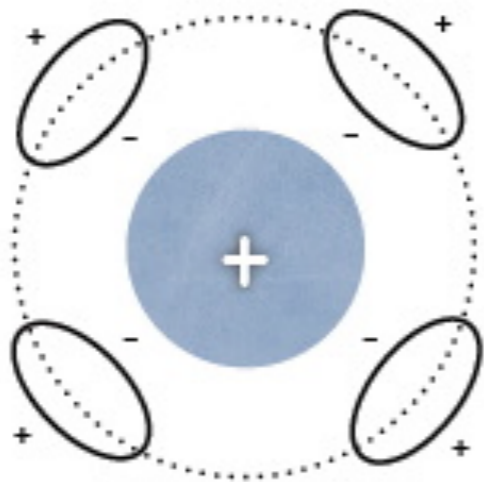

QCD

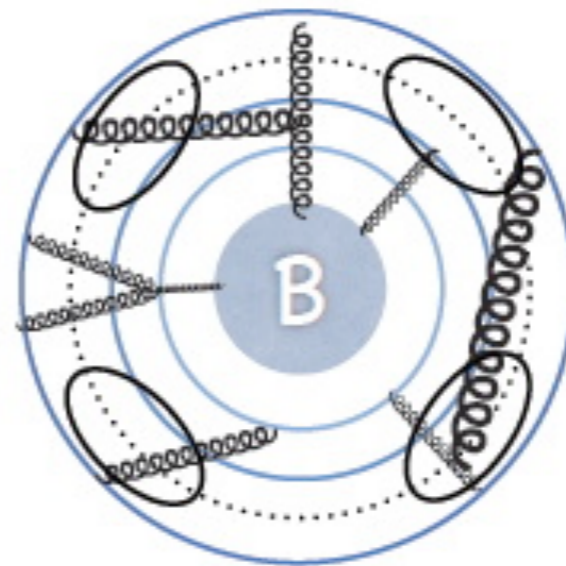



REN. GROUP AND ASYMPTOTIC FREEDOM

Given

$$\alpha_S(\mu) = \frac{1}{b_0 \log \frac{\mu^2}{\Lambda^2}} \quad b_0 = \frac{11N_c - 2n_f}{12\pi}$$

It is tempting to use identify Λ with $\Lambda_S=300$ MeV and see what we get for LEP I

$$R(M_Z) = R_0 \left(1 + \frac{\alpha_S(M_Z)}{\pi} \right) = R_0(1 + 0.046)$$

which is in very reasonable agreement with LEP.

This example is very sloppy since it does not take into account heavy flavor thresholds, higher order effects, and so on. However it is important to stress that had we measured 8% effect at LEP I we would have extracted $\Lambda=5$ GeV, a totally unacceptable value...



α_s : EXPERIMENTAL RESULTS

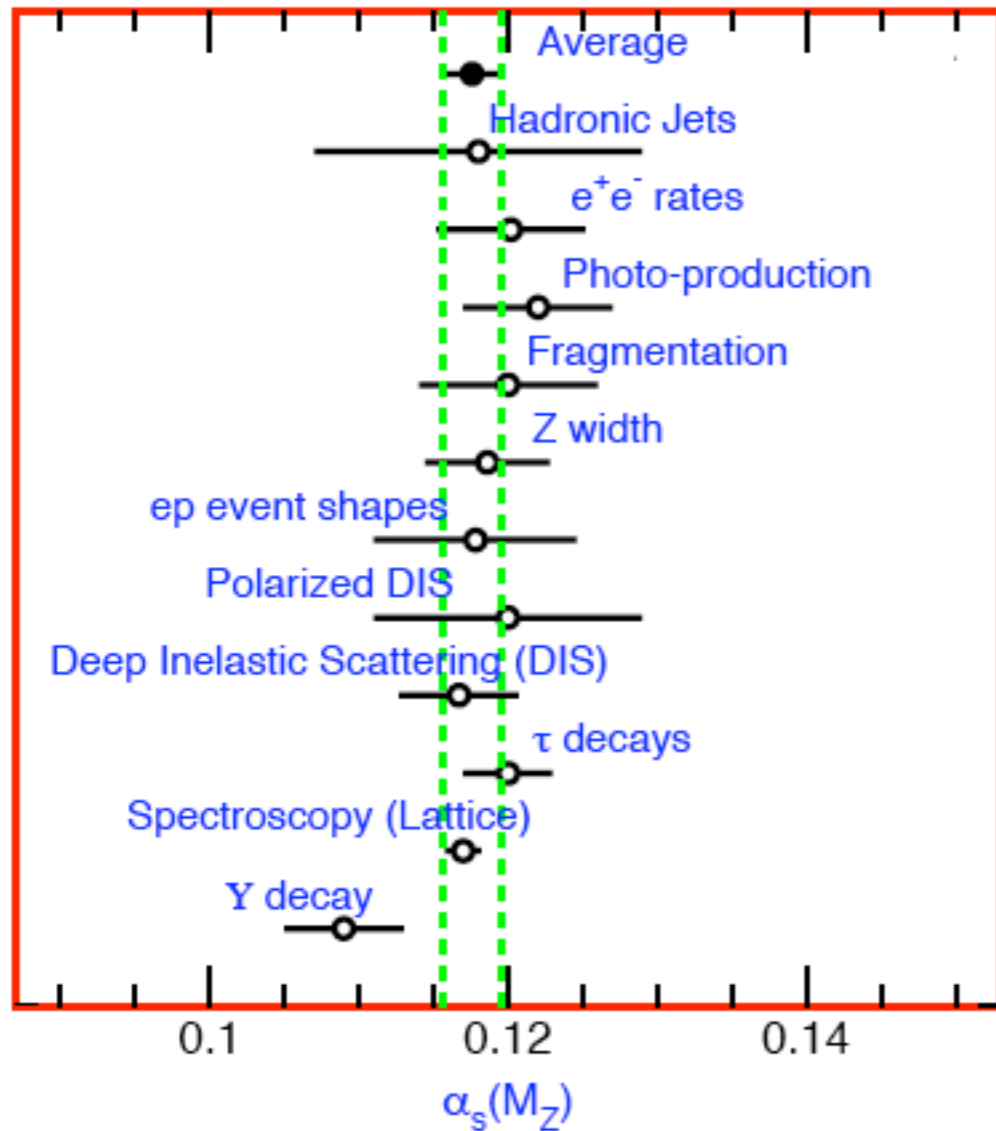

Many measurements at different scales all leading to very consistent results once evolved to the same reference scale, M_Z .

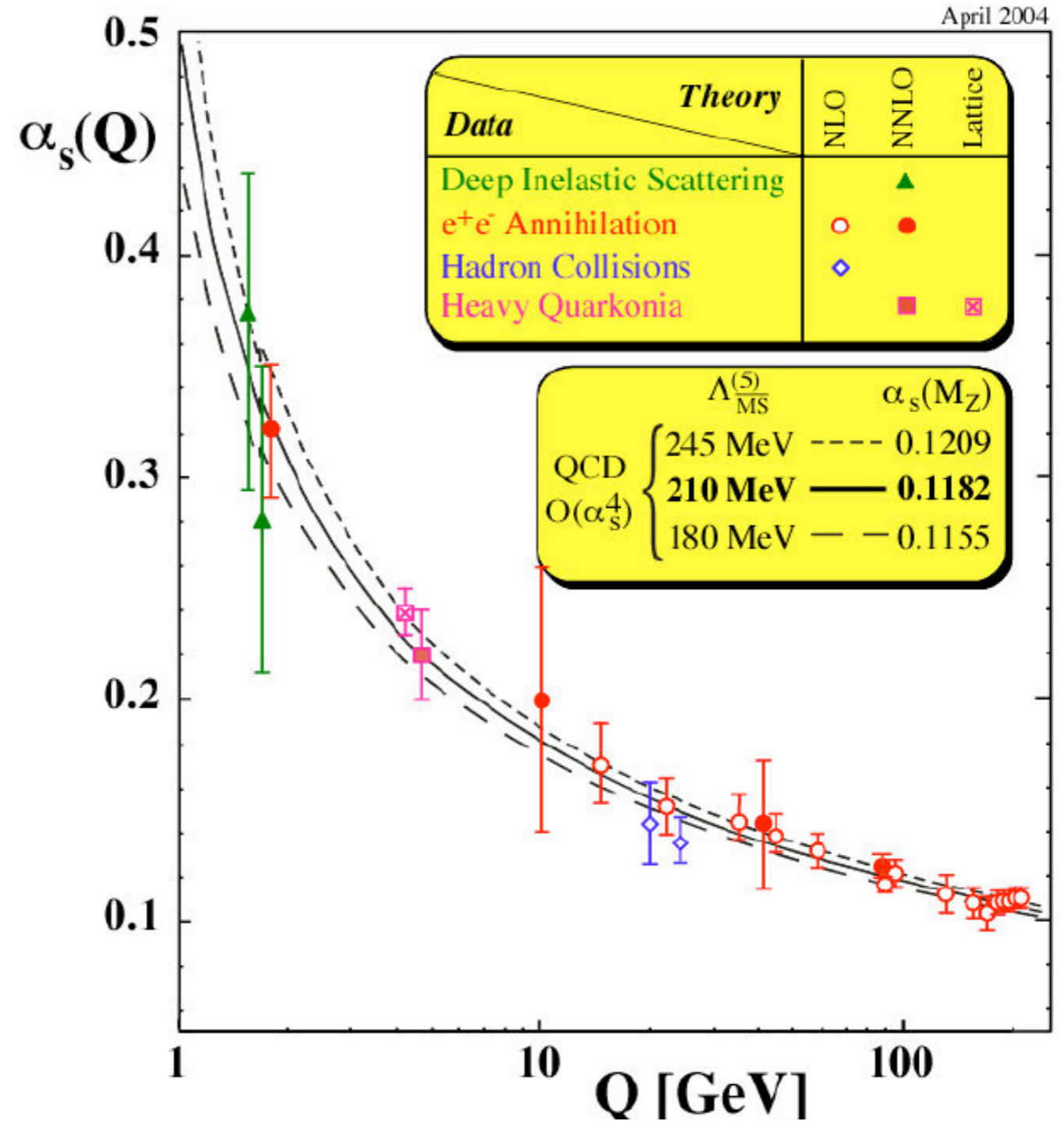



SCALE DEPENDENCE

$$R_2^{\text{ren}}(\alpha_S(\mu), \frac{\mu^2}{Q^2}) = R_0 \left(1 + \frac{\alpha_S(\mu)}{\pi} + \left[c + \pi b_0 \log \frac{\mu^2}{Q^2} \right] \left(\frac{\alpha_S(\mu)}{\pi} \right)^2 \right)$$

As we said, at all orders physical quantities do not depend on the choice of the renormalization scale. At fixed order, however, there is a residual dependence due to the non-cancellation of the higher order logs:

$$\frac{d}{d \log \mu} \sum_{n=1}^N c_n(\mu) \alpha_S^n(\mu) \sim \mathcal{O}(\alpha_S^{N+1}(\mu))$$

So possible (related) questions are:

- * Is there a systematic procedure to estimate the residual uncertainty in the theoretical prediction?
- * Is it possible to identify a scale corresponding to our best guess for the theoretical prediction?

BTW: The above argument proves that the more we work the better a prediction becomes!



SUMMARY

1. We have given evidence of why we think QCD is a good theory: hadron spectrum, scaling, QCD is a renormalizable and asymptotically free QFT, low energy (broken) symmetries.
2. We have seen how gauge invariance is realized in QCD starting from QED.
3. We have illustrated with an example the use of the renormalization group and the appearance of asymptotic freedom.