

Cyclotrons

Chapter 2

- Basic Longitudinal dynamics
- Acceleration
- Injection
- Extraction

Longitudinal dynamics

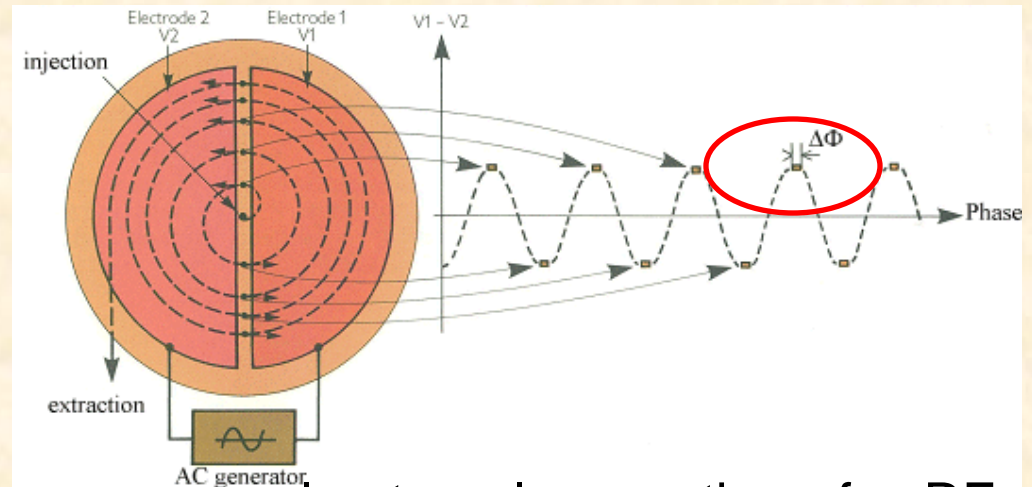

Longitudinal matching: A cyclotron can accelerate only a portion of a RF cycle

The acceptance is ± 20 RF (out of 360).

The external ion source, such as ECR or EBIS etc... delivers DC-beams compared to the cyclotron RF frequency.

A buncher located upstream the cyclotron injection will accelerate particles which would come late to the first accelerating gap and decelerates the ones coming too early. Then, more particles can be accelerated in the cyclotron within the $\pm 20^\circ$ RF acceptance. Increase the efficiency by a factor 4-6

Buncher principle

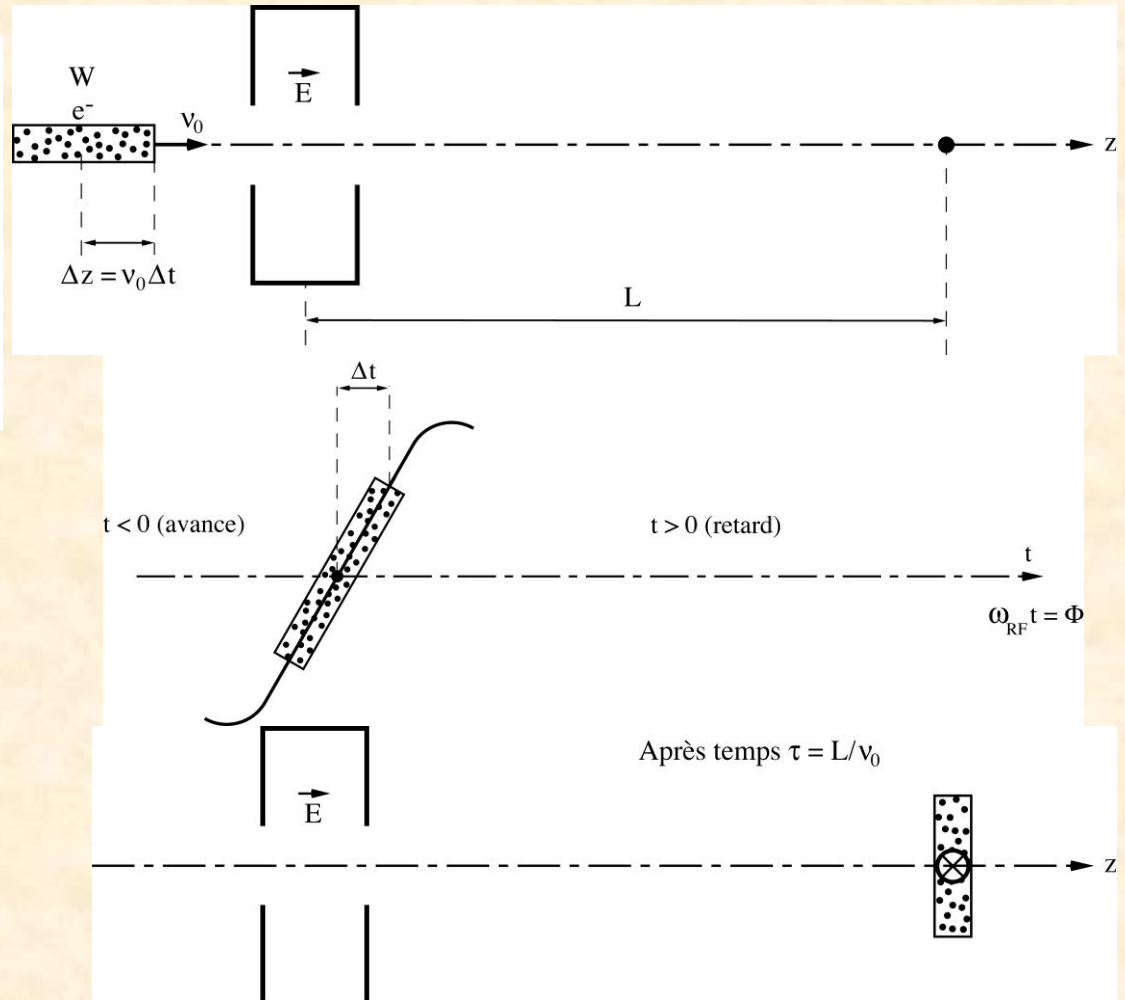
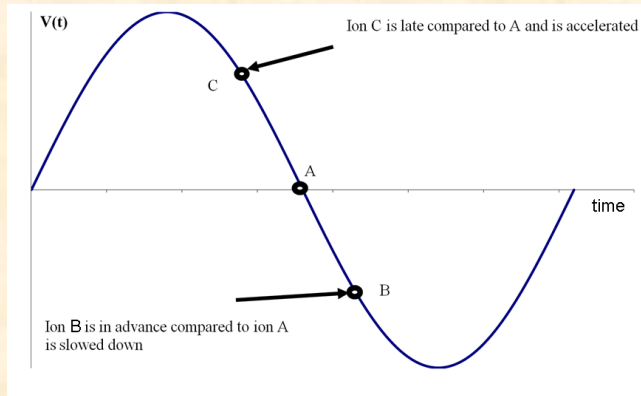

Bunching effect comes from a velocity (energy) modulation with respect to time, transformed into space modulation after a certain drift length.

Acceleration

- The final energy is independent of the accelerating potential $V = V_0 \cos\varphi$.

If V_0 varies, the **number** of turn varies.

- **The energy gain** per turn depends on the peak voltage V_0 , but is constant, if the cyclotron is **isochronous** ($\varphi = \text{const}$):

$$\delta W = N_g q V_0 \cos\varphi \quad N_g : \text{number of gaps}$$

- The radial separation turn between two turns varies as $1/r$ ($\gamma \sim 1$):

$$\frac{\delta r}{r} = \frac{1}{2} \frac{\delta W}{W} = \frac{q V_0 \cos\varphi}{2 W} \propto \frac{1}{r^2}$$

$$\delta r \propto \frac{1}{r}$$

RF Technology

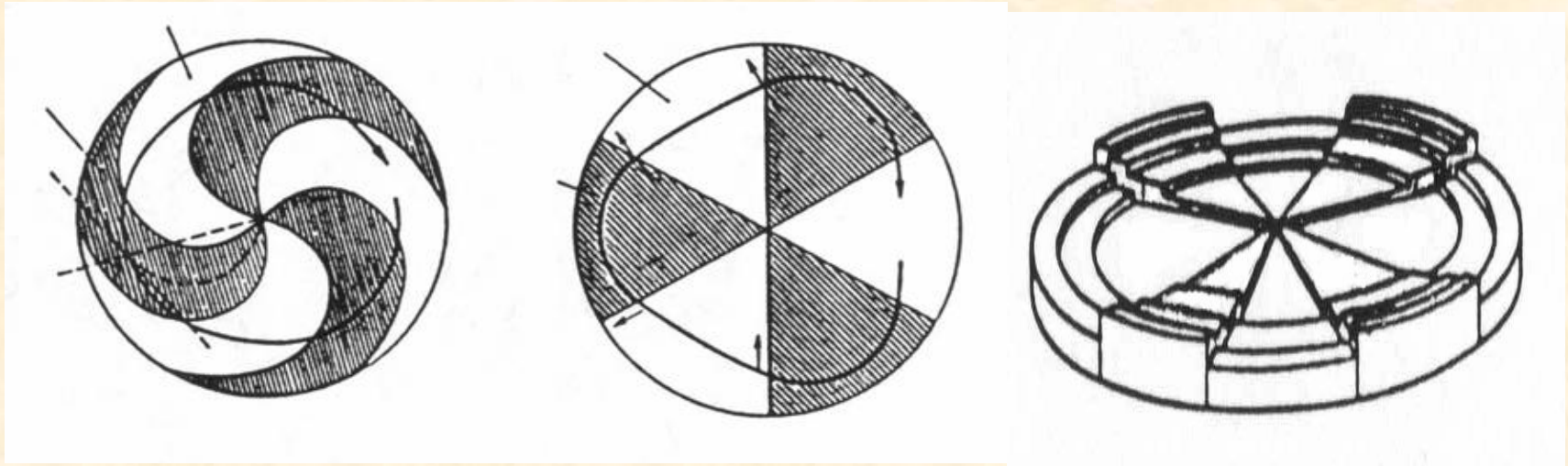

The choice of the pole shape and the number of sectors have a great impact on the available space for RF systems. Dees, and possibly stems and liners have to fit into the gaps and/or valley sections

RF Cavities (not Dees)

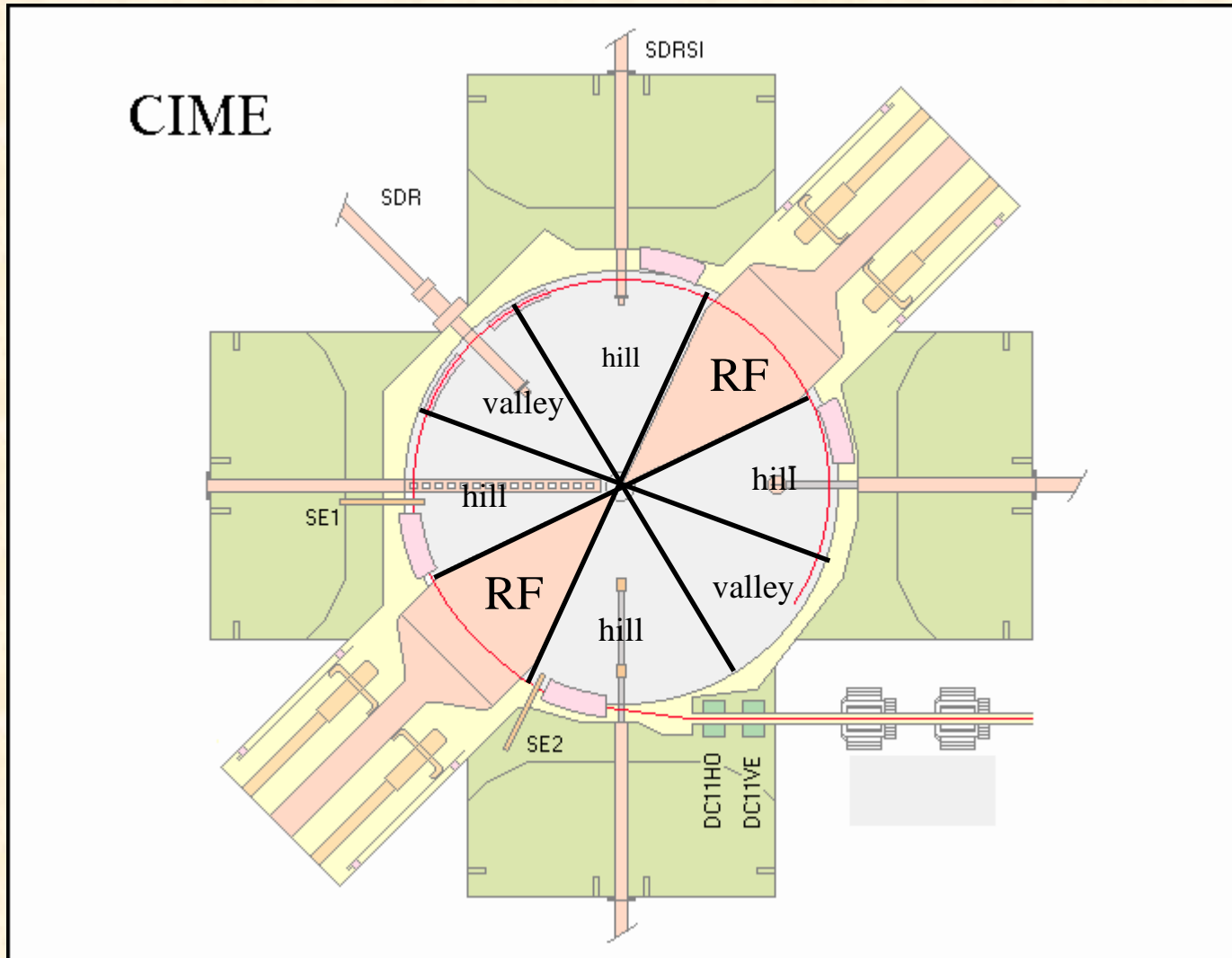

Example of RF Cavities (not Dees)

Energy gain in 1 gap of CIME cyclotron:

$$\delta W = qV_0 \sin\left(\frac{h\alpha}{2}\right) \cos \varphi$$

- For a maximum energy gain ($\cos\varphi = 1$) the particle passes the symmetry cavity axis
- Energy gain per gap for the various harmonic mode

$$\delta W = qV_0 \sin\left(\frac{h\alpha}{2}\right)$$

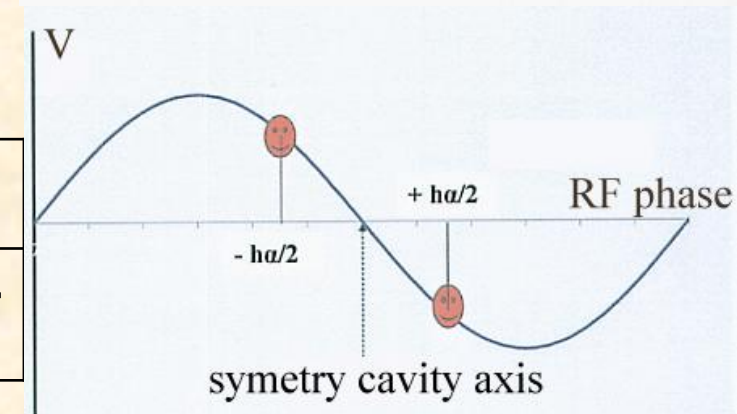
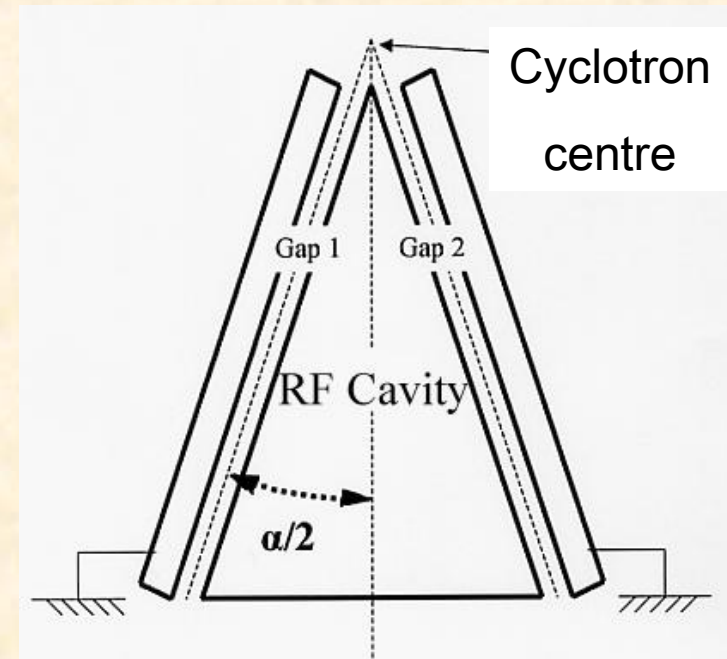

h	2	3	4	5	6	7	8
Sin(hα/2) (α = 40°)	0.64	0.87	0.98	0.98	0.86	0.64	0.34

All the modes accelerate the particles but for $h > 7$ the efficiency is too low.

Accelerating gap

The formula $\delta W = QV_0 \sin\left(\frac{h\alpha}{2}\right)$ corresponds to small accelerating gaps
Because of the gap geometry, the efficiency of the acceleration through
the gap (g) is **modulated** by the **transit time factor** τ :

$$\tau = \frac{\sin\left\{\frac{hg}{2r}\right\}}{\frac{hg}{2r}} < 1 \quad \delta W = QV_0 \tau \sin\left(\frac{h\alpha}{2}\right)$$

Introduction of pillars into the cavity to reduce the azimuthal field extension (seen in the § injection)

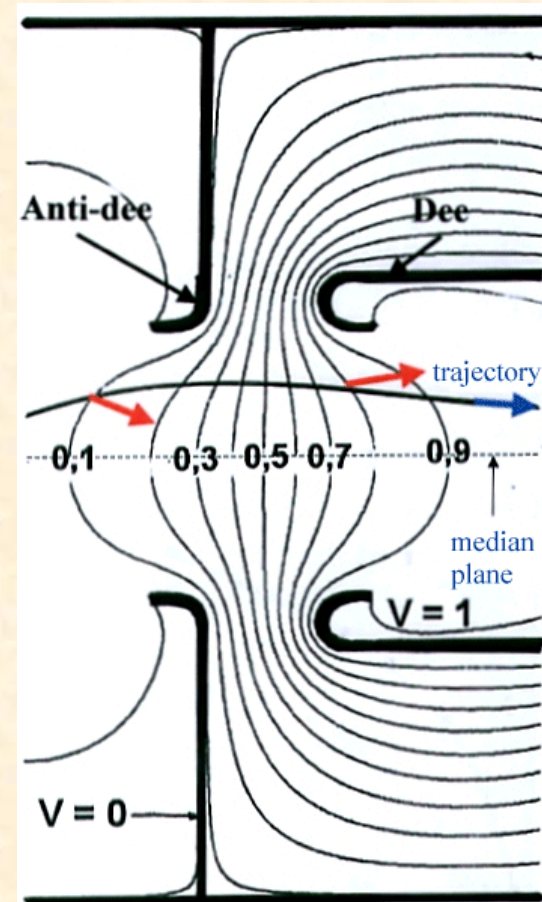

The Structure of a GANIL Double Gap $\lambda/2$ Resonator

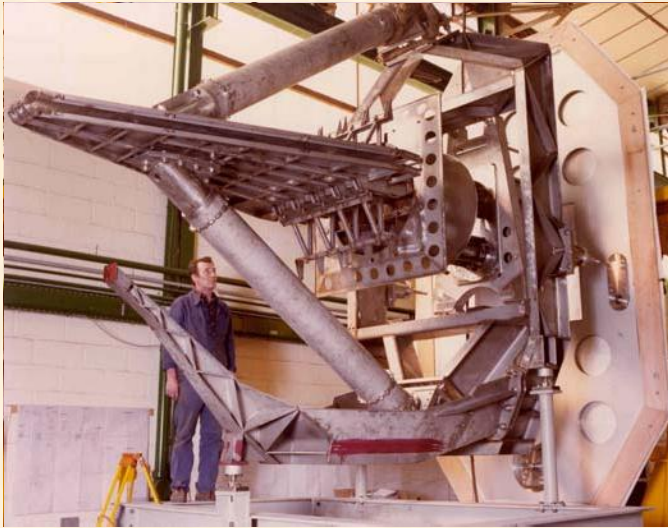

Stainless steel support frame, beam plane is visible



Copper skinned inner conductors with 'Dee' (inner electrode)



Outer shell of resonator, with support frame and beam slit

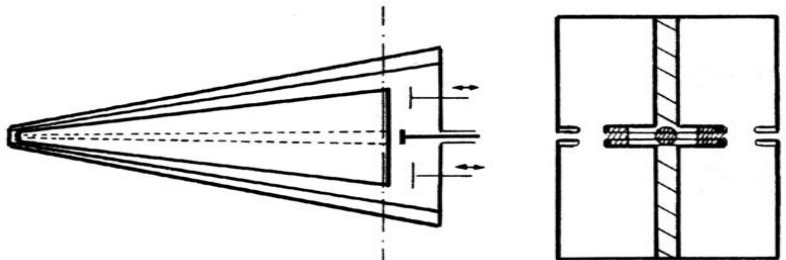

An example of a separate sector cyclotron: the PSI ring cyclotron

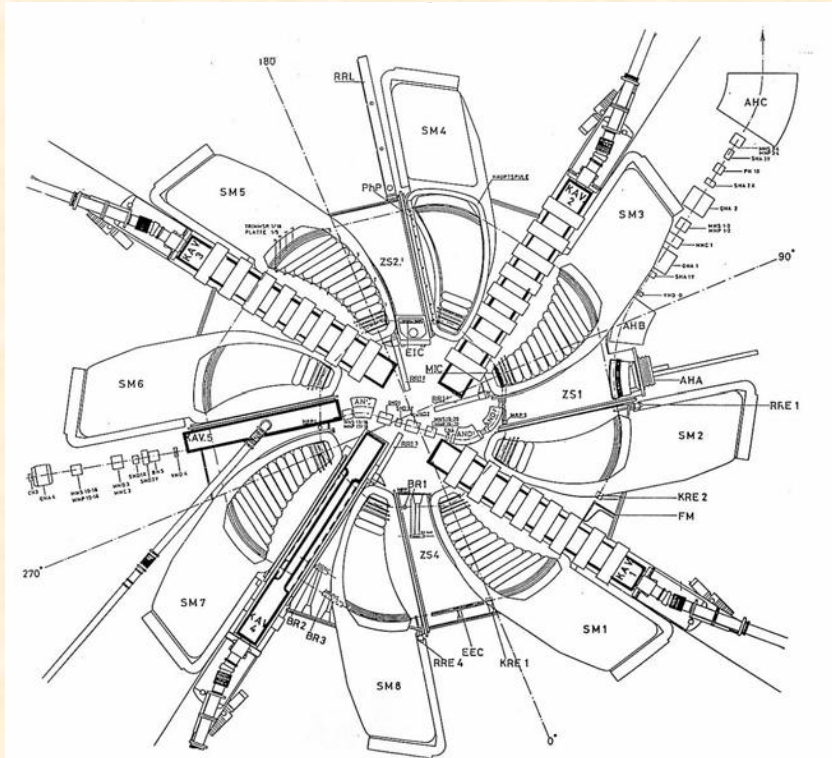

Typical 'Separated Sector Cyclotron' (SSC), median plane view (left), and photo (right). Shown is the PSI 590 MeV (p) ring cyclotron, with 8 sector magnets and 4 accelerating cavities

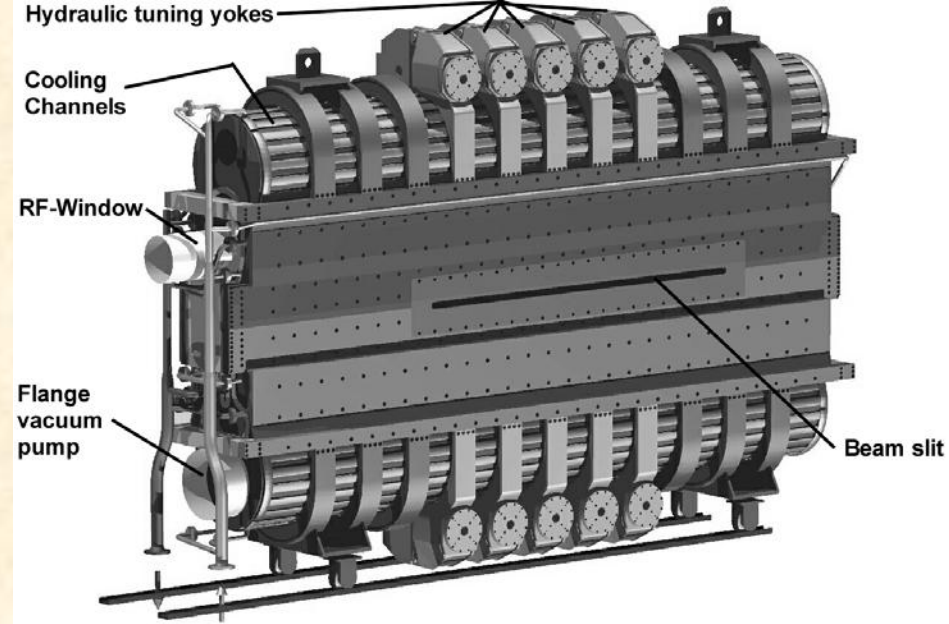

50 MHz, CW
Voltage: 1 MV

Beam injection

- Axial injection
- Radial injection

Axial injection

Injection of the beam through the centre
of the cyclotron

Cold Cathode PIG Ion Source

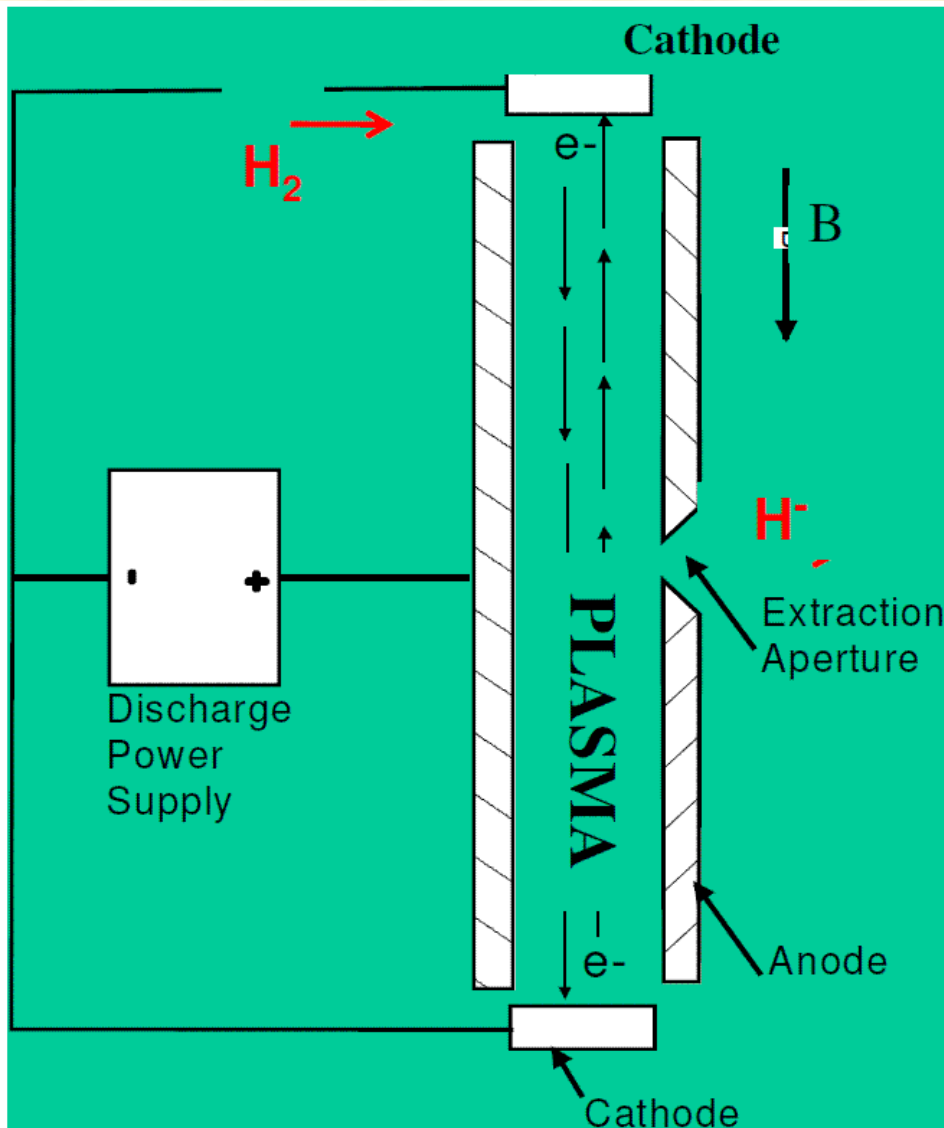

- Electron emission due to electrical potential on the cathodes
- Electron confinement due to the magnetic field along the anode axis
- Electrons produced by thermionic emission and ionic bombardment
 - Start-up: 3 kV to strike an arc
 - At the operating point : 100 V
- Cathodes heated by the plasma (100 V is enough to pull an outer e- off the gas atoms)

Example of PIG source

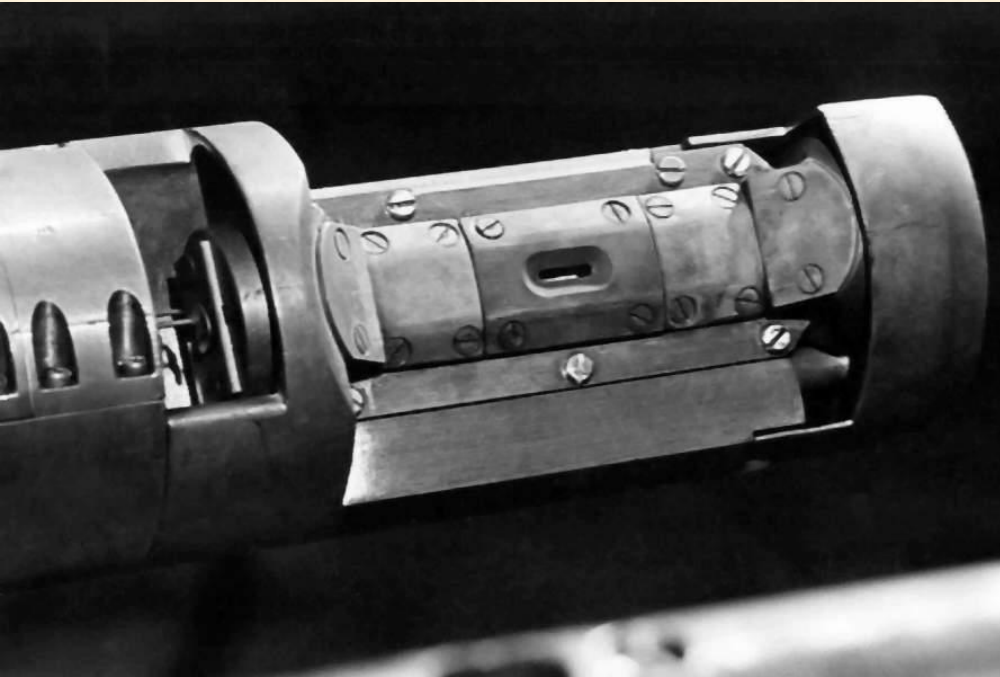

**FLNR, PIG test-bed, 1992.
The head of MC400 cyclotron vertical ion
source**



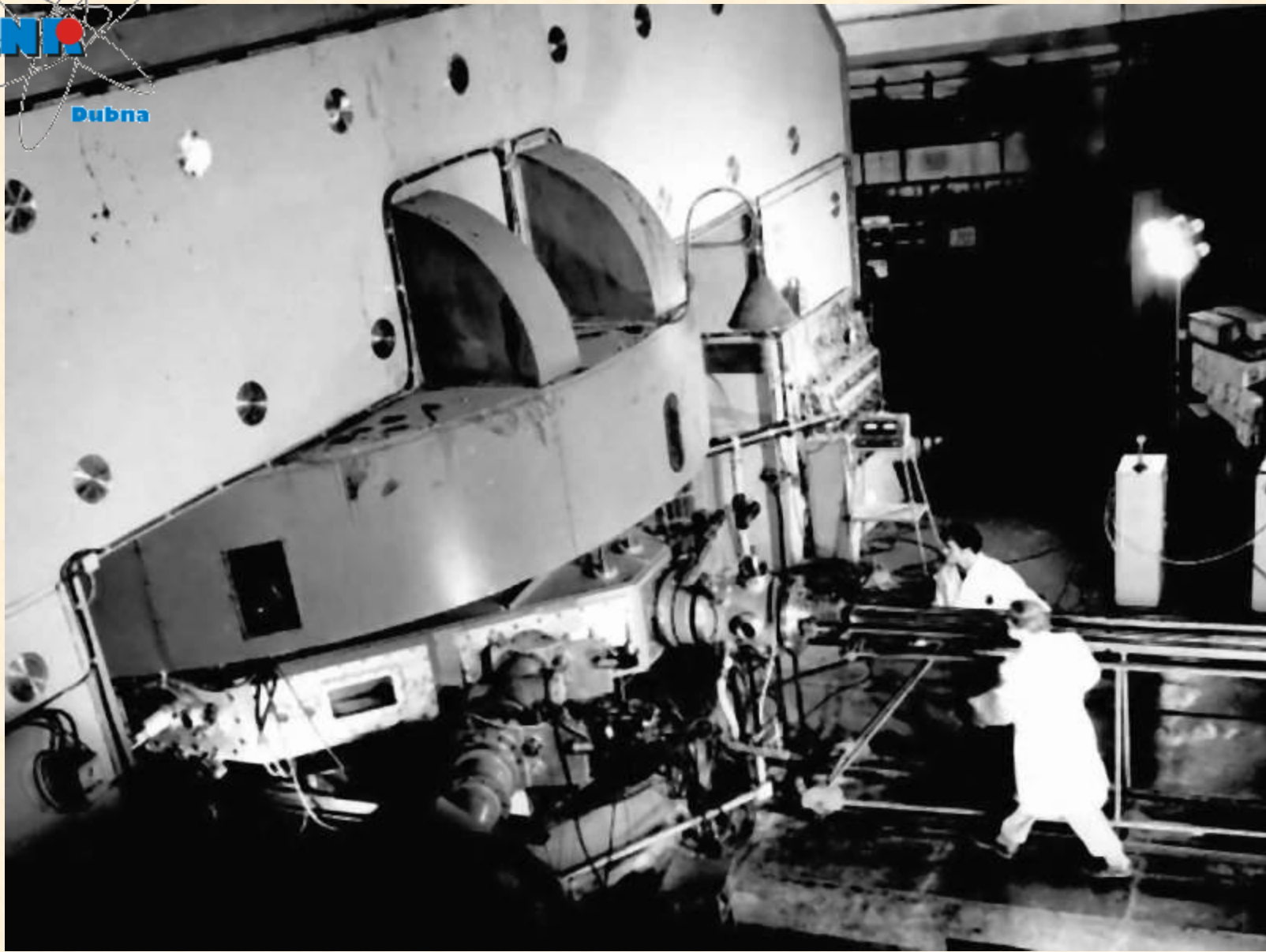

**FLNR, U300, 1970.
Ion Source mounting**

Remote ECR ion source



Axial injection

1. The electrostatic mirror
 - Simplest: A pair of planar electrodes which are at an angle of 45° to the incoming beam. The first electrode is a grid reducing transmission (65% efficiency).
 - smallest
 - High voltage

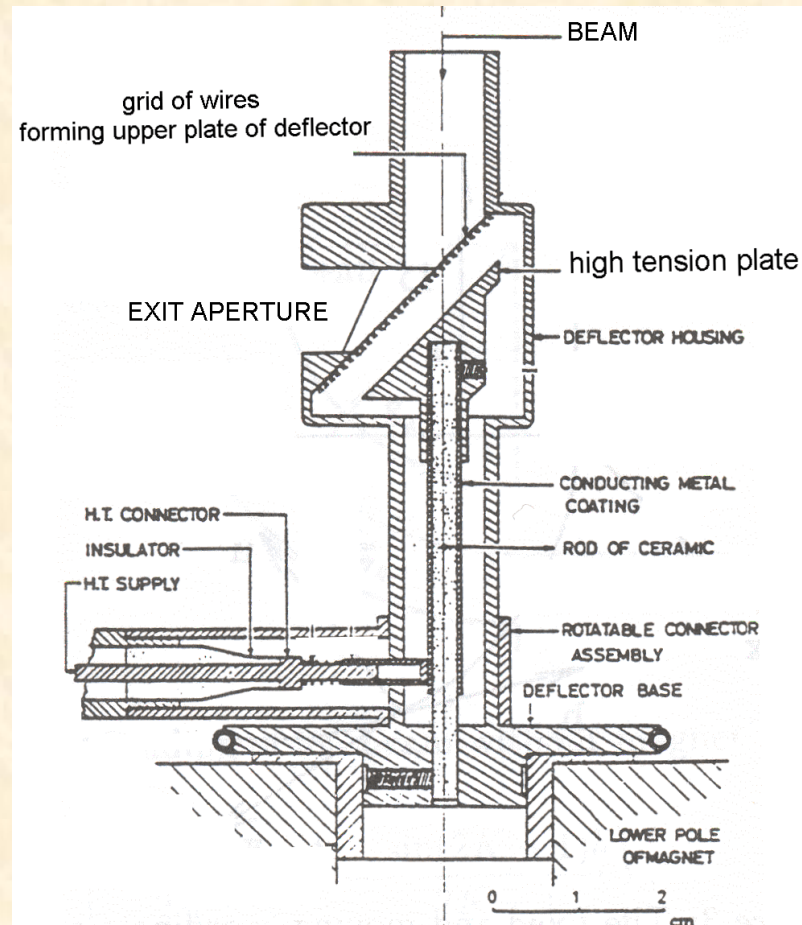

Axial injection

1. The electrostatic mirror
 - Simplest: A pair of planar electrodes which are at an angle of 45° to the incoming beam. The first electrode is a grid reducing transmission (65% efficiency).
 - smallest
 - High voltage
2. Spiral inflector (or helical channel)
 - analytical solution

Spiral inflector

Inflecteur CIME

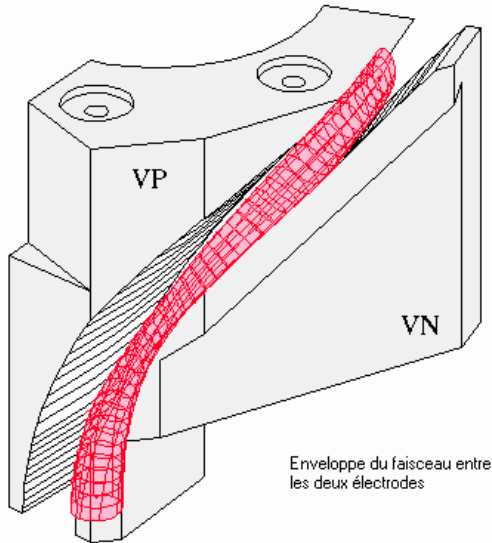

- First used in Grenoble (J.L. Pabot and J.L. Belmont)

- Consists of 2 cylindrical capacitors which have been twisted to take into account the spiraling of the ion trajectory from magnet field.

- $\vec{v}_{beam} \perp \vec{E}$: central trajectory lies on an equipotential surface. Allows lower voltage than with mirrors.

- 2 free parameters (spiral size in z and xy) giving flexibility for central region design

- 100 % transmission

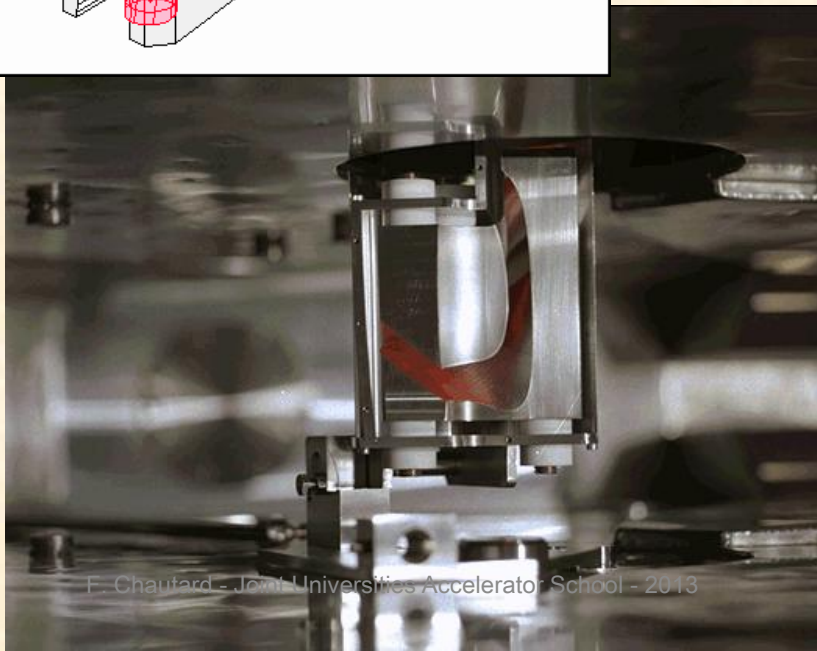

Axial injection

1. The electrostatic mirror
 - Simplest: A pair of planar electrodes which are at an angle of 45° to the incoming beam. The first electrode is a grid reducing transmission (65% efficiency).
 - smallest
 - High voltage
2. Spiral inflector (or helical channel)
 - analytical solution
3. The hyperboloid inflector
 - Simpler to construct because of revolution surface
 - No free parameters and bigger than a Spiral inflector
 - No transverse correlation. Easy beam matching
4. The parabolic inflector: not use in actual cyclotron, similar to hyperboloid
5. Axial hole

Central region

- Ion beam created by:
 - Internal source (PIG)
 - External source 1962 (ECR): The beam is injected vertically through the cyclotron yoke and reaches the horizontal trajectory
 - Dynamics problems encountered especially when running the machine for various harmonics.

- Goal : put the beam on the « good orbit » with the proper phase.
- The initial gaps are delimited with **pillars/posts** reducing the transit time and the vertical component of the electric field.
- The potential map are computed (in 3D if necessary)

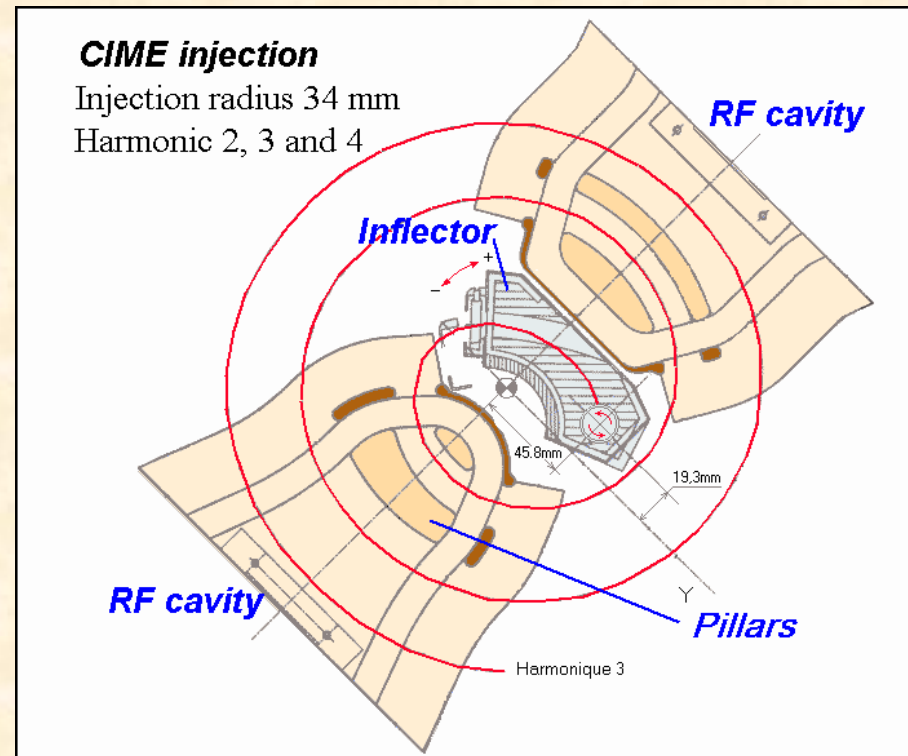

Radial injection

Injection of the beam through the magnetic gap of the cyclotron

Radial injection

1. Trochoidal (Lebedev Institute in Moscow)

- Field difference between hill-valley to send the beam on a trochoidal trajectory to the central region. (300 keV)

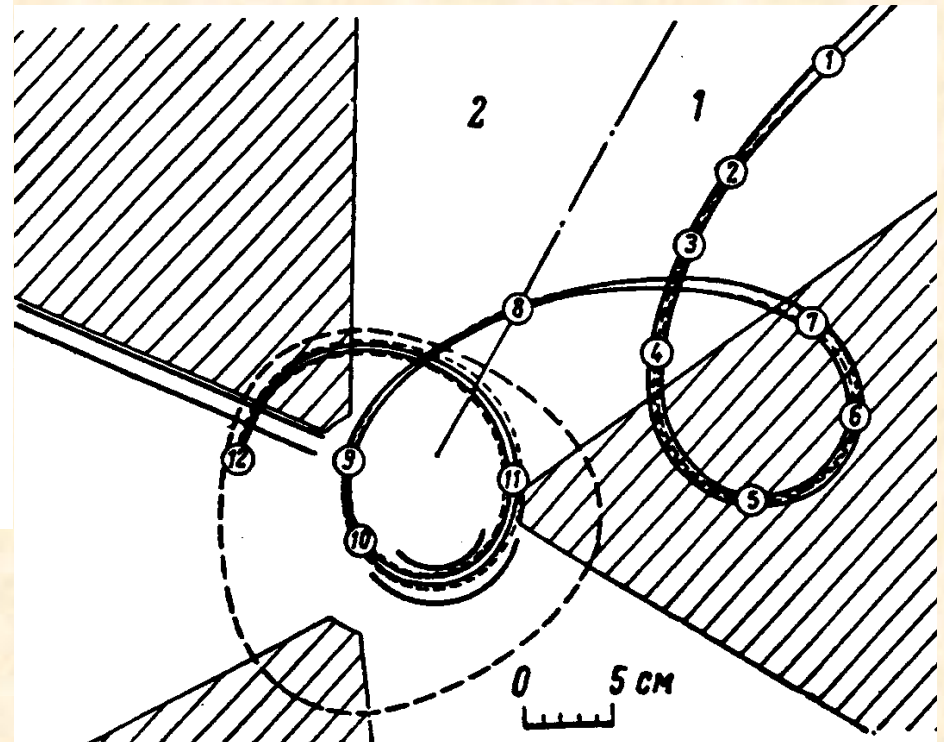
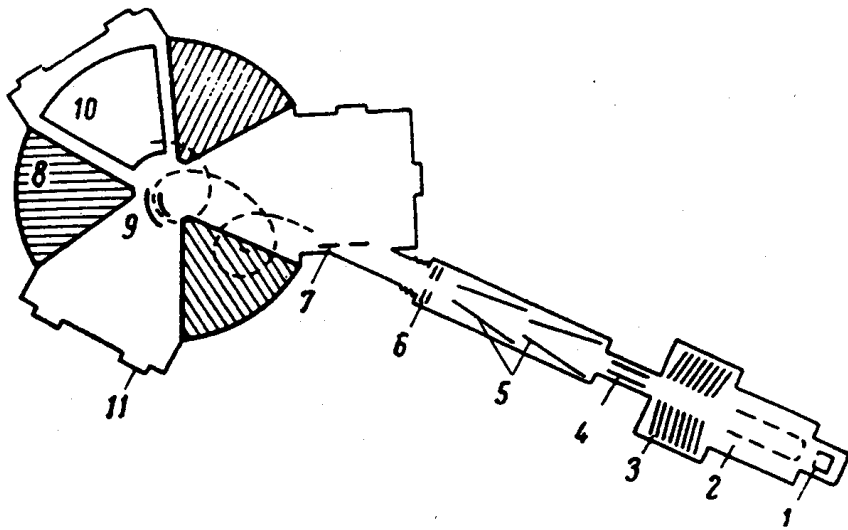

Radial injection

1. Trochoidal (Lebedev Institut in Moscow)
 - Field difference between hill-valley to send the beam on a trochoidal trajectory to the central region. (300 keV)
 - Not used today
2. Electric field cancelling magnetic field (Saclay, 1965)
 - system of electrodes shaped to provide horizontal electric field to cancel the force for the magnetic field to focus the beam on its path to the cyclotron centre.
 - Poor transmission (few percent)
3. Injection from another accelerator
 - Tandem + stripping + cyclotron : Oak Ridge, Chalk River
 - Matching between magnetic rigidity of the injected beam and the first cyclotron orbit rigidity
4. Injection into separated sector cyclotron
 - More room for injection pieces and excellent transmission

Example: Radial injection in SSC

- More room to insert bending elements.
- The beam coming from the pre-injector enters the SSC horizontally.
- It is guided by 4 magnetic dipoles to the “good trajectory”, then an electrostatic inflector deflects the beam behind the dipole yokes.

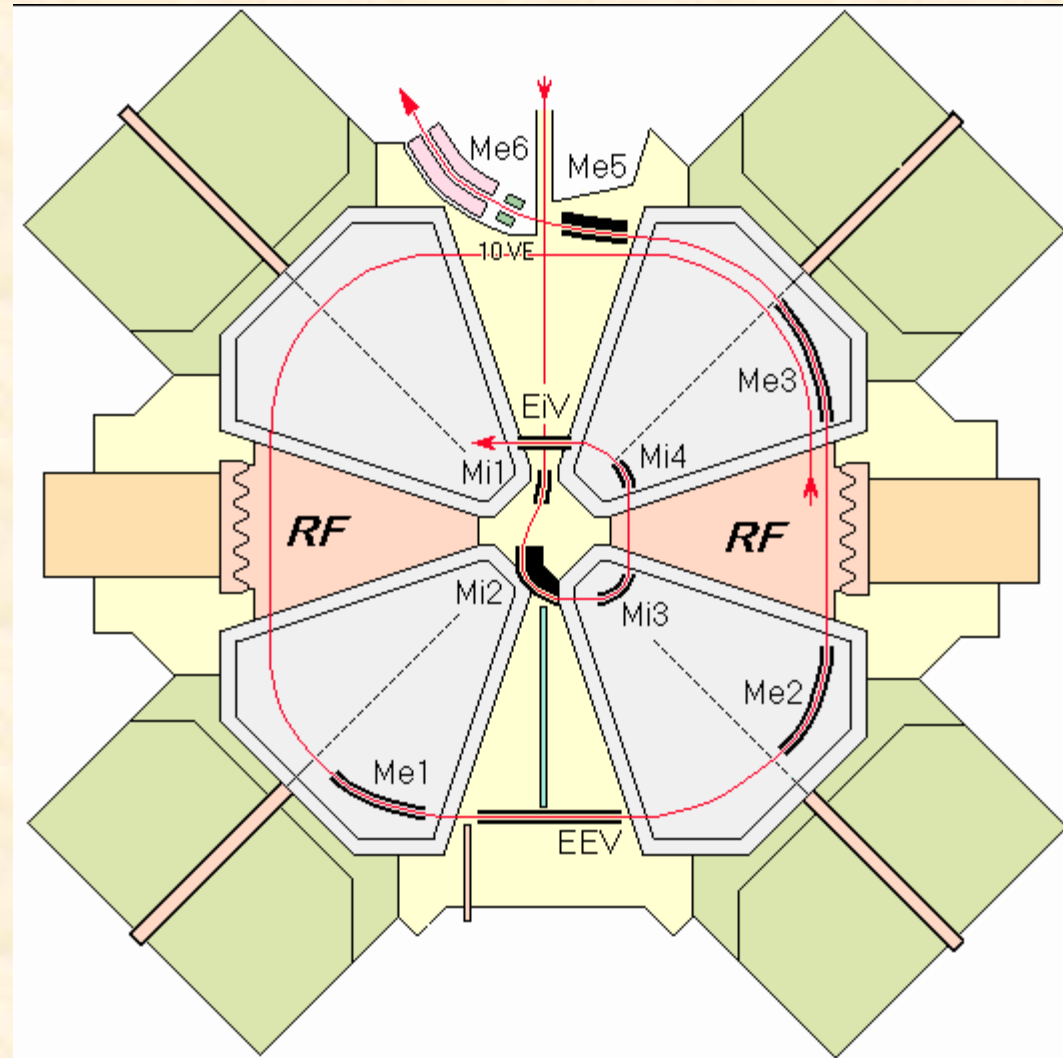



INFLECTEUR DE CSS1

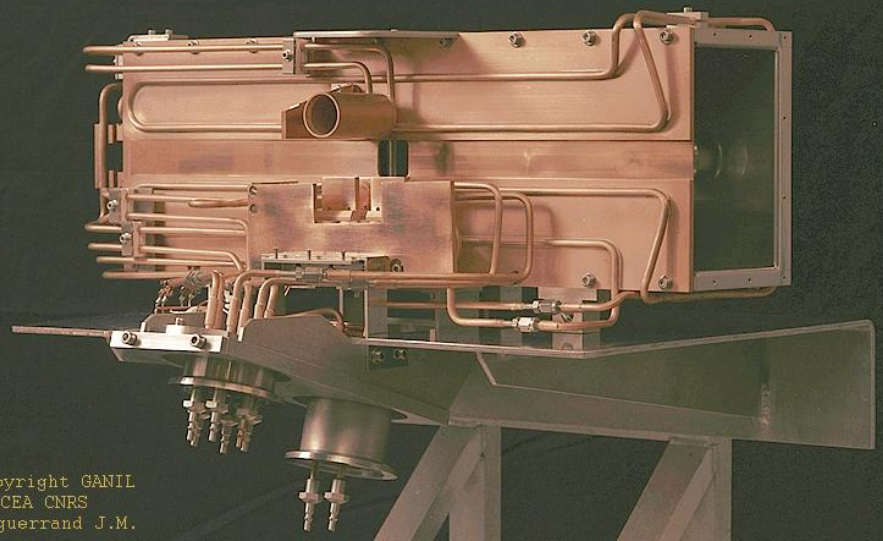
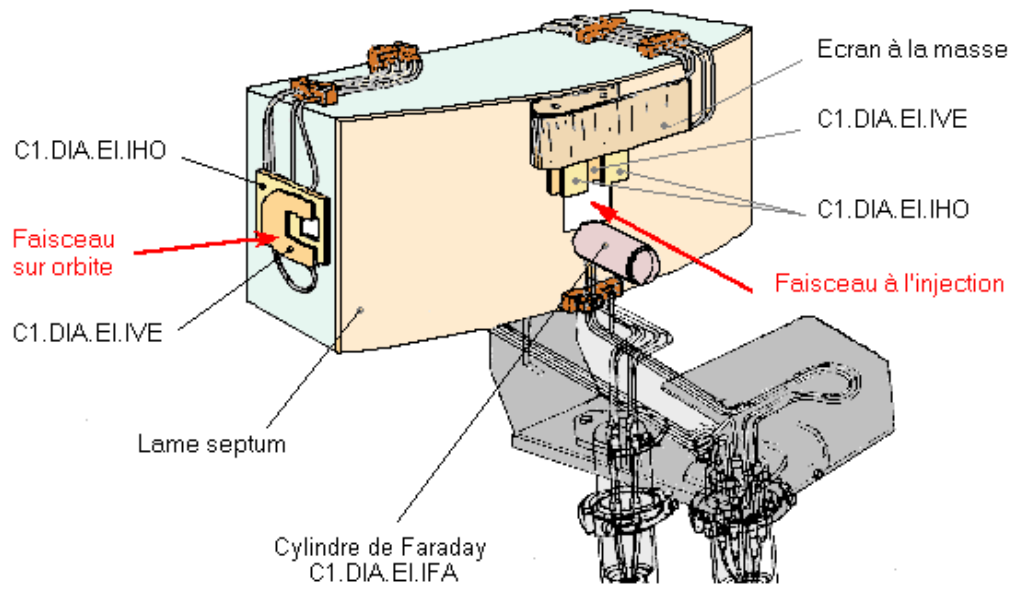

Copyright GANIL
CEA CNRS
Enguerrand J.M.

Extraction

Goal : High extraction efficiency

1. Extraction by acceleration and fringe field

- Energy gain per turn as high as possible
- Accelerate the beam to fringing field

2. Resonant extraction

- If turn separation not enough then magnetic perturbations are used. Particles are forced to oscillate around their equilibrium orbit with a magnetic bump

3. Stripping extraction

Extraction

1. Extraction by acceleration and fringe field

The orbit radial separation is : $\delta r = r \times \frac{\delta W}{W} \times \frac{\gamma}{\gamma + 1} \times \frac{1}{v_r^2}$

$\delta r \nearrow$:

- $\delta W \nearrow$: Energy gain per turn as high as possible
- $v_r \searrow$: Accelerate the beam to fringing field where drop

$$v_r = \sqrt{1 - n}$$

$$n \approx -\frac{\partial B_z}{\partial r}$$



Extraction

1. Resonant extraction

- If turn separation is not enough then magnetic perturbations are used.
- Particles are forced to oscillate around their equilibrium orbit with a magnetic bump.

- The integer resonance $\nu_r = N$

- Precessional extraction : $\nu_r = 1$



Bump with a harmonic coil
 $\langle B_{\text{harm}} \rangle = 0$

- Half-integer resonance : $\nu_r = N/2$

- Third order resonance: $\nu_r = N/3$ (slow extraction for synchrotron)

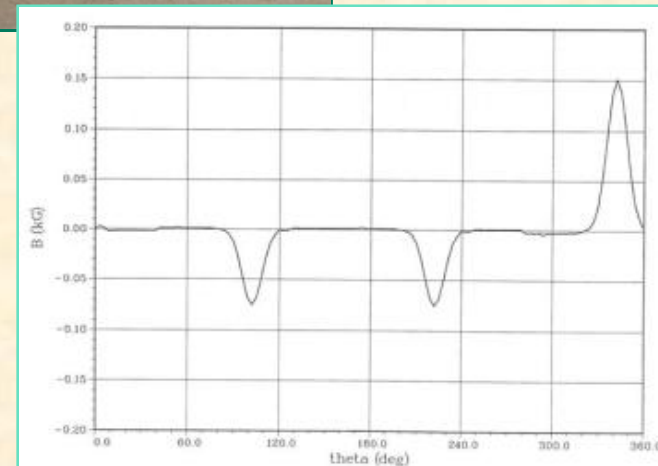

Extraction for Compact cyclotron

- The last turn passes first through two electrostatic septa (< 90 kV) in order to deviate to beam towards the ejection channel.
- Two movable magneto-static dipoles drive the beam across the last cavity.
- Despite the strong fringing field along the extracted beam trajectory, the simulations (confirmed by experiments) showed that the beam dynamics (envelops and alignment) can be done with a 90% efficiency
- small turn separation (overlapping turns) \Rightarrow bunch extracted over several turns

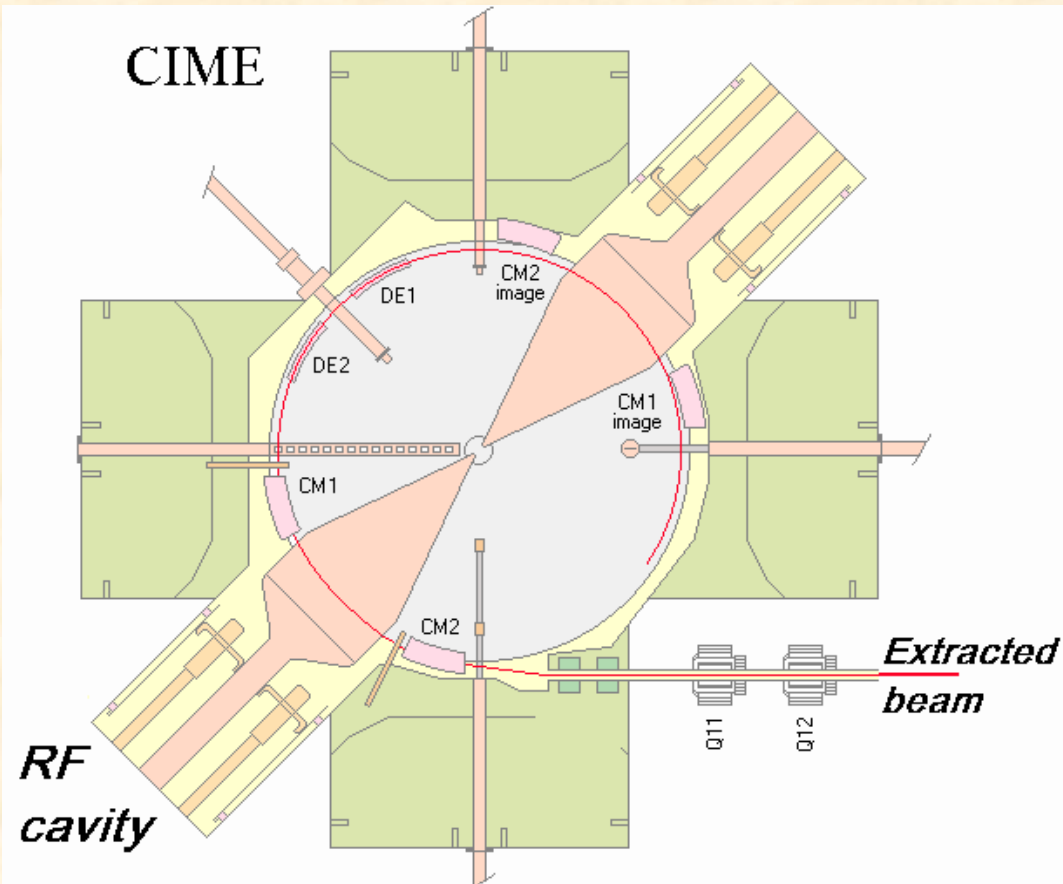

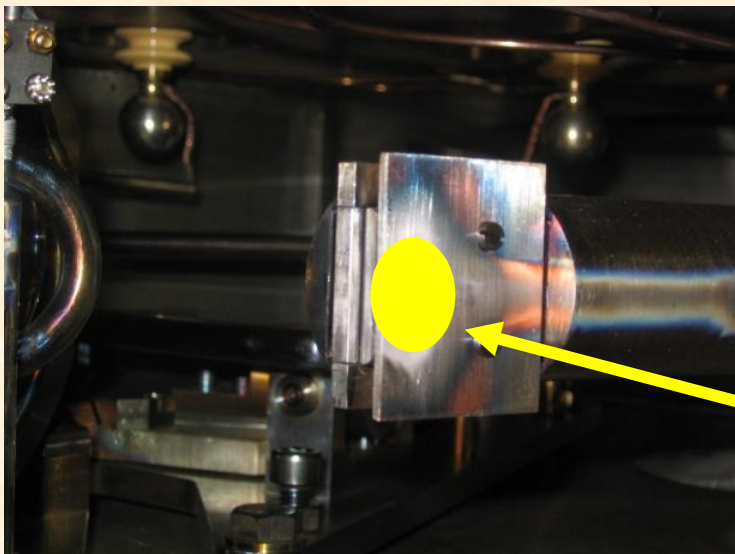

Beam

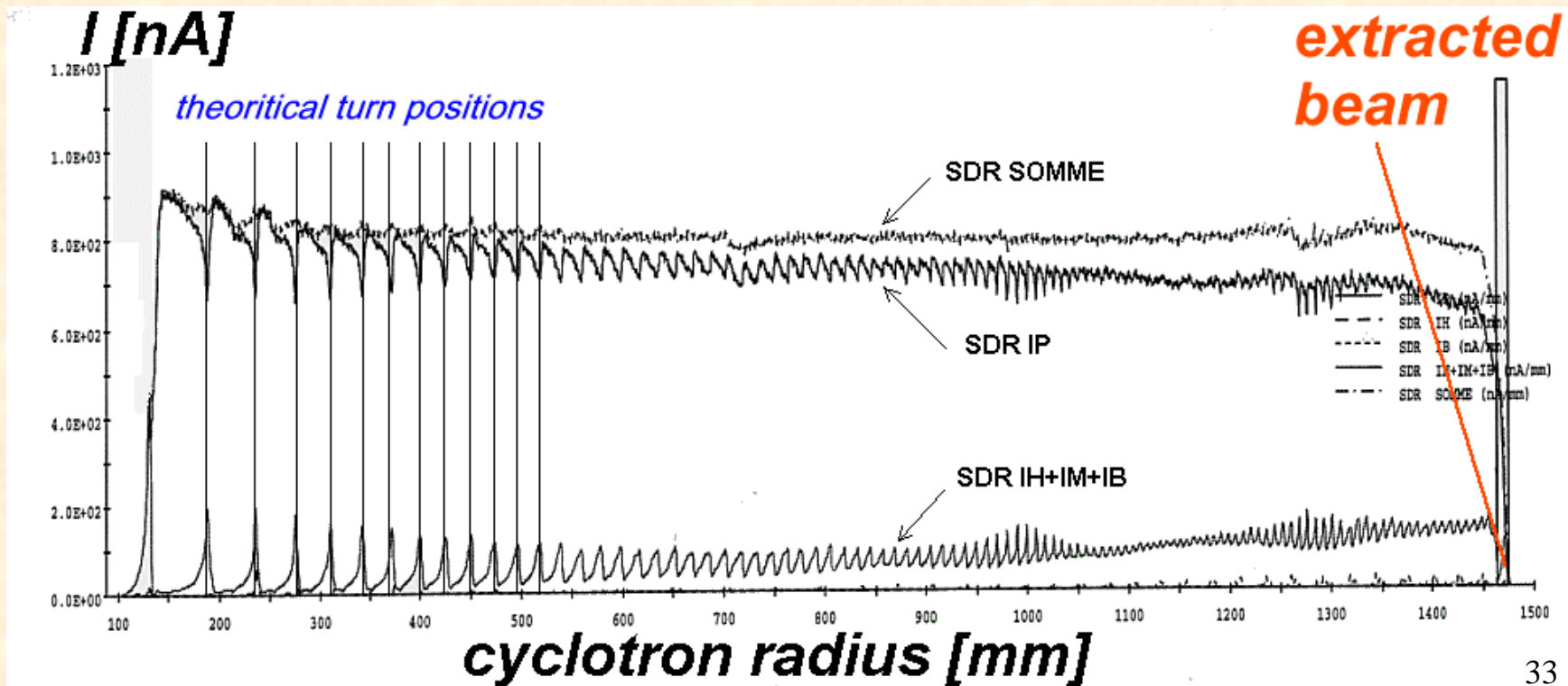
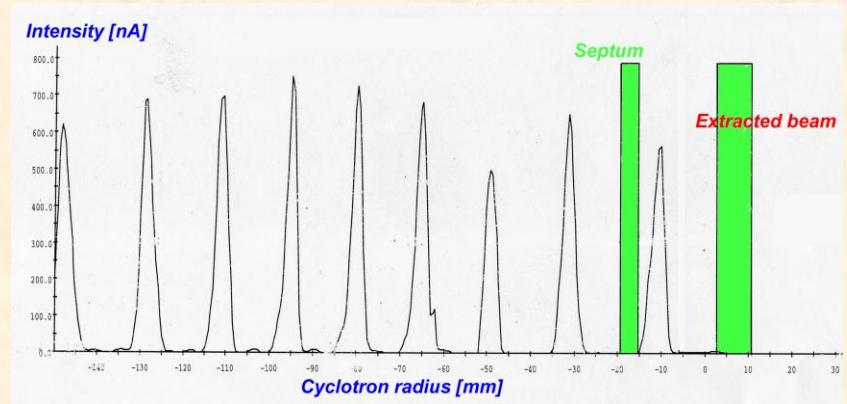

Extraction by stripping

The extraction efficiency for deflector + magnetic channel :
50 – 90%. For high intensities activation, vacuum and melting problems

- Stripping method :
 - H⁻ ions are changed into protons (H⁺ ions) by stripping the electrons off, on thin stripping foil (μm carbon) :
 - Charge state -1 \rightarrow +1
 - Since the protons are positively charged, they then curve the opposite way from the negatively charged circulating beam ions.
 - Thus, the protons curve out of the cyclotron into the beamlines (Triumf (Canada), Louvain (Belgium))
 - Efficiency close to 100 %
 - Short distance in the fringing field : Less focusing problems



Extraction by stripping

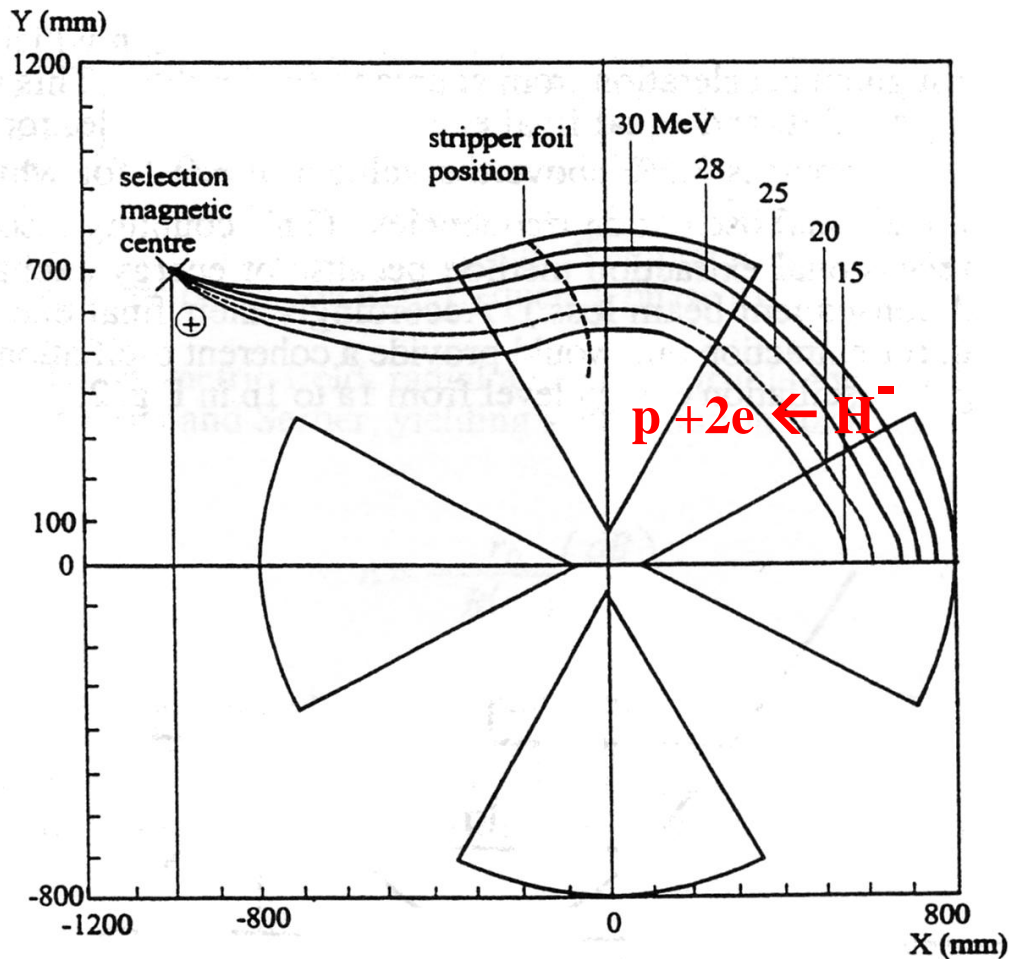

Extraction orbits in the IBA Cyclone 30

IBA Cyclone 30

All energies go to one crossover point by proper foil azimuthal position



Cyclotrons

- End Chapter 2
- Basic Longitudinal dynamics
- Acceleration
- Injection
- Extraction