

Experiences with Feedback Systems and foreseen Improvements for LS1

Ralph J. Steinhagen, BE-BI

for and with input from:

M. Anderson, B. Auchmann, E. Calvo-Giraldo, B. Dehning, R. Denz,
M. Gasior, S. Jackson, L. Jensen, J.-M. Jouanigot, Q. King,
T. LeFevre, S. Page, L. Ponce, A. Verweij, J. Wenninger

... no “direct” link but can create dangerous, combined failure scenarios:

I. local orbit bumps +

a) fast kick → single turn failure → ...

b) any other loss mechanism → collimator hierarchy violation
→ reduced cleaning performance/losses → ...

II. Q/Q' being off-reference → driving beam instabilities, life-time issues,
decreasing time constants of other failures

... amplifies the effect of another second failure.

... impact on machine availability for physics.

- LHC feedback systems most visible faces are:
 - **Feedback Controller (OFC)**: actual parameter/feedback controller logic
 - Simple streaming task for all feed-forwards/feedbacks:
 (Monitor \rightarrow Network)_{FB} \rightarrow Data-processing \rightarrow Network \rightarrow PC-Gateways
 - **Service Unit (OFSU)**: Interface to users/software control system/SIS
- However more than 3500+ devices (~130 FE) and many technical services like FESA, CMW, timing, technical network etc. are involved in the loop
 - **Overall strength depends on the reliability of the weakest link**

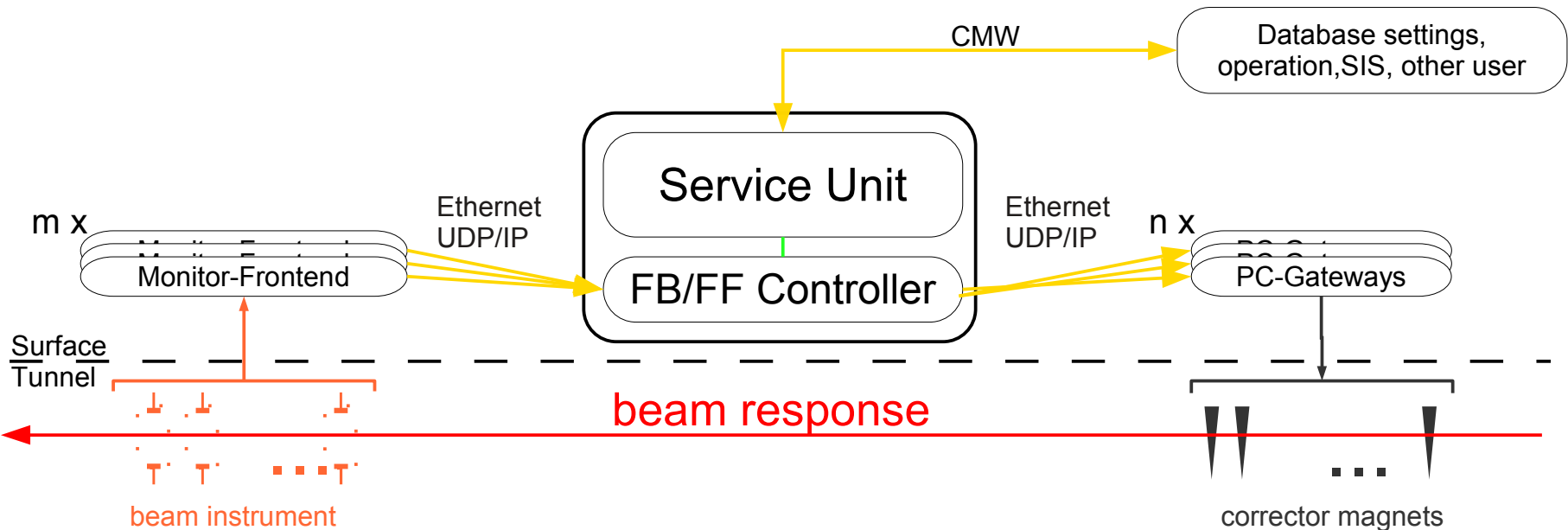

... are typically slow and detected/mitigated either by:

A) Feedback controller itself – time scale of typ. 40-80 ms

- sanity checks: 80% of the functionality dealing with error handling vs. 20% for the main “business” logic of doing the actual orbit/tune correction
 - de-selecting/muting of noisy, erroneous or failing BPM elements
 - Q/Q' data integrity and stability assessment → stops FB loop to prevent QPS trips ... but routinely overridden by operators (compromise between safety ↔ machine availability)
 - Stopping FB is not without issues since Orbit-FB is required during squeeze with the present collimator settings.

B) Software Interlock System (SIS) – time scale of few seconds

- Interlock on global orbit (via OFC/OFSU), RF frequency, CODs
- Monitoring of OFC/OFSU status to catch latched references
- Watchdog (10s): loss of communication → dump
(FB availability becomes effectively an interlock)
- Q/Q' values are not interlocked (basically only via losses on BLMs)

■ Not exploited enough: using forewarning

- UDP latency issues (missing packets, bursts, etc.)
- CMW, technical network latencies, timing infrastructure

- Laurette@Evian'11: “[in 2012] ... => Should be left with 2-3 dumps! but what will we find if beams are not dumped?”
- Consider only PM with $E > 450$ GeV, $I_{B1/2} > 10^{10}$ protons/beam, and ...
 - only dumps, no near-misses, events causing losses without dump, or events that have been recovered by OP or the sequencer
 - PM comment containing “FB”, “Feedback”, “OFC”, “OFSU”, “BBQ”, “BPM”, “RT”, “Orbit”, “Tune”, “Instability”
 - OFC/OFSU crash reports
 - ... plus some cleaning up of “no orbit change”, unrelated and “OK” statements

	Total PMs:	FB & Co:	Percentage:
2010	453	8	1.7%
2011	684	30	4.4%
2012/13	851	28	3.3%

- Disclaimer: numbers to be taken indicative and not as absolute



Feedback & Co. Failure Statistics

An Attempt to Classify into Sub-Groups & Trends

- Some failures are an interplay between multiple sub-systems (double counting!)
(*counted only if affecting feedback and/or during RAMP & SQUEEZE)

	FB	OFC	OFSU*	BBQ	BPM*	QPS/ COD	Orbit	Q/Q'
2010	8	2	0	2	0	3	9	0
2011	30	2	5	18	3	14	13	6
2012/13	28	4	10	1	7	1	17**	30**

- BBQ/Tune-FB/QPS interplay may become important again after LS1 if we cannot raise the QPS thresholds ... need to preserve this improvement.
 - Some system failures related to problems with infrastructure where equipment owner has limited control over (i.e. FESA, CMW, timing, TN network) – However, it at least indicates the trends and area to be looked further into.
 - Marked “**” cases not necessarily attributed to FB failures but illustrate the increased criticality of the control of orbit and Q/Q' during 2012:
 - Smaller β^* → tighter collimator tolerances ↔ tighter orbit tolerances
 - Larger bunch intensity/tighter collimators(?) → increased single bunch instabilities
- Should address this if we want to push the envelope (i.e. through new/better BI diagnostics)

- Measurement quality (BPMs, BBQ) → transients on orbit, tune → collimator induced losses/QPS trips of RQT[D/F] → dump
- Front-end/SW infrastructure problems: FESA, CMW, Timing & network
 - Threading issues, non-RT behaviour, crashes, external load factor i.e. slow clients, technet switch overloads
 - non-RT behaviour of input data stream → no data → pausing feedback → exceeding loop latencies, either
 - a) no correction → orbit drift → dump
 - b) classical FB instability (too high BW) → additional orbit drift → dump
 - Invalid data – most believed to be/being fixed (i.e. timing, memory corruption)
- Insufficient loop stability margin
 - mismatch between actual optics and the one used by the OFC
 - Optics re-computation errors – being fixed in OFSU
 - FB running at the design stability limit

- Installed RF commutation switches directly after BPMSW.1[L/R]5.B[1/2] to assess electrical offset drifts (RF cables, WBTN front-end, integrator, etc.):

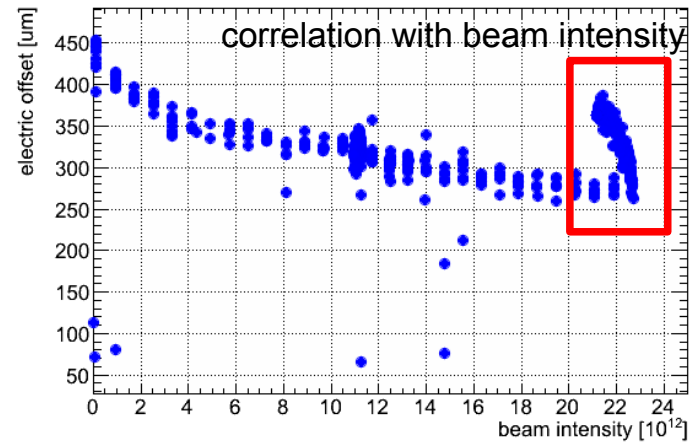
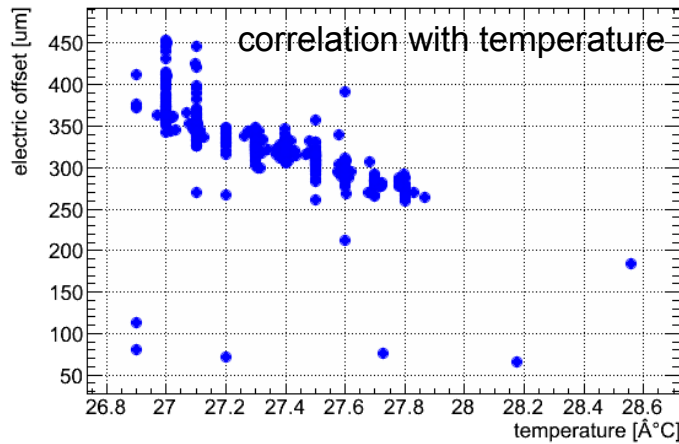
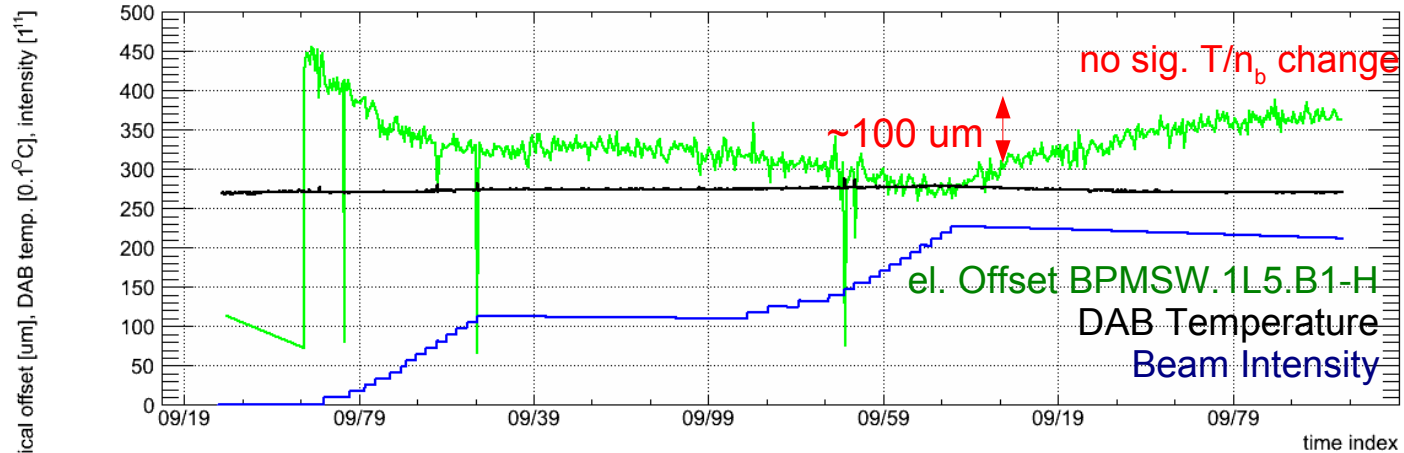

- Measurement drifts $\sim 100 \text{ um/h}$ w/o significant temperature changes
 \rightarrow Orbit-FB converts these meas. errors into real orbit shift

- ... “A system is said to be real-time if the total correctness of an operation depends not only upon its logical correctness, but also upon the time in which it is performed. [...] are classified by the consequence of missing a deadline:
 - Hard – Missing a deadline is a total system failure.
 - Firm – Infrequent deadline misses are tolerable, but may degrade the system's quality of service. The usefulness of a result is zero after its deadline.
 - Soft – The usefulness of a result degrades after its deadline, thereby degrading the system's quality of service.”
- LHC feedback is a 'firm real-time systems' as there is some (limited) margin on occasional missing data and additional latencies but the loop may become unstable if these become systematic
 - E.g. missing packet reduces phase margin by $\sim 15^\circ @ 1\text{Hz}$ ($0^\circ < \text{stable} < 90^\circ < \text{unstable} < 180^\circ$ – max. instability)

- ... perceived in the CCC as 'BPM disco' effect (since 2010)
- Low-level: bursts, non-synchronised or missing data at the OFC

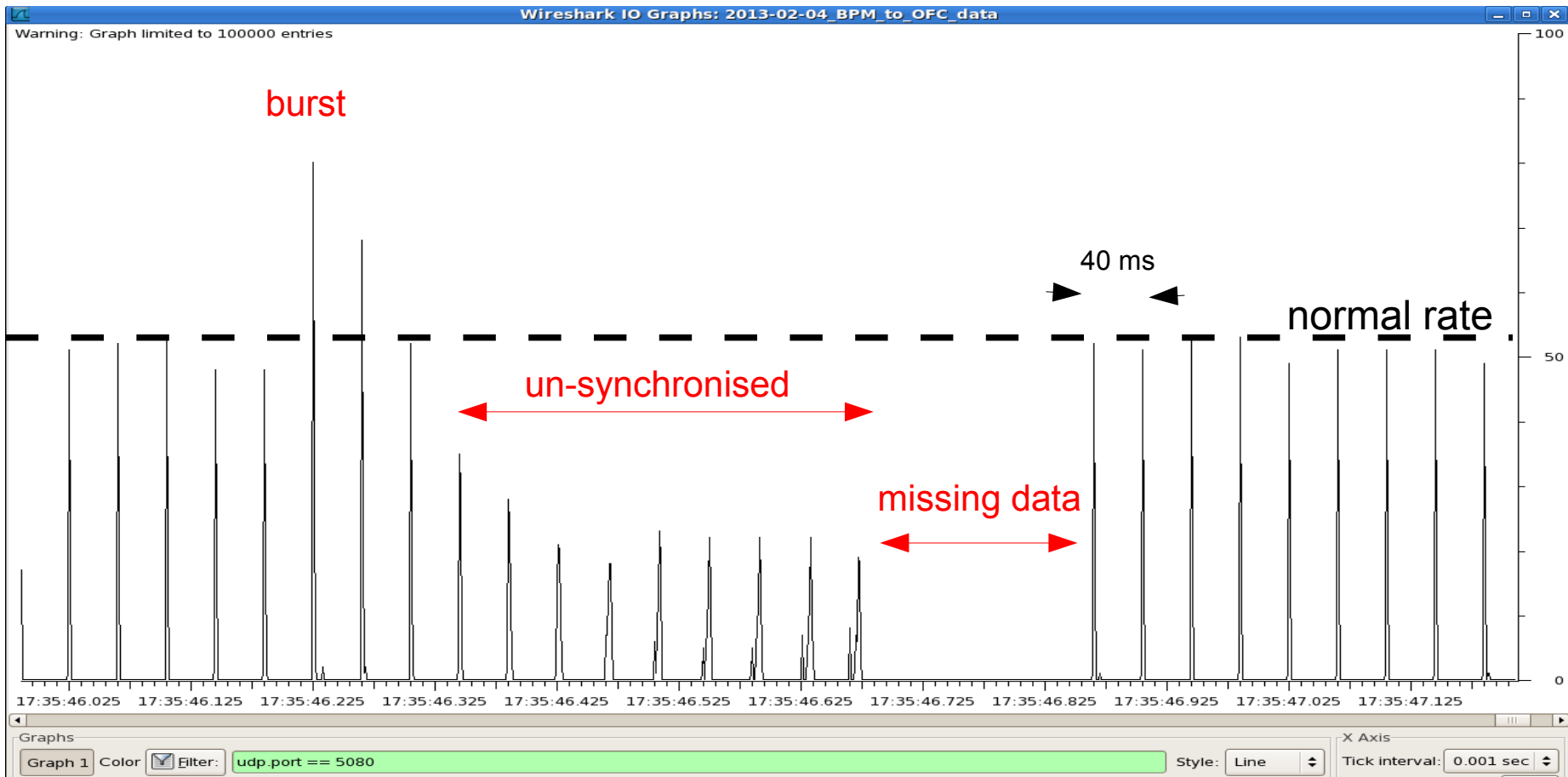

- Compromises OFC data concentration → latencies → FB loop instability (missing packet $\approx 15^\circ$ loss of phase margin @1 Hz) → losses on collimators → dump

Overload of LHC's Technical Network Infrastructure

- Increased demand of data, new instrument and prototype systems increased the overall technical network load,
 - i.e. LSS4 real-time data competing with other clients causing loss of BBQ data and affecting Q' measurement (sign errors)

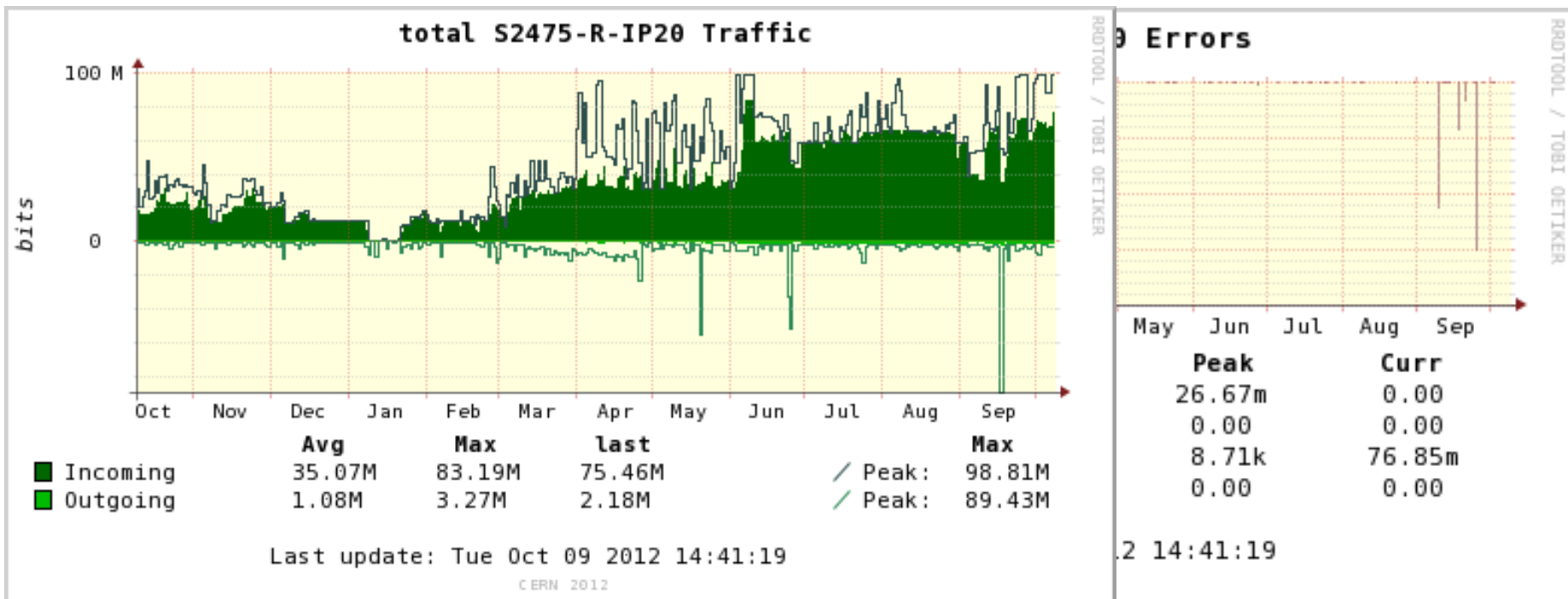

- Given switch has been upgraded during the last Christmas TS
 - may possibly discover other (new) bottlenecks after LS-1 due to new systems being installed/commissioned

- Open- and thus closed-loop bandwidth depends on the excitation amplitude:
 - + non-linear phase once rate-limiter is in action...

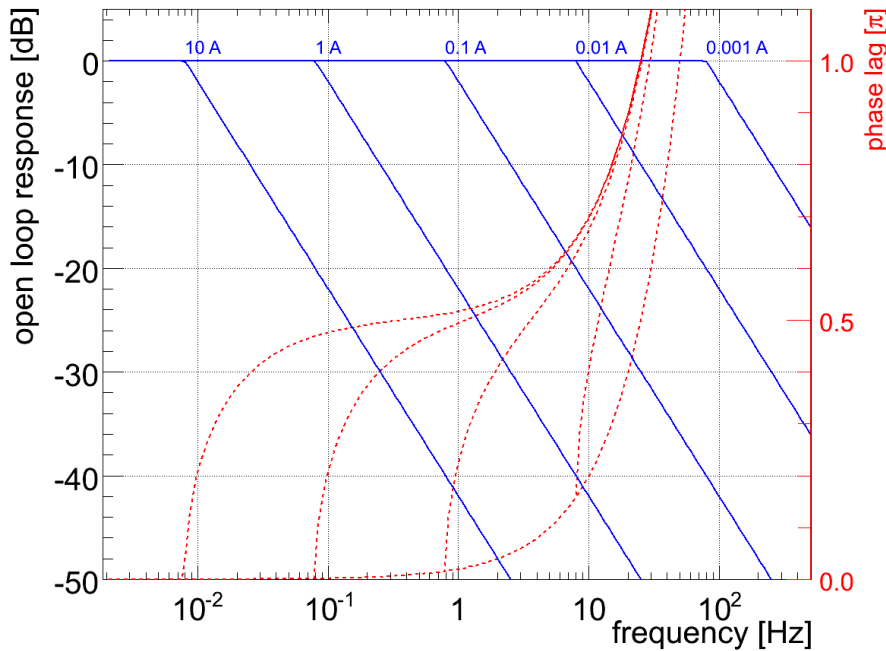

$\Delta I = 0.1 \text{ A} \leftrightarrow \Delta x \approx 32 \text{ } \mu\text{m} @ \beta = 180 \text{ m}$

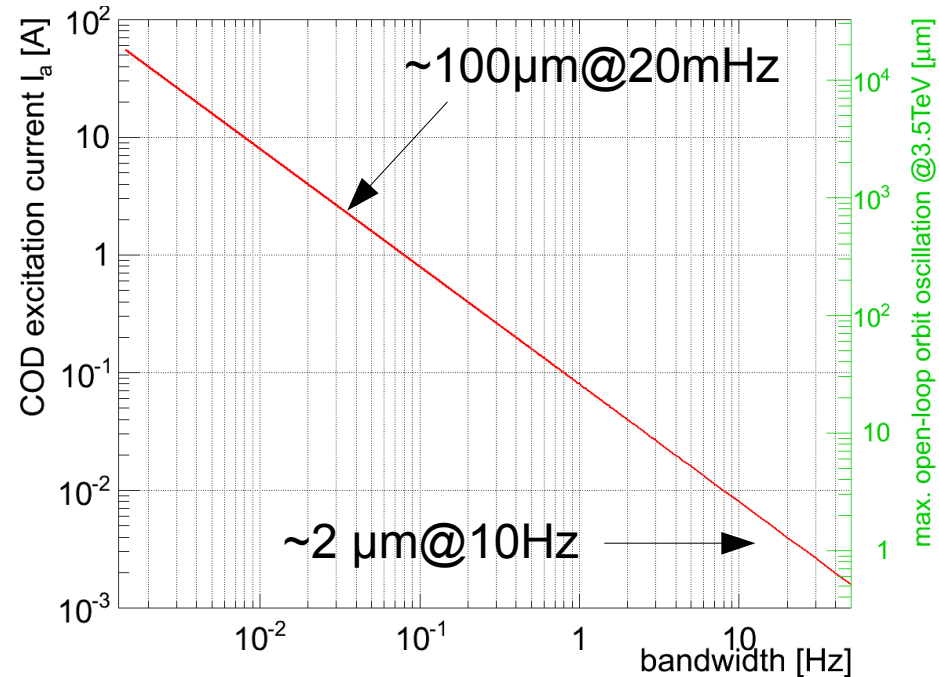

- Consider $\sim 35 \mu\text{m} @ 1 \text{ Hz}$ as effective bandwidth @4TeV (assuming 3C bump)

- Losses and orbit movement at H-TCP.C6R7.B2 well correlated

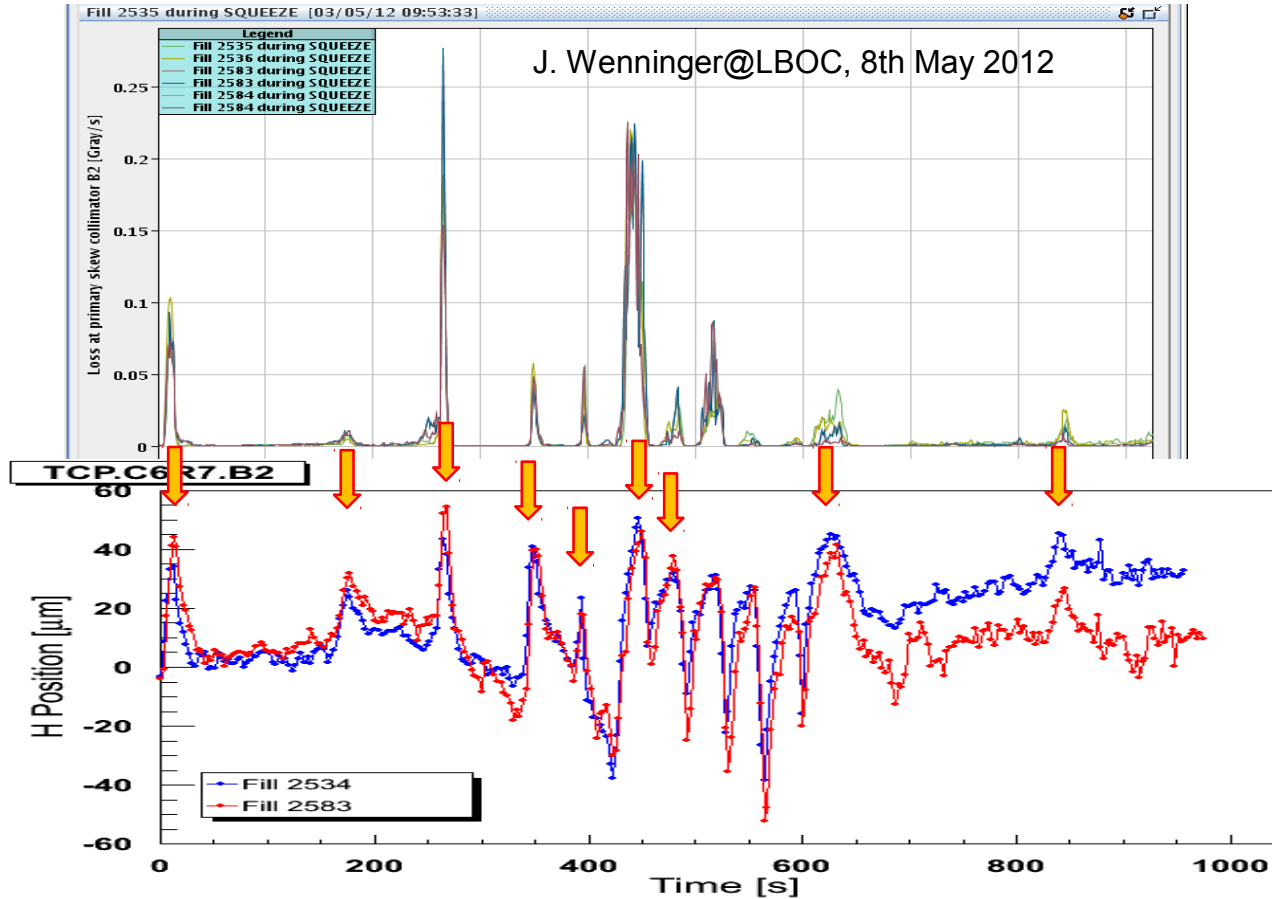

- Maximum drift rates of 40 $\mu\text{m/s}$ \rightarrow (close to) limit of Orbit-FB at 4 TeV
- At this speed, OFC needs to operate with correct optics (see appendix for details)



Planned Improvements for after LS-1 I/III

Measurement Data Integrity – BI-QP

- Temperature stabilised BPM racks (should minimise but not remove systematic drifts)
- BPM signal RF commutation switches on BPMSW's (already deployed in IP5)
→ identify and compensate measurement errors w.r.t. real orbit drifts
- Redundant IR-BPM read-out electronics (Diode-Orbit acquisition), tbd:
 - naming convention of additional channels
 - integration w.r.t. WBTN-based BPMs
 - initial deployments only at BPMSW.1[L/R][1,5,8,2].B[1/2] (vs. full Q1-Q7)
- BPMs in TCTP collimator – non-trivial integration to be discussed/agreed upon
 - Orbit computation needs settings of gap centre, opening and angle
 - new orbit reference management (collimators are moving targets vs. collimator move according to the target? ColUS?)
- ADT as Q/Q' source (RF-FB, SW integration effort)
- Split BBQ use-cases into independent chains, i.e. optimised parameters for Q', Tune-FB, coupling, beam-beam/stability studies – implementation tbd.



Required Improvements for after LS-1 II/III

Improvements of Loop Stability – BI, CO & OP

- Establish true 'firm real-time' constraints on input data
 - review BPM/BBQ UDP transmission robustness and implementation (in particular the interplay with CMW, FESA, proxies etc.)
 - decouple RT traffic from those needed for operation and others (TN QoS, IT-CS)
- Operate with actual and not approximate optics (particular during squeeze)
- Gain scheduling based on beam mode/operational scenario (basic infrastructure there but not all used during regular operation)
- validate BPM response at least once per fill – foreseen but not executed systematically (takes < 1 min and detects dead BPMs)
- N-fill based feed-forward – in preparation (J. Wenninger et al.)
- Should re-visit option of having a dedicated full feedback test-bed
 - now possible with improved CPU/network performance (w.r.t. 2005-2008)
 - Important for training & development during a (long) period without beam

- Attribute errors to the specific sub-systems
 - Finer granularity of post-mortem reports (i.e. system expert feedback and sub-categories)
 - better monitoring of technical infrastructure (FESA, CMW, timing, network)
 - bits and pieces are there but expert-only features

- Better pre-warning, better GUI integration, particularly concerning overview (needs input from OP concerning level of detail)

- Miscellaneous (pending since 2011):
 - OFSU: user accessible 25 Hz data & PM buffer of all feedback states/data
 - Improve transparent full recovery after an OFC/OFSU crash
 - Orbit, Q/Q' and optics reference control, hot spare/additional systems
 - remove OFC functionality that shouldn't be there in the first place (i.e. ORM recalculation)

- N.B. Some of the modifications are subject and for confirmation during the upcoming 'FB Architecture Review' in May

- ... no “direct” link to MPS but can create dangerous, combined failure modes
 - OFC/OFSU prominent faces but many more devices & services involved
- Main issues of 2012 dumps with beam related to:
 - Beam measurement quality
 - Front-end/SW infrastructure problems: FESA, CMW, Timing & network
 - Insufficient loop stability margin (tighter constraints than in 2010/11)
- A lot of progress and issues have been already addressed during 2012/13
- A set of important improvements are under way during LS1, notably
 - Temperature controlled racks & new Diode-Orbit ACQ for the IR BPMs
 - Improvements in the service infrastructure (CMW, TechNet, etc.)
- Need better diagnostics, warning and status indication of overall infrastructure, and better tracking and finer granularity of error assessment
 - i.e. “EICs assign a preliminary error to the PM → refined by system expert w.r.t. given sub-system”



Miscellaneous Items

- Bandwidth modifier w.r.t. eigenvalue index (<1 more stable, >1 diminishes stability margin)

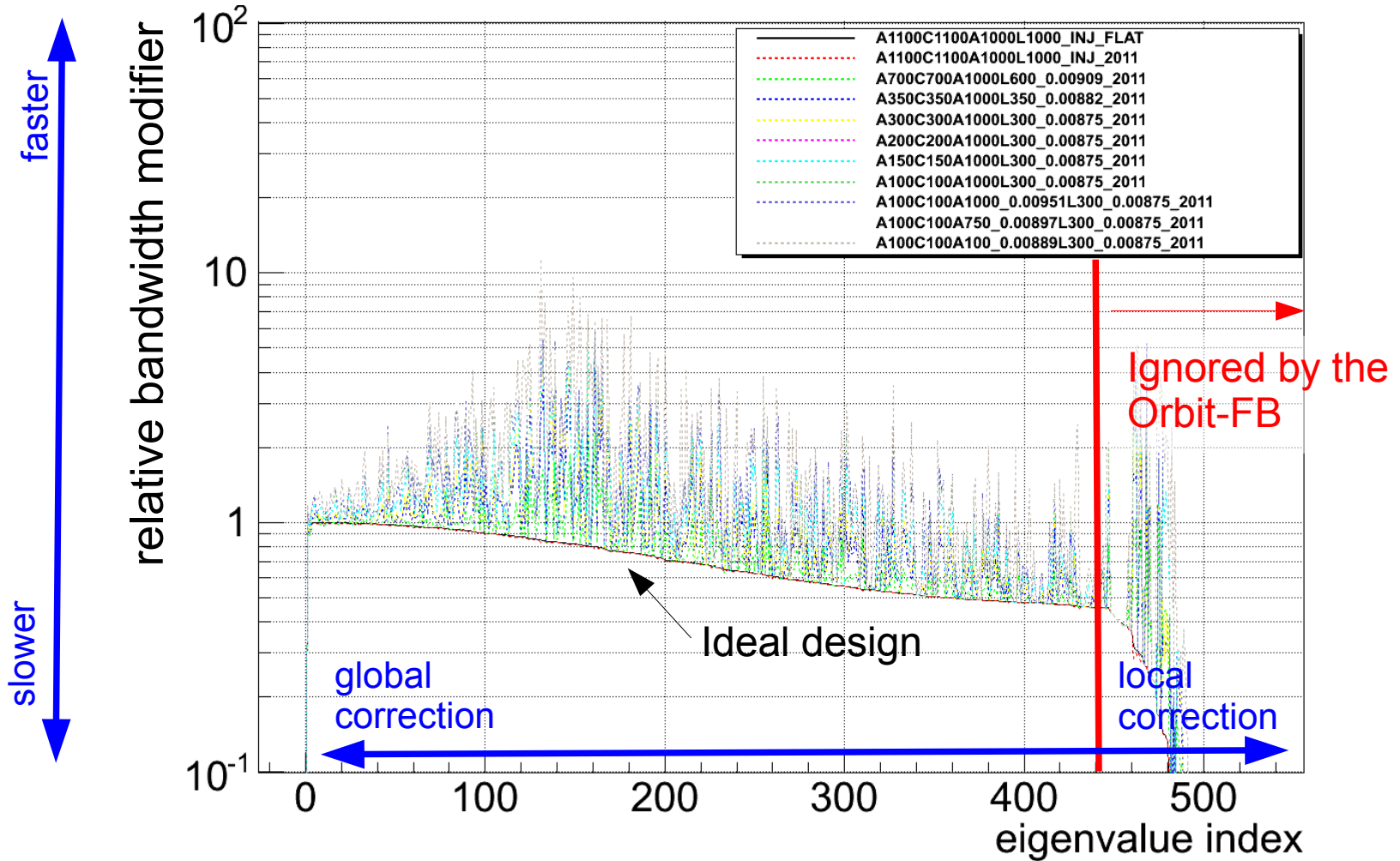

- Typ. operational bandwidth <10% of maximum possible (sometimes too slow)