

# rayos cósmicos

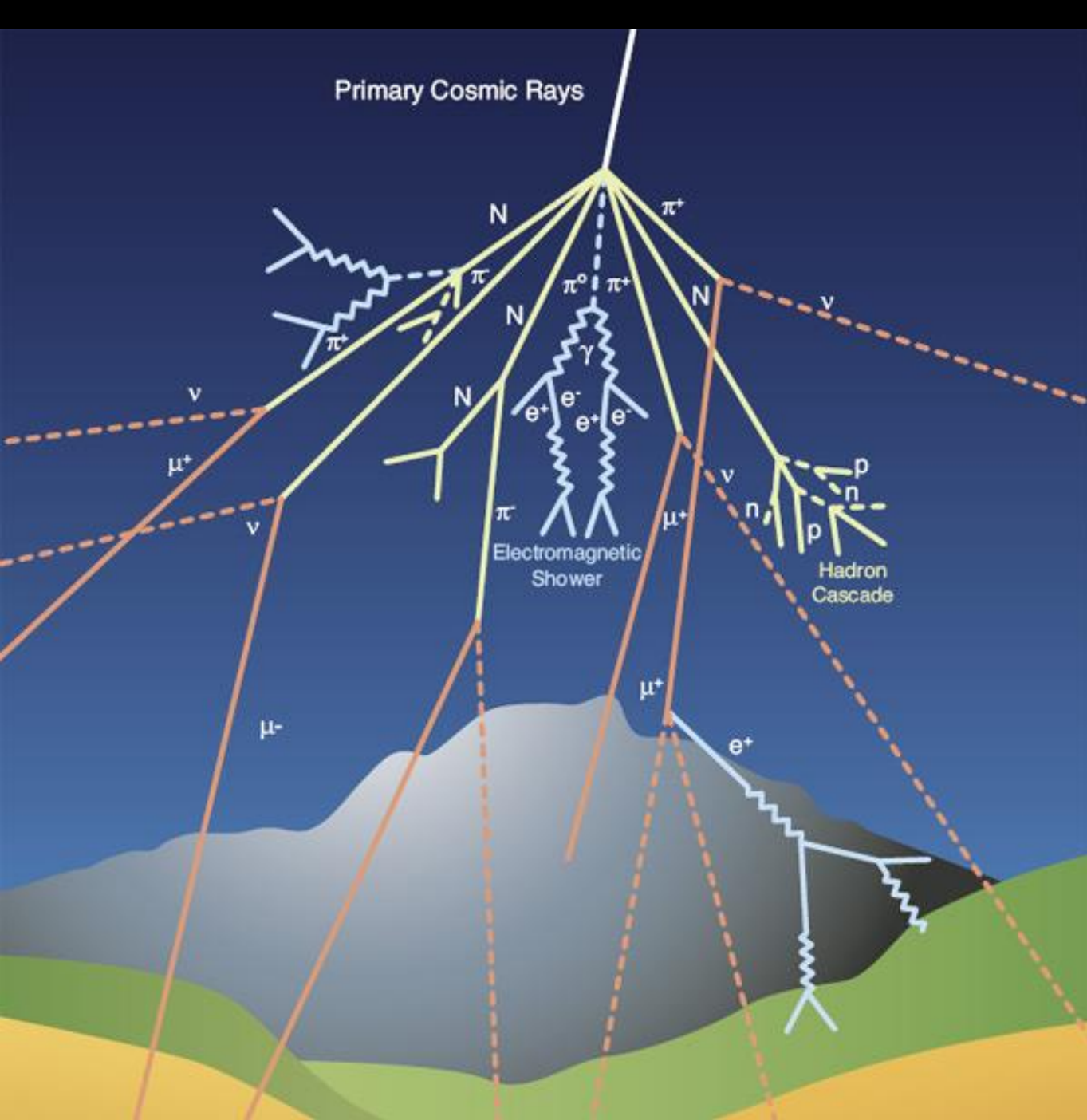

Cristina Fernández  
Pablo García

*CIEMAT, 1 Marzo 2016*



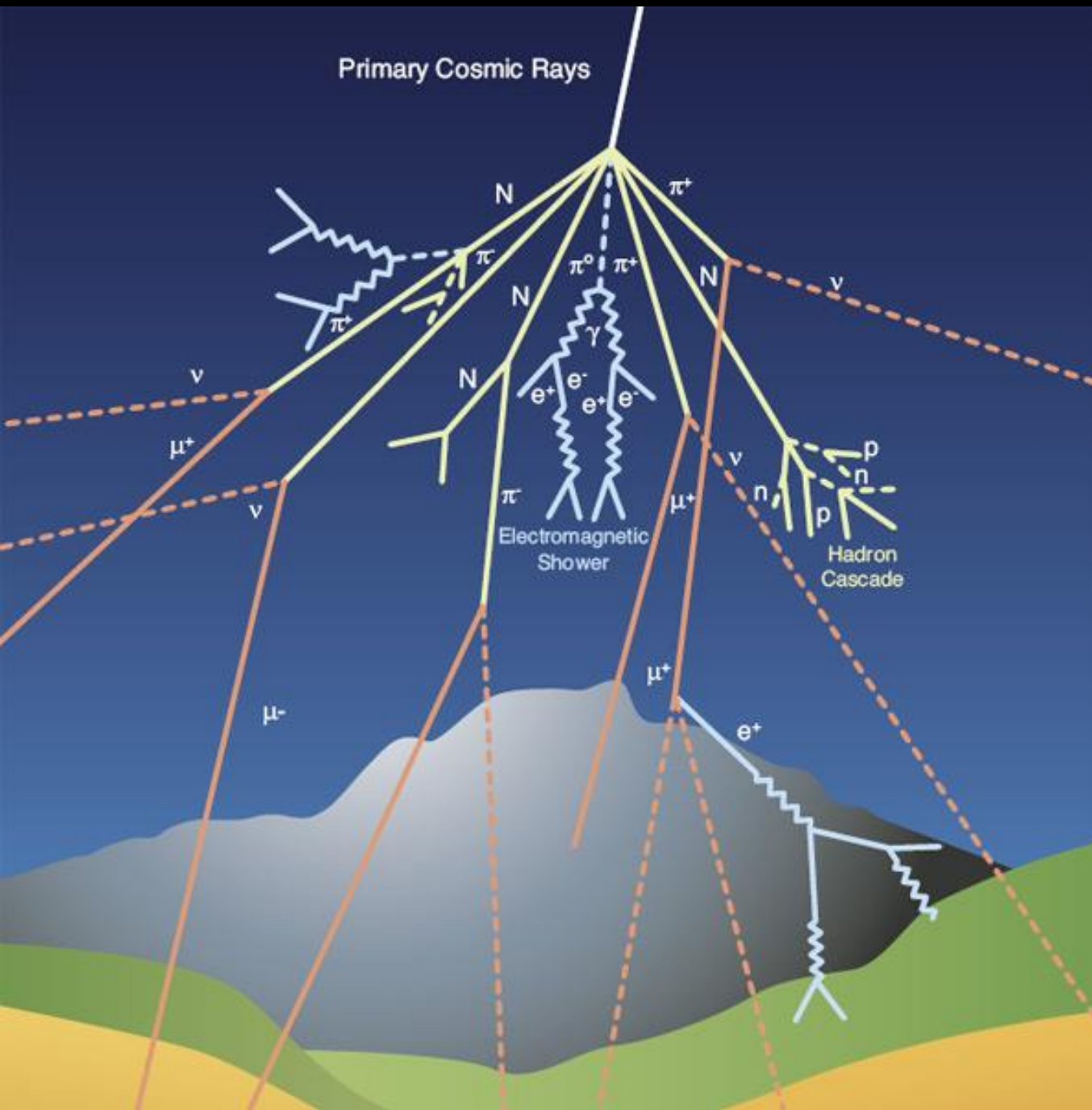

$$v = 0.98 c$$

$$vt = 600 \text{ m}$$

$$d = 10 \text{ km}$$

¿?

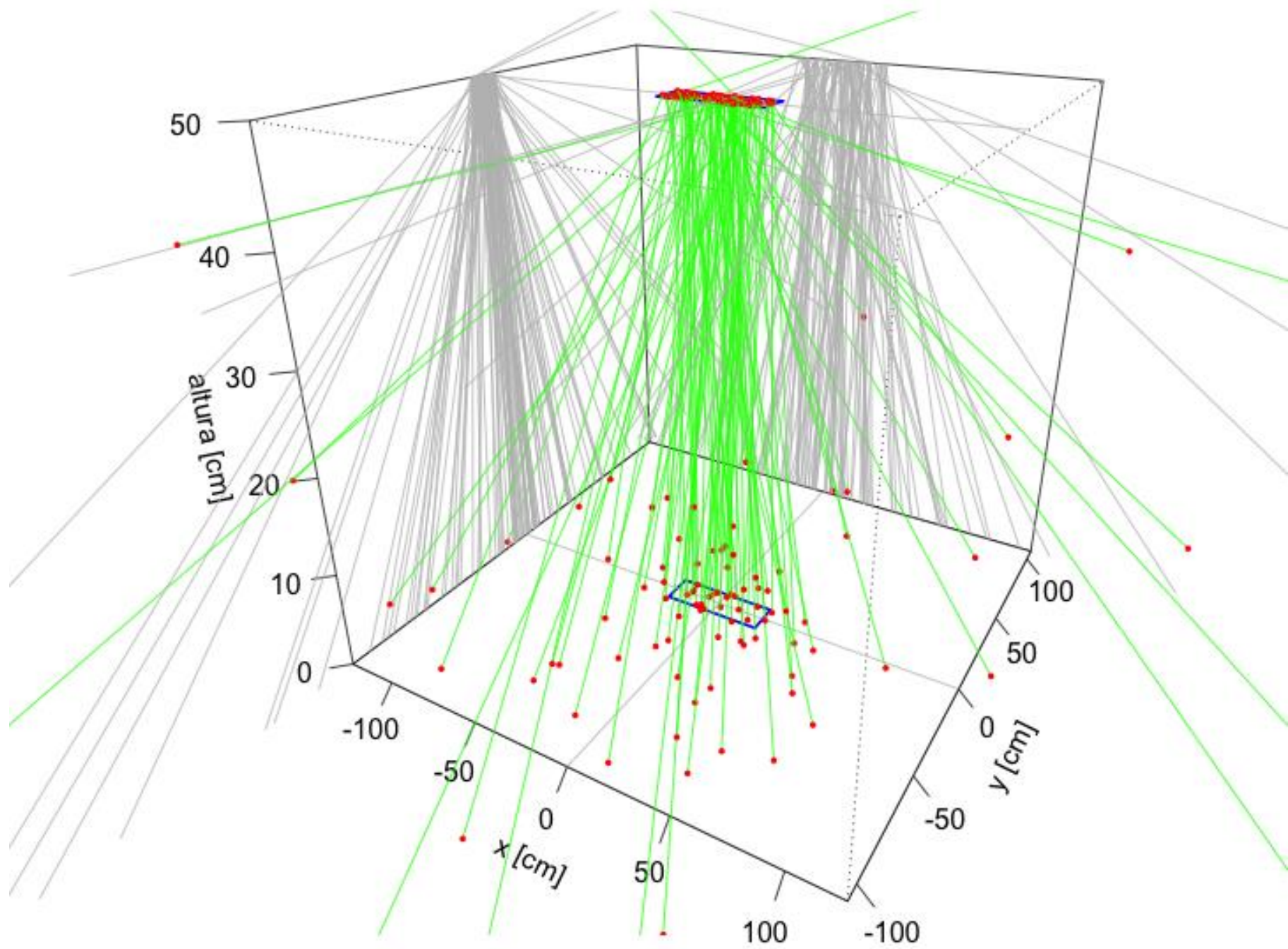

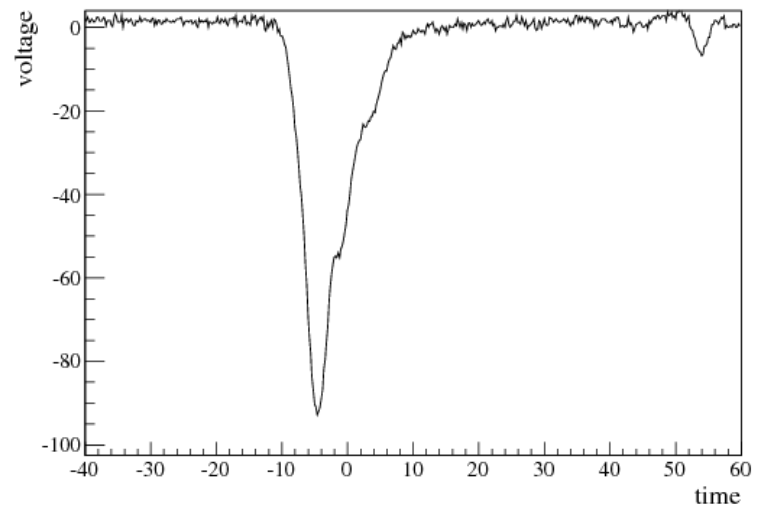
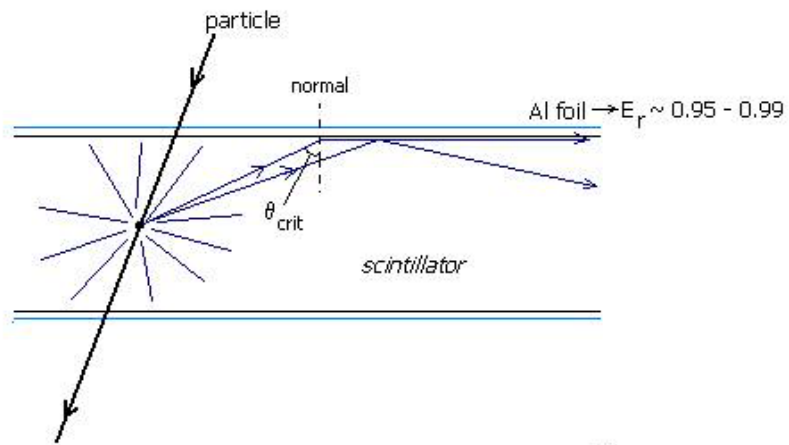

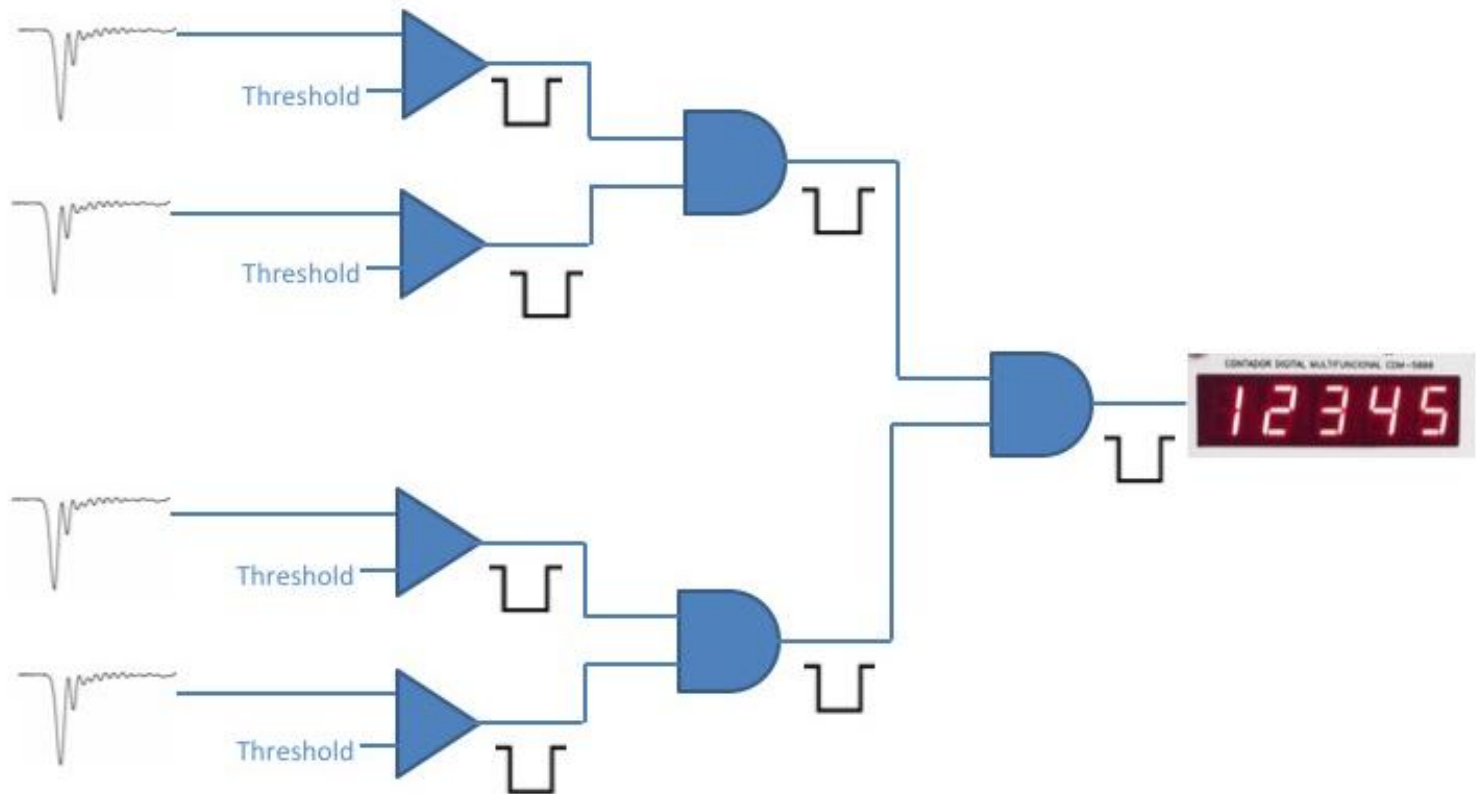
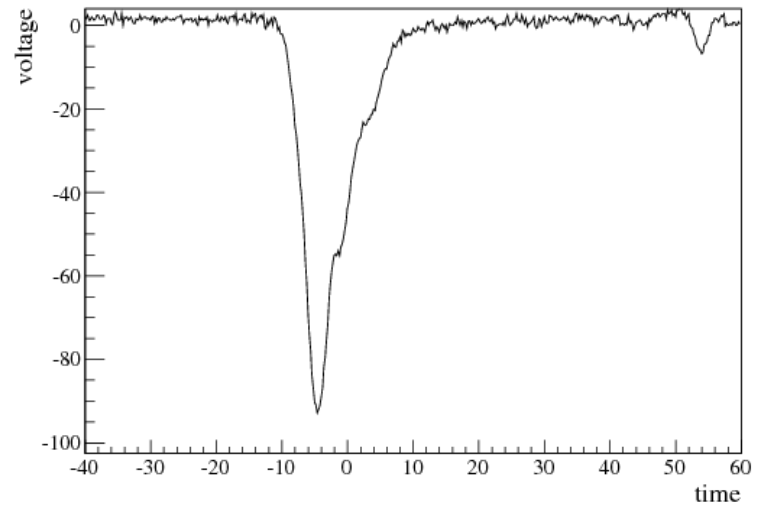
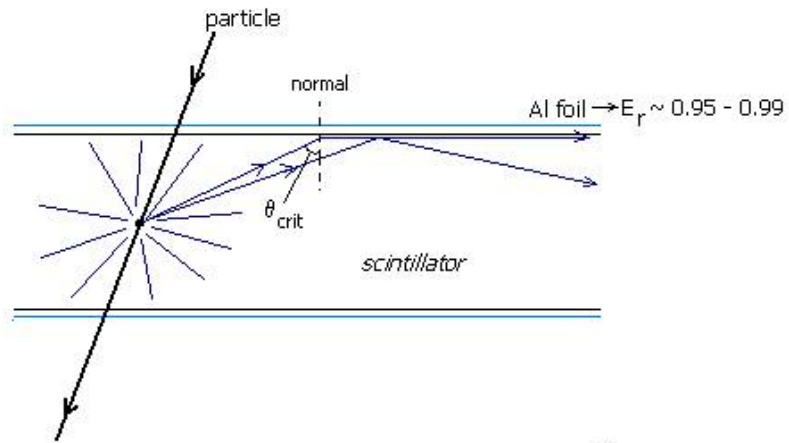

flujo en Madrid  $\approx$   
110 muones /  $m^2$  s sr

