



## What could be delivered -- BI

Planned & Possible Upgrades related to:  
LHC Inter- and Intra-Bunch (Head-Tail) Diagnostics

Ralph J. Steinhausen,  
Beam Instrumentation Group, CERN;

- 2012 LHC operation indicated potential luminosity-performance limitations:
  - Max. bunch charge  $n_b > 1.7 \cdot 10^{11}$  ppb (50 ns operation)
    - intra-bunch instabilities during RAMP & ADJUST (IP8 bunches)
  - Max. beam intensity (25 ns operation) → e-cloud & bunch-by-bunch instabilities
  - Min. crossing angle (limits min  $\beta^*$ ) → long-range beam-beam for  $< \sim 9\sigma$  separation
- After LS1, LHC will operate at increased beam intensities and energy for which these effects could become more important
  - may need better diagnostics to understand, improve and mitigate these effects if we want to maintain/improve the present luminosity performance
- Implies some trade-off between:
  - what has been requested/is needed for beam operation, and
  - what is possible with existing technologies and the available resources.
- Main aim: provide a high-frequency intra-bunch beam diagnostic beyond and complementary to the existing bunch-by-bunch capabilities of the ADT.

## Tackle three domains independently:

A) Pick-up – improve bandwidth, linearity, power-issues, EMC susceptibility:

1. Synchrotron-Light based BPM → dual use CTF3 & LHC
  - Collaboration with ACAS (Uni-Melbourne and ASLS)
2. Direct EO-based BPM → machine/beam type independent
  - Plan to design/integrate prototype monitor to be installed in SPS during LS-1
3. Wider-band, electro-magnetic pick-up → ???

B) Analog front-end:

1. Time-Domain: new wide-band ~DC-6/8 GHz  $\Sigma$ - $\Delta$  hybrid
2. Frequency-Domain: new Multiband-Instability-Monitor (MIM)
  - Used also as a pre-/post-trigger for the time-domain acquisition
  - Collaboration with ACAS (Uni-Melbourne and ASLS)

C) Digital-Data-Acquisition – large PM-type history buffer, online pre-processing

1. GUZIK DAQ: 64GB, 20 GS/s, 4.5 – 13 GHz BW, ext. FPGA firmware
2. Bunch-by-bunch DAQ (needed for B.2) ↔ related to b-b-b BBQ activities

# Limits of Classical Head-Tail Monitoring Approach I/II

## SPS/LHC HT System Response

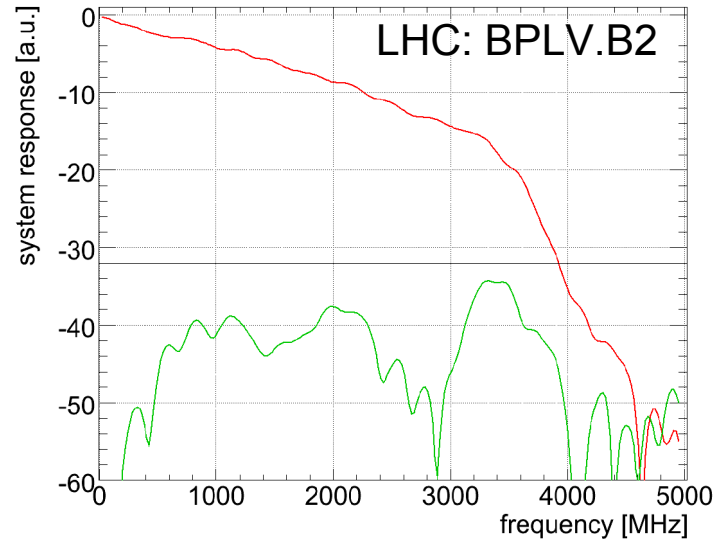
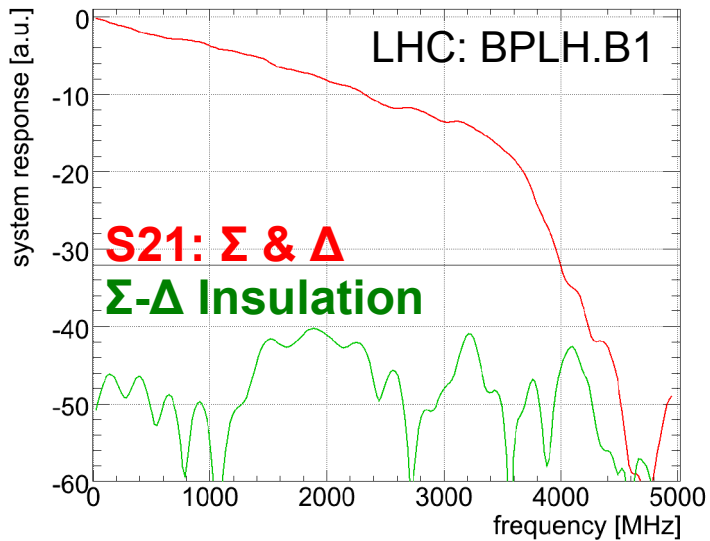
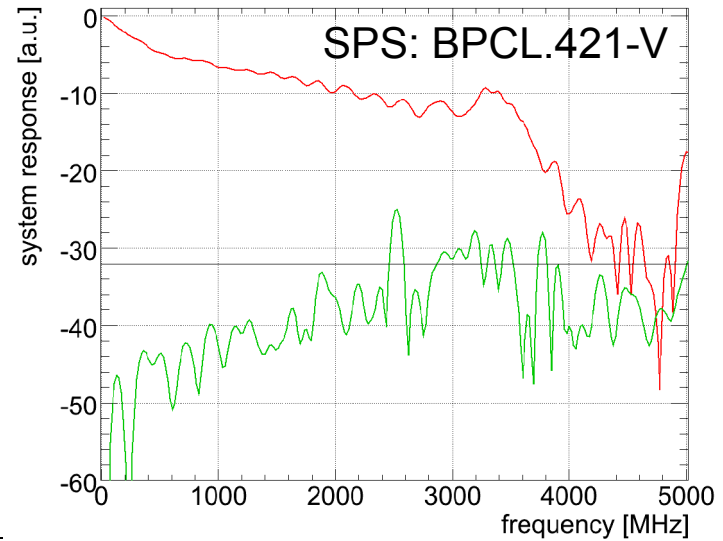
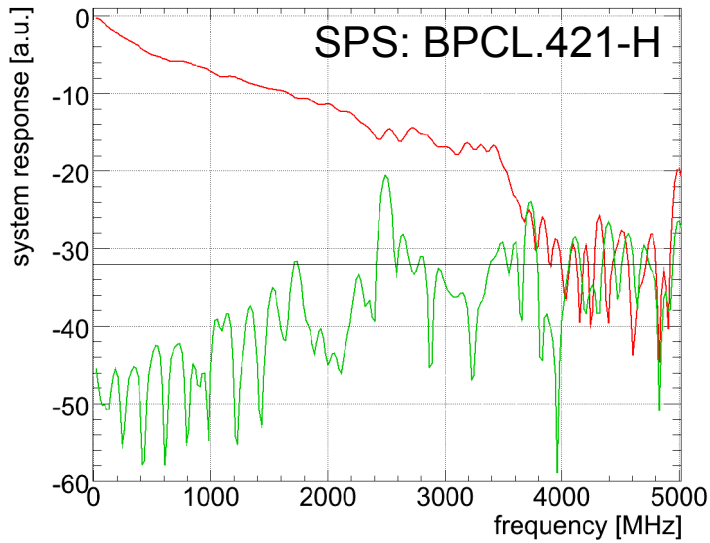

- 3.5 GHz due to scope bandwidth (pick-up itself ~6 GHz)
- common-mode bleed-through/SFDR: ~1% @ 1GHz → limits scope resolution

# Analog Frontend and Pickup Improvements I/II

## Synchrotron Light- & Electro-Optical Beam Position Pickup

- SynchLightBPM – collaboration with ACAS (Australian Universities & Labs)
  - pro: very wide-band signal (tested up to 12 GHz), large dynamic range, DC response
  - con: not enough free view-ports available → envisage this for LS2?
- Electro-Optical Pick-Up
  - working principle similar to LCD/TFT screen: particle beam modulates crystal birefringence → intensity of two laser beams A & B, position  $\sim (A-B)/(A+B)$
  - pro: very wide-band signal, no beam power issues, true DC response (alt. AGM?)
  - SPS Prototype to be installed during LS-1 → also in LHC (LS-2?)

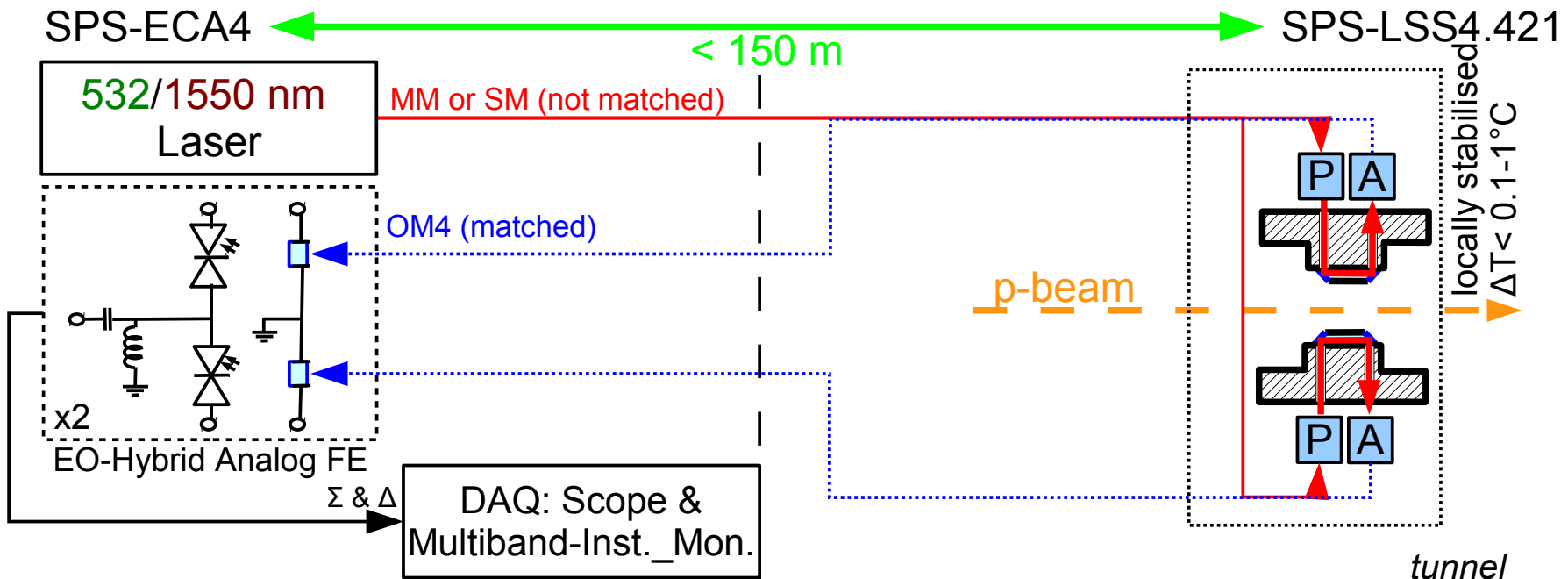

- Major paradigm change from 'Q' H-T diagnostics' to an 'inter- and intra-bunch instability monitor'!



Present main limitations:

- Sampling limited to  $8/\sim 6.3$  ENOB  $\leftrightarrow$  resolution  $\sim 100$   $\mu\text{m}$ 
  - Beam typ. lost before visible with HT
  - Q/Q' diag. requires  $\sim 2 \sigma$  kick amplitudes  $\rightarrow$  emittance blow-up (similar to BPM/ADT)
- Sampling buffer: original HT tracks single bunch over 1-2k turns vs. all bunches  $< 10$  turns
  - issues: oscilloscope reliability, read-out perf., IT safety, integration, ...
- Shorter bunches, higher modes  $\rightarrow$  need increased system bandwidth
- Issue of instabilities of interest occurring ...
  - A) ... on any & a priori unknown bunch,
  - B) ... at a not precisely/unknown time during the fill

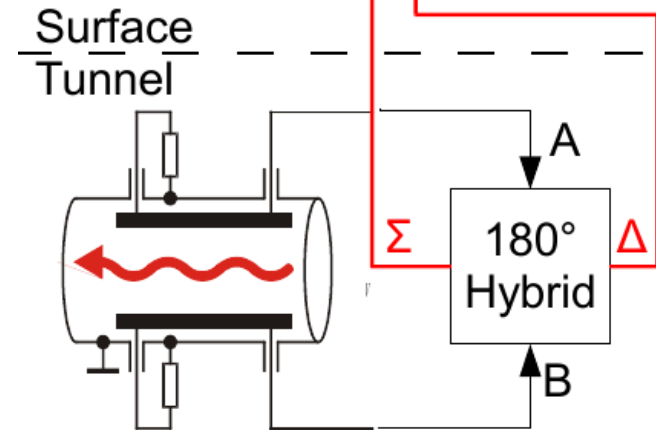

$\rightarrow$  Upgrade proposal: implement something similar to what is known in aviation industries as a 'flight recorder'

- Somewhat orthogonal requirements to be satisfied at the same time:
  - A) track one bunch over few thousand turns to measure growth times
  - B) track all bunches to detect/identify type of instability

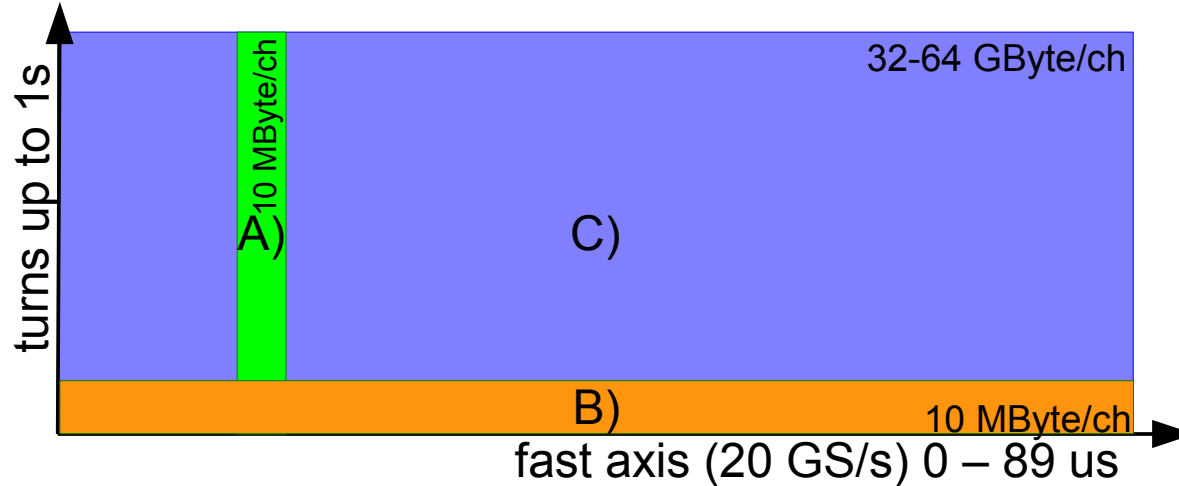

C) Huge buffers simplify triggering and data selection but also make smart memory management, online and automatic post-processing mandatory

- Main idea: deploy a acquisition system similar to what is known in aviation as 'flight recorder'
  - Record every turn & bunch for >10k turns and with bandwidth of 6 GHz
  - Serves both 'post-mortem' (MP) and study buffer (ABP) requirements

- Exploitation using scopes from Agilent, LeCroy and Agilent are time-proven but ultimately limited in available sampling memory, post-processing and reliability of controls integration
- Interesting new candidate: Guzik's GSA & ADC 6000 Series
  - 4 (2,1) ch@ 4 (6.5/8, 13) GHz
  - 16 (32) GB/ch sampling buffer ↔ monitoring of 1.6 s of beam data!
  - Various on-line processing that could be exploited to pre-select data:
    - FFT & DFT (per bunch, mag. average, sub-frequency ranges), rise-time, bunch-width (FWHM), bunch statistics (average, r.m.s., min., max. signal), number of rising/falling edge → possible HT mode detection already in HW?
    - Functionality to be explored → tested demo system for evaluation
- System to be deployed to detect PS Ghost&Satellite and intra-bunch (head-tail) upgrade in the SPS as part of LIU
- However:
  - Sampling limited to ~6.3 ENOB ↔ resolution ~100 um (beam losses)
  - Important price tag, no budget/requirement confirmation for LHC





# Analog Frontend and Pickup Improvements II/II

## Multiband-Instability-Monitor (MIM)

- Upgrade motivation: oscilloscope sampling limited to 8/~6.3 ENOB  
↔ resolution ~100 um: beam typ. lost before visible with HT
- Divide-and-Conquer strategy – use multiple ADCs to sample the same signal.  
Two common approaches:

- Time-Interleaving:

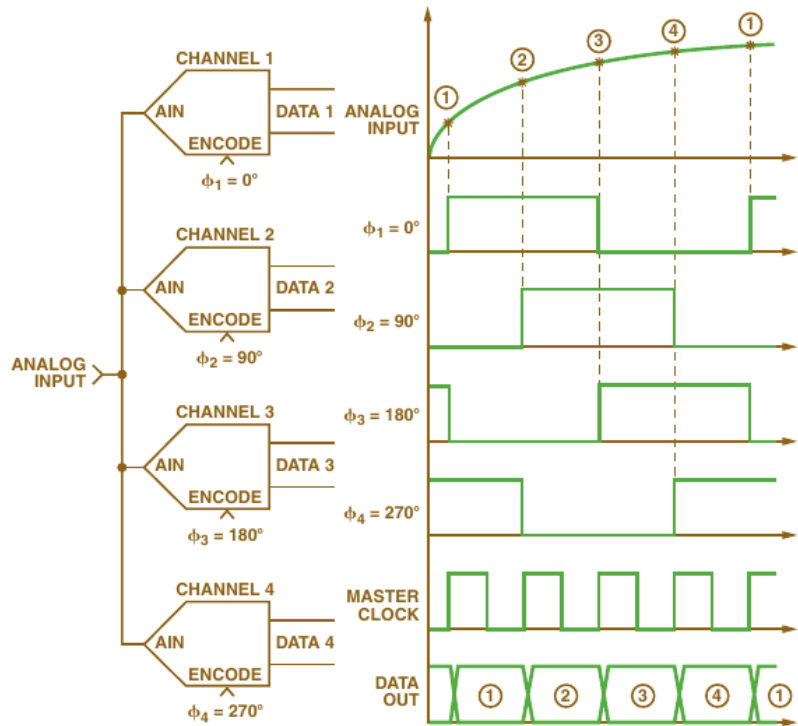

–  $f_s > 250 \text{ MHz}$  (i.e. oscilloscopes/digitisers)

- Orthogonal-Frequency-Multiplexing:

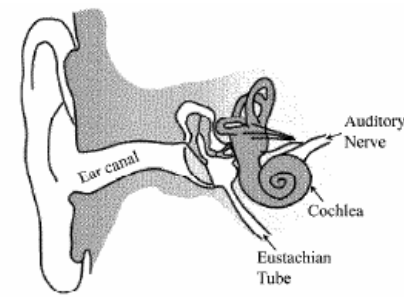
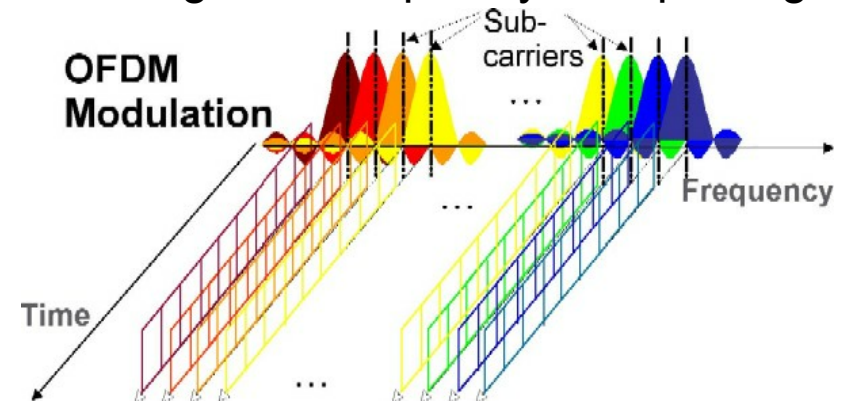

Similar to nature's design for eyes and ears

– aka. cochlear RF-receiver, similar function to mammal's eyes and ear organ

# Multiband-Instability-Monitor (MIM) Proposed Parameter Specification

- 'Nyquist-Shannon sampling' and 'Fourier' theorem state that beam signal/instability information content is identical regardless of whether processed in time- or frequency-domain, provided the bandwidth and sampling criteria are met. 
- For the LHC (SPS) this corresponds to:
  - Min. (design) bunch length 0.2 ns r.m.s.  $\rightarrow f_{\max} \approx 15$  GHz
  - Finite RF bucket size of 2.5 (5) ns  $\rightarrow \Delta f_{b|_{\min}} = 0.4$  (0.2) GHz
  - 25 ns bunch repetition frequency  $\rightarrow \Delta f_{bw} > 2-3 \cdot 40$  MHz
- However, design bandwidth of the existing BPL[H/V] (BPLC) pick-ups supports only  $f_{\max} \approx 6$  GHz (N.B. EO- & SL-BPM:  $f_{\max} > 6$  GHz)
- Proposal: split the requirements into two phases (keep modularity):
  - Initially using BPL[H/V]):  $f_{\max} \approx 6$  GHz &  $\Delta f_{b|_{\min}} = 0.4$  GHz  $\rightarrow$  16 bands
  - For new pick-up, upgrade by 16 channels (32 total, 12.8 GHz)

# Multiband-Instability-Monitor (MIM)

## Example: Time-Domain Reconstruction

- Single bunch/turn – head-tail mode=1, 16 bands @  $\Delta f_h = 0.4$  GHz

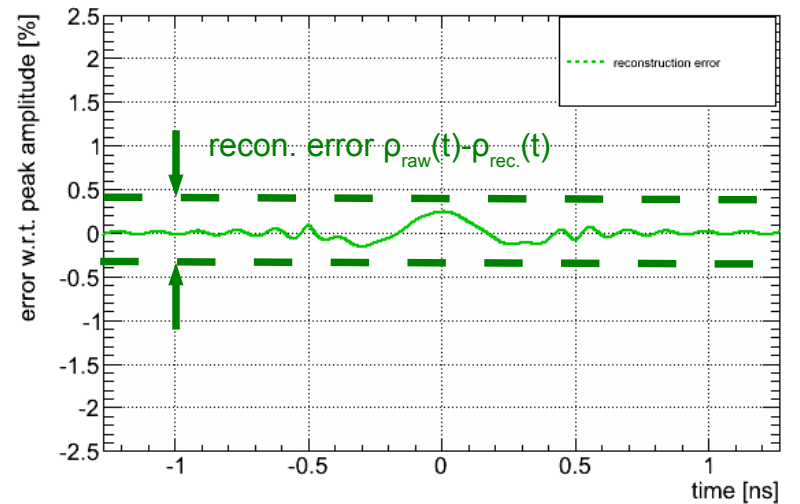
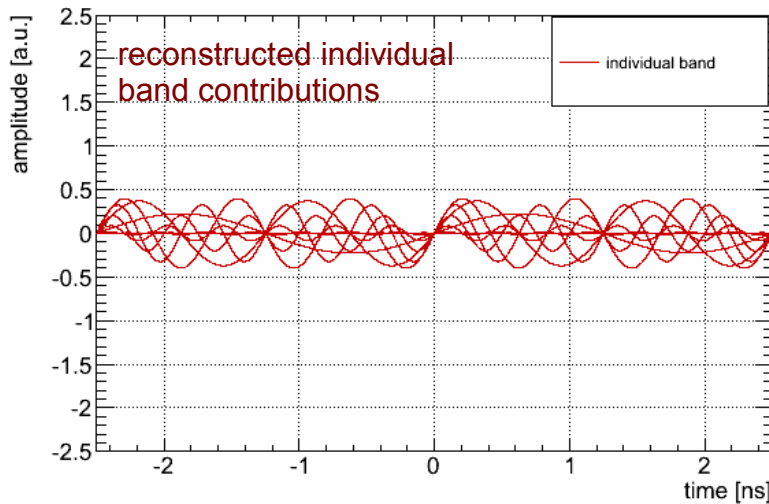
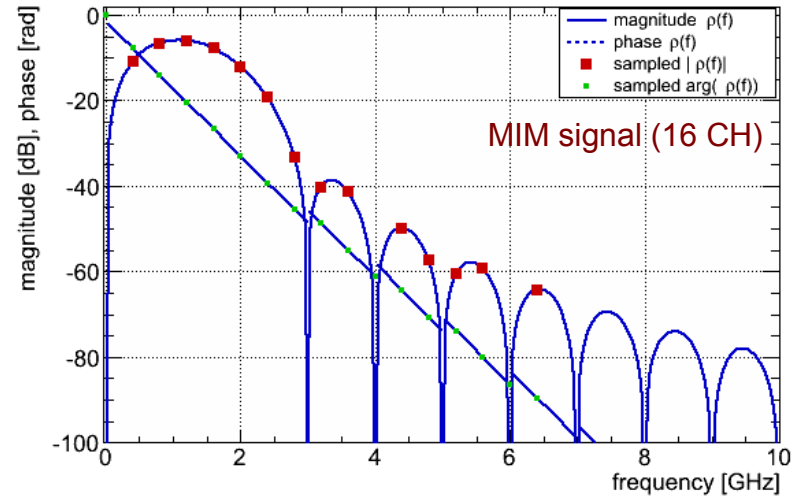
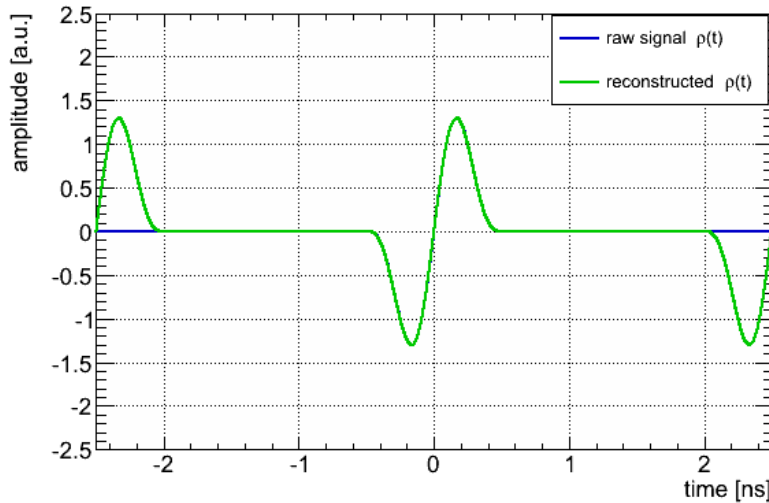

- Pk-Pk reconstruction error of less than 0.5% for 16 bands

# Multiband-Instability-Monitor (MIM) – Schematic

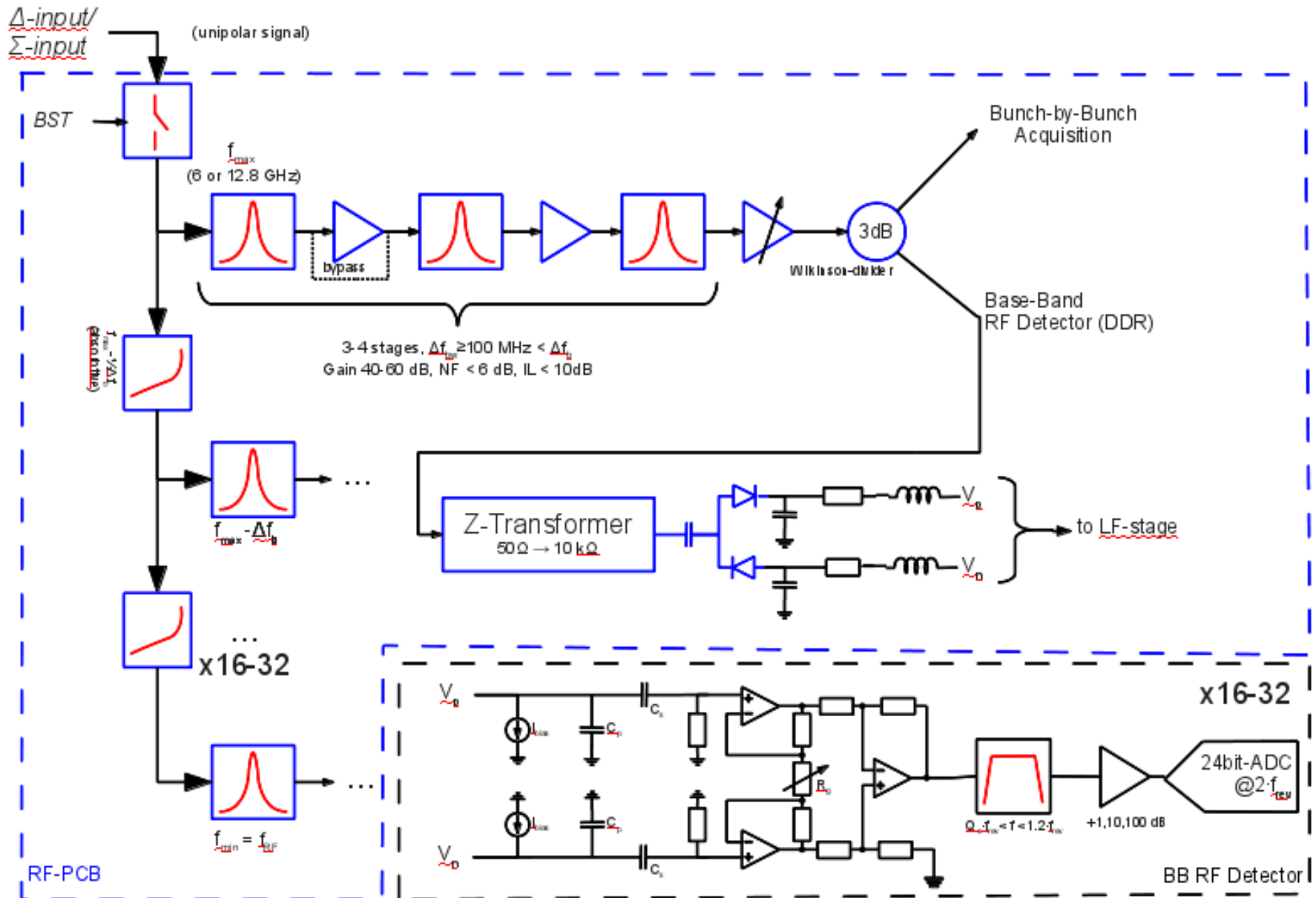

- I. Balanced RF Schottky Diode Detector → *schematic see slide before*
    - highest possible sensitivity (close to thermal noise limit)
    - most robust → proposal to use this as an early instability trigger/detector
    - only either all bunches or gating on single-bunch
    - more suited for frequency-domain analysis
  
  - II. Bunch-by-Bunch RF Schottky Diode Detector → *schematic see appendix*
    - similar to above + instantaneous measurements for all bunches possible
    - only magnitude information (i.e. no phase/time-domain reconstruction)
    - reduced sensitivity, more elaborate DAQ needed (n x 80 MB/s)
  
  - III. Direct-Down-Conversion Receiver → *schematic see appendix*
    - full amplitude & phase information
      - bunch-by-bunch time-domain reconstruction possible
    - Complex (multiple mixing frequencies, noise, clock jitter), commercial solutions exist but no integrated CERN-DAQ solution available yet
    - 60 dB less sensitive than the above but still a bit more than scopes
- Present baseline being designed to be compatible with having 'option I' + either 'option II' or 'option III' which could be upgraded at a later stage.



# Multiband-Instability-Monitor (MIM) Time- & Frequency-Domain Resolution

- Pushes the envelope of what can be done with modern ADCs

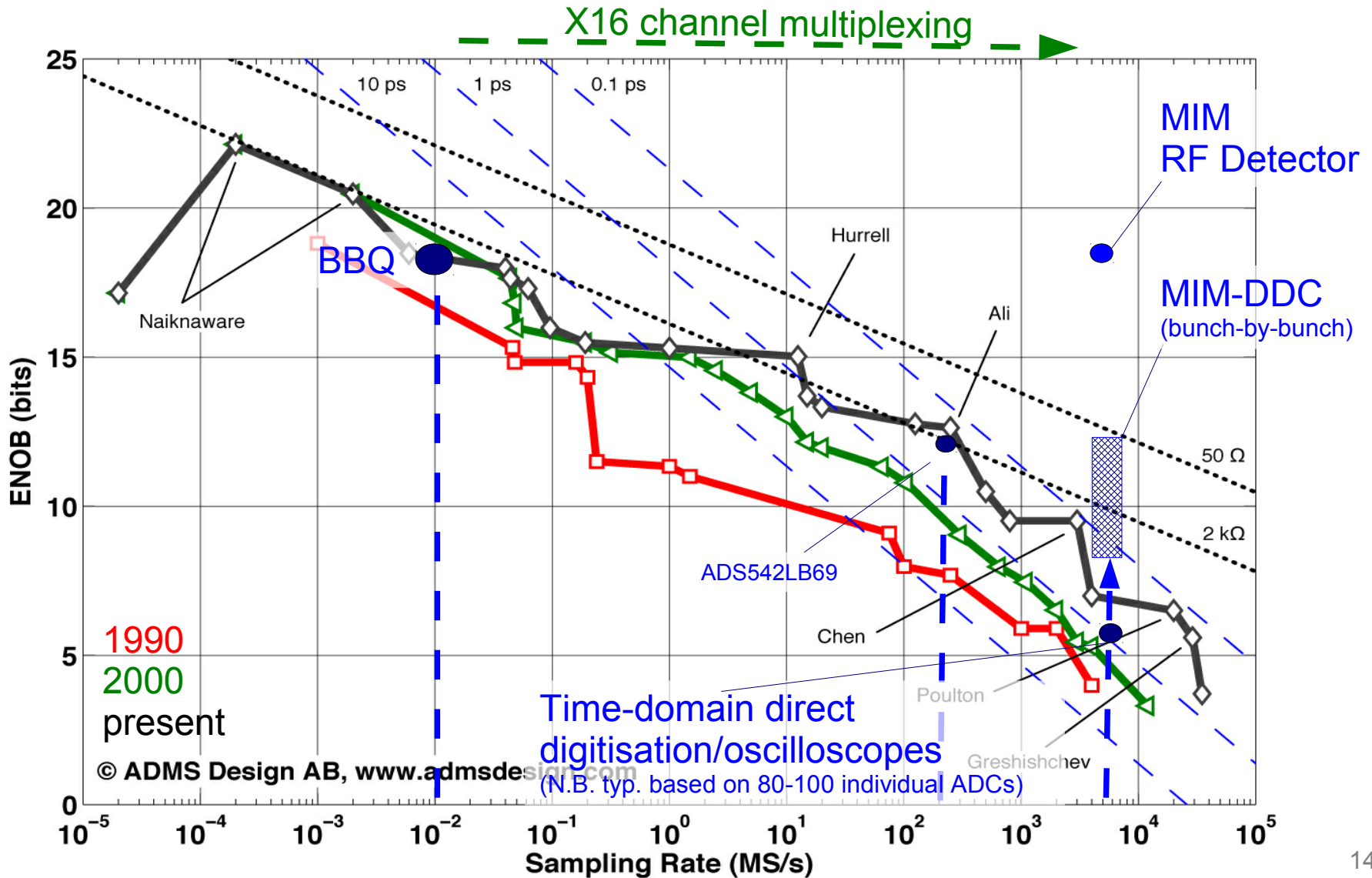

ADT BBQ Q comparison, Ralph. Steinhagen@CERN.ch, 2012-08-25

# Multiband-Instability-Monitor (MIM)

## Example: Frequency-Domain Reconstruction

- Example: if there is more power in 'CH n≥1' → head-tail instability

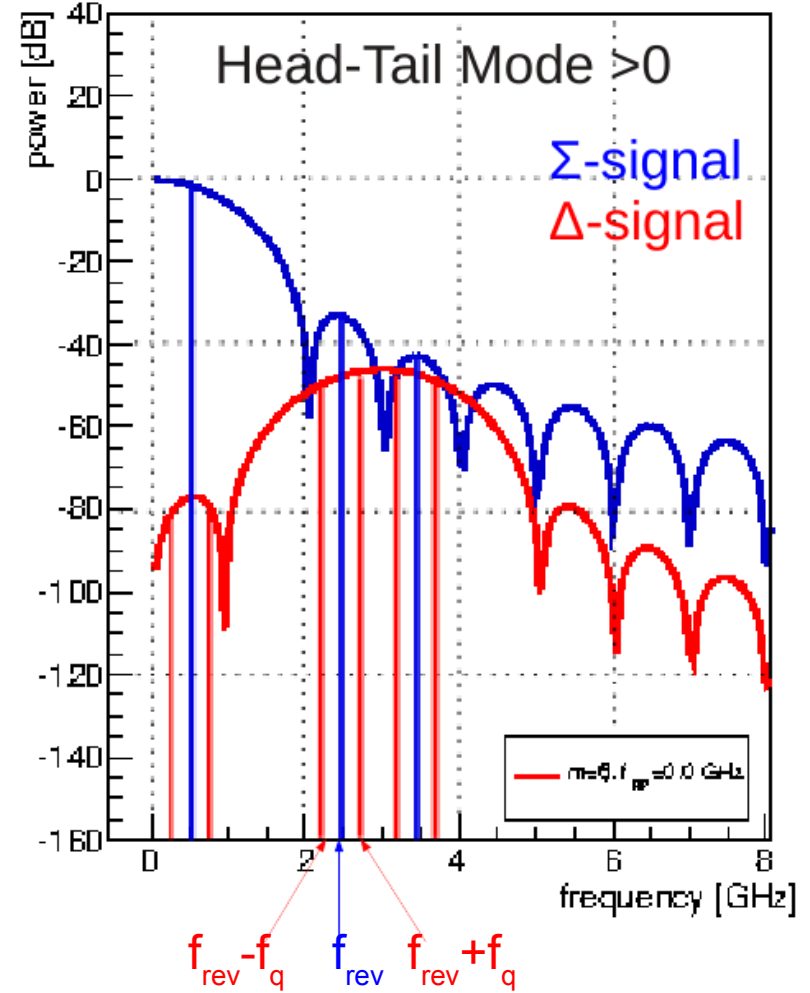
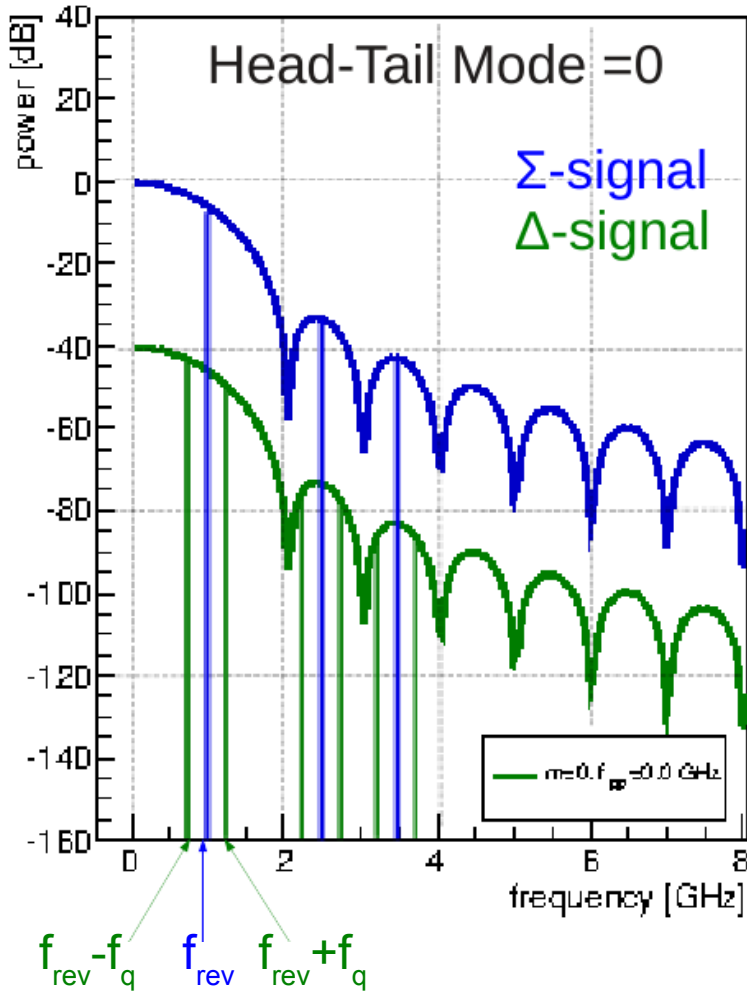

- A full diagnostics chain in its own right but will also be used to pre-trigger the time-domain based data acquisition



# Multiband-Instability-Monitor (MIM) Proof-of-Concept Prototype

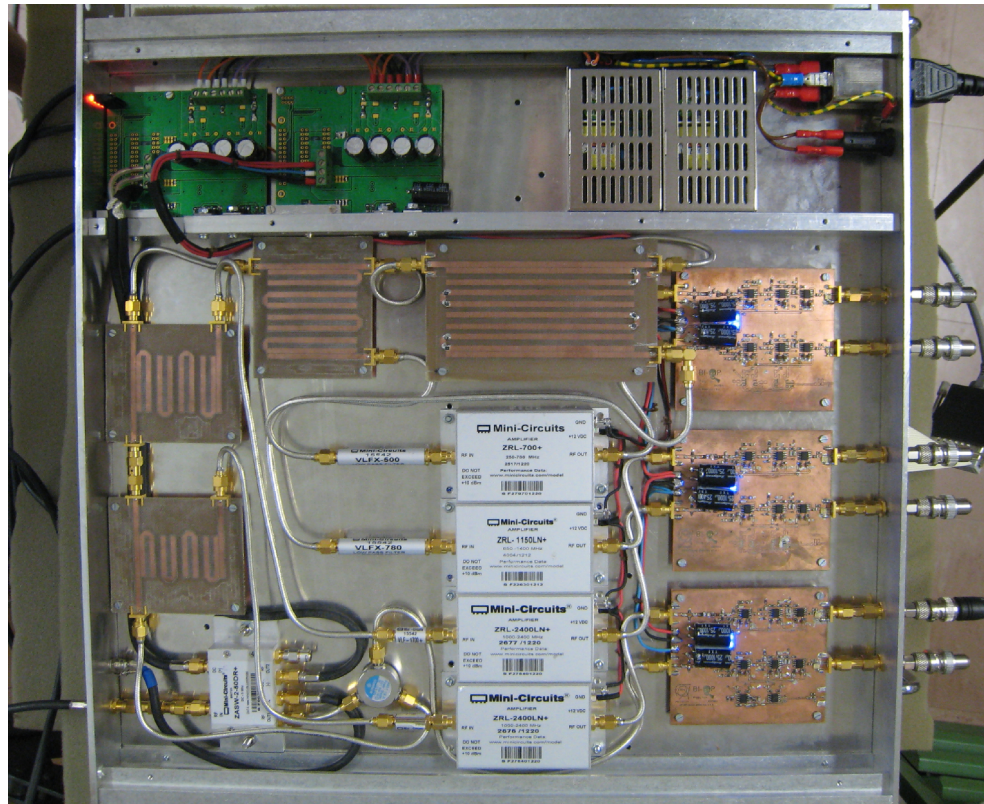

$\Delta$ -Signal

full-range  
0.4 GHz

0.8 GHz  
1.2 GHz

1.6 GHz  
full-range

- Proof-of-concept successfully tested in SPS & LHC
  - Prototype based on only 4+1 channels rather than 16+
  - Improves the diagnostics for safe testing of beam stability margin: re-use existing BQK as wide-band kicker to excite specific head-tail and TMCI modes for measuring the growth/damping time of a given mode (N.B. Low ~300-400 W power requirement)



- B1-V instability during ADJUST as measured by the MIM prototype:

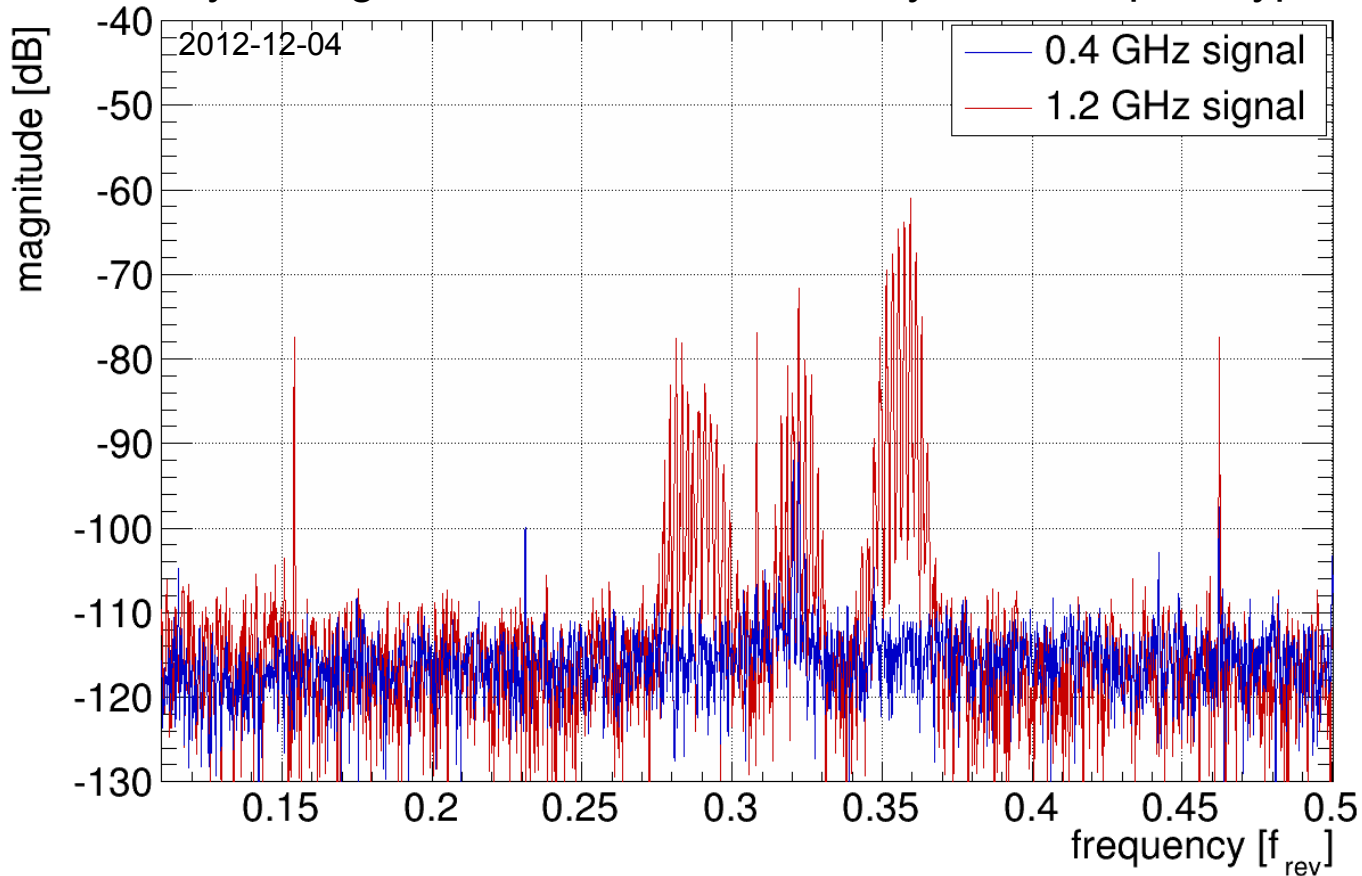

- Little activity in the 400 MHz band compared to the 1.2 GHz band (N.B. vivid  $Q_s$  sidebands) indicates that this instability is related to an intra-bunch motion (simulation/additional measurements are indicative of a TMCI)
- More sensitive than direct time-domain detection (i.e. using oscilloscopes)

### Head-Tail mode only

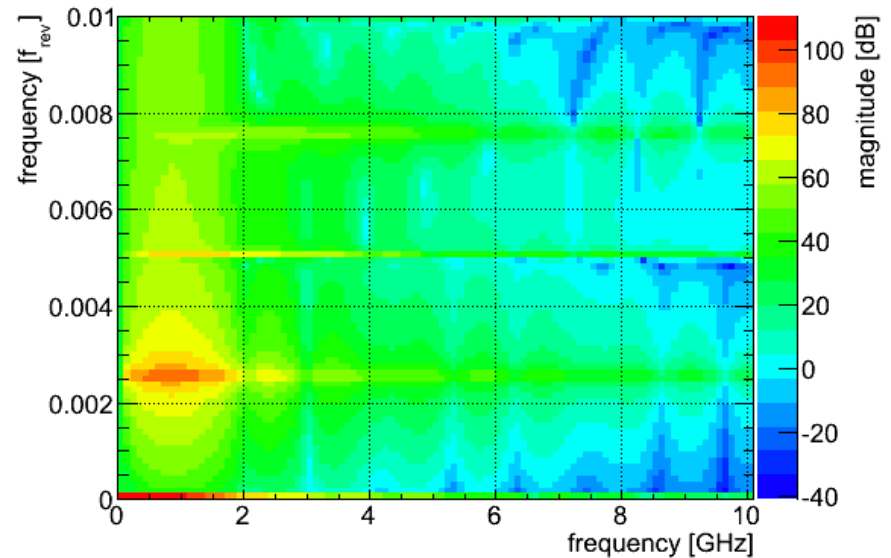
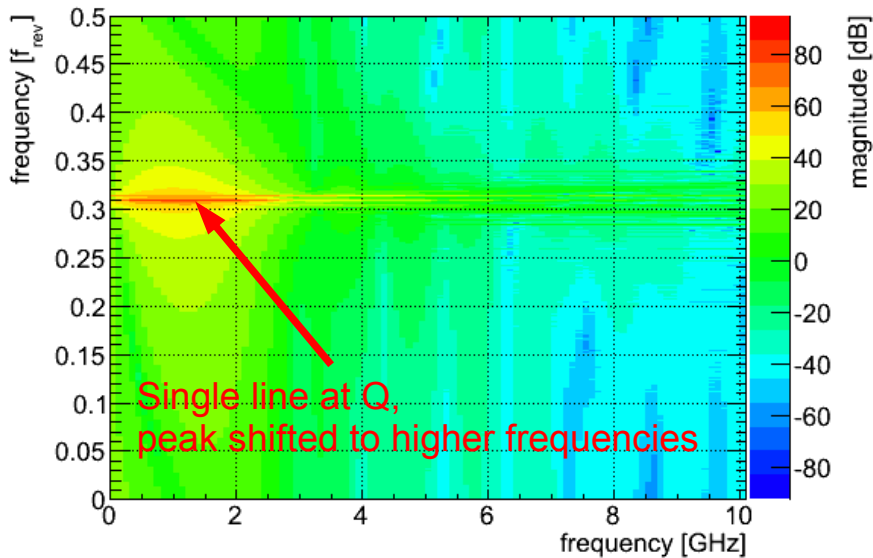
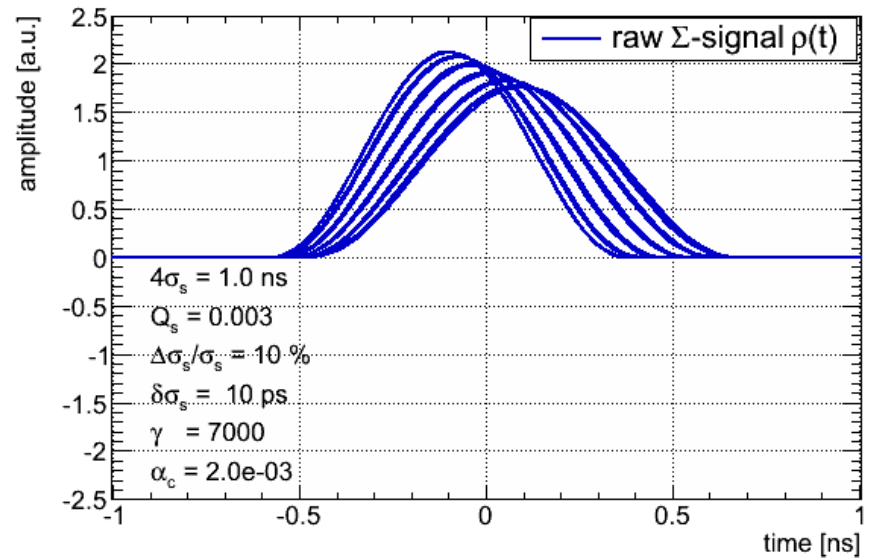
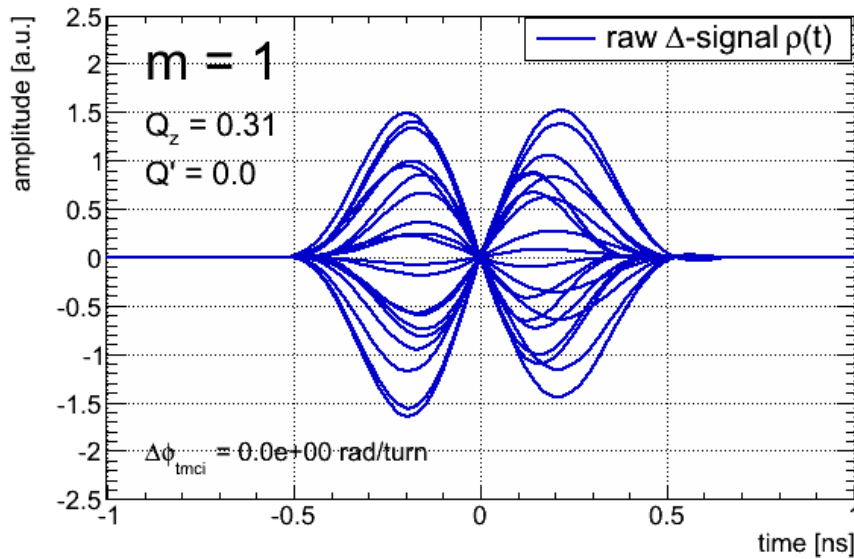

### Head-Tail mode + TMCI

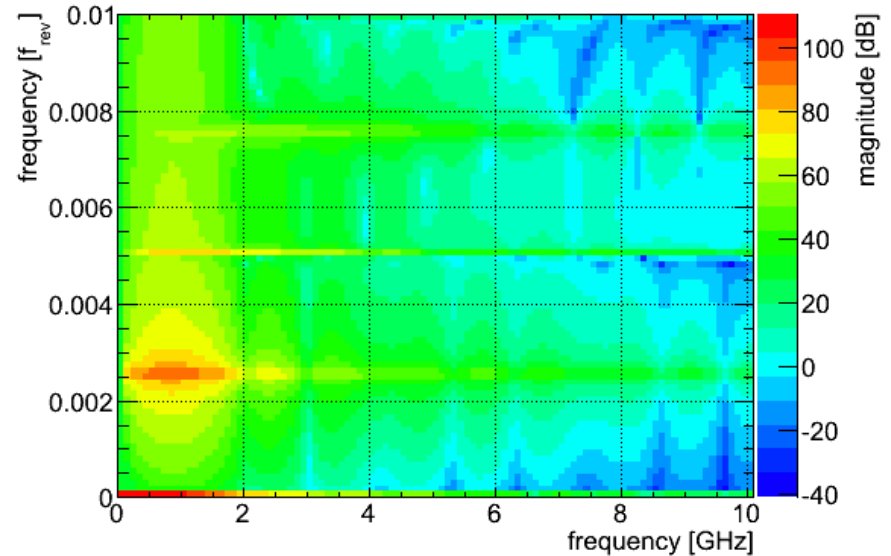
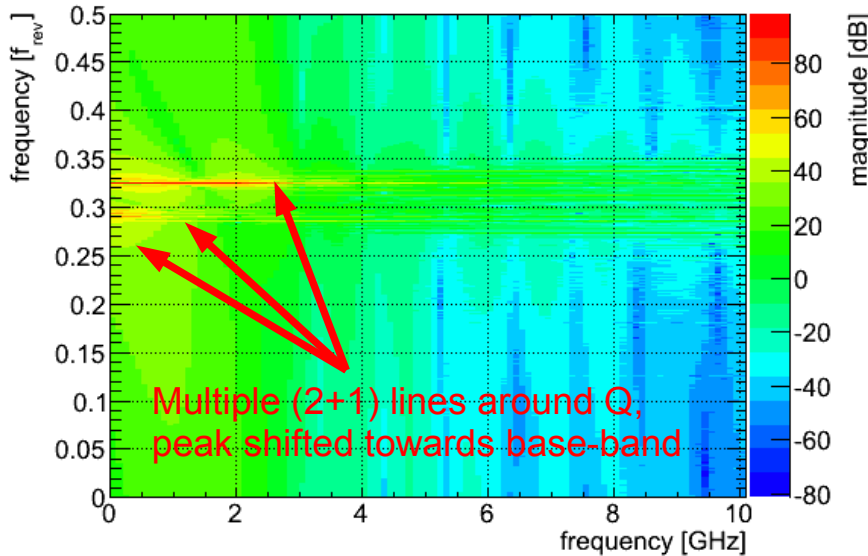
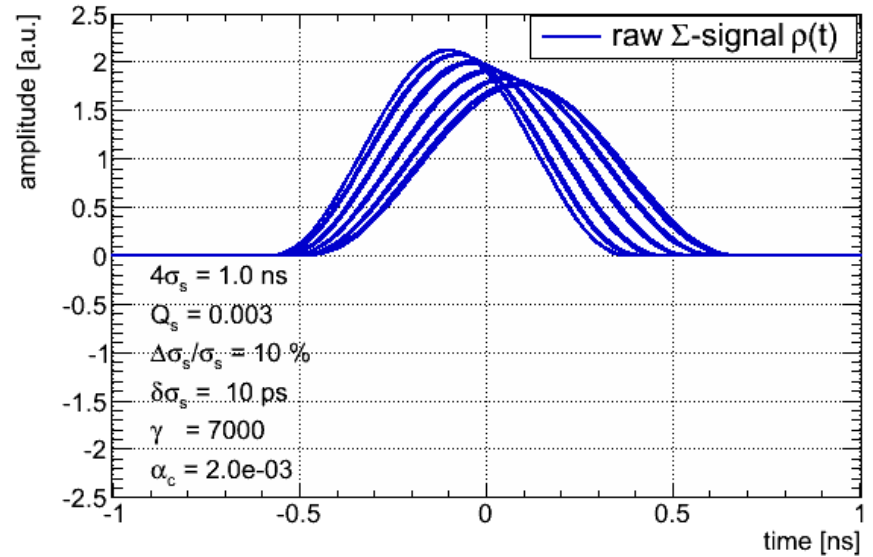
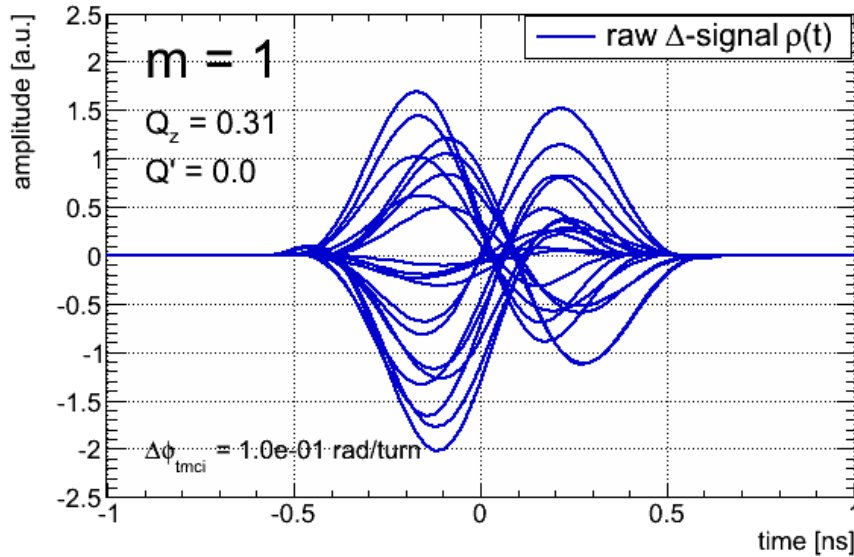

# Multiband-Instability-Monitor (MIM)

## Possible Use during 'Mode of Operation' Changes

- System is very sensitive and in most cases detects growing oscillation amplitudes before they reach millimeter amplitudes
  - Provides a bench mark for the various models and simulation tools
  - Could be used to safely measure beam stability margin using growth/damping time measurements while varying machine parameters e.g. within the same fill. (reciprocity theorem)
    - installed and tested this using a HF exciter on the BQK-V during 2012
- Could be used as a criteria to validate whether proposed new settings are safe w.r.t. existing ones (i.e. beam/bunch intensity, spacing,  $Q/Q'$ , octupoles, beam-beam separation, etc.)
  - reduces the amount of trial-and-error/dump
  - Changes the presently more qualitative assessments into quantitative measurements



# Multiband-Instability-Monitor (MIM) Testing Stability Margin with HF Exciter (0.3-2.5 GHz)

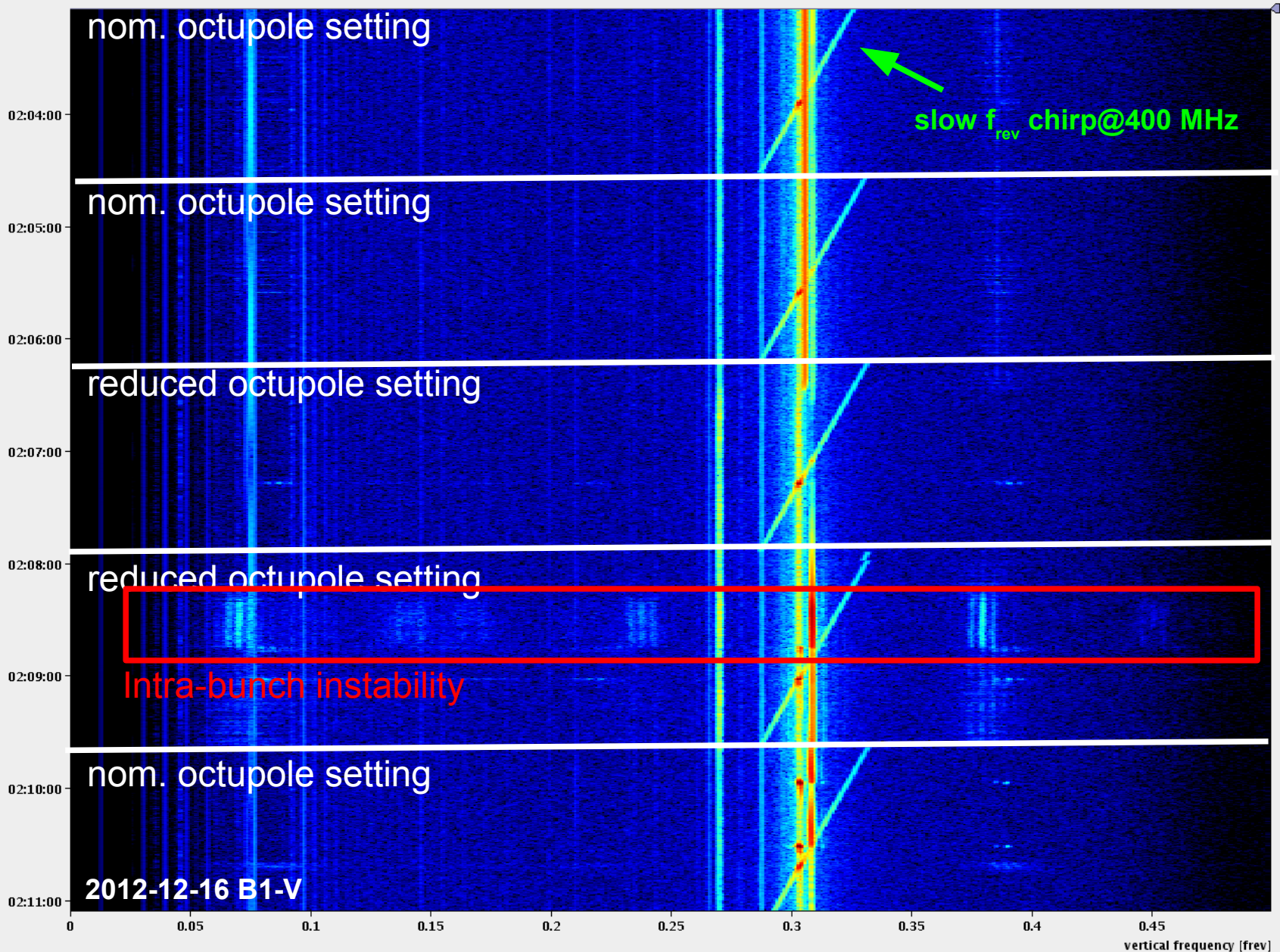

ADT BBQ Q comparison, Ralph.Steinhausen@CERN.ch, 2012-08-25



- Analogue Front-end:
  - moderate prototyping costs
  - final design, evaluation, production of baseline option: ~ 1 yrs
  - Bunch-by-bunch acquisition system development: + ~1 yr
  - New pick-up: hope for an LS1 SPS prototype → LHC: LS2 the earliest
- Digitizer Upgrade:
  - Important price tag → important lead-times of passing this through the CERN FD & Finance committee and actual procurement
- Regardless of the specific acquisition system, all solutions have implications and require resources for a full integration into day-to-day operation
  - can mostly start only once the hardware is ready and in place (~0.5-1 yr)
  - additional tunnel rack-space
  - front-end and online post-processing server, logging & GUIs (ABP, OP)
  - triggering infrastructure and synchronisation with other instrumentation (CO, BI/RF)
- **New instrumentation upgrades need a 'go-ahead' and resource in the next few months to be ready after LS1**

- Proposal to provide a high-frequency diagnostic that is beyond and complementary to the existing bunch-by-bunch capabilities of the ADT
- Three areas of active R&D and possible upgrades during LS1
  - Pickups: Electro-Optical-BPM prototype in SPS (aim: LS1 → if requested: in LHC ~LS2)
  - Analog-FE: wide-band hybrid/gain-control, Multiband-Instability-Monitor (MIM)
  - Digital-Data-Acquisition
    - A) Classic time-domain: next generation digitizer upgrade, however:
      - ~6.3 ENOB ↔ 100 um resolution: beams dumped under op. conditions
      - Important price tag and lead-times
    - B) Multiband-Instability-Monitor, three acquisition options:
      - I. Balanced Schottky Diode Detector → technical implementable during LS1
        - » highest possible, nm-level resolution
        - » most robust → use this as an early instability trigger/detector
      - II. Bunch-by-Bunch RF Schottky Diode Detector – (magnitude only)
      - III. Direct-Down-Conversion Receiver – full amplitude & phase information
- Implies follow-up in terms of front-end SW, GUIs, logging, synchronisation, ..
- Existing resources allow at most option 'B.I' while keeping compatibility with later upgrade of either complementary option 'B.II' or 'B.III'

additional supporting slides





# Multiband-Instability-Monitor (MIM) Time- & Frequency-Domain Resolution

- Pushes the envelope of what can be done with modern ADCs

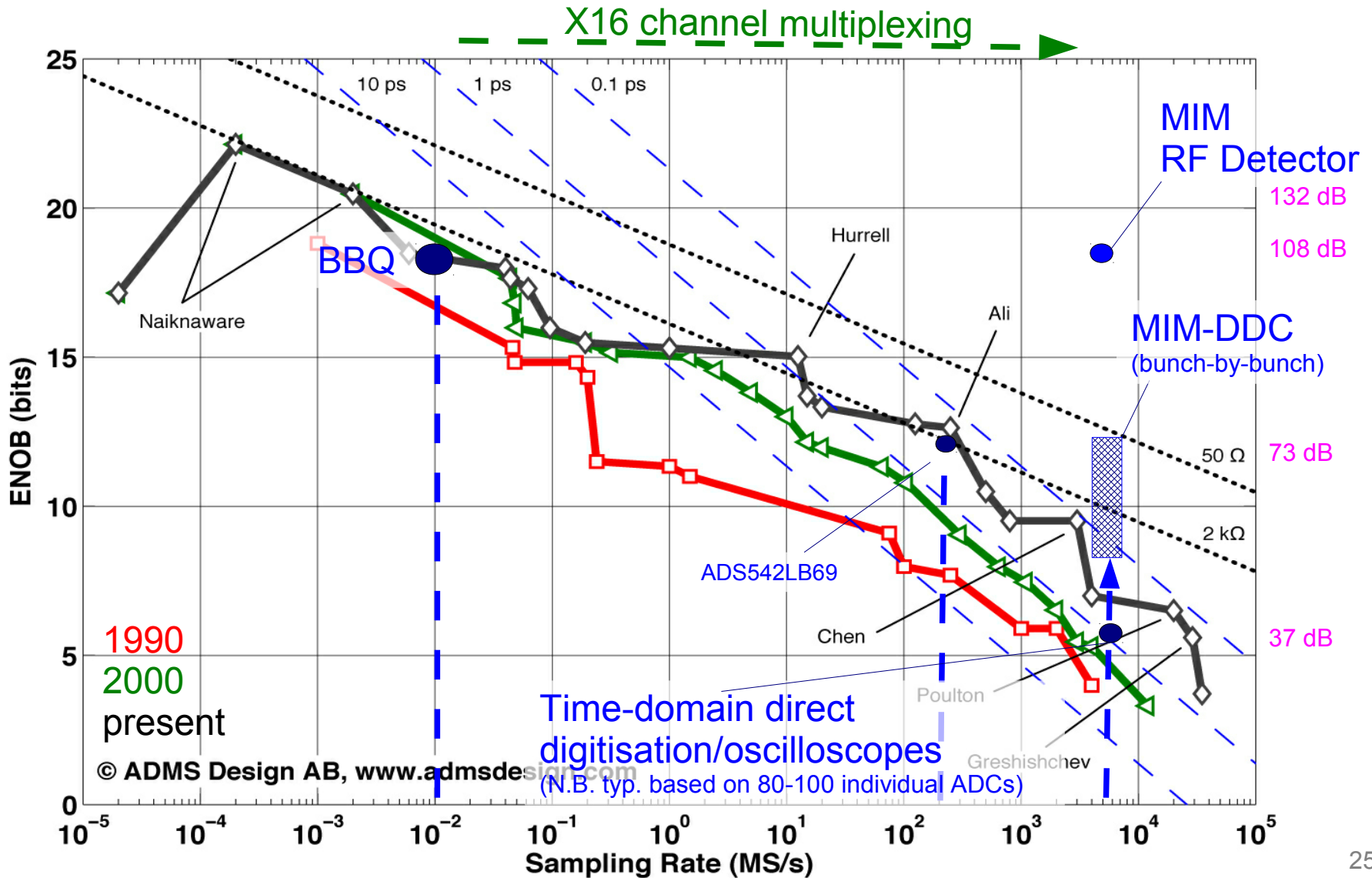

ADT BBQ Q comparison, Ralph.Steinhausen@CERN.ch, 2012-08-25

# Multiband-Instability-Monitor (MIM) Bunch-by-Bunch RF Schottky Diode Detector

- Differential measurement between the bunch-by-bunch signal and avg orbit
  - PRO: reduces common-mode → higher dynamic range than BPM electronic.
  - CON: less sensitive than simple RF det., no phase information for  $f > 400$  MHz

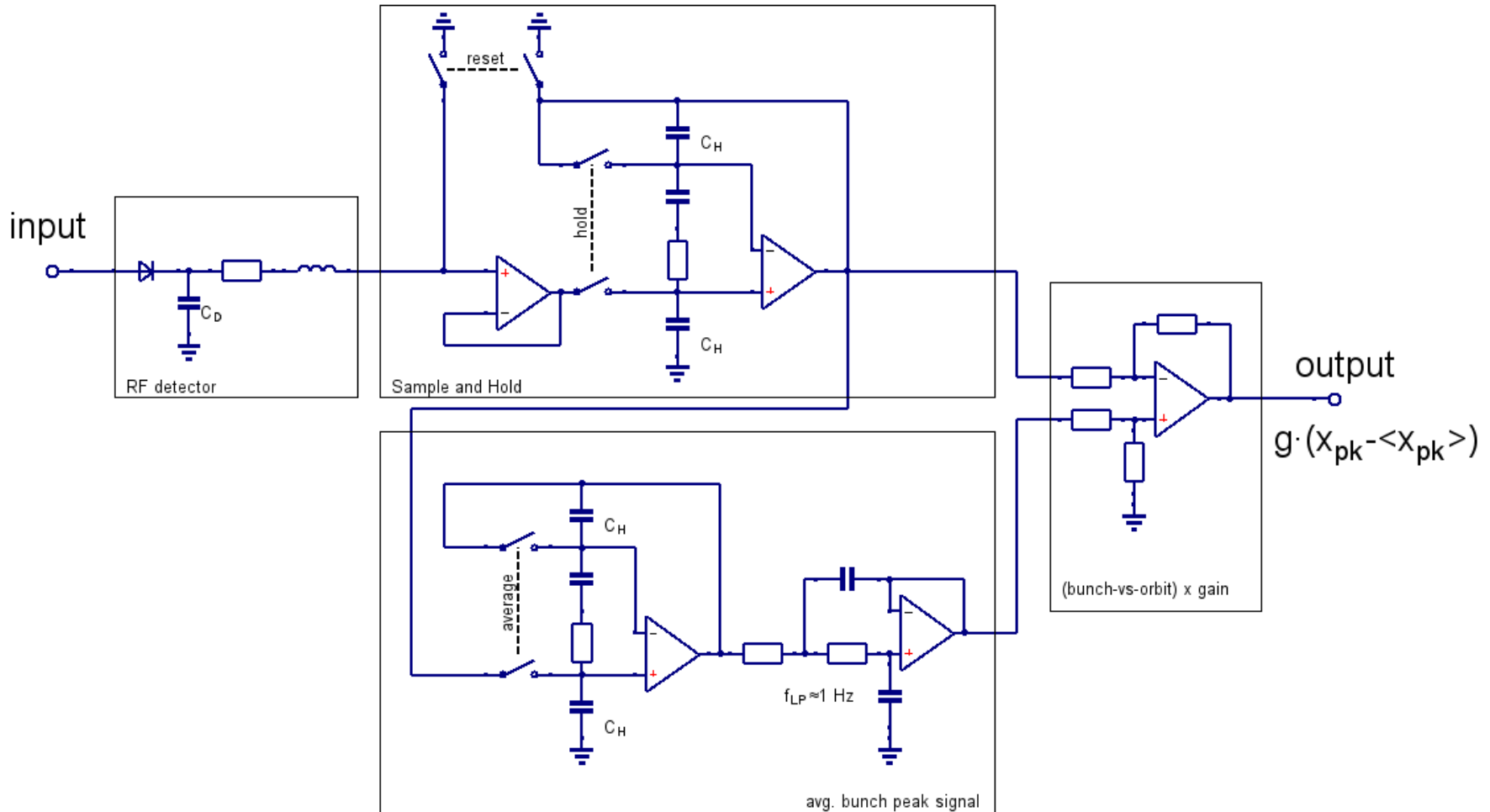

# Multiband-Instability-Monitor (MIM)

## Bunch-by-Bunch Amplitude and Phase Detection

- Direct-Down-Conversion Scheme (DDC) aka. 'Software-Defined-Radio' (SDR)
- Exists in two flavours: Analog and direct (digital) I/Q-demodulator
  - analog: has wide bandwidth but affected by systematic drifts of RF mixers
  - digital: less drifts, easier to implement (SDR) but more syst. for large bw.
  - both: exists as system-on-chip, poorer signal-to-noise (N.F.  $\sim 12\text{dB}$  due to mixers/VGA) compared to RF Detector, no CERN integration (yet)

### Analog IQ Demodulator:

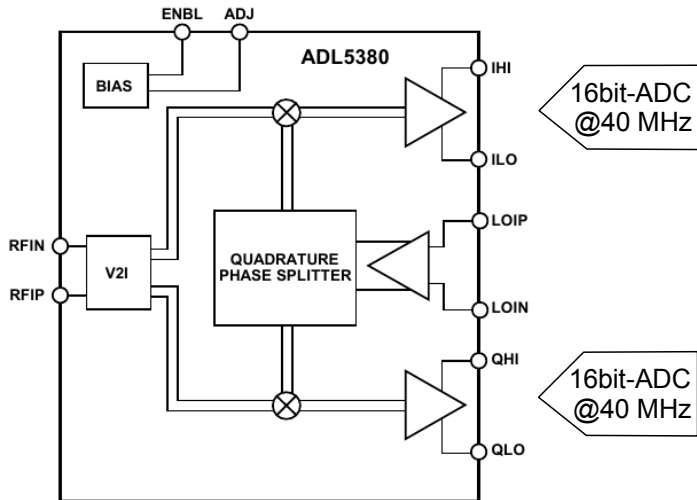

### Direct IQ Demodulator:

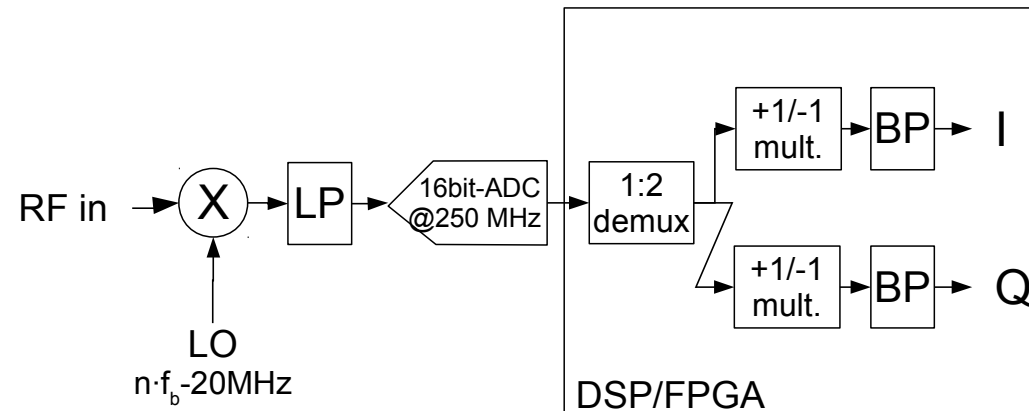

N.B Any RF Schottky Diode Detector is de-facto an unbalanced RF mixer with RF & LO tight together

- Similar strip-line design with response up to 3 (5) GHz bandwidth...

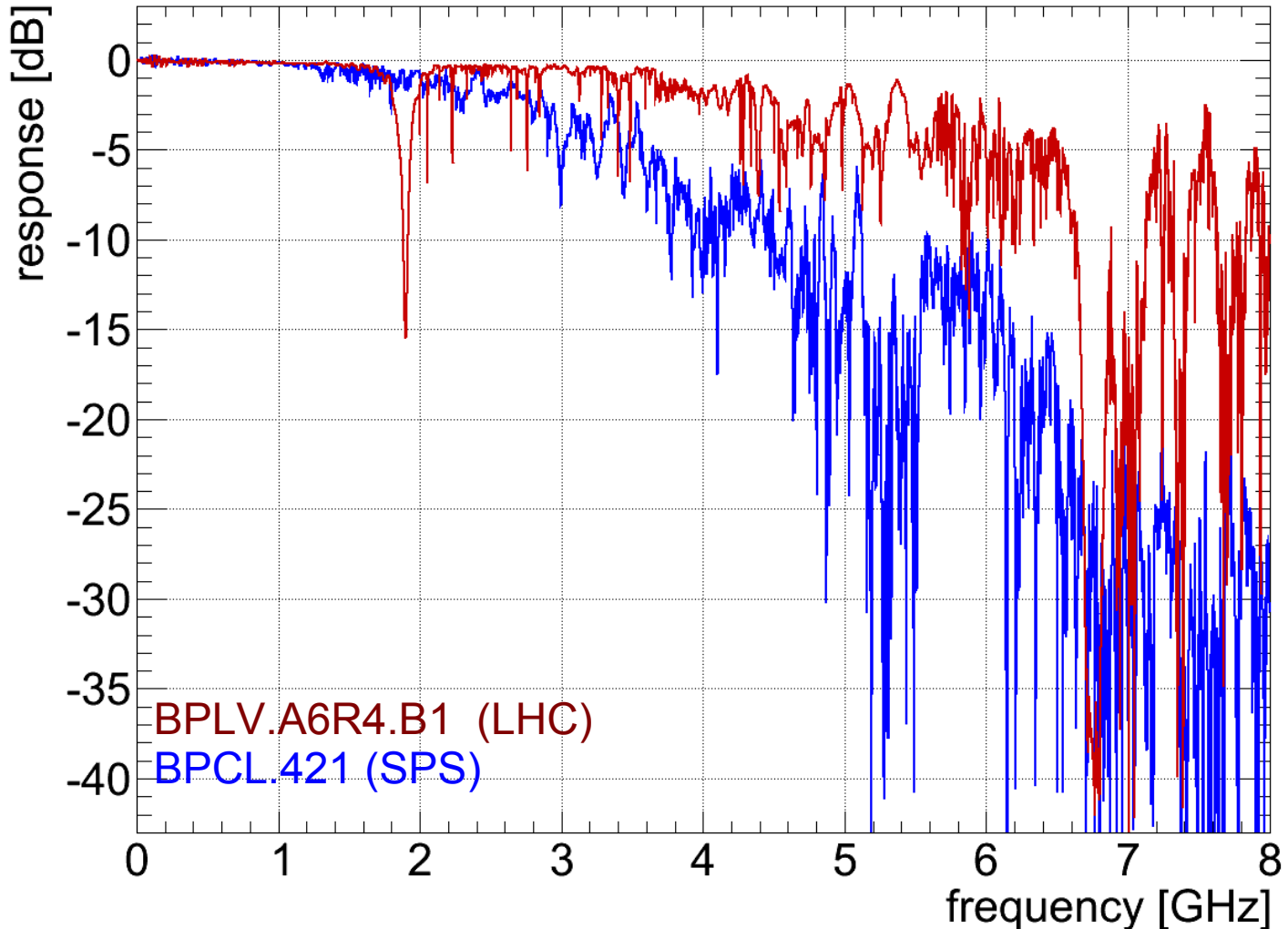

- A priori would expect the same...  
... differences likely due to RF feed-through dielectric material/geometry

- Filter bank – first section (here:  $\Delta f_{\text{bw}} = 200\text{MHz}$ )

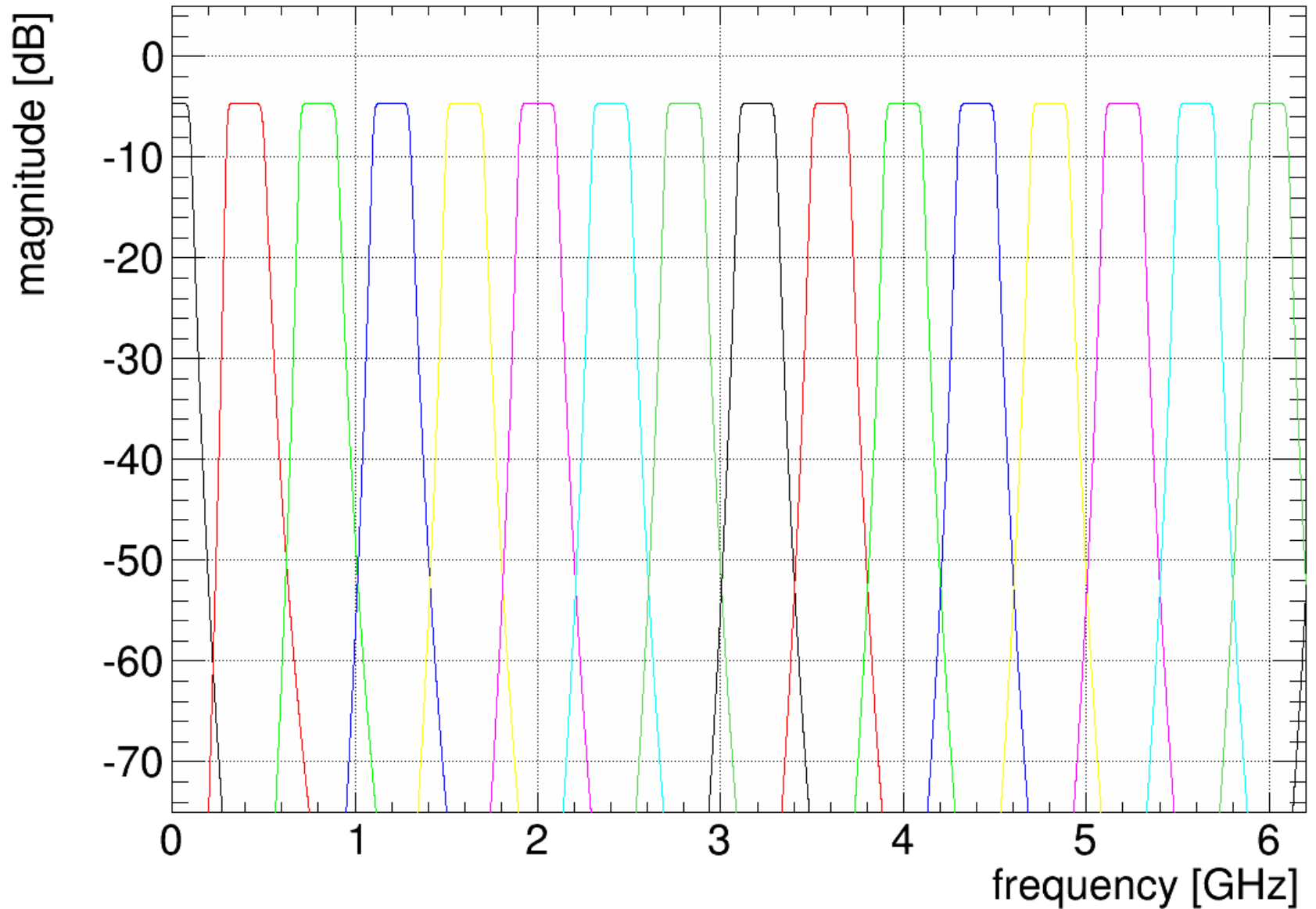

- Transverse instabilities come in various flavours, e.g.:
  - Lower-order modes: Inter-bunch resolving bunch-by-bunch motion → BPMs
  - High-order modes: Intra-bunch instabilities → Head-Tail<sup>1</sup> instabilities

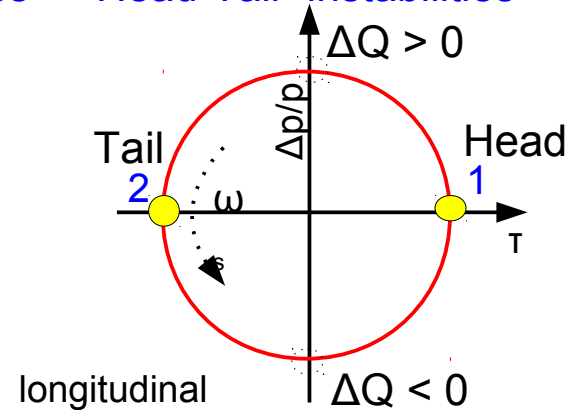
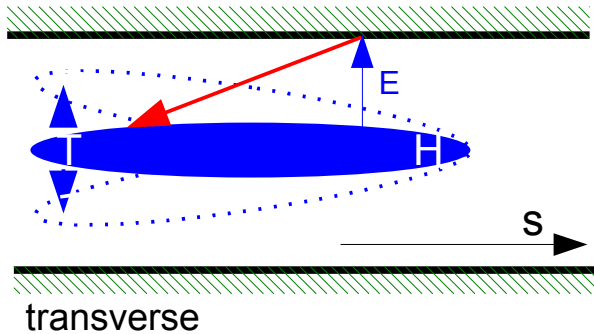

- Studied intensively in the CERN-Booster<sup>2</sup>:

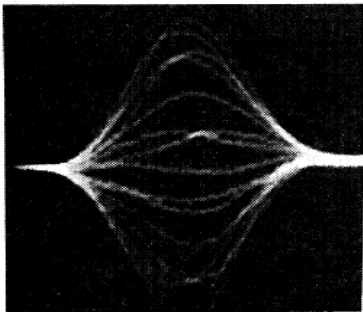

a) mode  $m = 0$ ,  $\chi = 0$

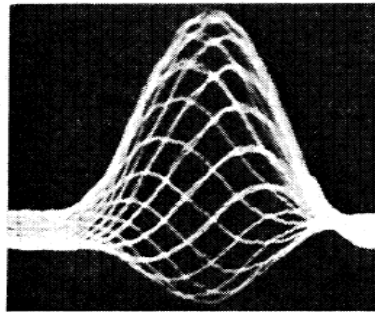

b)  $m = 0$ ,  $\chi = 2.3$  radians

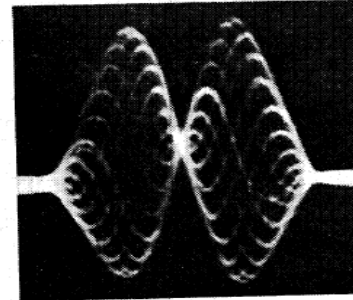

b)  $m = 1$ ,  $\chi = 6.9$  radians

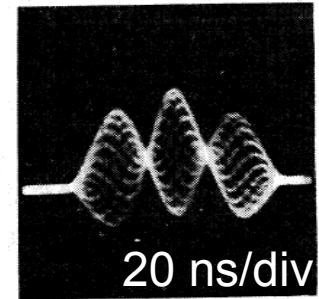

d)  $m = 2$ ,  $\chi = 6.9$  radians

- PS: 120 ns bunch length ↔ less demanding in terms of bandwidth
- SPS/LHC: bunch length down to 1 ns → requires multi-GHz analog bandwidth

1 M. Sands, "The Head-Tail Effect: An Instability Mechanism in Storage Rings", SLAC-TN-69-008, 1969

2 J. Gareyte, "Head-Tail Type Instabilities in the PS and Booster", CERN, 1974

- 30 dumps with post-mortem related to Q/Q' related instabilities (6 in 2011, 0 in 2010)

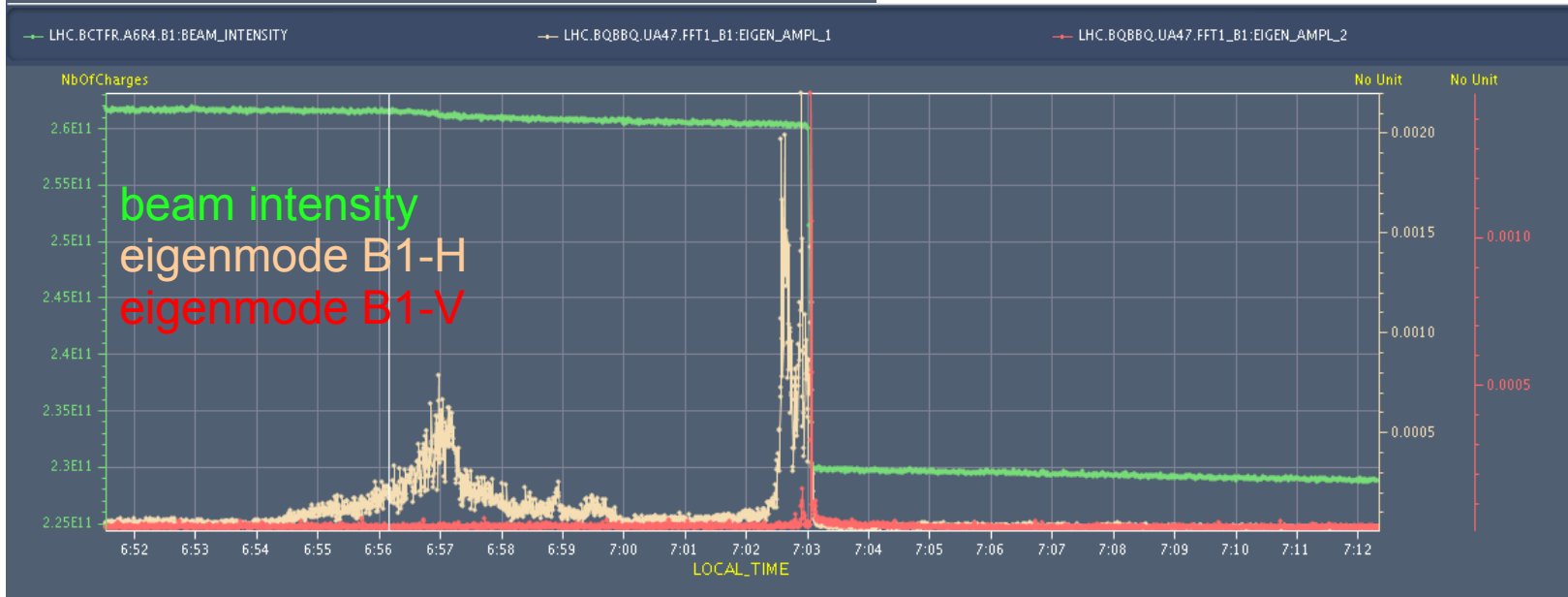
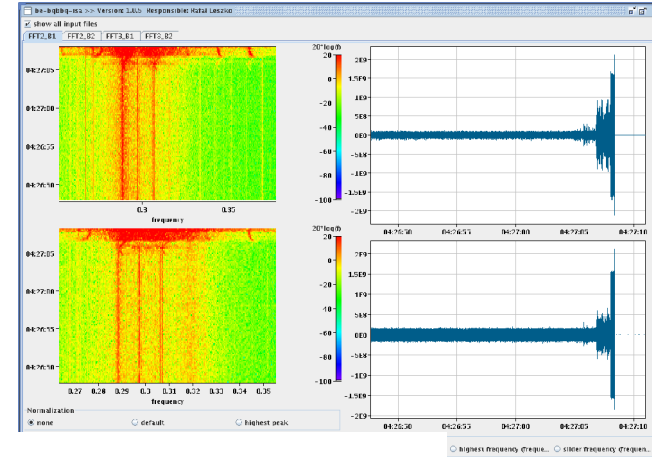
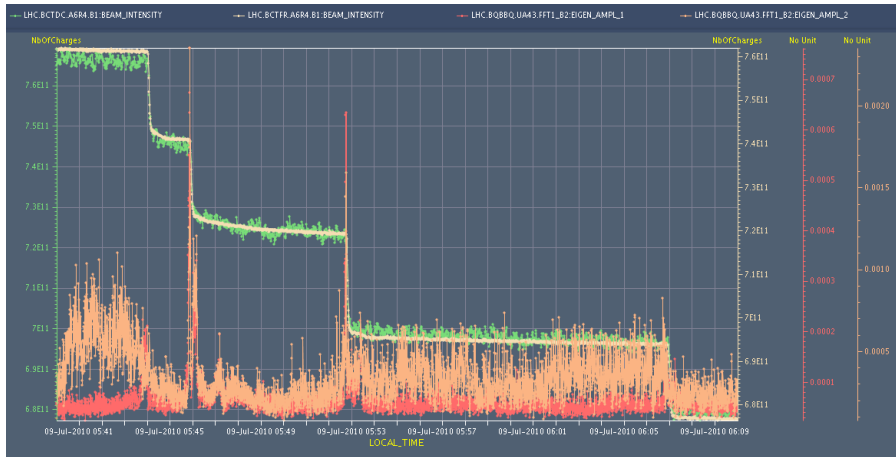

- Often detected early on by BBQ, signature points to a intra-bunch TMCI (MIM)

- Need crossing angle  $\theta$  to avoid additional parasitic collisions in the IR  
 → reduces bunch overlap → reduces luminosity:

$$L = L_0 \cdot F_{crossing} \cdot \dots = L_0 \cdot \frac{1}{\sqrt{1 + \frac{\sigma_s}{\sigma_{x,y}} \tan(\theta/2)}} \cdot \dots$$

- Without crab-cavity:

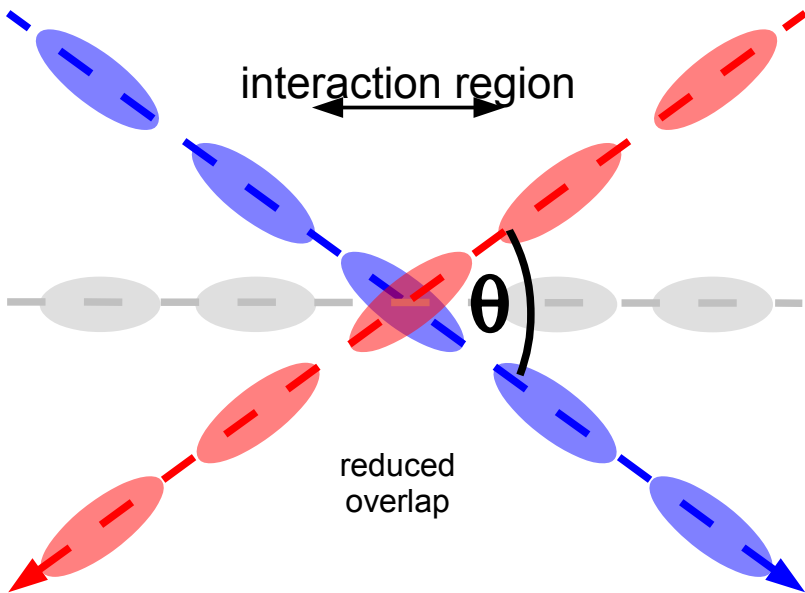

- Aim with crab cavity:  $F_{crossing} \approx 1$

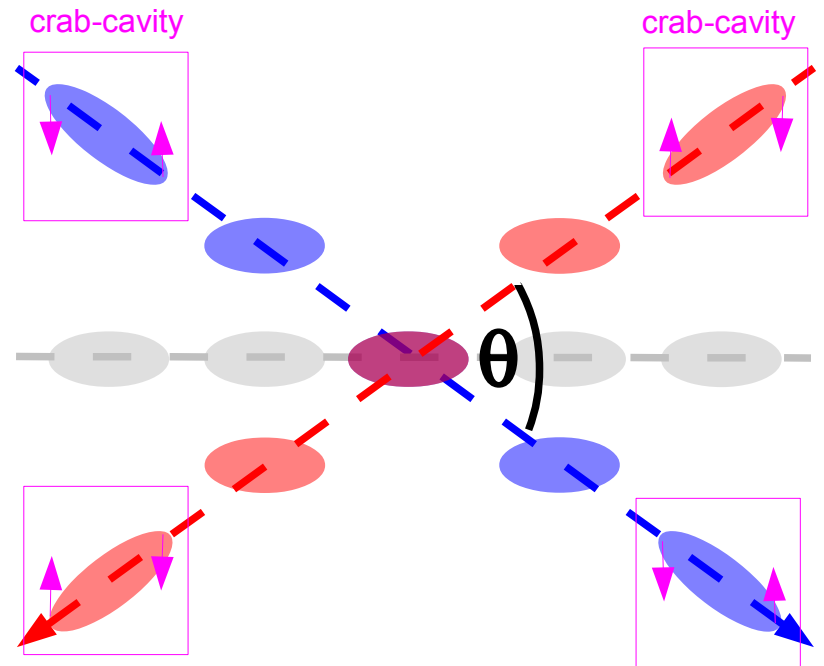



- Direct measurement of crab-cavity kick angle  $\theta$  and phase error  $\Delta\phi$   
 → orbit difference  $\Delta x$  between head and tail of the bunch

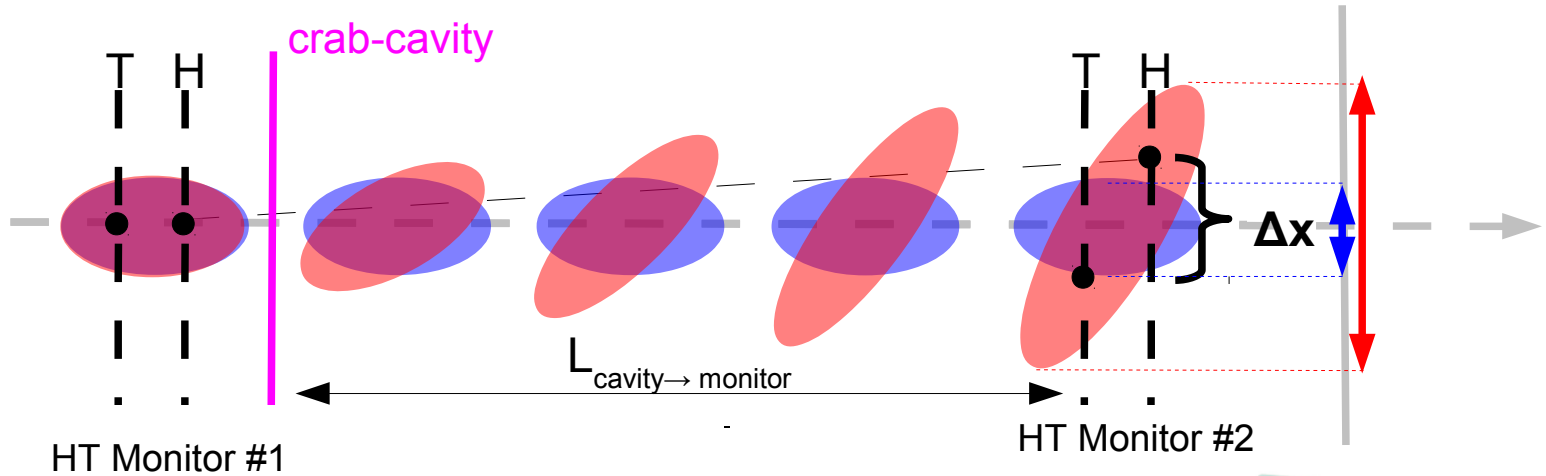

- Present standard implementation: long strip-line,  $\Sigma$ - $\Delta$  hybrid & high bandwidth to resolve bunch structure  
 Main limitations:

- Resolution: sampling limited to  $8/\sim 6.3$  ENOB  
 → limits resolution to the 100  $\mu\text{m}$  range  
 → Beam typ. lost before visible with HT
- Power issues, linearity over wide bandwidth, ...  
 limit:  $\sim 3\text{-}5$  GHz BW &  $< 40$  dB dynamic range

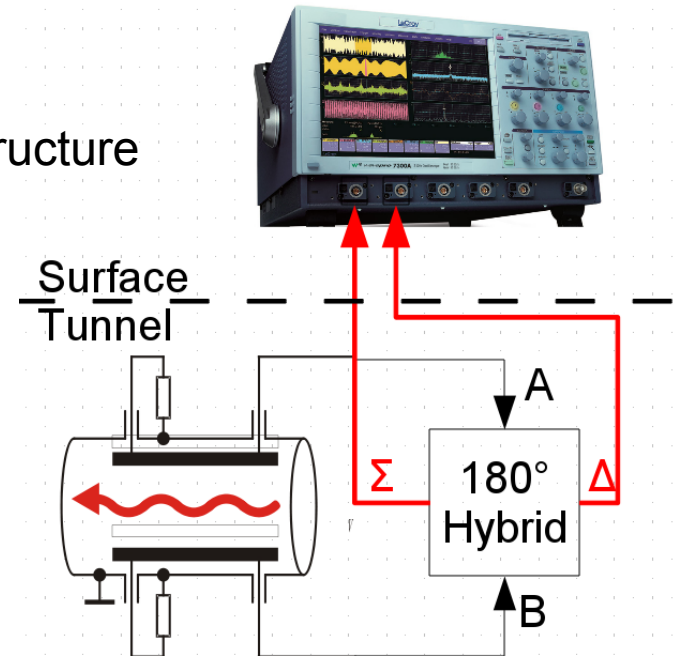

- A note on Gigabyte Sampling Buffers: The aim is not to systematically process, analyse and store the whole buffer but to allow data-mining in case of instabilities:
  - Use-case example 1: Unstable bunches or batches are not known in advance. However, the guilty ones and timing can be identified with e.g. FastBCT and other instruments after the instability occurred  
→ can be used to narrow the range of the data to be retrieved
  - Use-case example 2: instrument could be used by several users with different diagnostics indicators at the same, e.g. 'user 1' monitors few bunches over maximum number of turns while 'user 2' acquires the first 500 full turns looking for bunch-by-bunch oscillations but at a reduced sampling frequency.
  - Use-case example 3: keep specification open to allow future upgrades and R&D, i.e. present HT monitor was designed to measure Q' but not as instability monitor, larger buffer and bandwidth allowed the exploitation for other beam studies outside the scope during the design.