

Overview:

1. Introduction and overview
2. Antimatter at high energies (SppS, LEP, Fermilab)
3. Meson spectroscopy (antimatter as QCD probe)
4. Astroparticle physics and cosmology
5. CP and CPT violation tests
6. Precision tests with Antihydrogen: spectroscopy
7. Precision tests with Antihydrogen: gravity
8. Applications of antimatter

Overview:

1. Introduction and overview
2. Antimatter at high energies (SppS, LEP, Fermilab)
3. Meson spectroscopy (antimatter as QCD probe)
4. Astroparticle physics and cosmology
5. CP and CPT violation tests
6. Precision tests with Antihydrogen: spectroscopy
- 7. Precision tests with Antihydrogen: gravity**
8. Applications of antimatter

1589

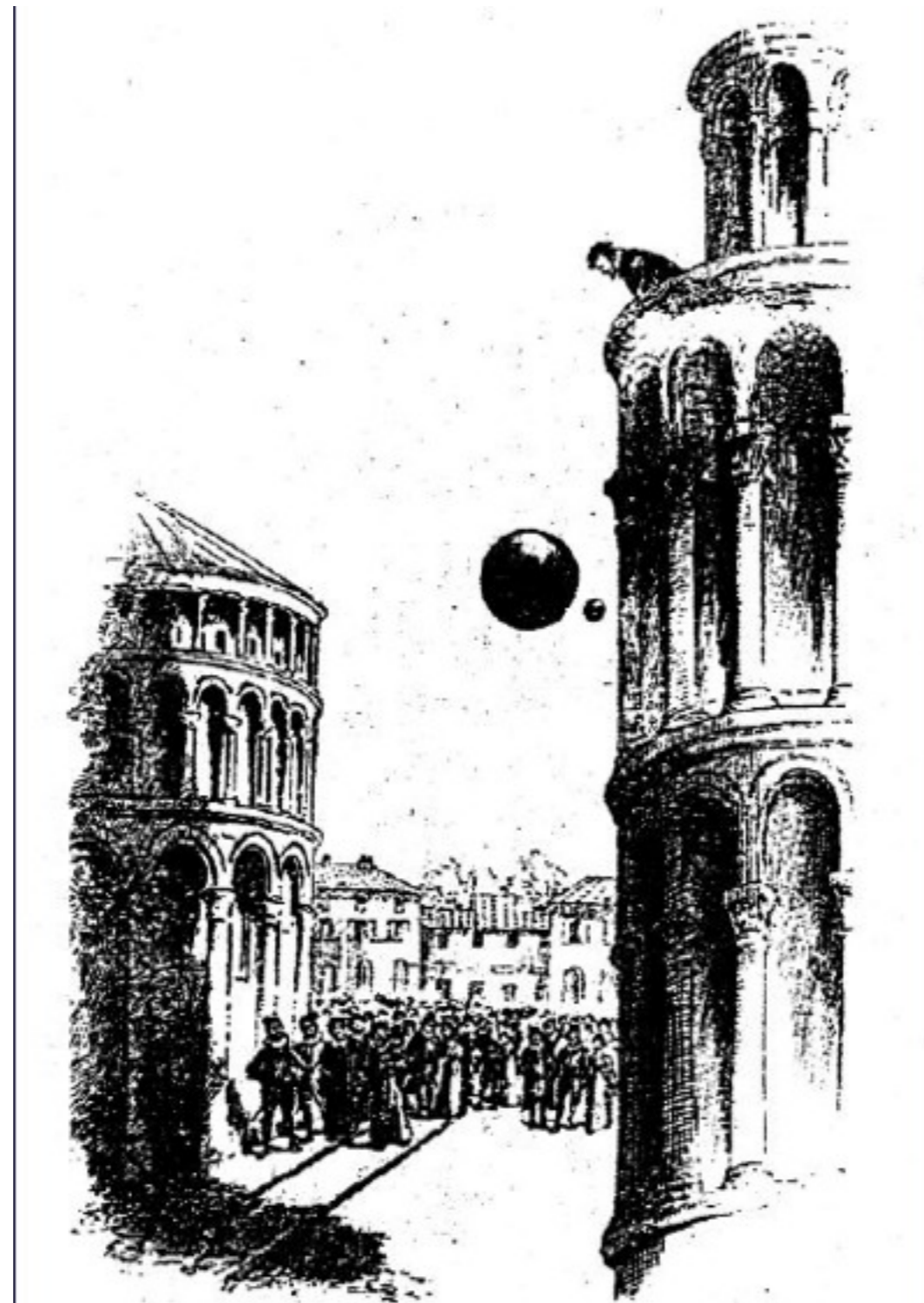

2012



Motivation

- General relativity is a classical (non quantum) theory;
- EEP violations may appear in some quantum theory
- New quantum scalar and vector fields are allowed in some models (Kaluza Klein)

Einstein field: tensor graviton (Spin 2, “Newtonian”)

+ Gravi-vector (spin 1)

+ Gravi-scalar (spin 0)

- These fields may mediate interactions violating the equivalence principle

Discussion and experimental constraints

M. Nieto and T. Goldman, Phys. Rep. 205 (1991) 221

Motivation for antigravity in General Relativity

G. Chardin, Hyperfine Interactions 109 (1997) 83

Scalar: “charge” of particle equal to “charge of antiparticle” : **attractive force**

Vector: “charge” of particle opposite to “charge of antiparticle”: **repulsive/attractive force**

$$V = - \frac{G_{\infty}}{r} m_1 m_2 \left(1 \mp a e^{-r/v} + b e^{-r/s} \right) \quad \text{Phys. Rev. D 33 (2475) (1986)}$$

Cancellation effects in matter experiment if $a \approx b$ and $v \approx s$

AEgIS: Antihydrogen Experiment: Gravity, Interferometry, Spectroscopy

Tests of gravity require very cold trapped \bar{H} or a pulsed cold beam of \bar{H}

$$G \sim 100 \text{ nV/m on } \bar{p}$$

Experimental goal: g measurement with 1% accuracy on antihydrogen

(first direct measurement on antimatter)

a) production of a pulsed cold beam of antihydrogen ($T \sim 0.1 \text{ K}$)

b) measurement of the beam deflection with a Moiré deflectometer

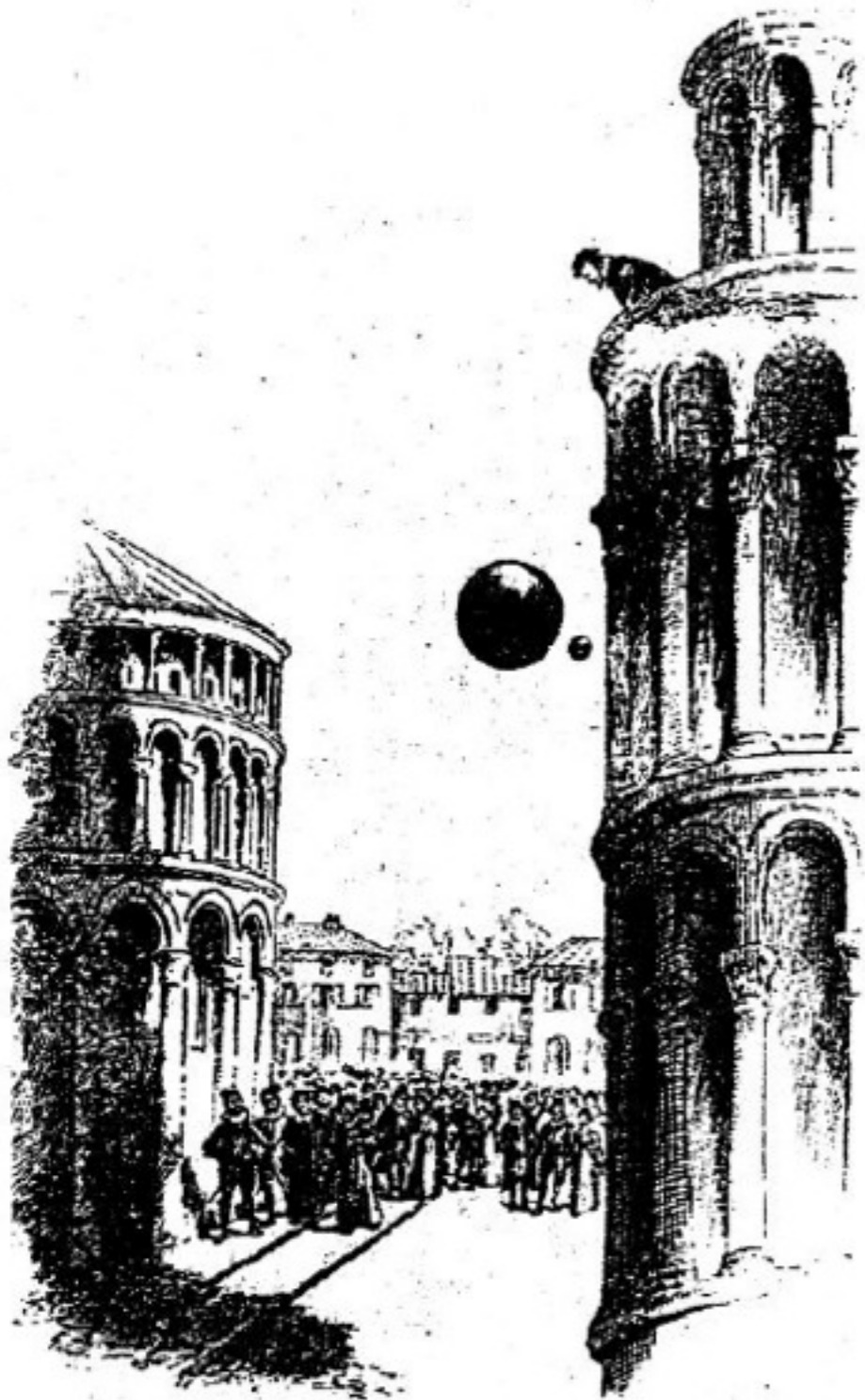

Schematic: i) antihydrogen formation

- Charge exchange reaction:

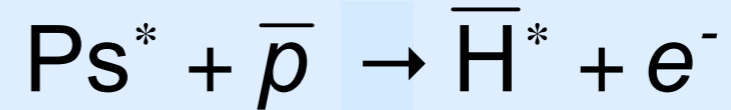
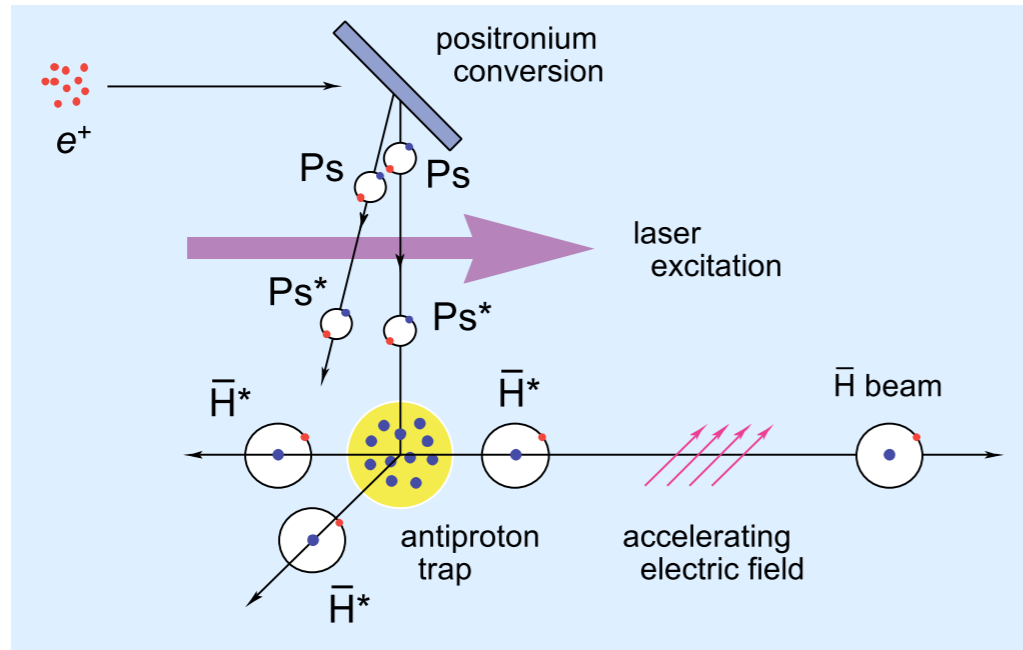

Works well at temperatures from 0–10 K

- Principle demonstrated by ATRAP ($Cs^* \rightarrow Ps^* \rightarrow \bar{H}^*$)

[C. H. Storry *et al.*, Phys. Rev. Lett. **93** (2004) 263401]

- Advantages:

- Large cross-section $\sigma = a_0 n^4$
- Narrow and well-defined \bar{H} n -state distribution
- \bar{H} production from \bar{p} at rest \rightarrow ultracold \bar{H}

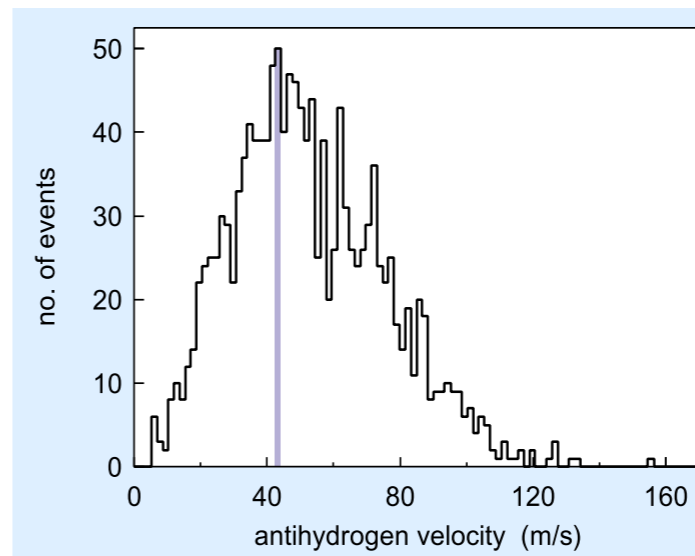

At $T(p) = 100\text{mK}$,
 $n(Ps) = 35$
 $\Rightarrow v(H) \approx 45 \text{ m/s}$
 $T(H) \approx 120\text{mK}$

Schematic: ii) beam formation

- Neutral atoms are not sensitive to static electric and magnetic fields
- Electric field gradients exert force on electric dipoles:

$$E = -\frac{1}{2n^2} + \frac{3}{2}nkF$$

$$Force = -\frac{3}{2}nk\vec{\nabla}F$$

⇒ Rydberg atoms are very sensitive to inhomogeneous electric fields

- Stark deceleration of hydrogen demonstrated

[E. Vliegen & F. Merkt, J. Phys. B **39** (2006) L241 - ETH Physical Chemistry]

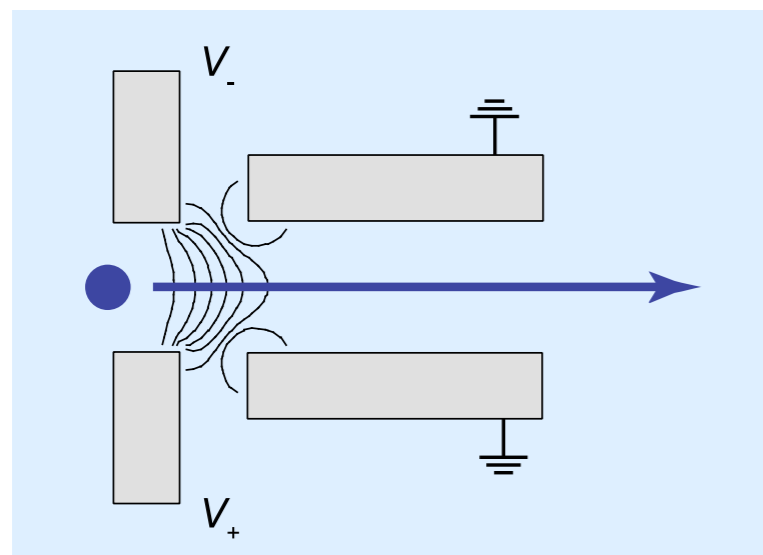

Lectures on Antimatter

- $n = 22, 23, 24$
- Accelerations of up to $2 \times 10^8 \text{ m/s}^2$ achieved
- Hydrogen beam at 700 m/s can be stopped in $5 \mu\text{s}$ over only 1.8 mm

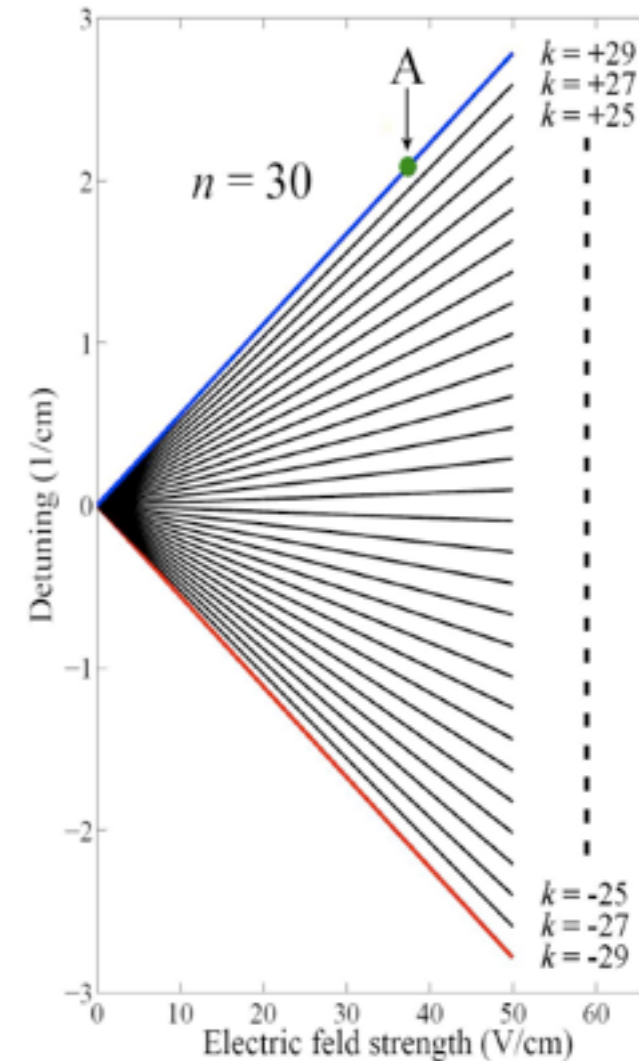

Schematic: iii) trajectory measurement

- Classical counterpart of the Mach-Zehnder interferometer
 - Decoherence effects reduced
 - “Self-focusing” effect – beam collimation uncritical

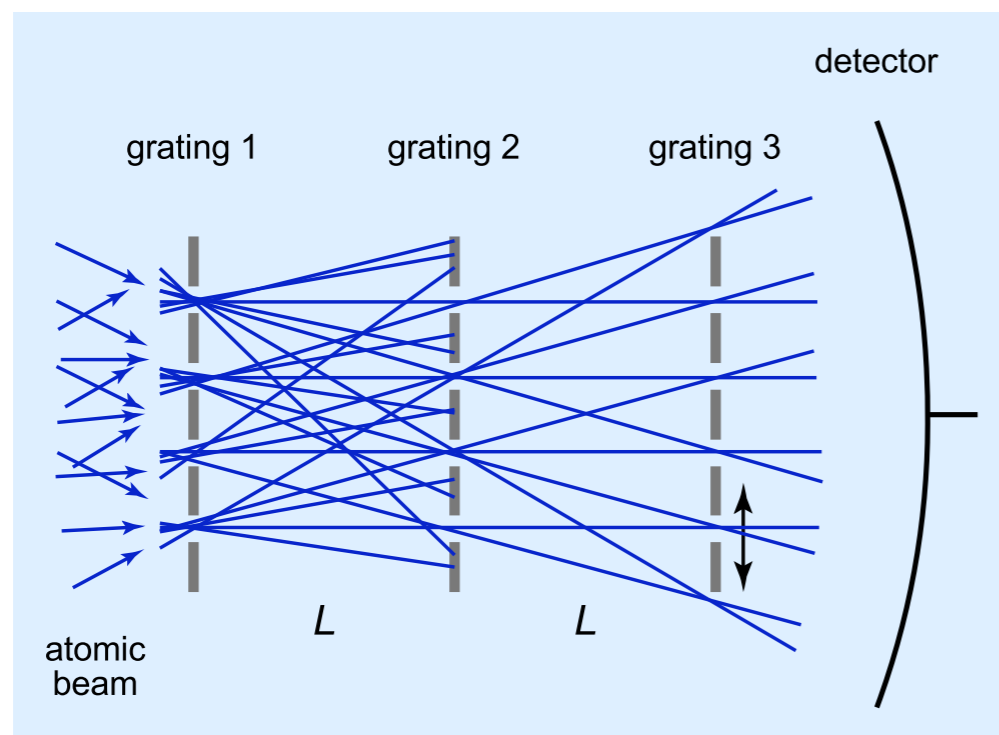

Fringe phase and phase shift identical to Mach-Zehnder interferometer!

- Replace the third grating and detector by position-sensitive detector
 - ⇒ Transmission increases by \sim factor 3
- Has been successfully used for a gravity measurement with ordinary matter, $\sigma(g)/g = 2 \times 10^{-4}$
[M. K. Oberthaler *et al.*, Phys. Rev. A **54** (1996) 3165]

Schematic: iii) trajectory measurement

- Classical counterpart of the Mach-Zehnder interferometer
 - Decoherence effects reduced
 - “Self-focusing” effect – beam collimation uncritical

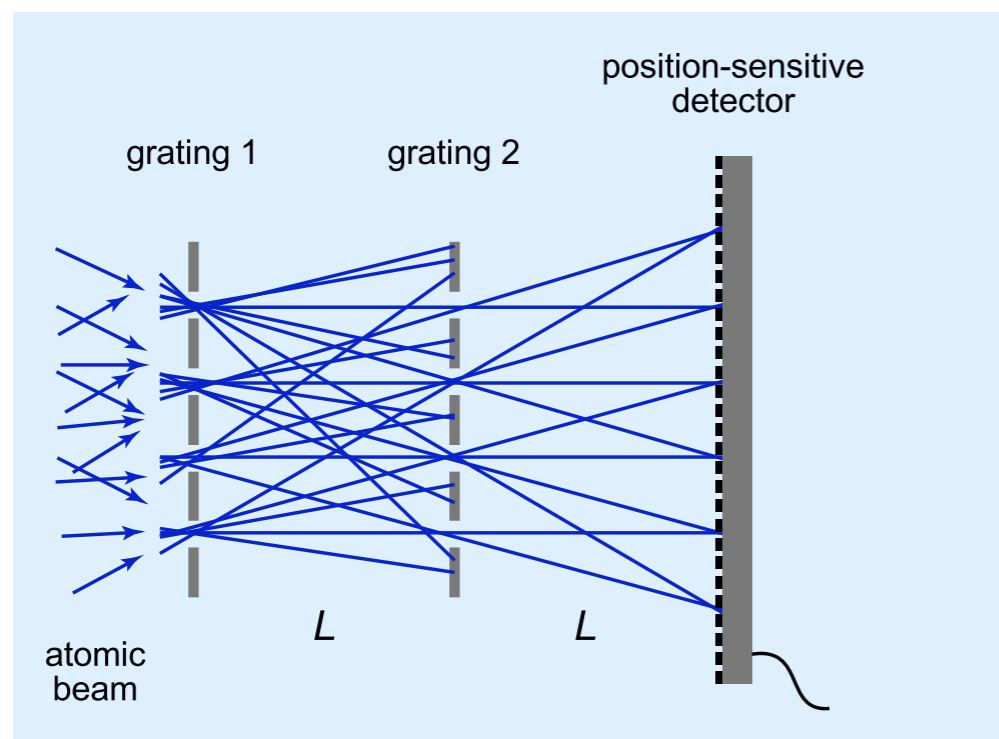

Fringe phase and phase shift identical to Mach-Zehnder interferometer!

- Replace the third grating and detector by position-sensitive detector
 - ⇒ Transmission increases by \sim factor 3
- Has been successfully used for a gravity measurement with ordinary matter, $\sigma(g)/g = 2 \times 10^{-4}$
[M. K. Oberthaler *et al.*, Phys. Rev. A **54** (1996) 3165]

Moiré deflectometer: principle of operation

1) No gravity, very high statistics

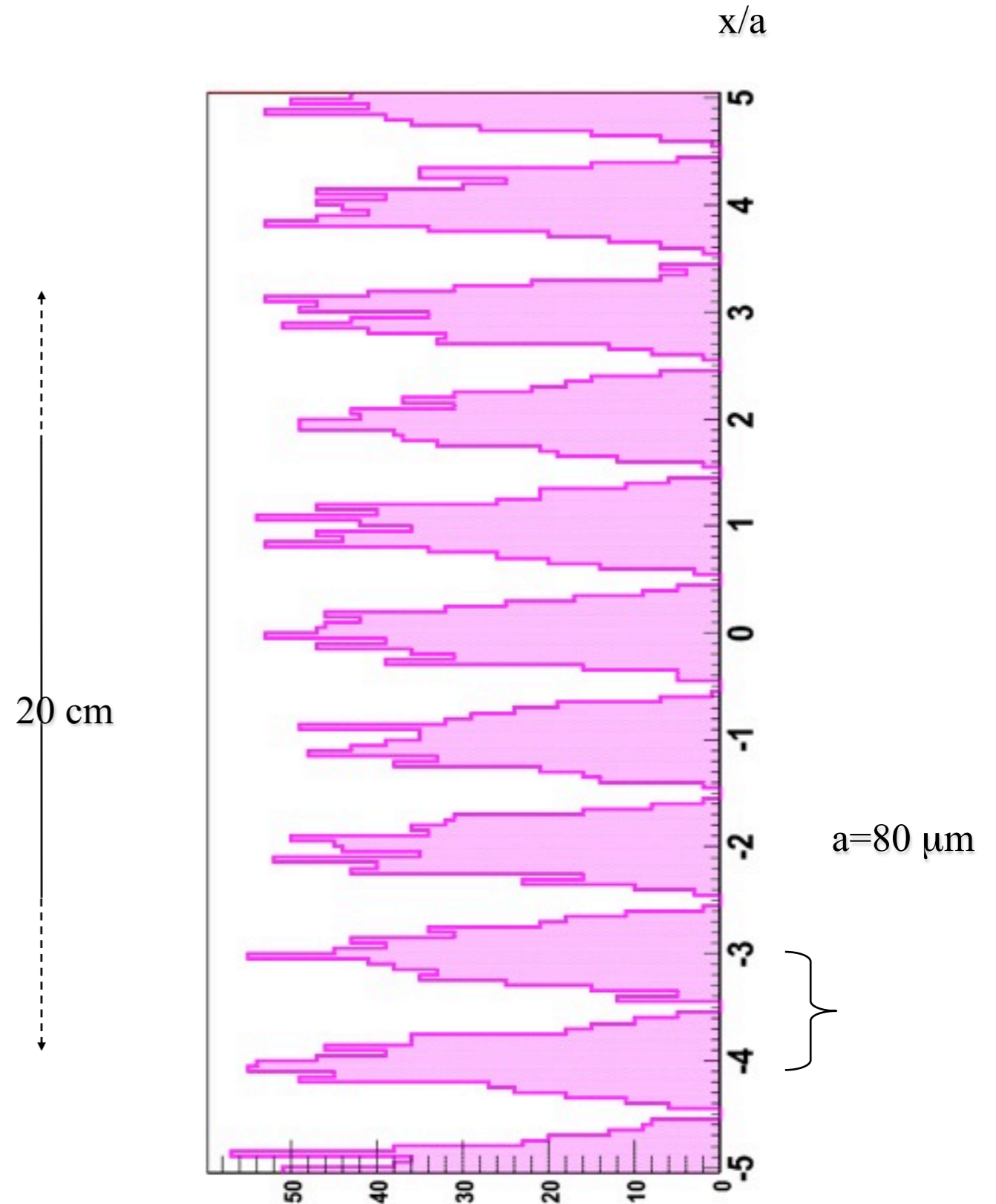
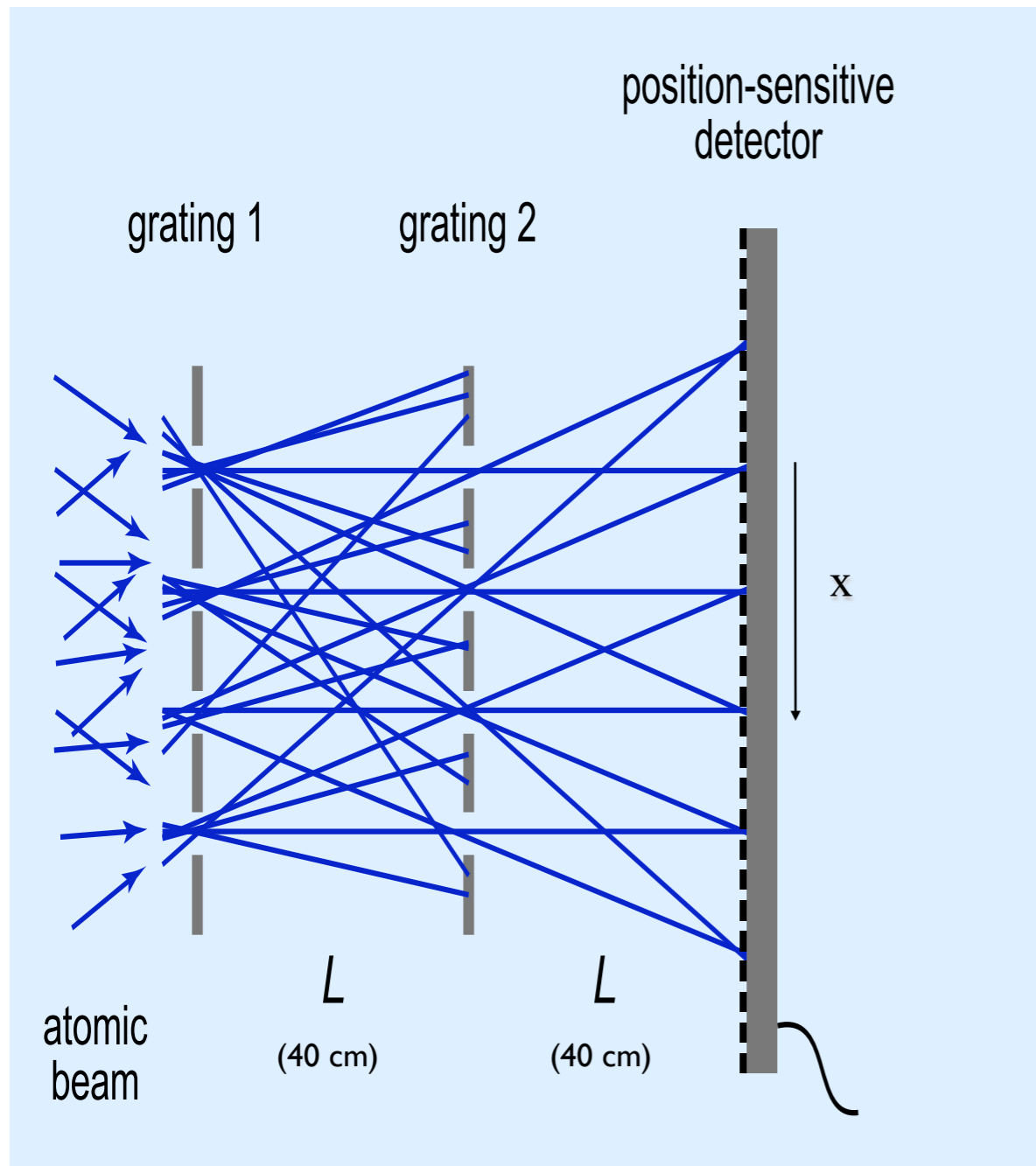

$V_h = 600 \text{ m/s}$

With gravity

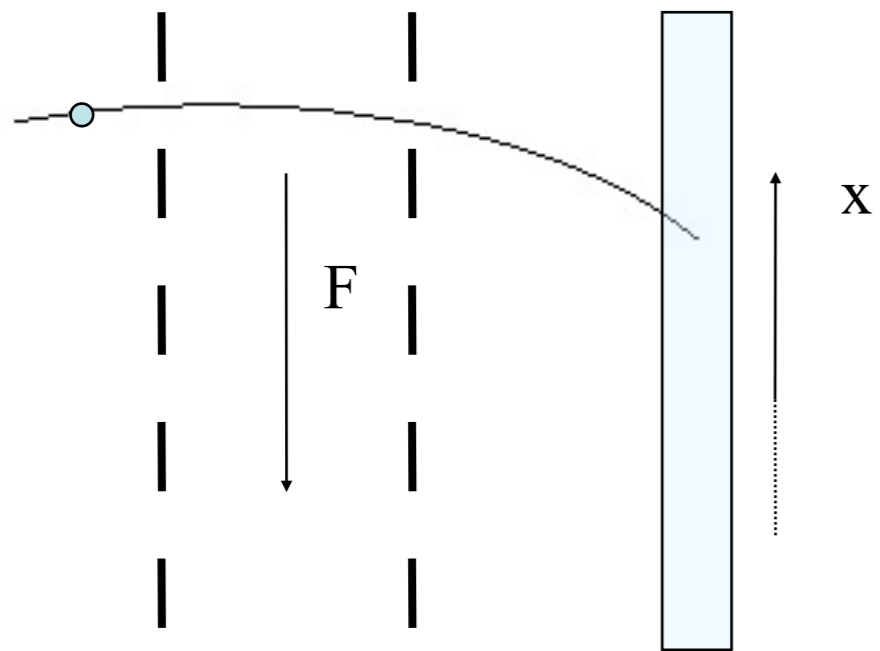

Grating
units

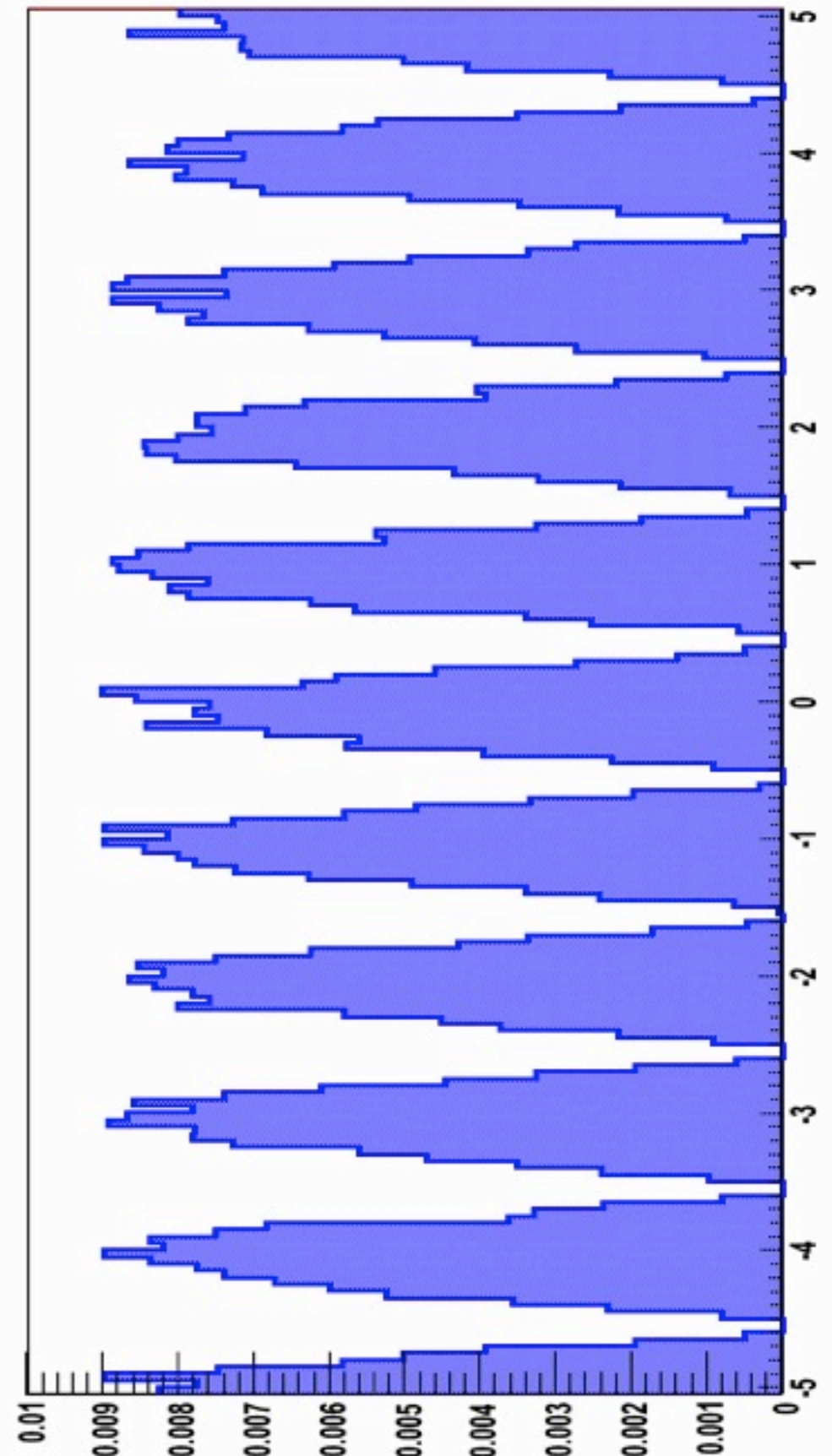

With gravity

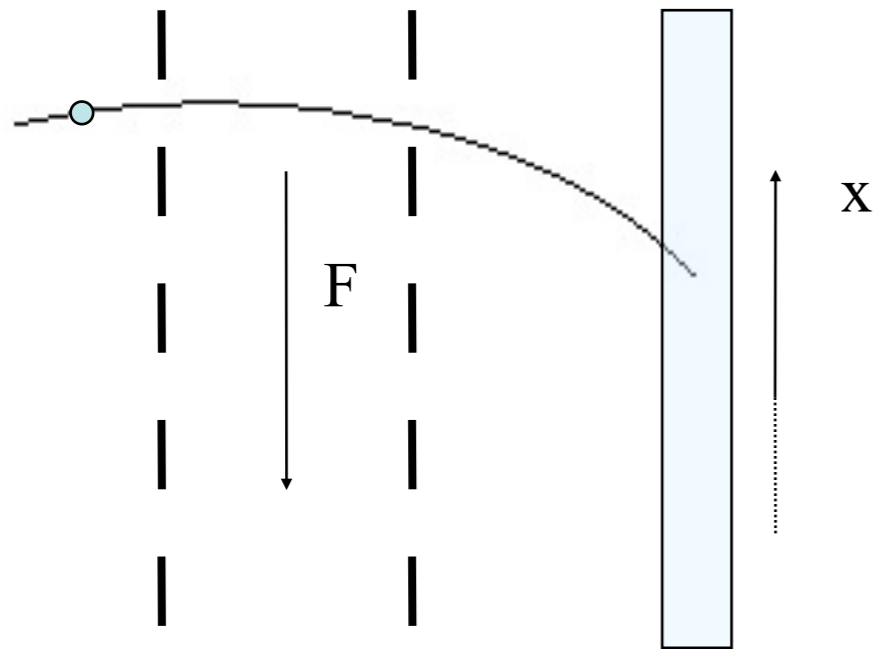

slight shift ($\sim 10 \mu\text{m}$)

Grating units

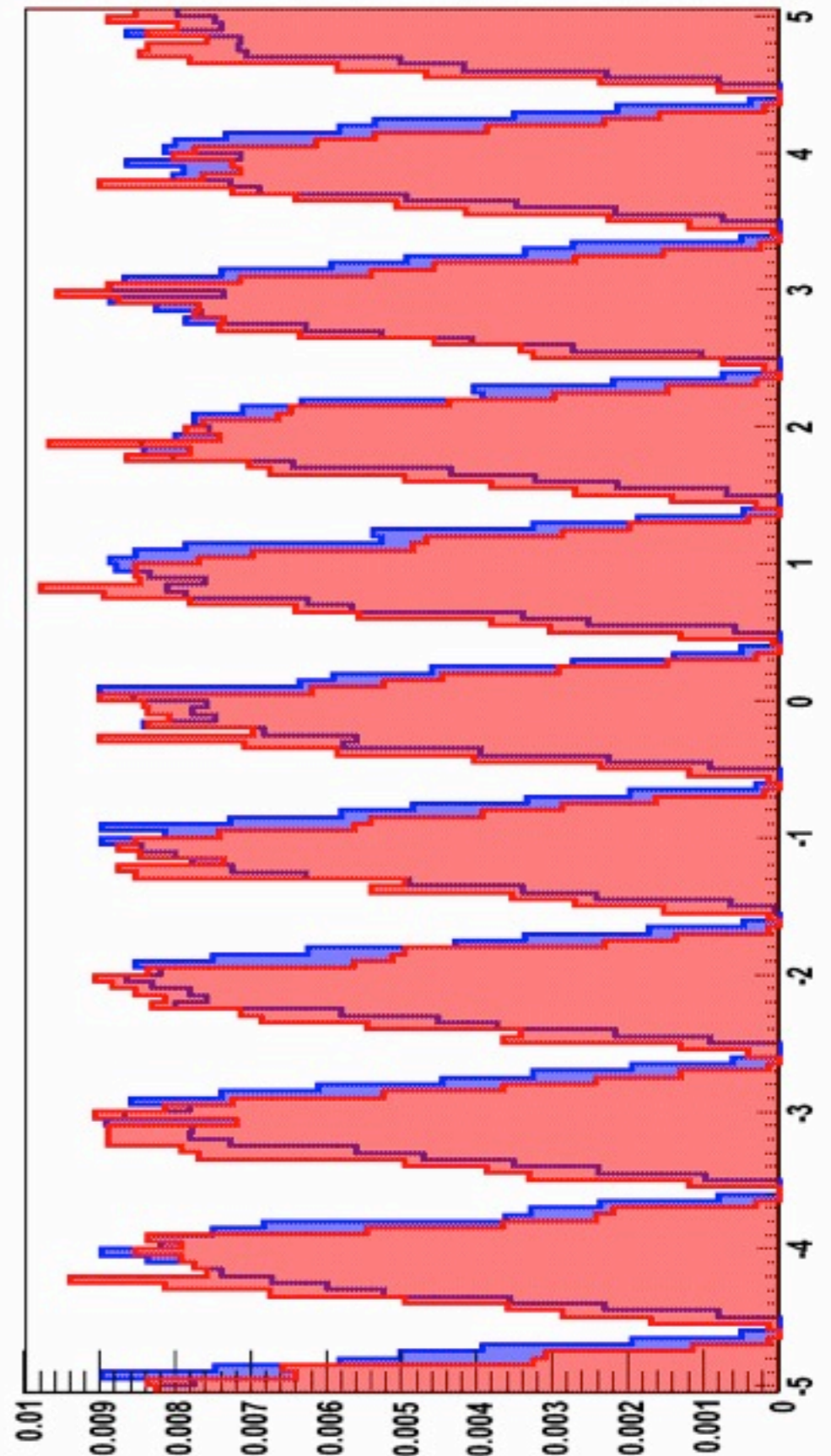

$V_h = 600$ m/s

$V_h = 400$ m/s

measure impact point to ($\leq 10 \mu\text{m}$)

solution 1: Si strip detectors ($\sim 10 \mu\text{m}$?)

solution 2: photographic emulsion ($\leq 1 \mu\text{m}$?)

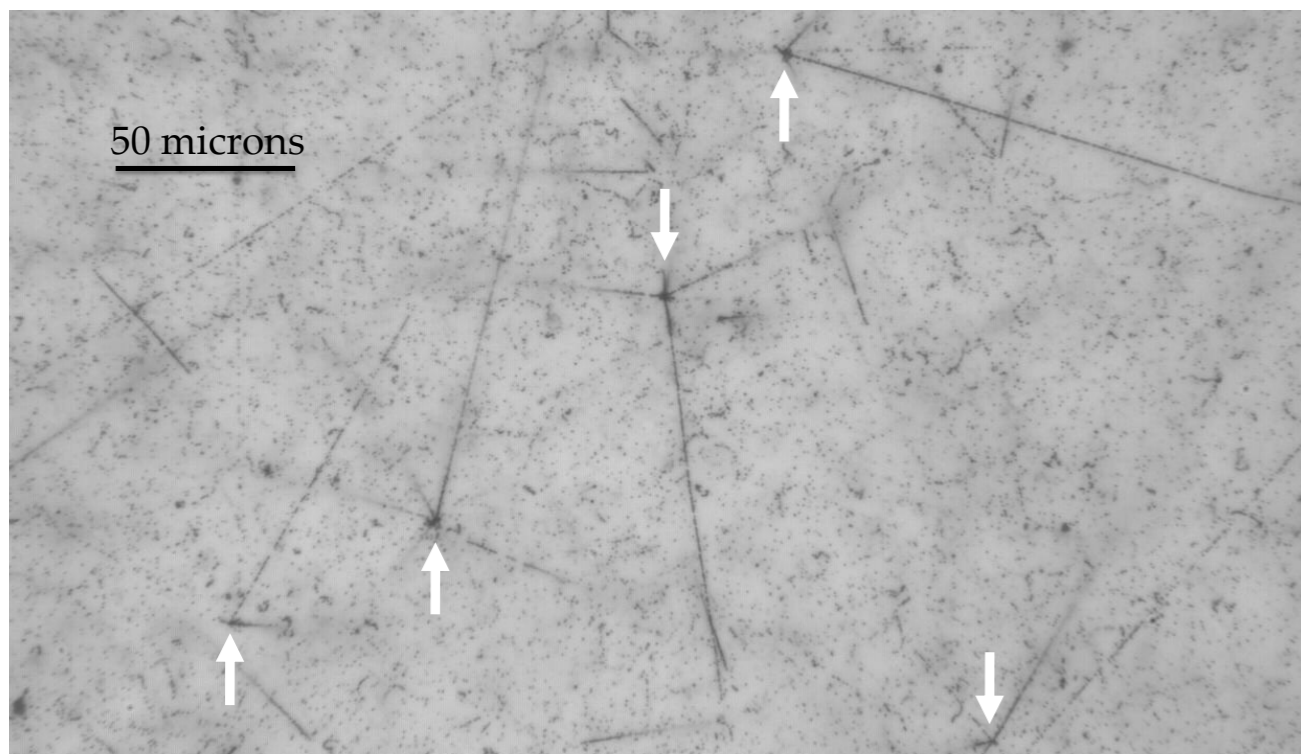

Grating
units

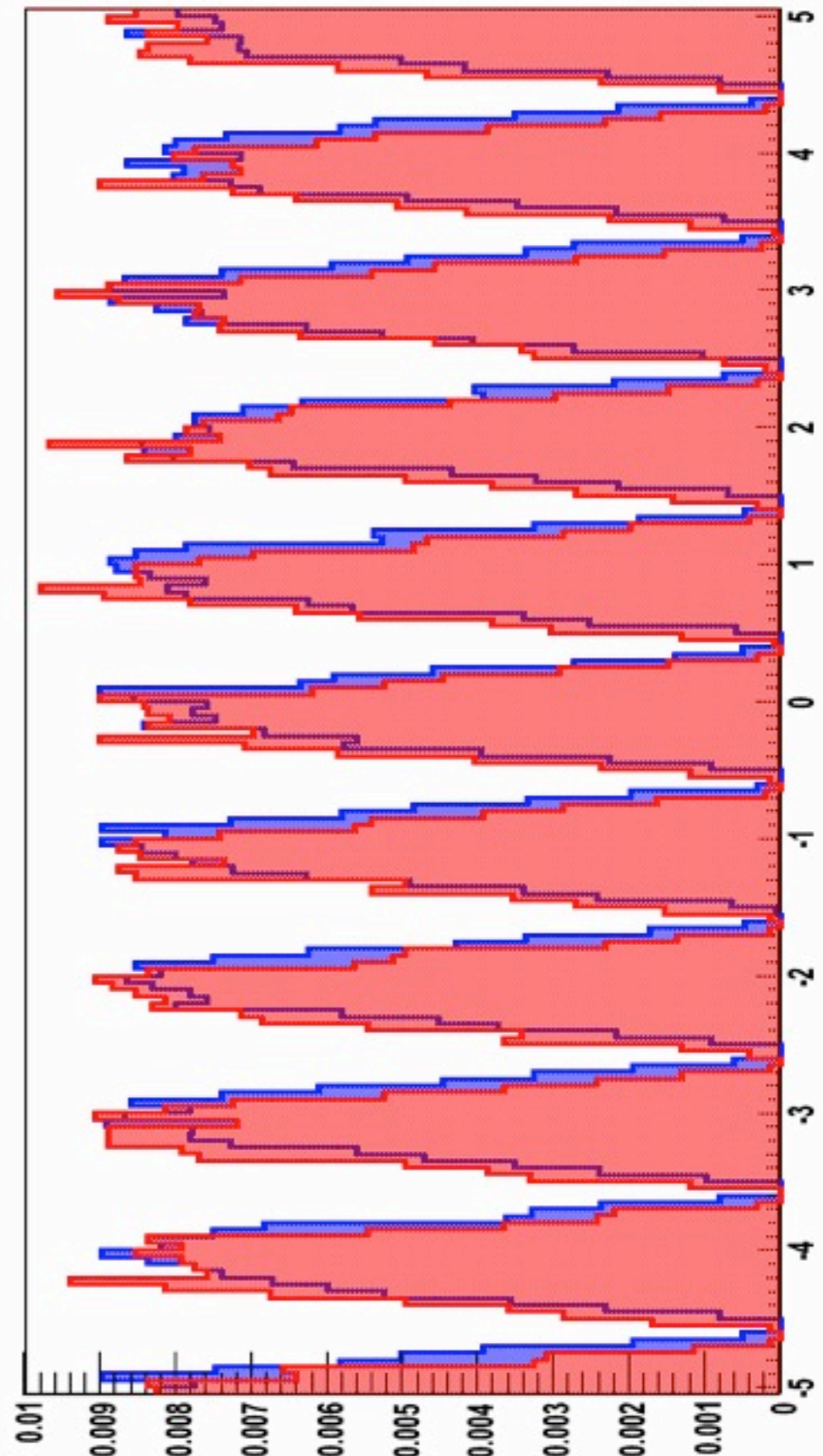

detection of the \bar{H} annihilation vertex

detection of the \bar{H} annihilation vertex

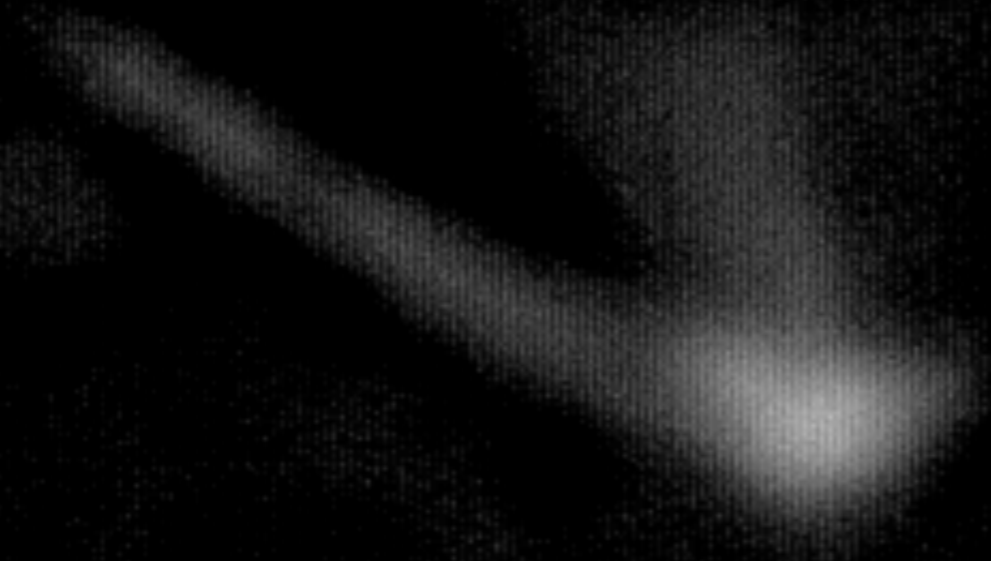

detection of the \bar{H} annihilation vertex

detection of the \bar{H} annihilation vertex

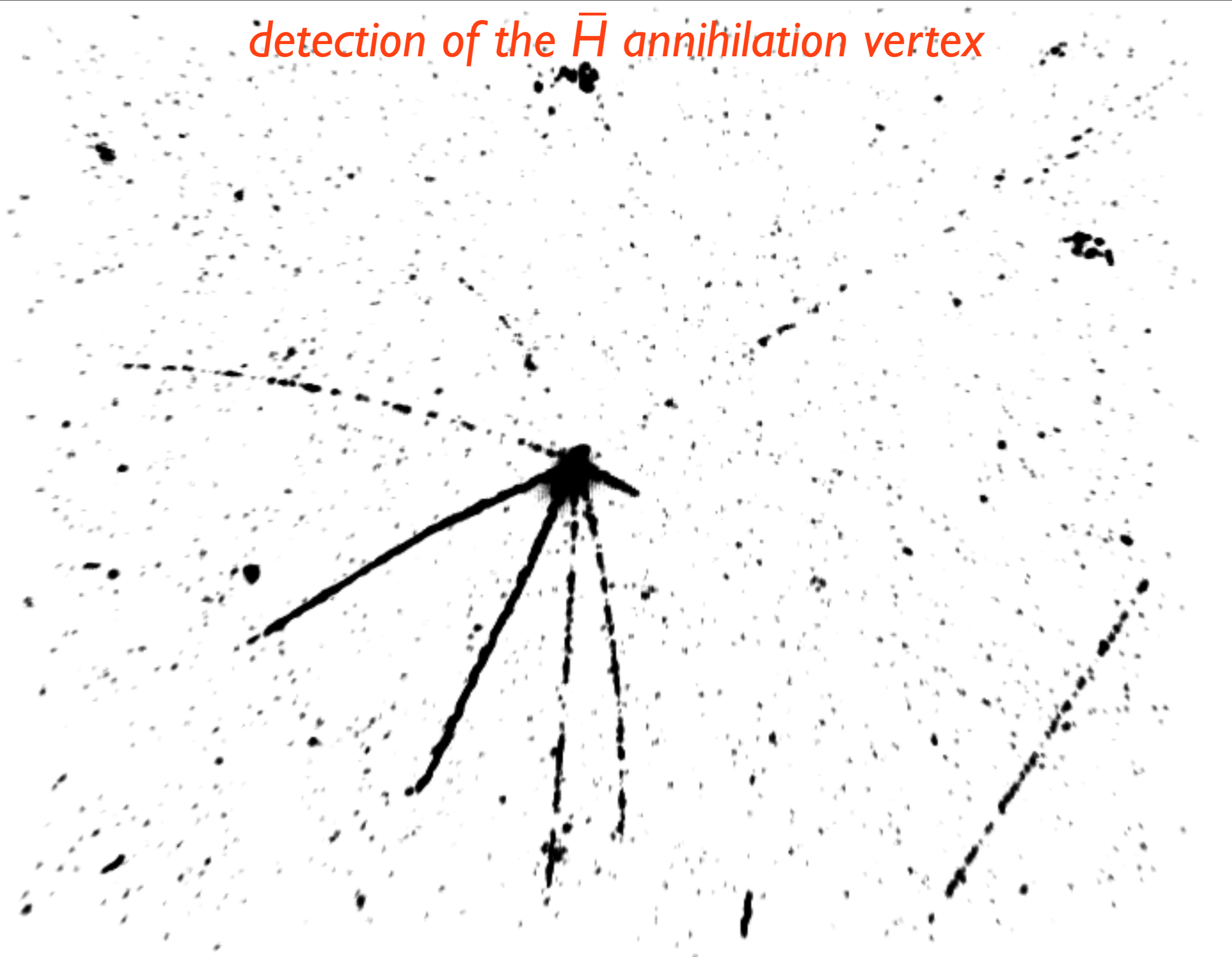

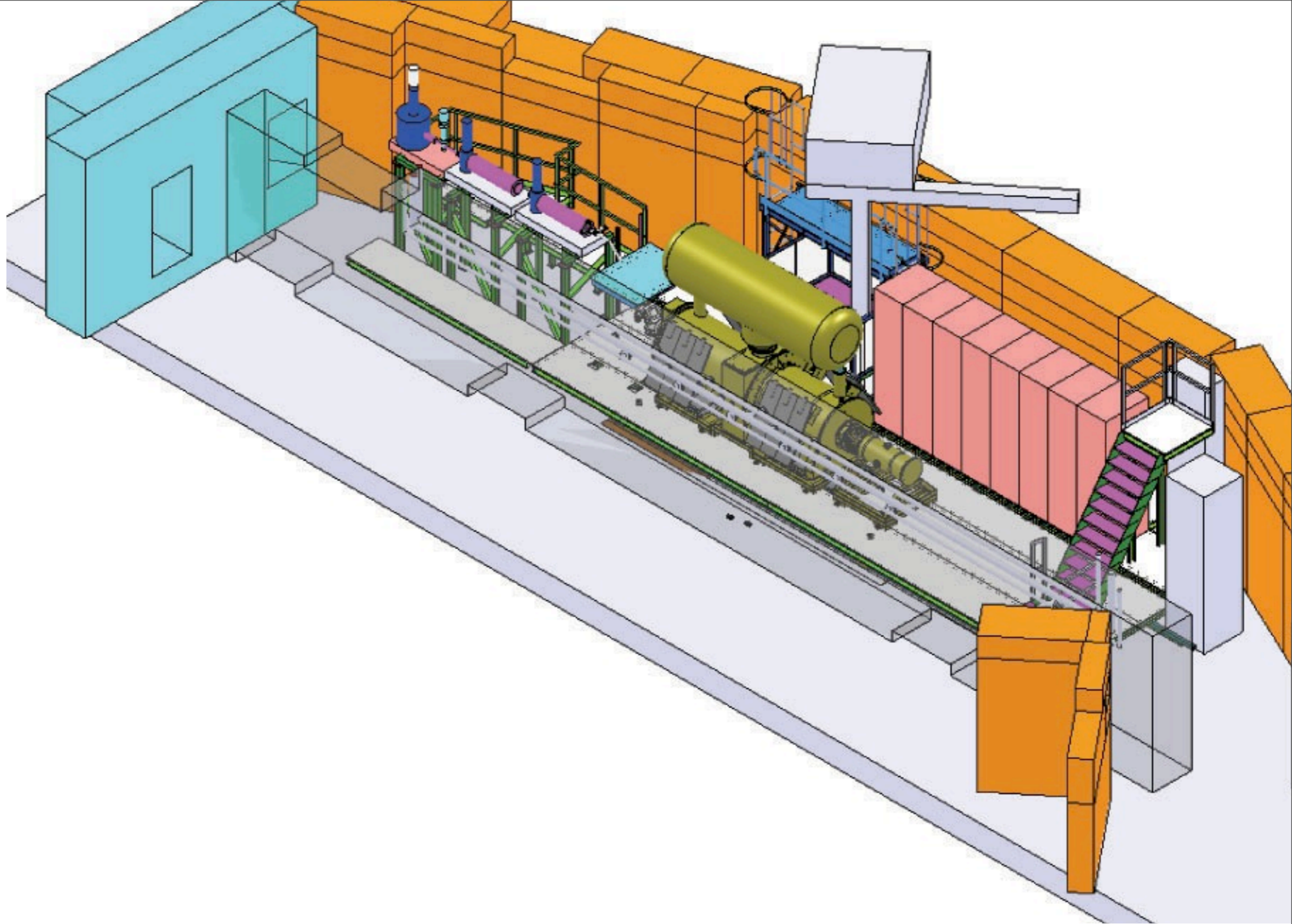

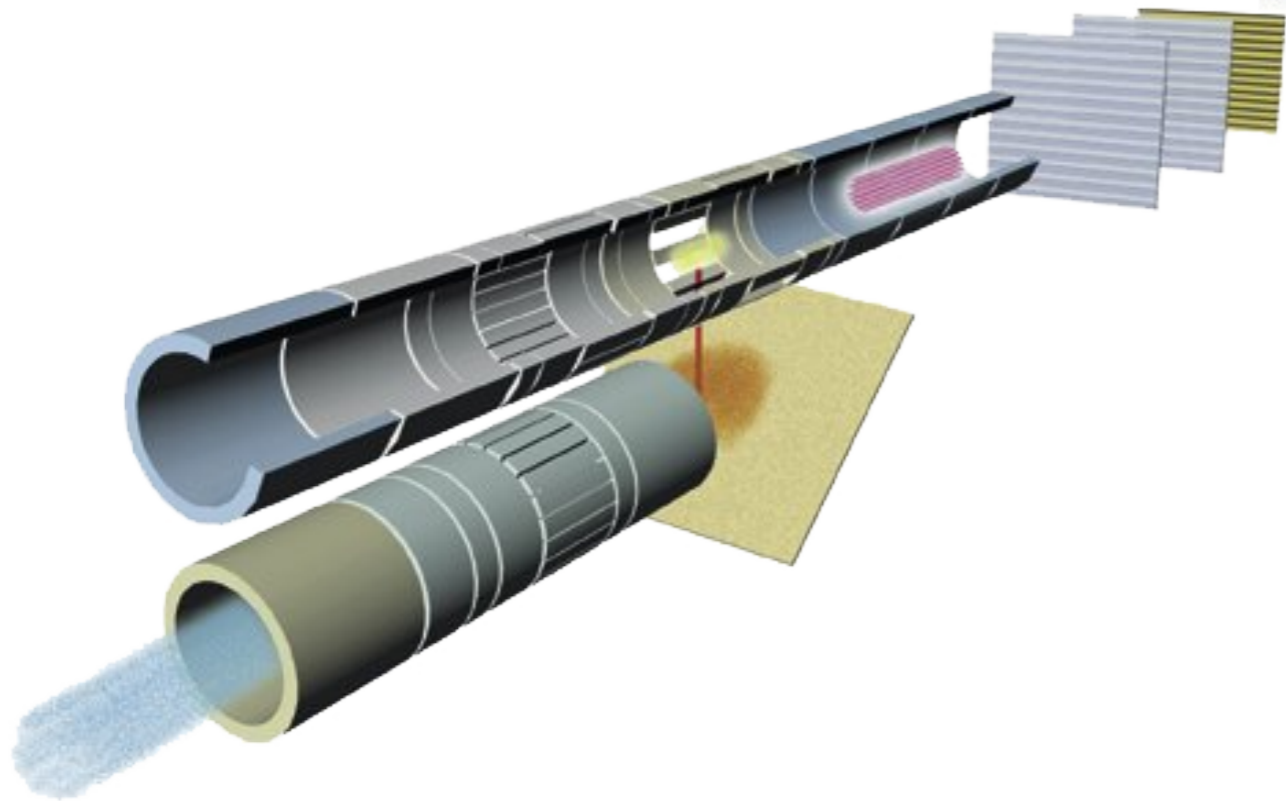
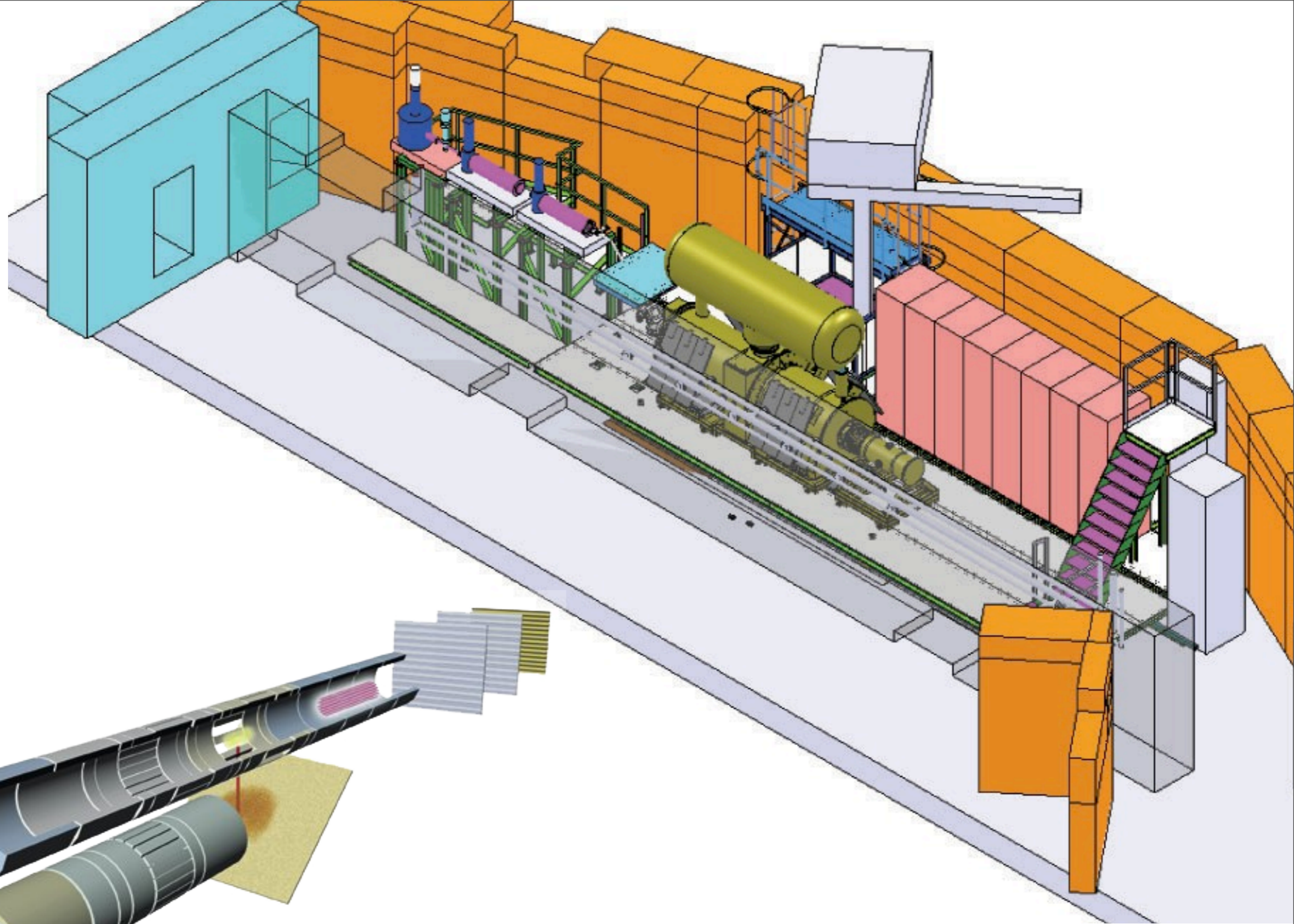

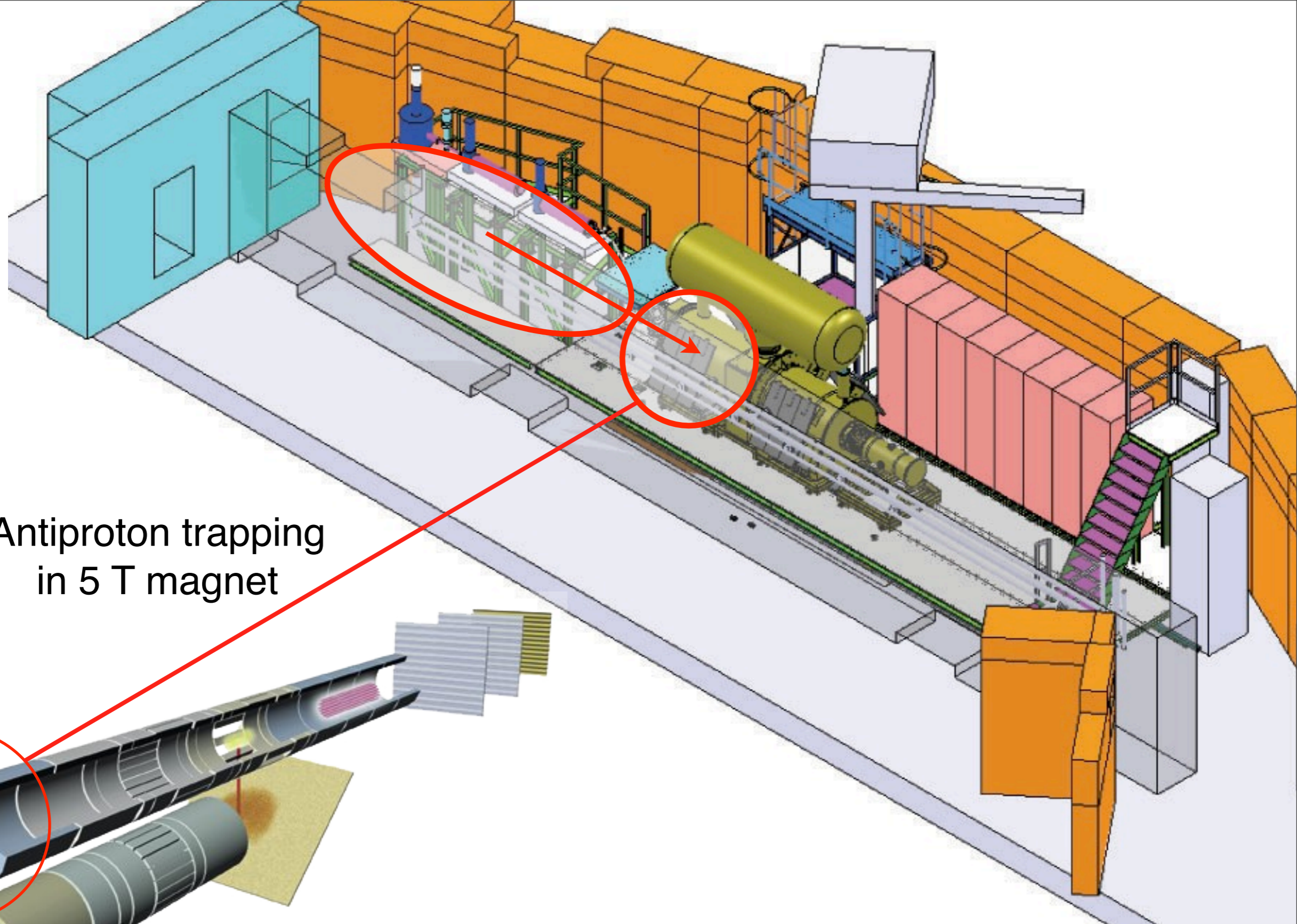

Antiproton trapping
in 5 T magnet

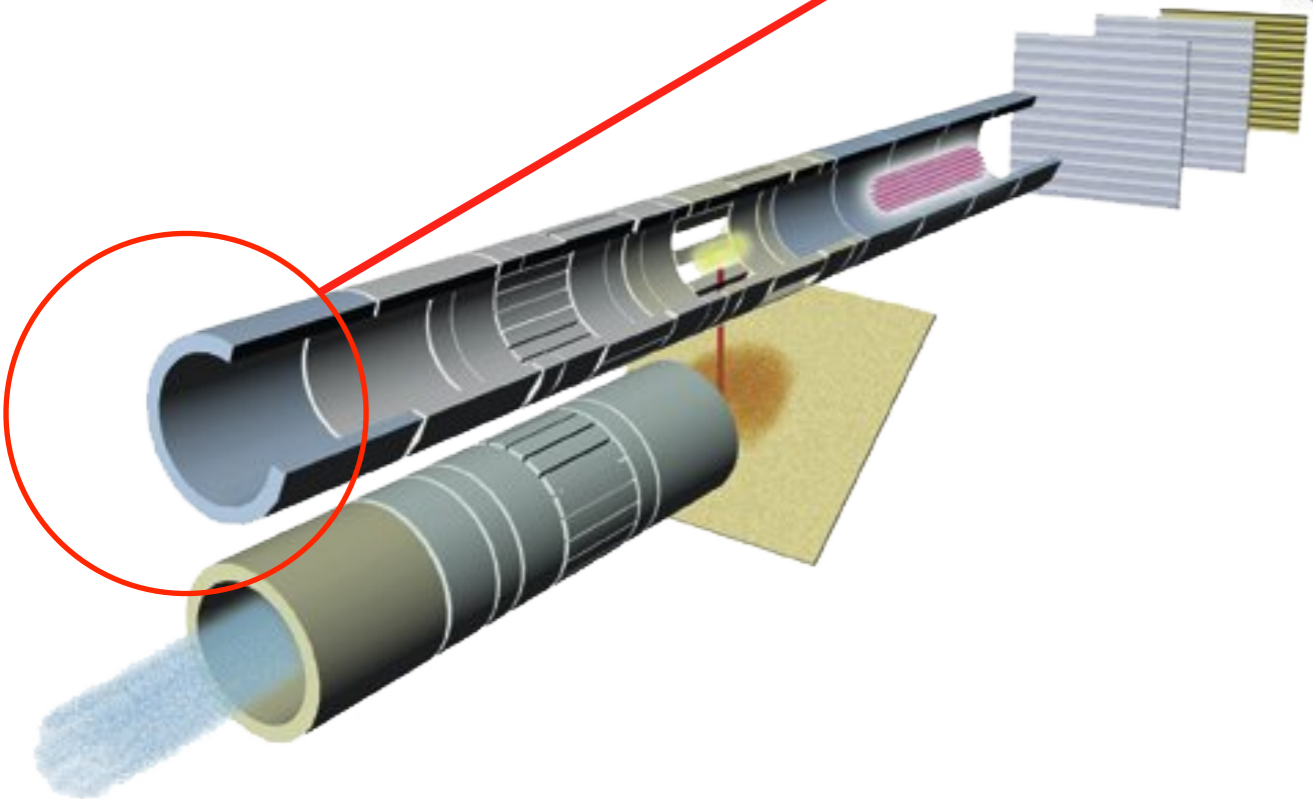

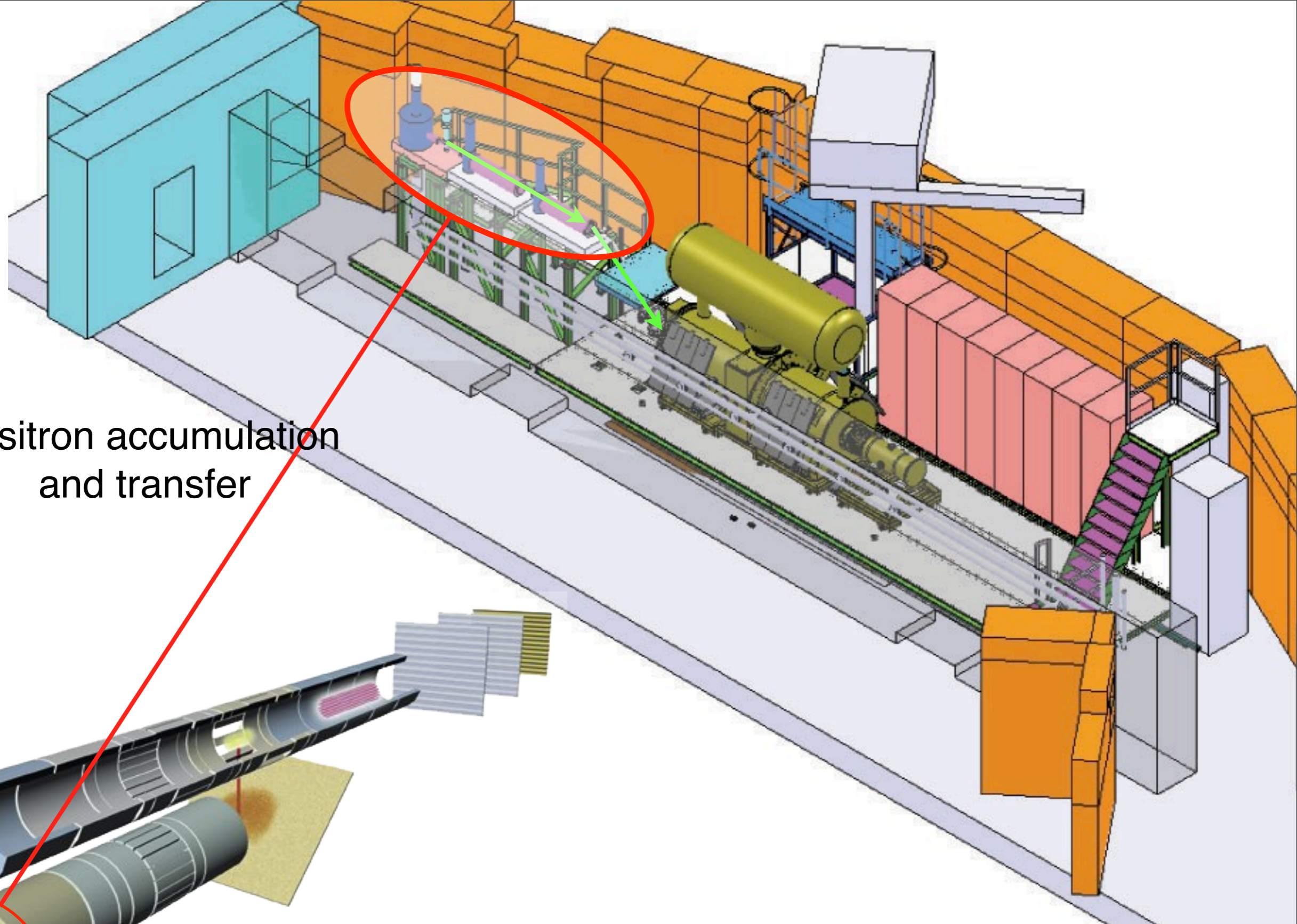

Positron accumulation
and transfer

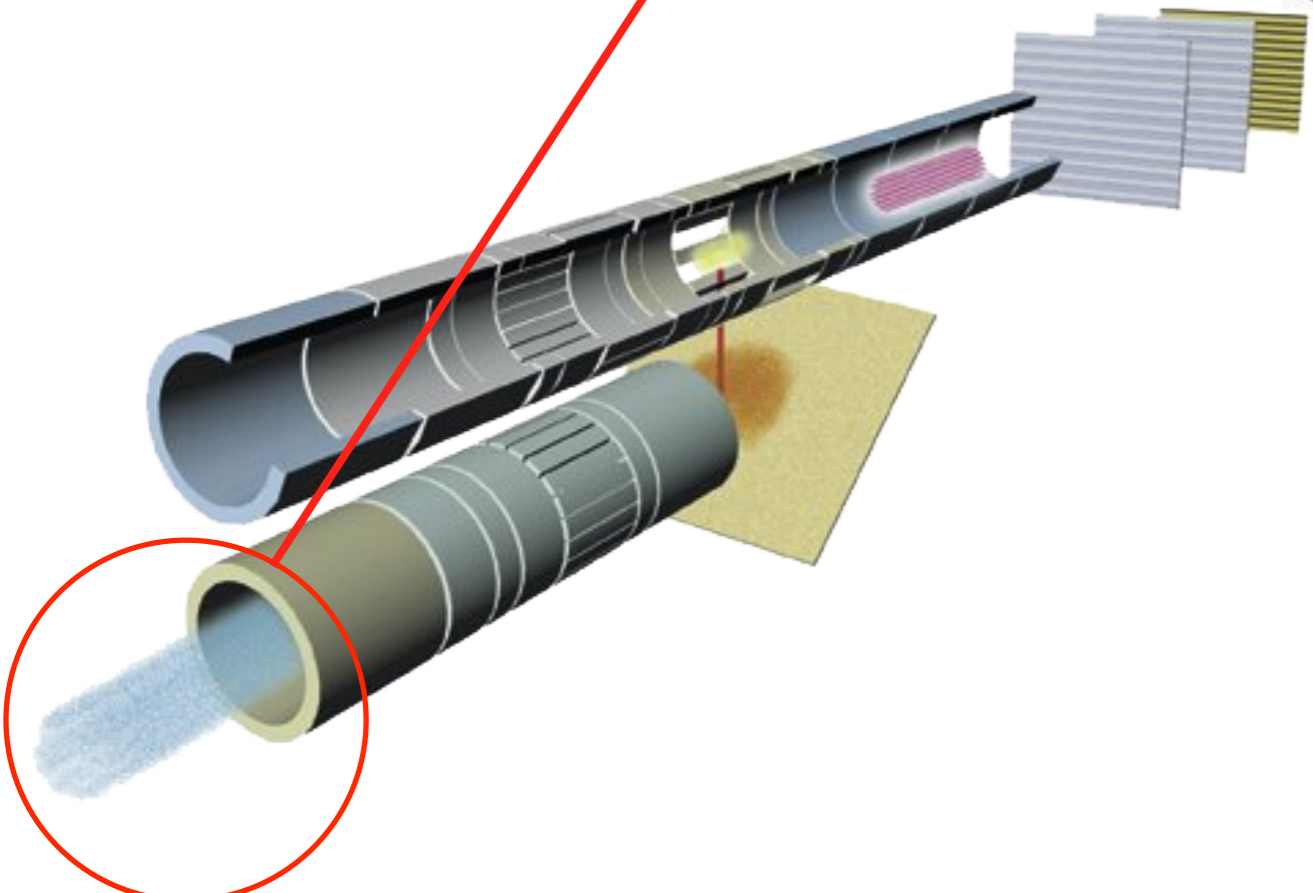

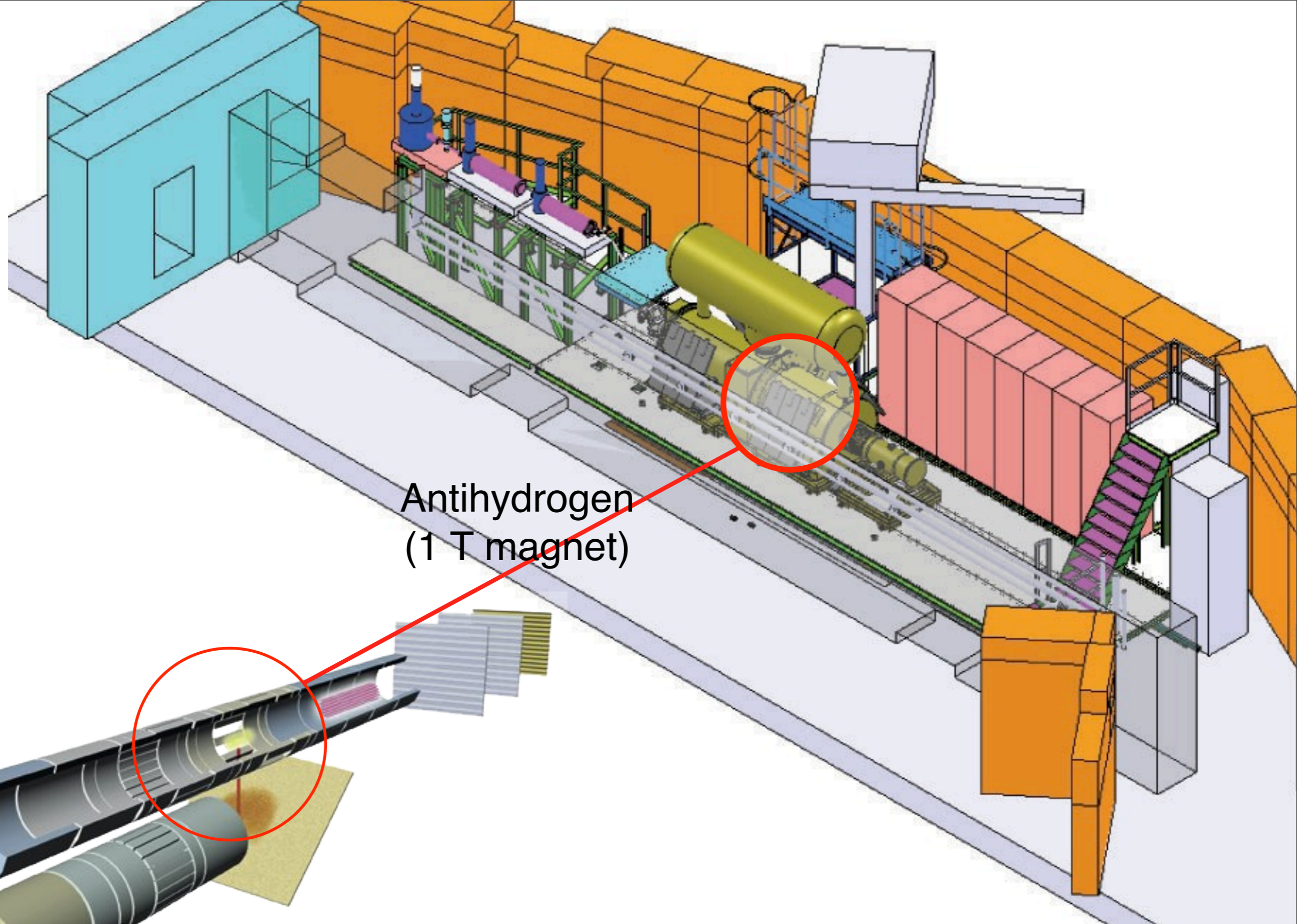

Antihydrogen
(1 T magnet)

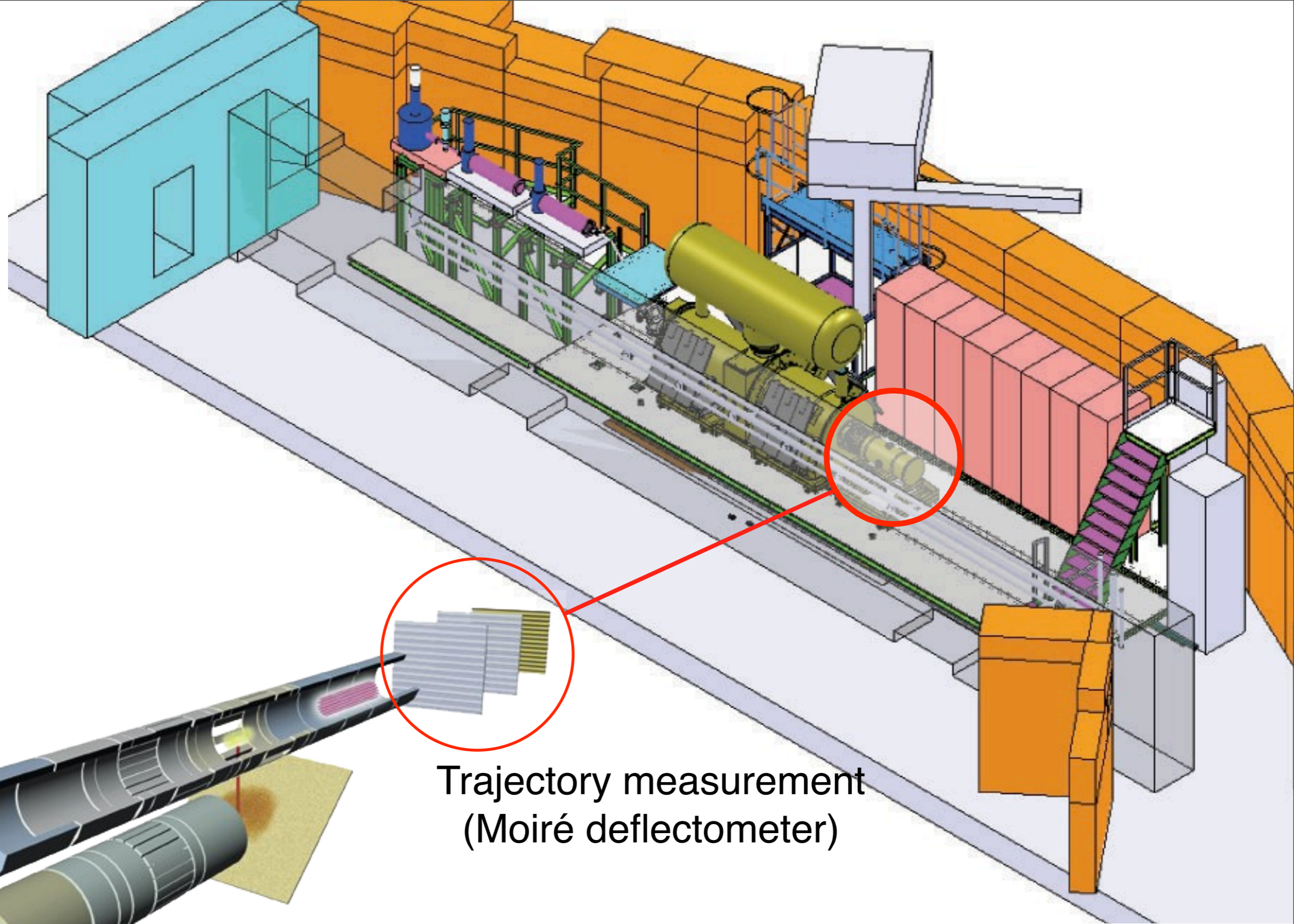

Trajectory measurement
(Moiré deflectometer)

Timeline:

2012: AEGIS assembly, tests with H production

2013: no antiprotons! tests with H production

2014: antiprotons only late in year: H (and then \bar{H})
beam production, first measurements?

2015: gravity measurement & \bar{H} spectroscopy

2016: gravity measurement & \bar{H} spectroscopy

2017: ELENA starts up: GBAR enters the game

(meanwhile, of course, ALPHA, ATRAP, ASACUSA are very active....)

new (de)celerator in 2017: ELENA

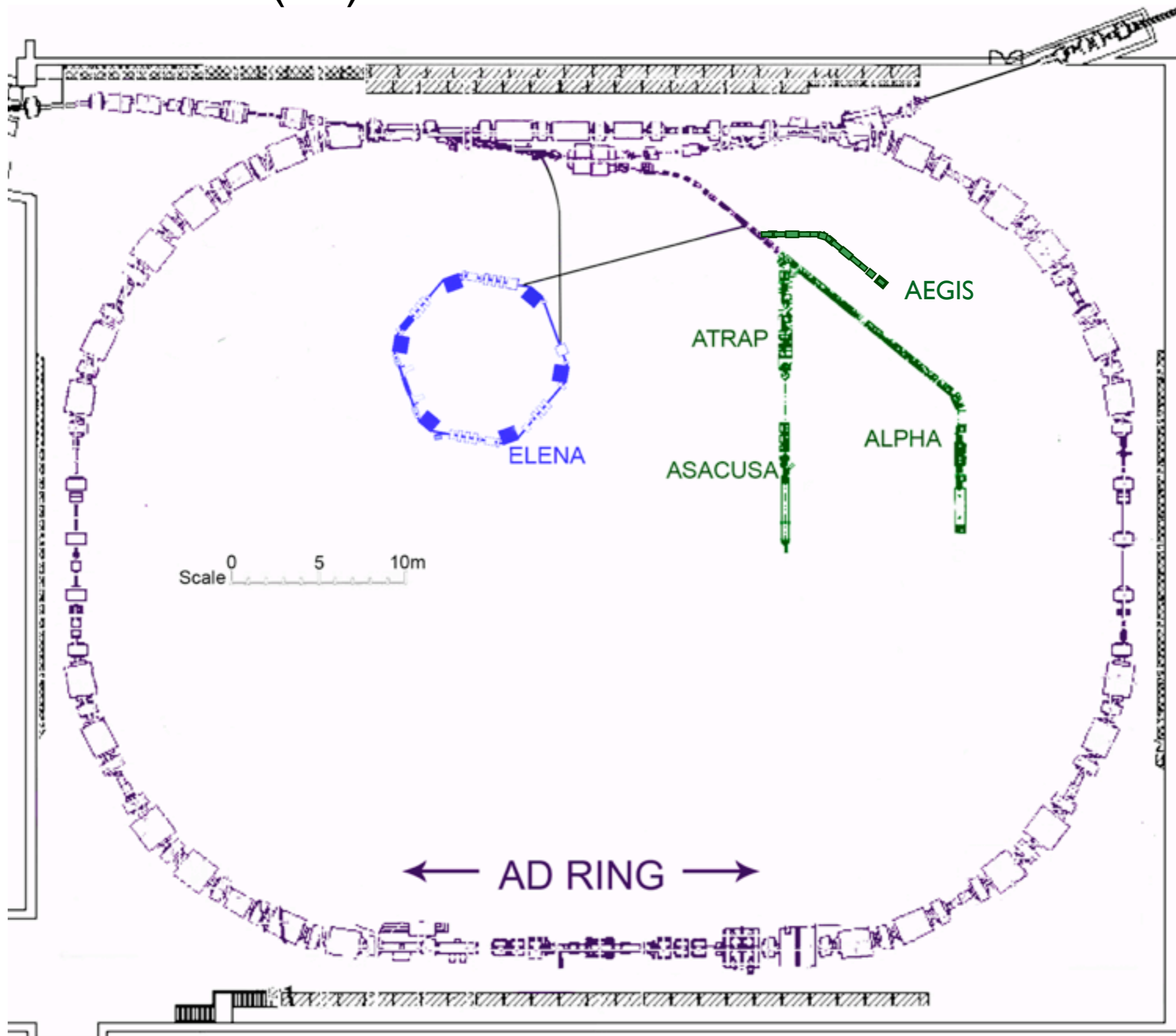

new (de)celerator in 2017: ELENA

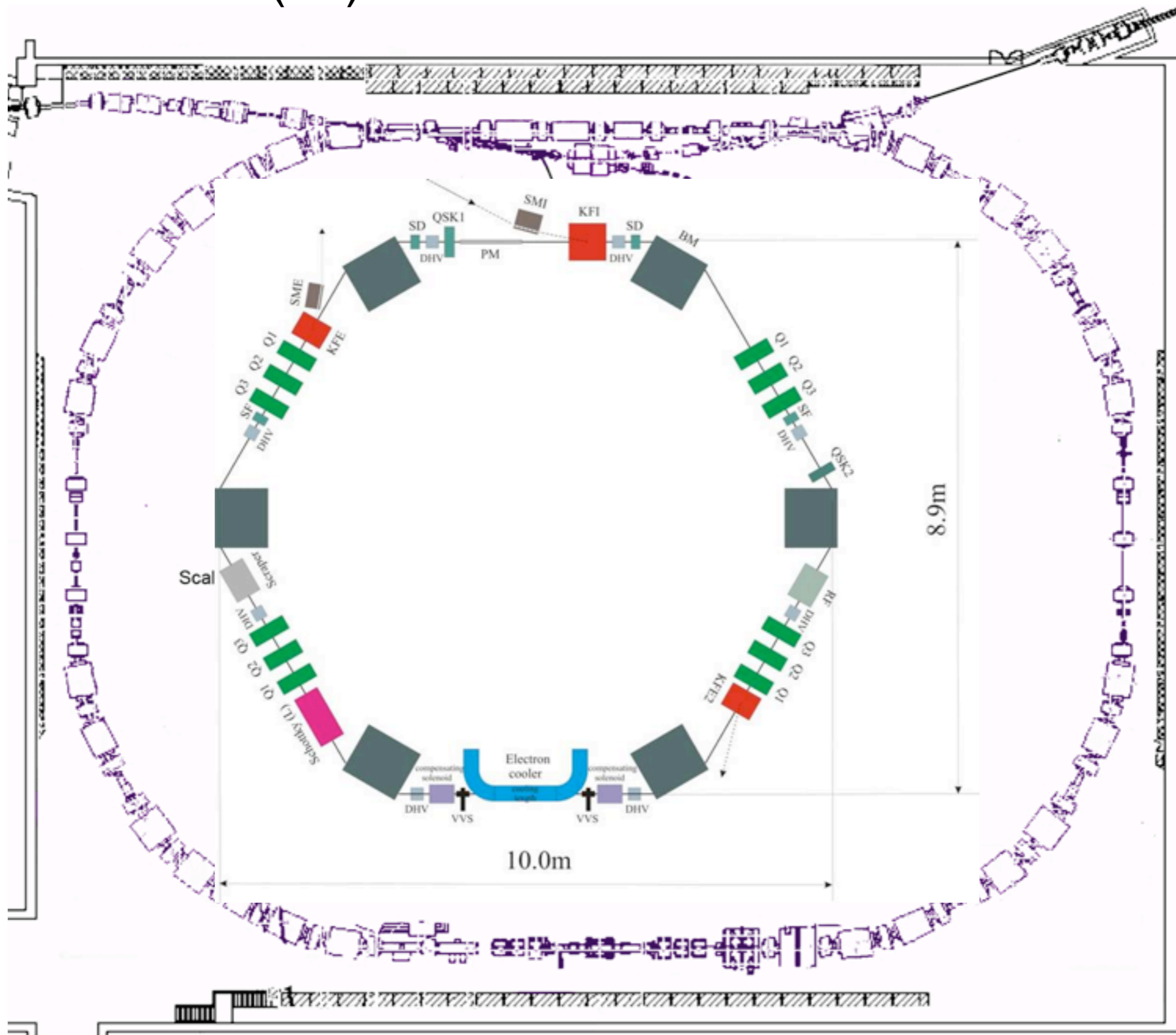

new (de)celerator in 2017: ELENA

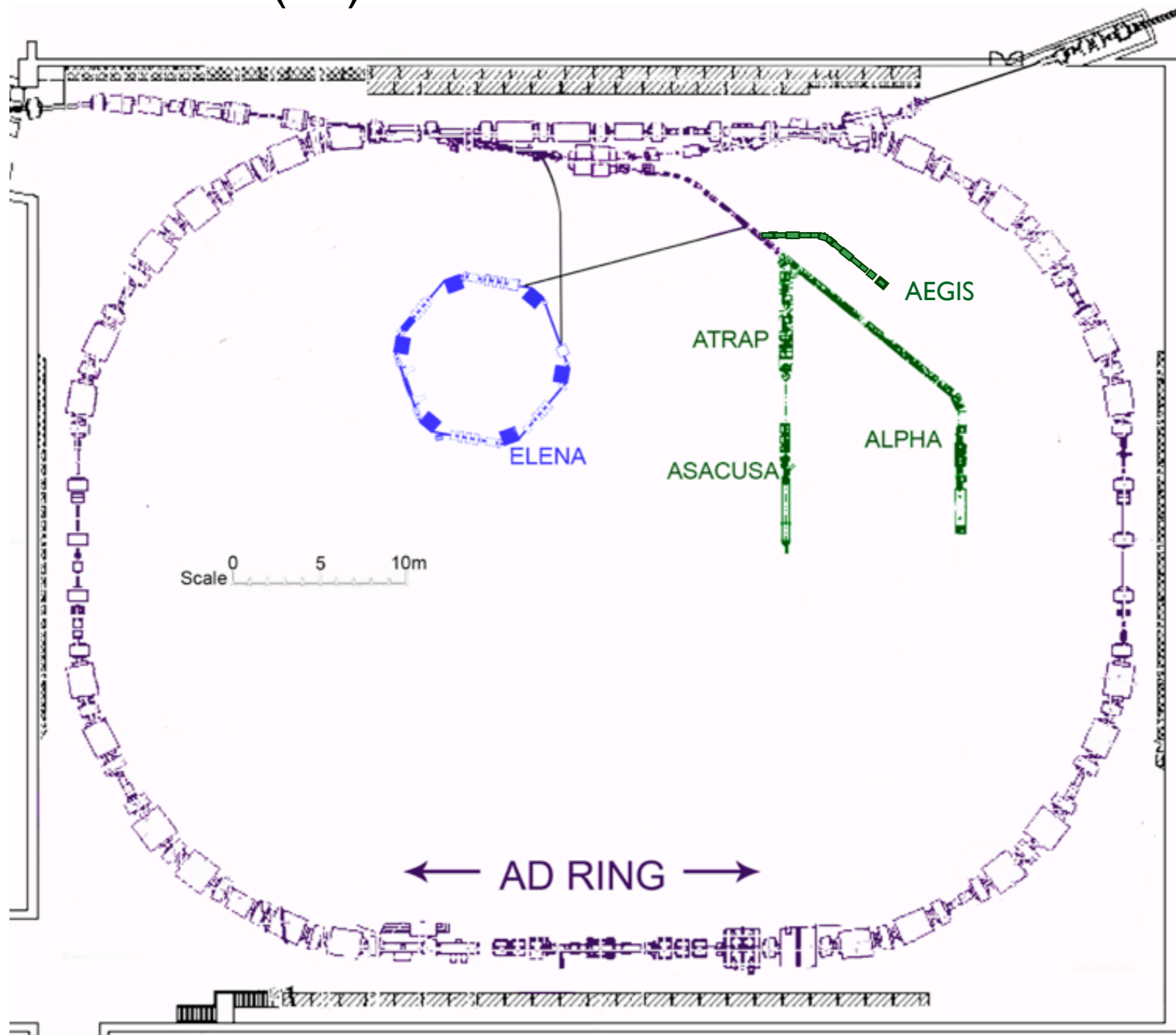

new experiments in 2017: GBAR

Synoptic Scheme

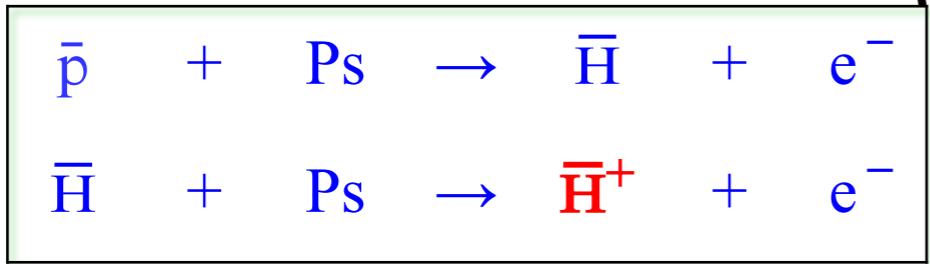
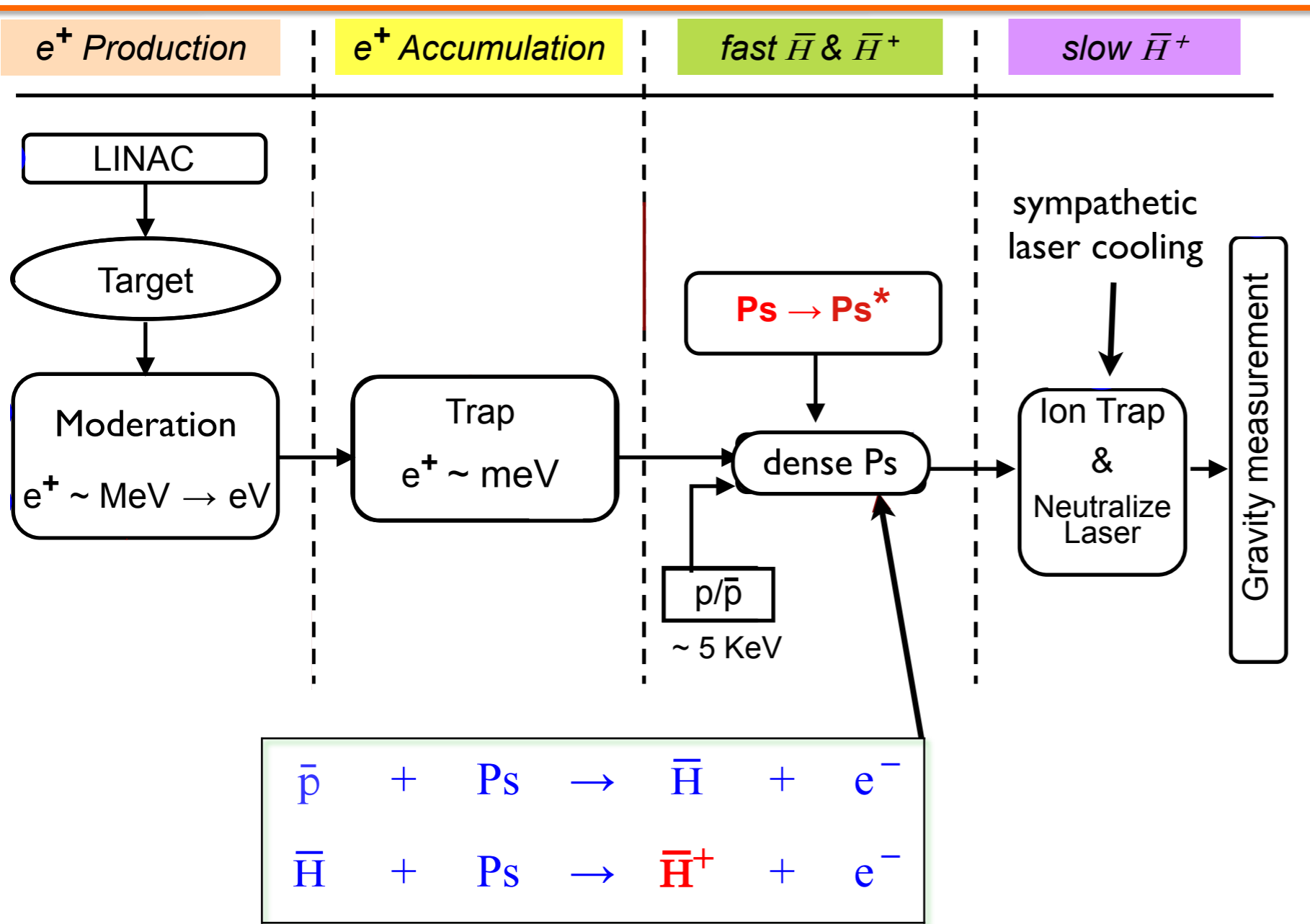

- Produce ion $\bar{\text{H}}^+$
- Capture ion $\bar{\text{H}}^+$
- Sympathetic cooling $20 \mu\text{K}$
- Photodetachment of e^+
- Time of flight

antiprotons: x100
positrons: x1000

Precision requires “Ultra-cold” ($\sim 1 \mu\text{K}$) Antihydrogen

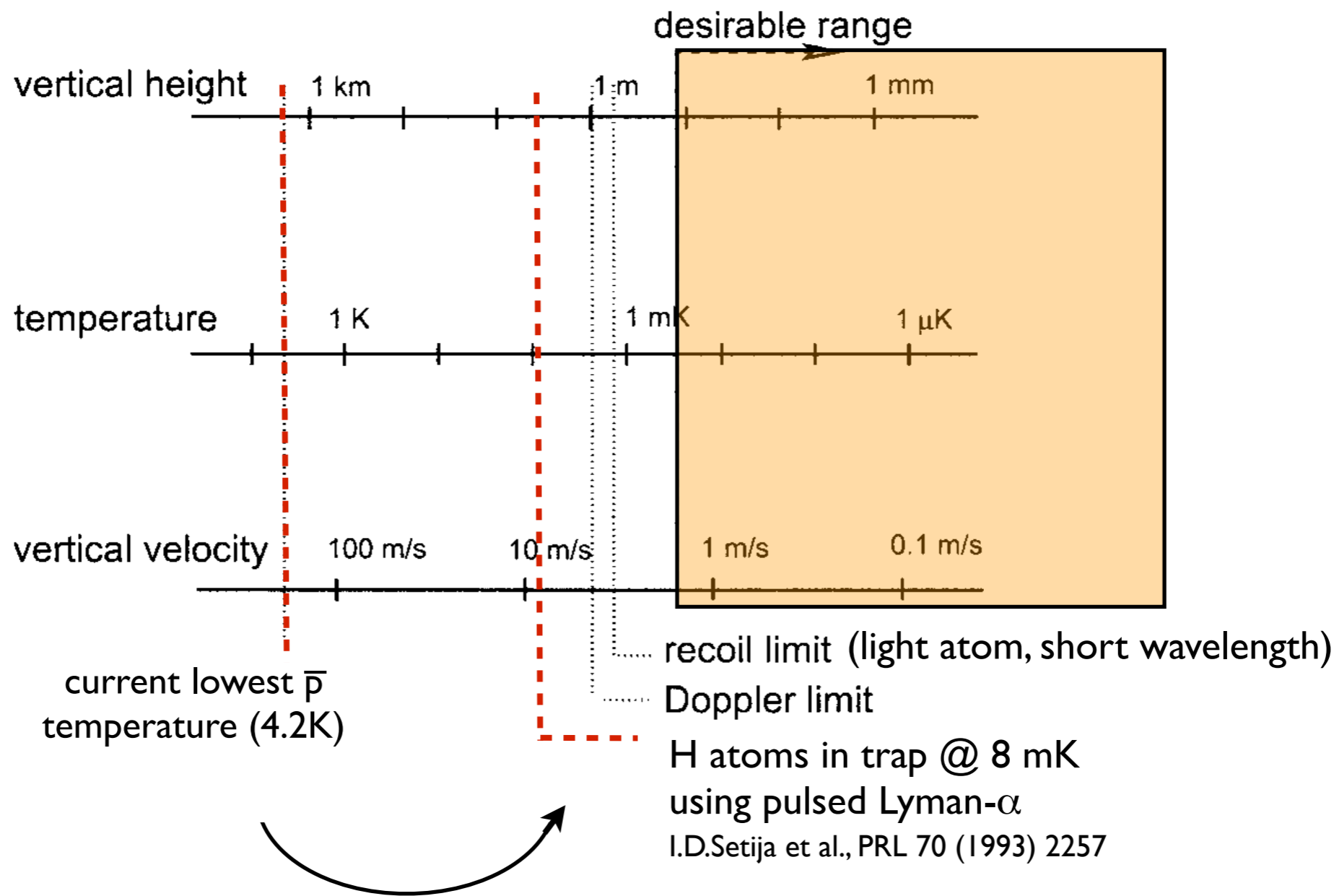

IS \rightarrow 2P laser cooling: cw Lyman- α source

Eikema, Walz, Hänsch, PRL 86 (2001) 5679

sympathetic cooling to the rescue

GBAR

cooling of \bar{H}^+

J. Walz and T. Hänsch, Gen. Rel. and Grav. 36 (2004) 561

AEGIS

sympathetic cooling to the rescue

GBAR

cooling of \bar{H}^+

J. Walz and T. Hänsch, Gen. Rel. and Grav. 36 (2004) 561

formation of \bar{H}^+ (binding energy = 0.754 eV)

how? perhaps through $Ps(2p) + \bar{H}(1s) \rightarrow \bar{H}^+ + e^-$

Roy & Sinha, EPJD 47 (2008) 327

sympathetic cooling of \bar{H}^+

e.g. $In^+ \rightarrow 20 \mu K$

photodetachment at $\sim 6083 \text{ cm}^{-1}$

gravity measurement via TOF

AEGIS

sympathetic cooling to the rescue

GBAR

cooling of \bar{H}^+

J. Walz and T. Hänsch, Gen. Rel. and Grav. 36 (2004) 561

formation of \bar{H}^+ (binding energy = 0.754 eV)

how? perhaps through $Ps(2p) + \bar{H}(1s) \rightarrow \bar{H}^+ + e^-$

Roy & Sinha, EPJD 47 (2008) 327

sympathetic cooling of \bar{H}^+

e.g. $In^+ \rightarrow 20 \mu K$

photodetachment at $\sim 6083 \text{ cm}^{-1}$

gravity measurement via TOF

AEGIS

cooling of \bar{p}

Warring et al, PRL 102 (2009) 043001

Fischer et al, PRL 104 (2010) 073004

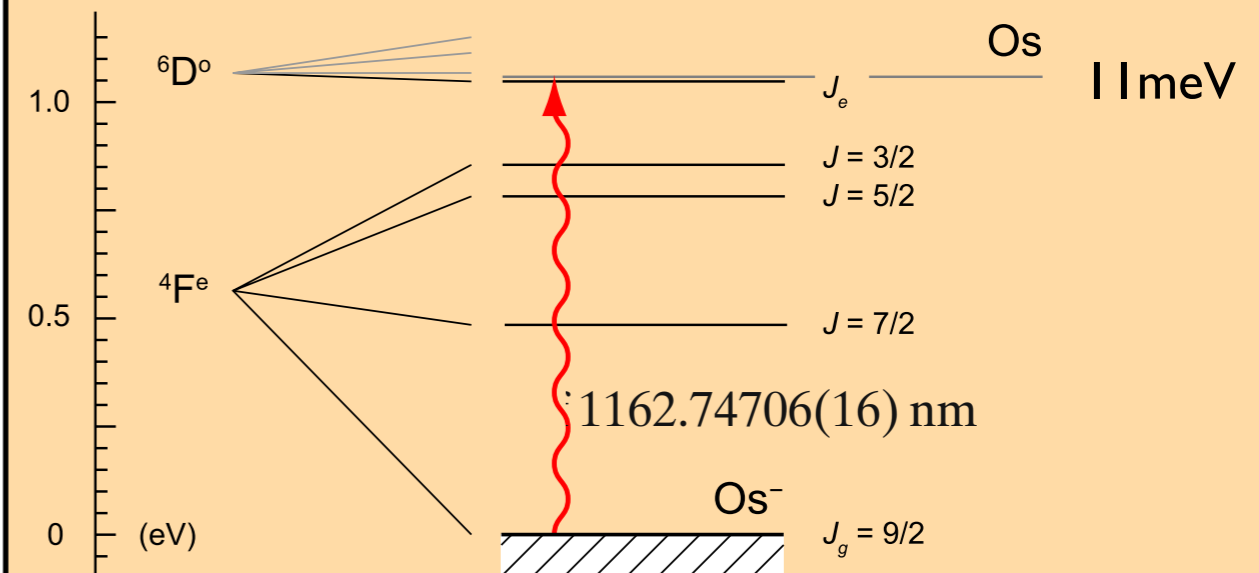

very weak cooling

→ best to start at $\sim 4 \text{ K}$ and cool to Doppler limit ($T_D \approx 0.24 \mu K$)

sympathetic cooling to the rescue

GBAR

cooling of \bar{H}^+

J. Walz and T. Hänsch, Gen. Rel. and Grav. 36 (2004) 561

formation of \bar{H}^+ (binding energy = 0.754 eV)

how? perhaps through $Ps(2p) + \bar{H}(1s) \rightarrow \bar{H}^+ + e^-$

Roy & Sinha, EPJD 47 (2008) 327

sympathetic cooling of \bar{H}^+

e.g. $In^+ \rightarrow 20 \mu K$

photodetachment at $\sim 6083 \text{ cm}^{-1}$

gravity measurement via TOF

AEGIS

cooling of \bar{p}

Warring et al, PRL 102 (2009) 043001

Fischer et al, PRL 104 (2010) 073004

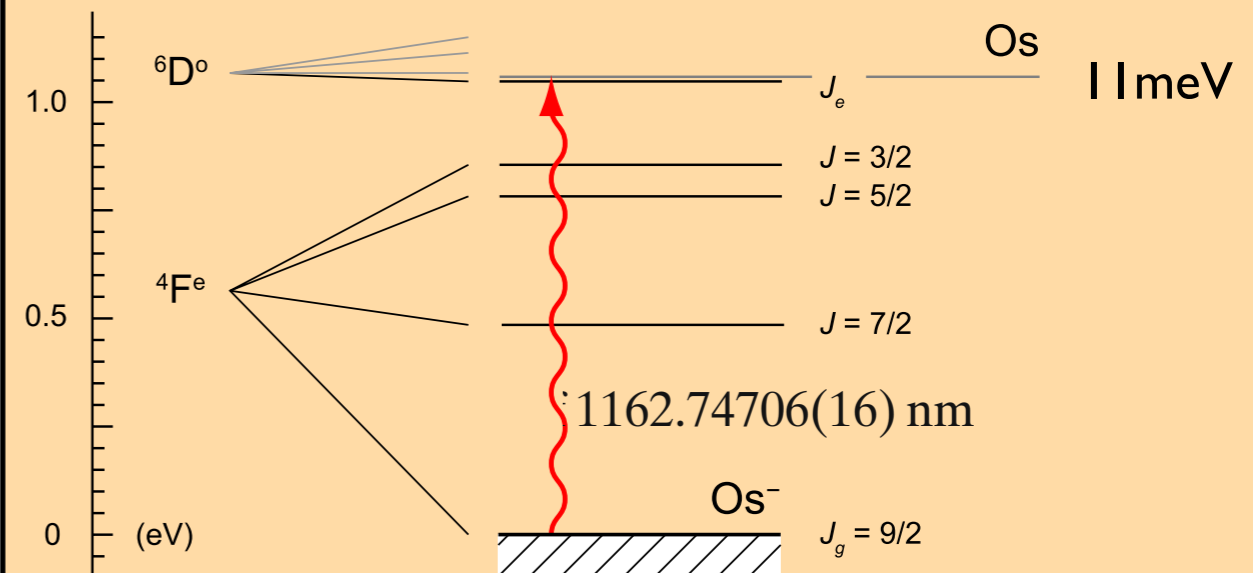

very weak cooling

→ best to start at $\sim 4K$ and cool to Doppler limit ($T_D \approx 0.24 \mu K$)

should allow reaching same precision on g as with atoms (10^{-6} or better)

Overview:

1. Introduction and overview
2. Antimatter at high energies (SppS, LEP, Fermilab)
3. Meson spectroscopy (antimatter as QCD probe)
4. Astroparticle physics and cosmology
5. CP and CPT violation tests
6. Precision tests with Antihydrogen: spectroscopy
7. Precision tests with Antihydrogen: gravity
- 8. Applications of antimatter**

Overview:

1. Introduction and overview
2. Antimatter at high energies (SppS, LEP, Fermilab)
3. Meson spectroscopy (antimatter as QCD probe)
4. Astroparticle physics and cosmology
5. CP and CPT violation tests
6. Precision tests with Antihydrogen: spectroscopy
7. Precision tests with Antihydrogen: gravity
- 8. Applications of antimatter**

(aka: can it make me rich?)

Applications:

1. Positron emission tomography

2. Radiotherapy

3. Fuel

4. Other ideas

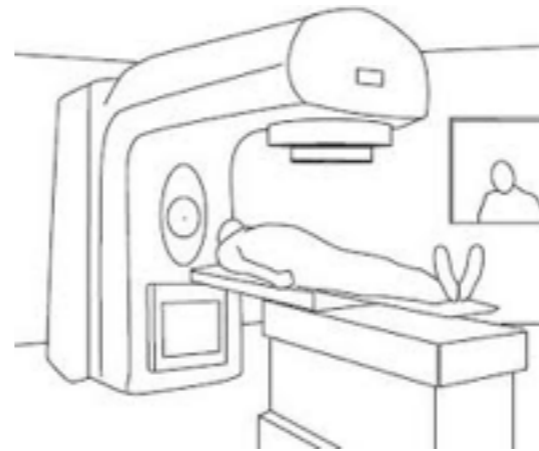

Applications:

1. Positron emission tomography

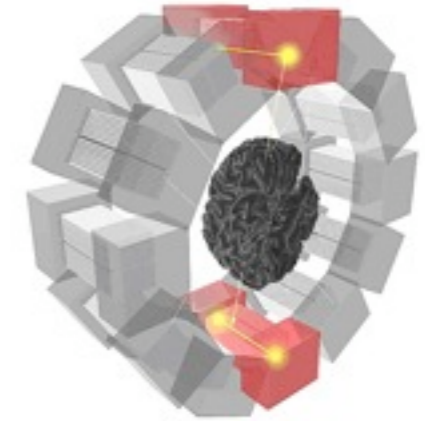

2. Radiotherapy

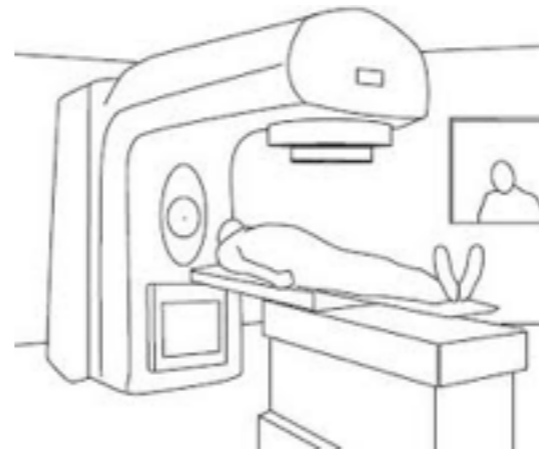

3. Fuel



4. Other ideas



2-fluoro-
2-deoxy-D-glucose
"FDG"

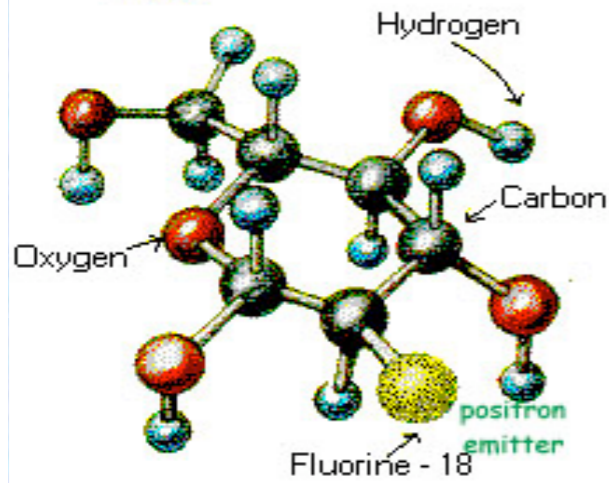

Insert e^+ emitting isotopes (C-11, N-13, O-15, F-18) into physiologically relevant molecules (O_2 , glucose, enzymes) and inject into patient.

(Lifetimes \sim few to 100 minutes)

Reconstruct place of positron annihilation with crystal calorimeter

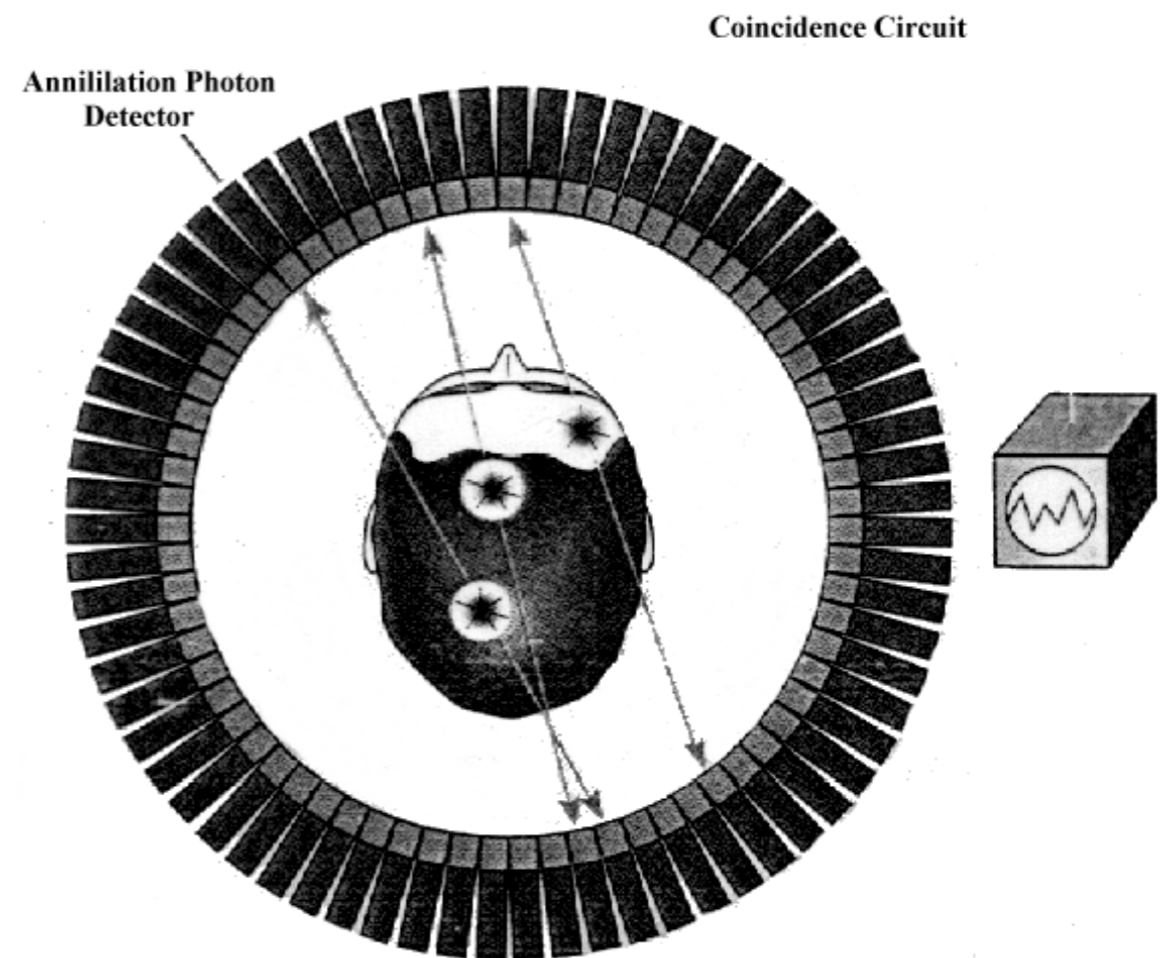

Multiple radiation detectors arranged around the subject's head are connected by coincidence circuits.

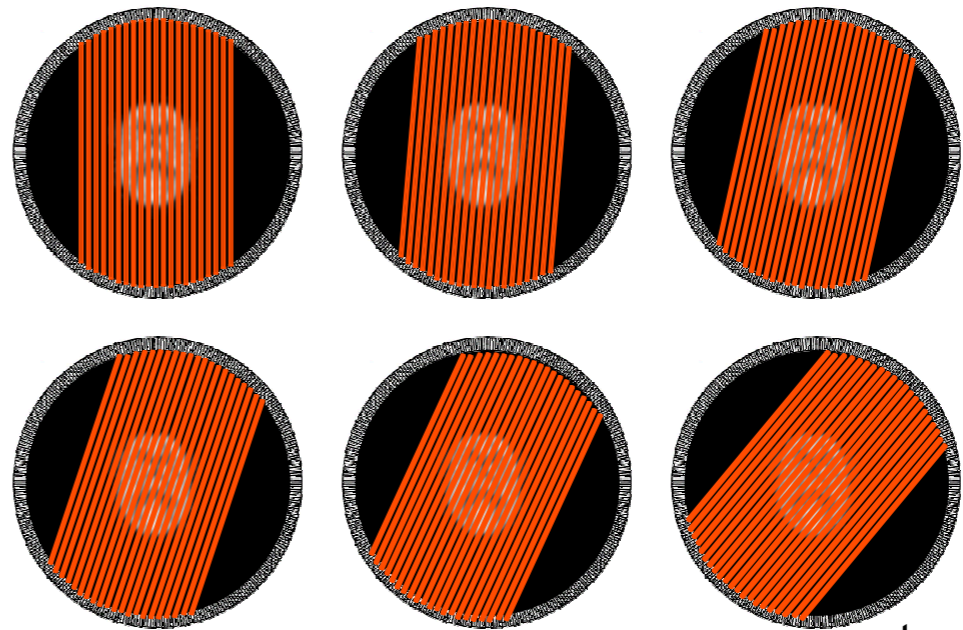
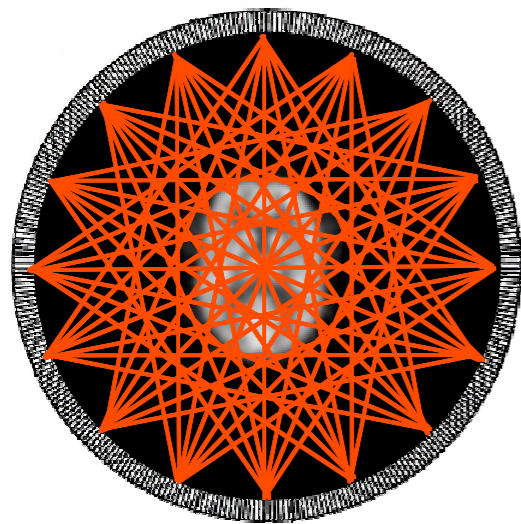
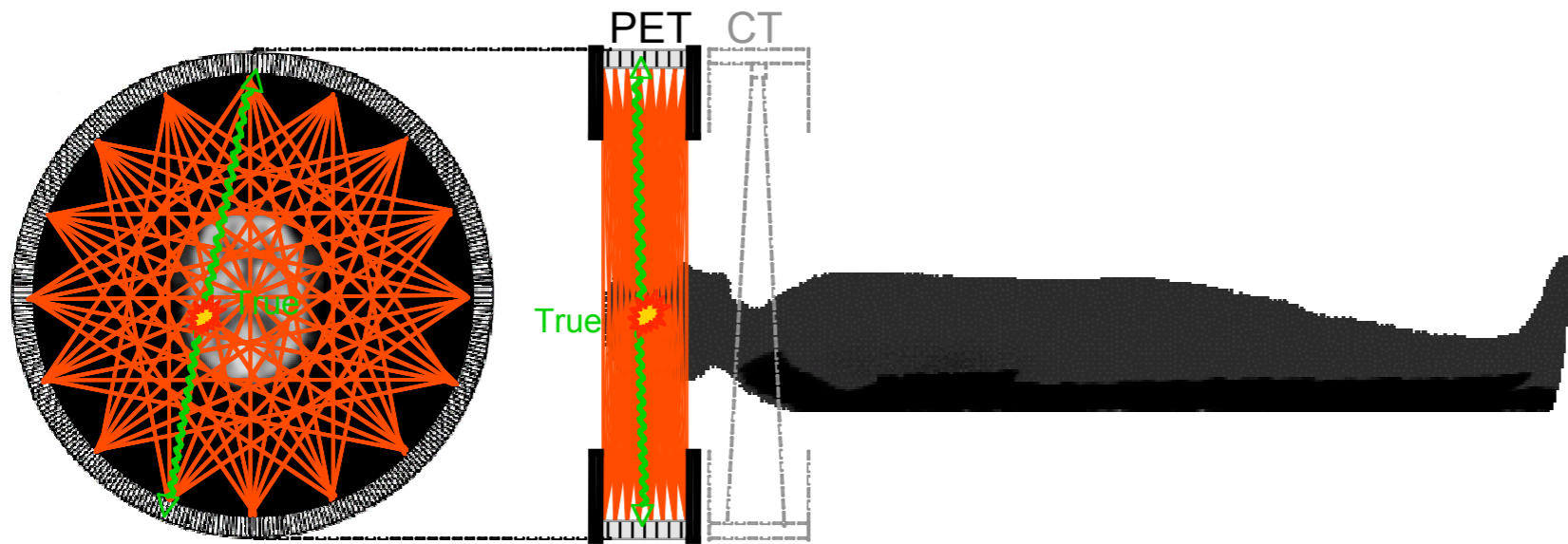

etc...

Data representation: sinograms

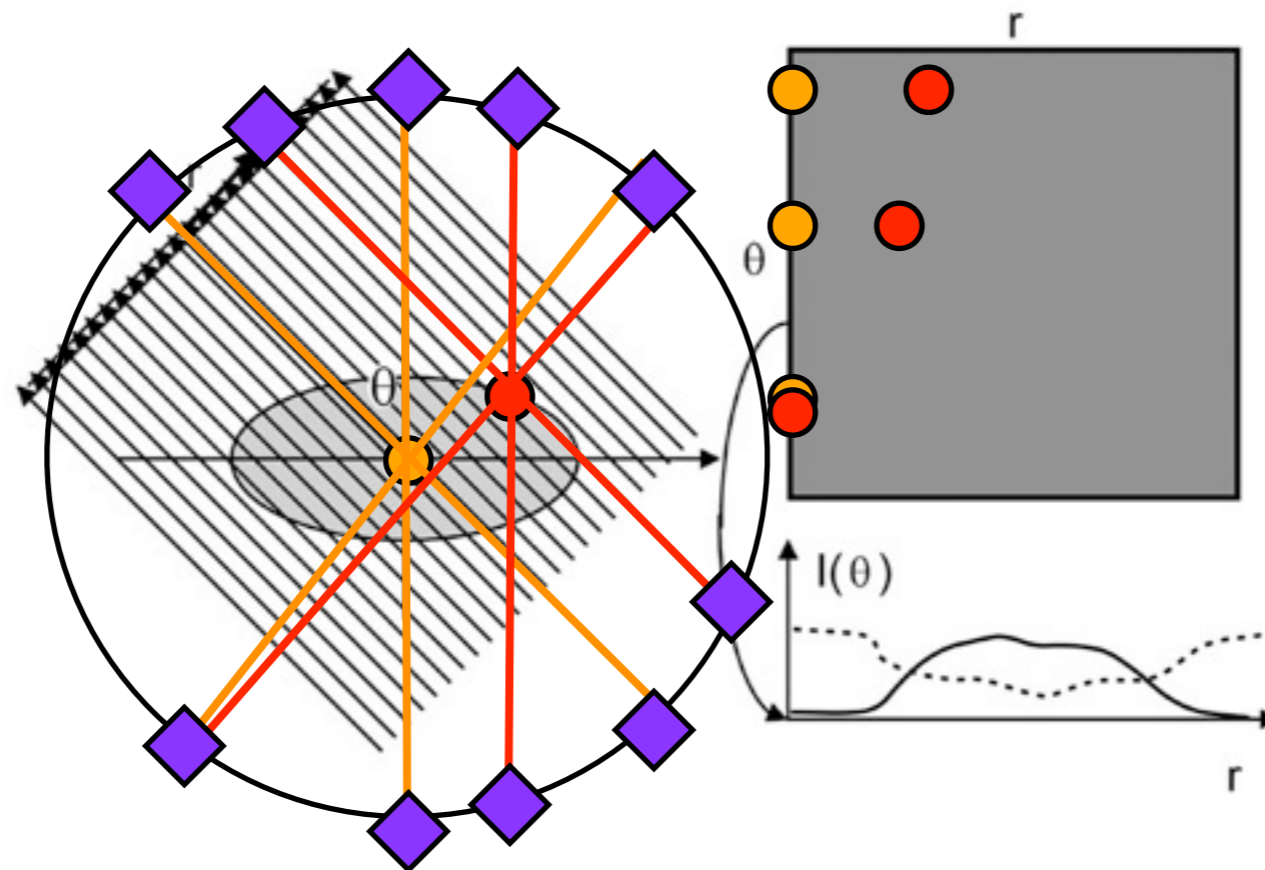

The number of events detected along a line is proportional to the integral of activity along that line

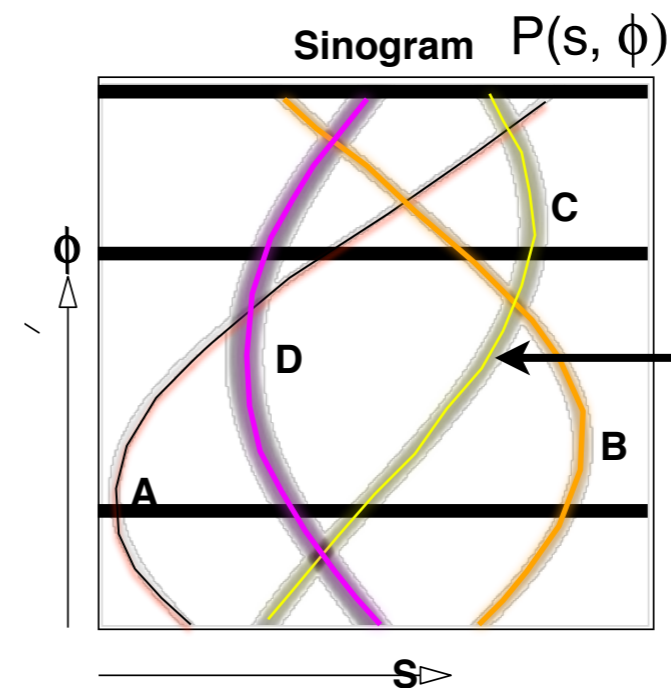
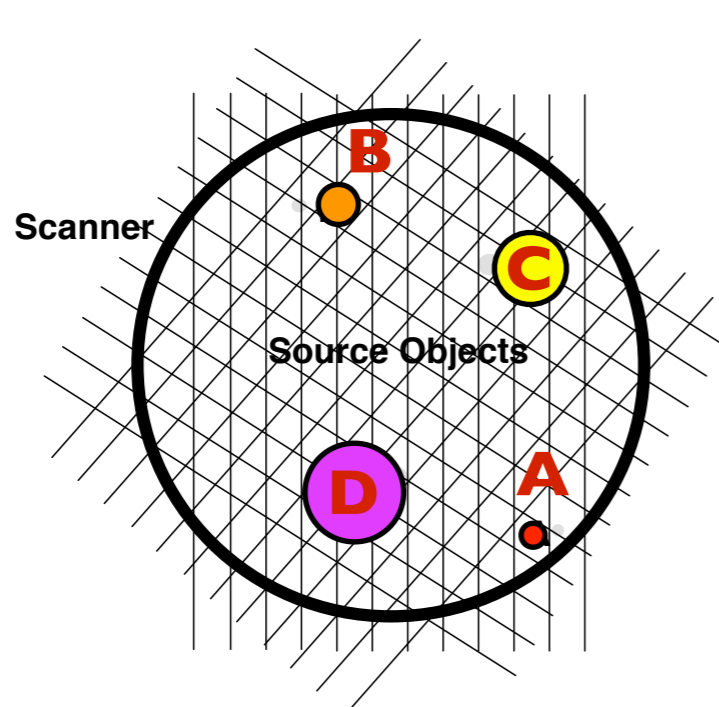

Intensity =
Line integral through
tracer distribution for
a particular (s, phi)

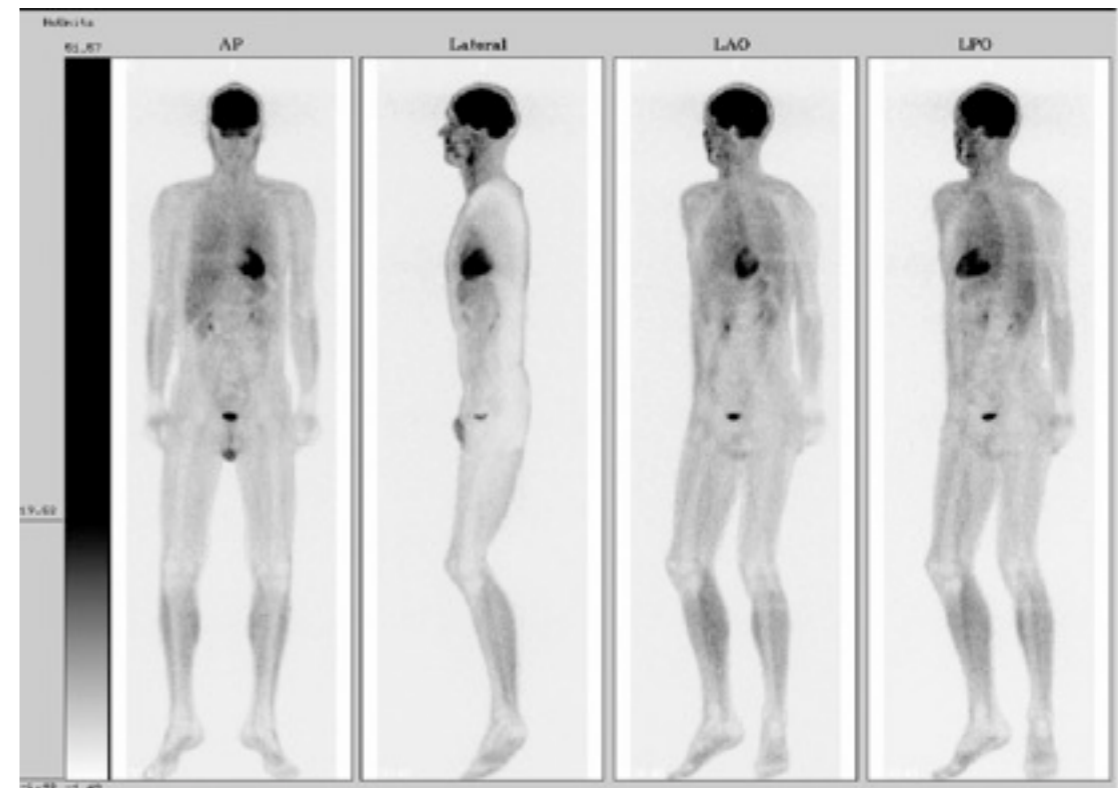
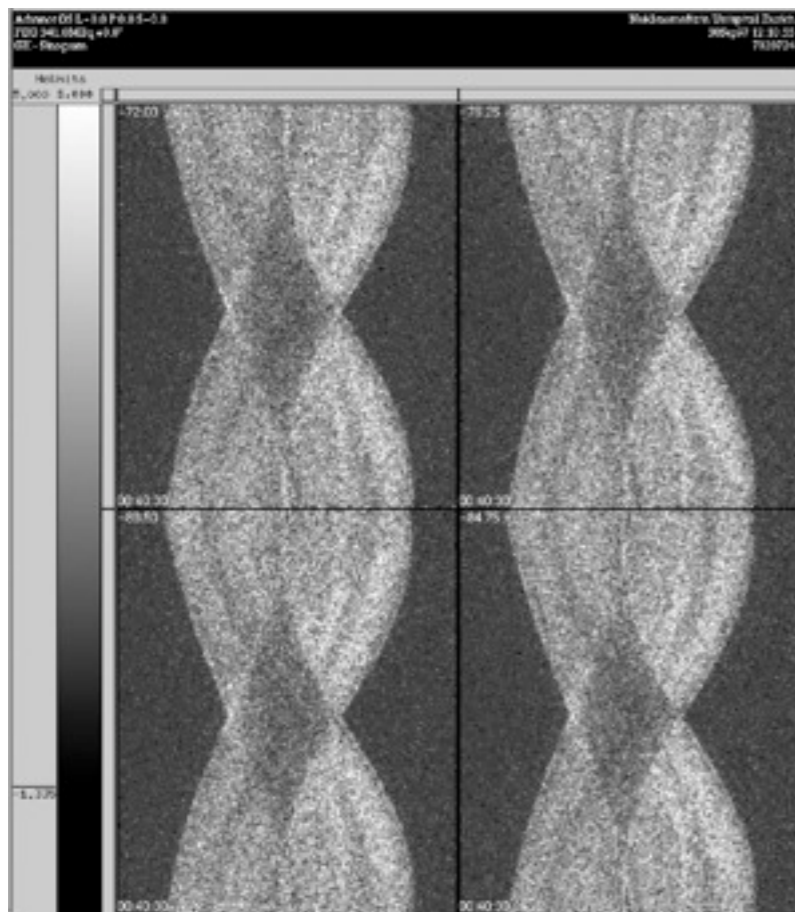

<http://research.nokia.com/files/tomoRGI.pdf>

- Filtered back-projection
fast, cheap, inaccurate
- Expectation maximization (iterative procedure)
slow, expensive, accurate

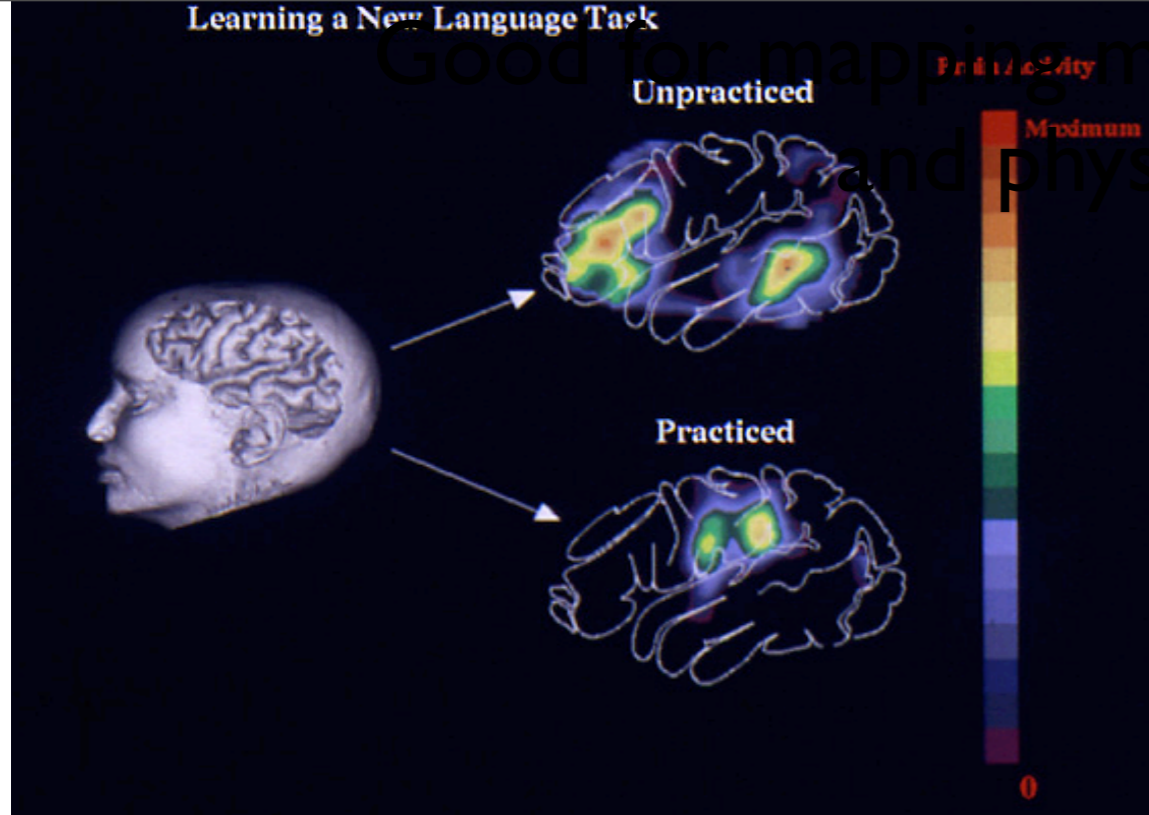

metabolism, neurotransmitters and physiological changes

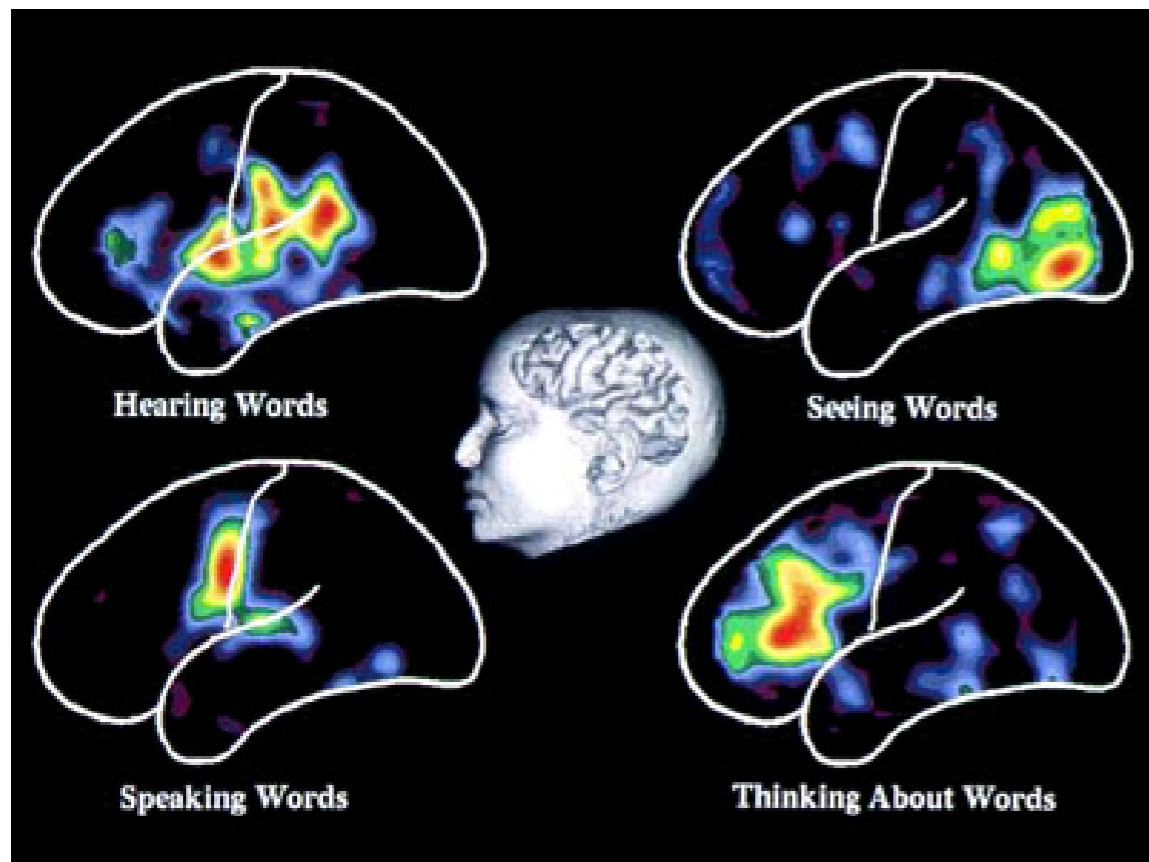
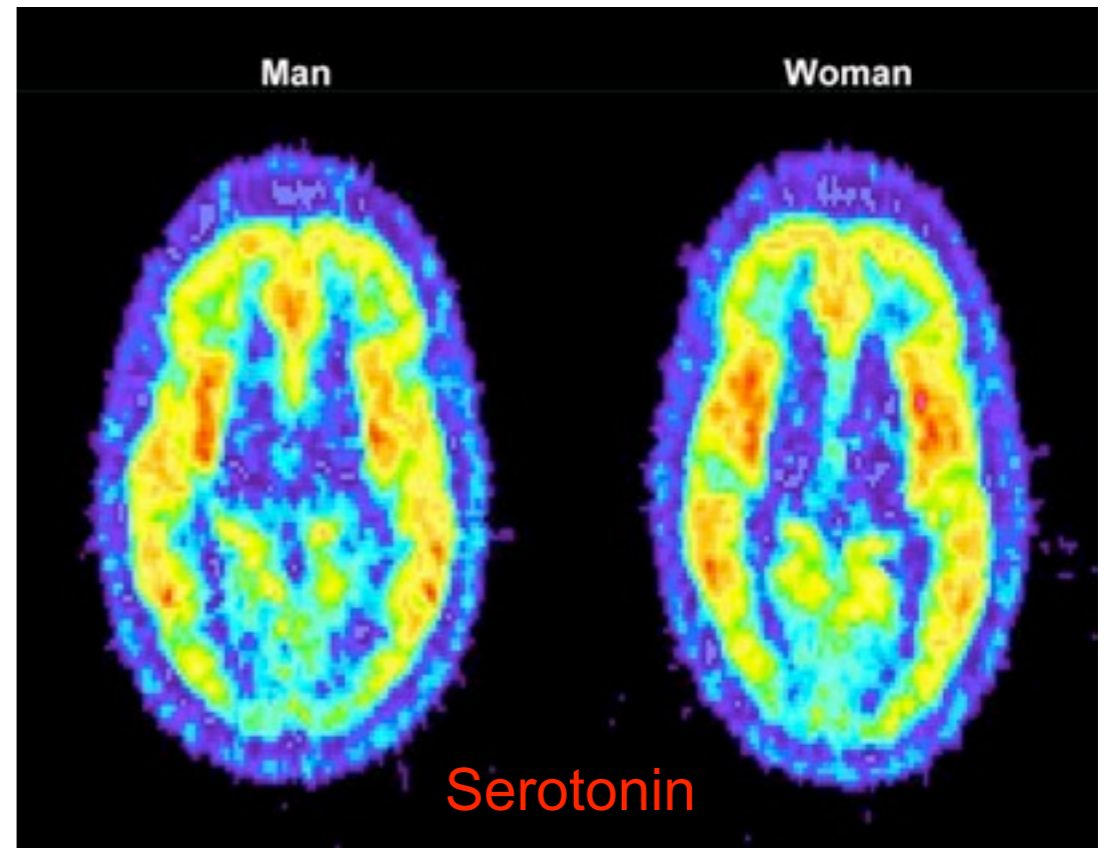

- Serotonin receptors
- Dopamine receptors
- Glucose
- Amyloid-binding molecules
- Opioid receptors
- Pharmacological tests

brain



stomach
(abnormal)



bladder

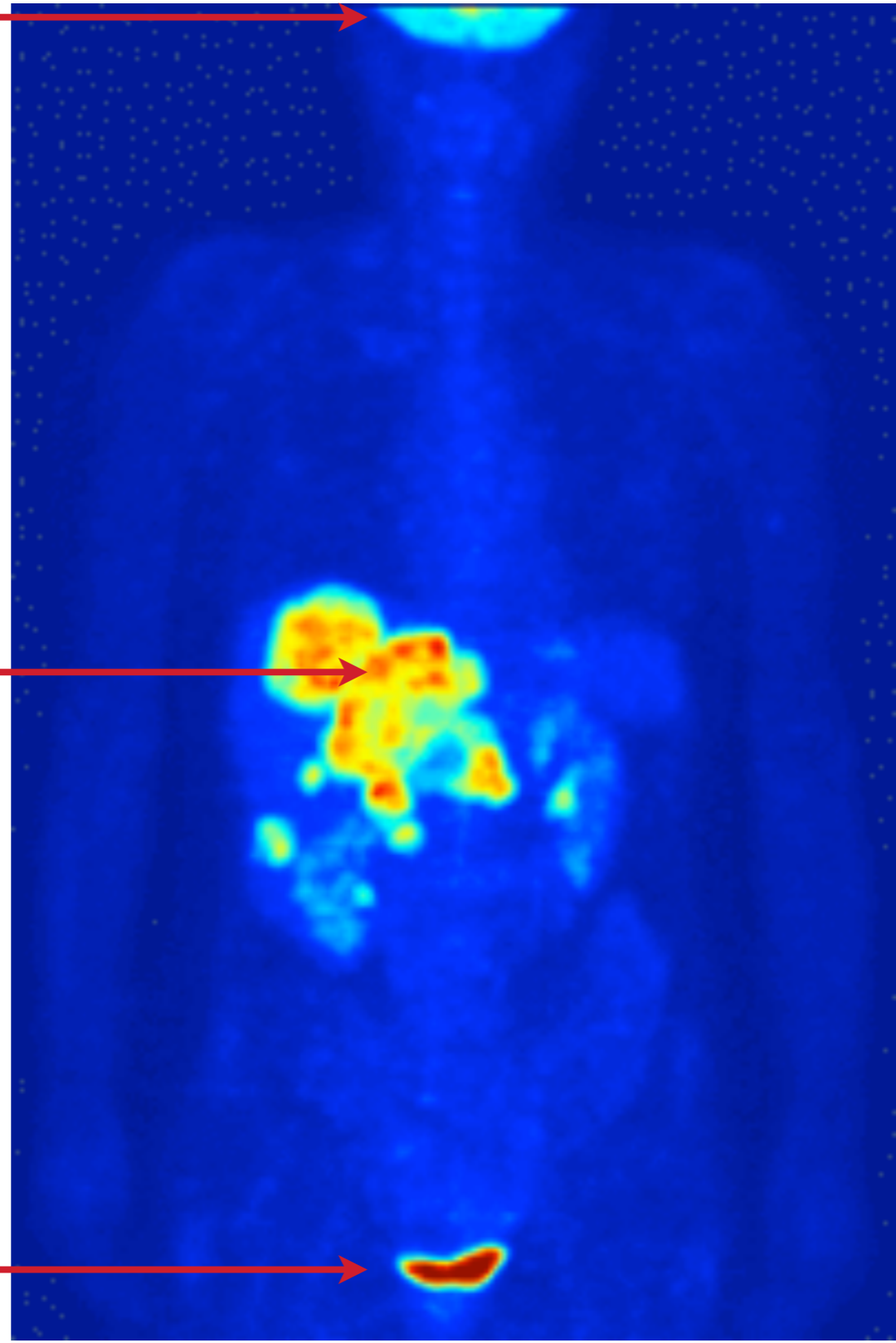

Maximum Intensity Projection of a ¹⁸F-FDG whole body PET acquisition

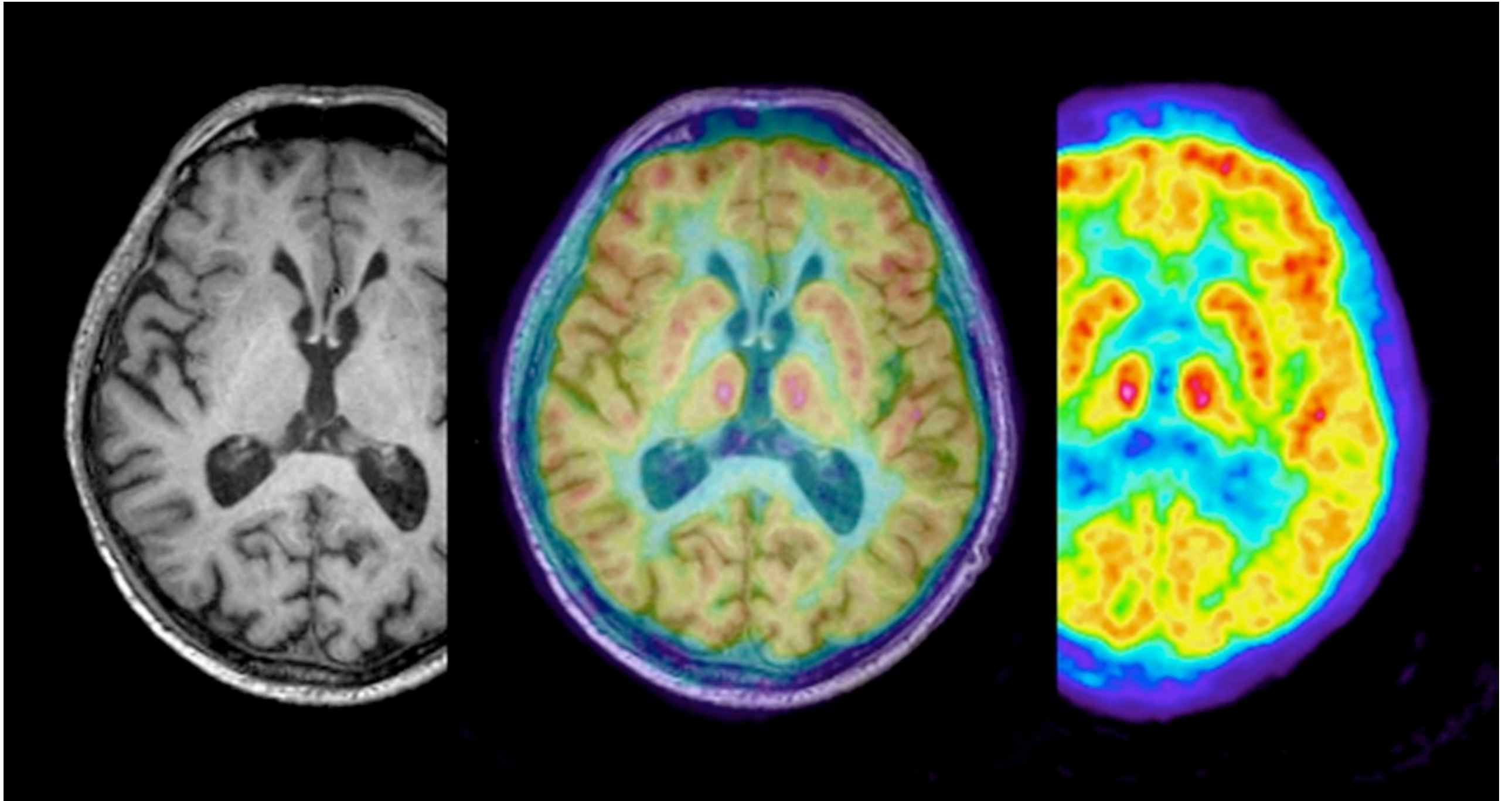

MRI

Combined

PET

Radiotherapy

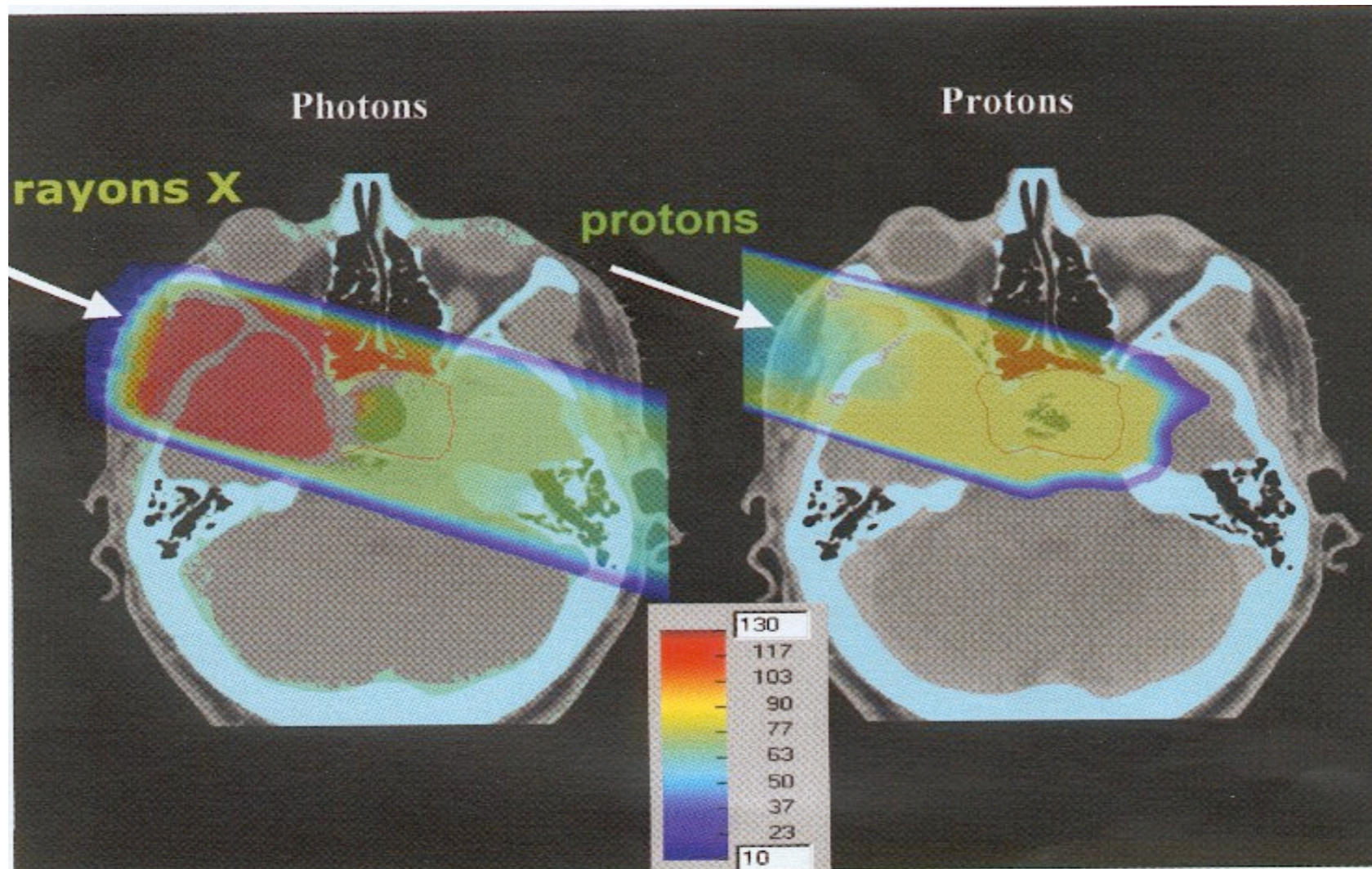

Monte Carlo simulations

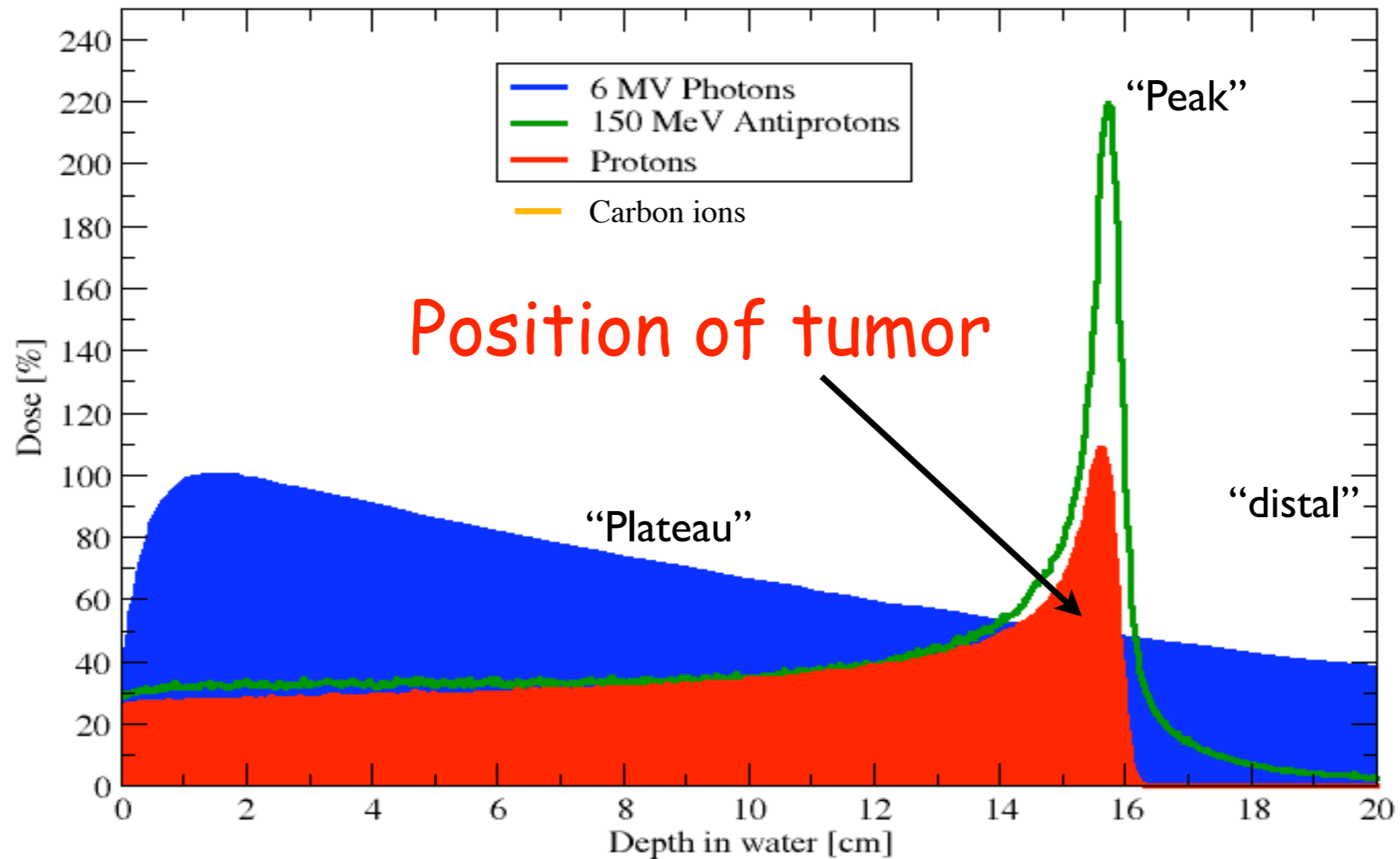

MCNPX
FLUKA
GEANT
SHIELD
HIT
.
.

Monte Carlo simulations

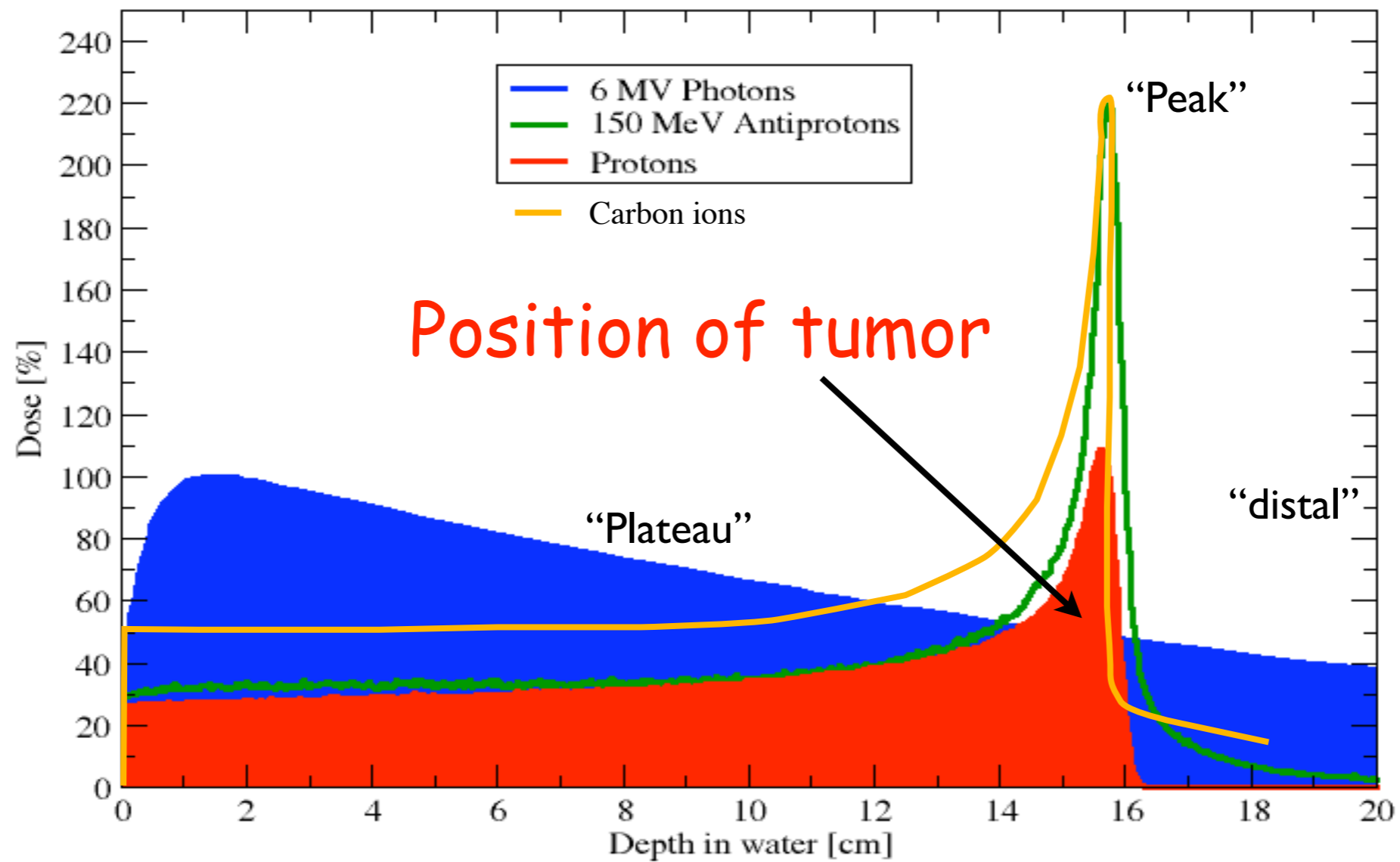

MCNPX
FLUKA
GEANT
SHIELD
HIT
·
·

The AD-4 Experiment at CERN

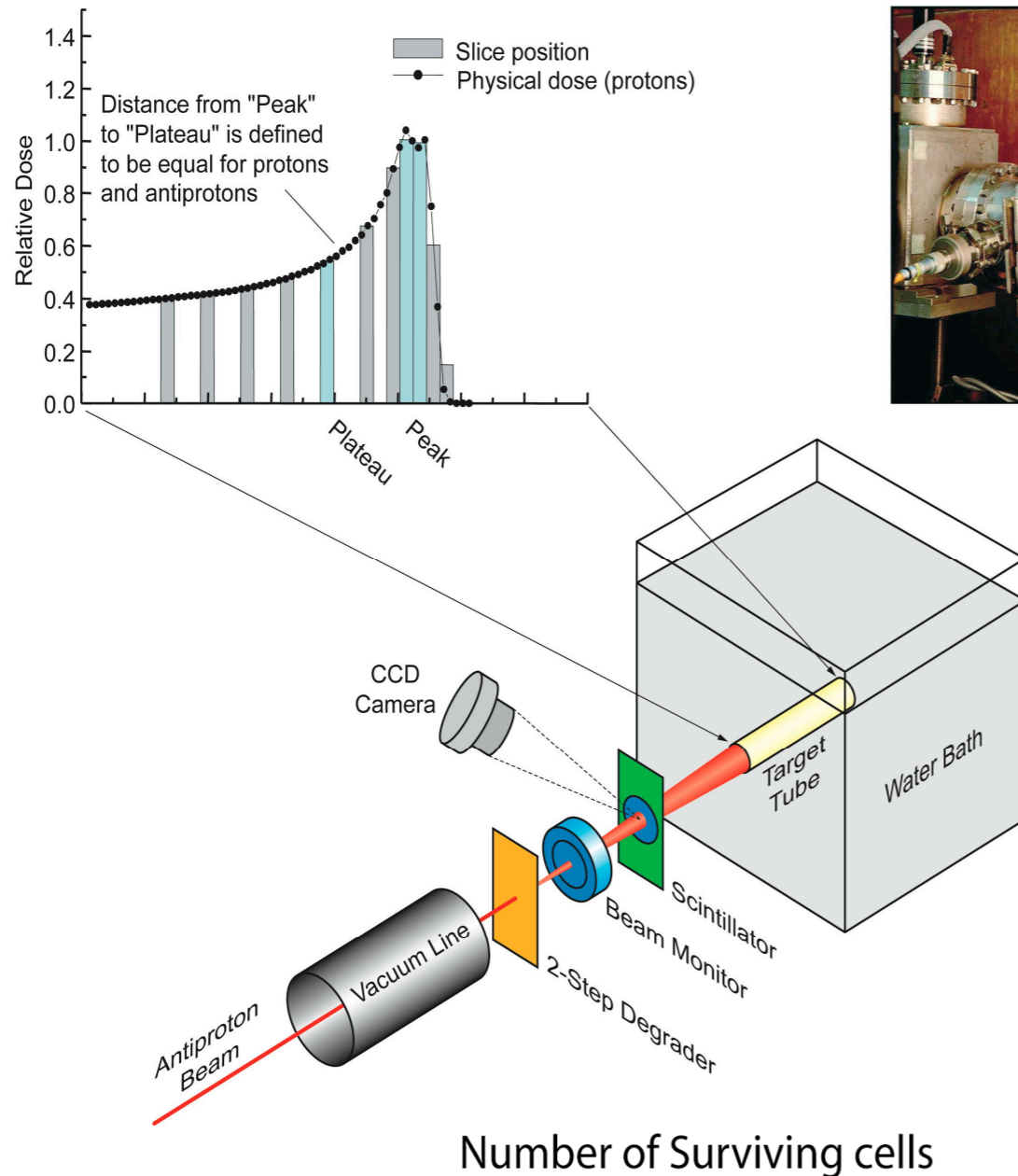

INGREDIENTS:

- V-79 Chinese Hamster cells embedded in gelatin
- **Antiproton** beam from AD (126 MeV)

METHOD:

- Irradiate cells with dose levels to give survival in the peak is between 0 and 90 %
- Slice samples, dissolve gel, incubate cells, and look for number of colonies

ANALYSIS:

- Study cell survival in peak (tumor) and plateau (skin) and compare the results to protons (and carbon ions)

Biological Analysis Method

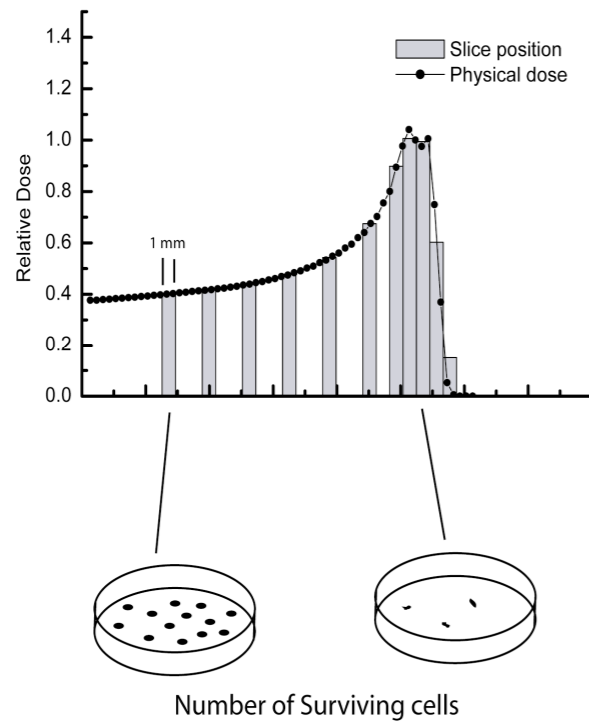

- Irradiate sample tube with living cells suspended in gel.
- Slice sample tube in ≤ 1 mm slices and determine survival fraction for each slice.
- Repeat for varying (peak) doses.

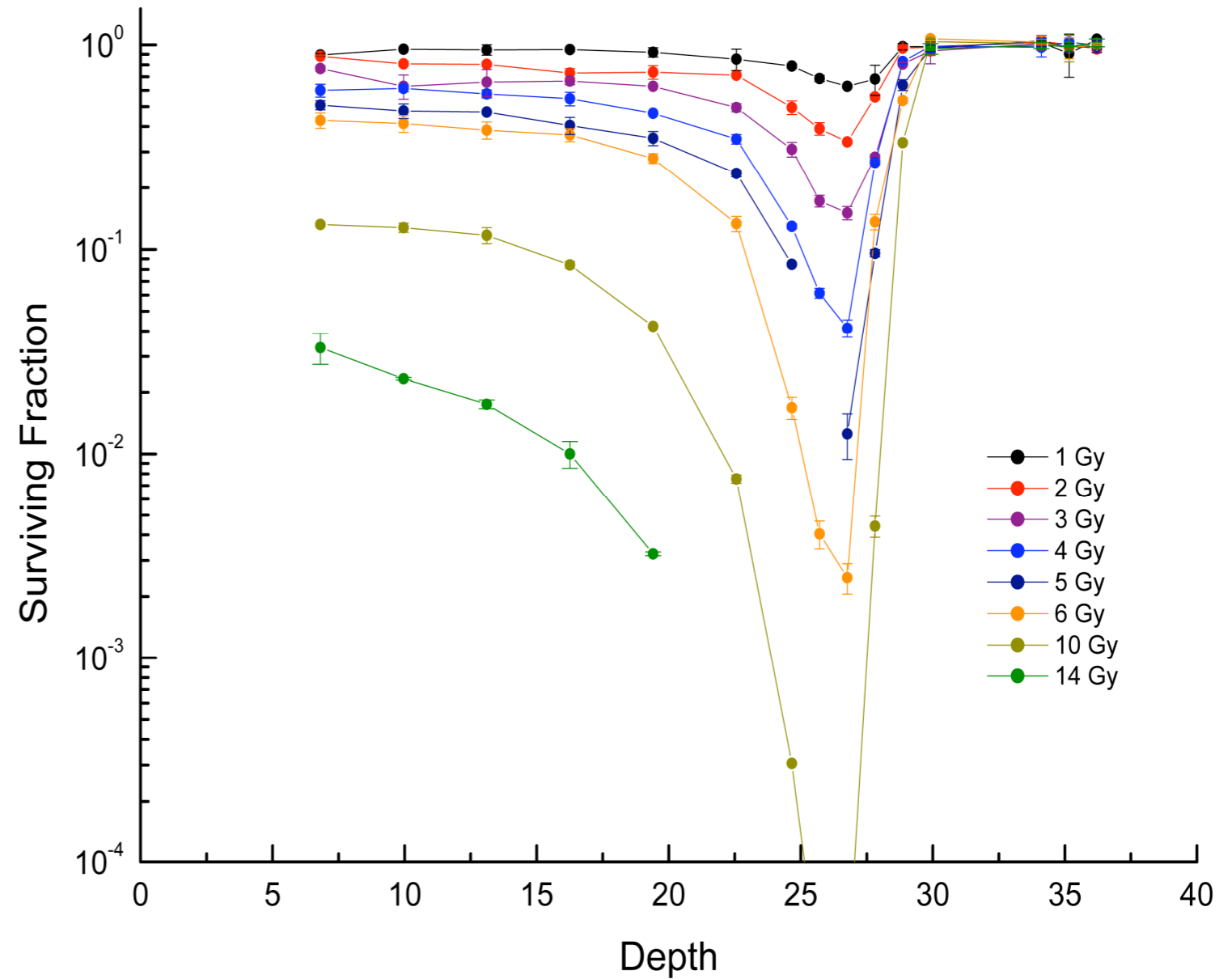

Example: Protons at TRIUMF

Biological Analysis Method

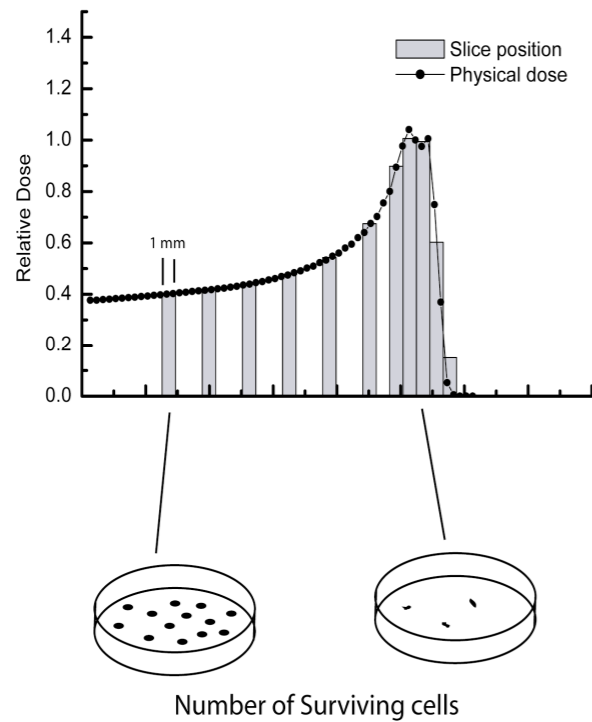

- Irradiate sample tube with living cells suspended in gel.
- Slice sample tube in ≤ 1 mm slices and determine survival fraction for each slice.
- Repeat for varying (peak) doses.

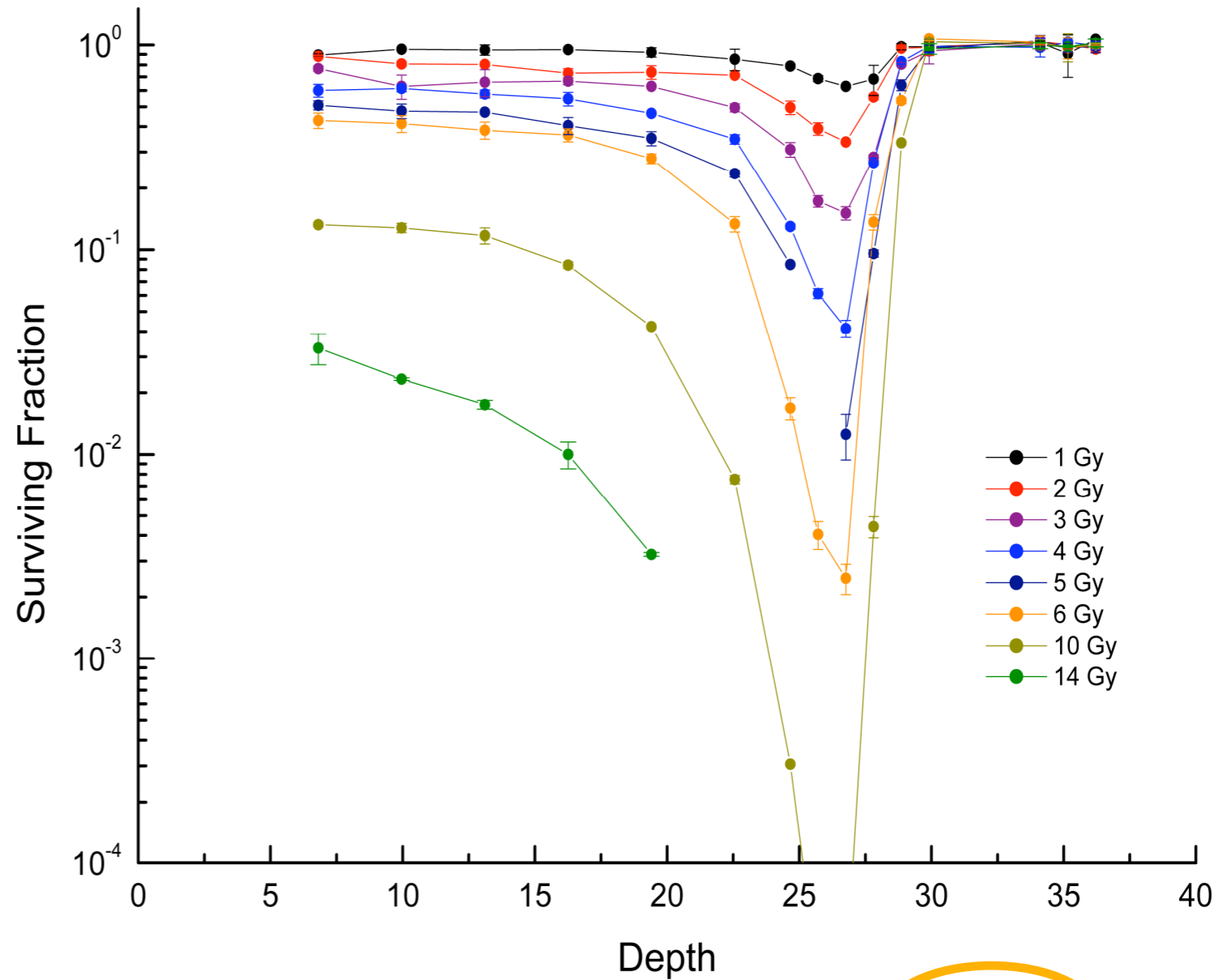

Example: Protons at TRIUMF

Biological Analysis Method

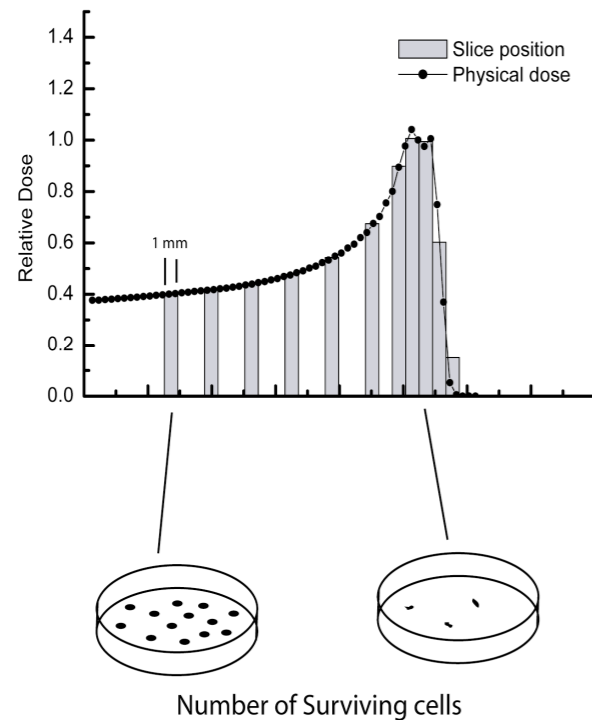

- Irradiate sample tube with living cells suspended in gel.
- Slice sample tube in ≤ 1 mm slices and determine survival fraction for each slice.
- Repeat for varying (peak) doses.

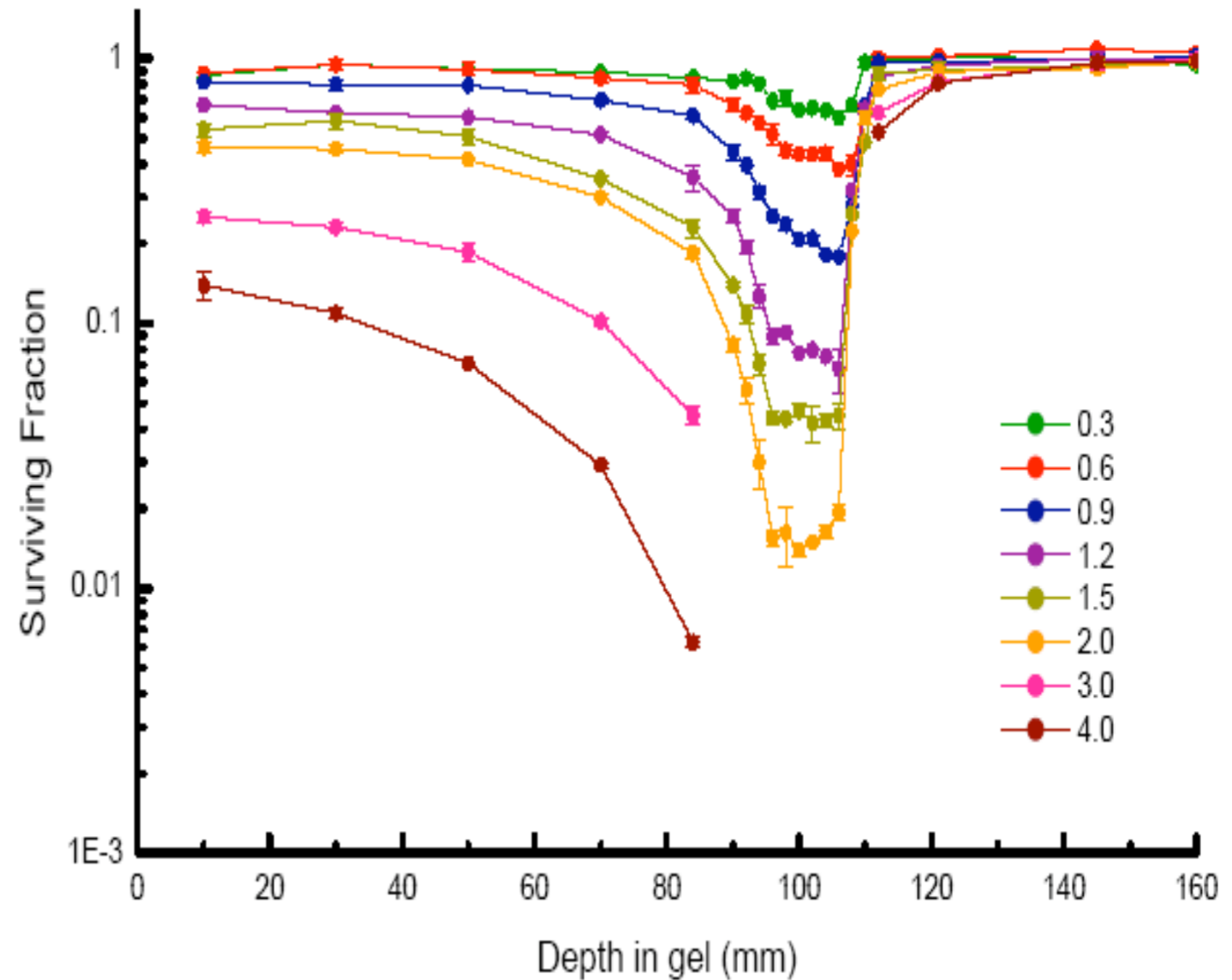

Example: SOBP of Carbon Ions at GSI

Biological Analysis Method

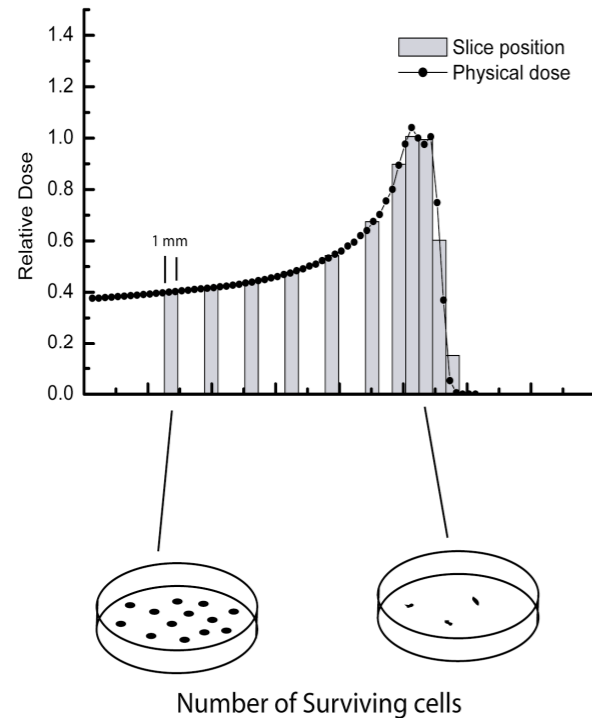

- Irradiate sample tube with living cells suspended in gel.
- Slice sample tube in ≤ 1 mm slices and determine survival fraction for each slice.
- Repeat for varying (peak) doses.

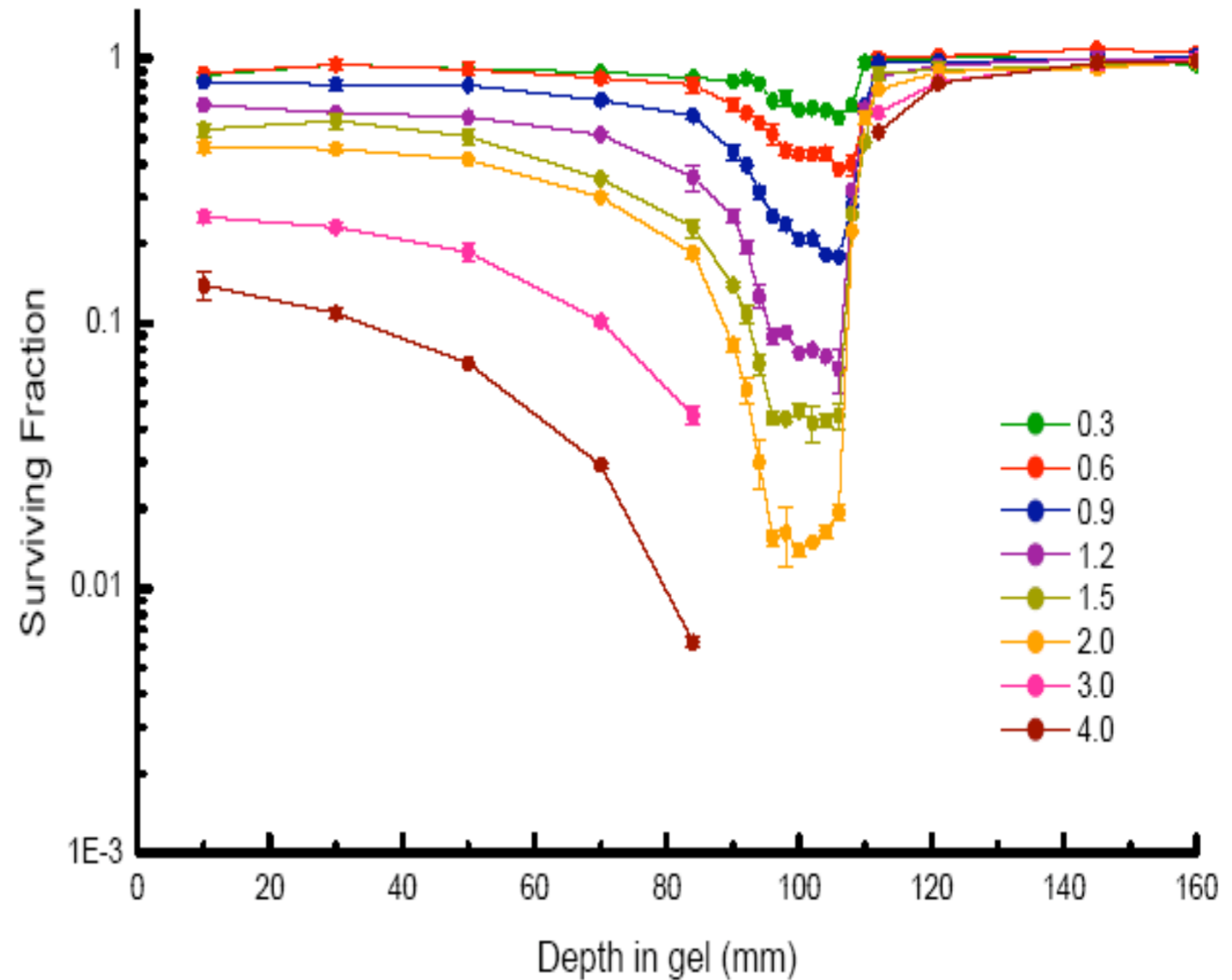

Example: SOBP of Carbon Ions at GSI

Antiproton – Proton Comparison

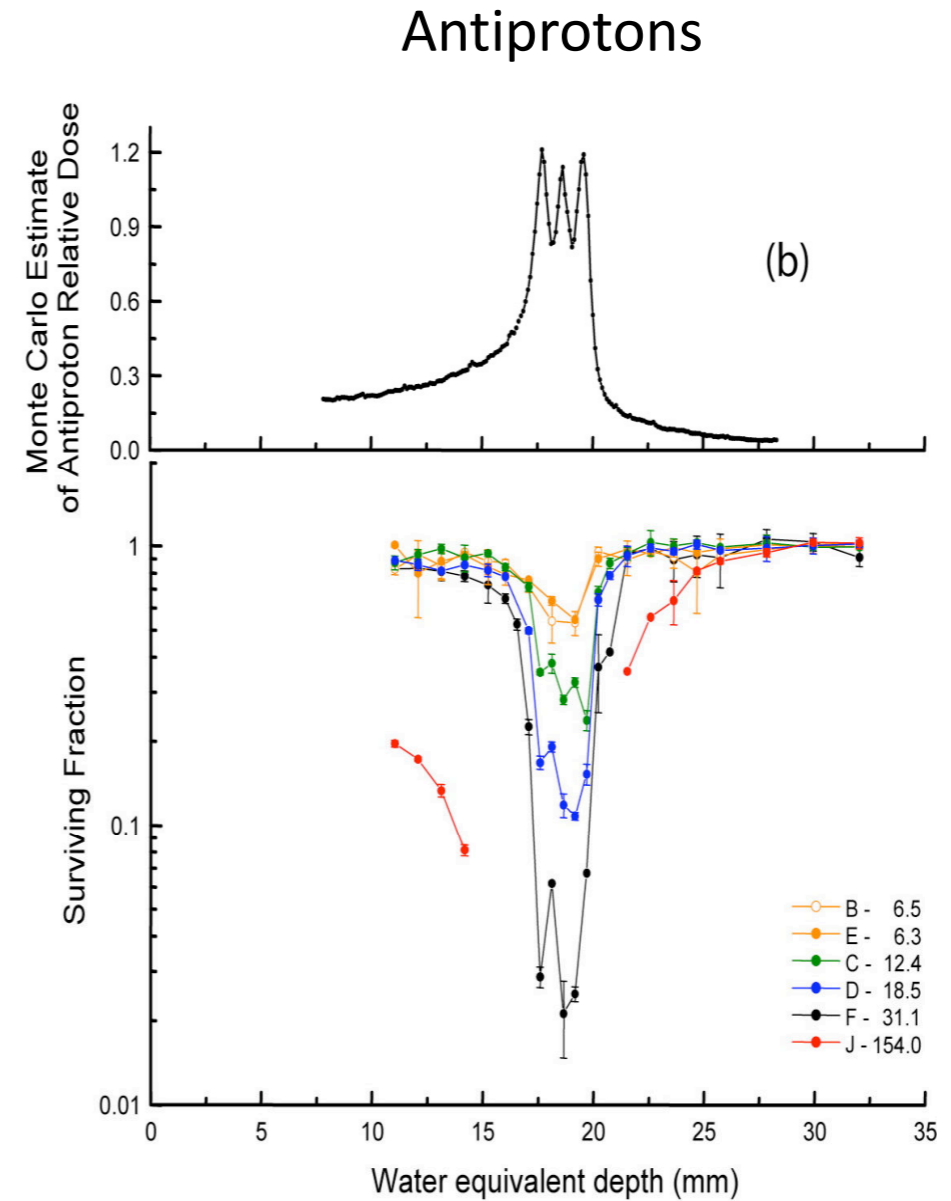
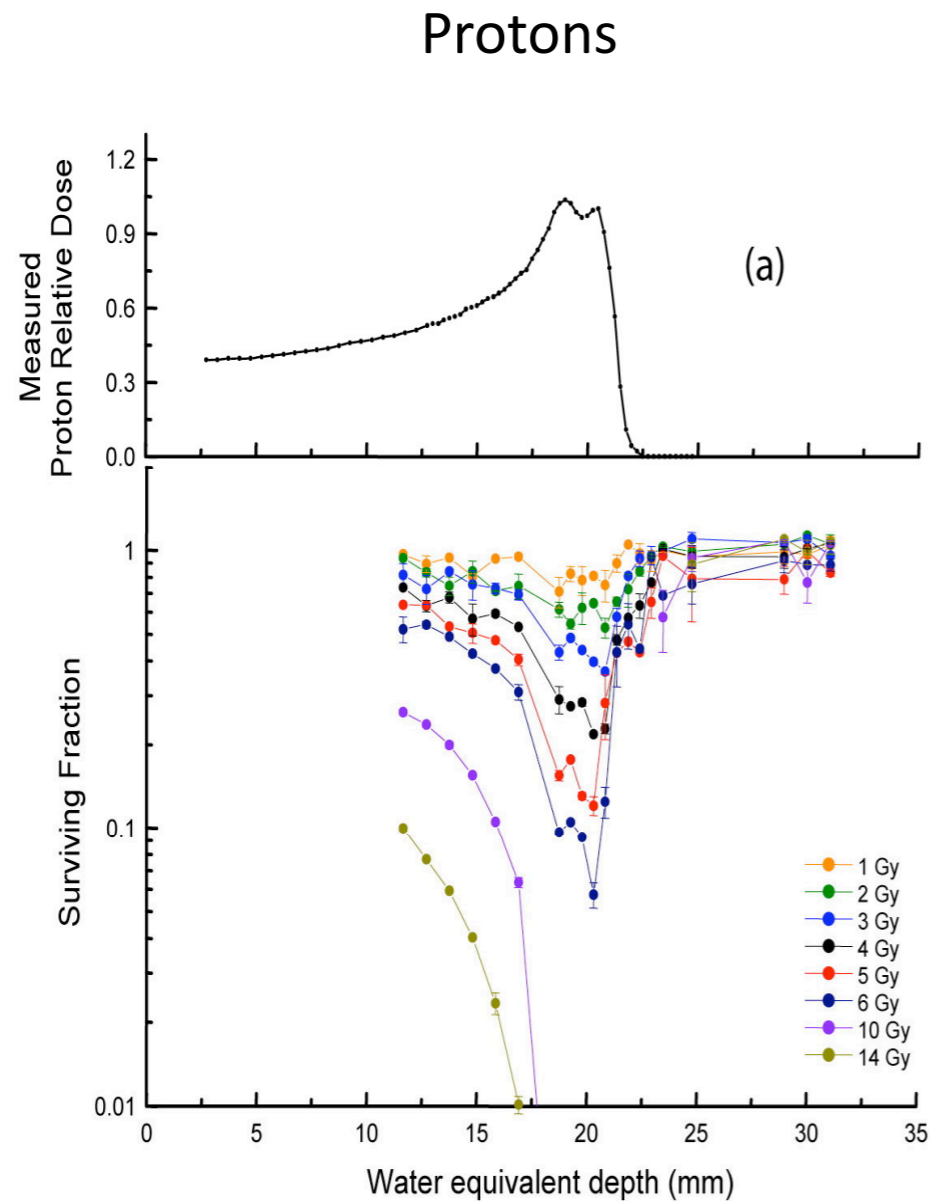

Potential Clinical Advantages?

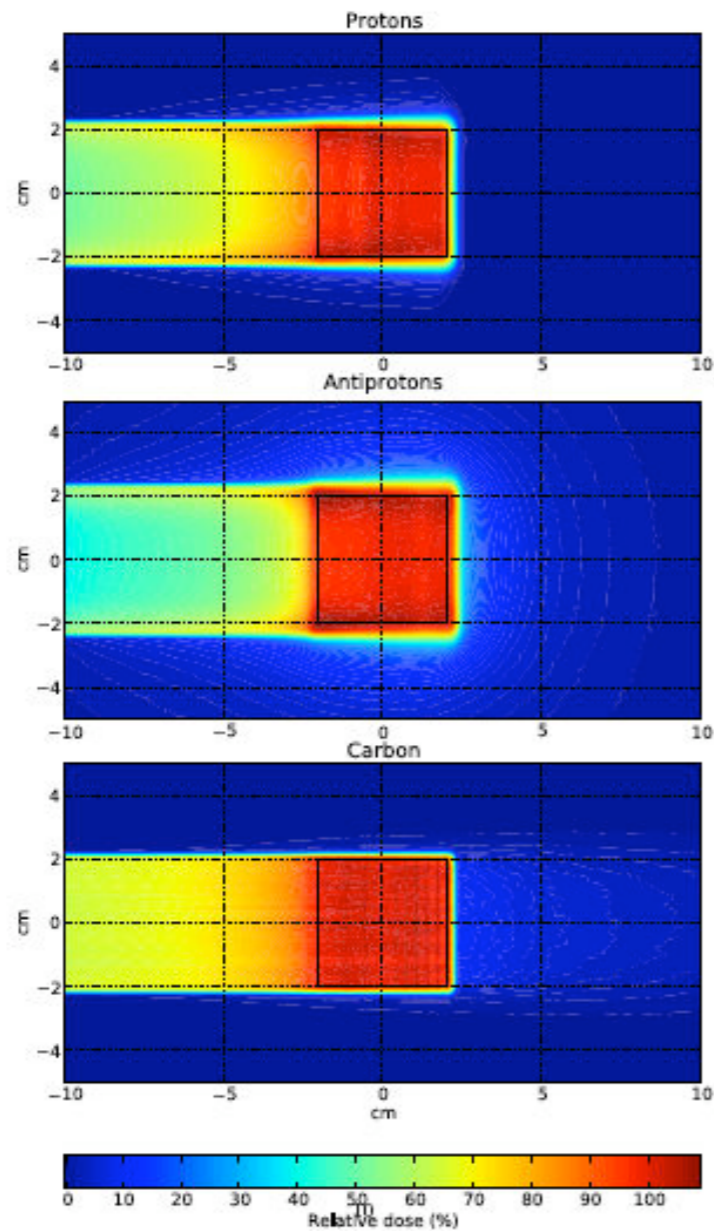

Each Particle Type shows distinct features

- Protons are well known and easy to plan (RBE = 1) which is the reason they are most widely adopted.
- Antiprotons have lowest entrance dose for the price of an extended isotropic low dose halo.
- Carbon ions have sharpest lateral penumbra but comparatively higher entrance dose than even protons (no RBE included here), but show forward directed tail due to in beam fragmentation.

Detailed dose plans (including RBE) will need to be developed to assess applicability of particle types for different tumor types and locations!

DNA Damage Assays

There is more to biology than just clonogenics

– especially outside the targeted area:

- Immediately after attack on DNA proteins are recruited to the site
- This event signals cell cycle arrest to allow repair
- If damage is too extensive to repair programmed cell death (apoptosis) is induced
- Cells also deficient of cell cycle check point proteins may enter mitosis (cancer cells are often deficient in repair proteins and continue dividing)

γ -H2AX: Phosphorylation of H2AX in the presence of Double Strand Breaks

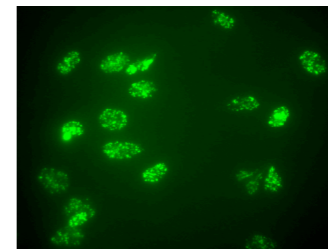

Micronuclei: Fluorescent detection of micronuclei (parts of whole chromosomes) formed due to DNA damage indicating potential of tumorigenesis



γ -H2AX and Micronucleus assays are typically used to study immediate and long term DNA damage respectively

Fuel and energy



Antimatter in a trap
(in the film *Angels and Demons*)

Fuel and energy



You are an antimatter factory



Your body produces antimatter:
The body of an 80 kg individual produces 180 positrons per hour! These come from the disintegration of potassium-40, a natural isotope which is absorbed by drinking water, eating and breathing.

You are an antimatter factory



Your body produces antimatter:

The body of an 80 kg individual produces 180 positrons per hour! These come from the disintegration of potassium-40, a natural isotope which is absorbed by drinking water, eating and breathing.

maybe we can do better..



...but not a lot better:

CERN produces $3 \times 10^7 \bar{p}$ /cycle $\sim 10^{15} \bar{p}$ /yr

20 kt TNT = $8.4 \cdot 10^{13}$ J
0.5 g antimatter
+ 0.5 g matter



0.5 g antimatter = $4.5 \cdot 10^{13}$ J

Total energy needed (efficiency
= 10^{-9}) : $4.5 \cdot 10^{22}$ J

Electricity discount price CERN
[1 kWh = $3.6 \cdot 10^6$ J] = 0.1 €

Price $\sim 1,000,000,000,000,000$ €

Delivery time $\sim 1\ 000\ 000\ 000$ years



...but not a lot better:

CERN produces $3 \times 10^7 \bar{p}/\text{cycle} \sim 10^{15} \bar{p}/\text{yr}$

20 kt TNT = $8.4 \cdot 10^{13} \text{ J}$
0.5 g antimatter
+ 0.5 g matter



0.5 g antimatter = $4.5 \cdot 10^{13} \text{ J}$

Total energy needed (efficiency
= 10^{-9}) : $4.5 \cdot 10^{22} \text{ J}$

Electricity discount price CERN
[1 kWh = $3.6 \cdot 10^6 \text{ J}$] = 0.1 €

Price ~ 1,000,000,000,000,000 €

Delivery time ~ 1 000 000 000 years

....so, can (rare, expensive and difficult-to-produce) antimatter be used for anything useful?

The usefulness of antimatter



„Anti-Protonic Assumption“
Salvador Dali, 1956

The usefulness of antimatter



„Anti-Protonic Assumption“
Salvador Dali, 1956

...it's certainly an inspiration for the imagination of artists...

The artistic value of antimatter

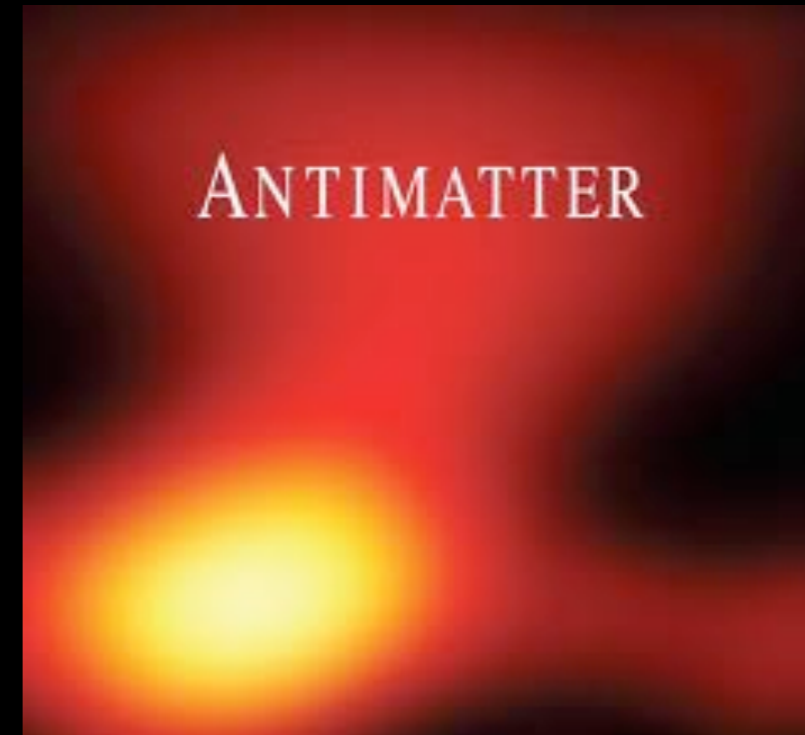

Antimatter
FILM FESTIVAL
OCTOBER 2012



No 15

Screenings
Installations
Performances

Victoria BC Canada



The monetary value of antimatter

Gold:
(50 kCHF/kg)



Antimatter (positrons):
(50 kCHF/GBq)

(1.5 GBq ^{22}Na source will produce about
 $10^{17} e^+ \sim 10^{-10} \text{g}$)

The monetary value of antimatter



The end
(really, this time)

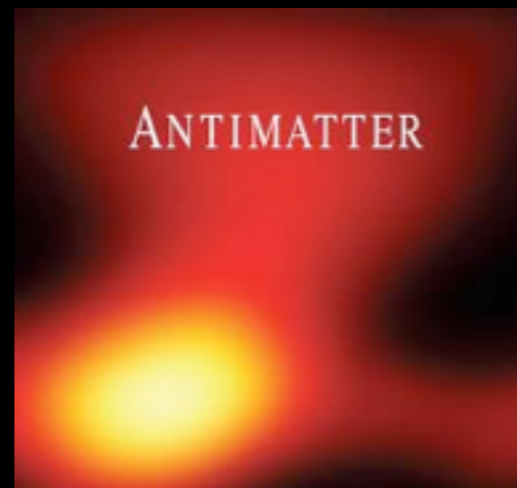

The end
(really, this time)

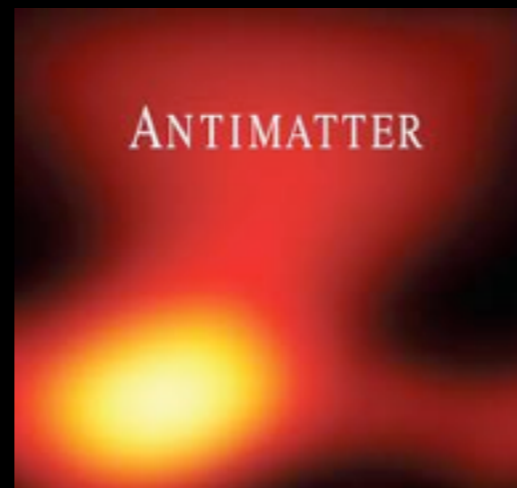

Leaving Eden is the fourth album by the UK band Antimatter.